

ATE New Parts ATE Neuteile

08/2022



Brakethrough Technology



Erstklassig First-class

Besser ist besser

Wenn es um Qualität geht, genügt uns ein „sehr gut“ noch lange nicht. Wir erfüllen hohe Ansprüche an das Qualitätsmanagement und die europäische Sicherheitsnorm ECE-R90 wird von ATE sogar übertroffen. Zudem führen wir zahlreiche zusätzliche Tests durch, unter anderem zu Verschleiß und Wärmeleistung.

Auch Nachhaltigkeit ist uns wichtig: Wir stellen die Mischungen für ATE Bremsbeläge auf kupferfreie Materialien um und setzen bei ATE Ceramic auf geringen Abrieb. Nutzen ausschließlich umweltfreundliches Material für die Beschichtung von Bremscheiben. Und bereiten Produkte wie Bremsattel wieder auf.

Better is better

When it comes to quality, “very good” is simply not good enough for us. We meet high standards of quality management – and ATE even exceeds the European safety standard ECE-R90. We also perform many additional tests, including wear and thermal performance.

Sustainability is also important to us: we convert the compounds for ATE brake pads to copperfree materials and opt for low abrasion with ATE Ceramic. We only use environmentally friendly material for the coating of brake discs – and we remanufacture products like brake callipers.

Höchste Qualität für optimale Leistung.



NEU: SUPER DOT 5.1

Neue Premium-Flüssigkeit ATE SUPER DOT 5.1 mit bester Funktionalität bei heißen wie kalten Einsatzbedingungen: 5°C höherer Nassiedepunkt und höheres Wechselintervall als ATE SL.6 bei gleich guter Viskosität, ideal für Fahrzeuge mit modernen Fahrerassistenzsystemen wie ESP®, ABS und ASR.

Große Auswahl für alle Einsatzgebiete

- | ATE SL als bewährter DOT 4 Typ, ATE TYP 200 für Rennsportbegeisterte und ATE DOT 3 G für Oldtimer und Fahrzeuge, wo die Verwendung einer DOT 3-Flüssigkeit vom Fahrzeughersteller vorgeschrieben ist
- | ATE SL.6 ist optimal für ESP®, ABS und ASR: dünnflüssig auch bei niedrigen Temperaturen, schnelle Reaktionszeit
- | Siedepunkte und Viskosität übertreffen gesetzliche und technische Anforderungen
- | Schutz vor Korrosion durch hochwertige Additive

Die Eigenschaften von ATE Bremsflüssigkeiten

	Siedepunkt	Nassiedepunkt	Viskosität bei -40°C	Wechselintervall
ATE SUPER DOT 5.1	min. 265°C	min. 180°C	max. 750 mm ² /s	bis 3 Jahre
ATE TYP 200 DOT 4 Racing-Qualität	min. 280°C	min. 198°C	max. 1.400 mm ² /s	bis 3 Jahre
ATE SL.6 DOT 4 Ideal für ESP®, ABS, ASR	min. 265°C	min. 175°C	max. 700 mm ² /s	bis 2 Jahre
ATE SL DOT 4	min. 260°C	min. 165°C	max. 1.400 mm ² /s	bis 1 Jahr
ATE G DOT 3	min. 245°C	min. 150°C	max. 1.500 mm ² /s	bis 1 Jahr

Zur Erhaltung der Funktionssicherheit der Bremsanlage muss Bremsflüssigkeit entsprechend der vom Fahrzeughersteller vorgegebenen Qualität und in den angegebenen Wechselintervallen ausgetauscht werden.

Servicegeräte

Natürlich bieten wir auch Geräte für Tests, Entlüftung und Entsorgung von Bremsflüssigkeiten an. Sie arbeiten exakt und zuverlässig, sind leicht zu bedienen und technologisch auf dem neuesten Stand.

Erfahren Sie mehr über ATE Bremsflüssigkeiten auf www.ate.de/bremsflussigkeit sowie über unsere Servicegeräte auf www.ate-info.de



Typ	ATE Sachnummer	EAN-Nr. 4006633	Gebinde	Paletteneinheit
SUPER DOT 5.1 SAE-Spezifikation, J1704-FMVSS 116/DOT 5.1 ISO Klasse 5-1 – niedrigviskos	706602 03.9901-6602.2	45757 6	1 l	600 Kannen ²
	706603 03.9901-6603.2	45759 0	5 l	400 Kannen ³
	706611 03.9901-6611.2	45761 3	20 l	36 Kannen
TYP 200 SAE-Spezifikation, J1704-FMVSS 116/DOT 4	706202 03.9901-6202.2	10825 6	1 l	600 Kannen ²
	706203 03.9901-6203.2	12166 8	5 l	400 Kannen ³
	706220 03.9901-6220.2	12780 6	30 l	22 Kannen
SL.6 SAE-Spezifikation, J1704-FMVSS 116/DOT 4 ISO-Klasse 6 – niedrigviskos	706402 03.9901-6402.2	20746 1	1 l	600 Kannen ²
	706403 03.9901-6403.2	20748 5	5 l	400 Kannen ³
	706411 03.9901-6411.2	20750 8	20 l	36 Kannen
	706420 03.9901-6420.2	23120 6	30 l	22 Kannen
	706414 03.9901-6414.2	23005 6	50 l	12 Kannen
	706405 03.9901-6405.2	23121 3	200 l	1 Stück
SL SAE-Spezifikation, J1704-FMVSS 116/DOT 4	705801 03.9901-5801.2	49001 6	1/2 l	1.200 Kannen ¹
	705802 03.9901-5802.2	49002 3	1 l	600 Kannen ²
	705803 03.9901-5803.2	49003 0	5 l	400 Kannen ³
	705811 03.9901-5811.2	29907 7	20 l	12 Kannen
	705820 03.9901-5820.2	10824 9	30 l	22 Kannen
	705814 03.9901-5814.2	10366 4	50 l	12 Kannen
	705805 03.9901-5805.2	49005 4	200 l	1 Stück
G SAE-Spezifikation, J1703-FMVSS 116/DOT 3	705302 03.9901-5302.2	10199 8	1 l	600 Kannen ²
	705303 03.9901-5303.2	10201 8	5 l	400 Kannen ³

Abweichende Artikelnummern für Lieferländer außerhalb Deutschlands möglich.

Paletteneinheit:

¹ 20 Kannen je Karton

² 10 Kannen je Karton

³ 4 Kannen je Karton

Top quality for optimum performance.



NEW: SUPER DOT 5.1

The new premium ATE SUPER DOT 5.1 brake fluid with optimum performance in both hot and cold conditions: 5°C higher wet boiling point than ATE SL.6, same excellent viscosity, longer change interval, ideal for vehicles with advanced driver assistance systems like ESP®, ABS and ASR.

Wide selection for all applications

- | ATE SL as a proven DOT 4 grade, ATE TYPE 200 for racing enthusiasts and ATE DOT 3 G for classic cars and vehicles for which the manufacturer specifies a DOT 3 brake fluid
- | ATE SL.6 is optimal for ESP®, ABS and ASR: low viscosity even at low temperatures, with a fast reaction time
- | Boiling points and viscosities are better than in statutory and technical regulations
- | Protection from corrosion by high-grade additives

Properties of ATE brake fluids

	Boiling point	Wet boiling point	Viscosity at -40°C	Change interval
ATE SUPER DOT 5.1	min. 265 °C / 509 °F	min. 180 °C / 356 °F	max. 750 mm ² /s	up to 3 years
ATE TYPE 200 DOT 4 Racing quality	min. 280 °C / 536 °F	min. 198 °C / 388 °F	max. 1,400 mm ² /s	up to 3 years
ATE SL.6 DOT 4 Ideal for ESP®, ABS, ASR	min. 265 °C / 509 °F	min. 175 °C / 347 °F	max. 700 mm ² /s	up to 2 years
ATE SL DOT 4	min. 260 °C / 500 °F	min. 165 °C / 329 °F	max. 1,400 mm ² /s	up to 1 year
ATE G/ATE Blue DOT 3	min. 245 °C / 473 °F	min. 150 °C / 302 °F	max. 1,500 mm ² /s	up to 1 year

To maintain the operational reliability and safety of the brake system, you must change the brake fluid in accordance with the vehicle manufacturer's recommendations on quality and at the specified change intervals.

Service units

Of course we also offer devices for testing, bleeding and disposing of brake fluids. The devices work accurately and reliably, are easy to use and their technology is state-of-the-art.



To learn more about ATE brake fluids go to www.ate.de/bremsfluessigkeit. Information on our service units is available at www.ate-info.de

Type	ATE item code	Language variations	Container	Pallet unit
SUPER DOT 5.1 SAE specification, J1704-FMVSS 116/DOT 5.1 ISO Class 5-1 – low viscosity	706602 03.9901-6602.2	DE, EN, ES, PT, CN, FR, IT, AR, SE, NL, JP, TH, GR	1 L	600 cans ²
	706612 03.9901-6612.2	PL, RU, CZ, SK, SLO, HU, BG, KA, HR, SR, RO	1 L	600 cans ²
	706603 03.9901-6603.2	DE, EN, ES, PT, CN, FR, IT, AR, SE, NL, JP, TH, GR, PL, RU, CZ, SK, SLO, HU, BG, KA, HR, SR, RO	5 L	400 cans ³
	706611 03.9901-6611.2	DE, EN, ES, PT, CN, FR, IT, AR, SE, NL, JP, TH, GR, PL, RU, CZ, SK, SLO, HU, BG, KA, HR, SR, RO	20 L	36 cans
TYP 200 SAE specification, J1704-FMVSS 116/DOT 4	706202 03.9901-6202.2	DE, EN, ES, PT, CN, FR, IT, AR, SE, NL, JP, TH, GR	1 L	600 cans ²
	706212 03.9901-6212.2	PL, RU, CZ, SK, SLO, HU, BG, KA, HR, SR, RO	1 L	600 cans ²
	706203 03.9901-6203.2	DE, EN, PL, ES, CN, FR, IT, RO, AR, SE, RU, HR, SR, CZ, SK, SLO, GR, HU, JP, TH, BG, NL, PT, KA, DK, FI, SQ, TR, LV, NO, LT, MS, HY	5 L	400 cans ³
	706220 03.9901-6220.2	DE, EN, PL, ES, CN, FR, IT, RO, AR, SE, RU, HR, SR, CZ, SK, SLO, GR, HU, JP, TH, BG, NL, PT, KA, DK, FI, SQ, TR	30 L	22 cans
SL.6 SAE specification, J1704-FMVSS 116/DOT 4 ISO Class 6 – low viscosity	706402 03.9901-6402.2	DE, EN, ES, PT, CN, FR, IT, AR, SE, NL, JP, TH, GR	1 L	600 cans ²
	706432 03.9901-6432.2	PL, RU, CZ, SK, SLO, HU, BG, KA, HR, SR, RO	1 L	600 cans ²
	706403 03.9901-6403.2	DE, EN, PL, ES, CN, FR, IT, RO, AR, SE, RU, HR, SR, CZ, SK, SLO, GR, HU, JP, TH, BG, NL, PT, KA, DK, FI, SQ, TR, LV, NO, LT, MS, HY	5 L	400 cans ³
	706411 03.9901-6411.2	DE, EN, PL, ES, CN, FR, IT, RO, AR, SE, RU, HR, SR, CZ, SK, SLO, GR, HU, JP, TH, BG, NL, PT, KA, DK, FI, SQ, TR, LV	20 L	36 cans
	706420 03.9901-6420.2	DE, EN, PL, ES, CN, FR, IT, RO, AR, SE, RU, HR, SR, CZ, SK, SLO, GR, HU, JP, TH, BG, NL, PT, KA, DK, FI, SQ, TR	30 L	22 cans
	706414 03.9901-6414.2	DE, EN, PL, ES, CN, FR, IT, RO, AR, SE, RU, HR, SR, CZ, SK, SLO, GR, HU, JP, TH, BG, NL, PT, KA, DK, FI, SQ, TR	50 L	12 cans
	706405 03.9901-6405.2	DE, EN, PL, ES, CN, FR, IT, RO, AR, SE, RU, HR, SR, CZ, SK, SLO, GR, HU, JP, TH, BG, NL, PT, KA, DK, FI, SQ, TR	200 L	1 item
SL SAE specification, J1704-FMVSS 116/DOT 4	705801 03.9901-5801.2	DE, EN, ES, AR, TH, CN	1/2 L	1,200 cans ¹
	705831 03.9901-5831.2	PL, RO, RU, HR, SLO, KA	1/2 L	1,200 cans ²
	705802 03.9901-5802.2	DE, EN, ES, PT, CN, FR, IT, AR, SE, NL, JP, TH, GR	1 L	600 cans ²
	705832 03.9901-5832.2	PL, RU, CZ, SK, SLO, HU, BG, KA, HR, SR, RO	1 L	600 cans ²
	705803 03.9901-5803.2	DE, EN, PL, ES, CN, FR, IT, RO, AR, SE, RU, HR, SR, CZ, SK, SLO, GR, HU, JP, TH, BG, NL, PT, KA, DK, FI, SQ, TR, LV, NO, LT, MS, HY	5 L	400 cans ³
	705811 03.9901-5811.2	DE, EN, PL, ES, CN, FR, IT, RO, AR, SE, RU, HR, SR, CZ, SK, SLO, GR, HU, JP, TH, BG, NL, PT, KA, DK, FI, SQ, TR, LV	20 L	12 cans
	705820 03.9901-5820.2	DE, EN, PL, ES, CN, FR, IT, RO, AR, SE, RU, HR, SR, CZ, SK, SLO, GR, HU, JP, TH, BG, NL, PT, KA, DK, FI, SQ, TR	30 L	22 cans
	705814 03.9901-5814.2	DE, EN, PL, ES, CN, FR, IT, RO, AR, SE, RU, HR, SR, CZ, SK, SLO, GR, HU, JP, TH, BG, NL, PT, KA, DK, FI, SQ, TR	50 L	12 cans
	705805 03.9901-5805.2	DE, EN, PL, ES, CN, FR, IT, RO, AR, SE, RU, HR, SR, CZ, SK, SLO, GR, HU, JP, TH, BG, NL, PT, KA, DK, FI, SQ, TR	200 L	1 item
G SAE specification, J1703-FMVSS 116/DOT 3	705302 03.9901-5302.2	-	1 L	600 cans ²
	705303 03.9901-5303.2	-	5 L	400 cans ³
BLUE SAE specification, J1703-FMVSS 116/DOT 3	700301 03.9901-0301.2	-	1/2 L	1,200 cans ²
	700302 03.9901-0302.2	-	1 L	600 cans ²

Item codes may be different for countries of delivery other than Germany.

Pallet unit: ¹20 cans per box, ²10 cans per box, ³4 cans per box

EN Table of contents

Index of vehicles
Product details
Applications of vehicles
Technical translations

8	Herstellerverzeichnis
15	Produktdetails
51	Fahrzeugverwendungen
684	Technische Übersetzungen

DE Inhaltsverzeichnis

ES Índice

8	Índice de vehículos	8
15	Descripción del producto	15
51	Aplicaciones	51
684	Traducciones técnicas	684

FR Table des matières

Liste des véhicules
Présentation du produit
Applications
Traductions techniques

8	Indice autovetture	8
15	Panoramica prodotti	15
51	Applicazioni autoveicoli	51
684	Traduzioni tecniche	684

IT Sommario



- EN** Index of vehicles
- DE** Herstellerverzeichnis
- ES** Índice de vehículos
- FR** Liste des véhicules
- IT** Indice autovettura

08/2022

ALFA ROMEO	52	BMW	100	BMW	100
156 (932_)	52	1 (E81)	100	Z4 Roadster (E89)	134
156 Sportwagon (932_)	52	1 (E87)	100	Z4 Roadster (G29)	134
159 (939_)	52	1 (F40)	101	Z8 Roadster (E52)	134
159 Sportwagon (939_)	52	1 (F52)	101		
BRERA (939_)	52	1 Convertible (E88)	101		
GIULIETTA (940_)	52	1 Coupe (E82)	101	CHEVROLET	134
GIULIETTA Hatchback Van (940_)	52	2 Active Tourer (F45)	102	AVEO Hatchback (T300)	135
MITO (955_)	53	2 Active Tourer Van (F45)	102	AVEO Saloon (T300)	135
SPIDER (939_)	53	2 Coupe (G42)	102	CORSA Estate	135
		2 Gran Coupe (F44)	103	CRUZE (J300)	135
		2 Gran Tourer (F46)	103	CRUZE Hatchback (J305)	135
		2 Gran Tourer Van (F46)	103	CRUZE Station Wagon (J308)	136
		3 (E30)	103	ORLANDO (J309)	137
		3 (E36)	104	TRAX	137
		3 (E46)	104	VOLT	137
		3 (E90)	105	ZAFIRA (F75)	137
		3 (G20, G80, G28)	106		
		3 Compact (E36)	107		
		3 Compact (E46)	107		
		3 Convertible (E30)	107	CHRYSLER	137
		3 Convertible (E36)	107	200 Convertible	137
		3 Convertible (E46)	108	200 Saloon	137
		3 Convertible (E93)	108	DELTA	138
		3 Coupe (E36)	108	SEBRING (JS)	138
		3 Coupe (E46)	109	SEBRING Convertible (JS)	138
		3 Coupe (E92)	109	YPSILON	138
		3 Touring (E30)	110		
		3 Touring (E36)	110		
		3 Touring (E46)	110	CITROËN	138
		3 Touring (E91)	110	BERLINGO / BERLINGO FIRST Box	138
		3 Touring (G21, G81)	112	Body/MPV (M_)	
		3 Touring Van (G21)	112	BERLINGO (ER_, EC_)	138
		4 Convertible (G23, G83)	112	BERLINGO Box Body/MPV (B9)	139
		4 Coupe (G22, G82)	113	BERLINGO Box Body/MPV (K9)	139
		4 Gran Coupe (G26)	113	BERLINGO MULTISPACE (B9)	140
		5 (E28)	114	BERLINGO Platform/Chassis (B9)	140
		5 (E34)	115	C4 AIRCROSS	142
		5 (E39)	115	C4 Coupe (LA_)	142
		5 (E60)	117	C4 GRAND PICASSO I (UA_)	142
		5 (F10)	119	C4 GRAND PICASSO II (DA_, DE_)	143
		5 (G30, F90)	120	C4 I (LC_)	140
		5 Gran Turismo (F07)	120	C4 I Hatchback Van (LR_)	140
		5 Touring (E34)	120	C4 II (NC_)	141
		5 Touring (E39)	120	C4 II Hatchback Van (NC_)	141
		5 Touring (E61)	122	C4 III (BA_, BB_, BC_)	142
		5 Touring (F11)	124	C4 II Saloon (NC_)	141
		5 Touring (G31)	124	C4 PICASSO II	145
		5 Touring Van (G31)	125	C4 PICASSO II Van (DD_)	145
		6 (E24)	125	C4 PICASSO I MPV (UD_)	144
		6 (E63)	125	C4 SPACETOURER (3D_)	145
		6 Convertible (E64)	125	C4 SPACETOURER Van (3D_)	146
		6 Gran Turismo (G32)	125	C5 AIRCROSS (A_)	148
		7 (E23)	126	C5 III (RD_)	146
		7 (E32)	126	C5 III Break (RW_)	147
		7 (E38)	127	C6 (TD_)	148
		7 (E65, E66, E67)	127	DS4 (NX_)	148
		7 (F01, F02, F03, F04)	128	DS5	149
		7 (G11, G12)	128	EVASION MPV (22, U6)	150
		8 (E31)	128	GRAND C4 SPACETOURER (3A_, 3E_)	150
		i4 (G26)	128	GRAND C4 SPACETOURER Van (3A_, 3E_)	151
		iX3 (G08)	129	SAXO (S0, S1)	151
		X1 (E84)	129	XSARA (N1)	151
		X1 (F48)	129	XSARA Break (N2)	151
		X2 (F39)	129	XSARA Coupe (N0)	152
		X3 (E83)	130	XSARA Estate Van	152
		X3 (G01, F97)	130	XSARA Hatchback Van (N3_)	152
		X3 Van (G01)	130		
		X4 (G02, F98)	131		
		X5 (E53)	131	CUPRA	152
		X5 (E70)	131	ATECA (KH7, KHP)	152
		X5 (F15, F85)	131	BORN (K11)	152
		X5 (G05, F95)	132	FORMENTOR (KM7)	153
		X5 Van (G05)	132	LEON (KL1)	153
		X6 (E71, E72)	132	LEON Sportstourer (KL8)	154
		X6 (G06, F96)	133		
		Z1 Roadster	133		
		Z3 Coupe (E36)	133	DACIA	154
		Z3 Roadster (E36)	133	DOKKER Express Box Body/MPV	154
		Z4 Coupe (E86)	134	DOKKER MPV (KE_)	155
		Z4 Roadster (E85)	134		
AUDI	53				
100 C3 Avant (445, 446)	54				
100 C3 Saloon (443, 444)	55				
100 C4 Avant (4A5)	55				
100 C4 Saloon (4A2)	55				
80 B3 Saloon (893, 894, 8A2)	53				
90 B3 (893, 894, 8A2)	54				
A1 (8X1, 8XK)	56				
A1 City Carver (GBH)	58				
A1 Sportback (8XA, 8XF)	58				
A1 Sportback (GBA)	60				
A2 (8Z0)	60				
A3 (8L1)	60				
A3 (8P1)	61				
A3 (8V1, 8VK)	63				
A3 Convertible (8P7)	66				
A3 Convertible (8V7, 8VE)	66				
A3 Limousine (8VS, 8VM)	69				
A3 Limousine (8YS)	72				
A3 Sportback (8PA)	73				
A3 Sportback (8VA, 8VF)	75				
A3 Sportback (8YA)	78				
A4 Allroad B8 (8KH)	79				
A4 Allroad B9 (8WH, 8WJ)	79				
A4 B5 (8D2)	79				
A4 B5 Avant (8D5)	80				
A4 B6 (8E2)	80				
A4 B6 Avant (8E5)	81				
A4 B6 Convertible (8H7)	81				
A4 B7 (8EC)	81				
A4 B7 Avant (8ED)	82				
A4 B7 Convertible (8HE)	82				
A4 B8 (8K2)	83				
A4 B8 Avant (8K5)	83				
A4 B9 (8W2, 8WC)	84				
A4 B9 Avant (8W5, 8WD)	85				
A5 (8T3)	86				
A5 Convertible (8F7)	86				
A5 Sportback (8TA)	86				
A6 Allroad C6 (4FH)	86				
A6 C4 (4A2)	87				
A6 C4 Avant (4A5)	87				
A6 C5 (4B2)	87				
A6 C5 Avant (4B5)	88				
A6 C6 (4F2)	88				
A6 C6 Avant (4F5)	89				
A8 D2 (4D2, 4D8)	89				
A8 D3 (4E2, 4E8)	89				
ALLROAD C5 (4BH)	90				
CABRIOLET B3 (8G7)	90				
COUPE B3 (89, 8B3)	90				
E-TRON (GEN)	90				
E-TRON GT Saloon (F83)	90				
E-TRON Sportback (GEA)	90				
Q2 (GAB, GAG)	91				
Q3 (8UB, 8UG)	92				
Q3 (F3B)	93				
Q3 Sportback (F3N)	95				
Q4 Sportback (F4N)	96				
Q4 SUV (F4B)	96				
Q7 (4LB)	96				
Q7 Van (4LB)	96				
TT (8J3)	97				
TT (8N3)	97				
TT (FV3, FVP)	97				
TT Roadster (8J9)	98				
TT Roadster (8N9)	99				
TT Roadster (FV9, FVR)	99				

DAZIA	154	FORD	166	HONDA	205
DUSTER (HM_)	155	FIESTA Hatchback Van (WFVT)	176	CR-V II (RD_)	206
DUSTER (HS_)	156	FIESTA I (GFBT)	172	CR-V III (RE_)	206
DUSTER SUV Van	156	FIESTA II (FBD)	172	CR-V IV (RM_)	206
LODGY (JS_)	157	FIESTA III (GFJ)	173		
LOGAN II	157	FIESTA IV (JA_, JB_)	173	HYUNDAI	206
LOGAN MCV II	157	FIESTA Saloon	176	CRETA	206
SANDERO II	157	FIESTA V (JH_, JD_)	174	CRETA (SU2_)	206
SANDERO III	158	FIESTA V Van	175	ELANTRA IV Saloon (HD)	207
		FOCUS C-MAX (DM2)	186	ELANTRA V Coupe (JK)	207
DAEWOO	158	FOCUS I (DAW, DBW)	176	ELANTRA V Saloon (CN7)	207
ESPERO (KLEJ)	158	FOCUS I Estate Van (DNW)	177	ELANTRA VII Saloon (CN7)	207
LANOS (KLAT)	158	FOCUS II (DA_, HCP, DP)	177	ELANTRA VI Saloon (AD, ADA)	207
LANOS Saloon (KLAT)	158	FOCUS II Convertible	178	ELANTRA V Saloon (MD, UD)	207
NEXIA	158	FOCUS II Estate Van	178	GRANDEUR (HG)	207
NEXIA Saloon	159	FOCUS III	180	GRANDEUR (IG)	208
RACER Hatchback	159	FOCUS III Estate Van	182	i20 III (BC3, B13)	208
		FOCUS III Hatchback Van	182	i30 (PDE, PD, PDEN)	208
		FOCUS III Saloon	183	i30 Estate (PDE)	208
		FOCUS III Turnier	184	i30 FASTBACK (PDE, PDEN)	209
		FOCUS II Saloon (DB_, FCH, DH)	179	i30 Hatchback Van (PDE)	209
		FOCUS II Turnier (DA_, FFS, DS)	180	i30 Kombi Van (PDE)	209
		FOCUS I Saloon (DFW)	177	IONIQ (AE)	210
		FOCUS I Turnier (DNW)	177	KONA (OS, OSE, OSI)	210
		FOCUS IV (HN)	185	KONA SUV Van (OS, OSE, OSI)	210
		FOCUS IV Saloon (HM)	185	SONATA VII (LF)	210
		FOCUS IV Turnier (HP)	186	VELOSTER (FS)	210
		FUSION (JU_)	187		
		GALAXY I (WGR)	187	ISUZU	210
		GALAXY II (WA6)	187	D-MAX I (TFR, TFS)	210
		GALAXY MK II VAN (WA6)	188	D-MAX II (TFR, TFS)	211
		GALAXY MK I VAN (WGR)	188	D-MAX III (TFR, TFS)	211
		GRAND C-MAX (DXA/CB7, DXA/CEU)	188	D-MAX II Platform/Chassis (TFR, TFS)	211
		GRAND C-MAX Van	189	D-MAX I Platform/Chassis (TFR, TFS)	211
		KA (RB_)	189	KB	211
		KA Van (RB)	190		
		KUGA I	190	IVECO	211
		KUGA II (DM2)	190	DAILY II Dump Truck	211
		KUGA III (DFK)	192	DAILY III Platform/Chassis	212
		KUGA II VAN	191	DAILY III Van	213
		KUGA I VAN	190	DAILY II Platform/Chassis	211
		MONDEO I (GBP)	192	DAILY II Van	212
		MONDEO II (BAP)	193	DAILY IV Bus	215
		MONDEO II Saloon (BFP)	194	DAILY IV Platform/Chassis	215
		MONDEO II Turnier (BNP)	194	DAILY IV Van	218
		MONDEO I Saloon (GBP)	192	DAILY V Bus	221
		MONDEO I Turnier (BNP)	193	DAILY VI Bus	226
		MONDEO IV (BA7)	194	DAILY VI Platform/Chassis	227
		MONDEO IV Saloon (BA7)	195	DAILY VI Van	230
		MONDEO IV Turnier (BA7)	195	DAILY V Platform/Chassis	222
		MONDEO IV Van	196	DAILY V Van	224
		ORION I (AFD)	196		
		ORION II (AFF)	196	JAGUAR	233
		ORION III (GAL)	197	E-PACE (X540)	233
		PUMA (EC_)	197	F-PACE (X761)	234
		PUMA (J2K, CF7)	198	I-PACE (X590)	235
		SCORPIO I (GAE, GGE)	198	XE (X760)	236
		SCORPIO II (GFR, GGR)	199	XF II (X260)	236
		SCORPIO II Turnier (GNR, GGR)	199	XF SPORTBRAKE (X260)	237
		SCORPIO I Saloon (GGE)	198	XJ (X300, X330)	238
		SCORPIO I Turnier (GGE)	199	XJ (X351)	238
		SIERRA I Hatchback (GBC)	200		
		SIERRA II (GBG, GB4)	200	JEEP	238
		SIERRA II Hatchback (GBC, GBG)	201	COMPASS (MK49)	238
		SIERRA II Turnier (BNG)	202	COMPASS (MP, M6, MV, M7)	238
		SIERRA Turnier (BNC)	202	PATRIOT (MK74)	238
		S-MAX (WA6)	203	RENEGADE SUV (BU, B1, BV)	239
		S-MAX VAN (WA6)	203	RENEGADE VAN (BU, B1)	239
		STREET KA (RL2)	203		
		TOURNEO CONNECT	203	KIA	239
		TOURNEO CONNECT / GRAND	204	CADENZA I (VG)	239
		TOURNEO CONNECT V408 MPV	204	CADENZA II (YG)	239
		TRANSIT CONNECT (P65_, P70_, P80_)	204	CEED (CD)	239
		TRANSIT CONNECT MPV	204	CEED Combi Van (CD)	240
		TRANSIT CONNECT V408 Box Body/MPV	204	CEED Hatchback Van (CD)	240
		HONDA	205		
		ACCORD VII (CL, CN)	205		
		ACCORD VII (CM)	205		
		ACCORD VII Tourer (CM, CN)	206		
DAEWOO	158				
ESPERO (KLEJ)	158				
LANOS (KLAT)	158				
LANOS Saloon (KLAT)	158				
NEXIA	158				
NEXIA Saloon	159				
RACER Hatchback	159				
DS	159				
DS 3 CROSSBACK (UR_, UC_, UJ_)	159				
DS 4 / DS 4 CROSSBACK (NX_)	159				
DS 5 (KF_)	160				
DS 7 Crossback (J_)	160				
FERRARI	160				
208/308 Coupe	160				
328 GTB	161				
328 GTS	161				
MONDIAL	161				
MONDIAL Convertible	161				
FIAT	161				
500 (312_)	162				
500 C (312_)	162				
500e (332_)	162				
500e Convertible (332_)	162				
500L (351_, 352_)	162				
500X (334_)	162				
CROMA (194_)	163				
CROMA Estate Van (194_)	163				
DOBLO Bus (263_)	163				
DOBLO Cargo (263_)	163				
DOBLO Platform/Chassis (263_)	163				
PANDA (169_)	164				
PANDA (312_, 319_)	164				
PANDA Hatchback Van (169_)	164				
PANDA VAN (312_, 519_)	165				
TALENTO Bus (296_)	165				
TALENTO Platform/Chassis (296_)	165				
TALENTO Van (296_)	166				
ULYSSE (220_)	166				
FORD	166				
C-MAX (DM2)	166				
C-MAX II (DXA/CB7, DXA/CEU)	167				
C-MAX II Van	168				
COUGAR (EC_)	168				
ESCORT III (GAA)	169				
ESCORT III Convertible (ALD)	169				
ESCORT III Express (AVA)	169				
ESCORT III Turnier (AWA)	169				
ESCORT II Turnier	169				
ESCORT IV (GAF, AWF, ABFT)	170				
ESCORT IV Convertible (ALF)	170				
ESCORT IV Express (AVF)	171				
ESCORT IV Turnier (AWF, AVF)	171				
ESCORT V (AAL, ABL)	171				
ESCORT V Convertible (ALL)	171				
ESCORT VI (GAL, AAL, ABL)	172				
ESCORT VI Convertible (ALL)	172				
ESCORT V Turnier (ANL)	171				
FIESTA Box Body/MPV (F3L, F5L)	175				
FIESTA Box Body/MPV (J5_, J3_)	175				
FIESTA Box Body/MPV (JV_)	175				
FIESTA Hatchback Van (FVD)	176				

KIA	239	MERCEDES-BENZ	255	MERCEDES-BENZ	255
CEED Sportswagon (CD)	240	C-CLASS (W202)	257	SPRINTER CLASSIC 4,6-t Bus (B909)	291
CERATO III Hatchback (YD)	241	C-CLASS (W204)	257	SPRINTER CLASSIC 4,6-t Van (B909)	291
CERATO III Saloon (YD)	241	C-CLASS (W205)	258	V-CLASS (638/2)	291
CERATO IV Saloon (BD, BDM)	241	C-CLASS (W206)	260	VITO Bus (W638)	291
CERATO KOUP II (TD)	241	C-CLASS All-Terrain (S206)	261	VITO Van (W638)	291
CERATO KOUP III (YD)	241	C-CLASS Convertible (A205)	261		
NIRO (DE)	241	C-CLASS Coupe (C204)	262		
NIRO VAN (DE)	242	C-CLASS Coupe (C205)	262	MINI	291
OPTIMA (FSGDS6B)	242	C-CLASS T-Model (S202)	263	MINI (R50, R53)	291
OPTIMA (JF)	242	C-CLASS T-Model (S204)	264	MINI CLUBMAN (F54)	292
OPTIMA Sportswagon (JF)	242	C-CLASS T-Model (S205)	265	MINI Convertible (R52)	292
PROCEED (CD)	242	C-CLASS T-MODEL (S206)	267	MINI COUNTRYMAN (F60)	292
PROCEED Combi Van (CD)	243	CITAN Box Body/MPV (W415)	267		
SELTOS (SP2, SP2I)	243	CITAN Box Body/MPV (W420)	267	MITSUBISHI	292
SEPHIA (FA)	243	CITAN Mixto (Double Cabin) (W415)	267	ASX (GA_W_)	293
SEPHIA Saloon (FA)	243	CITAN MPV (W415)	268	ASX Van (GA_W_)	293
SOUL II (PS)	244	CITAN Tourer (W420)	268	ECLIPSE CROSS (GK_)	293
SOUL III (SK3)	244	CLA (C118)	268	LANCER VII (CS_A, CT_A)	293
XCEED (CD)	244	CLA Coupe (C117)	268	LANCER VIII (CY_A, CZ_A)	294
XCEED Van (CD)	244	CLA Shooting Brake (X117)	268	LANCER VIII Sportback (CX_A)	294
		CLA Shooting Brake (X118)	269	OUTLANDER III (GG_W, GF_W, ZJ, ZL, ZK)	294
		CLK (C208)	269	OUTLANDER III Van (GF_W, GG_W)	295
LADA	244	CLK Convertible (A208)	269		
VESTA (GFL_)	245	CLS (C218)	269		
VESTA SW Estate (GFK_)	245	CLS (C219)	270		
		CLS (C257)	270		
		CLS Shooting Brake (X218)	270	NISSAN	295
LANCIA	245	E-CLASS (W210)	271	INTERSTAR Platform/Chassis (X62B)	295
DELTA III (844_)	245	E-CLASS (W211)	272	INTERSTAR Van (X62B)	296
YPSILON (312_)	245	E-CLASS (W212)	272	LEAF (ZE1)	297
ZETA (22_)	245	E-CLASS (W213)	273	NV200 Van	297
		E-CLASS All-Terrain (S213)	274	NV300 Kombi (X82)	297
		E-CLASS Convertible (A207)	274	NV300 Platform/Chassis (X82)	297
LAND ROVER	245	E-CLASS Convertible (A238)	274	NV300 Van (X82)	298
DEFENDER Cabrio (L316)	245	E-CLASS Coupe (C207)	275	NV350 Van (E26)	298
DEFENDER Pick Up (L316)	245	E-CLASS Coupe (C238)	275	NV400 Bus (X62, X62B)	298
DEFENDER Platform/Chassis (L316)	245	E-CLASS T-Model (S210)	275	NV400 Platform/Chassis (X62, X62B)	299
DEFENDER Station Wagon (L316)	246	E-CLASS T-Model (S211)	277	NV400 Van (X62, X62B)	300
DISCOVERY SPORT (L550)	246	E-CLASS T-Model (S212)	277	PRIMASTAR (X82)	301
DISCOVERY SPORT VAN (L550)	246	E-CLASS T-Model (S213)	278	PRIMASTAR Bus (X83)	302
FREELANDER 2 (L359)	247	EQA (H243)	278	PRIMASTAR Platform/Chassis (X83)	302
FREELANDER 2 VAN (L359)	248	EQB (X243)	278	PRIMASTAR Van (X83)	303
RANGE ROVER EVOQUE (L538)	248	EQC (N293)	278	PRIMERA (P12)	304
RANGE ROVER EVOQUE (L551)	248	EQE (V295)	278	PRIMERA Estate (WP12)	305
RANGE ROVER EVOQUE Convertible (L538)	249	EQS (V297)	279	PRIMERA Hatchback (P12)	305
RANGE ROVER EVOQUE VAN (L538)	250	G-CLASS (W463)	279	PRIMERA Traveller (WP11)	305
RANGE ROVER VELAR (L560)	250	GLA (H247)	279	QASHQAI II SUV (J11, J11_)	305
		GLA-CLASS (X156)	279	QASHQAI II VAN (J11_)	306
		GLB (X247)	279		
		GLC (X253)	279	OPEL	306
MASERATI	251	GLC Coupe (C253)	281	AMPERA (R12)	306
228	251	GL-CLASS (X164)	281	ASCONA (R12)	306
BITURBO (69, 78, AF3, AM 332)	251	GLE (V167)	282	ASCONA C (J82)	306
BITURBO Coupe (AM 331)	251	GLE Coupe (C167)	282	ASCONA C Hatchback (J82)	306
BITURBO Spider (AM 333)	251	GLS (X167)	282	ASTRA F (T92)	306
KARIF	251	M-CLASS (W164)	283	ASTRA F CLASSIC Estate (T92)	307
		R-CLASS (W251, V251)	283	ASTRA F CLASSIC Hatchback (T92)	307
		S-CLASS (V223)	284	ASTRA F CLASSIC Saloon (T92)	307
MAZDA	251	S-CLASS (W220)	284	ASTRA F Convertible (T92)	308
121 III (JASM, JB5M)	255	S-CLASS (W221)	284	ASTRA F Estate (T92)	308
2 (DY)	252	S-CLASS (W222, V222, X222)	285	ASTRA F Estate Van (T92)	309
3 (BK)	252	S-CLASS (W223)	286	ASTRA F Hatchback (T92)	310
3 (BL)	252	S-CLASS (Z223)	286	ASTRA G CLASSIC (T98)	311
3 Saloon (BK)	253	S-CLASS Convertible (A217)	286	ASTRA G CLASSIC Caravan (F35)	311
3 Saloon (BL)	253	S-CLASS Coupe (C216)	286	ASTRA G CLASSIC Saloon (T98)	312
5 (CR19)	253	S-CLASS Coupe (C217)	286	ASTRA G Convertible (T98)	312
5 (CW)	254	SL (R230)	287	ASTRA G Coupe (T98)	312
6 Estate (GJ, GL)	254	SL (R231)	287	ASTRA G Estate (T98)	312
6 Estate Van (GJ)	254	SL (R232)	287	ASTRA G Estate Van (F70)	314
6 Saloon (GJ, GL)	254	SLK (R170)	287	ASTRA G Hatchback (T98)	314
		SPRINTER 2-t Bus (B901, B902)	287	ASTRA G Saloon (T98)	316
		SPRINTER 2-t Platform/Chassis (B901, B902)	288	ASTRA H (A04)	317
		SPRINTER 2-t Van (B901, B902)	288	ASTRA H CLASSIC Estate (A04)	317
MERCEDES-BENZ	255	SPRINTER 3-t Bus (B903)	288	ASTRA H CLASSIC Hatchback (A04)	318
A-CLASS (W176)	255	SPRINTER 3-t Platform/Chassis (B903)	289	ASTRA H CLASSIC Saloon (A04)	318
A-CLASS (W177)	255	SPRINTER 3-t Van (B903)	289	ASTRA H Estate (A04)	318
A-CLASS Saloon (V177)	256	SPRINTER 4-t Bus (B904)	290	ASTRA H Estate Van (L70)	319
B-CLASS Sports Tourer (W245)	256	SPRINTER 4-t Platform/Chassis (B904)	290	ASTRA H GTC (A04)	319
B-CLASS Sports Tourer (W246, W242)	256	SPRINTER 4-t Van (B904)	290	ASTRA H Saloon (A04)	320
B-CLASS Sports Tourer (W247)	256	SPRINTER CLASSIC 3,5-t Van (B909)	290	ASTRA H TwinTop (A04)	320

SAAB	414	SUZUKI	498	VAUXHALL	502
9-3 (YS3F, E79, D79, D75)	415	S-CROSS (AKK414)	498	NOVA Saloon (S83)	531
9-3 Cabriolet (YS3D)	420	SX4 S-CROSS (JY)	498	NOVAVAN Hatchback Van (S83)	531
9-3 Convertible (YS3F)	421	VITARA (LY)	498	OMEGA (B) Estate (V94)	531
9-3 Estate (E50)	425			OMEGA (B) Saloon (V94)	531
9-3X (YS3)	427			ROYALE	532
9-5 (YS3E)	427	TALBOT	498	ROYALE Coupe	532
9-5 (YS3G)	430	1307-1510	498	SENATOR	532
9-5 Estate (YS3E)	430	SOLARA	499	SENATOR Mk II (B) (V88)	532
				SIGNUM (Z03)	532
SEAT	437	TOYOTA	499	TIGRA Mk I (S93)	534
ALHAMBRA (710, 711)	437	ALPHARD I (_H1_)	499	VECTRA (B) Estate (J96)	534
ALHAMBRA (7V8, 7V9)	437	AVENSIS (_T22_)	499	VECTRA (B) Hatchback (J96)	535
ALHAMBRA VAN (711)	438	AVENSIS Estate (_T22_)	500	VECTRA (B) Saloon (J96)	536
ALTEA (5P1)	438	AVENSIS Liftback (_T22_)	500	VECTRA Mk II (C) (Z02)	537
ALTEA XL (5P5, 5P8)	439	AVENSIS VERSO (_M2_)	501	VECTRA Mk II (C) Estate (Z02)	539
ARONA (KJ7, KJP)	440	ISIS (_M1_)	501	VECTRA Mk II (C) GTS (Z02)	542
ATECA (KH7, KHP)	440	NOAH/VOXY (_R7_)	501	VIVARO A Bus (X83)	543
CORDOBA (6L2)	442	PREVIA II (_R3_)	501	VIVARO A Platform/Chassis (X83)	544
IBIZA III (6L1)	443	SIENNA (_L2_)	501	VIVARO A Van (X83)	545
IBIZA IV (6J5, 6P1)	443	SUPRA (DB_)	501	VIVARO B Bus (X82)	546
IBIZA IV Hatchback Van (6J1)	444	YARIS / VIOS Saloon (_P9_)	502	VIVARO B Platform/Chassis (X82)	547
IBIZA IV SC (6J1, 6P5)	444	YARIS (_P9_)	502	VIVARO B Van (X82)	547
IBIZA IV ST (6J8, 6P8)	446			ZAFIRA A (T98)	548
IBIZA V (KJ1, KJG)	447			ZAFIRA Mk II (B) (A05)	548
LEON (1M1)	447	VAUXHALL	502	ZAFIRA Mk III (P12)	549
LEON (1P1)	447	ASTRA Mk II Belmont (T85)	502		
LEON (5F1)	450	ASTRA Mk II Convertible (T85)	502	VOLVO	550
LEON (KL1)	453	ASTRA Mk II Estate (T85)	502	440 (445)	550
LEON Hatchback Van (5F1)	453	ASTRA Mk II Hatchback (T85)	502	460 (464)	550
LEON SC (5F5)	455	ASTRA Mk III (F) Convertible (T92)	503	480 (482)	550
LEON Sportstourer (KL8)	457	ASTRA Mk III (F) Estate (T92)	503	850 (854)	550
LEON ST (5F8)	457	ASTRA Mk III (F) Hatchback (T92)	504	850 Estate (855)	551
LEON ST Estate Van (5F8)	460	ASTRA Mk III (F) Saloon (T92)	505	C30 (533)	551
Mii (KF1, KE1)	462	ASTRA Mk IV (G) Convertible (T98)	506	C40	552
TARRACO (KN2)	462	ASTRA Mk IV (G) Coupe (T98)	506	C70 II Convertible (542)	552
TOLEDO II (1M2)	463	ASTRA Mk IV (G) Estate (T98)	507	S40 II (544)	553
TOLEDO III (5P2)	464	ASTRA Mk IV (G) Hatchback (T98)	508	S60 I (384)	554
TOLEDO IV (KG3)	464	ASTRA Mk IV (G) Saloon (T98)	508	S60 II (134)	556
		ASTRA Mk V (H) (A04)	509	S60 II Cross Country (134)	557
SKODA	465	ASTRA Mk V (H) Estate (A04)	510	S60 III (224)	557
CITIGO (NF1)	465	ASTRA Mk V (H) Sport Hatch (A04)	510	S70 (874)	558
E-CITIGO (NE1)	465	ASTRA Mk V (H) TwinTop (A04)	511	S80 I (184)	559
ENYAQ iV Coupe (5AC)	465	ASTRA Mk VI (J) (P10)	511	S80 II (124)	559
ENYAQ iV SUV (5AZ)	465	ASTRA Mk VI (J) Estate (P10)	511	S90 II (234)	560
FABIA I (6Y2)	466	ASTRA Mk VI (J) GTC (P10)	512	V40 Cross Country (526)	561
FABIA I Combi (6Y5)	466	ASTRA Mk VI (J) Saloon (P10)	512	V40 Hatchback (525)	561
FABIA II (542)	467	ASTRA Mk VII (K) (B16)	512	V40 Hatchback Van (525)	562
FABIA II Combi (545)	467	ASTRA Mk VII (K) Estate (B16)	513	V50 (545)	562
FABIA III (NJ3)	467	ASTRAVAN Mk III (F) Estate Van (T92)	513	V60 I (155)	563
FABIA III Estate (NJ5)	468	ASTRAVAN Mk IV (G) Estate Van (T98)	513	V60 I Cross Country (157)	565
FABIA I Praktik (6Y5)	466	ASTRAVAN Mk V (H) Estate Van (A04)	514	V60 I Estate Van (155)	565
FABIA I Saloon (6Y3)	466	CALIBRA (C89)	514	V60 II (225)	565
KAMIQ (NW4)	468	CARLTON Mk III Estate (V87)	515	V60 II Cross Country (227)	566
KAROQ (NU7, ND7)	468	CARLTON Mk III Saloon (V87)	515	V70 I (875, 876)	566
KODIAQ (NS7, NV7, NS6)	469	CAVALIER Mk III Hatchback (J89)	516	V70 II (285)	567
OCTAVIA I (1U2)	470	CAVALIER Mk III Saloon (J89)	517	V70 III (135)	569
OCTAVIA I Combi (1U5)	471	COMBO Mk I (B) (S93)	519	V70 III Estate Van (135)	572
OCTAVIA I Estate Van (1U5)	471	COMBO Mk II (C) Box Body/MPV (F25)	519	V90 II Cross Country (236)	572
OCTAVIA II (1Z3)	471	COMBO Mk IV (E) Box Body/MPV (K9)	520	V90 II Estate (235)	572
OCTAVIA II Combi (1Z5)	474	COMBO Mk IV (E) Life (K9)	520	XC40 (536)	573
OCTAVIA III (5E3, NL3, NR3)	476	COMBO TOUR Mk II (C) (F25)	520	XC60 II (246)	574
OCTAVIA III Combi (5E5, 5E6)	480	CORSA Mk I (B) (S93)	521	XC70 I Cross Country (295)	575
OCTAVIA IV (NX3, NN3)	484	CORSA Mk II (C) (X01)	523	XC70 II (136)	576
OCTAVIA IV Combi (NX5)	485	CORSA Mk III (D) (S07)	523	XC70 II VAN (136)	576
RAPID (NA2)	486	CORSA Mk IV (E) (X15)	523	XC90 I (275)	576
RAPID (NH3, NK3, NK6)	486	CORSAVAN Mk I (B) Hatchback Van (S93)	523	XC90 II (256)	577
RAPID Spaceback (NH1)	487	CORSAVAN Mk IV (E) Hatchback Van (X15)	524	XC90 I VAN (275)	577
ROOMSTER (5J7)	488	GRANDLAND X / GRANDLAND (A18)	524		
ROOMSTER Praktik (5J)	488	INSIGNIA Mk I (A) Country Tourer (G09)	524	VW	578
SCALA (NW1)	489	INSIGNIA Mk I (A) Hatchback (G09)	525	AMAROK (2HA, 2HB, S1B, S6B, S7A, S7B)	578
SUPERB I (3U4)	489	INSIGNIA Mk I (A) Saloon (G09)	525	AMAROK Platform/Chassis (S1B, S6B, S7B)	578
SUPERB II (3T4)	490	INSIGNIA Mk I (A) Sports Tourer (G09)	525	ARTEON (3H7, 3H8)	578
SUPERB II Estate (3T5)	492	MERIVA A (X03)	526	ARTEON SHOOTING BRAKE (3H9)	580
SUPERB III (3V3)	494	MERIVA Mk II (B) (S10)	526	BEETLE (5C1, 5C2)	581
SUPERB III Estate (3V5)	495	MOKKA / MOKKA X (J13)	527	BEETLE Convertible (5C7, 5C8)	583
YETI (5L)	496	MOVANO Mk II (B) Chassis/Cab (X62)	527	BORA (9M2)	585
		MOVANO Mk II (B) Combi (X62)	528	BORA I (1J2)	586
		MOVANO Mk II (B) VAN (X62)	529		
		NOVA Hatchback (S83)	530		

VW	578	VW	578
BORA Variant (1J6)	588	PASSAT B7 Variant (365)	649
CADDY ALLTRACK Box Body/MPV (SAA)	598	PASSAT B8 (3G2, CB2)	650
CADDY ALLTRACK MPV (SAB)	599	PASSAT B8 Variant (3G5, CB5)	652
CADDY Box Body/MPV (6K9, 9E7, 9E9)	600	PASSAT CC B6 (357)	653
CADDY CALIFORNIA V Camper (SBB, SBJ)	601	POLO (9N_, 9A_)	654
CADDY III Box Body/MPV (2KA, 2KH, 2CA, 2CH)	589	POLO IV Saloon (9A4, 9A2, 9N2, 9A6)	654
CADDY III MPV (2KB, 2KJ, 2CB, 2CJ)	591	POLO IV Saloon (9N4)	655
CADDY IV Box Body/MPV (SAA, SAH)	593	POLO V (6R1, 6C1)	655
CADDY IV MPV (SAB, SAJ)	595	POLO Van (6R)	657
CADDY V Box Body/MPV (SBA, SBH)	596	POLO Van Estate Van (6V5)	657
CADDY V MPV (SBB, SBJ)	597	POLO VI (AW1, BZ1, AE1)	657
CALIFORNIA T5 Camper (7EC, 7EF, 7EG, 7HF)	602	POLO VIVO Hatchback (6S1, 6S3)	658
CC B7 (358)	603	POLO V Saloon (602, 604, 612, 614)	656
CRAFTER Bus (SYI, SYJ)	603	SCIROCCO III (137, 138)	658
CRAFTER Platform/Chassis (SZ_)	603	SCIROCCO Van (137)	661
CRAFTER Van (SY_, SX_)	604	SHARAN (7M8, 7M9, 7M6)	663
EOS (1F7, 1F8)	604	SHARAN (7N1, 7N2)	663
FOX Hatchback (5Z1, 5Z3, 5Z4)	606	SHARAN VAN (7M_)	663
FOX Van (5Z1)	606	SHARAN VAN (7N1, 7N2)	663
GOLF ALLTRACK VIII (CG5)	629	TAOS (CL1, CQ1)	664
GOLF ALLTRACK VII Variant (BA5, BV5)	628	T-CROSS (C11)	664
GOLF Hatchback Van (1K1)	629	TIGUAN (5N_)	665
GOLF III (1H1)	606	TIGUAN (AD1, AX1)	666
GOLF III Variant (1H5)	606	TIGUAN ALLSPACE (BW2, BJ2)	667
GOLF IV (1J1)	606	TIGUAN SUV Van (AD1)	668
GOLF IV (9B3)	607	TIGUAN VAN (5N_)	668
GOLF IV Van (1J1)	607	TOUAREG (7LA, 7L6, 7L7)	669
GOLF IV Variant (1J5)	608	TOURAN (1T1, 1T2)	670
GOLF PLUS V (5M1, 521)	630	TOURAN (1T3)	673
GOLF PLUS Van (521)	630	TOURAN (1T3)	674
GOLF SPORTSVAN VII (AM1, AN1)	631	TOURAN VAN (1T1, 1T2)	675
GOLF V (1K1)	608	TOURAN VAN (1T3)	676
GOLF VAN IV Variant (1J5)	633	TOURAN VAN (5T1)	676
GOLF VAN VII Variant (BA5)	634	TRANSPORTER III Bus	677
GOLF VAN VI Variant (AJ5)	633	TRANSPORTER III Platform/Chassis	677
GOLF VI (5K1)	609	TRANSPORTER III Van	677
GOLF VI Convertible (517)	611	TRANSPORTER IV Bus (70B, 70C, 7DB, 7DK, 70J, 70K, 7DC, 7DJ)	677
GOLF VII (5G1, BQ1, BE1, BE2)	613	TRANSPORTER IV Platform/Chassis (70E, 70L, 70M, 7DE, 7DL, 7D)	678
GOLF VIII (CD1)	626	TRANSPORTER IV Van (70A, 70H, 7DA, 7DH)	678
GOLF VIII Variant (CG5)	627	TRANSPORTER V Bus (7HB, 7HJ, 7EB, 7EJ)	679
GOLF VII Van (5G1)	620	TRANSPORTER V Platform/Chassis (7JD, 7JE, 7JL, 7JY, 7JZ, 7FD)	679
GOLF VII Variant (BA5, BV5)	622	TRANSPORTER V Van (7HA, 7HH, 7EA, 7EH)	680
GOLF VI Van (5K1_)	612	T-ROC (A11, D11)	680
GOLF VI Variant (AJ5)	613	T-ROC Convertible (AC7, AC8)	681
GOLF V Variant (1K5)	609	UP! (121, 122, BL1, BL2, BL3, 123)	682
GRAND CALIFORNIA Camper (SCB, SCC)	635	VENTO (1H2)	683
ID.3 (E11)	635		
ID.4 (E21)	635		
ID.5 (E39)	635		
JETTA III (1K2)	636		
JETTA IV (162, 163, AV3, AV2)	637		
JETTA VII Saloon (BU3, BU4)	639		
LOAD UP (121, 122, BL1, BL2)	639		
LT 28-35 II Bus (2DB, 2DE, 2DK)	639		
LT 28-46 II Platform/Chassis (2DC, 2DF, 2DG, 2DL, 2DM)	640		
LT 28-46 II Van (2DA, 2DD, 2DH)	640		
LUPO I (6X1, 6E1)	640		
MULTIVAN T7 (STM, STN)	640		
MULTIVAN V (7HM, 7HN, 7HF, 7EF, 7EM, 7EN)	640		
MULTIVAN VI (SGF, SGM, SGN, SHM, SHN)	640		
NEW BEETLE (9C1, 1C1)	641		
NEW BEETLE Convertible (1Y7)	641		
PASSAT ALLTRACK B7 (365)	641		
PASSAT ALLTRACK B8 Variant (3G5, CB5)	642		
PASSAT B3/B4 (3A2, 35I)	643		
PASSAT B3/B4 Variant (3A5, 35I)	643		
PASSAT B5.5 (3B3)	643		
PASSAT B5.5 Variant (3B6)	643		
PASSAT B5 (3B2)	644		
PASSAT B5 Variant (3B5)	645		
PASSAT B6 (3C2)	645		
PASSAT B6 Variant (3C5)	646		
PASSAT B7 (362)	648		
PASSAT B7 (A32, A33)	649		
PASSAT B7 Estate Van (365)	649		



- EN** Product details
- DE** Produktdetails
- ES** Descripción del producto
- FR** Présentation du produit
- IT** Panoramica prodotti

08/2022

03.0137-3005.2

653005

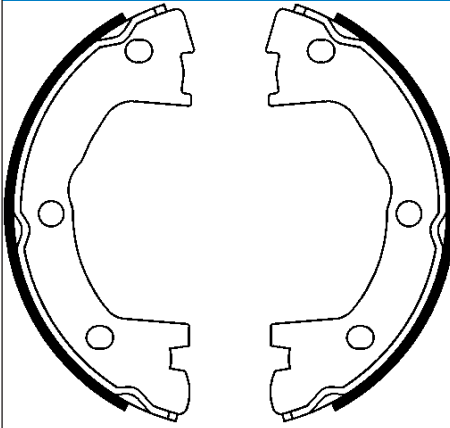

Brake Shoe Set, parking brake

Brake diameter, inside [mm]: 172

Test Mark: E1 90R-011045/142

Supplementary Article/Supplementary Info: without lever

Article number of recommended accessories: 03.0137-9344.2

Width [mm] 42

MAPP code available

IVECO

03.9314-1336.4

760246



Cleaning Kit, wheel hub

03.9314-1337.3

760247



Cleaning Disc, wheel hub cleaning set

Outer diameter [mm]: 160

Inner diameter [mm]: 79.5

11.0101-5407.2

260011



Guide Sleeve Kit, brake caliper

Brake System: ATE

ALFA ROMEO, AUDI, CHEVROLET, CITROËN, DAEWOO, DS, FERRARI, FIAT, FORD, HONDA, JAGUAR, KIA, LANCIA, LAND ROVER, MASERATI, MAZDA, MERCEDES-BENZ, MINI, NISSAN, OPEL, PEUGEOT, POLESTAR, PORSCHE, RENAULT, ROVER, SAAB, SEAT, SKODA, TALBOT, TOYOTA, VAUXHALL, VOLVO, VW

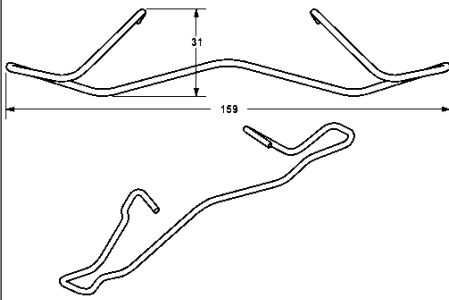
11.8116-0356.1**390586****Spring, brake caliper**

Brake System: ATE

CITROËN, DACIA, DS, FIAT, FORD, HONDA, MAZDA, OPEL, PEUGEOT, RENAULT, SAAB, VAUXHALL, VOLVO

11.8171-0008.1**990049****Guide Bolt, brake caliper**

Diameter [mm]: 12

Brake System: ATE

Length [mm]: 54.9

ALFA ROMEO, AUDI, BMW, CHEVROLET, CHRYSLER, CITROËN, DACIA, DAEWOO, DS, FERRARI, FIAT, FORD, HONDA, JAGUAR, JEEP, KIA, LANCIA, LAND ROVER, MASERATI, MAZDA, MERCEDES-BENZ, MINI, NISSAN, OPEL, PEUGEOT, POLESTAR, PORSCHE, RENAULT, ROVER, SAAB, SEAT, SKODA, TALBOT, TOYOTA, VAUXHALL, VOLVO, VW

11.9282-1001.3**250159****Control Element, parking brake caliper**

Supplementary Article/Info 2: with bolts/screws

Operating Mode: Electric

Brake System: ATE

Supplementary Article/Supplementary Info: with seal

AUDI, CUPRA, SEAT, SKODA, VW

11.9282-1002.3**250160****Control Element, parking brake caliper**

Supplementary Article/Info 2: with bolts/screws

Operating Mode: Electric

Brake System: ATE

Supplementary Article/Supplementary Info: with seal

AUDI, CUPRA, SEAT, SKODA, VW

13.0460-2609.2

602609

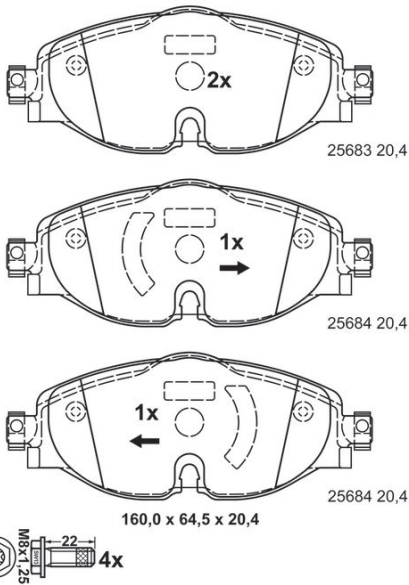

Brake Pad Set, disc brake

Thickness [mm] 20.4

Supplementary Article/Info 2: with brake caliper screws

Brake System: Lucas / TRW

Test Mark: E1 90R-02A0335/0074

Wear Warning Contact: prepared for wear indicator / excl. wear warning contact

Height [mm] 64.5

Width [mm] 160

Number of bolts/screws: 4

MAPP code available

AUDI, SKODA, VW

13.0460-2756.2

602756

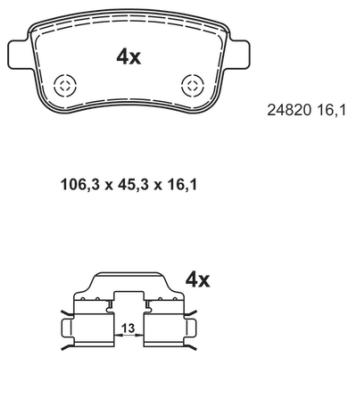

Brake Pad Set, disc brake

Thickness [mm] 16.1

Supplementary Article/Info 2: with brake caliper screws

Brake System: Lucas / TRW

Test Mark: E1 90R-011115/1551

Supplementary Article/Supplementary Info: with accessories

Wear Warning Contact: not prepared for wear indicator / excl. wear warning contact

Height [mm] 45.3

Width [mm] 106

MAPP code available

RENAULT

13.0460-2840.2

602840

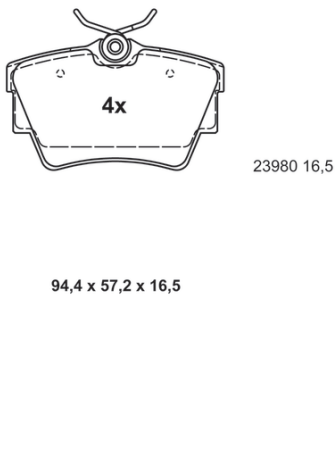

Brake Pad Set, disc brake

Thickness [mm] 16.5

Supplementary Article/Info 2: with brake caliper screws

Brake System: Lucas / TRW

Test Mark: E1 90R-01452/384

Observe dimensions

Wear Warning Contact: prepared for wear indicator / excl. wear warning contact

Height [mm] 57.2

Article number of recommended accessories: 13.0460-0072.2

Width [mm] 94.7

Number of bolts/screws: 4

MAPP code available

FIAT, NISSAN, OPEL, RENAULT, VAUXHALL

13.0460-4830.2

604830

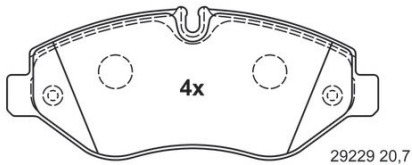

163,1 x 67,1 x 20,7

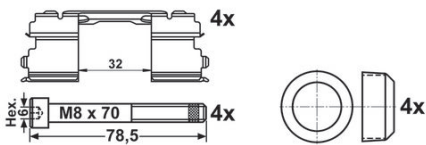

Brake Pad Set, disc brake

Thickness [mm] 20.7

Supplementary Article/Info 2: with brake caliper screws

Brake System: Brembo

Test Mark: E1 90R-011106/958

Supplementary Article/Supplementary Info: with accessories

Wear Warning Contact: prepared for wear indicator / excl. wear warning contact

Height [mm] 67.1

Width [mm] 163.1

Number of bolts/screws: 4

MAPP code available

IVECO

13.0460-4966.2

604966

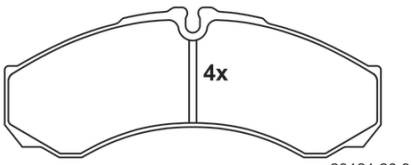

164,6 x 66,5 x 20,3

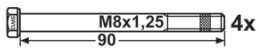

Brake Pad Set, disc brake

Thickness [mm] 20.3

Supplementary Article/Info 2: with brake caliper screws

Brake System: Brembo

Test Mark: E1 90R-011136/1073

Observe dimensions

Wear Warning Contact: prepared for wear indicator / excl. wear warning contact

Height [mm] 66.5

Article number of recommended accessories: 24.8190-1304.2

Width [mm] 164.6

Number of bolts/screws: 4

MAPP code available

IVECO, RENAULT TRUCKS

13.0460-4996.2

604996

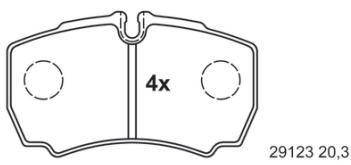

109,8 x 63,8 x 20,3



Brake Pad Set, disc brake

Thickness [mm] 20.3

Brake System: Brembo

Test Mark: E1 90R-01686/722

Wear Warning Contact: prepared for wear indicator / excl. wear warning contact

Height [mm] 63.8

Width [mm] 109.8

MAPP code available

IVECO

13.0460-5508.2

605508

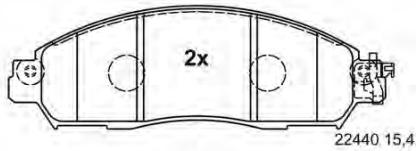
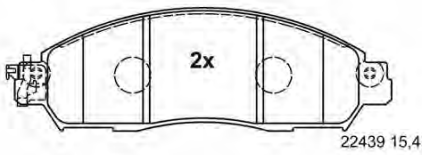

165,5 x 54,0 x 15,4



Brake Pad Set, disc brake

Thickness [mm] 15.4
 Brake System: Akebono
 Test Mark: E1 90R-02A0335/0636
 Wear Warning Contact: with acoustic wear warning
 Height [mm] 54
 Width [mm] 165.5
 MAPP code available

NISSAN

13.0460-5510.2

605510

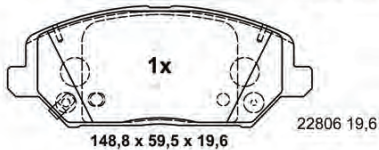
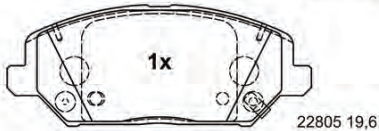
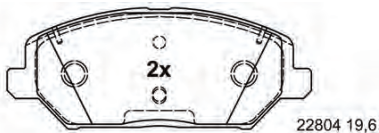

148,8 x 59,5 x 19,6

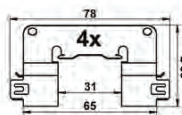
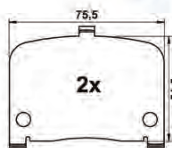

Brake Pad Set, disc brake

Thickness [mm] 19.6
 Supplementary Article/Info 2: with anti-squeak plate
 Brake System: Mobis
 Test Mark: E9 90R-02A1248/4999
 Supplementary Article/Supplementary Info: with accessories
 Wear Warning Contact: with acoustic wear warning
 Height [mm] 59.5
 Width [mm] 148.8
 MAPP code available

HYUNDAI, KIA

13.0460-5525.2

605525



98,6 x 64,3 x 16,0

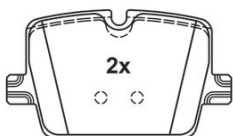

98,6 x 55,9 x 16,0

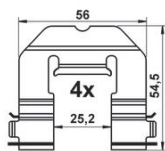
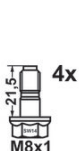

Brake Pad Set, disc brake

Thickness [mm] 16
 Supplementary Article/Info 2: with brake caliper screws
 Height 1 [mm]: 64.3
 Brake System: Mando
 Test Mark: E1 90R-02A0730/0619
 Supplementary Article/Supplementary Info: with accessories
 Observe dimensions
 Wear Warning Contact: prepared for wear indicator / excl. wear warning contact
 Width [mm] 98.6
 Number of bolts/screws: 4
 Height 2 [mm]: 55.9
 MAPP code available

BMW, TOYOTA

13.0460-5527.2

605527

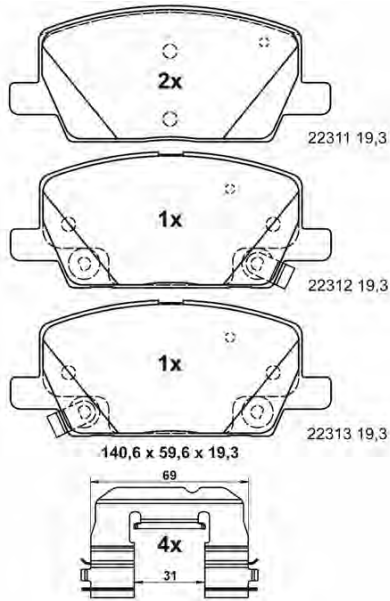

Brake Pad Set, disc brake

Thickness [mm] 19.3
 Brake System: Mando
 Test Mark: E1 90R-02A0477/0612
 Supplementary Article/Supplementary Info: with accessories
 Wear Warning Contact: with acoustic wear warning
 Height [mm] 59.6
 Width [mm] 140.6
 MAPP code available
 Number of wear indicators [per axle]: 2

CHEVROLET, OPEL, VAUXHALL

13.0460-5540.2

605540

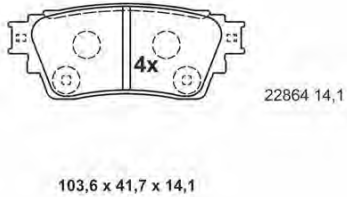

Brake Pad Set, disc brake

Thickness [mm] 14.1
 Brake System: Advics
 Test Mark: E1 90R-02A0525/0707
 Wear Warning Contact: with acoustic wear warning
 Height [mm] 41.7
 Width [mm] 103.6
 MAPP code available

MITSUBISHI



13.0460-5847.2

605847

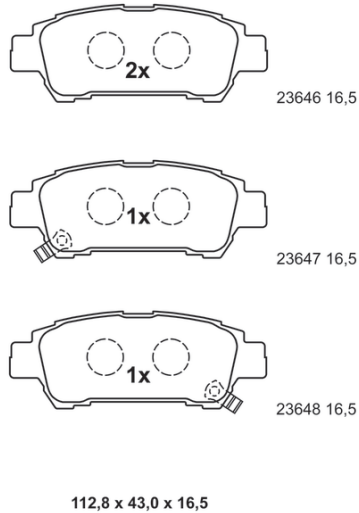

Brake Pad Set, disc brake

Thickness [mm] 16.5
 Brake System: Sumitomo
 Test Mark: E9 90R-01231/355
 Wear Warning Contact: with acoustic wear warning
 Height [mm] 43
 Width [mm] 112.8
 MAPP code available

TOYOTA

13.0460-7326.2

607326

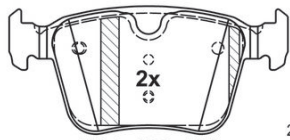

22141 15,5

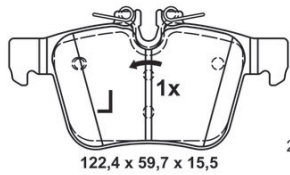

22142 15,5

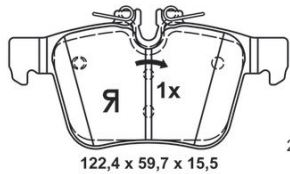

22142 15,5



Brake Pad Set, disc brake

Thickness [mm] 15.5

Height 1 [mm]: 56.2

Brake System: ATE

Width 2 [mm]: 122.4

Width 1 [mm]: 122.4

Test Mark: E1 90R-02A0401/0262

Wear Warning Contact: prepared for wear indicator / excl. wear warning contact

Article number of recommended accessories: 24.8190-0815.2 / 24.8190-0816.2

Height 2 [mm]: 59.7

MAPP code available

JAGUAR, LAND ROVER, POLESTAR, VOLVO

13.0460-7345.2

607345

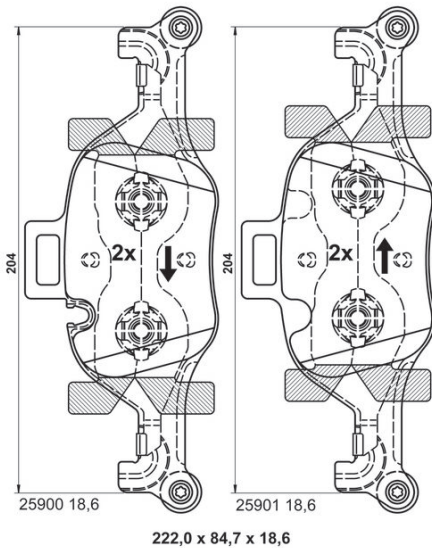

222,0 x 84,7 x 18,6



Brake Pad Set, disc brake

Thickness [mm] 18.6

Brake System: ATE

Width 2 [mm]: 204

Width 1 [mm]: 222

Test Mark: E1 90R-02A0612/0589

Wear Warning Contact: prepared for wear indicator / excl. wear warning contact

Height [mm] 84.7

Article number of recommended accessories: 24.8190-0824.2

MAPP code available

BMW

13.0470-2609.2

LD2609

ATE Ceramic

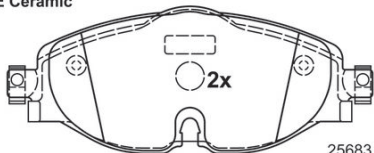

25683 20,4

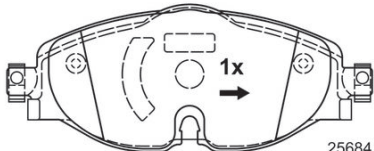

25684 20,4

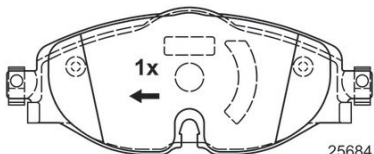

25684 20,4

160,0 x 64,5 x 20,4

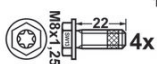

4x



Brake Pad Set, disc brake

Thickness [mm] 20.4

Supplementary Article/Info 2: with brake caliper screws

Brake System: Lucas / TRW

Test Mark: E1 90R-02A0213/0074

Wear Warning Contact: prepared for wear indicator / excl. wear warning contact

Height [mm] 64.5

Width [mm] 160

Number of bolts/screws: 4

MAPP code available

AUDI, SKODA, VW

13.0470-2763.2

LD2763

ATE Ceramic



23661 17,2

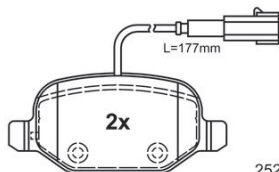

25237 17,2

95,5 x 43,9 x 17,2

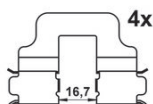

Brake Pad Set, disc brake

Thickness [mm] 17.2

Supplementary Article/Info 2: with brake caliper screws

Warning Contact Length [mm]: 177

Brake System: Lucas / TRW

Test Mark: E1 90R-02A1242/0354

Supplementary Article/Supplementary Info: with accessories

Wear Warning Contact: incl. wear warning contact

Height [mm] 43.9

Width [mm] 95.5

Number of bolts/screws: 4

MAPP code available

ALFA ROMEO

13.0470-4870.2

LD4870

ATE Ceramic

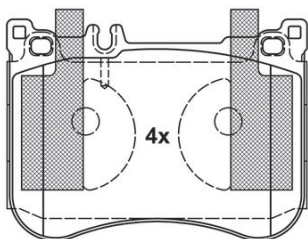

25179 17,8

132,0 x 97,5 x 17,8



Brake Pad Set, disc brake

Thickness [mm] 17.8

Brake System: Brembo

Test Mark: E1 90R-02A0479/0721

Observe dimensions

Wear Warning Contact: prepared for wear indicator / excl. wear warning contact

Height [mm] 97.5

Article number of recommended accessories: 24.8190-0959.2

Width [mm] 132

MAPP code available

MERCEDES-BENZ

13.0470-5525.2

LD5525

ATE Ceramic

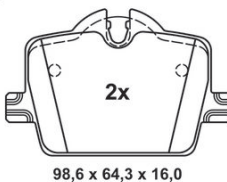

21433 16,0

98,6 x 64,3 x 16,0

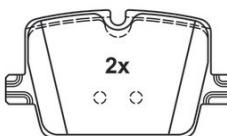

21434 16,0

98,6 x 55,9 x 16,0

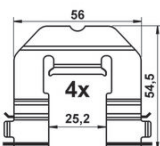

Brake Pad Set, disc brake

Thickness [mm] 16

Supplementary Article/Info 2: with brake caliper screws

Height 1 [mm]: 64.3

Brake System: Mando

Test Mark: E1 90R-02A0258/0626

Supplementary Article/Supplementary Info: with accessories

Observe dimensions

Wear Warning Contact: prepared for wear indicator / excl. wear warning contact

Width [mm] 98.6

Number of bolts/screws: 4

Height 2 [mm]: 55.9

MAPP code available

BMW, TOYOTA

13.0470-5540.2

LD5540

ATE Ceramic

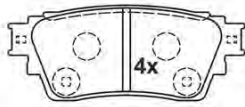

22864 14,1

103,6 x 41,7 x 14,1

4x



Brake Pad Set, disc brake

Thickness [mm] 14.1

Brake System: Advics

Test Mark: E1 90R-02A0258/0708

Wear Warning Contact: with acoustic wear warning

Height [mm] 41.7

Width [mm] 103.6

MAPP code available

MITSUBISHI

13.0470-5654.2

LD5654

ATE Ceramic

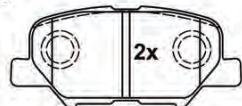

25688 14,4

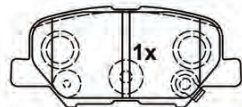

25689 14,4

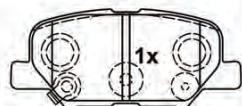

25690 14,4

101,4 x 44,5 x 14,4



Brake Pad Set, disc brake

Thickness [mm] 14.4

Brake System: Mando

Test Mark: E9 90R-02A1242/3652

Wear Warning Contact: with acoustic wear warning

Height [mm] 44.5

Article number of recommended accessories: 13.0460-0534.2

Width [mm] 101.4

MAPP code available

CITROËN, MAZDA, MITSUBISHI, PEUGEOT

13.0470-7326.2

LD7326

ATE Ceramic

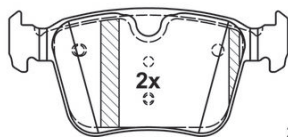

22141 15,5

122,4 x 56,2 x 15,5

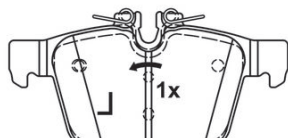

22142 15,5

122,4 x 59,7 x 15,5

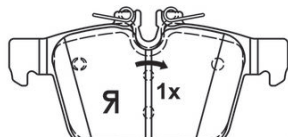

22142 15,5

122,4 x 59,7 x 15,5



Brake Pad Set, disc brake

Thickness [mm] 15.5

Height 1 [mm]: 56.2

Brake System: ATE

Width 2 [mm]: 122.4

Width 1 [mm]: 122.4

Test Mark: E1 90R-02A0402/0263

Wear Warning Contact: prepared for wear indicator / excl. wear warning contact

Article number of recommended accessories: 24.8190-0815.2 / 24.8190-0816.2

Height 2 [mm]: 59.7

MAPP code available

JAGUAR, LAND ROVER, VOLVO

13.0470-7337.2 LD7337

ATE Ceramic



22582 16,3

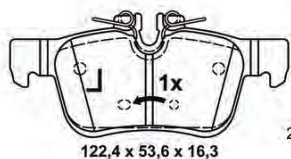

22568 16,3

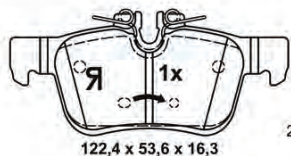

22568 16,3



Brake Pad Set, disc brake

Thickness [mm] 16.3
 Height 1 [mm]: 48.4
 Brake System: ATE
 Width 2 [mm]: 122.4
 Width 1 [mm]: 122.4
 Test Mark: E1 90R-02A0258/0716
 Wear Warning Contact: prepared for wear indicator / excl. wear warning contact
 Height 2 [mm]: 52.1
 MAPP code available

VOLVO

13.0470-7345.2 LD7345

ATE Ceramic

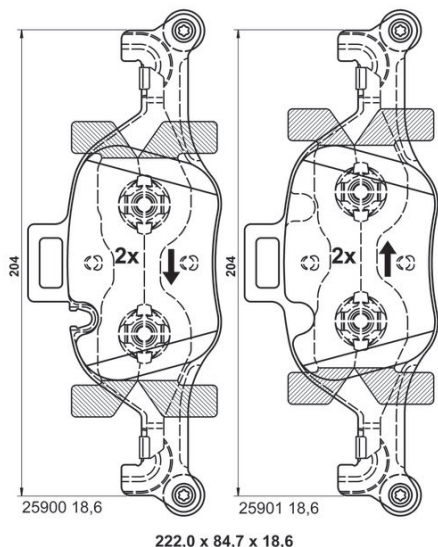

222,0 x 84,7 x 18,6



Brake Pad Set, disc brake

Thickness [mm] 18.6
 Brake System: ATE
 Width 2 [mm]: 204
 Width 1 [mm]: 222
 Test Mark: E1 90R-02A0479/0590
 Wear Warning Contact: prepared for wear indicator / excl. wear warning contact
 Height [mm] 84.7
 Article number of recommended accessories: 24.8190-0824.2
 MAPP code available

BMW

24.0109-0182.1 409182

Abbildung ähnlich
 Illustration similar

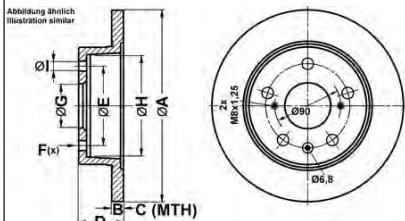

	A	B	C	D	E	F ^(*)	G	H	I
	259,4	9,0	8,0	43,2	114,3	5	62,0	146,6	14,0



Brake Disc

Inner diameter [mm]: 146.6
 Minimum thickness [mm] 8
 Brake Disc Thickness [mm] 9
 Test Mark: E1 90R-02C0165/0836
 Surface Coated
 Centering Diameter [mm]: 62
 Number of Holes: 5
 Bore Ø [mm] 14
 Bolt Hole Circle Ø [mm]: 114.3
 Height [mm] 43.2
 MAPP code available
 Brake Disc Type: Solid
 Outer diameter [mm]: 259.4

SUZUKI

24.0110-0356.1

410356



Brake Disc

- Inner diameter [mm]: 174.5
- Minimum thickness [mm] 8
- Supplementary Article/Info 2: with bolts/screws
- Brake Disc Thickness [mm] 9.7
- Test Mark: E1 90R-02C0165/0523
- Surface Coated
- Centering Diameter [mm]: 65
- Number of Holes: 9
- Bore Ø [mm] 15.3
- Bolt Hole Circle Ø [mm]: 112
- Height [mm] 48.2
- MAPP code available
- Brake Disc Type: Solid
- Outer diameter [mm]: 272
- AUDI, CUPRA, SEAT, SKODA, VW**

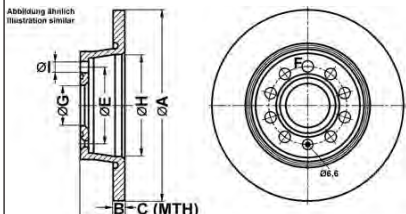

	A	B	C	D	E	F(x)	G	H	I
	272,0	9,7	8,0	48,2	112,0	9	65,0	174,5	15,3

24.0110-0368.1

410368



Brake Disc

- Inner diameter [mm]: 162.3
- Minimum thickness [mm] 8.4
- Brake Disc Thickness [mm] 10
- Test Mark: E1 90R-02C0165/0719
- Surface Coated
- Centering Diameter [mm]: 76
- Number of Holes: 5
- Bore Ø [mm] 12.5
- Bolt Hole Circle Ø [mm]: 114.3
- Height [mm] 45
- MAPP code available
- Brake Disc Type: Solid
- Outer diameter [mm]: 262
- HYUNDAI, KIA**

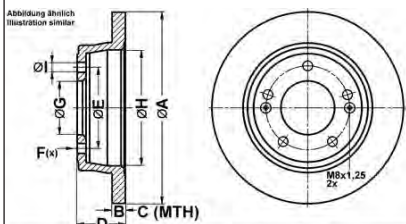

	A	B	C	D	E	F(x)	G	H	I
	262,0	10,0	8,4	45,0	114,3	5	76,0	162,3	12,5

24.0110-0400.1

410400



Brake Disc

- Inner diameter [mm]: 155
- Minimum thickness [mm] 8.4
- Machining: High-carbon
- Brake Disc Thickness [mm] 10
- Test Mark: E1 90R-02C0165/0359
- Surface Coated
- Centering Diameter [mm]: 76
- Number of Holes: 5
- Bore Ø [mm] 12.5
- Bolt Hole Circle Ø [mm]: 114.3
- Height [mm] 31.9
- MAPP code available
- Brake Disc Type: Solid
- Outer diameter [mm]: 284
- HYUNDAI, KIA**

Abbildung ähnlich
Illustration similar

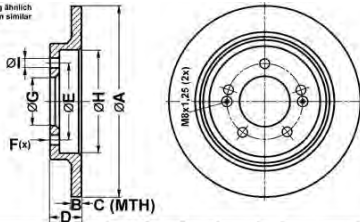

	A	B	C	D	E	F(x)	G	H	I
	284,0	10,0	8,4	31,9	114,3	5	76,0	155,0	12,5

24.0110-0408.1

410408



Brake Disc

- Inner diameter [mm]: 162
- Minimum thickness [mm] 8.4
- Machining: High-carbon
- Brake Disc Thickness [mm] 10
- Test Mark: E1 90R-02C0165/1035
- Surface Coated
- Centering Diameter [mm]: 76
- Number of Holes: 5
- Bore Ø [mm] 12.5
- Bolt Hole Circle Ø [mm]: 114.3
- Height [mm] 32.2
- MAPP code available
- Brake Disc Type: Solid
- Outer diameter [mm]: 262
- HYUNDAI, KIA**

Abbildung ähnlich
Illustration similar

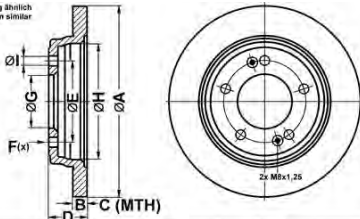

	A	B	C	D	E	F(x)	G	H	I
	262,0	10,0	8,4	32,2	114,3	5	76,0	162,0	12,5

24.0112-0190.1

412190



Brake Disc

- Inner diameter [mm]: 167.5
- Minimum thickness [mm] 10
- Machining: Alloyed / High-carbon
- Supplementary Article/Info 2: with bolts/screws
- Brake Disc Thickness [mm] 12
- Test Mark: E1 90R-02C0165/1116
- Surface Coated
- Centering Diameter [mm]: 91
- Number of Holes: 5
- Bore Ø [mm] 17
- Bolt Hole Circle Ø [mm]: 130
- Height [mm] 71.5
- MAPP code available
- Brake Disc Type: Solid
- Outer diameter [mm]: 305
- NISSAN, OPEL, RENAULT, VAUXHALL**

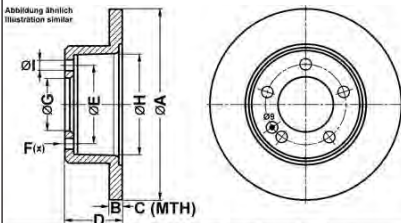

	A	B	C	D	E	F(x)	G	H	I
	305,0	12,0	10,0	71,5	130,0	5	91,0	167,5	17,0

24.0112-0191.1

412191



Brake Disc

- Inner diameter [mm]: 167
- Minimum thickness [mm] 10
- Machining: Alloyed / High-carbon
- Supplementary Article/Info 2: with bolts/screws
- Brake Disc Thickness [mm] 12
- Test Mark: E1 90R-02C0165/1116
- Surface Coated
- Centering Diameter [mm]: 90
- Number of Holes: 5
- Bore Ø [mm] 15.5
- Bolt Hole Circle Ø [mm]: 130
- Height [mm] 71.4
- MAPP code available
- Brake Disc Type: Solid
- Outer diameter [mm]: 305
- NISSAN, OPEL, RENAULT, VAUXHALL**

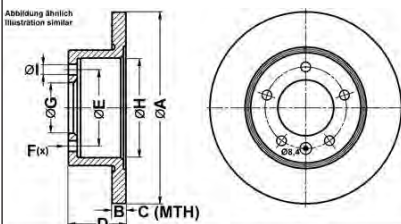

	A	B	C	D	E	F(x)	G	H	I
	305,0	12,0	10,0	71,4	130,0	5	90,0	167,0	15,5

24.0112-0210.1

412210

**Brake Disc**

Inner diameter [mm]: 173
Minimum thickness [mm] 10
No. of holes 2: 9
Supplementary Article/Info 2: with bolts/screws
Brake Disc Thickness [mm] 12
Test Mark: E1 90R-02C0165/0904
Surface Coated
Centering Diameter [mm]: 65
Number of Holes: 5
Bore Ø [mm] 15.3
Bolt Hole Circle Ø [mm]: 112
Height [mm] 48.2
MAPP code available
Brake Disc Type: Solid
Outer diameter [mm]: 300
AUDI, SEAT, SKODA, VW

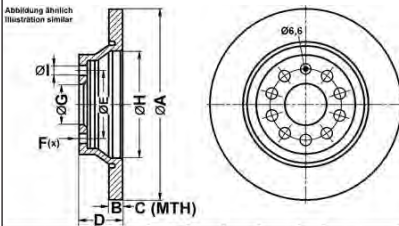

	A	B	C	D	E	F(x)	G	H	I
	300,0	12,0	10,0	48,2	112,0	5/9	65,0	173,0	15,3

24.0113-0200.1

413200

**Brake Disc**

Inner diameter [mm]: 158
Minimum thickness [mm] 11
Brake Disc Thickness [mm] 13
Test Mark: E1 90R-02C0165/0620
Surface Coated
Centering Diameter [mm]: 68
Number of Holes: 5
Bore Ø [mm] 12.7
Bolt Hole Circle Ø [mm]: 114.3
Height [mm] 47
MAPP code available
Brake Disc Type: Solid
Outer diameter [mm]: 290
NISSAN, RENAULT

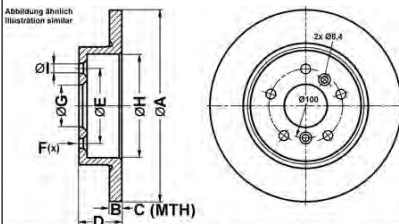

	A	B	C	D	E	F(x)	G	H	I
	290,0	13,0	11,0	47,0	114,3	5	68,0	158,0	12,7

24.0118-0153.1

418153

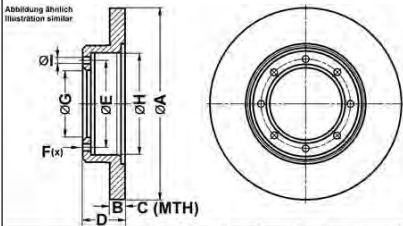

	A	B	C	D	E	F(x)	G	H	I
	302,0	18,0	15,0	51,0	140,0	8	120,0	164,0	10,9



Brake Disc

- Inner diameter [mm]: 164
- Minimum thickness [mm] 15
- Brake Disc Thickness [mm] 18
- Test Mark: E1 90R-02C0165/1056
- Surface Coated
- Centering Diameter [mm]: 120
- Number of Holes: 8
- Bore Ø [mm] 10.9
- Bolt Hole Circle Ø [mm]: 140
- Height [mm] 51
- MAPP code available
- Brake Disc Type: Solid
- Outer diameter [mm]: 302
- NISSAN, OPEL, RENAULT, VAUXHALL**

24.0122-0270.1

422270

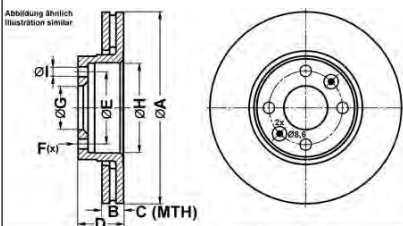

	A	B	C	D	E	F(x)	G	H	I
	258,0	22,0	19,8	44,0	100,0	4	61,0	125,3	13,5



Brake Disc

- Inner diameter [mm]: 125.3
- Minimum thickness [mm] 19.8
- Machining: High-carbon
- Supplementary Article/Info 2: with bolts/screws
- Brake Disc Thickness [mm] 22
- Test Mark: E1 90R-02C0118/0362
- Surface Coated
- Centering Diameter [mm]: 61
- Number of Holes: 4
- Bore Ø [mm] 13.5
- Bolt Hole Circle Ø [mm]: 100
- Height [mm] 44
- MAPP code available
- Brake Disc Type: Vented
- Outer diameter [mm]: 258
- DACIA, LADA, MERCEDES-BENZ, RENAULT**

24.0122-0290.1

422290

**Brake Disc**

Inner diameter [mm]: 146.3

Minimum thickness [mm] 20

Brake Disc Thickness [mm] 22

Test Mark: E1 90R-02C0115/1106

Surface Coated

Centering Diameter [mm]: 62

Number of Holes: 5

Bore Ø [mm] 12.7

Bolt Hole Circle Ø [mm]: 114.3

Height [mm] 47

MAPP code available

Brake Disc Type: Vented

Outer diameter [mm]: 280

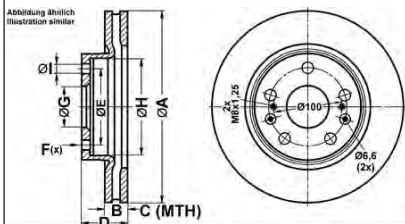
SUZUKI

	A	B	C	D	E	F(x)	G	H	I
	280,0	22,0	20,0	47,0	114,3	5	62,0	146,3	12,7

24.0125-0145.1

425145

**Brake Disc**

Inner diameter [mm]: 144

Minimum thickness [mm] 22

Machining: High-carbon

No. of holes 2: 9

Supplementary Article/Info 2: with bolts/screws

Brake Disc Thickness [mm] 25

Test Mark: E1 90R-02C0115/0010

Surface Coated

Centering Diameter [mm]: 65

Number of Holes: 5

Bore Ø [mm] 15.3

Bolt Hole Circle Ø [mm]: 112

Height [mm] 49.9

MAPP code available

Brake Disc Type: Vented

Outer diameter [mm]: 288

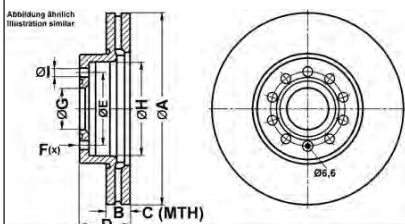
AUDI, CUPRA, SEAT, SKODA, VW

	A	B	C	D	E	F(x)	G	H	I
	288,0	25,0	22,0	49,9	112,0	5/9	65,0	144,0	15,3

24.0125-0158.1

425158

**Brake Disc**

Inner diameter [mm]: 146
Minimum thickness [mm] 22
Machining: High-carbon
No. of holes 2: 9
Supplementary Article/Info 2: with bolts/screws
Brake Disc Thickness [mm] 25
Test Mark: E1 90R-02C0115/1001
Surface Coated
Centering Diameter [mm]: 65
Number of Holes: 5
Bore Ø [mm] 15.3
Bolt Hole Circle Ø [mm]: 112
Height [mm] 49.9
MAPP code available
Brake Disc Type: Vented
Outer diameter [mm]: 312
AUDI, CUPRA, SEAT, SKODA, VW

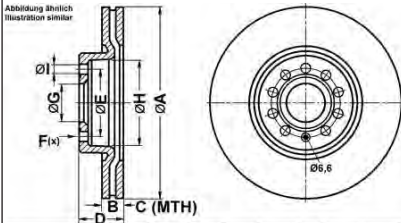

	A	B	C	D	E	F(x)	G	H	I
	312,0	25,0	22,0	49,9	112,0	5/9	65,0	146,0	15,3

24.0125-0222.1

425222

**Brake Disc**

Inner diameter [mm]: 135.1
Minimum thickness [mm] 22.4
Machining: Alloyed / High-carbon
Supplementary Article/Info 2: with bolts/screws
Brake Disc Thickness [mm] 25
Test Mark: E1 90R-02C0115/1003
Surface Coated
Centering Diameter [mm]: 65
Number of Holes: 5
Bore Ø [mm] 15.4
Bolt Hole Circle Ø [mm]: 100
Height [mm] 44.2
MAPP code available
Brake Disc Type: Vented
Outer diameter [mm]: 312
AUDI

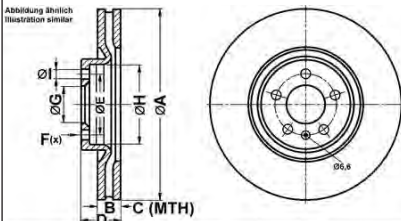

	A	B	C	D	E	F(x)	G	H	I
	312,0	25,0	22,4	44,2	100,0	5	65,0	135,1	15,4

24.0128-0238.1

428238



Brake Disc

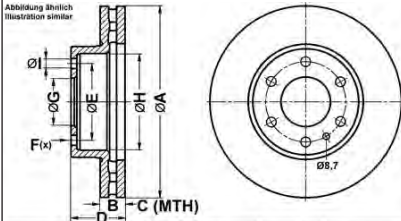

	A	B	C	D	E	F(x)	G	H	I
	300,0	28,0	25,0	74,5	125,0	6	78,0	156,0	15,5

- Inner diameter [mm]: 156
- Minimum thickness [mm] 25
- Brake Disc Thickness [mm] 28
- Test Mark: E1 90R-02C0115/0577
- Surface Coated
- Centering Diameter [mm]: 78
- Number of Holes: 6
- Bore Ø [mm] 15.5
- Bolt Hole Circle Ø [mm]: 125
- Height [mm] 74.5
- MAPP code available
- Brake Disc Type: Vented
- Outer diameter [mm]: 300
- IVECO**

24.0128-0239.1

428239



Brake Disc

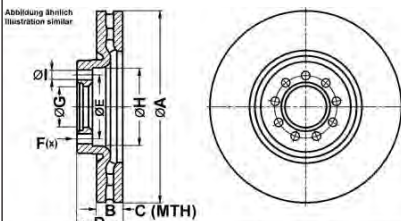

	A	B	C	D	E	F(x)	G	H	I
	290,0	28,0	25,0	46,0	95,0	9	64,0	123,0	12,5

- Inner diameter [mm]: 123
- Minimum thickness [mm] 25
- Brake Disc Thickness [mm] 28
- Test Mark: E1 90R-02C0115/0057
- Surface Coated
- Centering Diameter [mm]: 64
- Number of Holes: 9
- Bore Ø [mm] 12.5
- Bolt Hole Circle Ø [mm]: 95
- Height [mm] 46
- MAPP code available
- Brake Disc Type: Vented
- Outer diameter [mm]: 290
- IVECO**

24.0128-0252.1

428252

**Brake Disc**

Inner diameter [mm]: 160.5
Minimum thickness [mm] 24.5
Supplementary Article/Info 2: with bolts/screws
Brake Disc Thickness [mm] 28
Test Mark: E1 90R-02C0115/0884
Surface Coated
Centering Diameter [mm]: 90
Number of Holes: 5
Bore Ø [mm] 17.4
Bolt Hole Circle Ø [mm]: 130
Height [mm] 69.9
MAPP code available
Brake Disc Type: Vented
Outer diameter [mm]: 302
NISSAN, OPEL, RENAULT, VAUXHALL

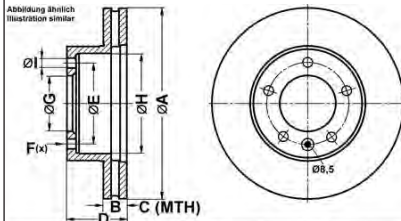
Abbildung ähnlich
Illustration similar

	A	B	C	D	E	F(x)	G	H	I
	302,0	28,0	24,5	69,9	130,0	5	90,0	160,5	17,4

24.0128-0287.1

428287

**Brake Disc**

Inner diameter [mm]: 147.7
Minimum thickness [mm] 23.4
Machining: High-carbon
Supplementary Article/Info 2: with bolts/screws
Brake Disc Thickness [mm] 28
Test Mark: E1 90R-02C0118/1075
Surface Coated
Centering Diameter [mm]: 68
Number of Holes: 5
Bore Ø [mm] 15.5
Bolt Hole Circle Ø [mm]: 114.3
Height [mm] 44
MAPP code available
Brake Disc Type: Vented
Outer diameter [mm]: 296
FIAT, NISSAN, OPEL, RENAULT, VAUXHALL

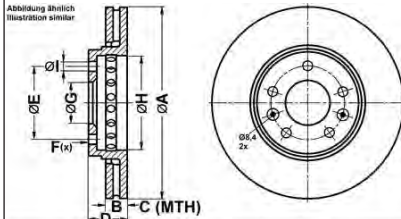
Abbildung ähnlich
Illustration similar

	A	B	C	D	E	F(x)	G	H	I
	296,0	28,0	23,4	44,0	114,3	5	68,0	149,0	15,5

24.0130-0253.1

430253

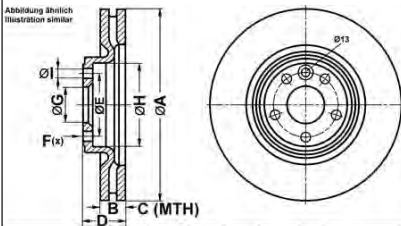

	A	B	C	D	E	F(x)	G	H	I
	325,0	30,0	28,0	48,0	108,0	5	63,5	145,0	15,8



Brake Disc

Inner diameter [mm]: 145

Minimum thickness [mm] 28

Machining: High-carbon

Brake Disc Thickness [mm] 30

Test Mark: E1 90R-02C0115/1126

Surface Coated

Centering Diameter [mm]: 63.5

Number of Holes: 5

Bore Ø [mm] 15.8

Bolt Hole Circle Ø [mm]: 108

Height [mm] 48

MAPP code available

Brake Disc Type: Vented

Outer diameter [mm]: 325

JAGUAR, LAND ROVER

24.0310-0356.1

510356

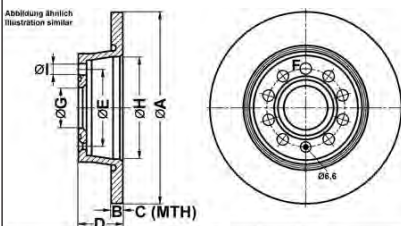

	A	B	C	D	E	F(x)	G	H	I
	272,0	9,7	8,0	48,2	112,0	9	65,0	174,5	15,3



Brake Disc

Inner diameter [mm]: 174.5

Minimum thickness [mm] 8

Supplementary Article/Info 2: with bolts/screws

Brake Disc Thickness [mm] 9.7

Surface Coated

Centering Diameter [mm]: 65

Number of Holes: 9

Bore Ø [mm] 15.3

Bolt Hole Circle Ø [mm]: 112

Height [mm] 48.2

MAPP code available

Brake Disc Type: Solid

Outer diameter [mm]: 272

AUDI, SEAT, SKODA, VW

24.0312-0188.1

512188

Abbildung ähnlich
Illustration similar

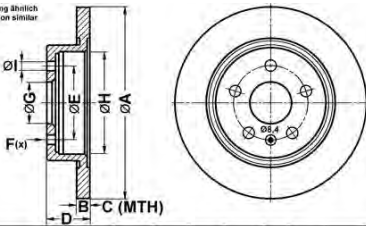

	A	B	C	D	E	F(x)	G	H	I
	268,0	12,0	10,0	44,9	105,0	5	60,0	147,0	14,2



Brake Disc

- Inner diameter [mm]: 147
- Minimum thickness [mm] 10
- Supplementary Article/Info 2: with bolts/screws
- Brake Disc Thickness [mm] 12
- Surface Coated
- Centering Diameter [mm]: 60
- Number of Holes: 5
- Bore Ø [mm] 14.2
- Bolt Hole Circle Ø [mm]: 105
- Height [mm] 44.9
- MAPP code available
- Brake Disc Type: Solid
- Outer diameter [mm]: 268
- CHEVROLET, OPEL, VAUXHALL**

24.0312-0189.1

512189

Abbildung ähnlich
Illustration similar

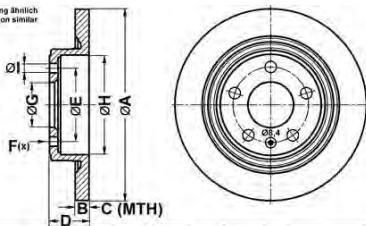

	A	B	C	D	E	F(x)	G	H	I
	292,0	12,0	10,0	45,0	115,0	5	70,7	157,0	14,2



Brake Disc

- Inner diameter [mm]: 157
- Minimum thickness [mm] 10
- Supplementary Article/Info 2: with bolts/screws
- Brake Disc Thickness [mm] 12
- Surface Coated
- Centering Diameter [mm]: 70.7
- Number of Holes: 5
- Bore Ø [mm] 14.2
- Bolt Hole Circle Ø [mm]: 115
- Height [mm] 45
- MAPP code available
- Brake Disc Type: Solid
- Outer diameter [mm]: 292
- CHEVROLET, OPEL, VAUXHALL**

24.0325-0158.1

525158

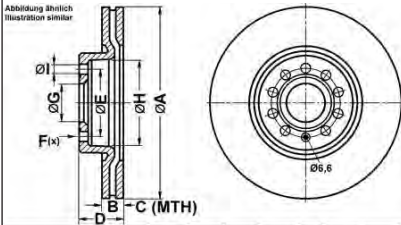

	A	B	C	D	E	F(x)	G	H	I
	312,0	25,0	22,0	49,9	112,0	5/9	65,0	146,0	15,3



Brake Disc

- Inner diameter [mm]: 146
- Minimum thickness [mm] 22
- Machining: High-carbon
- No. of holes 2: 9
- Supplementary Article/Info 2: with bolts/screws
- Brake Disc Thickness [mm] 25
- Test Mark: E1 90R-02C0858/1214
- Surface Coated
- Centering Diameter [mm]: 65
- Number of Holes: 5
- Bore Ø [mm] 15.3
- Bolt Hole Circle Ø [mm]: 112
- Height [mm] 49.9
- MAPP code available
- Brake Disc Type: Vented
- Outer diameter [mm]: 312
- AUDI, SEAT, SKODA, VW**

24.0326-0165.1

526165

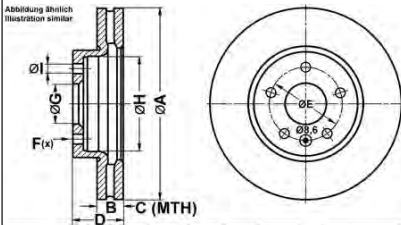

	A	B	C	D	E	F(x)	G	H	I
	276,0	26,0	23,0	45,5	105,0	5	60,0	139,0	14,2



Brake Disc

- Inner diameter [mm]: 139
- Minimum thickness [mm] 23
- Supplementary Article/Info 2: with bolts/screws
- Brake Disc Thickness [mm] 26
- Test Mark: E1 90R-02C0858/1206
- Surface Coated
- Centering Diameter [mm]: 60
- Number of Holes: 5
- Bore Ø [mm] 14.2
- Bolt Hole Circle Ø [mm]: 105
- Height [mm] 45.5
- MAPP code available
- Brake Disc Type: Vented
- Outer diameter [mm]: 276
- CHEVROLET, OPEL, VAUXHALL**

24.0326-0166.1

526166

**Brake Disc**

Inner diameter [mm]: 149

Minimum thickness [mm] 23

Machining: High-carbon

Supplementary Article/Info 2: with bolts/screws

Brake Disc Thickness [mm] 26

Surface Coated

Centering Diameter [mm]: 70.7

Number of Holes: 5

Bore Ø [mm] 14.2

Bolt Hole Circle Ø [mm]: 115

Height [mm] 45.5

MAPP code available

Brake Disc Type: Vented

Outer diameter [mm]: 300

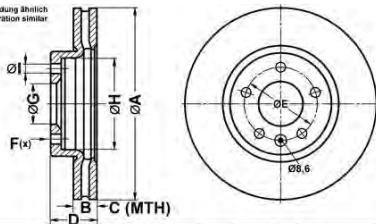
CHEVROLET, OPEL, VAUXHALLAbbildung ähnlich
Illustration similar

	A	B	C	D	E	F ^(R)	G	H	I
	300,0	26,0	23,0	45,5	115,0	5	70,7	149,0	14,2

24.0530-0001.5

241269

**Brake Caliper Axle Kit**

Supplementary Article/Info 2: with brake pads

Brake System: Lucas / TRW

Supplementary Article/Supplementary Info: with holder

Service exchange part

Piston Diameter [mm]: 34

MAPP code available

Brake Caliper Type: Fist-type Caliper / Aluminium brake caliper

OPEL, VAUXHALL

24.0710-2097.3

360647

**Wheel Speed Sensor**

MAPP code available

Length [mm]: 720

NISSAN, OPEL, RENAULT, VAUXHALL

24.0710-2099.3

360648

**Wheel Speed Sensor**

MAPP code available

Length [mm]: 592

DACIA, RENAULT

24.0710-2100.3

360649



Wheel Speed Sensor

MAPP code available

Length [mm]: 956

NISSAN, OPEL, RENAULT, VAUXHALL

24.0710-2122.3

360650



Wheel Speed Sensor

MAPP code available

Length [mm]: 1,073

MERCEDES-BENZ

24.0710-2123.3

360651



Wheel Speed Sensor

MAPP code available

Length [mm]: 1,049

MERCEDES-BENZ

24.0710-2127.3

360652



Wheel Speed Sensor

Supplementary Article/Info 2: without cable

MAPP code available

Length [mm]: 55.4

VOLVO

24.0710-2128.3

360653



Wheel Speed Sensor

Supplementary Article/Info 2: without cable

MAPP code available

Length [mm]: 43.4

VOLVO

24.0711-5273.3 360303



Wheel Speed Sensor

Supplementary Article/Info 2: without cable

MAPP code available

AUDI, CUPRA, SEAT, SKODA, VW

24.0711-5274.3 360304



Wheel Speed Sensor

Supplementary Article/Info 2: without cable

MAPP code available

AUDI, CUPRA, SEAT, SKODA, VW

24.0711-5401.3 360330



Wheel Speed Sensor

Supplementary Article/Info 2: without cable

MAPP code available

AUDI, CUPRA, PORSCHE, SEAT, SKODA, VW

24.0711-5402.3 360331



Wheel Speed Sensor

Supplementary Article/Info 2: without cable

MAPP code available

AUDI, CUPRA, PORSCHE, SEAT, SKODA, VW

24.0711-6337.3 360390



Wheel Speed Sensor

Supplementary Article/Info 2: without cable

MAPP code available

AUDI, CUPRA, SEAT, SKODA, VW

24.2126-3131.3

011038



Brake Master Cylinder

Supplementary Article/Info 2: without brake fluid reservoir

Brake System: ATE

Number of connectors: 2

Thread Size: M12x1

Length 2 [mm]: 139.8

Length 1 [mm]: 37.2

MAPP code available

Diameter [mm]: 27

VW

24.3223-1710.3

020557



Wheel Brake Cylinder

Material: Aluminium

MAPP code available

Piston Diameter [mm]: 23.8

ISUZU

24.3402-7003.5

241457



Brake Caliper

Brake System: ATE

Supplementary Article/Supplementary Info: without holder

Service exchange part

Piston Diameter [mm]: 40

paired article number: 24.3402-7004.5

MAPP code available

Brake Caliper Type: Fist-type Caliper

OPEL, VAUXHALL

24.3402-7004.5

241458



Brake Caliper

Brake System: ATE

Supplementary Article/Supplementary Info: without holder

Service exchange part

Piston Diameter [mm]: 40

paired article number: 24.3402-7003.5

MAPP code available

Brake Caliper Type: Fist-type Caliper

OPEL, VAUXHALL

24.3414-1707.5

240337



Brake Caliper

Brake System: Lucas / TRW

Supplementary Article/Supplementary Info: without holder

Service exchange part

Piston Diameter [mm]: 41

paired article number: 24.3414-1708.5

Brake Caliper Type: Fist-type Caliper

NISSAN, OPEL, RENAULT, VAUXHALL

24.3414-1708.5

240338



Brake Caliper

Brake System: Lucas / TRW

Supplementary Article/Supplementary Info: without holder

Service exchange part

Piston Diameter [mm]: 41

paired article number: 24.3414-1707.5

Brake Caliper Type: Fist-type Caliper

NISSAN, OPEL, RENAULT, VAUXHALL

24.3421-1723.5

241449



Brake Caliper

Supplementary Article/Supplementary Info: without holder

Service exchange part

Piston Diameter [mm]: 42

paired article number: 24.3421-1724.5

Brake Caliper Type: Fist-type Caliper

OPEL, SAAB, VAUXHALL

24.3481-1821.5

241355



Brake Caliper

Brake System: Brembo

Supplementary Article/Supplementary Info: without holder

Service exchange part

Piston Diameter [mm]: 48

paired article number: 24.3481-1822.5

Brake Caliper Type: Fist-type Caliper (2 pistons)

NISSAN, OPEL, RENAULT, VAUXHALL

24.3481-1822.5

241356



Brake Caliper

Brake System: Brembo

Supplementary Article/Supplementary Info: without holder

Service exchange part

Piston Diameter [mm]: 48

paired article number: 24.3481-1821.5

Brake Caliper Type: Fist-type Caliper (2 pistons)

NISSAN, OPEL, RENAULT, VAUXHALL

24.3481-1823.5

241477



Brake Caliper

Brake System: Bosch

Supplementary Article/Supplementary Info: without holder

Service exchange part

Piston Diameter [mm]: 48

paired article number: 24.3481-1824.5

Brake Caliper Type: Fist-type Caliper

FIAT

24.3481-1824.5

241478



Brake Caliper

Brake System: Bosch

Supplementary Article/Supplementary Info: without holder

Service exchange part

Piston Diameter [mm]: 48

paired article number: 24.3481-1823.5

Brake Caliper Type: Fist-type Caliper

FIAT

24.3484-1703.5

241303



Brake Caliper

Brake System: Bosch

Supplementary Article/Supplementary Info: without holder

Service exchange part

Piston Diameter [mm]: 48

paired article number: 24.3484-1704.5

MAPP code available

Brake Caliper Type: Fist-type Caliper

NISSAN, OPEL, RENAULT, VAUXHALL

24.3484-1704.5

241304



Brake Caliper

Brake System: Bosch

Supplementary Article/Supplementary Info: without holder

Service exchange part

Piston Diameter [mm]: 48

paired article number: 24.3484-1703.5

MAPP code available

Brake Caliper Type: Fist-type Caliper

NISSAN, OPEL, RENAULT, VAUXHALL

24.3571-1801.5

241387



Brake Caliper

Supplementary Article/Supplementary Info: without holder

Service exchange part

Piston Diameter [mm]: 57

paired article number: 24.3571-1802.5

Brake Caliper Type: Fist-type Caliper

AUDI, CUPRA, SEAT, SKODA, VW

24.3571-1802.5

241388



Brake Caliper

Supplementary Article/Supplementary Info: without holder

Service exchange part

Piston Diameter [mm]: 57

paired article number: 24.3571-1801.5

Brake Caliper Type: Fist-type Caliper

AUDI, CUPRA, SEAT, SKODA, VW

24.3571-1815.5

241485



Brake Caliper

Supplementary Article/Supplementary Info: without holder

Service exchange part

Piston Diameter [mm]: 57

paired article number: 24.3571-1816.5

Brake Caliper Type: Fist-type Caliper

CHRYSLER, CITROËN, JEEP, MITSUBISHI, PEUGEOT

24.3571-1816.5

241486



Brake Caliper

Supplementary Article/Supplementary Info: without holder

Service exchange part

Piston Diameter [mm]: 57

paired article number: 24.3571-1815.5

Brake Caliper Type: Fist-type Caliper

CHRYSLER, CITROËN, JEEP, MITSUBISHI, PEUGEOT

24.3601-2607.5

241487



Brake Caliper

Brake Caliper Colour: Red

Brake System: TRW

Supplementary Article/Supplementary Info: without holder

Service exchange part

Piston Diameter [mm]: 60

paired article number: 24.3601-2608.5

MAPP code available

Brake Caliper Type: Fist-type Caliper

VW

24.3601-2608.5

241488



Brake Caliper

Brake Caliper Colour: Red

Brake System: TRW

Supplementary Article/Supplementary Info: without holder

Service exchange part

Piston Diameter [mm]: 60

paired article number: 24.3601-2607.5

MAPP code available

Brake Caliper Type: Fist-type Caliper

VW

24.3727-3408.2

583408



Cable Pull, parking brake

MAPP code available

Length [mm]: 1,936

VW

24.3727-3503.2

583503



Cable Pull, parking brake

Length 2 [mm]: 1,468

Length [mm]: 1,453

OPEL, VAUXHALL

24.4123-1731.3**011094****Brake Master Cylinder**

Supplementary Article/Info 2: without brake fluid reservoir

Number of connectors: 2

Thread Size: M12x1

Length 1 [mm]: 32

MAPP code available

Material: Cast Aluminium

Diameter [mm]: 23.8

FIAT, JEEP**24.4156-1076.3****011070****Brake Master Cylinder**

Supplementary Article/Info 2: without brake fluid reservoir

Brake System: ATE

Number of connectors: 2

Thread Size: M12x1

Length 2 [mm]: 90

Length 1 [mm]: 19.5

MAPP code available

Diameter [mm]: 27

JAGUAR**24.5134-0420.3****331648****Brake Hose**

External Thread [mm]: M10x1

Internal Thread [mm]: M10x1

MAPP code available

Length [mm]: 465

BMW, MINI**24.5176-0233.3****331632****Brake Hose**

Flange Hole Diameter [mm]: 10

Internal Thread [mm]: M10x1

Supplementary Article/Info 2: with hollow screw

Thread Size: M10x1,5

Length [mm]: 245

MAPP code available

AUDI

24.5176-0673.3

331651



Brake Hose

Flange Hole Diameter [mm]: 10
Internal Thread [mm]: M10x1
Supplementary Article/Info 2: with hollow screw
Thread Size: M10x1
Length [mm]: 685
MAPP code available

OPEL, VAUXHALL

24.5177-0373.3

331541

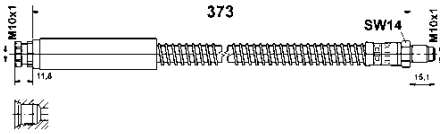

Brake Hose

External Thread [mm]: M10x1
Internal Thread [mm]: M10x1
MAPP code available
Length [mm]: 373
Spanner size 1 [mm]: 14

LAND ROVER

24.5229-0200.3

330572

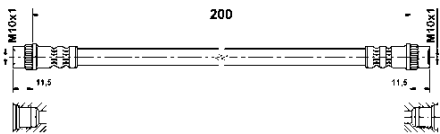

Brake Hose

Internal Thread 1 [mm]: M10x1
MAPP code available
Internal Thread 2 [mm]: M10x1
Length [mm]: 200

NISSAN, OPEL, PEUGEOT, RENAULT, VAUXHALL

24.5270-0450.3

331183

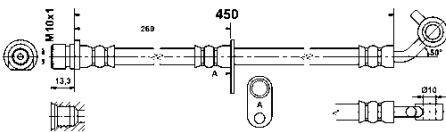

Brake Hose

Flange Hole Diameter [mm]: 10
Internal Thread [mm]: M10x1
Supplementary Article/Info 2: without hollow screw
Length [mm]: 450
MAPP code available

HONDA

24.5296-0540.3

331645



Brake Hose

Supplementary Article/Info 2: without hollow screw
Internal Thread [mm]: M10x1
Flange Hole Diameter [mm]: 10
MAPP code available
Length [mm]: 540

FORD

24.6238-7039.5

241313



Brake Caliper

Brake System: ATE

Vehicle Equipment: for vehicles with electric parking brake

Supplementary Article/Supplementary Info: without holder

Service exchange part

Piston Diameter [mm]: 38

paired article number: 24.6238-7040.5

MAPP code available

Brake Caliper Type: Fist-type Caliper

Brake Caliper Type: Brake caliper with adjusting element for electr. handbrake

JAGUAR, LAND ROVER

24.8190-0067.2

620067



Warning Contact, brake pad wear

Brake Type: Disc Brake

Length [mm]: 92.5

MERCEDES-BENZ

24.8190-0827.2

620827



Warning Contact, brake pad wear

Brake Type: Disc Brake

Length [mm]: 422

AUDI

24.8190-0828.2

620828



Warning Contact, brake pad wear

Length 2 [mm]: 237

Length 1 [mm]: 474

Brake Type: Disc Brake

Length [mm]: 711

BMW, MINI

24.8190-0830.2

620830



Warning Contact, brake pad wear

Brake Type: Disc Brake

Length [mm]: 260

AUDI, CUPRA, SKODA, VW

24.8190-0831.2

620831



Warning Contact, brake pad wear

Brake Type: Disc Brake

Length [mm]: 231

VW

24.8190-0959.2

620959



Warning Contact, brake pad wear

Brake Type: Disc Brake

Length [mm]: 102

MERCEDES-BENZ



EN Applications of vehicles

DE Fahrzeugverwendungen

ES Aplicaciones

FR Applications

IT Applicazioni autoveicoli

08/2022





	kW				
ALFA ROMEO - MITO (955_) 08/08→10/18					
 Brake Pad Set, disc brake					
0.9	74	12/13→08/18	Braking System: not for vehicles with reinforced brakes; Fitting Position: Rear Axle	13.0470-2763.2 LD2763	Brake System: Lucas / TRW Wear Warning Contact: incl. wear warning contact Supplementary Article/Supplementary Info: with accessories Ceramic
0.9 TwinAir	63 - 77	07/11→08/18			
1.3 MultiJet	59 - 70	08/08→10/18			
1.4	51 - 70	08/08→10/18			
1.4 Bifuel	88	01/09→10/18			
1.4 MultiAir	77 - 125	09/09→10/18			
1.4 TB	103	12/13→10/18			
1.4 TJet	88 - 114	08/08→08/13			
1.4 Turbo MultiAir	99 - 120	10/09→10/18			
1.6 JTDM	88	08/08→08/15			
1.4	57	03/11→10/18	Construction year from: 05/11 →; Braking System: not for vehicles with reinforced brakes; Fitting Position: Rear Axle	13.0470-2763.2 LD2763	Brake System: Lucas / TRW Wear Warning Contact: incl. wear warning contact Supplementary Article/Supplementary Info: with accessories Ceramic
1.6 JTDM	85	08/08→08/15	Construction year from: 09/09 →; Braking System: not for vehicles with reinforced brakes; Fitting Position: Rear Axle	13.0470-2763.2 LD2763	Brake System: Lucas / TRW Wear Warning Contact: incl. wear warning contact Supplementary Article/Supplementary Info: with accessories Ceramic
ALFA ROMEO - SPIDER (939_) 03/06→03/11					
Guide Sleeve Kit, brake caliper					
2.2 JTS	136	03/06→03/11	Construction year from: 04/06 → → Construction year to: 02/08; Fitting Position: Front Axle	11.0101-5407.2 260011	Brake System: ATE
Guide Bolt, brake caliper					
2.2 JTS	136	03/06→03/11	Construction year from: 04/06 → → Construction year to: 02/08; Required quantity: 2	2 11.8171-0008.1 990049	Brake System: ATE
AUDI - 80 B3 Saloon (893, 894, 8A2) 06/86→10/91					
Guide Bolt, brake caliper					
1.6	51 - 55	09/86→09/91	Construction year from: 08/89 → → Construction year to: 07/91; Transmission Type: Manual Transmission; Required quantity: 2; Fitting Position: Front Axle	2 11.8171-0008.1 990049	Brake System: ATE
			Construction year from: 08/89 → → Construction year to: 07/91; Transmission Type: Automatic Transmission; Required quantity: 2; Fitting Position: Front Axle	2 11.8171-0008.1 990049	Brake System: ATE
			→ Construction year to: 07/89; Required quantity: 2; Fitting Position: Front Axle	2 11.8171-0008.1 990049	Brake System: ATE
1.6	75	08/90→10/91	Transmission Type: Manual Transmission; Required quantity: 2; Fitting Position: Front Axle	2 11.8171-0008.1 990049	Brake System: ATE
1.8	55	10/86→01/90	Transmission Type: Automatic Transmission; Required quantity: 2; Fitting Position: Front Axle	2 11.8171-0008.1 990049	Brake System: ATE
1.6 D	40	02/87→07/89	Required quantity: 2; Fitting Position: Front Axle	2 11.8171-0008.1 990049	Brake System: ATE
1.8 E quattro	82	09/86→08/91			
1.8 quattro	83	09/86→08/90			
1.8 S quattro	65 - 66	09/86→09/91			
2.0 E	83	08/88→10/90			
2.0 E 16V quattro	101	03/90→08/91			
2.0 E quattro	83	08/88→09/90			
2.0 quattro	82 - 85	08/88→08/91			
1.6 TD	59	09/86→08/91	Construction year from: 04/88 → → Construction year to: 07/91; Special Purpose Vehicle: for taxis; Required quantity: 2; Fitting Position: Front Axle	2 11.8171-0008.1 990049	Brake System: ATE
			Construction year from: 08/89 → → Construction year to: 07/91; Transmission Type: Automatic Transmis-	2 11.8171-0008.1 990049	Brake System: ATE



	kW				
AUDI - 80 B3 Saloon (893, 894, 8A2) 06/86→10/91					
Guide Bolt, brake caliper					
1.6 TD	59	09/86→08/91	sion; Required quantity: 2; Fitting Position: Front Axle		
			Construction year from: 08/89 → → Construction year to: 07/91; Special Purpose Vehicle: not for taxis; Transmission Type: Manual Transmission; Required quantity: 2; Fitting Position: Front Axle	2	11.8171-0008.1 990049 Brake System: ATE
			Construction year from: 04/88 → → Construction year to: 07/89; Special Purpose Vehicle: not for taxis; Required quantity: 2; Fitting Position: Front Axle	2	11.8171-0008.1 990049 Brake System: ATE
1.8 E	82	06/86→08/91	Construction year from: 09/86 → → Construction year to: 07/91; Required quantity: 2; Fitting Position: Front Axle	2	11.8171-0008.1 990049 Brake System: ATE
1.8 S	66	09/86→10/91	→ Construction year to: 07/91; Transmission Type: Manual Transmission; Required quantity: 2; Fitting Position: Front Axle	2	11.8171-0008.1 990049 Brake System: ATE
			→ Construction year to: 07/91; Transmission Type: Automatic Transmission; Required quantity: 2; Fitting Position: Front Axle	2	11.8171-0008.1 990049 Brake System: ATE
1.9 D	50	08/89→08/91	→ Construction year to: 07/91;	2	11.8171-0008.1 990049 Brake System: ATE
2.0	82	10/90→08/91	Required quantity: 2;		
2.0 E 16V	101	03/90→09/91	Fitting Position: Front Axle		
AUDI - 90 B3 (893, 894, 8A2) 04/87→09/91					
Guide Bolt, brake caliper					
1.6 TD	59	04/87→09/91	Construction year from: 04/88 → → Construction year to: 07/91; Required quantity: 2; Fitting Position: Front Axle	2	11.8171-0008.1 990049 Brake System: ATE
2.0	85	07/88→09/91	→ Construction year to: 07/91; Required quantity: 2; Fitting Position: Front Axle	2	11.8171-0008.1 990049 Brake System: ATE
2.0 20 V quattro	118	08/88→09/91	Required quantity: 2;	2	11.8171-0008.1 990049 Brake System: ATE
2.0 quattro	101	08/89→07/90	Fitting Position: Front Axle		
2.2 E	100	04/87→07/91			
2.2 E quattro	100	04/87→09/91			
2.3 E	100	04/87→07/91			
2.3 E quattro	100	04/87→07/91			
AUDI - 100 C3 Avant (445, 446) 08/82→11/90					
Guide Bolt, brake caliper					
1.8	55 - 66	08/82→07/90	Vehicle Identification Number from: 44-H-073661 →; Required quantity: 2; Fitting Position: Front Axle	2	11.8171-0008.1 990049 Brake System: ATE
1.8 Cat	66	03/85→11/90			
2.0	83	09/86→11/87	→ Vehicle Identification Number to: 44-H-073660; Required quantity: 2;	2	11.8171-0008.1 990049 Brake System: ATE
2.0 E	85	01/85→12/87	Fitting Position: Front Axle		
2.0 E Cat	85	01/88→11/90			
2.0 TD	74	03/88→11/90			
2.2	85	10/84→09/86			
1.9	74	02/83→07/84	Required quantity: 2;	2	11.8171-0008.1 990049 Brake System: ATE
2.4 D	60	08/89→11/90	Fitting Position: Front Axle		
2.0 D	51	03/83→11/90	→ Construction year to: 07/84; Required quantity: 2; Fitting Position: Front Axle	2	11.8171-0008.1 990049 Brake System: ATE
			Construction year from: 08/84 →; → Vehicle Identification Number to: 44-H-073660; Required quantity: 2; Fitting Position: Front Axle	2	11.8171-0008.1 990049 Brake System: ATE
			Vehicle Identification Number from: 44-H-073661 →; → Construction year to: 07/89; Required quantity: 2; Fitting Position: Front Axle	2	11.8171-0008.1 990049 Brake System: ATE
2.0 TD	64	03/83→10/87	→ Construction year to: 07/84; Required quantity: 2; Fitting Position: Front Axle	2	11.8171-0008.1 990049 Brake System: ATE
2.1	96 - 100	08/82→07/84	Vehicle Identification Number from: 44-H-073661 →; Rim Hole Number: 4;	2	11.8171-0008.1 990049 Brake System: ATE
2.2	101	08/84→12/88	Required quantity: 2;		
2.2 Cat	101	06/89→11/90	Fitting Position: Front Axle		
2.3	98 - 100	08/86→11/90	→ Vehicle Identification Number to: 44-H-073660; Required quantity: 2; Fitting Position: Front Axle	2	11.8171-0008.1 990049 Brake System: ATE







	kW				
AUDI - 100 C3 Saloon (443, 444) 08/82→07/91					
Guide Bolt, brake caliper					
1.8	55 - 08/82→07/89	Vehicle Identification Number from: 44-H-073661 →; Required quantity: 2; Fitting Position: Front Axle	2	11.8171-0008.1 990049	Brake System: ATE
1.8 Cat	66 03/85→11/90				
2.0	83 - 08/84→12/87	→ Vehicle Identification Number to: 44-H-073660; Required quantity: 2; Fitting Position: Front Axle	2	11.8171-0008.1 990049	Brake System: ATE
2.0 Cat	85 01/88→11/90				
2.0 D Turbo	74 03/88→11/90				
2.2	85 10/84→09/86				
1.9	74 08/82→07/84	Required quantity: 2; Fitting Position: Front Axle	2	11.8171-0008.1 990049	Brake System: ATE
2.0 D	51 08/82→07/88	→ Construction year to: 07/84; Required quantity: 2; Fitting Position: Front Axle	2	11.8171-0008.1 990049	Brake System: ATE
		Construction year from: 08/84 →; → Vehicle Identification Number to: 44-H-073660; Required quantity: 2; Fitting Position: Front Axle	2	11.8171-0008.1 990049	Brake System: ATE
		Vehicle Identification Number from: 44-H-073661 →; Required quantity: 2; Fitting Position: Front Axle	2	11.8171-0008.1 990049	Brake System: ATE
2.0 D Turbo	64 08/82→02/88	→ Construction year to: 07/84; Required quantity: 2; Fitting Position: Front Axle	2	11.8171-0008.1 990049	Brake System: ATE
2.1	100 08/82→07/84	Vehicle Identification Number from: 44-H-073661 →; Rim Hole Number: 4; Required quantity: 2; Fitting Position: Front Axle	2	11.8171-0008.1 990049	Brake System: ATE
2.2	79 - 08/82→12/88				
	101				
2.2 Cat	101 06/89→11/90				
2.3 E	98 - 10/86→11/90	→ Vehicle Identification Number to: 44-H-073660; Required quantity: 2; Fitting Position: Front Axle	2	11.8171-0008.1 990049	Brake System: ATE
	100				
2.4 D	60 08/89→07/91	→ Construction year to: 12/90; Required quantity: 2; Fitting Position: Front Axle	2	11.8171-0008.1 990049	Brake System: ATE
AUDI - 100 C4 Avant (4A5) 12/90→11/94					
Guide Bolt, brake caliper					
2.0 E	74 - 09/91→07/94	Required quantity: 2; Fitting Position: Front Axle	2	11.8171-0008.1 990049	Brake System: ATE
	85				
2.0 E 16V	103 07/92→07/94				
2.0 E 16V quattro	103 07/92→07/94				
2.0 E quattro	85 12/90→07/92				
2.3 E	98 09/91→07/94				
2.3 E quattro	98 09/91→07/94				
2.6	102 07/93→07/94				
2.6 E quattro	102 08/93→07/94				
2.6 quattro	110 07/92→07/94				
2.8 E	128 09/91→07/94				
2.8 E quattro	128 09/91→07/94				
2.4 D	60 12/90→07/94	Construction year from: 05/91 →; Required quantity: 2; Fitting Position: Front Axle	2	11.8171-0008.1 990049	Brake System: ATE
2.5 TDI	85 12/90→07/94	Construction year from: 06/91 →; Required quantity: 2; Fitting Position: Front Axle	2	11.8171-0008.1 990049	Brake System: ATE
2.6	110 03/92→07/94	Construction year from: 04/92 →; Required quantity: 2; Fitting Position: Front Axle	2	11.8171-0008.1 990049	Brake System: ATE
AUDI - 100 C4 Saloon (4A2) 12/90→07/94					
Guide Bolt, brake caliper					
2.0	74 12/90→07/94	Required quantity: 2; Fitting Position: Front Axle	2	11.8171-0008.1 990049	Brake System: ATE
2.0 E	85 12/90→07/94				
2.0 E 16V	103 01/92→07/94				
2.0 E 16V quattro	103 07/92→07/94				
2.0 E quattro	85 12/90→07/92				
2.3 E	98 12/90→07/94				
2.3 E quattro	98 12/90→07/94				
2.6	102 07/93→07/94				
2.6 quattro	110 04/92→07/94				
2.8 E	128 12/90→07/94				
2.8 E quattro	128 12/90→07/94				
2.4 D	60 12/90→07/94	Construction year from: 05/91 →; Required quantity: 2; Fitting Position: Front Axle	2	11.8171-0008.1 990049	Brake System: ATE
2.5 TDI	85 12/90→07/94	Construction year from: 06/91 →; Required quantity: 2; Fitting Position: Front Axle	2	11.8171-0008.1 990049	Brake System: ATE
2.6	110 03/92→07/94	Construction year from: 04/92 →; Required quantity: 2; Fitting Position: Front Axle	2	11.8171-0008.1 990049	Brake System: ATE

	kW				
AUDI - A1 (8X1, 8XK) 05/10→10/18					
Guide Sleeve Kit, brake caliper					
1.0 TFSI	60 - 03/15→10/18		for PR number: 1ZS; Fitting Position: Front Axle	11.0101-5407.2 260011	Brake System: ATE
1.4 TDI	66 11/14→10/18		for PR number: 1ZM; Fitting Position: Front Axle	11.0101-5407.2 260011	Brake System: ATE
1.4 TFSI	92 11/14→10/18		for PR number: 1ZM; Fitting Position: Front Axle	11.0101-5407.2 260011	Brake System: ATE
1.6 TDI	85 11/14→10/18		for PR number: 1ZM; Fitting Position: Front Axle	11.0101-5407.2 260011	Brake System: ATE
1.8 TFSI	141 02/15→10/18		for PR number: 1ZM; Fitting Position: Front Axle	11.0101-5407.2 260011	Brake System: ATE
S1 quattro	170 03/14→10/18		for PR number: 1ZM; Fitting Position: Front Axle	11.0101-5407.2 260011	Brake System: ATE
1.2 TFSI	63 05/10→04/15		for PR number: 1LJ; Fitting Position: Front Axle	11.0101-5407.2 260011	Brake System: ATE
1.4 TFSI	90 - 05/10→04/15		for PR number: 1ZS; Fitting Position: Front Axle	11.0101-5407.2 260011	Brake System: ATE
	136		for PR number: 1ZS; Fitting Position: Front Axle	11.0101-5407.2 260011	Brake System: ATE
1.6 TDI	66 - 05/10→04/15		for PR number: 1ZM; Fitting Position: Front Axle	11.0101-5407.2 260011	Brake System: ATE
	77		for PR number: 1ZM; Fitting Position: Front Axle	11.0101-5407.2 260011	Brake System: ATE
2.0 TDI	100 - 09/11→04/15		for PR number: 1ZM; Fitting Position: Front Axle	11.0101-5407.2 260011	Brake System: ATE
	105		for PR number: 1ZM; Fitting Position: Front Axle	11.0101-5407.2 260011	Brake System: ATE
2.0 TFSI quattro	188 03/12→11/12		Construction year from: 10/12 →; for PR number: 1ZM; Fitting Position: Front Axle	11.0101-5407.2 260011	Brake System: ATE
			Construction year from: 10/12 →; for PR number: 1ZM; Fitting Position: Front Axle	11.0101-5407.2 260011	Brake System: ATE
			Construction year from: 10/12 →; for PR number: 1LJ; Fitting Position: Front Axle	11.0101-5407.2 260011	Brake System: ATE
			Construction year from: 10/12 →; for PR number: 1ZS; Fitting Position: Front Axle	11.0101-5407.2 260011	Brake System: ATE
Guide Bolt, brake caliper					
1.0 TFSI	60 01/16→10/18		for PR number: 1ZC; Required quantity: 2	2 11.8171-0008.1 990049	Brake System: ATE
S1 quattro	170 03/14→10/18		for PR number: 1ZS; Required quantity: 2	2 11.8171-0008.1 990049	Brake System: ATE
			for PR number: 1ZM; Required quantity: 2	2 11.8171-0008.1 990049	Brake System: ATE
			for PR number: 1ZN; Required quantity: 2	2 11.8171-0008.1 990049	Brake System: ATE
1.0 TFSI	70 03/15→10/18		for PR number: 1ZG; Required quantity: 2	2 11.8171-0008.1 990049	Brake System: ATE
1.4 TDI	66 11/14→10/18		for PR number: 1ZC; Required quantity: 2	2 11.8171-0008.1 990049	Brake System: ATE
1.4 TFSI	92 11/14→10/18		for PR number: 1ZC; Required quantity: 2	2 11.8171-0008.1 990049	Brake System: ATE
1.6 TDI	85 11/14→10/18		for PR number: 1ZS; Required quantity: 2	2 11.8171-0008.1 990049	Brake System: ATE
1.8 TFSI	141 02/15→10/18		for PR number: 1ZM; Required quantity: 2	2 11.8171-0008.1 990049	Brake System: ATE
			for PR number: 1ZN; Required quantity: 2	2 11.8171-0008.1 990049	Brake System: ATE
1.2 TFSI	63 05/10→04/15		for PR number: 1ZG; Required quantity: 2	2 11.8171-0008.1 990049	Brake System: ATE
1.4 TFSI	90 - 05/10→04/15		for PR number: 1ZC; Required quantity: 2	2 11.8171-0008.1 990049	Brake System: ATE
	136		for PR number: 1ZC; Required quantity: 2	2 11.8171-0008.1 990049	Brake System: ATE
1.6 TDI	66 - 05/10→04/15		for PR number: 1LJ; Required quantity: 2	2 11.8171-0008.1 990049	Brake System: ATE
	77		for PR number: 1ZS; Required quantity: 2	2 11.8171-0008.1 990049	Brake System: ATE
2.0 TDI	100 - 09/11→04/15		for PR number: 1ZM; Required quantity: 2	2 11.8171-0008.1 990049	Brake System: ATE
	105		for PR number: 1ZN; Required quantity: 2	2 11.8171-0008.1 990049	Brake System: ATE
			for PR number: 1ZM; Required quantity: 2	2 11.8171-0008.1 990049	Brake System: ATE
1.4 TSI	110 11/14→10/18		for PR number: 1ZG; Required quantity: 2	2 11.8171-0008.1 990049	Brake System: ATE
			for PR number: 1ZC; Required quantity: 2	2 11.8171-0008.1 990049	Brake System: ATE
2.0 TFSI quattro	188 03/12→11/12		Construction year from: 10/12 →; for PR number: 1ZG; Required quantity: 2	2 11.8171-0008.1 990049	Brake System: ATE
			Construction year from: 10/12 →; for PR number: 1ZC; Required quantity: 2	2 11.8171-0008.1 990049	Brake System: ATE
			Construction year from: 10/12 →; for PR number: 1LJ; Required quantity: 2	2 11.8171-0008.1 990049	Brake System: ATE
			Construction year from: 10/12 →; for PR number: 1ZS; Required quantity: 2	2 11.8171-0008.1 990049	Brake System: ATE
			Construction year from: 10/12 →; for PR number: 1ZM; Required quantity: 2	2 11.8171-0008.1 990049	Brake System: ATE

→

	kW				
AUDI - A1 (8X1, 8XK) 05/10→10/18					
 Brake Hose					
S1 quattro	170 03/14→10/18	Required quantity: 2; for PR number: 0N0; Fitting Position: Rear Axle	2	24.5176-0233.3 331632	Length [mm]: 245
2.0 TFSI quattro	188 03/12→11/12	Construction year from: 10/12 →; Required quantity: 2; for PR number: 0N0; Fitting Position: Rear Axle	2	24.5176-0233.3 331632	Length [mm]: 245
 Wheel Speed Sensor					
1.0 TFSI	60 - 03/15→10/18	Fitting Position: Front Axle Left		24.0711-5273.3 360303	
1.2 TFSI	70	Fitting Position: Front Axle Right		24.0711-5274.3 360304	
1.4 TDI	63 05/10→04/15				
1.4 TFSI	66 11/14→10/18				
1.4 TFSI	90 - 05/10→10/18				
1.4 TSI	136				
1.4 TSI	110 11/14→10/18				
1.6 TDI	66 - 05/10→10/18				
1.6 TDI	85				
1.8 TFSI	141 02/15→10/18				
2.0 TDI	100 - 09/11→04/15				
2.0 TDI	105				
S1 quattro	170 03/14→10/18				
2.0 TFSI quattro	188 03/12→11/12	Construction year from: 10/12 →; Fitting Position: Front Axle Left		24.0711-5273.3 360303	
		Construction year from: 10/12 →; Fitting Position: Front Axle Right		24.0711-5274.3 360304	
AUDI - A1 City Carver (GBH) 07/19→					
 Brake Pad Set, disc brake					
25 TFSI	70 07/19→	for PR number: 1ZA / 1ZK; Fitting Position: Front Axle		13.0460-2609.2 602609	Brake System: Lucas / TRW 25683 20,4 Wear Warning Contact: prepared for wear indicator / excl. wear warning contact
30 TFSI	81 - 07/19→				
35 TFSI	85				
35 TFSI	110 07/19→			13.0470-2609.2 LD2609	Brake System: Lucas / TRW Wear Warning Contact: prepared for wear indicator / excl. wear warning contact Ceramic
 Brake Disc					
25 TFSI	70 07/19→	for PR number: 1ZA; Fitting Position: Front Axle		24.0125-0222.1 425222	Outer diameter [mm]: 312 Brake Disc Thickness [mm] 25 Minimum thickness [mm] 22.4 Brake Disc Type: Vented Supplementary Article/Info 2: with bolts/screws
30 TFSI	81 - 07/19→				
35 TFSI	85				
35 TFSI	110 07/19→				
 Wheel Speed Sensor					
25 TFSI	70 07/19→	→ Construction year to: 11/19; Fitting Position: Front Axle Left		24.0711-5273.3 360303	
30 TFSI	85 07/19→				
35 TFSI	110 07/19→	→ Construction year to: 11/19; Fitting Position: Front Axle Right		24.0711-5274.3 360304	
AUDI - A1 Sportback (8XA, 8XF) 09/11→10/18					
Guide Sleeve Kit, brake caliper					
1.0 TFSI	60 - 03/15→10/18	for PR number: 1ZN; Fitting Position: Front Axle		11.0101-5407.2 260011	Brake System: ATE
1.4 TDI	70				
1.4 TDI	66 11/14→10/18	for PR number: 1ZS; Fitting Position: Front Axle		11.0101-5407.2 260011	Brake System: ATE
1.4 TFSI	92 11/14→10/18				
1.4 TSI	110 11/14→10/18				
1.6 TDI	85 11/14→10/18	for PR number: 1ZM; Fitting Position: Front Axle		11.0101-5407.2 260011	Brake System: ATE
1.8 TFSI	141 02/15→10/18				
S1 quattro	170 03/14→10/18				
1.2 TFSI	63 01/12→04/15	for PR number: 1ZN; Fitting Position: Front Axle		11.0101-5407.2 260011	Brake System: ATE
1.4 TFSI	90 - 11/11→04/15				
1.4 TFSI	136				
1.6 TDI	66 - 11/11→04/15	for PR number: 1LJ; Fitting Position: Front Axle		11.0101-5407.2 260011	Brake System: ATE
1.6 TDI	77				
2.0 TDI	100 - 09/11→04/15	for PR number: 1ZS; Fitting Position: Front Axle		11.0101-5407.2 260011	Brake System: ATE
2.0 TDI	105				
		for PR number: 1ZM; Fitting Position: Front Axle		11.0101-5407.2 260011	Brake System: ATE
Guide Bolt, brake caliper					
1.0 TFSI	60 01/16→10/18	for PR number: 1ZC; Required quantity: 2	2	11.8171-0008.1 990049	Brake System: ATE
S1 quattro	170 03/14→10/18				



	kW					
AUDI - A1 Sportback (8XA, 8XF) 09/11→10/18						
Guide Bolt, brake caliper						
1.0 TFSI S1 quattro	60 01/16→10/18	for PR number: 1ZS; Required quantity: 2	2	11.8171-0008.1 990049	Brake System: ATE	
	170 03/14→10/18	for PR number: 1ZM; Required quantity: 2	2	11.8171-0008.1 990049	Brake System: ATE	
		for PR number: 1ZN; Required quantity: 2	2	11.8171-0008.1 990049	Brake System: ATE	
1.0 TFSI 1.4 TDI 1.4 TFSI 1.4 TSI 1.6 TDI 1.8 TFSI	70 03/15→10/18	for PR number: 1ZG; Required quantity: 2	2	11.8171-0008.1 990049	Brake System: ATE	
	66 11/14→10/18					
	92 11/14→10/18	for PR number: 1ZC; Required quantity: 2	2	11.8171-0008.1 990049	Brake System: ATE	
	110 11/14→10/18					
	85 11/14→10/18	for PR number: 1ZS; Required quantity: 2	2	11.8171-0008.1 990049	Brake System: ATE	
	141 02/15→10/18	for PR number: 1ZM; Required quantity: 2	2	11.8171-0008.1 990049	Brake System: ATE	
		for PR number: 1ZN; Required quantity: 2	2	11.8171-0008.1 990049	Brake System: ATE	
1.2 TFSI 1.4 TFSI 1.6 TDI 2.0 TDI	63 01/12→04/15	for PR number: 1ZG; Required quantity: 2	2	11.8171-0008.1 990049	Brake System: ATE	
	90 - 11/11→04/15					
	136	for PR number: 1ZC; Required quantity: 2	2	11.8171-0008.1 990049	Brake System: ATE	
	66 - 11/11→04/15					
	77	for PR number: 1LJ; Required quantity: 2	2	11.8171-0008.1 990049	Brake System: ATE	
	100 - 09/11→04/15	for PR number: 1ZS; Required quantity: 2	2	11.8171-0008.1 990049	Brake System: ATE	
	105	for PR number: 1ZM; Required quantity: 2	2	11.8171-0008.1 990049	Brake System: ATE	
		for PR number: 1ZN; Required quantity: 2	2	11.8171-0008.1 990049	Brake System: ATE	
 Brake Disc						
1.2 TFSI 1.4 TFSI 1.6 TDI 2.0 TDI	63 01/12→04/15	for PR number: 1LJ; Fitting Position: Front Axle		24.0125-0158.1 425158	Outer diameter [mm]: 312 Brake Disc Thickness [mm] 25 Minimum thickness [mm] 22 Brake Disc Type: Vented Supplementary Article/Info 2: with bolts/screws	
	90 - 11/11→04/15					
	136					
	66 - 11/11→04/15	for PR number: 1KS; Fitting Position: Rear Axle		24.0325-0158.1 525158	Outer diameter [mm]: 312 Brake Disc Thickness [mm] 25 Minimum thickness [mm] 22 Brake Disc Type: Vented Supplementary Article/Info 2: with bolts/screws	
	77					
	100 - 09/11→04/15					
105			24.0110-0356.1 410356	Outer diameter [mm]: 272 Brake Disc Thickness [mm] 9.7 Minimum thickness [mm] 8 Brake Disc Type: Solid Supplementary Article/Info 2: with bolts/screws		
			24.0310-0356.1 510356	Outer diameter [mm]: 272 Brake Disc Thickness [mm] 9.7 Minimum thickness [mm] 8 Brake Disc Type: Solid Supplementary Article/Info 2: with bolts/screws		
1.4 TDI 1.4 TFSI 1.4 TSI 1.6 TDI	66 11/14→10/18	for PR number: 1KS; Fitting Position: Rear Axle		24.0110-0356.1 410356	Outer diameter [mm]: 272 Brake Disc Thickness [mm] 9.7 Minimum thickness [mm] 8 Brake Disc Type: Solid Supplementary Article/Info 2: with bolts/screws	
	92 11/14→10/18					
	110 11/14→10/18					
	85 11/14→10/18					
				24.0310-0356.1 510356	Outer diameter [mm]: 272 Brake Disc Thickness [mm] 9.7 Minimum thickness [mm] 8 Brake Disc Type: Solid Supplementary Article/Info 2: with bolts/screws	
 Brake Hose						
1.0 TFSI 1.2 TFSI 1.4 TDI 1.4 TFSI 1.4 TSI 1.6 TDI 1.8 TFSI →	60 - 03/15→10/18	Required quantity: 2; for PR number: 0N0; Fitting Position: Rear Axle		2	24.5176-0233.3 331632	Length [mm]: 245
	70					
	63 01/12→04/15					
	66 11/14→10/18					
	90 - 11/11→10/18					
	136					
	110 11/14→10/18					
66 - 11/11→10/18						
85						
141 02/15→10/18						

	kW				
AUDI - A1 Sportback (8XA, 8XF) 09/11→10/18					
 Brake Hose					
2.0 TDI	100 - 09/11→04/15	Required quantity: 2; for PR number: 0N0; Fitting Position: Rear Axle	2	24.5176-0233.3 331632	Length [mm]: 245
S1 quattro	105 170 03/14→10/18				
 Wheel Speed Sensor					
1.0 TFSI	60 - 03/15→10/18	Fitting Position: Front Axle Left		24.0711-5273.3 360303	
	70				
1.2 TFSI	63 01/12→04/15	Fitting Position: Front Axle Right		24.0711-5274.3 360304	
1.4 TDI	66 11/14→10/18				
1.4 TFSI	90 - 11/11→10/18				
	136				
1.4 TSI	110 11/14→10/18				
1.6 TDI	66 - 11/11→10/18				
	85				
1.8 TFSI	141 02/15→10/18				
2.0 TDI	100 - 09/11→04/15				
	105				
S1 quattro	170 03/14→10/18				
AUDI - A1 Sportback (GBA) 07/18→					
 Brake Pad Set, disc brake					
25 TFSI	70 11/18→	for PR number: 1ZA / 1ZK; Fitting Position: Front Axle		13.0460-2609.2 602609	Brake System: Lucas / TRW 25683 20,4 Wear Warning Contact: prepared for wear indicator / excl. wear warning contact
30 TFSI	81 - 07/18→				
	85				
35 TFSI	110 09/18→				
40 TFSI	147 - 09/18→			13.0470-2609.2 LD2609	Brake System: Lucas / TRW Wear Warning Contact: prepared for wear indicator / excl. wear warning contact Ceramic
	152				
 Brake Disc					
25 TFSI	70 11/18→	for PR number: 1ZA; Fitting Position: Front Axle		24.0125-0222.1 425222	Outer diameter [mm]: 312 Brake Disc Thickness [mm] 25 Minimum thickness [mm] 22.4 Brake Disc Type: Vented Supplementary Article/Info 2: with bolts/screws
30 TFSI	81 - 07/18→				
	85				
35 TFSI	110 09/18→				
40 TFSI	147 - 09/18→				
	152				
 Wheel Speed Sensor					
25 TFSI	70 11/18→	→ Construction year to: 11/19; Fitting Position: Front Axle Left		24.0711-5273.3 360303	
30 TFSI	85 07/18→				
35 TFSI	110 09/18→	→ Construction year to: 11/19; Fitting Position: Front Axle Right		24.0711-5274.3 360304	
40 TFSI	147 09/18→				
AUDI - A2 (8Z0) 02/00→08/05					
Guide Bolt, brake caliper					
1.2 TDI	45 03/01→08/05	→ Construction year to: 07/05; Required quantity: 2	2	11.8171-0008.1 990049	Brake System: ATE
 Wheel Speed Sensor					
1.4	55 02/00→08/05	Construction year from: 06/00 → → Construction year to: 07/05; Fitting Position: Front Axle Left		24.0711-5273.3 360303	
1.4 TDI	55 02/00→08/05				
		Construction year from: 06/00 → → Construction year to: 07/05; Fitting Position: Front Axle Right		24.0711-5274.3 360304	
1.4 TDI	66 11/03→08/05	→ Construction year to: 07/05; Fitting Position: Front Axle Left		24.0711-5273.3 360303	
1.6 FSI	81 05/02→08/05				
		→ Construction year to: 07/05; Fitting Position: Front Axle Right		24.0711-5274.3 360304	
AUDI - A3 (8L1) 09/96→09/06					
Guide Bolt, brake caliper					
1.6	74 - 09/96→05/03	→ Vehicle Identification Number to: 8L- W-094814; for PR number: 1LQ / 1LR / 1LS; Required quantity: 2	2	11.8171-0008.1 990049	Brake System: ATE
1.8	75				
1.8 T	92 09/96→05/03 110 12/96→05/03	Vehicle Identification Number from: 8L- W-094815 →; for PR number: 1LQ / 1LR / 1LS / 1ZP; Required quantity: 2	2	11.8171-0008.1 990049	Brake System: ATE
		for PR number: 1LE / 1LN / 1ZD; Required quantity: 2	2	11.8171-0008.1 990049	Brake System: ATE
→					

	kW				
AUDI - A3 (8L1) 09/96→09/06					
Guide Bolt, brake caliper					
1.8 T	132	12/98→05/03	for PR number: 1LE / 1LN / 1ZD; Required quantity: 2	2	11.8171-0008.1 990049 Brake System: ATE
1.8 T quattro	132	10/98→05/03			
1.9 TDI	74	10/00→05/03	for PR number: 1LQ / 1LR / 1LS / 1ZP; Required quantity: 2	2	11.8171-0008.1 990049 Brake System: ATE
1.8 T quattro	110	12/96→05/03	Construction year from: 08/98 →; for PR number: 1LQ / 1LR / 1LS / 1ZP; Required quantity: 2	2	11.8171-0008.1 990049 Brake System: ATE
			Construction year from: 08/98 →; for PR number: 1LE / 1LN / 1ZD; Required quantity: 2	2	11.8171-0008.1 990049 Brake System: ATE
1.9 TDI	66	09/96→07/01	→ Vehicle Identification Number to: 8L-W-094814; for PR number: 1LQ / 1LR / 1LS; Required quantity: 2	2	11.8171-0008.1 990049 Brake System: ATE
	81		→ Construction year to: 06/01; for PR number: 1LE / 1LN / 1ZD; Required quantity: 2	2	11.8171-0008.1 990049 Brake System: ATE
			Vehicle Identification Number from: 8L-W-094815 →; → Construction year to: 06/01; for PR number: 1LQ / 1LR / 1LS / 1ZP; Required quantity: 2	2	11.8171-0008.1 990049 Brake System: ATE
1.9 TDI	96	08/00→05/03	Construction year from: 09/00 →; for PR number: 1LQ / 1LR / 1LS / 1ZP; Required quantity: 2	2	11.8171-0008.1 990049 Brake System: ATE
1.9 TDI quattro	96	08/00→05/03			
			Construction year from: 09/00 →; for PR number: 1LE / 1LN / 1ZD; Required quantity: 2	2	11.8171-0008.1 990049 Brake System: ATE
S3 quattro	154	03/99→05/03	for PR number: 1LE / 1LN / 1ZD; Required quantity: 2	2	11.8171-0008.1 990049 Brake System: ATE
	165		for PR number: 1LQ / 1LR / 1LS / 1ZP; Required quantity: 2	2	11.8171-0008.1 990049 Brake System: ATE
			for PR number: 1LT; Required quantity: 2	2	11.8171-0008.1 990049 Brake System: ATE
AUDI - A3 (8P1) 05/03→12/13					
Guide Bolt, brake caliper					
1.2 TSI	77	04/10→08/12	for PR number: 1ZE / 1ZP; Required quantity: 2	2	11.8171-0008.1 990049 Brake System: ATE
1.4 TFSI	92	09/07→08/12			
1.6	75	05/03→08/12	for PR number: 1ZD / 1LJ / 1ZA; Required quantity: 2	2	11.8171-0008.1 990049 Brake System: ATE
1.6 E-Power	75	01/11→08/12			
1.6 FSI	85	08/03→09/07			
1.6 TDI	66	05/09→08/12	for PR number: 1LK; Required quantity: 2	2	11.8171-0008.1 990049 Brake System: ATE
	77				
1.8 TFSI quattro	118	07/08→08/12			
2.0 FSI	110	05/03→06/08			
2.0 TDI	100	05/03→08/12			
	125				
2.0 TDI 16V	103	05/03→08/12			
2.0 TDI 16V quattro	103	08/04→08/12			
2.0 TDI quattro	100	05/03→08/12			
	125				
2.0 TFSI	147	09/04→08/12			
2.0 TFSI quattro	147	09/04→08/12			
3.2 V6 quattro	184	07/03→05/09			
1.8 T	110	08/06→08/12	Construction year from: 01/07 →; for PR number: 1ZE / 1ZP; Required quantity: 2	2	11.8171-0008.1 990049 Brake System: ATE
1.8 TFSI	118	11/06→08/12			
			Construction year from: 01/07 →; for PR number: 1ZD / 1LJ / 1ZA; Required quantity: 2	2	11.8171-0008.1 990049 Brake System: ATE
			Construction year from: 01/07 →; for PR number: 1LK; Required quantity: 2	2	11.8171-0008.1 990049 Brake System: ATE
1.9 TDI	77	05/03→05/10	Construction year from: 06/03 →; for PR number: 1ZE / 1ZP; Required quantity: 2	2	11.8171-0008.1 990049 Brake System: ATE
			Construction year from: 06/03 →; for PR number: 1ZD / 1LJ / 1ZA; Required quantity: 2	2	11.8171-0008.1 990049 Brake System: ATE
			Construction year from: 06/03 →; for PR number: 1LK; Required quantity: 2	2	11.8171-0008.1 990049 Brake System: ATE
S3 quattro	188	02/07→08/12	Construction year from: 07/08 →; for PR number: 1ZK; Required quantity: 2	2	11.8171-0008.1 990049 Brake System: ATE
S3 quattro	195	11/06→08/12	for PR number: 1ZK; Required quantity: 2	2	11.8171-0008.1 990049 Brake System: ATE
→					



	kW				
AUDI - A3 (8P1) 05/03→12/13					
 Brake Disc					
1.2 TSI 1.4 TFSI 1.6 1.6 E-Power 1.6 FSI 1.6 TDI	77 04/10→08/12 92 09/07→08/12 75 05/03→08/12 75 01/11→08/12 85 08/03→09/07 66 - 05/09→08/12 77	for PR number: 1ZE / 1ZP; Fitting Position: Front Axle		24.0125-0145.1 425145	Outer diameter [mm]: 288 Brake Disc Thickness [mm] 25 Minimum thickness [mm] 22 Brake Disc Type: Vented Supplementary Article/Info 2: with bolts/screws
1.8 TFSI quattro 2.0 FSI 2.0 TDI 2.0 TDI 16V 2.0 TDI 16V quattro 2.0 TDI quattro 2.0 TFSI 2.0 TFSI quattro 3.2 V6 quattro	118 07/08→08/12 110 05/03→06/08 100 - 05/03→08/12 125 103 05/03→08/12 103 08/04→08/12 100 - 05/03→08/12 125 147 09/04→08/12 147 09/04→08/12 184 07/03→05/09	for PR number: 1ZD / 1LJ / 1ZA; Fitting Position: Front Axle		24.0125-0158.1 425158 24.0325-0158.1 525158	Outer diameter [mm]: 312 Brake Disc Thickness [mm] 25 Minimum thickness [mm] 22 Brake Disc Type: Vented Supplementary Article/Info 2: with bolts/screws Outer diameter [mm]: 312 Brake Disc Thickness [mm] 25 Minimum thickness [mm] 22 Brake Disc Type: Vented Supplementary Article/Info 2: with bolts/screws
		for PR number: 1KS; Fitting Position: Rear Axle		24.0110-0356.1 410356 24.0310-0356.1 510356	Outer diameter [mm]: 272 Brake Disc Thickness [mm] 9.7 Minimum thickness [mm] 8 Brake Disc Type: Solid Supplementary Article/Info 2: with bolts/screws Outer diameter [mm]: 272 Brake Disc Thickness [mm] 9.7 Minimum thickness [mm] 8 Brake Disc Type: Solid Supplementary Article/Info 2: with bolts/screws
1.8 T	110 08/06→08/12	Construction year from: 01/07 →; for PR number: 1ZE / 1ZP; Fitting Position: Front Axle		24.0125-0145.1 425145	Outer diameter [mm]: 288 Brake Disc Thickness [mm] 25 Minimum thickness [mm] 22 Brake Disc Type: Vented Supplementary Article/Info 2: with bolts/screws
		Construction year from: 01/07 →; for PR number: 1ZD / 1LJ / 1ZA; Fitting Position: Front Axle		24.0125-0158.1 425158	Outer diameter [mm]: 312 Brake Disc Thickness [mm] 25 Minimum thickness [mm] 22 Brake Disc Type: Vented Supplementary Article/Info 2: with bolts/screws
		Construction year from: 01/07 →; for PR number: 1KS; Fitting Position: Rear Axle		24.0110-0356.1 410356 24.0310-0356.1 510356	Outer diameter [mm]: 272 Brake Disc Thickness [mm] 9.7 Minimum thickness [mm] 8 Brake Disc Type: Solid Supplementary Article/Info 2: with bolts/screws Outer diameter [mm]: 272 Brake Disc Thickness [mm] 9.7 Minimum thickness [mm] 8 Brake Disc Type: Solid Supplementary Article/Info 2: with bolts/screws
1.8 TFSI	118 11/06→08/12	Construction year from: 01/07 →; for PR number: 1ZE / 1ZP; Fitting Position: Front Axle		24.0125-0145.1 425145	Outer diameter [mm]: 288 Brake Disc Thickness [mm] 25 Minimum thickness [mm] 22 Brake Disc Type: Vented Supplementary Article/Info 2: with bolts/screws
		Construction year from: 01/07 →; for PR number: 1ZD / 1LJ / 1ZA; Fitting Position: Front Axle		24.0125-0158.1 425158 24.0325-0158.1 525158	Outer diameter [mm]: 312 Brake Disc Thickness [mm] 25 Minimum thickness [mm] 22 Brake Disc Type: Vented Supplementary Article/Info 2: with bolts/screws Outer diameter [mm]: 312 Brake Disc Thickness [mm] 25 Minimum thickness [mm] 22 Brake Disc Type: Vented Supplementary Article/Info 2: with bolts/screws
		Construction year from: 01/07 →; for PR number: 1KS; Fitting Position: Rear Axle		24.0110-0356.1 410356	Outer diameter [mm]: 272 Brake Disc Thickness [mm] 9.7 Minimum thickness [mm] 8 Brake Disc Type: Solid Supplementary Article/Info 2: with bolts/screws



→

		kW					
AUDI - A3 (8P1) 05/03→12/13							
 Brake Disc							
1.8 TFSI	118	11/06→08/12	Construction year from: 01/07 →; for PR number: 1KS; Fitting Position: Rear Axle		24.0310-0356.1 510356	Outer diameter [mm]: 272 Brake Disc Thickness [mm] 9.7 Minimum thickness [mm] 8 Brake Disc Type: Solid Supplementary Article/Info 2: with bolts/screws	
1.9 TDI	77	05/03→05/10	Construction year from: 06/03 →; for PR number: 1ZE / 1ZP; Fitting Position: Front Axle		24.0125-0145.1 425145	Outer diameter [mm]: 288 Brake Disc Thickness [mm] 25 Minimum thickness [mm] 22 Brake Disc Type: Vented Supplementary Article/Info 2: with bolts/screws	
			Construction year from: 06/03 →; for PR number: 1ZD / 1LJ / 1ZA; Fitting Position: Front Axle		24.0125-0158.1 425158	Outer diameter [mm]: 312 Brake Disc Thickness [mm] 25 Minimum thickness [mm] 22 Brake Disc Type: Vented Supplementary Article/Info 2: with bolts/screws	
			Construction year from: 06/03 →; for PR number: 1KS; Fitting Position: Rear Axle		24.0110-0356.1 410356	Outer diameter [mm]: 272 Brake Disc Thickness [mm] 9.7 Minimum thickness [mm] 8 Brake Disc Type: Solid Supplementary Article/Info 2: with bolts/screws	
					24.0310-0356.1 510356	Outer diameter [mm]: 272 Brake Disc Thickness [mm] 9.7 Minimum thickness [mm] 8 Brake Disc Type: Solid Supplementary Article/Info 2: with bolts/screws	
AUDI - A3 (8V1, 8VK) 04/12→10/20							
 Brake Caliper							
1.0 TFSI	85	07/16→12/17	for PR number: 1ZA / 1ZD; Fitting Position: Front Axle Left		24.3571-1801.5 241387	Supplementary Article/Supplementary Info: without holder Brake Caliper Type: Fist-type Caliper	
1.2 TFSI	77	02/13→08/16					
	81						
1.4 TFSI	90	04/12→08/16					
	103						
1.4 TSI	110	05/14→12/17	for PR number: 1ZA / 1ZD; Fitting Position: Front Axle Right		24.3571-1802.5 241388	Supplementary Article/Supplementary Info: without holder Brake Caliper Type: Fist-type Caliper	
1.5 TFSI	110	05/17→12/17					
1.6 TDI	77	10/12→10/20					
	85						
1.8 TFSI	132	04/12→08/16					
1.8 TFSI quattro	132	08/12→08/16					
2.0 TDI	81	04/12→10/20					
	135						
2.0 TDI quattro	110	10/12→12/17					
	135						
2.0 TFSI	140	05/16→12/17					
2.0 TFSI quattro	140	05/16→12/17					
S3 quattro	206	11/12→12/17					
	228						
Guide Sleeve Kit, brake caliper							
1.0 TFSI	85	07/16→12/17	for PR number: 1KE / 1KJ / 1KR / 1KY; Fitting Position: Rear Axle		11.0101-5407.2 260011	Brake System: ATE	
1.2 TFSI	77	02/13→08/16					
	81						
1.4 TFSI	90	04/12→08/16					
	103						
1.4 TSI	110	05/14→12/17					
1.5 TFSI	110	05/17→12/17					
1.6 TDI	77	10/12→10/20					
	85						
1.8 TFSI	132	04/12→08/16					
1.8 TFSI quattro	132	08/12→08/16					
2.0 TDI	81	04/12→10/20					
	135						
2.0 TDI quattro	110	10/12→12/17					
	135						
2.0 TFSI	140	05/16→12/17					
2.0 TFSI quattro	140	05/16→12/17					
S3 quattro	206	11/12→12/17					
	228						
→							



		kW					
AUDI - A3 (8V1, 8VK) 04/12→10/20							
Guide Bolt, brake caliper							
1.0 TFSI	85	07/16→12/17	for PR number: 1KE / 1KJ / 1KR / 1KY; Required quantity: 2; Fitting Position: Rear Axle	2	11.8171-0008.1	990049	Brake System: ATE
1.2 TFSI	77 - 81	02/13→08/16					
1.4 TFSI	90 - 103	04/12→08/16					
1.4 TSI	110	05/14→12/17					
1.5 TFSI	110	05/17→12/17					
1.6 TDI	77 - 85	10/12→10/20					
1.8 TFSI	132	04/12→08/16					
1.8 TFSI quattro	132	08/12→08/16					
2.0 TDI	81 - 135	04/12→10/20					
2.0 TDI quattro	110 - 135	10/12→12/17					
2.0 TFSI	140	05/16→12/17					
2.0 TFSI quattro	140	05/16→12/17					
S3 quattro	206 - 228	11/12→12/17					
 Brake Disc							
1.0 TFSI	85	07/16→12/17	for PR number: 1ZE / 1ZP; Fitting Position: Front Axle	24.0125-0145.1	425145	Outer diameter [mm]: 288 Brake Disc Thickness [mm] 25 Minimum thickness [mm] 22 Brake Disc Type: Vented Supplementary Article/Info 2: with bolts/screws	
1.2 TFSI	77 - 81	02/13→08/16					
1.4 TFSI	90 - 103	04/12→08/16					
1.4 TSI	110	05/14→12/17					
1.5 TFSI	110	05/17→12/17					
1.6 TDI	77 - 85	10/12→10/20					
1.8 TFSI	132	04/12→08/16					
1.8 TFSI quattro	132	08/12→08/16					
2.0 TDI	100 - 135	04/12→10/20					
2.0 TDI quattro	110 - 135	10/12→12/17					
2.0 TFSI	140	05/16→12/17	for PR number: 1ZA / 1ZD; Fitting Position: Front Axle	24.0125-0158.1	425158	Outer diameter [mm]: 312 Brake Disc Thickness [mm] 25 Minimum thickness [mm] 22 Brake Disc Type: Vented Supplementary Article/Info 2: with bolts/screws	
2.0 TFSI quattro	140	05/16→12/17					
S3 quattro	206 - 228	11/12→12/17					
			for PR number: 1KE / 1KR; Fitting Position: Rear Axle	24.0110-0356.1	410356	Outer diameter [mm]: 272 Brake Disc Thickness [mm] 9.7 Minimum thickness [mm] 8 Brake Disc Type: Solid Supplementary Article/Info 2: with bolts/screws	
			for PR number: 2ED; Vehicle Equipment: for vehicles with electric parking brake; Fitting Position: Rear Axle	24.0112-0210.1	412210	Outer diameter [mm]: 300 Brake Disc Thickness [mm] 12 Minimum thickness [mm] 10 Brake Disc Type: Solid Supplementary Article/Info 2: with bolts/screws	
2.0 TDI	81	01/13→08/16	for PR number: 1ZE / 1ZP; Fitting Position: Front Axle	24.0125-0145.1	425145	Outer diameter [mm]: 288 Brake Disc Thickness [mm] 25 Minimum thickness [mm] 22 Brake Disc Type: Vented Supplementary Article/Info 2: with bolts/screws	
			for PR number: 1ZA / 1ZD; Fitting Position: Front Axle	24.0125-0158.1	425158	Outer diameter [mm]: 312 Brake Disc Thickness [mm] 25 Minimum thickness [mm] 22 Brake Disc Type: Vented Supplementary Article/Info 2: with bolts/screws	
			for PR number: 1KE / 1KR; Fitting Position: Rear Axle	24.0110-0356.1	410356	Outer diameter [mm]: 272 Brake Disc Thickness [mm] 9.7 Minimum thickness [mm] 8 Brake Disc Type: Solid Supplementary Article/Info 2: with bolts/screws	



→

	kW				
AUDI - A3 (8V1, 8VK) 04/12→10/20					
 Brake Disc					
2.0 TDI	81 01/13→08/16	for PR number: 1KE / 1KR; Fitting Position: Rear Axle		24.0310-0356.1 510356	Outer diameter [mm]: 272 Brake Disc Thickness [mm] 9.7 Minimum thickness [mm] 8 Brake Disc Type: Solid Supplementary Article/Info 2: with bolts/screws
		for PR number: 2ED; Vehicle Equipment: for vehicles with electric parking brake; Fitting Position: Rear Axle		24.0112-0210.1 412210	Outer diameter [mm]: 300 Brake Disc Thickness [mm] 12 Minimum thickness [mm] 10 Brake Disc Type: Solid Supplementary Article/Info 2: with bolts/screws
 Wheel Speed Sensor					
1.0 TFSI	85 07/16→12/17	Fitting Position: Front Axle Left		24.0711-5273.3 360303	
1.2 TFSI	77 - 02/13→08/16 81	Fitting Position: Front Axle Right		24.0711-5274.3 360304	
1.4 TFSI	92 - 03/13→08/16 103	Required quantity: 2; Comfort Equipment Variant (trim package): for cruise control system; Fitting Position: Rear Axle		2 24.0711-6337.3 360390	
1.4 TSI	110 05/14→12/17				
1.5 TFSI	110 05/17→12/17				
1.6 TDI	77 - 10/12→10/20 85	Required quantity: 2; Vehicle Equipment: for vehicles with parking assistant system; Fitting Position: Rear Axle		2 24.0711-6337.3 360390	
2.0 TDI	81 - 09/12→10/20 135				
2.0 TFSI	140 05/16→12/17				
1.4 TFSI	90 04/12→05/14	Construction year from: 08/12 →; Fitting Position: Front Axle Left		24.0711-5273.3 360303	
1.8 TFSI	132 04/12→08/16				
2.0 TDI	110 04/12→12/17	Construction year from: 08/12 →; Fitting Position: Front Axle Right		24.0711-5274.3 360304	
		Construction year from: 08/12 →; Required quantity: 2; Comfort Equipment Variant (trim package): for cruise control system; Fitting Position: Rear Axle		2 24.0711-6337.3 360390	
		Construction year from: 08/12 →; Required quantity: 2; Vehicle Equipment: for vehicles with parking assistant system; Fitting Position: Rear Axle		2 24.0711-6337.3 360390	
1.8 TFSI quattro	132 08/12→08/16	Fitting Position: Front Axle Left		24.0711-5273.3 360303	
2.0 TDI quattro	110 - 10/12→12/17 135	Fitting Position: Front Axle Right		24.0711-5274.3 360304	
2.0 TFSI quattro	140 05/16→12/17	Vehicle Equipment: for vehicles with parking assistant system; Fitting Position: Rear Axle Left		24.0711-5401.3 360330	
S3 quattro	206 - 11/12→12/17 228				
		Comfort Equipment Variant (trim package): for cruise control system; Fitting Position: Rear Axle Left		24.0711-5401.3 360330	
		Comfort Equipment Variant (trim package): for cruise control system; Fitting Position: Rear Axle Right		24.0711-5402.3 360331	
		Vehicle Equipment: for vehicles with parking assistant system; Fitting Position: Rear Axle Right		24.0711-5402.3 360331	
Control Element, parking brake caliper					
1.0 TFSI	85 07/16→12/17	for PR number: 1KE / 1KR / 1KZ; Fitting Position: Rear Axle Left		11.9282-1001.3 250159	Brake System: ATE
1.2 TFSI	77 - 02/13→08/16 81				
1.4 TFSI	90 - 04/12→08/16 103	for PR number: 1KE / 1KR / 1KZ; Fitting Position: Rear Axle Right		11.9282-1002.3 250160	Brake System: ATE
1.4 TSI	110 05/14→12/17				
1.5 TFSI	110 05/17→12/17				
1.6 TDI	77 - 10/12→10/20 85				
1.8 TFSI	132 04/12→08/16				
1.8 TFSI quattro	132 08/12→08/16				
2.0 TDI	81 - 04/12→10/20 135				
2.0 TDI quattro	110 - 10/12→12/17 135				
2.0 TFSI	140 05/16→12/17				
2.0 TFSI quattro	140 05/16→12/17				
S3 quattro	206 - 11/12→12/17 228				



	kW				
AUDI - A3 Convertible (8P7) 04/08→05/13					
Guide Bolt, brake caliper					
1.2 TFSI	77 03/10→05/13	for PR number: 1ZE; Required quantity: 2	2	11.8171-0008.1 990049	Brake System: ATE
1.4 TFSI	92 02/11→05/13	for PR number: 1LJ; Required quantity: 2	2	11.8171-0008.1 990049	Brake System: ATE
1.6	75 09/08→05/10				
1.6 TDI	77 05/09→05/13				
1.8 TFSI	118 04/08→05/13				
1.9 TDI	77 04/08→10/09				
2.0 TDI	100 - 04/08→05/13				
	103				
2.0 TFSI	147 04/08→05/13				
 Brake Disc					
1.2 TFSI	77 03/10→05/13	for PR number: 1ZE; Fitting Position: Front Axle		24.0125-0145.1 425145	Outer diameter [mm]: 288 Brake Disc Thickness [mm] 25 Minimum thickness [mm] 22 Brake Disc Type: Vented Supplementary Article/Info 2: with bolts/screws
1.4 TFSI	92 02/11→05/13				
1.6	75 09/08→05/10				
1.6 TDI	77 05/09→05/13				
1.8 TFSI	118 04/08→05/13				
1.9 TDI	77 04/08→10/09				
2.0 TDI	100 - 04/08→05/13	for PR number: 1LJ / 1ZA; Fitting Position: Front Axle		24.0125-0158.1 425158	Outer diameter [mm]: 312 Brake Disc Thickness [mm] 25 Minimum thickness [mm] 22 Brake Disc Type: Vented Supplementary Article/Info 2: with bolts/screws
	103				
2.0 TFSI	147 04/08→05/13			24.0325-0158.1 525158	Outer diameter [mm]: 312 Brake Disc Thickness [mm] 25 Minimum thickness [mm] 22 Brake Disc Type: Vented Supplementary Article/Info 2: with bolts/screws
		for PR number: 1KS; Fitting Position: Rear Axle		24.0110-0356.1 410356	Outer diameter [mm]: 272 Brake Disc Thickness [mm] 9.7 Minimum thickness [mm] 8 Brake Disc Type: Solid Supplementary Article/Info 2: with bolts/screws
				24.0310-0356.1 510356	Outer diameter [mm]: 272 Brake Disc Thickness [mm] 9.7 Minimum thickness [mm] 8 Brake Disc Type: Solid Supplementary Article/Info 2: with bolts/screws
AUDI - A3 Convertible (8V7, 8VE) 10/13→					
 Brake Caliper					
1.4 TFSI	85 - 10/13→ 103	for PR number: 1ZA / 1ZD; Fitting Position: Front Axle Left		24.3571-1801.5 241387	Supplementary Article/Supplementary Info: without holder Brake Caliper Type: Fist-type Caliper
1.4 TSI	110 05/14→10/20				
1.5 TFSI	110 05/17→10/18				
1.6 TDI	81 - 02/14→10/20	for PR number: 1ZA / 1ZD; Fitting Position: Front Axle Right		24.3571-1802.5 241388	Supplementary Article/Supplementary Info: without holder Brake Caliper Type: Fist-type Caliper
	85				
1.8 TFSI	125 - 10/13→10/20 132				
1.8 TFSI quattro	132 03/14→				
2.0 TDI	100 - 10/13→ 135				
2.0 TDI quattro	110 - 03/14→10/20 135				
2.0 TFSI	140 05/16→10/20				
2.0 TFSI quattro	140 - 05/14→10/20 162				
35 TFSI	110 10/18→10/20				
40 TFSI	140 11/18→10/20				
40 TFSI quattro	140 11/18→10/20				
S3 quattro	210 - 03/14→ 228				
Guide Sleeve Kit, brake caliper					
1.4 TFSI	85 - 10/13→ 103	for PR number: 1KE / 1KJ / 1KR / 1KY; Fitting Position: Rear Axle		11.0101-5407.2 260011	Brake System: ATE
1.4 TSI	110 05/14→10/20				
1.5 TFSI	110 05/17→10/18				
1.6 TDI	81 - 02/14→10/20 85				
1.8 TFSI	125 - 10/13→10/20 132				
1.8 TFSI quattro	132 03/14→				
2.0 TDI	100 - 10/13→ 135				
2.0 TDI quattro	110 - 03/14→10/20 135				
→					



	kW								
AUDI - A3 Convertible (8V7, 8VE) 10/13→									
Guide Sleeve Kit, brake caliper									
2.0 TFSI	140 05/16→10/20	for PR number: 1KE / 1KJ / 1KR / 1KY; Fitting Position: Rear Axle	2	11.0101-5407.2 260011	Brake System: ATE				
2.0 TFSI quattro	140 - 05/14→10/20 162								
35 TFSI	110 10/18→10/20								
40 TFSI	140 11/18→10/20								
40 TFSI quattro	140 11/18→10/20								
S3 quattro	210 - 03/14→ 228								
Guide Bolt, brake caliper									
1.4 TFSI	85 - 10/13→ 103	for PR number: 1KE / 1KJ / 1KR / 1KY; Required quantity: 2; Fitting Position: Rear Axle	2	11.8171-0008.1 990049	Brake System: ATE				
1.4 TSI	110 05/14→10/20								
1.5 TFSI	110 05/17→10/18								
1.6 TDI	81 - 02/14→10/20 85								
1.8 TFSI	125 - 10/13→10/20 132								
1.8 TFSI quattro	132 03/14→								
2.0 TDI	100 - 10/13→ 135								
2.0 TDI quattro	110 - 03/14→10/20 135								
2.0 TFSI	140 05/16→10/20								
2.0 TFSI quattro	140 - 05/14→10/20 162								
35 TFSI	110 10/18→10/20								
40 TFSI	140 11/18→10/20								
40 TFSI quattro	140 11/18→10/20								
S3 quattro	210 - 03/14→ 228								
 Brake Disc									
1.4 TFSI	85 - 10/13→ 103	for PR number: 1ZE / 1ZP; Fitting Position: Front Axle		24.0125-0145.1 425145	Outer diameter [mm]: 288 Brake Disc Thickness [mm] 25 Minimum thickness [mm] 22 Brake Disc Type: Vented Supplementary Article/Info 2: with bolts/screws				
1.4 TSI	110 05/14→10/20								
1.5 TFSI	110 05/17→10/18								
1.6 TDI	81 - 02/14→10/20 85								
1.8 TFSI	132 10/13→07/16	for PR number: 1ZA / 1ZD; Fitting Position: Front Axle		24.0125-0158.1 425158	Outer diameter [mm]: 312 Brake Disc Thickness [mm] 25 Minimum thickness [mm] 22 Brake Disc Type: Vented Supplementary Article/Info 2: with bolts/screws				
1.8 TFSI quattro	132 03/14→								
2.0 TDI	100 - 10/13→ 135								
2.0 TDI quattro	110 - 03/14→10/20 135								
2.0 TFSI	140 05/16→10/20								
2.0 TFSI quattro	140 05/16→10/20								
40 TFSI quattro	140 11/18→10/20								
S3 quattro	210 - 03/14→ 228								
		for PR number: 1KE / 1KR; Fitting Position: Rear Axle		24.0110-0356.1 410356	Outer diameter [mm]: 272 Brake Disc Thickness [mm] 9.7 Minimum thickness [mm] 8 Brake Disc Type: Solid Supplementary Article/Info 2: with bolts/screws				
				24.0310-0356.1 510356	Outer diameter [mm]: 272 Brake Disc Thickness [mm] 9.7 Minimum thickness [mm] 8 Brake Disc Type: Solid Supplementary Article/Info 2: with bolts/screws				
		for PR number: 2ED; Vehicle Equipment: for vehicles with electric parking brake; Fitting Position: Rear Axle		24.0112-0210.1 412210	Outer diameter [mm]: 300 Brake Disc Thickness [mm] 12 Minimum thickness [mm] 10 Brake Disc Type: Solid Supplementary Article/Info 2: with bolts/screws				
1.8 TFSI	125 05/14→10/20	for PR number: 1ZE / 1ZP; Fitting Position: Front Axle		24.0125-0145.1 425145	Outer diameter [mm]: 288 Brake Disc Thickness [mm] 25 Minimum thickness [mm] 22 Brake Disc Type: Vented Supplementary Article/Info 2: with bolts/screws				
2.0 TFSI quattro	162 05/14→10/20								
35 TFSI	110 10/18→10/20								
40 TFSI	140 11/18→10/20								
→									

	kW			
AUDI - A3 Convertible (8V7, 8VE) 10/13→				
 Brake Disc				
1.8 TFSI 2.0 TFSI quattro 35 TFSI 40 TFSI	125 05/14→10/20 162 05/14→10/20 110 10/18→10/20 140 11/18→10/20	for PR number: 1ZA / 1ZD; Fitting Position: Front Axle	24.0125-0158.1 425158	Outer diameter [mm]: 312 Brake Disc Thickness [mm] 25 Minimum thickness [mm] 22 Brake Disc Type: Vented Supplementary Article/Info 2: with bolts/screws
		for PR number: 1KE / 1KR; Fitting Position: Rear Axle	24.0110-0356.1 410356	Outer diameter [mm]: 272 Brake Disc Thickness [mm] 9.7 Minimum thickness [mm] 8 Brake Disc Type: Solid Supplementary Article/Info 2: with bolts/screws
			24.0310-0356.1 510356	Outer diameter [mm]: 272 Brake Disc Thickness [mm] 9.7 Minimum thickness [mm] 8 Brake Disc Type: Solid Supplementary Article/Info 2: with bolts/screws
		for PR number: 2ED; Vehicle Equipment: for vehicles with electric parking brake; Fitting Position: Rear Axle	24.0112-0210.1 412210	Outer diameter [mm]: 300 Brake Disc Thickness [mm] 12 Minimum thickness [mm] 10 Brake Disc Type: Solid Supplementary Article/Info 2: with bolts/screws
S3 quattro	213 07/16→10/20	for PR number: 1ZE / 1ZP; Fitting Position: Front Axle	24.0125-0145.1 425145	Outer diameter [mm]: 288 Brake Disc Thickness [mm] 25 Minimum thickness [mm] 22 Brake Disc Type: Vented Supplementary Article/Info 2: with bolts/screws
		for PR number: 1ZA / 1ZD; Fitting Position: Front Axle	24.0125-0158.1 425158	Outer diameter [mm]: 312 Brake Disc Thickness [mm] 25 Minimum thickness [mm] 22 Brake Disc Type: Vented Supplementary Article/Info 2: with bolts/screws
		for PR number: 2ED; Vehicle Equipment: for vehicles with electric parking brake; Fitting Position: Rear Axle	24.0112-0210.1 412210	Outer diameter [mm]: 300 Brake Disc Thickness [mm] 12 Minimum thickness [mm] 10 Brake Disc Type: Solid Supplementary Article/Info 2: with bolts/screws
 Wheel Speed Sensor				
1.4 TFSI	85 - 10/13→ 103	Fitting Position: Front Axle Left	24.0711-5273.3 360303	
1.4 TSI	110 05/14→10/20	Fitting Position: Front Axle Right	24.0711-5274.3 360304	
1.5 TFSI	110 05/17→10/18	Comfort Equipment Variant (trim package): for cruise control system; Required quantity: 2;	24.0711-6337.3 360390	2
1.6 TDI	81 - 02/14→10/20 85	Fitting Position: Rear Axle		
1.8 TFSI	125 - 10/13→10/20 132	Vehicle Equipment: for vehicles with parking assistant system; Required quantity: 2;	24.0711-6337.3 360390	2
2.0 TDI	100 - 10/13→ 135	Fitting Position: Rear Axle		
2.0 TFSI	140 05/16→10/20			
1.8 TFSI quattro	132 03/14→	Fitting Position: Front Axle Left	24.0711-5273.3 360303	
2.0 TDI quattro	110 - 03/14→10/20 135	Fitting Position: Front Axle Right	24.0711-5274.3 360304	
2.0 TFSI quattro	140 - 05/14→10/20 162	Vehicle Equipment: for vehicles with parking assistant system; Fitting Position: Rear Axle Left	24.0711-5401.3 360330	
S3 quattro	213 - 04/14→10/20 228	Comfort Equipment Variant (trim package): for cruise control system; Fitting Position: Rear Axle Left	24.0711-5401.3 360330	
		Comfort Equipment Variant (trim package): for cruise control system; Fitting Position: Rear Axle Right	24.0711-5402.3 360331	
		Vehicle Equipment: for vehicles with parking assistant system; Fitting Position: Rear Axle Right	24.0711-5402.3 360331	
S3 quattro	210 03/14→	Construction year from: 04/14 →; Fitting Position: Front Axle Left	24.0711-5273.3 360303	
→				

	kW				
AUDI - A3 Convertible (8V7, 8VE) 10/13→					
 Wheel Speed Sensor					
S3 quattro	210 03/14→		Construction year from: 04/14 →; Fitting Position: Front Axle Right	24.0711-5274.3 360304	
			Construction year from: 04/14 →; Vehicle Equipment: for vehicles with parking assistant system; Fitting Position: Rear Axle Left	24.0711-5401.3 360330	
			Construction year from: 04/14 →; Comfort Equipment Variant (trim package): for cruise control system; Fitting Position: Rear Axle Left	24.0711-5401.3 360330	
			Construction year from: 04/14 →; Vehicle Equipment: for vehicles with parking assistant system; Fitting Position: Rear Axle Right	24.0711-5402.3 360331	
			Construction year from: 04/14 →; Comfort Equipment Variant (trim package): for cruise control system; Fitting Position: Rear Axle Right	24.0711-5402.3 360331	
Control Element, parking brake caliper					
1.4 TFSI	85 - 10/13→ 103		for PR number: 1KE / 1KR / 1KZ; Fitting Position: Rear Axle Left	11.9282-1001.3 250159	Brake System: ATE
1.4 TSI	110 05/14→10/20			11.9282-1002.3 250160	Brake System: ATE
1.5 TFSI	110 05/17→10/18		for PR number: 1KE / 1KR / 1KZ; Fitting Position: Rear Axle Right		
1.6 TDI	81 - 02/14→10/20 85				
1.8 TFSI	125 - 10/13→10/20 132				
1.8 TFSI quattro	132 03/14→				
2.0 TDI	100 - 10/13→ 135				
2.0 TDI quattro	110 - 03/14→10/20 135				
2.0 TFSI	140 05/16→10/20				
2.0 TFSI quattro	140 - 05/14→10/20 162				
35 TFSI	110 10/18→10/20				
40 TFSI	140 11/18→10/20				
40 TFSI quattro	140 11/18→10/20				
S3 quattro	210 - 03/14→ 228				
AUDI - A3 Limousine (8VS, 8VM) 05/13→					
 Brake Caliper					
1.0 TFSI	85 07/16→10/20		for PR number: 1ZA / 1ZD; Fitting Position: Front Axle Left	24.3571-1801.5 241387	Supplementary Article/Supplementary Info: without holder Brake Caliper Type: Fist-type Caliper
1.2 TFSI	77 - 10/13→ 81				
1.4 TFSI	90 - 05/13→ 103		for PR number: 1ZA / 1ZD; Fitting Position: Front Axle Right	24.3571-1802.5 241388	Supplementary Article/Supplementary Info: without holder Brake Caliper Type: Fist-type Caliper
1.4 TSI	110 05/14→10/20				
1.5 TFSI	110 05/17→10/18				
1.6 TDI	77 - 09/13→ 85				
1.6 TDI quattro	81 05/15→				
1.8 TFSI	125 - 05/13→ 132				
1.8 TFSI quattro	132 11/13→				
2.0 TDI	81 - 05/13→ 135				
2.0 TDI quattro	110 - 10/13→10/20 135				
2.0 TFSI	140 - 11/15→10/20 162				
2.0 TFSI quattro	140 05/16→10/20				
30 TDI	85 07/18→10/20				
30 TFSI	85 07/18→10/20				
35 TDI	110 07/18→10/20				
35 TFSI	110 10/18→10/20				
40 TDI quattro	135 07/18→07/19				
40 TFSI	140 07/18→10/20				
40 TFSI quattro	140 07/18→10/20				
RS3 quattro	294 04/17→10/20				
S3 quattro	206 - 10/13→ 228				
Guide Sleeve Kit, brake caliper					
1.0 TFSI	85 07/16→10/20		for PR number: 1KE / 1KJ / 1KR / 1KY; Fitting Position: Rear Axle	11.0101-5407.2 260011	Brake System: ATE
1.2 TFSI	77 - 10/13→ 81				
1.4 TFSI	90 - 05/13→ 103				
→					

	kW				
AUDI - A3 Limousine (8VS, 8VM) 05/13→					
Guide Sleeve Kit, brake caliper					
1.4 TSI	110 05/14→10/20	for PR number: 1KE / 1KJ / 1KR / 1KY; Fitting Position: Rear Axle	2	11.0101-5407.2 260011	Brake System: ATE
1.5 TFSI	110 05/17→10/18				
1.6 TDI	77 - 09/13→ 85				
1.6 TDI quattro	81 05/15→				
1.8 TFSI	125 - 05/13→ 132				
1.8 TFSI quattro	132 11/13→				
2.0 TDI	81 - 05/13→ 135				
2.0 TDI quattro	110 - 10/13→10/20 135				
2.0 TFSI	140 - 11/15→10/20 162				
2.0 TFSI quattro	140 05/16→10/20				
30 TDI	85 07/18→10/20				
30 TFSI	85 07/18→10/20				
35 TDI	110 07/18→10/20				
35 TFSI	110 10/18→10/20				
40 TDI quattro	135 07/18→07/19				
40 TFSI	140 07/18→10/20				
40 TFSI quattro	140 07/18→10/20				
RS3 quattro	294 04/17→10/20				
S3 quattro	206 - 10/13→ 228				
Guide Bolt, brake caliper					
1.0 TFSI	85 07/16→10/20	for PR number: 1KE / 1KJ / 1KR / 1KY; Required quantity: 2; Fitting Position: Rear Axle	2	11.8171-0008.1 990049	Brake System: ATE
1.2 TFSI	77 - 10/13→ 81				
1.4 TFSI	90 - 05/13→ 103				
1.4 TSI	110 05/14→10/20				
1.5 TFSI	110 05/17→10/18				
1.6 TDI	77 - 09/13→ 85				
1.6 TDI quattro	81 05/15→				
1.8 TFSI	125 - 05/13→ 132				
1.8 TFSI quattro	132 11/13→				
2.0 TDI	81 - 05/13→ 135				
2.0 TDI quattro	110 - 10/13→10/20 135				
2.0 TFSI	140 - 11/15→10/20 162				
2.0 TFSI quattro	140 05/16→10/20				
30 TDI	85 07/18→10/20				
30 TFSI	85 07/18→10/20				
35 TDI	110 07/18→10/20				
35 TFSI	110 10/18→10/20				
40 TDI quattro	135 07/18→07/19				
40 TFSI	140 07/18→10/20				
40 TFSI quattro	140 07/18→10/20				
RS3 quattro	294 04/17→10/20				
S3 quattro	206 - 10/13→ 228				
Brake Disc					
1.0 TFSI	85 07/16→10/20	for PR number: 1ZE / 1ZP; Fitting Position: Front Axle	2	24.0125-0145.1 425145	Outer diameter [mm]: 288 Brake Disc Thickness [mm] 25 Minimum thickness [mm] 22 Brake Disc Type: Vented Supplementary Article/Info 2: with bolts/screws
1.2 TFSI	81 05/14→				
1.4 TFSI	90 - 05/13→ 103				
1.4 TSI	110 05/14→10/20				
1.5 TFSI	110 05/17→10/18				
1.6 TDI	77 - 09/13→ 85	for PR number: 1ZA / 1ZD; Fitting Position: Front Axle	2	24.0125-0158.1 425158	Outer diameter [mm]: 312 Brake Disc Thickness [mm] 25 Minimum thickness [mm] 22 Brake Disc Type: Vented Supplementary Article/Info 2: with bolts/screws
1.6 TDI quattro	81 05/15→				
1.8 TFSI	132 05/13→				
1.8 TFSI quattro	132 11/13→				
2.0 TDI	100 - 05/13→ 135				
2.0 TDI quattro	110 - 10/13→10/20 135				
2.0 TFSI	140 05/16→10/20				
2.0 TFSI quattro	140 05/16→10/20				
35 TDI	110 07/18→10/20				
40 TDI quattro	135 07/18→07/19				
40 TFSI quattro	140 07/18→10/20				
RS3 quattro	294 04/17→10/20				
S3 quattro	206 - 10/13→ 221				
→					



	kW				
AUDI - A3 Limousine (8VS, 8VM) 05/13→					
 Wheel Speed Sensor					
1.0 TFSI	85 07/16→10/20		Fitting Position: Front Axle Left	24.0711-5273.3	360303
1.2 TFSI	77 - 10/13→		Fitting Position: Front Axle Right	24.0711-5274.3	360304
	81				
1.4 TFSI	90 - 05/13→		Required quantity: 2; Comfort Equipment Variant (trim package): for cruise control system; Fitting Position: Rear Axle	2	24.0711-6337.3 360390
	103				
1.4 TSI	110 05/14→10/20				
1.5 TFSI	110 05/17→10/18				
1.6 TDI	77 - 09/13→		Required quantity: 2; Vehicle Equipment: for vehicles with parking assistant system; Fitting Position: Rear Axle	2	24.0711-6337.3 360390
	85				
1.8 TFSI	125 - 05/13→				
	132				
2.0 TDI	81 - 05/13→				
	135				
2.0 TFSI	140 05/16→10/20				
30 TDI	85 07/18→10/20				
30 TFSI	85 07/18→10/20				
1.6 TDI quattro	81 05/15→		Fitting Position: Front Axle Left	24.0711-5273.3	360303
1.8 TFSI quattro	132 11/13→		Fitting Position: Front Axle Right	24.0711-5274.3	360304
2.0 TDI quattro	110 - 10/13→10/20		Vehicle Equipment: for vehicles with parking assistant system; Fitting Position: Rear Axle Left	24.0711-5401.3	360330
	135				
2.0 TFSI quattro	140 05/16→10/20		Comfort Equipment Variant (trim package): for cruise control system; Fitting Position: Rear Axle Left	24.0711-5401.3	360330
S3 quattro	206 - 10/13→		Comfort Equipment Variant (trim package): for cruise control system; Fitting Position: Rear Axle Right	24.0711-5402.3	360331
	228		Vehicle Equipment: for vehicles with parking assistant system; Fitting Position: Rear Axle Right	24.0711-5402.3	360331
RS3 quattro	294 04/17→10/20		Fitting Position: Front Axle Left	24.0711-5273.3	360303
			Fitting Position: Front Axle Right	24.0711-5274.3	360304
			Fitting Position: Rear Axle Left	24.0711-5401.3	360330
			Fitting Position: Rear Axle Right	24.0711-5402.3	360331
Control Element, parking brake caliper					
1.0 TFSI	85 07/16→10/20		for PR number: 1KE / 1KR / 1KZ; Fitting Position: Rear Axle Left	11.9282-1001.3	250159 Brake System: ATE
1.2 TFSI	77 - 10/13→				
	81		for PR number: 1KE / 1KR / 1KZ; Fitting Position: Rear Axle Right	11.9282-1002.3	250160 Brake System: ATE
1.4 TFSI	90 - 05/13→				
	103				
1.4 TSI	110 05/14→10/20				
1.5 TFSI	110 05/17→10/18				
1.6 TDI	77 - 09/13→				
	85				
1.6 TDI quattro	81 05/15→				
1.8 TFSI	125 - 05/13→				
	132				
1.8 TFSI quattro	132 11/13→				
2.0 TDI	81 - 05/13→				
	135				
2.0 TDI quattro	110 - 10/13→10/20				
	135				
2.0 TFSI	140 - 11/15→10/20				
	162				
2.0 TFSI quattro	140 05/16→10/20				
30 TDI	85 07/18→10/20				
30 TFSI	85 07/18→10/20				
35 TDI	110 07/18→10/20				
35 TFSI	110 10/18→10/20				
40 TDI quattro	135 07/18→07/19				
40 TFSI	140 07/18→10/20				
40 TFSI quattro	140 07/18→10/20				
RS3 quattro	294 04/17→10/20				
S3 quattro	206 - 10/13→				
	228				
AUDI - A3 Limousine (8YS) 03/20→					
 Brake Disc					
30 TDI	85 06/20→		for PR number: 1ZE; Fitting Position: Front Axle	24.0125-0145.1	425145 Outer diameter [mm]: 288 Brake Disc Thickness [mm] 25 Minimum thickness [mm] 22 Brake Disc Type: Vented Supplementary Article/Info 2: with bolts/screws
30 TFSI	81 06/20→				
30 TFSI Mild Hybrid	81 06/20→				
35 TDI	110 04/20→				
35 TFSI	110 04/20→				
35 TFSI Mild Hybrid	110 04/20→				
40 TDI quattro	147 12/20→				
40 TFSI quattro	140 07/21→				
S3 quattro	228 06/20→				
→					



	kW					
AUDI - A3 Limousine (8YS) 03/20→						
 Brake Disc						
30 TDI	85 06/20→	for PR number: 1ZK / 1ZL / 1ZU; Fitting Position: Front Axle	24.0125-0158.1	425158	Outer diameter [mm]: 312 Brake Disc Thickness [mm] 25 Minimum thickness [mm] 22 Brake Disc Type: Vented Supplementary Article/Info 2: with bolts/screws	
30 TFSI	81 06/20→					
30 TFSI Mild Hybrid	81 06/20→					
35 TDI	110 04/20→					
35 TFSI	110 04/20→					
35 TFSI Mild Hybrid	110 04/20→	for PR number: 1KE / 2EC / 2EJ; Fitting Position: Rear Axle	24.0110-0356.1	410356	Outer diameter [mm]: 272 Brake Disc Thickness [mm] 9.7 Minimum thickness [mm] 8 Brake Disc Type: Solid Supplementary Article/Info 2: with bolts/screws	
40 TDI quattro	147 12/20→					
40 TFSI quattro	140 07/21→					
40 TFSI quattro	140 07/21→					
S3 quattro	228 06/20→					
 Wheel Speed Sensor						
30 TDI	85 06/20→	Fitting Position: Front Axle Left	24.0711-5273.3	360303		
30 TFSI	81 06/20→	Fitting Position: Front Axle Right	24.0711-5274.3	360304		
30 TFSI Mild Hybrid	81 06/20→					
35 TDI	110 04/20→	Required quantity: 2; Fitting Position: Rear Axle	2	24.0711-6337.3	360390	
35 TFSI	110 04/20→					
35 TFSI Mild Hybrid	110 04/20→					
40 TDI quattro	147 12/20→					
40 TFSI quattro	140 07/21→					
S3 quattro	228 06/20→					
RS3 quattro	294 07/21→	Fitting Position: Front Axle Left	24.0711-5273.3	360303		
		Fitting Position: Front Axle Right	24.0711-5274.3	360304		
		Fitting Position: Rear Axle Left	24.0711-5401.3	360330		
		Fitting Position: Rear Axle Right	24.0711-5402.3	360331		
Control Element, parking brake caliper						
RS3 quattro	294 07/21→	Fitting Position: Rear Axle Left	11.9282-1001.3	250159	Brake System: ATE	
		Fitting Position: Rear Axle Right	11.9282-1002.3	250160	Brake System: ATE	
AUDI - A3 Sportback (8PA) 09/04→12/15						
Guide Bolt, brake caliper						
1.2 TSI	77 04/10→03/13	for PR number: 1ZD / 1LJ / 1ZA; Required quantity: 2	2	11.8171-0008.1	990049	Brake System: ATE
1.4 TFSI	92 09/07→03/13					
1.6	75 09/04→03/13	for PR number: 1ZE / 1ZP; Required quantity: 2	2	11.8171-0008.1	990049	Brake System: ATE
1.6 E-Power	75 01/11→03/13					
1.6 FSI	85 09/04→09/07	for PR number: 1LK; Required quantity: 2	2	11.8171-0008.1	990049	Brake System: ATE
1.6 TDI	66 - 05/09→03/13					
	77					
1.8 TFSI quattro	118 07/08→03/13					
1.9 TDI	77 09/04→05/10					
2.0 FSI	110 09/04→06/08					
2.0 TDI	100 - 09/04→03/13					
	125					
2.0 TDI 16V	103 09/04→03/13					
2.0 TDI 16V quattro	103 11/05→03/13					
2.0 TDI quattro	103 - 01/06→03/13					
	125					
2.0 TFSI	147 09/04→03/13					
2.0 TFSI quattro	147 09/04→03/13					
3.2 V6 quattro	184 09/04→05/09					
1.8 TFSI	118 11/06→03/13	Construction year from: 01/07 →; for PR number: 1ZE / 1ZP; Required quantity: 2	2	11.8171-0008.1	990049	Brake System: ATE
		Construction year from: 01/07 →; for PR number: 1ZD / 1LJ / 1ZA; Required quantity: 2	2	11.8171-0008.1	990049	Brake System: ATE
2.0 TDI	104 01/10→03/13	for PR number: 1ZE / 1ZP; Required quantity: 2	2	11.8171-0008.1	990049	Brake System: ATE
S3 quattro	188 - 06/08→03/13	for PR number: 1ZK; Required quantity: 2	2	11.8171-0008.1	990049	Brake System: ATE
	195					
 Brake Disc						
1.2 TSI	77 04/10→03/13	for PR number: 1ZE / 1ZP; Fitting Position: Front Axle	24.0125-0145.1	425145	Outer diameter [mm]: 288 Brake Disc Thickness [mm] 25 Minimum thickness [mm] 22 Brake Disc Type: Vented Supplementary Article/Info 2: with bolts/screws	
1.4 TFSI	92 09/07→03/13					
1.6	75 09/04→03/13					
1.6 E-Power	75 01/11→03/13					
1.6 FSI	85 09/04→09/07					
1.6 TDI	66 - 05/09→03/13					
	77					
1.8 TFSI quattro	118 07/08→03/13					
1.9 TDI	77 09/04→05/10					
2.0 FSI	110 09/04→06/08					

	kW				
AUDI - A3 Sportback (8PA) 09/04→12/15					
 Brake Disc					
2.0 TDI 2.0 TDI 16V 2.0 TDI 16V quattro 2.0 TDI quattro 2.0 TFSI 2.0 TFSI quattro 3.2 V6 quattro	103 - 06/05→03/13 125 103 09/04→03/13 103 11/05→03/13 103 - 01/06→03/13 125 147 09/04→03/13 147 09/04→03/13 184 09/04→05/09	for PR number: 1ZD / 1LJ / 1ZA; Fitting Position: Front Axle	24.0125-0158.1 425158 24.0325-0158.1 525158	Outer diameter [mm]: 312 Brake Disc Thickness [mm] 25 Minimum thickness [mm] 22 Brake Disc Type: Vented Supplementary Article/Info 2: with bolts/screws Outer diameter [mm]: 312 Brake Disc Thickness [mm] 25 Minimum thickness [mm] 22 Brake Disc Type: Vented Supplementary Article/Info 2: with bolts/screws	
		for PR number: 1KS; Fitting Position: Rear Axle	24.0110-0356.1 410356 24.0310-0356.1 510356	Outer diameter [mm]: 272 Brake Disc Thickness [mm] 9.7 Minimum thickness [mm] 8 Brake Disc Type: Solid Supplementary Article/Info 2: with bolts/screws Outer diameter [mm]: 272 Brake Disc Thickness [mm] 9.7 Minimum thickness [mm] 8 Brake Disc Type: Solid Supplementary Article/Info 2: with bolts/screws	
1.8 TFSI	118 11/06→03/13	Construction year from: 01/07 →; for PR number: 1ZE / 1ZP; Fitting Position: Front Axle	24.0125-0145.1 425145	Outer diameter [mm]: 288 Brake Disc Thickness [mm] 25 Minimum thickness [mm] 22 Brake Disc Type: Vented Supplementary Article/Info 2: with bolts/screws	
		Construction year from: 01/07 →; for PR number: 1ZD / 1LJ / 1ZA; Fitting Position: Front Axle	24.0125-0158.1 425158 24.0325-0158.1 525158	Outer diameter [mm]: 312 Brake Disc Thickness [mm] 25 Minimum thickness [mm] 22 Brake Disc Type: Vented Supplementary Article/Info 2: with bolts/screws Outer diameter [mm]: 312 Brake Disc Thickness [mm] 25 Minimum thickness [mm] 22 Brake Disc Type: Vented Supplementary Article/Info 2: with bolts/screws	
		Construction year from: 01/07 →; for PR number: 1KS; Fitting Position: Rear Axle	24.0110-0356.1 410356 24.0310-0356.1 510356	Outer diameter [mm]: 272 Brake Disc Thickness [mm] 9.7 Minimum thickness [mm] 8 Brake Disc Type: Solid Supplementary Article/Info 2: with bolts/screws Outer diameter [mm]: 272 Brake Disc Thickness [mm] 9.7 Minimum thickness [mm] 8 Brake Disc Type: Solid Supplementary Article/Info 2: with bolts/screws	
2.0 TDI	100 09/04→03/13	for PR number: 1ZE / 1ZP; Fitting Position: Front Axle	24.0125-0145.1 425145	Outer diameter [mm]: 288 Brake Disc Thickness [mm] 25 Minimum thickness [mm] 22 Brake Disc Type: Vented Supplementary Article/Info 2: with bolts/screws	
		for PR number: 1ZD / 1LJ / 1ZA; Fitting Position: Front Axle	24.0125-0158.1 425158	Outer diameter [mm]: 312 Brake Disc Thickness [mm] 25 Minimum thickness [mm] 22 Brake Disc Type: Vented Supplementary Article/Info 2: with bolts/screws	
		for PR number: 1KS; Fitting Position: Rear Axle	24.0110-0356.1 410356 24.0310-0356.1 510356	Outer diameter [mm]: 272 Brake Disc Thickness [mm] 9.7 Minimum thickness [mm] 8 Brake Disc Type: Solid Supplementary Article/Info 2: with bolts/screws Outer diameter [mm]: 272 Brake Disc Thickness [mm] 9.7 Minimum thickness [mm] 8 Brake Disc Type: Solid Supplementary Article/Info 2: with bolts/screws	

	kW			
AUDI - A3 Sportback (8VA, 8VF) 09/12→				
 Brake Caliper				
1.0 TFSI	85 07/16→10/20	for PR number: 1ZA / 1ZD; Fitting Position: Front Axle Left	24.3571-1801.5 241387	Supplementary Article/Supplementary Info: without holder Brake Caliper Type: Fist-type Caliper
1.2 TFSI	77 - 05/13→ 81			
1.4 TFSI	90 - 09/12→ 103			
1.4 TFSI e-tron	110 - 05/14→10/20 150			
1.4 TFSI g-tron	81 11/13→10/20	for PR number: 1ZA / 1ZD; Fitting Position: Front Axle Right	24.3571-1802.5 241388	Supplementary Article/Supplementary Info: without holder Brake Caliper Type: Fist-type Caliper
1.4 TFSI	110 05/14→10/20			
1.5 TFSI	110 05/17→10/18			
1.6 TDI	77 - 10/12→ 85			
1.6 TDI quattro	81 05/15→08/16			
1.8 TFSI	132 09/12→			
1.8 TFSI quattro	132 05/13→			
2.0 TDI	81 - 09/12→10/20 135			
2.0 TDI quattro	110 - 02/13→10/20 135			
2.0 TFSI	140 05/16→10/20			
2.0 TFSI quattro	140 05/16→10/20			
30 g-tron	96 11/18→10/20			
30 TDI	85 07/18→10/20			
30 TFSI	85 07/18→10/20			
35 TDI	110 07/18→10/20			
35 TFSI	110 10/18→10/20			
40 TDI quattro	135 07/18→10/20			
40 TFSI	140 07/18→10/20			
40 TFSI quattro	140 07/18→10/20			
S3 quattro	206 - 11/12→ 228			
Guide Sleeve Kit, brake caliper				
1.0 TFSI	85 07/16→10/20	for PR number: 1KE / 1KJ / 1KR / 1KY; Fitting Position: Rear Axle	11.0101-5407.2 260011	Brake System: ATE
1.2 TFSI	77 - 05/13→ 81			
1.4 TFSI	90 - 09/12→ 103			
1.4 TFSI e-tron	110 - 05/14→10/20 150			
1.4 TFSI g-tron	81 11/13→10/20			
1.4 TFSI	110 05/14→10/20			
1.5 TFSI	110 05/17→10/18			
1.6 TDI	77 - 10/12→ 85			
1.6 TDI quattro	81 05/15→08/16			
1.8 TFSI	132 09/12→			
1.8 TFSI quattro	132 05/13→			
2.0 TDI	81 - 09/12→10/20 135			
2.0 TDI quattro	110 - 02/13→10/20 135			
2.0 TFSI	140 05/16→10/20			
2.0 TFSI quattro	140 05/16→10/20			
30 g-tron	96 11/18→10/20			
30 TDI	85 07/18→10/20			
30 TFSI	85 07/18→10/20			
35 TDI	110 07/18→10/20			
35 TFSI	110 10/18→10/20			
40 TDI quattro	135 07/18→10/20			
40 TFSI	140 07/18→10/20			
40 TFSI quattro	140 07/18→10/20			
RS3 quattro	270 - 03/15→ 294			
S3 quattro	206 - 11/12→ 228			
Guide Bolt, brake caliper				
1.0 TFSI	85 07/16→10/20	for PR number: 1KE / 1KJ / 1KR / 1KY; Required quantity: 2; Fitting Position: Rear Axle	2 11.8171-0008.1 990049	Brake System: ATE
1.2 TFSI	77 - 05/13→ 81			
1.4 TFSI	90 - 09/12→ 103			
1.4 TFSI e-tron	110 - 05/14→10/20 150			
1.4 TFSI g-tron	81 11/13→10/20			
1.4 TFSI	110 05/14→10/20			
1.5 TFSI	110 05/17→10/18			
1.6 TDI	77 - 10/12→ 85			
1.6 TDI quattro	81 05/15→08/16			
1.8 TFSI	132 09/12→			
1.8 TFSI quattro	132 05/13→			

	kW				
AUDI - A3 Sportback (8VA, 8VF) 09/12→					
Guide Bolt, brake caliper					
2.0 TDI	81 - 09/12→10/20 135	for PR number: 1KE / 1KJ / 1KR / 1KY; Required quantity: 2; Fitting Position: Rear Axle	2	11.8171-0008.1 990049	Brake System: ATE
2.0 TDI quattro	110 - 02/13→10/20 135				
2.0 TFSI	140 05/16→10/20				
2.0 TFSI quattro	140 05/16→10/20				
30 g-tron	96 11/18→10/20				
30 TDI	85 07/18→10/20				
30 TFSI	85 07/18→10/20				
35 TDI	110 07/18→10/20				
35 TFSI	110 10/18→10/20				
40 TDI quattro	135 07/18→10/20				
40 TFSI	140 07/18→10/20				
40 TFSI quattro	140 07/18→10/20				
RS3 quattro	270 - 03/15→ 294				
S3 quattro	206 - 11/12→ 228				
Brake Disc					
1.0 TFSI	85 07/16→10/20	for PR number: 1ZE / 1ZP; Fitting Position: Front Axle		24.0125-0145.1 425145	Outer diameter [mm]: 288 Brake Disc Thickness [mm] 25 Minimum thickness [mm] 22 Brake Disc Type: Vented Supplementary Article/Info 2: with bolts/screws
1.2 TFSI	77 - 05/13→ 81				
1.4 TFSI	90 - 09/12→ 103				
1.4 TFSI e-tron	110 - 05/14→10/20 150				
1.4 TFSI g-tron	81 11/13→10/20	for PR number: 1ZA / 1ZD; Fitting Position: Front Axle		24.0125-0158.1 425158	Outer diameter [mm]: 312 Brake Disc Thickness [mm] 25 Minimum thickness [mm] 22 Brake Disc Type: Vented Supplementary Article/Info 2: with bolts/screws
1.4 TSI	110 05/14→10/20				
1.5 TFSI	110 05/17→10/18				
1.6 TDI	77 - 10/12→ 85				
1.6 TDI quattro	81 05/15→08/16				
1.8 TFSI	132 09/12→			24.0325-0158.1 525158	Outer diameter [mm]: 312 Brake Disc Thickness [mm] 25 Minimum thickness [mm] 22 Brake Disc Type: Vented Supplementary Article/Info 2: with bolts/screws
1.8 TFSI quattro	132 05/13→				
2.0 TDI	100 - 09/12→10/20 135				
2.0 TDI quattro	110 - 02/13→10/20 135				
2.0 TFSI	140 05/16→10/20	for PR number: 1KE / 1KR; Fitting Position: Rear Axle		24.0110-0356.1 410356	Outer diameter [mm]: 272 Brake Disc Thickness [mm] 9.7 Minimum thickness [mm] 8 Brake Disc Type: Solid Supplementary Article/Info 2: with bolts/screws
2.0 TFSI quattro	140 05/16→10/20				
30 g-tron	96 11/18→10/20				
35 TDI	110 07/18→10/20				
35 TFSI	110 10/18→10/20				
40 TDI quattro	135 07/18→10/20				
40 TFSI quattro	140 07/18→10/20				
S3 quattro	206 - 11/12→ 221			24.0310-0356.1 510356	Outer diameter [mm]: 272 Brake Disc Thickness [mm] 9.7 Minimum thickness [mm] 8 Brake Disc Type: Solid Supplementary Article/Info 2: with bolts/screws
		for PR number: 2ED; Vehicle Equipment: for vehicles with electric parking brake; Fitting Position: Rear Axle		24.0112-0210.1 412210	Outer diameter [mm]: 300 Brake Disc Thickness [mm] 12 Minimum thickness [mm] 10 Brake Disc Type: Solid Supplementary Article/Info 2: with bolts/screws
2.0 TDI	81 - 03/13→10/20 105	for PR number: 1ZE / 1ZP; Fitting Position: Front Axle		24.0125-0145.1 425145	Outer diameter [mm]: 288 Brake Disc Thickness [mm] 25 Minimum thickness [mm] 22 Brake Disc Type: Vented Supplementary Article/Info 2: with bolts/screws
30 TDI	85 07/18→10/20				
30 TFSI	85 07/18→10/20				
40 TFSI	140 07/18→10/20				
		for PR number: 1ZA / 1ZD; Fitting Position: Front Axle		24.0125-0158.1 425158	Outer diameter [mm]: 312 Brake Disc Thickness [mm] 25 Minimum thickness [mm] 22 Brake Disc Type: Vented Supplementary Article/Info 2: with bolts/screws
		for PR number: 1KE / 1KR; Fitting Position: Rear Axle		24.0110-0356.1 410356	Outer diameter [mm]: 272 Brake Disc Thickness [mm] 9.7 Minimum thickness [mm] 8 Brake Disc Type: Solid Supplementary Article/Info 2: with bolts/screws
				24.0310-0356.1 510356	Outer diameter [mm]: 272 Brake Disc Thickness [mm] 9.7 Minimum thickness [mm] 8 Brake Disc Type: Solid Supplementary Article/Info 2: with bolts/screws

	kW			
AUDI - A3 Sportback (8VA, 8VF) 09/12→				
 Brake Disc				
2.0 TDI 30 TDI 30 TFSI 40 TFSI	81 - 03/13→10/20 105 85 07/18→10/20 85 07/18→10/20 140 07/18→10/20	for PR number: 2ED; Vehicle Equipment: for vehicles with electric parking brake; Fitting Position: Rear Axle	24.0112-0210.1 412210	Outer diameter [mm]: 300 Brake Disc Thickness [mm] 12 Minimum thickness [mm] 10 Brake Disc Type: Solid Supplementary Article/Info 2: with bolts/screws
S3 quattro	228 06/16→10/20	for PR number: 1ZE / 1ZP; Fitting Position: Front Axle	24.0125-0145.1 425145	Outer diameter [mm]: 288 Brake Disc Thickness [mm] 25 Minimum thickness [mm] 22 Brake Disc Type: Vented Supplementary Article/Info 2: with bolts/screws
		for PR number: 1ZA / 1ZD; Fitting Position: Front Axle	24.0125-0158.1 425158	Outer diameter [mm]: 312 Brake Disc Thickness [mm] 25 Minimum thickness [mm] 22 Brake Disc Type: Vented Supplementary Article/Info 2: with bolts/screws
			24.0325-0158.1 525158	Outer diameter [mm]: 312 Brake Disc Thickness [mm] 25 Minimum thickness [mm] 22 Brake Disc Type: Vented Supplementary Article/Info 2: with bolts/screws
		for PR number: 2ED; Vehicle Equipment: for vehicles with electric parking brake; Fitting Position: Rear Axle	24.0112-0210.1 412210	Outer diameter [mm]: 300 Brake Disc Thickness [mm] 12 Minimum thickness [mm] 10 Brake Disc Type: Solid Supplementary Article/Info 2: with bolts/screws
 Wheel Speed Sensor				
1.0 TFSI 1.2 TFSI	85 07/16→10/20 77 - 05/13→ 81	Fitting Position: Front Axle Left	24.0711-5273.3 360303	
		Fitting Position: Front Axle Right	24.0711-5274.3 360304	
1.4 TFSI 1.4 TFSI e-tron 1.4 TSI	90 - 09/12→ 103 110 05/14→10/20 110 05/14→10/20	Required quantity: 2; Comfort Equipment Variant (trim package): for cruise control system; Fitting Position: Rear Axle	2	24.0711-6337.3 360390
1.5 TFSI 1.6 TDI 1.8 TFSI 2.0 TDI 2.0 TFSI	110 05/17→10/18 77 - 10/12→ 85 132 09/12→ 81 - 09/12→10/20 135 140 05/16→10/20	Required quantity: 2; Vehicle Equipment: for vehicles with parking assistant system; Fitting Position: Rear Axle	2	24.0711-6337.3 360390
1.4 TFSI e-tron	150 05/14→10/20	Fitting Position: Front Axle Left	24.0711-5273.3 360303	
		Fitting Position: Front Axle Right	24.0711-5274.3 360304	
		Required quantity: 2; Comfort Equipment Variant (trim package): for cruise control system; Fitting Position: Rear Axle	2	24.0711-6337.3 360390
1.4 TFSI g-tron	81 11/13→10/20	Construction year from: 02/14 →; Fitting Position: Front Axle Left	24.0711-5273.3 360303	
		Construction year from: 02/14 →; Fitting Position: Front Axle Right	24.0711-5274.3 360304	
		Construction year from: 02/14 →; Required quantity: 2; Comfort Equipment Variant (trim package): for cruise control system; Fitting Position: Rear Axle	2	24.0711-6337.3 360390
		Construction year from: 02/14 →; Required quantity: 2; Vehicle Equipment: for vehicles with parking assistant system; Fitting Position: Rear Axle	2	24.0711-6337.3 360390
1.6 TDI quattro 1.8 TFSI quattro 2.0 TDI quattro	81 05/15→08/16 132 05/13→ 110 - 02/13→10/20 135	Fitting Position: Front Axle Left	24.0711-5273.3 360303	
		Fitting Position: Front Axle Right	24.0711-5274.3 360304	
2.0 TFSI quattro RS3 quattro	140 05/16→10/20 270 - 03/15→ 294	Vehicle Equipment: for vehicles with parking assistant system; Fitting Position: Rear Axle Left	24.0711-5401.3 360330	
S3 quattro	206 - 11/12→ 228	Comfort Equipment Variant (trim package): for cruise control system; Fitting Position: Rear Axle Left	24.0711-5401.3 360330	
		Comfort Equipment Variant (trim package): for cruise control system; Fitting Position: Rear Axle Right	24.0711-5402.3 360331	

	kW				
AUDI - A3 Sportback (8VA, 8VF) 09/12→					
 Wheel Speed Sensor					
1.6 TDI quattro	81	05/15→08/16	Vehicle Equipment: for vehicles with parking assistant system; Fitting Position: Rear Axle Right	24.0711-5402.3	360331
1.8 TFSI quattro	132	05/13→			
2.0 TDI quattro	110	02/13→10/20			
	135				
2.0 TFSI quattro	140	05/16→10/20			
RS3 quattro	270	03/15→			
	294				
S3 quattro	206	11/12→			
	228				
Control Element, parking brake caliper					
1.0 TFSI	85	07/16→10/20	for PR number: 1KE / 1KR / 1KZ; Fitting Position: Rear Axle Left	11.9282-1001.3	250159 Brake System: ATE
1.2 TFSI	77	05/13→			
	81				
1.4 TFSI	90	09/12→	for PR number: 1KE / 1KR / 1KZ; Fitting Position: Rear Axle Right	11.9282-1002.3	250160 Brake System: ATE
	103				
1.4 TFSI e-tron	110	05/14→10/20			
	150				
1.4 TFSI g-tron	81	11/13→10/20			
1.4 TSI	110	05/14→10/20			
1.5 TFSI	110	05/17→10/18			
1.6 TDI	77	10/12→			
	85				
1.6 TDI quattro	81	05/15→08/16			
1.8 TFSI	132	09/12→			
1.8 TFSI quattro	132	05/13→			
2.0 TDI	81	09/12→10/20			
	135				
2.0 TDI quattro	110	02/13→10/20			
	135				
2.0 TFSI	140	05/16→10/20			
2.0 TFSI quattro	140	05/16→10/20			
30 g-tron	96	11/18→10/20			
30 TDI	85	07/18→10/20			
30 TFSI	85	07/18→10/20			
35 TDI	110	07/18→10/20			
35 TFSI	110	10/18→10/20			
40 TDI quattro	135	07/18→10/20			
40 TFSI	140	07/18→10/20			
40 TFSI quattro	140	07/18→10/20			
RS3 quattro	270	03/15→			
	294				
S3 quattro	206	11/12→			
	228				
AUDI - A3 Sportback (8YA) 11/19→					
 Brake Disc					
30 g-tron	96	07/20→	for PR number: 1ZE; Fitting Position: Front Axle	24.0125-0145.1	425145 Outer diameter [mm]: 288 Brake Disc Thickness [mm] 25 Minimum thickness [mm] 22 Brake Disc Type: Vented Supplementary Article/Info 2: with bolts/screws
30 TDI	85	11/19→			
30 TFSI	81	06/20→			
30 TFSI Mild Hybrid	81	06/20→			
35 TDI	110	11/19→			
35 TFSI	110	11/19→			
35 TFSI Mild Hybrid	110	04/20→	for PR number: 1ZK / 1ZL / 1ZU; Fitting Position: Front Axle	24.0125-0158.1	425158 Outer diameter [mm]: 312 Brake Disc Thickness [mm] 25 Minimum thickness [mm] 22 Brake Disc Type: Vented Supplementary Article/Info 2: with bolts/screws
40 TDI quattro	147	12/20→			
40 TFSIe	110	06/20→			
40 TFSI quattro	140	07/21→			
45 TFSIe	110	07/21→			
S3 quattro	228	06/20→			
			for PR number: 1KE / 2EC / 2EJ; Fitting Position: Rear Axle	24.0110-0356.1	410356 Outer diameter [mm]: 272 Brake Disc Thickness [mm] 9.7 Minimum thickness [mm] 8 Brake Disc Type: Solid Supplementary Article/Info 2: with bolts/screws
 Wheel Speed Sensor					
30 g-tron	96	07/20→	Fitting Position: Front Axle Left	24.0711-5273.3	360303
30 TDI	85	11/19→	Fitting Position: Front Axle Right	24.0711-5274.3	360304
30 TFSI	81	06/20→			
30 TFSI Mild Hybrid	81	06/20→	Required quantity: 2; Fitting Position: Rear Axle	2	24.0711-6337.3 360390
35 TDI	110	11/19→			
35 TFSI	110	11/19→			
35 TFSI Mild Hybrid	110	04/20→			
40 TDI quattro	147	12/20→			
40 TFSIe	110	06/20→			
40 TFSI quattro	140	07/21→			
45 TFSIe	110	07/21→			
S3 quattro	228	06/20→			
RS3 quattro	294	07/21→	Fitting Position: Front Axle Left	24.0711-5273.3	360303
→					

	kW				
AUDI - A4 B5 (8D2) 11/94→12/01					
Guide Bolt, brake caliper					
2.4	121 03/97→11/00	Construction year from: 08/97 →; Required quantity: 2; Fitting Position: Front Axle	2	11.8171-0008.1 990049	Brake System: ATE
		→ Construction year to: 07/97; Required quantity: 2; Fitting Position: Front Axle	2	11.8171-0008.1 990049	Brake System: ATE
2.4 quattro	121 03/97→11/00	Construction year from: 08/97 →; Required quantity: 2; Fitting Position: Front Axle	2	11.8171-0008.1 990049	Brake System: ATE
2.5 TDI quattro	110 09/97→11/00	Construction year from: 11/97 →; Required quantity: 2; Fitting Position: Front Axle	2	11.8171-0008.1 990049	Brake System: ATE
2.8 quattro	128 01/95→07/97	→ Construction year to: 07/96; Required quantity: 2; Fitting Position: Front Axle	2	11.8171-0008.1 990049	Brake System: ATE
2.8 quattro	142 10/96→08/01	→ Construction year to: 04/01; Required quantity: 2; Fitting Position: Front Axle	2	11.8171-0008.1 990049	Brake System: ATE
AUDI - A4 B5 Avant (8D5) 11/94→12/02					
Guide Bolt, brake caliper					
1.6	74 - 11/94→09/01	→ Vehicle Identification Number to: 8D-V-054061; Required quantity: 2; Fitting Position: Front Axle	2	11.8171-0008.1 990049	Brake System: ATE
1.8	75				
1.8 quattro	85 - 07/95→09/01				
	92				
1.8 T	110 - 03/96→09/01	→ Construction year to: 04/01; Required quantity: 2;	2	11.8171-0008.1 990049	Brake System: ATE
1.8 T quattro	110 - 01/96→09/01	Fitting Position: Front Axle			
	132				
1.9 TDI	81 - 02/96→09/01				
	85				
1.9 TDI quattro	81 - 09/96→09/01				
	85				
2.4	120 08/97→09/01				
2.4 quattro	120 08/97→09/01				
2.5 TDI	110 09/97→09/01				
2.6	110 02/96→09/01				
2.6 quattro	110 01/96→09/01				
2.8	142 10/96→09/01				
2.8 quattro	142 10/96→09/01				
2.4	121 03/97→09/01	Construction year from: 08/97 → →	2	11.8171-0008.1 990049	Brake System: ATE
2.4 quattro	121 03/97→09/01	Construction year to: 04/01; Required quantity: 2; Fitting Position: Front Axle			
2.5 TDI quattro	110 09/97→09/01	Construction year from: 11/97 → → Construction year to: 04/01; Required quantity: 2; Fitting Position: Front Axle	2	11.8171-0008.1 990049	Brake System: ATE
2.8	128 - 03/96→09/00	Required quantity: 2;	2	11.8171-0008.1 990049	Brake System: ATE
2.8 quattro	140	Fitting Position: Front Axle			
2.8 quattro	140 03/99→09/00				
2.8 quattro	128 01/96→09/96	→ Construction year to: 07/96; Required quantity: 2; Fitting Position: Front Axle	2	11.8171-0008.1 990049	Brake System: ATE
RS4 quattro	280 05/00→09/01	Construction year from: 06/00 → → Construction year to: 04/01; Required quantity: 2	2	11.8171-0008.1 990049	Brake System: ATE
AUDI - A4 B6 (8E2) 11/00→12/05					
Guide Bolt, brake caliper					
1.6	75 11/00→12/04	Construction year from: 12/00 →;	2	11.8171-0008.1 990049	Brake System: ATE
1.8 T	110 11/00→07/02	for PR number: 1LB / 1LE;			
1.8 T quattro	110 11/00→07/02	Required quantity: 2			
1.9 TDI	96 11/00→12/04	Construction year from: 12/00 →;	2	11.8171-0008.1 990049	Brake System: ATE
2.0	96 11/00→12/04	for PR number: 1LF / 1LT;			
2.5 TDI quattro	132 11/00→12/04	Required quantity: 2			
3.0	162 11/00→12/04	Construction year from: 12/00 →;	2	11.8171-0008.1 990049	Brake System: ATE
3.0 quattro	162 11/00→12/04	for PR number: 1LA / 1LC; Required quantity: 2			
1.8 T	120 - 07/01→12/04	for PR number: 1LB / 1LE;	2	11.8171-0008.1 990049	Brake System: ATE
	140	Required quantity: 2			
1.8 T quattro	120 - 07/01→12/04	for PR number: 1LF / 1LT;	2	11.8171-0008.1 990049	Brake System: ATE
	140	Required quantity: 2			
1.9 TDI	74 - 05/01→12/04	for PR number: 1LA / 1LC;	2	11.8171-0008.1 990049	Brake System: ATE
	85	Required quantity: 2			
1.9 TDI quattro	96 11/01→12/04				
2.0 FSI	110 07/02→12/04				
→					

	kW				
AUDI - A4 B6 (8E2) 11/00→12/05					
Guide Bolt, brake caliper					
2.4	120 - 09/01→12/04 125	for PR number: 1LB / 1LE; Required quantity: 2	2	11.8171-0008.1 990049	Brake System: ATE
2.5 TDI	114 - 08/01→12/04 120	for PR number: 1LF / 1LT; Required quantity: 2	2	11.8171-0008.1 990049	Brake System: ATE
3.0	160 04/01→12/04	for PR number: 1LA / 1LC; Required quantity: 2	2	11.8171-0008.1 990049	Brake System: ATE
3.0 quattro	160 04/01→12/04	for PR number: 1LA / 1LC; Required quantity: 2	2	11.8171-0008.1 990049	Brake System: ATE
S4 quattro	253 03/03→12/04	→ Vehicle Identification Number to: 8H-7-900460; for PR number: 1LJ; Required quantity: 2	2	11.8171-0008.1 990049	Brake System: ATE
		Vehicle Identification Number from: 8H-7-900461 →; for PR number: 1LJ; Required quantity: 2	2	11.8171-0008.1 990049	Brake System: ATE
AUDI - A4 B6 Avant (8E5) 02/00→12/05					
Guide Bolt, brake caliper					
1.6	75 09/01→12/04	for PR number: 1LB / 1LE; Required quantity: 2	2	11.8171-0008.1 990049	Brake System: ATE
1.8 T	110 - 09/01→12/04 140	for PR number: 1LF / 1LT; Required quantity: 2	2	11.8171-0008.1 990049	Brake System: ATE
1.8 T quattro	110 - 09/01→12/04 140	for PR number: 1LA / 1LC; Required quantity: 2	2	11.8171-0008.1 990049	Brake System: ATE
1.9 TDI	74 - 09/01→12/04 96	for PR number: 1LA / 1LC; Required quantity: 2	2	11.8171-0008.1 990049	Brake System: ATE
1.9 TDI quattro	96 11/01→12/04				
2.0	96 09/01→12/04				
2.0 FSI	110 07/02→12/04				
2.4	120 - 09/01→12/04 125				
2.5 TDI	114 - 09/01→12/04 120				
2.5 TDI quattro	132 09/01→12/04				
3.0	160 - 04/01→12/04 162				
3.0 quattro	160 - 04/01→12/04 162				
S4 quattro	253 03/03→12/04	→ Vehicle Identification Number to: 8H-7-900460; for PR number: 1LJ; Required quantity: 2	2	11.8171-0008.1 990049	Brake System: ATE
		Vehicle Identification Number from: 8H-7-900461 →; for PR number: 1LJ; Required quantity: 2	2	11.8171-0008.1 990049	Brake System: ATE
AUDI - A4 B6 Convertible (8H7) 01/02→12/09					
Guide Bolt, brake caliper					
1.8 T	120 - 07/02→12/05 125	for PR number: 1LF / 1LT; Required quantity: 2	2	11.8171-0008.1 990049	Brake System: ATE
1.8 T quattro	120 05/03→12/05	for PR number: 1LB / 1LE; Required quantity: 2	2	11.8171-0008.1 990049	Brake System: ATE
2.0	96 09/04→12/05				
2.4	120 - 04/02→12/05 125	for PR number: 1LA; Required quantity: 2	2	11.8171-0008.1 990049	Brake System: ATE
2.5 TDI	120 08/02→12/05				
3.0	162 04/02→12/05				
3.0 quattro	162 05/03→12/05				
3.0	160 04/02→12/05	for PR number: 1LF / 1LT; Required quantity: 2	2	11.8171-0008.1 990049	Brake System: ATE
		for PR number: 1LB / 1LE; Required quantity: 2	2	11.8171-0008.1 990049	Brake System: ATE
		for PR number: 1LA / 1LC; Required quantity: 2	2	11.8171-0008.1 990049	Brake System: ATE
S4 quattro	253 03/04→12/05	Required quantity: 2	2	11.8171-0008.1 990049	Brake System: ATE
AUDI - A4 B7 (8EC) 11/04→06/08					
Guide Bolt, brake caliper					
1.6	75 11/04→06/08	for PR number: 1LB / 1LE; Required quantity: 2	2	11.8171-0008.1 990049	Brake System: ATE
1.8 T	120 11/04→06/08				
1.8 T quattro	120 11/04→06/08	for PR number: 1LF / 1LT; Required quantity: 2	2	11.8171-0008.1 990049	Brake System: ATE
1.9 TDI	85 11/04→06/08				
2.0	96 11/04→06/08				
2.0 TDI	89 - 11/04→06/08 125	for PR number: 1LA / 1LC; Required quantity: 2	2	11.8171-0008.1 990049	Brake System: ATE
2.0 TDI 16V	103 11/04→06/08				
2.0 TDI quattro	103 - 01/06→06/08 125				
2.0 TFSI	125 - 11/04→06/08 162				
2.0 TFSI quattro	147 - 11/04→06/08 162				
2.5 TDI	120 11/04→05/06				
→					

	kW				
AUDI - A4 B7 (8EC) 11/04→06/08					
Guide Bolt, brake caliper					
2.7 TDI	120 - 11/05→06/08		for PR number: 1LB / 1LE; Required quantity: 2	2	11.8171-0008.1 990049 Brake System: ATE
3.0	160 11/04→05/06		for PR number: 1LF / 1LT; Required quantity: 2	2	11.8171-0008.1 990049 Brake System: ATE
3.0 quattro	160 11/04→07/06		for PR number: 1LA / 1LC; Required quantity: 2	2	11.8171-0008.1 990049 Brake System: ATE
3.0 TDI quattro	150 - 11/04→06/08		for PR number: 1LA / 1LC; Required quantity: 2	2	11.8171-0008.1 990049 Brake System: ATE
3.2 FSI	188 01/05→06/08				
3.2 FSI quattro	188 01/05→06/08				
2.0 TDI	93 11/05→11/06		Construction year from: 06/06 →; for PR number: 1LF / 1LT; Required quantity: 2	2	11.8171-0008.1 990049 Brake System: ATE
			Construction year from: 06/06 →; for PR number: 1LA / 1LC; Required quantity: 2	2	11.8171-0008.1 990049 Brake System: ATE
			Construction year from: 06/06 →; for PR number: 1LB / 1LE; Required quantity: 2	2	11.8171-0008.1 990049 Brake System: ATE
S4 quattro	253 11/04→06/08		→ Vehicle Identification Number to: 8H-7-900460; for PR number: 1LJ; Required quantity: 2	2	11.8171-0008.1 990049 Brake System: ATE
			Vehicle Identification Number from: 8H-7-900461 →; for PR number: 1LJ; Required quantity: 2	2	11.8171-0008.1 990049 Brake System: ATE
AUDI - A4 B7 Avant (8ED) 11/04→06/08					
Guide Bolt, brake caliper					
1.6	75 11/04→06/08		for PR number: 1LA / 1LC; Required quantity: 2	2	11.8171-0008.1 990049 Brake System: ATE
1.8 T	120 11/04→06/08		for PR number: 1LB / 1LE; Required quantity: 2	2	11.8171-0008.1 990049 Brake System: ATE
1.8 T quattro	120 11/04→06/08		for PR number: 1LB / 1LE; Required quantity: 2	2	11.8171-0008.1 990049 Brake System: ATE
1.9 TDI	85 11/04→06/08		for PR number: 1LF / 1LT; Required quantity: 2	2	11.8171-0008.1 990049 Brake System: ATE
2.0	96 11/04→06/08		for PR number: 1LA / 1LC; Required quantity: 2	2	11.8171-0008.1 990049 Brake System: ATE
2.0 TDI	89 - 11/04→06/08		for PR number: 1LF / 1LT; Required quantity: 2	2	11.8171-0008.1 990049 Brake System: ATE
2.0 TDI 16V	103 11/04→06/08				
2.0 TDI quattro	103 - 01/06→06/08				
2.0 TFSI	125 - 11/04→06/08				
2.0 TFSI quattro	147 - 11/04→06/08				
2.5 TDI	120 11/04→05/06				
2.7 TDi	120 11/05→03/08				
2.7 TDI	132 01/06→06/08				
3.0	160 11/04→05/06				
3.0 quattro	160 11/04→07/06				
3.0 TDI quattro	150 - 11/04→06/08				
3.2 FSI	188 01/05→06/08				
3.2 FSI quattro	188 01/05→06/08				
2.0 TDI	93 11/05→11/06		Construction year from: 06/06 →; for PR number: 1LB / 1LE; Required quantity: 2	2	11.8171-0008.1 990049 Brake System: ATE
			Construction year from: 06/06 →; for PR number: 1LF / 1LT; Required quantity: 2	2	11.8171-0008.1 990049 Brake System: ATE
			Construction year from: 06/06 →; for PR number: 1LA / 1LC; Required quantity: 2	2	11.8171-0008.1 990049 Brake System: ATE
S4 quattro	253 11/04→06/08		→ Vehicle Identification Number to: 8H-7-900460; for PR number: 1LJ; Required quantity: 2	2	11.8171-0008.1 990049 Brake System: ATE
			Vehicle Identification Number from: 8H-7-900461 →; for PR number: 1LJ; Required quantity: 2	2	11.8171-0008.1 990049 Brake System: ATE
AUDI - A4 B7 Convertible (8HE) 01/02→12/09					
Guide Bolt, brake caliper					
1.8 T	120 01/06→03/09		for PR number: 1LB / 1LE; Required quantity: 2	2	11.8171-0008.1 990049 Brake System: ATE
			for PR number: 1LF / 1LT; Required quantity: 2	2	11.8171-0008.1 990049 Brake System: ATE
			for PR number: 1LA / 1LC; Required quantity: 2	2	11.8171-0008.1 990049 Brake System: ATE
2.0 TDI	100 - 01/06→03/09		→ Construction year to: 11/08; for PR number: 1LB / 1LE; Required quantity: 2	2	11.8171-0008.1 990049 Brake System: ATE
2.0 TFSI 16V	147 01/06→03/09				
2.7 TDI	132 06/06→03/09				
3.0 TDI quattro	150 - 01/06→03/09		→ Construction year to: 11/08; for PR number: 1LF / 1LT; Required quantity: 2	2	11.8171-0008.1 990049 Brake System: ATE
→	171				

	kW				
AUDI - A4 B7 Convertible (8HE) 01/02→12/09					
Guide Bolt, brake caliper					
3.2 FSI	188	01/06→03/09	→ Construction year to: 11/08;	2	11.8171-0008.1 990049 Brake System: ATE
3.2 FSI quattro	188	01/06→03/09	for PR number: 1LA; Required quantity: 2		
S4 quattro	253	11/05→03/09	→ Vehicle Identification Number to: 8H-7-900460; for PR number: 1LJ; Required quantity: 2	2	11.8171-0008.1 990049 Brake System: ATE
			Vehicle Identification Number from: 8H-7-900461 →; for PR number: 1LJ; Required quantity: 2	2	11.8171-0008.1 990049 Brake System: ATE
AUDI - A4 B8 (8K2) 08/07→12/15					
Guide Bolt, brake caliper					
1.8 T	110	07/08→05/10	for PR number: 1LT;	2	11.8171-0008.1 990049 Brake System: ATE
1.8 TFSI	88 - 118	11/07→12/15	Required quantity: 2; Fitting Position: Front Axle		
1.8 TFSI quattro	118	09/08→03/12	for PR number: 1LY;	2	11.8171-0008.1 990049 Brake System: ATE
2.0 TDI	88 - 140	11/07→12/15	Required quantity: 2; Fitting Position: Front Axle		
2.0 TDI quattro	105 - 140	01/08→12/15			
2.0 TFSI	132 - 165	06/08→12/15			
2.0 TFSI flexible fuel	132	11/09→12/15			
2.0 TFSI flexible fuel quattro	132	11/09→12/15			
2.0 TFSI quattro	132 - 165	06/08→12/15			
2.7 TDI	120 - 140	11/07→03/12			
3.0 TDI	150	11/11→12/15			
3.0 TDI quattro	155 - 180	11/07→12/15			
3.0 TFSI quattro	200	02/12→12/15			
3.2 FSI	195	09/08→03/12			
3.2 FSI quattro	195	11/07→03/12			
1.8 TFSI	125	11/11→12/15	Construction year from: 01/12 →;	2	11.8171-0008.1 990049 Brake System: ATE
1.8 TFSI quattro	125	11/11→12/15	for PR number: 1LT; Required quantity: 2; Fitting Position: Front Axle		
			Construction year from: 01/12 →;	2	11.8171-0008.1 990049 Brake System: ATE
			for PR number: 1LY; Required quantity: 2; Fitting Position: Front Axle		
AUDI - A4 B8 Avant (8K5) 11/07→12/15					
Guide Bolt, brake caliper					
1.8 TFSI	88	04/08→12/15	for PR number: 1LT; Required quantity: 2	2	11.8171-0008.1 990049 Brake System: ATE
1.8 TFSI quattro	118	09/08→03/12	for PR number: 1LY; Required quantity: 2	2	11.8171-0008.1 990049 Brake System: ATE
2.0 TDI	88 - 140	04/08→12/15			
2.0 TDI quattro	105 - 140	04/08→12/15			
2.0 TFSI	132 - 165	06/08→12/15			
2.0 TFSI flexible fuel	132	11/09→12/15			
2.0 TFSI flexible fuel quattro	132	11/09→12/15			
2.0 TFSI quattro	155 - 165	06/08→12/15			
2.7 TDI	120	06/08→03/12			
3.0 TDI	150	11/11→12/15			
3.0 TDI quattro	155 - 180	04/08→12/15			
3.0 TFSI quattro	200	02/12→12/15			
3.2 FSI	195	09/08→03/12			
3.2 FSI quattro	195	04/08→03/12			
1.8 TFSI	118	11/07→03/12	Construction year from: 04/08 →;	2	11.8171-0008.1 990049 Brake System: ATE
			for PR number: 1LT; Required quantity: 2		
			Construction year from: 04/08 →;	2	11.8171-0008.1 990049 Brake System: ATE
			for PR number: 1LY; Required quantity: 2		
1.8 TFSI	125	11/11→12/15	Construction year from: 01/12 →;	2	11.8171-0008.1 990049 Brake System: ATE
1.8 TFSI quattro	125	11/11→12/15	for PR number: 1LT; Required quantity: 2		
			Construction year from: 01/12 →;	2	11.8171-0008.1 990049 Brake System: ATE
			for PR number: 1LY; Required quantity: 2		
2.7 TDI	140	04/08→03/12	Construction year from: 06/08 →;	2	11.8171-0008.1 990049 Brake System: ATE
			for PR number: 1LT; Required quantity: 2		
			Construction year from: 06/08 →;	2	11.8171-0008.1 990049 Brake System: ATE
			for PR number: 1LY; Required quantity: 2		

	kW			
AUDI - A4 B9 (8W2, 8WC) 05/15→				
Guide Sleeve Kit, brake caliper				
1.4 TFSI	110 08/15→11/19	for PR number: 1LA / 1LB;		11.0101-5407.2 260011 Brake System: ATE
2.0 TDI	90 - 05/15→ 140	Fitting Position: Front Axle		
2.0 TDI quattro	110 - 09/15→11/19 140			
2.0 TFSI	140 - 05/15→ 185			
2.0 TFSI Mild Hybrid	185 05/17→11/19			
2.0 TFSI Mild Hybrid quattro	185 05/17→11/19			
2.0 TFSI quattro	183 - 05/15→ 185			
3.0 TDI	160 09/15→08/18			
3.0 TDI quattro	160 - 05/15→08/18 200			
30 TDI	90 05/16→11/19			
30 TDI Mild Hybrid	100 07/19→			
35 TDI	110 08/15→11/19			
35 TDI Mild Hybrid	120 03/19→			
35 TFSI Mild Hybrid	110 12/18→11/19			
40 TDI	140 05/15→11/19			
40 TDI Mild Hybrid	150 09/20→			
40 TDI Mild Hybrid quattro	150 05/20→			
40 TDI quattro	140 09/15→11/19			
40 TFSI Mild Hybrid	140 - 05/17→ 150			
40 TFSI Mild Hybrid quattro	150 06/20→			
45 TDI quattro	170 07/18→11/19			
45 TFSI Mild Hybrid	180 07/18→11/19			
45 TFSI Mild Hybrid quattro	180 - 07/18→ 195			
50 TDI Mild Hybrid quattro	210 08/20→			
50 TDI quattro	210 07/18→11/19			
S4 quattro	260 05/16→11/19			
S4 TDI Mild Hybrid quattro	251 - 05/19→ 255			
Guide Bolt, brake caliper				
1.4 TFSI	110 08/15→11/19	for PR number: 1LA / 1LB;	2	11.8171-0008.1 990049 Brake System: ATE
2.0 TDI	90 - 05/15→ 140	Required quantity: 2		
2.0 TDI quattro	110 - 09/15→11/19 140			
2.0 TFSI	140 - 05/15→ 185			
2.0 TFSI Mild Hybrid	185 05/17→11/19			
2.0 TFSI Mild Hybrid quattro	185 05/17→11/19			
2.0 TFSI quattro	183 - 05/15→ 185			
3.0 TDI	160 09/15→08/18			
3.0 TDI quattro	160 - 05/15→08/18 200			
30 TDI	90 05/16→11/19			
30 TDI Mild Hybrid	100 07/19→			
35 TDI	110 08/15→11/19			
35 TDI Mild Hybrid	120 03/19→			
35 TFSI Mild Hybrid	110 12/18→11/19			
40 TDI	140 05/15→11/19			
40 TDI Mild Hybrid	150 09/20→			
40 TDI Mild Hybrid quattro	150 05/20→			
40 TDI quattro	140 09/15→11/19			
40 TFSI Mild Hybrid	140 - 05/17→ 150			
40 TFSI Mild Hybrid quattro	150 06/20→			
45 TDI quattro	170 07/18→11/19			
45 TFSI Mild Hybrid	180 07/18→11/19			
45 TFSI Mild Hybrid quattro	180 - 07/18→ 195			
50 TDI Mild Hybrid quattro	210 08/20→			
50 TDI quattro	210 07/18→11/19			
S4 quattro	260 05/16→11/19			
S4 TDI Mild Hybrid quattro	251 - 05/19→ 255			

	kW			
AUDI - A4 B9 Avant (8W5, 8WD) 08/15→				
Guide Sleeve Kit, brake caliper				
1.4 TFSI	110 02/16→10/19	for PR number: 1LA / 1LB;		11.0101-5407.2 260011 Brake System: ATE
2.0 TDI	90 - 08/15→10/19	Fitting Position: Front Axle		
	140			
2.0 TDI quattro	110 - 10/15→10/19			
	140			
2.0 TFSI	140 - 08/15→			
	185			
2.0 TFSI g-tron	125 11/16→10/19			
2.0 TFSI Mild Hybrid	185 05/17→10/19			
2.0 TFSI Mild Hybrid quattro	185 11/18→			
2.0 TFSI quattro	183 - 08/15→10/19			
	185			
3.0 TDI	160 10/15→08/18			
3.0 TDI quattro	160 - 08/15→08/18			
	200			
30 TDI	90 10/18→10/19			
30 TDI Mild Hybrid	100 07/19→			
35 TDI	110 10/18→10/19			
35 TDI Mild Hybrid	120 07/19→			
35 TFSI Mild Hybrid	110 12/18→10/19			
40 TDI	140 10/18→05/19			
40 TDI Mild Hybrid	150 09/20→			
40 TDI Mild Hybrid quattro	150 05/20→			
40 TDI quattro	140 10/18→09/20			
40 TFSI g-tron	125 11/16→10/19			
40 TFSI Mild Hybrid	140 - 05/17→			
	150			
40 TFSI Mild Hybrid quattro	150 06/20→			
45 TDI quattro	170 07/18→10/19			
45 TFSI Mild Hybrid	180 07/18→10/19			
45 TFSI Mild Hybrid quattro	180 - 07/18→			
	195			
50 TDI Mild Hybrid quattro	210 08/20→			
50 TDI quattro	210 07/18→10/19			
S4 quattro	260 05/16→10/19			
S4 TDI Mild Hybrid quattro	251 - 05/19→			
	255			
Guide Bolt, brake caliper				
1.4 TFSI	110 02/16→10/19	for PR number: 1LA / 1LB;	2	11.8171-0008.1 990049 Brake System: ATE
2.0 TDI	90 - 08/15→10/19	Required quantity: 2		
	140			
2.0 TDI quattro	110 - 10/15→10/19			
	140			
2.0 TFSI	140 - 08/15→			
	185			
2.0 TFSI g-tron	125 11/16→10/19			
2.0 TFSI Mild Hybrid	185 05/17→10/19			
2.0 TFSI Mild Hybrid quattro	185 11/18→			
2.0 TFSI quattro	183 - 08/15→10/19			
	185			
3.0 TDI	160 10/15→08/18			
3.0 TDI quattro	160 - 08/15→08/18			
	200			
30 TDI	90 10/18→10/19			
30 TDI Mild Hybrid	100 07/19→			
35 TDI	110 10/18→10/19			
35 TDI Mild Hybrid	120 07/19→			
35 TFSI Mild Hybrid	110 12/18→10/19			
40 TDI	140 10/18→05/19			
40 TDI Mild Hybrid	150 09/20→			
40 TDI Mild Hybrid quattro	150 05/20→			
40 TDI quattro	140 10/18→09/20			
40 TFSI g-tron	125 11/16→10/19			
40 TFSI Mild Hybrid	140 - 05/17→			
	150			
40 TFSI Mild Hybrid quattro	150 06/20→			
45 TDI quattro	170 07/18→10/19			
45 TFSI Mild Hybrid	180 07/18→10/19			
45 TFSI Mild Hybrid quattro	180 - 07/18→			
	195			
50 TDI Mild Hybrid quattro	210 08/20→			
50 TDI quattro	210 07/18→10/19			
S4 quattro	260 05/16→10/19			
S4 TDI Mild Hybrid quattro	251 - 05/19→			
	255			



	kW				
AUDI - A5 (8T3) 06/07→01/17					
Guide Bolt, brake caliper					
1.8 TFSI	118 - 10/07→01/17 130	for PR number: 1LT; Required quantity: 2	2	11.8171-0008.1 990049	Brake System: ATE
2.0 TDI	125 - 08/08→01/17 140				
2.0 TDI quattro	125 - 08/08→01/17 140				
2.0 TFSI	132 - 06/08→01/17 169				
2.0 TFSI quattro	155 - 06/08→01/17 169				
2.7 TDI	120 - 06/07→03/12 140				
3.0 TDI	150 10/11→01/17				
3.0 TDI quattro	155 - 06/07→01/17 180				
3.0 TFSI quattro	200 12/11→01/17				
3.2 FSI	195 06/07→03/12				
3.2 FSI quattro	195 06/07→03/12				
2.0 TDI	120 08/08→01/17	Construction year from: 10/08 →; for PR number: 1LT; Required quantity: 2	2	11.8171-0008.1 990049	Brake System: ATE
2.0 TFSI quattro	162 03/12→01/17	Construction year from: 05/13 →; for PR number: 1LT; Required quantity: 2	2	11.8171-0008.1 990049	Brake System: ATE
AUDI - A5 Convertible (8F7) 02/09→01/17					
Guide Bolt, brake caliper					
1.8 TFSI	118 - 09/09→01/17 130	for PR number: 1LT; Required quantity: 2	2	11.8171-0008.1 990049	Brake System: ATE
2.0 TDI	110 - 05/09→01/17 140				
2.0 TDI quattro	130 - 01/12→01/17 140				
2.0 TFSI	132 - 03/09→01/17 169				
2.0 TFSI quattro	155 - 03/09→01/17 169				
2.7 TDI	120 - 03/09→03/12 140				
3.0 TDI	150 10/11→01/17				
3.0 TDI quattro	160 - 03/09→01/17 180				
3.0 TFSI quattro	200 11/11→01/17				
3.2 FSI	195 03/09→03/12				
3.2 FSI quattro	195 03/09→03/12				
2.0 TDI	105 10/11→05/15	Construction year from: 11/11 →; for PR number: 1LT; Required quantity: 2	2	11.8171-0008.1 990049	Brake System: ATE
2.0 TFSI quattro	162 03/12→01/17	Construction year from: 05/13 →; for PR number: 1LT; Required quantity: 2	2	11.8171-0008.1 990049	Brake System: ATE
AUDI - A5 Sportback (8TA) 07/07→01/17					
Guide Bolt, brake caliper					
1.8 TFSI	106 - 11/09→01/17 130	for PR number: 1LT; Required quantity: 2	2	11.8171-0008.1 990049	Brake System: ATE
2.0 TDI	100 - 09/09→01/17 140				
2.0 TDI quattro	125 - 09/09→01/17 140				
2.0 TFSI	132 - 09/09→01/17 169				
2.0 TFSI quattro	155 - 09/09→01/17 169				
2.7 TDI	120 - 09/09→03/12 140				
3.0 TDI	150 10/11→01/17				
3.0 TDI quattro	160 - 09/09→01/17 180				
3.0 TFSI quattro	200 12/11→01/17				
3.2 FSI quattro	195 09/09→03/12				
AUDI - A6 Allroad C6 (4FH) 03/06→08/11					
Guide Bolt, brake caliper					
2.7 TDI quattro	120 - 05/06→08/11 140	→ Construction year to: 05/11; for PR number: 1LG; Required quantity: 2	2	11.8171-0008.1 990049	Brake System: ATE
3.0 TDI quattro	155 - 05/06→08/11 176				
3.0 TFSI quattro	213 10/08→08/11	→ Construction year to: 05/11; for PR number: 1ZL; Required quantity: 2	2	11.8171-0008.1 990049	Brake System: ATE
2.7 TDI quattro	132 03/06→10/08	for PR number: 1LG; Required quantity: 2	2	11.8171-0008.1 990049	Brake System: ATE
3.0 TDI quattro	171 05/06→10/08				
3.2 FSI quattro	188 05/06→10/08				
4.2 FSI quattro	257 05/06→12/10	for PR number: 1ZL; Required quantity: 2	2	11.8171-0008.1 990049	Brake System: ATE



	kW				
AUDI - A6 C4 (4A2) 06/94→10/97					
Guide Bolt, brake caliper					
1.8	92	12/95→10/97	Required quantity: 2; Fitting Position: Front Axle	2	11.8171-0008.1 990049 Brake System: ATE
1.9 TDI	66	06/94→10/97			
2.0	74	06/94→10/97			
	85				
2.0 16V	103	06/94→10/97			
2.3	98	06/94→12/95			
2.4	110	07/95→06/96			
2.5 TDI	85	06/94→10/97			
2.6	102	06/94→10/97			
	110				
2.8	120	06/94→10/97			
	142				
1.8 quattro	92	12/95→10/97	Required quantity: 2	2	11.8171-0008.1 990049 Brake System: ATE
2.0 16V quattro	103	06/94→10/97			
2.5 TDI quattro	103	10/95→10/97			
2.6 quattro	110	06/94→10/97			
2.8 quattro	128	06/94→10/97			
	142				
2.3 quattro	98	06/94→12/95	Construction year from: 08/94 →; Required quantity: 2	2	11.8171-0008.1 990049 Brake System: ATE
2.5 TDI	103	08/94→10/97	Construction year from: 10/94 →; Required quantity: 2; Fitting Position: Front Axle	2	11.8171-0008.1 990049 Brake System: ATE
AUDI - A6 C4 Avant (4A5) 06/94→12/97					
Guide Bolt, brake caliper					
1.8	92	12/95→12/97	Required quantity: 2; Fitting Position: Front Axle	2	11.8171-0008.1 990049 Brake System: ATE
1.9 TDI	66	06/94→12/97			
2.0	74	06/94→12/97			
	85				
2.0 16V	103	06/94→12/97			
2.3	98	06/94→12/95			
2.5 TDI	85	06/94→12/97			
2.6	102	06/94→12/97			
	110				
2.8	128	06/94→12/97			
	142				
1.8 quattro	92	12/95→12/97	Required quantity: 2	2	11.8171-0008.1 990049 Brake System: ATE
2.0 16V quattro	103	06/94→12/97			
2.5 TDI quattro	103	07/95→12/97			
2.6 quattro	110	06/94→12/97			
2.8 quattro	128	06/94→12/97			
	142				
2.3 quattro	98	06/94→12/95	Construction year from: 08/94 →; Required quantity: 2	2	11.8171-0008.1 990049 Brake System: ATE
2.5 TDI	103	08/94→12/97	Construction year from: 10/94 →; Required quantity: 2; Fitting Position: Front Axle	2	11.8171-0008.1 990049 Brake System: ATE
AUDI - A6 C5 (4B2) 01/97→12/05					
Guide Bolt, brake caliper					
1.8	85	05/97→01/05	Vehicle Identification Number from: 4B-2-031501 →; for PR number: 1LB / 1LE; Required quantity: 2	2	11.8171-0008.1 990049 Brake System: ATE
1.8 T	92	12/97→01/05			
1.8 T quattro	132	12/97→01/05			
1.9 TDI	81	04/97→01/05	Vehicle Identification Number from: 4B-2-031501 →; for PR number: 1LF / 1LT; Required quantity: 2	2	11.8171-0008.1 990049 Brake System: ATE
	96	08/01→01/05			
2.0	100	07/98→01/05			
2.4	125	07/98→01/05			
2.4 quattro	115	08/98→01/05	→ Vehicle Identification Number to: 4B-2-031500; for PR number: 1LB / 1LE; Required quantity: 2; Fitting Position: Front Axle	2	11.8171-0008.1 990049 Brake System: ATE
	125	07/97→01/05			
2.5 TDI	110	07/97→01/05			
2.5 TDI quattro	110	07/97→01/05	→ Vehicle Identification Number to: 4B-2-031500; for PR number: 1LF / 1LT; Required quantity: 2; Fitting Position: Front Axle	2	11.8171-0008.1 990049 Brake System: ATE
	132	10/97→01/05			
2.8	132	10/97→01/05			
	140				
2.8 quattro	132	01/98→05/01			
	140				
1.8 T	110	01/97→01/05	Vehicle Identification Number from: 4B-2-031501 →; for PR number: 1LB / 1LE; Required quantity: 2	2	11.8171-0008.1 990049 Brake System: ATE
1.8 T quattro	110	02/97→01/05			
2.4	115	02/97→01/05			
	121				
2.4 quattro	120	02/97→01/05	Vehicle Identification Number from: 4B-2-031501 →; for PR number: 1LF / 1LT; Required quantity: 2	2	11.8171-0008.1 990049 Brake System: ATE
	121	02/97→01/05			
2.8	142	02/97→01/05			
2.8 quattro	142	02/97→01/05			
			Construction year from: 04/97 →; → Vehicle Identification Number to:	2	11.8171-0008.1 990049 Brake System: ATE
→					



	kW				
AUDI - A6 C5 (4B2) 01/97→12/05					
Guide Bolt, brake caliper					
1.8 T	110 01/97→01/05	4B-2-031500; for PR number: 1LB / 1LE;			
1.8 T quattro	110 02/97→01/05	Required quantity: 2;			
2.4	115 - 02/97→01/05	Fitting Position: Front Axle			
2.4 quattro	121	Construction year from: 04/97 →;	2	11.8171-0008.1 990049	Brake System: ATE
	120 - 02/97→01/05	→ Vehicle Identification Number to:			
2.8	121	4B-2-031500; for PR number: 1LF / 1LT;			
2.8 quattro	142 02/97→01/05	Required quantity: 2;			
	142 02/97→01/05	Fitting Position: Front Axle			
3.0	160 - 06/01→01/05	Required quantity: 2	2	11.8171-0008.1 990049	Brake System: ATE
3.0 quattro	160 - 06/01→01/05				
	162				
3.7	191 03/99→01/05				
3.7 quattro	191 03/99→01/05				
AUDI - A6 C5 Avant (4B5) 11/97→01/05					
Guide Bolt, brake caliper					
1.8	85 - 12/97→01/05	Vehicle Identification Number from:	2	11.8171-0008.1 990049	Brake System: ATE
	92	4B-2-031501 →;			
1.8 T	110 - 12/97→01/05	for PR number: 1LB / 1LE;			
	132	Required quantity: 2			
1.8 T quattro	110 - 12/97→01/05	Vehicle Identification Number from:	2	11.8171-0008.1 990049	Brake System: ATE
	132	4B-2-031501 →;			
1.9 TDI	81 - 02/98→01/05	for PR number: 1LF / 1LT;			
	96	Required quantity: 2			
2.0	96 08/01→01/05	→ Vehicle Identification Number to:	2	11.8171-0008.1 990049	Brake System: ATE
2.4	100 - 12/97→01/05	4B-2-031500; for PR number: 1LB / 1LE;			
	125	Required quantity: 2;			
2.4 quattro	115 - 12/97→01/05	Fitting Position: Front Axle			
	125				
2.5 TDI	110 - 12/97→01/05	→ Vehicle Identification Number to:	2	11.8171-0008.1 990049	Brake System: ATE
	132	4B-2-031500; for PR number: 1LF / 1LT;			
2.5 TDI quattro	110 - 12/97→01/05	Required quantity: 2;			
	132	Fitting Position: Front Axle			
2.8	132 - 12/97→01/05				
	142				
2.8 quattro	142 12/97→01/05				
3.0	160 - 06/01→01/05	Required quantity: 2	2	11.8171-0008.1 990049	Brake System: ATE
	162				
3.0 quattro	160 - 06/01→01/05				
	162				
3.7	191 03/99→01/05				
3.7 quattro	191 03/99→01/05				
AUDI - A6 C6 (4F2) 04/04→08/11					
Guide Bolt, brake caliper					
2.0 TDI	89 - 07/04→10/08	for PR number: 1LT; Required quantity: 2	2	11.8171-0008.1 990049	Brake System: ATE
	103				
2.0 TFSI	125 06/05→03/11	for PR number: 1LG / 1LD;	2	11.8171-0008.1 990049	Brake System: ATE
2.4	130 05/04→10/08	Required quantity: 2			
2.4 quattro	130 01/05→10/08	for PR number: 1ZL / 1LH;	2	11.8171-0008.1 990049	Brake System: ATE
2.7 TDI	120 - 11/04→03/11	Required quantity: 2			
	132				
2.7 TDI quattro	120 - 11/04→03/11				
	132				
2.8 FSI	154 11/06→10/08				
2.8 FSI quattro	154 06/07→10/08				
3.0	160 08/04→05/06				
3.0 quattro	160 05/04→05/06				
3.0 TDI quattro	155 - 05/04→03/11				
	171				
3.2 FSI	188 - 05/04→03/11				
	195				
3.2 FSI quattro	183 - 05/04→10/08				
	188				
4.2 FSI quattro	257 06/06→03/11				
4.2 quattro	246 05/04→05/06				
2.0 TDI	100 07/04→03/11	Construction year from: 06/05 →;	2	11.8171-0008.1 990049	Brake System: ATE
		for PR number: 1LT; Required quantity: 2			
		Construction year from: 06/05 →;	2	11.8171-0008.1 990049	Brake System: ATE
		for PR number: 1LG / 1LD;			
		Required quantity: 2			
		Construction year from: 06/05 →;	2	11.8171-0008.1 990049	Brake System: ATE
		for PR number: 1ZL / 1LH;			
		Required quantity: 2			
2.0 TDI	120 - 11/08→03/11	for PR number: 1LT; Required quantity: 2	2	11.8171-0008.1 990049	Brake System: ATE
	125				
2.7 TDI	140 10/08→03/11	for PR number: 1LG;	2	11.8171-0008.1 990049	Brake System: ATE
2.7 TDI quattro	140 10/08→03/11	Required quantity: 2			
2.8 FSI	140 - 10/08→03/11	for PR number: 1ZL; Required quantity: 2	2	11.8171-0008.1 990049	Brake System: ATE
	162				



AUDI - A6 C6 (4F2) 04/04→08/11							
Guide Bolt, brake caliper							
2.8 FSI quattro	140 - 10/08→03/11 162		for PR number: 1LT; Required quantity: 2	2	11.8171-0008.1	990049	Brake System: ATE
3.0 TDI quattro	176 10/08→03/11		for PR number: 1LG; Required quantity: 2	2	11.8171-0008.1	990049	Brake System: ATE
3.0 TFSI quattro	213 - 10/08→03/11 220		for PR number: 1ZL; Required quantity: 2	2	11.8171-0008.1	990049	Brake System: ATE
AUDI - A6 C6 Avant (4F5) 11/04→08/11							
Guide Bolt, brake caliper							
2.0 TDI	89 - 06/05→08/11 103		for PR number: 1LT; Required quantity: 2	2	11.8171-0008.1	990049	Brake System: ATE
2.0 TFSI	125 06/05→08/11		for PR number: 1LG / 1LD; Required quantity: 2	2	11.8171-0008.1	990049	Brake System: ATE
2.4	130 03/05→10/08						
2.4 quattro	130 03/05→10/08		for PR number: 1ZL / 1LH; Required quantity: 2	2	11.8171-0008.1	990049	Brake System: ATE
2.7 TDI	120 - 03/05→08/11 132						
2.7 TDI quattro	120 - 11/04→08/11 132						
2.8 FSI	154 11/06→10/08						
2.8 FSI quattro	154 06/07→10/08						
3.0	160 03/05→05/06						
3.0 quattro	160 03/05→05/06						
3.0 TDI quattro	155 - 03/05→08/11 171						
3.2 FSI	188 03/05→10/08						
3.2 FSI quattro	188 03/05→10/08						
4.2 FSI quattro	257 06/06→08/11						
4.2 quattro	246 03/05→05/06						
2.0 TDI	120 - 10/08→08/11 125		for PR number: 1LT; Required quantity: 2	2	11.8171-0008.1	990049	Brake System: ATE
2.7 TDI	140 10/08→08/11		for PR number: 1ZL; Required quantity: 2	2	11.8171-0008.1	990049	Brake System: ATE
2.7 TDI quattro	140 10/08→08/11		for PR number: 1LG;	2	11.8171-0008.1	990049	Brake System: ATE
2.8 FSI	140 - 10/08→08/11 162		Required quantity: 2				
2.8 FSI quattro	140 - 10/08→08/11 162						
3.0 TDI quattro	176 10/08→08/11						
3.0 TFSI quattro	213 - 10/08→08/11 220						
AUDI - A8 D2 (4D2, 4D8) 03/94→12/05							
Guide Bolt, brake caliper							
6.0 W12 quattro	309 01/01→09/02		Required quantity: 2	2	11.8171-0008.1	990049	Brake System: ATE
AUDI - A8 D3 (4E2, 4E8) 10/02→12/10							
Guide Bolt, brake caliper							
2.8 FSI	154 08/07→07/10		→ Construction year to: 10/09; for PR number: 1LG; Required quantity: 2	2	11.8171-0008.1	990049	Brake System: ATE
3.0	160 - 07/03→05/06 162		→ Vehicle Identification Number to: 4E-5-003250; for PR number: 1LG; Required quantity: 2	2	11.8171-0008.1	990049	Brake System: ATE
3.0 quattro	160 - 07/03→05/05 162						
4.0 TDI quattro	202 05/03→07/05		Vehicle Identification Number from: 4E-5-003251 →; for PR number: 1LG; Required quantity: 2	2	11.8171-0008.1	990049	Brake System: ATE
3.0 TDI quattro	155 11/03→07/10		→ Vehicle Identification Number to: 4E-5-003250; for PR number: 1LG; Required quantity: 2	2	11.8171-0008.1	990049	Brake System: ATE
3.2 FSI	191 06/05→07/10						
3.2 FSI quattro	191 06/05→07/10						
4.2 FSI quattro	257 06/06→07/10						
4.2 TDI quattro	240 07/05→07/10		Vehicle Identification Number from: 4E-5-003251 →; → Construction year to: 10/09; for PR number: 1LG; Required quantity: 2	2	11.8171-0008.1	990049	Brake System: ATE
3.0 TDI quattro	171 08/03→07/10		Construction year from: 11/03 →; for PR number: 1LG; → Vehicle Identification Number to: 4E-5-003250; Required quantity: 2	2	11.8171-0008.1	990049	Brake System: ATE
			Vehicle Identification Number from: 4E-5-003251 →; → Construction year to: 10/09; for PR number: 1LG; Required quantity: 2	2	11.8171-0008.1	990049	Brake System: ATE
3.7 quattro	206 10/02→05/06		Construction year from: 11/02 →; for PR number: 1LG; → Vehicle Identification Number to: 4E-5-003250; Required quantity: 2	2	11.8171-0008.1	990049	Brake System: ATE
			Vehicle Identification Number from: 4E-5-003251 →; for PR number: 1LG; Required quantity: 2	2	11.8171-0008.1	990049	Brake System: ATE
→							





	kW				
AUDI - A8 D3 (4E2, 4E8) 10/02→12/10					
Guide Bolt, brake caliper					
4.2 quattro	246	10/02→07/10	Construction year from: 11/02 →; for PR number: 1LG; → Vehicle Identification Number to: 4E-5-003250; Required quantity: 2	2	11.8171-0008.1 990049 Brake System: ATE
			Vehicle Identification Number from: 4E-5-003251 →; → Construction year to: 10/09; for PR number: 1LG; Required quantity: 2	2	11.8171-0008.1 990049 Brake System: ATE
4.2 TDI quattro	235	01/05→06/05	Vehicle Identification Number from: 4E-5-003251 →; for PR number: 1LG; Required quantity: 2	2	11.8171-0008.1 990049 Brake System: ATE
6.0 W12 quattro	331	12/03→07/10	Vehicle Identification Number from: 4E-5-003251 →; → Construction year to: 10/09; for PR number: 1LG; Required quantity: 2	2	11.8171-0008.1 990049 Brake System: ATE
			Construction year from: 02/04 →; for PR number: 1LG; → Vehicle Identification Number to: 4E-5-003250; Required quantity: 2	2	11.8171-0008.1 990049 Brake System: ATE
AUDI - ALLROAD C5 (4BH) 05/00→08/05					
Guide Bolt, brake caliper					
2.5 TDI quattro	120	05/00→08/05	for PR number: 1LA; → Construction year to: 07/05; Required quantity: 2	2	11.8171-0008.1 990049 Brake System: ATE
2.7 quattro	187	09/00→08/05			
2.7 T quattro	184	05/00→08/05			
4.2 V8 quattro	220	07/02→08/05			
AUDI - CABRIOLET B3 (8G7) 05/91→08/00					
Guide Bolt, brake caliper					
2.3 E	98	05/91→07/94	Construction year from: 07/91 →; → Vehicle Identification Number to: 8G- N-025000; Required quantity: 2; Fitting Position: Front Axle	2	11.8171-0008.1 990049 Brake System: ATE
AUDI - COUPE B3 (89, 8B3) 10/88→12/96					
Guide Bolt, brake caliper					
1.8	82	08/89→07/91	Required quantity: 2;	2	11.8171-0008.1 990049 Brake System: ATE
2.0	82	05/89→07/90	Fitting Position: Front Axle		
	83				
2.0 16 V	101	01/92→07/92			
2.0 20 V	118	08/89→07/91			
2.2 quattro	100	11/88→07/91			
2.6 quattro	110	08/92→12/96			
2.0	85	05/89→12/96	→ Construction year to: 07/92;	2	11.8171-0008.1 990049 Brake System: ATE
2.3	98	03/90→12/96	Required quantity: 2;		
2.3 quattro	98	11/88→12/96	Fitting Position: Front Axle		
	100				
2.3	100	10/88→07/94	Construction year from: 11/88 → → Construction year to: 07/92; Required quantity: 2; Fitting Position: Front Axle	2	11.8171-0008.1 990049 Brake System: ATE
AUDI - E-TRON (GEN) 09/18→					
Warning Contact, brake pad wear					
50 quattro	230	09/19→	for PR number: 1LE / 1LF / 1ZK;	2	24.8190-0827.2 620827
55 quattro	300	09/18→	Required quantity: 2;		
S quattro	226	09/20→	Fitting Position: Front Axle		
	370				
AUDI - E-TRON GT Saloon (F83) 07/20→					
Warning Contact, brake pad wear					
GT quattro	350	11/20→	for PR number: 1LE / 1LF / 1ZK;	2	24.8190-0827.2 620827
RS quattro	440	02/21→	Required quantity: 2; Fitting Position: Front Axle		
AUDI - E-TRON Sportback (GEA) 09/19→					
Warning Contact, brake pad wear					
50 quattro	230	09/19→	for PR number: 1LE / 1LF / 1ZK;	2	24.8190-0827.2 620827
55 quattro	300	09/19→	Required quantity: 2;		
S quattro	226	09/20→	Fitting Position: Front Axle		
	370				



	kW				
AUDI - Q2 (GAB, GAG) 06/16→					
 Brake Caliper					
1.0 TFSI	85 10/16→10/20	for PR number: 1ZD; for PR number: 1ZK; Fitting Position: Front Axle Left		24.3571-1801.5 241387	Supplementary Article/Supplementary Info: without holder Brake Caliper Type: Fist-type Caliper
1.4 TFSI	110 06/16→08/18				
1.6 TDI	85 06/16→10/18				
2.0 TDI	110 09/16→				
2.0 TDI quattro	110 - 07/16→	for PR number: 1ZD; for PR number: 1ZK; Fitting Position: Front Axle Right		24.3571-1802.5 241388	Supplementary Article/Supplementary Info: without holder Brake Caliper Type: Fist-type Caliper
	140				
2.0 TFSI quattro	140 05/17→				
30 TDI	85 07/18→				
30 TFSI	81 - 07/18→				
	85				
35 TDI	110 09/16→				
35 TDI quattro	110 09/18→				
35 TFSI	110 07/18→				
40 TFSI quattro	140 09/18→				
SQ2 TFSI quattro	221 08/18→				
Guide Sleeve Kit, brake caliper					
1.0 TFSI	85 10/16→10/20	for PR number: 1KJ / 1KY; Fitting Position: Rear Axle		11.0101-5407.2 260011	Brake System: ATE
1.4 TFSI	110 06/16→08/18				
1.6 TDI	85 06/16→10/18				
2.0 TDI	110 09/16→				
2.0 TDI quattro	110 - 07/16→				
	140				
2.0 TFSI quattro	140 05/17→				
30 TDI	85 07/18→				
30 TFSI	81 - 07/18→				
	85				
35 TDI	110 09/16→				
35 TDI quattro	110 09/18→				
35 TFSI	110 07/18→				
40 TFSI quattro	140 09/18→				
SQ2 TFSI quattro	221 08/18→				
Guide Bolt, brake caliper					
1.0 TFSI	85 10/16→10/20	for PR number: 1KJ / 1KY; Required quantity: 2; Fitting Position: Rear Axle	2	11.8171-0008.1 990049	Brake System: ATE
1.4 TFSI	110 06/16→08/18				
1.6 TDI	85 06/16→10/18				
2.0 TDI	110 09/16→				
2.0 TDI quattro	110 - 07/16→				
	140				
2.0 TFSI quattro	140 05/17→				
30 TDI	85 07/18→				
30 TFSI	81 - 07/18→				
	85				
35 TDI	110 09/16→				
35 TDI quattro	110 09/18→				
35 TFSI	110 07/18→				
40 TFSI quattro	140 09/18→				
SQ2 TFSI quattro	221 08/18→				
 Brake Disc					
1.0 TFSI	85 10/16→10/20	for PR number: 1ZE / 1ZJ; Fitting Position: Front Axle		24.0125-0145.1 425145	Outer diameter [mm]: 288 Brake Disc Thickness [mm] 25 Minimum thickness [mm] 22 Brake Disc Type: Vented Supplementary Article/Info 2: with bolts/screws
1.4 TFSI	110 06/16→08/18				
1.6 TDI	85 06/16→10/18				
2.0 TDI	110 09/16→				
2.0 TDI quattro	110 - 07/16→	for PR number: 1ZA / 1ZB / 1ZD / 1ZK / 1ZU; Fitting Position: Front Axle		24.0125-0158.1 425158	Outer diameter [mm]: 312 Brake Disc Thickness [mm] 25 Minimum thickness [mm] 22 Brake Disc Type: Vented Supplementary Article/Info 2: with bolts/screws
	140				
2.0 TFSI quattro	140 05/17→				
30 TDI	85 07/18→				
30 TFSI	81 - 07/18→				
	85				
35 TDI	110 09/16→				
35 TDI quattro	110 09/18→				
35 TFSI	110 07/18→				
40 TFSI quattro	140 09/18→				
SQ2 TFSI quattro	221 08/18→	for PR number: 1ZA / 1ZD / 1ZK / 1ZU; Fitting Position: Front Axle		24.0325-0158.1 525158	Outer diameter [mm]: 312 Brake Disc Thickness [mm] 25 Minimum thickness [mm] 22 Brake Disc Type: Vented Supplementary Article/Info 2: with bolts/screws
		for PR number: 1KE / 1KR / 2EJ / 0N4 / 2EL; Fitting Position: Rear Axle		24.0110-0356.1 410356	Outer diameter [mm]: 272 Brake Disc Thickness [mm] 9.7 Minimum thickness [mm] 8 Brake Disc Type: Solid Supplementary Article/Info 2: with bolts/screws



	kW								
AUDI - Q2 (GAB, GAG) 06/16→									
 Brake Disc									
1.0 TFSI	85 10/16→10/20	for PR number: 1KE / 1KR / 2EJ / 2EL / 0N4; Fitting Position: Rear Axle	24.0310-0356.1	510356	Outer diameter [mm]: 272 Brake Disc Thickness [mm] 9.7 Minimum thickness [mm] 8 Brake Disc Type: Solid Supplementary Article/Info 2: with bolts/screws				
1.4 TFSI	110 06/16→08/18								
1.6 TDI	85 06/16→10/18								
2.0 TDI	110 09/16→								
2.0 TDI quattro	110 - 07/16→ 140								
2.0 TFSI quattro	140 05/17→								
30 TDI	85 07/18→								
30 TFSI	81 - 07/18→ 85								
35 TDI	110 09/16→								
35 TDI quattro	110 09/18→								
35 TFSI	110 07/18→								
40 TFSI quattro	140 09/18→								
SQ2 TFSI quattro	221 08/18→								
 Wheel Speed Sensor									
1.0 TFSI	85 10/16→10/20					Fitting Position: Front Axle Left	24.0711-5273.3	360303	
30 TFSI	85 07/18→10/20	Fitting Position: Front Axle Right	24.0711-5274.3	360304					
		Required quantity: 2; → Construction year to: 07/20; Fitting Position: Rear Axle	2	24.0711-6337.3	360390				
1.4 TFSI	110 06/16→08/18	Fitting Position: Front Axle Left	24.0711-5273.3	360303					
1.6 TDI	85 06/16→10/18	Fitting Position: Front Axle Right	24.0711-5274.3	360304					
		Required quantity: 2; Fitting Position: Rear Axle	2	24.0711-6337.3	360390				
2.0 TDI	110 09/16→	→ Construction year to: 10/20; Fitting Position: Front Axle Left	24.0711-5273.3	360303					
30 TDI	85 07/18→								
35 TDI	110 09/16→	→ Construction year to: 10/20; Fitting Position: Front Axle Right	24.0711-5274.3	360304					
35 TFSI	110 07/18→								
		Required quantity: 2; → Construction year to: 07/20; Fitting Position: Rear Axle	2	24.0711-6337.3	360390				
2.0 TDI quattro	110 09/16→	→ Construction year to: 10/20; Fitting Position: Front Axle Left	24.0711-5273.3	360303					
2.0 TFSI quattro	140 05/17→								
35 TDI quattro	110 09/18→	→ Construction year to: 10/20; Fitting Position: Front Axle Right	24.0711-5274.3	360304					
40 TFSI quattro	140 09/18→								
SQ2 TFSI quattro	221 08/18→	→ Construction year to: 10/19; Fitting Position: Rear Axle Left	24.0711-5401.3	360330					
		Construction year from: 11/19 →; Fitting Position: Rear Axle Left	24.0711-5401.3	360330					
		→ Construction year to: 10/19; Fitting Position: Rear Axle Right	24.0711-5402.3	360331					
		Construction year from: 11/19 →; Fitting Position: Rear Axle Right	24.0711-5402.3	360331					
2.0 TDI quattro	140 07/16→08/18	Fitting Position: Front Axle Left	24.0711-5273.3	360303					
		Fitting Position: Front Axle Right	24.0711-5274.3	360304					
		Fitting Position: Rear Axle Left	24.0711-5401.3	360330					
		Fitting Position: Rear Axle Right	24.0711-5402.3	360331					
30 TFSI	81 08/20→	→ Construction year to: 10/20; Fitting Position: Front Axle Left	24.0711-5273.3	360303					
		→ Construction year to: 10/20; Fitting Position: Front Axle Right	24.0711-5274.3	360304					
Control Element, parking brake caliper									
1.0 TFSI	85 10/16→10/20	for PR number: 1KJ; for PR number: 1KR; for PR number: 1KY; for PR number: 2EC; Fitting Position: Rear Axle Left	11.9282-1001.3	250159	Brake System: ATE				
1.4 TFSI	110 06/16→08/18								
1.6 TDI	85 06/16→10/18								
2.0 TDI	110 09/16→								
2.0 TDI quattro	110 - 07/16→ 140								
2.0 TFSI quattro	140 05/17→	for PR number: 1KJ; for PR number: 1KR; for PR number: 1KY; for PR number: 2EC; Fitting Position: Rear Axle Right	11.9282-1002.3	250160	Brake System: ATE				
30 TDI	85 07/18→								
30 TFSI	81 - 07/18→ 85								
35 TDI	110 09/16→								
35 TDI quattro	110 09/18→								
35 TFSI	110 07/18→								
40 TFSI quattro	140 09/18→								
SQ2 TFSI quattro	221 08/18→								
AUDI - Q3 (8UB, 8UG) 06/11→12/18									
Guide Bolt, brake caliper									
1.4 TFSI	92 07/16→10/18	for PR number: 1LJ / 1ZD; Required quantity: 2	2	11.8171-0008.1	990049	Brake System: ATE			
1.4 TFSI Flex	110 02/16→10/18								





	kW				
AUDI - Q3 (8UB, 8UG) 06/11→12/18					
Guide Bolt, brake caliper					
2.0 TDI	88 - 11/14→10/18 135	for PR number: 1LJ / 1ZD; Required quantity: 2	2	11.8171-0008.1 990049	Brake System: ATE
2.0 TDI quattro	110 - 11/14→10/18 135				
2.0 TFSI	132 05/15→10/18				
2.0 TFSI quattro	132 - 11/14→10/18 162				
1.4 TSI	110 10/13→10/18	for PR number: 1LJ / 1ZD; Required quantity: 2; Fitting Position: Front Axle	2	11.8171-0008.1 990049	Brake System: ATE
2.0 TDI	100 - 06/11→10/18 130				
2.0 TDI quattro	103 - 06/11→10/18 130				
2.0 TFSI quattro	125 - 06/11→10/18 155				
 Brake Disc					
1.4 TFSI	92 07/16→10/18	for PR number: 1LJ / 1ZD; Fitting Position: Front Axle		24.0125-0158.1 425158	Outer diameter [mm]: 312 Brake Disc Thickness [mm] 25 Minimum thickness [mm] 22 Brake Disc Type: Vented Supplementary Article/Info 2: with bolts/screws
2.0 TDI	88 - 11/14→10/18 135				
2.0 TDI quattro	110 - 11/14→10/18 135				
2.0 TFSI	132 05/15→10/18				
2.0 TFSI quattro	132 - 11/14→10/18 162			24.0325-0158.1 525158	Outer diameter [mm]: 312 Brake Disc Thickness [mm] 25 Minimum thickness [mm] 22 Brake Disc Type: Vented Supplementary Article/Info 2: with bolts/screws
		for PR number: 1KU; Vehicle Equipment: for vehicles with electric parking brake; Fitting Position: Rear Axle		24.0112-0210.1 412210	Outer diameter [mm]: 300 Brake Disc Thickness [mm] 12 Minimum thickness [mm] 10 Brake Disc Type: Solid Supplementary Article/Info 2: with bolts/screws
1.4 TFSi Flex	110 02/16→10/18	for PR number: 1LJ / 1ZD; Fitting Position: Front Axle		24.0125-0158.1 425158	Outer diameter [mm]: 312 Brake Disc Thickness [mm] 25 Minimum thickness [mm] 22 Brake Disc Type: Vented Supplementary Article/Info 2: with bolts/screws
		for PR number: 1KU; Vehicle Equipment: for vehicles with electric parking brake; Fitting Position: Rear Axle		24.0112-0210.1 412210	Outer diameter [mm]: 300 Brake Disc Thickness [mm] 12 Minimum thickness [mm] 10 Brake Disc Type: Solid Supplementary Article/Info 2: with bolts/screws
1.4 TSI	110 10/13→10/18	for PR number: 1LJ / 1ZD; Fitting Position: Front Axle		24.0125-0158.1 425158	Outer diameter [mm]: 312 Brake Disc Thickness [mm] 25 Minimum thickness [mm] 22 Brake Disc Type: Vented Supplementary Article/Info 2: with bolts/screws
2.0 TDI	100 - 06/11→10/18 130				
2.0 TDI quattro	103 - 06/11→10/18 130				
2.0 TFSI quattro	125 - 06/11→10/18 155			24.0325-0158.1 525158	Outer diameter [mm]: 312 Brake Disc Thickness [mm] 25 Minimum thickness [mm] 22 Brake Disc Type: Vented Supplementary Article/Info 2: with bolts/screws
		for PR number: 1KU; Construction year from: 11/14 →; Fitting Position: Rear Axle		24.0112-0210.1 412210	Outer diameter [mm]: 300 Brake Disc Thickness [mm] 12 Minimum thickness [mm] 10 Brake Disc Type: Solid Supplementary Article/Info 2: with bolts/screws
 Wheel Speed Sensor					
2.0 TDI quattro	103 - 06/11→10/18 135	for PR number: 7X5 / 8A3; Fitting Position: Rear Axle Left		24.0711-5401.3 360330	
2.0 TFSI quattro	125 - 06/11→10/18 162	for PR number: 7X5 / 8A3; Fitting Position: Rear Axle Right		24.0711-5402.3 360331	
AUDI - Q3 (F3B) 07/18→					
 Brake Caliper					
35 TDI	110 09/18→	for PR number: 1ZA / 1ZD / 1ZK / 1ZL; Fitting Position: Front Axle Left		24.3571-1801.5 241387	Supplementary Article/Supplementary Info: without holder Brake Caliper Type: Fist-type Caliper
35 TDI quattro	110 09/18→				
35 TFSI	110 08/18→				
35 TFSI Mild Hybrid	110 11/19→				
→					

	kW				
AUDI - Q3 (F3B) 07/18→					
 Brake Caliper					
40 TDI quattro	140 - 10/18→ 147		for PR number: 1ZA / 1ZD / 1ZK / 1ZL; Fitting Position: Front Axle Right	24.3571-1802.5 241388	Supplementary Article/Supplementary Info: without holder Brake Caliper Type: Fist-type Caliper
40 TFSI quattro	140 07/18→				
45 TFSI e	110 11/20→				
45 TFSI quattro	169 - 07/18→ 180				
 Brake Pad Set, disc brake					
35 TDI	110 09/18→		Construction year from: 11/20 →; for PR number: 1ZL; Fitting Position: Front Axle	13.0460-2609.2 602609	Brake System: Lucas / TRW 25683 20,4 Wear Warning Contact: prepared for wear indicator / excl. wear warning contact
35 TDI quattro	110 09/18→				
35 TFSI	110 08/18→				
35 TFSI Mild Hybrid	110 11/19→				
40 TDI quattro	140 10/18→				
40 TFSI quattro	140 07/18→			13.0470-2609.2 LD2609	Brake System: Lucas / TRW Wear Warning Contact: prepared for wear indicator / excl. wear warning contact Ceramic
45 TFSI quattro	169 07/18→				
40 TDI quattro	147 11/20→		for PR number: 1ZL; Fitting Position: Front Axle	13.0460-2609.2 602609	Brake System: Lucas / TRW 25683 20,4 Wear Warning Contact: prepared for wear indicator / excl. wear warning contact
45 TFSI e	110 11/20→				
45 TFSI quattro	180 01/21→			13.0470-2609.2 LD2609	Brake System: Lucas / TRW Wear Warning Contact: prepared for wear indicator / excl. wear warning contact Ceramic
 Brake Disc					
35 TDI	110 09/18→		for PR number: 1ZA / 1ZD / 1ZL; Fitting Position: Front Axle	24.0125-0158.1 425158	Outer diameter [mm]: 312 Brake Disc Thickness [mm] 25 Minimum thickness [mm] 22 Brake Disc Type: Vented Supplementary Article/Info 2: with bolts/screws
35 TDI quattro	110 09/18→				
35 TFSI	110 08/18→				
35 TFSI Mild Hybrid	110 11/19→				
40 TDI quattro	140 - 10/18→ 147				
40 TFSI quattro	140 07/18→		for PR number: 1KU / 2EM; Fitting Position: Rear Axle	24.0112-0210.1 412210	Outer diameter [mm]: 300 Brake Disc Thickness [mm] 12 Minimum thickness [mm] 10 Brake Disc Type: Solid Supplementary Article/Info 2: with bolts/screws
45 TFSI e	110 11/20→				
45 TFSI quattro	169 - 07/18→ 180				
 Wheel Speed Sensor					
2.5 RS quattro	294 10/19→		Fitting Position: Front Axle Left	24.0711-5273.3 360303	
			Fitting Position: Front Axle Right	24.0711-5274.3 360304	
			→ Construction year to: 11/19; Fitting Position: Rear Axle Left	24.0711-5401.3 360330	
			Construction year from: 12/19 →; Fitting Position: Rear Axle Left	24.0711-5401.3 360330	
			Construction year from: 12/19 →; Fitting Position: Rear Axle Right	24.0711-5402.3 360331	
			→ Construction year to: 11/19; Fitting Position: Rear Axle Right	24.0711-5402.3 360331	
35 TDI	110 09/18→		Fitting Position: Front Axle Left	24.0711-5273.3 360303	
35 TDI quattro	110 09/18→		Fitting Position: Front Axle Right	24.0711-5274.3 360304	
35 TFSI	110 08/18→		Fitting Position: Rear Axle Left	24.0711-5401.3 360330	
35 TFSI Mild Hybrid	110 11/19→		Fitting Position: Rear Axle Right	24.0711-5402.3 360331	
40 TDI quattro	140 10/18→		Construction year from: 12/19 →; Fitting Position: Rear Axle Left	24.0711-5401.3 360330	
40 TFSI quattro	140 07/18→		Fitting Position: Rear Axle Right	24.0711-5402.3 360331	
45 TFSI quattro	169 07/18→		Construction year from: 12/19 →; Fitting Position: Rear Axle Right	24.0711-5402.3 360331	
			Required quantity: 2; Fitting Position: Rear Axle	2 24.0711-6337.3 360390	
40 TDI quattro	147 11/20→		Fitting Position: Front Axle Left	24.0711-5273.3 360303	
45 TFSI quattro	180 01/21→		Fitting Position: Front Axle Right	24.0711-5274.3 360304	
			Fitting Position: Rear Axle Left	24.0711-5401.3 360330	
			Fitting Position: Rear Axle Right	24.0711-5402.3 360331	
			Required quantity: 2; Fitting Position: Rear Axle	2 24.0711-6337.3 360390	
45 TFSI e	110 11/20→		Fitting Position: Rear Axle Left	24.0711-5401.3 360330	
			Fitting Position: Rear Axle Right	24.0711-5402.3 360331	
Control Element, parking brake caliper					
2.5 RS quattro	294 10/19→		Fitting Position: Rear Axle Left	11.9282-1001.3 250159	Brake System: ATE



	kW			
AUDI - Q3 (F3B) 07/18→				
Control Element, parking brake caliper				
35 TDI	110 09/18→	Fitting Position: Rear Axle Right	11.9282-1002.3 250160	Brake System: ATE
35 TDI quattro	110 09/18→			
35 TFSI	110 08/18→			
35 TFSI Mild Hybrid	110 11/19→			
40 TDI quattro	140 - 10/18→			
	147			
40 TFSI quattro	140 07/18→			
45 TFSI e	110 11/20→			
45 TFSI quattro	169 - 07/18→			
	180			
AUDI - Q3 Sportback (F3N) 06/19→				
 Brake Caliper				
35 TDI	110 11/19→	for PR number: 1ZA / 1ZD / 1ZK / 1ZL; Fitting Position: Front Axle Left	24.3571-1801.5 241387	Supplementary Article/Supplementary Info: without holder Brake Caliper Type: Fist-type Caliper
35 TDI quattro	110 09/19→			
35 TFSI	110 09/19→			
35 TFSI Mild Hybrid	110 11/19→			
40 TDI quattro	140 - 07/19→	for PR number: 1ZA / 1ZD / 1ZK / 1ZL; Fitting Position: Front Axle Right	24.3571-1802.5 241388	Supplementary Article/Supplementary Info: without holder Brake Caliper Type: Fist-type Caliper
	147			
40 TFSI quattro	140 11/19→			
45 TFSI e	110 11/20→			
45 TFSI quattro	169 - 06/19→			
	180			
 Brake Pad Set, disc brake				
35 TDI	110 11/19→	Construction year from: 11/20 →; for PR number: 1ZL; Fitting Position: Front Axle	13.0460-2609.2 602609	Brake System: Lucas / TRW 25683 20,4 Wear Warning Contact: prepared for wear indicator / excl. wear warning contact
35 TDI quattro	110 09/19→			
35 TFSI	110 09/19→			
35 TFSI Mild Hybrid	110 11/19→			
40 TDI quattro	140 - 07/19→		13.0470-2609.2 LD2609	Brake System: Lucas / TRW Wear Warning Contact: prepared for wear indicator / excl. wear warning contact Ceramic
	147			
40 TFSI quattro	140 11/19→			
45 TFSI quattro	169 06/19→			
45 TFSI e	110 11/20→	for PR number: 1ZL; Fitting Position: Front Axle	13.0460-2609.2 602609	Brake System: Lucas / TRW 25683 20,4 Wear Warning Contact: prepared for wear indicator / excl. wear warning contact
45 TFSI quattro	180 01/21→		13.0470-2609.2 LD2609	Brake System: Lucas / TRW Wear Warning Contact: prepared for wear indicator / excl. wear warning contact Ceramic
 Brake Disc				
35 TDI	110 11/19→	for PR number: 1ZA / 1ZD / 1ZL; Fitting Position: Front Axle	24.0125-0158.1 425158	Outer diameter [mm]: 312 Brake Disc Thickness [mm] 25 Minimum thickness [mm] 22 Brake Disc Type: Vented Supplementary Article/Info 2: with bolts/screws
35 TDI quattro	110 09/19→			
35 TFSI	110 09/19→			
35 TFSI Mild Hybrid	110 11/19→			
40 TDI quattro	140 - 07/19→			
	147			
40 TFSI quattro	140 11/19→	for PR number: 1KU / 2EM; Fitting Position: Rear Axle	24.0112-0210.1 412210	Outer diameter [mm]: 300 Brake Disc Thickness [mm] 12 Minimum thickness [mm] 10 Brake Disc Type: Solid Supplementary Article/Info 2: with bolts/screws
45 TFSI e	110 11/20→			
45 TFSI quattro	169 - 06/19→			
	180			
 Wheel Speed Sensor				
2.5 RS quattro	294 10/19→	Fitting Position: Front Axle Left	24.0711-5273.3 360303	
		Fitting Position: Front Axle Right	24.0711-5274.3 360304	
		→ Construction year to: 11/19; Fitting Position: Rear Axle Left	24.0711-5401.3 360330	
		Construction year from: 12/19 →; Fitting Position: Rear Axle Left	24.0711-5401.3 360330	
		Construction year from: 12/19 →; Fitting Position: Rear Axle Right	24.0711-5402.3 360331	
		→ Construction year to: 11/19; Fitting Position: Rear Axle Right	24.0711-5402.3 360331	
35 TDI	110 11/19→	Fitting Position: Front Axle Left	24.0711-5273.3 360303	
35 TDI quattro	110 09/19→	Fitting Position: Front Axle Right	24.0711-5274.3 360304	
35 TFSI	110 09/19→	Fitting Position: Rear Axle Left	24.0711-5401.3 360330	
35 TFSI Mild Hybrid	110 11/19→	Fitting Position: Rear Axle Left	24.0711-5401.3 360330	
40 TDI quattro	140 07/19→	Construction year from: 12/19 →; Fitting Position: Rear Axle Left	24.0711-5401.3 360330	
40 TFSI quattro	140 11/19→	Fitting Position: Rear Axle Right	24.0711-5402.3 360331	
45 TFSI quattro	169 06/19→	Fitting Position: Rear Axle Right	24.0711-5402.3 360331	



	kW				
AUDI - Q3 Sportback (F3N) 06/19→					
 Wheel Speed Sensor					
35 TDI	110 11/19→		Construction year from: 12/19 →;		24.0711-5402.3 360331
35 TDI quattro	110 09/19→		Fitting Position: Rear Axle Right		
35 TFSI	110 09/19→		Required quantity: 2;	2	24.0711-6337.3 360390
35 TFSI Mild Hybrid	110 11/19→		Fitting Position: Rear Axle		
40 TDI quattro	140 07/19→				
40 TFSI quattro	140 11/19→				
45 TFSI quattro	169 06/19→				
40 TDI quattro	147 09/20→		Fitting Position: Front Axle Left		24.0711-5273.3 360303
45 TFSI quattro	180 01/21→		Fitting Position: Front Axle Right		24.0711-5274.3 360304
			Fitting Position: Rear Axle Left		24.0711-5401.3 360330
			Fitting Position: Rear Axle Right		24.0711-5402.3 360331
			Required quantity: 2;	2	24.0711-6337.3 360390
			Fitting Position: Rear Axle		
45 TFSI e	110 11/20→		Fitting Position: Rear Axle Left		24.0711-5401.3 360330
			Fitting Position: Rear Axle Right		24.0711-5402.3 360331
Control Element, parking brake caliper					
2.5 RS quattro	294 10/19→		Fitting Position: Rear Axle Left		11.9282-1001.3 250159 Brake System: ATE
35 TDI	110 11/19→		Fitting Position: Rear Axle Right		11.9282-1002.3 250160 Brake System: ATE
35 TDI quattro	110 09/19→				
35 TFSI	110 09/19→				
35 TFSI Mild Hybrid	110 11/19→				
40 TDI quattro	140 - 07/19→				
	147				
40 TFSI quattro	140 11/19→				
45 TFSI e	110 11/20→				
45 TFSI quattro	169 - 06/19→				
	180				
AUDI - Q4 Sportback (F4N) 06/21→					
Warning Contact, brake pad wear					
35 e-tron	125 06/21→		Required quantity: 1;	1	24.8190-0830.2 620830
40 e-tron	150 06/21→		for PR number: 1LB / 1LC;		
50 e-tron quattro	220 06/21→		Fitting Position: Front Axle		
AUDI - Q4 SUV (F4B) 07/20→					
Warning Contact, brake pad wear					
35 e-tron	125 05/21→		Required quantity: 1;	1	24.8190-0830.2 620830
40 e-tron	150 03/21→		for PR number: 1LB / 1LC;		
45 e-tron quattro	195 06/21→		Fitting Position: Front Axle		
50 e-tron quattro	220 03/21→				
AUDI - Q7 (4LB) 03/06→01/16					
 Wheel Speed Sensor					
3.0 TDI quattro	150 - 11/07→08/15		→ Construction year to: 05/10;		24.0711-5401.3 360330
	176		Fitting Position: Front Axle Left		
3.0 TFSI quattro	200 - 05/10→08/15		→ Construction year to: 05/10;		24.0711-5402.3 360331
	245		Fitting Position: Front Axle Right		
4.2 TDI quattro	250 05/09→08/15		Fitting Position: Rear Axle Left		24.0711-5401.3 360330
			Fitting Position: Rear Axle Right		24.0711-5402.3 360331
3.0 TDI quattro	155 - 03/06→05/10		Fitting Position: Front Axle Left		24.0711-5401.3 360330
	171		Fitting Position: Front Axle Right		24.0711-5402.3 360331
3.6 FSI quattro	206 08/06→05/10		Fitting Position: Rear Axle Left		24.0711-5401.3 360330
4.2 FSI quattro	257 03/06→05/10		Fitting Position: Rear Axle Right		24.0711-5402.3 360331
4.2 quattro	231 03/06→12/10				
4.2 TDI quattro	240 03/07→06/09				
6.0 TDI quattro	368 09/08→05/14				
3.0 TDI quattro	180 05/11→08/15		Fitting Position: Rear Axle Left		24.0711-5401.3 360330
3.0 TFSI quattro	206 05/11→08/15		Fitting Position: Rear Axle Right		24.0711-5402.3 360331
AUDI - Q7 Van (4LB) 03/06→01/16					
 Wheel Speed Sensor					
3.0 TDI quattro	150 - 11/10→08/15		Fitting Position: Rear Axle Left		24.0711-5401.3 360330
	180		Fitting Position: Rear Axle Right		24.0711-5402.3 360331
3.0 TDI quattro	155 - 03/06→05/10		Fitting Position: Front Axle Left		24.0711-5401.3 360330
	171		Fitting Position: Front Axle Right		24.0711-5402.3 360331
3.6 FSI quattro	206 08/06→05/10		Fitting Position: Rear Axle Left		24.0711-5401.3 360330
4.2 FSI quattro	257 08/06→05/10		Fitting Position: Rear Axle Right		24.0711-5402.3 360331
4.2 TDI quattro	240 03/07→06/09				
6.0 TDI quattro	368 09/08→05/14				
3.0 TDI quattro	176 11/07→05/12		→ Construction year to: 05/10;		24.0711-5401.3 360330
3.0 TFSI quattro	245 05/10→08/15		Fitting Position: Front Axle Left		
4.2 TDI quattro	250 03/07→08/15				



	kW				
AUDI - Q7 Van (4LB) 03/06→01/16					
 Wheel Speed Sensor					
3.0 TDI quattro	176 11/07→05/12	→ Construction year to: 05/10;		24.0711-5402.3	360331
3.0 TFSI quattro	245 05/10→08/15	Fitting Position: Front Axle Right			
4.2 TDI quattro	250 03/07→08/15	Fitting Position: Rear Axle Left		24.0711-5401.3	360330
		Fitting Position: Rear Axle Right		24.0711-5402.3	360331
AUDI - TT (8J3) 07/06→01/15					
Guide Bolt, brake caliper					
1.8 TFSI	118 06/08→06/14	for PR number: 1LJ; Required quantity: 2	2	11.8171-0008.1	990049 Brake System: ATE
2.0 TDI quattro	125 06/08→06/14	for PR number: 1LL; Required quantity: 2	2	11.8171-0008.1	990049 Brake System: ATE
2.0 TFSI quattro	147 06/08→06/10	for PR number: 1LM;	2	11.8171-0008.1	990049 Brake System: ATE
2.0 TTS quattro	195 05/08→06/14	Required quantity: 2			
		for PR number: 1LK; Required quantity: 2	2	11.8171-0008.1	990049 Brake System: ATE
2.0 TFSI	147 08/06→06/10	for PR number: 1LJ; Required quantity: 2	2	11.8171-0008.1	990049 Brake System: ATE
3.2 V6 quattro	184 08/06→06/10	for PR number: 1LL; Required quantity: 2	2	11.8171-0008.1	990049 Brake System: ATE
		for PR number: 1LM;	2	11.8171-0008.1	990049 Brake System: ATE
		Required quantity: 2			
		for PR number: 1LK / 1LM;	2	11.8171-0008.1	990049 Brake System: ATE
		Required quantity: 2			
2.0 TFSI	155 05/10→06/14	for PR number: 1LJ; Required quantity: 2	2	11.8171-0008.1	990049 Brake System: ATE
2.0 TFSI quattro	155 05/10→06/14	for PR number: 1LL; Required quantity: 2	2	11.8171-0008.1	990049 Brake System: ATE
		for PR number: 1LM;	2	11.8171-0008.1	990049 Brake System: ATE
		Required quantity: 2			
2.0 TTS quattro	200 05/08→06/14	for PR number: 1LN;	2	11.8171-0008.1	990049 Brake System: ATE
		Required quantity: 2			
 Brake Disc					
1.8 TFSI	118 06/08→06/14	for PR number: 1LJ / 1LL;		24.0125-0158.1	425158 Outer diameter [mm]: 312
2.0 TDI quattro	125 06/08→06/14	Fitting Position: Front Axle			Brake Disc Thickness [mm] 25
2.0 TFSI	147 - 08/06→06/14				Minimum thickness [mm] 22
	155				Brake Disc Type: Vented
2.0 TFSI quattro	147 - 06/08→06/14				Supplementary Article/Info 2: with
	155				bolts/screws
3.2 V6 quattro	184 08/06→06/10			24.0325-0158.1	525158 Outer diameter [mm]: 312
					Brake Disc Thickness [mm] 25
					Minimum thickness [mm] 22
					Brake Disc Type: Vented
					Supplementary Article/Info 2: with
					bolts/screws
2.0 TTS quattro	195 05/08→06/14	for PR number: 1LJ / 1LL;		24.0125-0158.1	425158 Outer diameter [mm]: 312
		Fitting Position: Front Axle			Brake Disc Thickness [mm] 25
					Minimum thickness [mm] 22
					Brake Disc Type: Vented
					Supplementary Article/Info 2: with
					bolts/screws
AUDI - TT (8N3) 10/98→12/06					
Guide Bolt, brake caliper					
1.8 T	110 - 10/98→06/06	for PR number: 1LD / 1LT / 1LV;	2	11.8171-0008.1	990049 Brake System: ATE
	140	Required quantity: 2			
1.8 T quattro	132 - 10/98→06/06				
	180				
3.2 VR6 quattro	184 07/03→06/06	Required quantity: 2	2	11.8171-0008.1	990049 Brake System: ATE
AUDI - TT (FV3, FVP) 07/14→					
 Brake Caliper					
1.8 TFSI	132 07/15→08/18	for PR number: 1LJ / 1ZD / 1ZF / 1ZL;		24.3571-1801.5	241387 Supplementary Article/Supple-
2.0 TDI	135 07/14→	Fitting Position: Front Axle Left			mentary Info: without holder
2.0 TDI quattro	135 01/17→				Brake Caliper Type: Fist-type
2.0 TFSI	169 07/14→				Caliper
2.0 TFSI quattro	162 - 07/14→	for PR number: 1LJ / 1ZD / 1ZF / 1ZL;		24.3571-1802.5	241388 Supplementary Article/Supple-
	169	Fitting Position: Front Axle Right			mentary Info: without holder
2.0 TTS quattro	210 - 11/14→				Brake Caliper Type: Fist-type
	228				Caliper
2.5 RS quattro	294 10/16→				
40 TFSI	145 07/18→				
45 TFSI	180 07/18→				
45 TFSI quattro	180 07/18→				
TTS quattro	235 01/21→				
→					

	kW				
AUDI - TT Roadster (8J9) 03/07→06/14					
 Brake Disc					
1.8 TFSI 2.0 TDI quattro 2.0 TFSI 2.0 TFSI quattro 3.2 V6 quattro	118 06/08→06/14 125 06/08→06/14 147 - 03/07→06/14 155 147 - 06/08→06/14 155 184 03/07→06/10	for PR number: 1LJ / 1LL; Fitting Position: Front Axle		24.0125-0158.1 425158 24.0325-0158.1 525158	Outer diameter [mm]: 312 Brake Disc Thickness [mm] 25 Minimum thickness [mm] 22 Brake Disc Type: Vented Supplementary Article/Info 2: with bolts/screws Outer diameter [mm]: 312 Brake Disc Thickness [mm] 25 Minimum thickness [mm] 22 Brake Disc Type: Vented Supplementary Article/Info 2: with bolts/screws
2.0 TTS quattro	195 05/08→06/14	for PR number: 1LJ / 1LL; Fitting Position: Front Axle		24.0125-0158.1 425158	Outer diameter [mm]: 312 Brake Disc Thickness [mm] 25 Minimum thickness [mm] 22 Brake Disc Type: Vented Supplementary Article/Info 2: with bolts/screws
AUDI - TT Roadster (8N9) 10/99→12/06					
Guide Bolt, brake caliper					
1.8 T 1.8 T quattro	110 - 10/99→06/06 140 132 - 10/99→06/06 165	for PR number: 1LD / 1LT / 1LV; Required quantity: 2	2	11.8171-0008.1 990049	Brake System: ATE
3.2 VR6 quattro	184 07/03→06/06	Required quantity: 2	2	11.8171-0008.1 990049	Brake System: ATE
AUDI - TT Roadster (FV9, FVR) 11/14→					
 Brake Caliper					
1.8 TFSI 2.0 TDI 2.0 TDI quattro 2.0 TFSI 2.0 TFSI quattro	132 07/15→08/18 135 11/14→ 135 01/17→ 169 11/14→ 162 - 11/14→ 169	for PR number: 1LJ / 1ZD / 1ZF / 1ZL; Fitting Position: Front Axle Left		24.3571-1801.5 241387	Supplementary Article/Supplementary Info: without holder Brake Caliper Type: Fist-type Caliper
2.0 TTS quattro 2.5 RS quattro 40 TFSI 45 TFSI 45 TFSI quattro TTS quattro	210 - 11/14→ 228 294 10/16→ 145 07/18→ 180 07/18→ 180 07/18→ 235 11/20→	for PR number: 1LJ / 1ZD / 1ZF / 1ZL; Fitting Position: Front Axle Right		24.3571-1802.5 241388	Supplementary Article/Supplementary Info: without holder Brake Caliper Type: Fist-type Caliper
 Brake Disc					
1.8 TFSI 2.0 TDI 2.0 TDI quattro 2.0 TFSI 2.0 TFSI quattro	132 07/15→08/18 135 11/14→ 135 01/17→ 169 11/14→ 162 - 11/14→ 169	for PR number: 1LJ / 1ZD / 1ZF / 1ZL / 1LP / 1ZT / 1ZV / 1ZW; Fitting Position: Front Axle		24.0125-0158.1 425158	Outer diameter [mm]: 312 Brake Disc Thickness [mm] 25 Minimum thickness [mm] 22 Brake Disc Type: Vented Supplementary Article/Info 2: with bolts/screws
2.0 TTS quattro 2.5 RS quattro 40 TFSI 45 TFSI 45 TFSI quattro TTS quattro	210 - 11/14→ 228 294 10/16→ 145 07/18→ 180 07/18→ 180 07/18→ 235 11/20→	for PR number: 1KZ / 1KE / 2EC; Fitting Position: Rear Axle		24.0110-0356.1 410356	Outer diameter [mm]: 272 Brake Disc Thickness [mm] 9.7 Minimum thickness [mm] 8 Brake Disc Type: Solid Supplementary Article/Info 2: with bolts/screws
		Vehicle Equipment: for vehicles with electric parking brake; for PR number: 1KV / 2ED / 2EN / 2EP; Fitting Position: Rear Axle		24.0112-0210.1 412210	Outer diameter [mm]: 300 Brake Disc Thickness [mm] 12 Minimum thickness [mm] 10 Brake Disc Type: Solid Supplementary Article/Info 2: with bolts/screws
 Wheel Speed Sensor					
1.8 TFSI 2.0 TDI 2.0 TFSI 40 TFSI 45 TFSI	132 07/15→08/18 135 11/14→ 169 11/14→ 145 07/18→ 180 07/18→	Fitting Position: Front Axle Left		24.0711-5273.3 360303	
		Fitting Position: Front Axle Right		24.0711-5274.3 360304	
		Required quantity: 2; Fitting Position: Rear Axle	2	24.0711-6337.3 360390	
2.0 TDI quattro 2.0 TFSI quattro	135 01/17→ 162 - 11/14→ 169	Fitting Position: Front Axle Left		24.0711-5273.3 360303	
		Fitting Position: Front Axle Right		24.0711-5274.3 360304	
2.0 TTS quattro	210 - 11/14→ 228	Fitting Position: Rear Axle Left		24.0711-5401.3 360330	
		Fitting Position: Rear Axle Right		24.0711-5402.3 360331	
2.5 RS quattro 45 TFSI quattro TTS quattro	294 10/16→ 180 07/18→ 235 11/20→				

	kW				
AUDI - TT Roadster (FV9, FVR) 11/14→					
Control Element, parking brake caliper					
1.8 TFSI	132 07/15→08/18	Fitting Position: Rear Axle Left		11.9282-1001.3 250159	Brake System: ATE
2.0 TDI	135 11/14→				
2.0 TDI quattro	135 01/17→	Fitting Position: Rear Axle Right		11.9282-1002.3 250160	Brake System: ATE
2.0 TFSI	169 11/14→				
2.0 TFSI quattro	162 - 11/14→				
	169				
2.0 TTS quattro	210 - 11/14→				
	228				
2.5 RS quattro	294 10/16→				
40 TFSI	145 07/18→				
45 TFSI	180 07/18→				
45 TFSI quattro	180 07/18→				
TTS quattro	235 11/20→				
BMW - 1 (E81) 09/06→09/12					
Guide Bolt, brake caliper					
118 d	100 - 09/06→12/11	Construction year from: 04/07 → →		2 11.8171-0008.1 990049	Brake System: ATE
	105	Construction year to: 05/11;			
120 i	120 - 03/07→09/12	Required quantity: 2;			
	125	Fitting Position: Front Axle			
120 d	120 03/07→12/11	Required quantity: 2;		2 11.8171-0008.1 990049	Brake System: ATE
		Fitting Position: Front Axle			
120 d	130 - 03/07→12/11	→ Construction year to: 05/11;		2 11.8171-0008.1 990049	Brake System: ATE
	145	Required quantity: 2;			
130 i	190 - 09/06→12/11	Fitting Position: Front Axle			
	195				
120 i	115 03/07→12/11	→ Construction year to: 03/07;		2 11.8171-0008.1 990049	Brake System: ATE
		Number of Doors: 3;			
		Required quantity: 2;			
		Fitting Position: Front Axle			
123 d	150 03/07→12/11	Construction year from: 10/07 → →		2 11.8171-0008.1 990049	Brake System: ATE
		Construction year to: 02/10;			
		Required quantity: 2;			
		Fitting Position: Front Axle			
		Construction year from: 10/07 → →		2 11.8171-0008.1 990049	Brake System: ATE
		Construction year to: 05/11;			
		Required quantity: 2;			
		Fitting Position: Front Axle			
BMW - 1 (E87) 02/03→01/13					
Guide Bolt, brake caliper					
118 d	90 06/04→02/07	Construction year from: 09/04 →;		2 11.8171-0008.1 990049	Brake System: ATE
		Number of Doors: 3;			
		Required quantity: 2;			
		Fitting Position: Front Axle			
118 d	100 - 03/07→06/11	Construction year from: 04/07 → →		2 11.8171-0008.1 990049	Brake System: ATE
	105	Construction year to: 05/11;			
120 i	120 - 03/07→06/11	Required quantity: 2;			
	125	Fitting Position: Front Axle			
120 d	110 06/04→02/07	Construction year from: 09/04 →;		2 11.8171-0008.1 990049	Brake System: ATE
		Number of Doors: 3;			
		Required quantity: 2;			
		Fitting Position: Front Axle			
		Construction year from: 09/04 →;		2 11.8171-0008.1 990049	Brake System: ATE
		Number of Doors: 5;			
		Required quantity: 2;			
		Fitting Position: Front Axle			
		Construction year from: 09/04 →;		2 11.8171-0008.1 990049	Brake System: ATE
		Required quantity: 2;			
		Fitting Position: Front Axle			
120 d	120 06/04→06/11	Construction year from: 09/04 → →		2 11.8171-0008.1 990049	Brake System: ATE
		Construction year to: 02/07;			
		Number of Doors: 5;			
		Required quantity: 2;			
		Fitting Position: Front Axle			
		Construction year from: 09/04 → →		2 11.8171-0008.1 990049	Brake System: ATE
		Construction year to: 02/07;			
		Number of Doors: 3;			
		Required quantity: 2;			
		Fitting Position: Front Axle			
		Construction year from: 09/04 → →		2 11.8171-0008.1 990049	Brake System: ATE
		Construction year to: 02/07;			
		Required quantity: 2;			
		Fitting Position: Front Axle			
120 d	130 03/07→06/11	→ Construction year to: 05/11;		2 11.8171-0008.1 990049	Brake System: ATE
130 i	190 03/07→06/11	Required quantity: 2;			
		Fitting Position: Front Axle			
120 i	110 06/04→02/07	Construction year from: 09/04 → →		2 11.8171-0008.1 990049	Brake System: ATE
		Construction year to: 12/05;			
→					

	kW								
BMW - 1 (E87) 02/03→01/13									
Guide Bolt, brake caliper									
120 i	110 06/04→02/07	Required quantity: 2; Number of Doors: 5; Fitting Position: Front Axle							
		Construction year from: 09/04 →; Number of Doors: 3; Required quantity: 2; Fitting Position: Front Axle	2	11.8171-0008.1 990049	Brake System: ATE				
120 i	115 03/07→06/11	→ Construction year to: 03/07; Number of Doors: 3; Required quantity: 2; Fitting Position: Front Axle	2	11.8171-0008.1 990049	Brake System: ATE				
123 d	150 03/07→06/11	Construction year from: 10/07 → → Construction year to: 02/10; Required quantity: 2; Fitting Position: Front Axle	2	11.8171-0008.1 990049	Brake System: ATE				
		Construction year from: 10/07 → → Construction year to: 05/11; Required quantity: 2; Fitting Position: Front Axle	2	11.8171-0008.1 990049	Brake System: ATE				
130 i	195 09/05→02/07	Required quantity: 2; Fitting Position: Front Axle	2	11.8171-0008.1 990049	Brake System: ATE				
BMW - 1 (F40) 07/19→									
Warning Contact, brake pad wear									
116 d	85 07/19→	Required quantity: 1; Braking System: for vehicles without M-sport brakes; Fitting Position: Front Axle	1	24.8190-0828.2 620828	Length 2 [mm]: 237				
116 i	80 11/20→								
118 d	100 - 07/19→								
	110								
118 i	100 - 07/19→								
	103								
120 d	140 03/20→								
120 d xDrive	140 07/19→								
 Brake Hose									
116 d	85 07/19→	Required quantity: 2; Fitting Position: Front Axle	2	24.5134-0420.3 331648	Length [mm]: 465				
116 i	80 11/20→								
118 d	100 - 07/19→								
	110								
118 i	100 - 07/19→								
	103								
120 d	140 03/20→								
120 d xDrive	140 07/19→								
120 i	131 11/20→								
128 ti	180 - 11/20→								
	195								
M 135 i xDrive	225 07/19→								
BMW - 1 (F52) 01/17→									
Warning Contact, brake pad wear									
118 i	100 01/17→08/19	Required quantity: 1; Braking System: for vehicles without M-sport brakes; Fitting Position: Front Axle	1	24.8190-0828.2 620828	Length 2 [mm]: 237				
 Brake Hose									
118 i	100 01/17→08/19	Required quantity: 2; Fitting Position: Front Axle	2	24.5134-0420.3 331648	Length [mm]: 465				
BMW - 1 Convertible (E88) 12/07→12/13									
Guide Bolt, brake caliper									
118 d	100 - 09/08→12/13	→ Construction year to: 10/13; Required quantity: 2	2	11.8171-0008.1 990049	Brake System: ATE				
	105								
118 i	100 - 03/08→12/13								
	105								
120 d	120 - 03/08→12/13								
	145								
120 i	115 - 03/08→12/13								
	120								
123 d	150 09/08→12/13								
120 i	125 12/07→10/13	Required quantity: 2	2	11.8171-0008.1 990049	Brake System: ATE				
125 i	160 12/07→10/13								
128 i	172 12/07→10/13								
BMW - 1 Coupe (E82) 10/06→10/13									
Guide Bolt, brake caliper									
118 d	100 - 09/09→10/13	Required quantity: 2	2	11.8171-0008.1 990049	Brake System: ATE				
	105								
→									

	kW				
BMW - 1 Coupe (E82) 10/06→10/13					
Guide Bolt, brake caliper					
120 d	120 - 09/07→10/13 130	Required quantity: 2	2	11.8171-0008.1 990049	Brake System: ATE
120 i	115 09/09→10/13				
123 d	150 10/07→10/13				
125 i	160 03/08→10/13				
120 d	145 09/07→10/13	Construction year from: 10/07 →; Required quantity: 2	2	11.8171-0008.1 990049	Brake System: ATE
120 i	125 10/07→10/13	Construction year from: 09/09 →; Required quantity: 2	2	11.8171-0008.1 990049	Brake System: ATE
M	250 03/11→06/12	Construction year from: 05/11 →; Required quantity: 2	2	11.8171-0008.1 990049	Brake System: ATE
BMW - 2 Active Tourer (F45) 11/13→					
Warning Contact, brake pad wear					
220 i	131 11/20→	Required quantity: 1; Fitting Position: Front Axle Left	1	24.8190-0828.2 620828	Length 2 [mm]: 237
 Brake Hose					
214 d	70 07/14→02/18	Construction year from: 03/15 →; Required quantity: 2; Fitting Position: Front Axle	2	24.5134-0420.3 331648	Length [mm]: 465
216 d	85 03/14→	Construction year from: 10/14 →;	2	24.5134-0420.3 331648	Length [mm]: 465
218 i	100 07/14→	Required quantity: 2;			
220 d xDrive	140 03/14→	Fitting Position: Front Axle			
220 i	141 03/14→				
225 i	170 11/13→				
225 i xDrive	170 03/14→				
216 i	75 02/15→02/18	Construction year from: 11/15 →; Required quantity: 2;	2	24.5134-0420.3 331648	Length [mm]: 465
218 d xDrive	100 - 12/14→ 110	Fitting Position: Front Axle			
216 i	80 03/18→	Required quantity: 2;	2	24.5134-0420.3 331648	Length [mm]: 465
218 d	110 11/13→	Fitting Position: Front Axle			
218 i	103 03/18→				
220 d	140 03/14→				
220 i	131 11/20→				
225 xe Plug-in-Hybrid	92 - 11/20→ 162				
218 d	100 11/13→	Construction year from: 09/14 →; Required quantity: 2; Fitting Position: Front Axle	2	24.5134-0420.3 331648	Length [mm]: 465
220 d	120 03/14→	Construction year from: 11/14 →;	2	24.5134-0420.3 331648	Length [mm]: 465
220 d xDrive	120 03/14→	Required quantity: 2;			
220 i	120 03/14→	Fitting Position: Front Axle			
225 xe Plug-in-Hybrid	100 - 11/14→ 165	Construction year from: 03/16 →; Required quantity: 2; Fitting Position: Front Axle	2	24.5134-0420.3 331648	Length [mm]: 465
BMW - 2 Active Tourer Van (F45) 11/13→					
 Brake Hose					
218 d	110 07/14→	Required quantity: 2;	2	24.5134-0420.3 331648	Length [mm]: 465
218 i	103 03/18→	Fitting Position: Front Axle			
220 d	140 11/14→				
BMW - 2 Coupe (G42) 08/21→					
 Brake Pad Set, disc brake					
230 i	180 04/22→	Braking System: for vehicles without M-sport brakes; Fitting Position: Front Axle		13.0460-7345.2 607345	Brake System: ATE Wear Warning Contact: prepared for wear indicator / excl. wear warning contact
				13.0470-7345.2 LD7345	Brake System: ATE Wear Warning Contact: prepared for wear indicator / excl. wear warning contact Ceramic
		Braking System: for vehicles without M-sport brakes; Fitting Position: Rear Axle		13.0460-5525.2 605525	Brake System: Mando Wear Warning Contact: prepared for wear indicator / excl. wear warning contact Supplementary Article/Supplementary Info: with accessories
				13.0470-5525.2 LD5525	Brake System: Mando Wear Warning Contact: prepared for wear indicator / excl. wear warning contact Supplementary Article/Supplementary Info: with accessories Ceramic

	kW				
BMW - 2 Gran Coupe (F44) 11/19→					
Warning Contact, brake pad wear					
216 d	85 03/20→	Required quantity: 1; Braking System: for vehicles without M-sport brakes; Fitting Position: Front Axle Left	1	24.8190-0828.2 620828	Length 2 [mm]: 237
218 i	100 - 11/19→ 103				
 Brake Hose					
216 d	85 03/20→	Required quantity: 2; Fitting Position: Front Axle	2	24.5134-0420.3 331648	Length [mm]: 465
218 d	100 - 11/19→ 110				
218 i	100 - 11/19→ 103				
220 d	120 - 11/19→ 140				
220 d xDrive	140 07/20→				
220 i	131 11/20→				
220 i xDrive	131 03/21→				
M 235 i xDrive	225 11/19→				
BMW - 2 Gran Tourer (F46) 07/14→					
 Brake Hose					
214 d	70 07/15→02/18	Required quantity: 2; Fitting Position: Front Axle	2	24.5134-0420.3 331648	Length [mm]: 465
216 i	80 03/18→				
218 d	110 07/14→				
218 d xDrive	100 - 03/15→ 110				
218 i	100 - 03/15→ 103				
220 d	140 09/14→				
220 d xDrive	120 - 03/15→ 140				
220 i	120 - 03/15→ 141				
216 d	85 08/14→	Construction year from: 03/15 →; Required quantity: 2; Fitting Position: Front Axle	2	24.5134-0420.3 331648	Length [mm]: 465
218 d	100 07/14→				
216 i	75 09/14→02/18	Construction year from: 07/15 →; Required quantity: 2; Fitting Position: Front Axle	2	24.5134-0420.3 331648	Length [mm]: 465
220 d	120 09/14→				
BMW - 2 Gran Tourer Van (F46) 07/14→					
 Brake Hose					
218 d	110 07/14→	Required quantity: 2; Fitting Position: Front Axle	2	24.5134-0420.3 331648	Length [mm]: 465
218 i	103 03/18→				
220 d	140 07/14→				
BMW - 3 (E30) 09/82→03/92					
Guide Bolt, brake caliper					
316	66 09/83→06/88	Construction year from: 07/87 →; Special Purpose Vehicle: for government vehicles; Required quantity: 2; Fitting Position: Front Axle	2	11.8171-0008.1 990049	Brake System: ATE
		+ ABS; Required quantity: 2; Fitting Position: Rear Axle	2	11.8171-0008.1 990049	Brake System: ATE
316 i	73 - 08/87→06/91 75	+ ABS; Special Purpose Vehicle: for government vehicles; Required quantity: 2; Fitting Position: Rear Axle	2	11.8171-0008.1 990049	Brake System: ATE
		Special Purpose Vehicle: for government vehicles; Required quantity: 2; Fitting Position: Front Axle	2	11.8171-0008.1 990049	Brake System: ATE
318 i	75 - 09/82→12/91 85	+ ABS; Special Purpose Vehicle: for government vehicles; Required quantity: 2; Fitting Position: Rear Axle	2	11.8171-0008.1 990049	Brake System: ATE
		Special Purpose Vehicle: for government vehicles; Required quantity: 2; Fitting Position: Front Axle	2	11.8171-0008.1 990049	Brake System: ATE
318 is	100 09/89→08/91	Required quantity: 2; Fitting Position: Front Axle	2	11.8171-0008.1 990049	Brake System: ATE
320 is	141 05/88→12/90				
324 td	85 09/87→08/91	Required quantity: 2; Fitting Position: Rear Axle	2	11.8171-0008.1 990049	Brake System: ATE
325 e 2.7	95 01/85→08/87				
325 i	125 - 09/83→06/91 126				
M3 2.3	143 - 07/86→06/91 147				
M3 EVO I 2.3	162 10/88→10/90				
320 i	92 - 09/82→12/91 95	Required quantity: 2; Fitting Position: Front Axle	2	11.8171-0008.1 990049	Brake System: ATE
		+ ABS; Required quantity: 2; Fitting Position: Rear Axle	2	11.8171-0008.1 990049	Brake System: ATE
→					

	kW				
BMW - 3 (E30) 09/82→03/92					
Guide Bolt, brake caliper					
320 i	92 - 09/82→12/91 95	Construction year from: 09/87 →; Special Purpose Vehicle: for government vehicles; Required quantity: 2; Fitting Position: Rear Axle	2	11.8171-0008.1 990049	Brake System: ATE
323 i 325 i X	110 09/83→09/86 125 - 03/86→08/91 126	Required quantity: 2; Fitting Position: Rear Axle	2	11.8171-0008.1 990049	Brake System: ATE
324 d	63 09/85→12/90	Required quantity: 2; Fitting Position: Front Axle	2	11.8171-0008.1 990049	Brake System: ATE
		+ ABS; Special Purpose Vehicle: for government vehicles; Required quantity: 2; Fitting Position: Rear Axle	2	11.8171-0008.1 990049	Brake System: ATE
325 e 2.7	90 10/83→12/88	→ Construction year to: 09/87; Required quantity: 2; Fitting Position: Front Axle	2	11.8171-0008.1 990049	Brake System: ATE
		→ Construction year to: 09/87; Required quantity: 2; Fitting Position: Rear Axle	2	11.8171-0008.1 990049	Brake System: ATE
M3 2.3	158 01/86→12/90	Construction year from: 07/86 →; Required quantity: 2; Fitting Position: Front Axle	2	11.8171-0008.1 990049	Brake System: ATE
		Construction year from: 07/86 →; Required quantity: 2; Fitting Position: Rear Axle	2	11.8171-0008.1 990049	Brake System: ATE
M3 EVO II 2.5	175 01/90→01/92	→ Construction year to: 12/91; Required quantity: 2; Fitting Position: Front Axle	2	11.8171-0008.1 990049	Brake System: ATE
		→ Construction year to: 12/91; Required quantity: 2; Fitting Position: Rear Axle	2	11.8171-0008.1 990049	Brake System: ATE
BMW - 3 (E36) 09/90→11/98					
Guide Bolt, brake caliper					
316 i	73 - 03/91→05/98 75	+ ABS; Required quantity: 2	2	11.8171-0008.1 990049	Brake System: ATE
		Required quantity: 2; Fitting Position: Front Axle	2	11.8171-0008.1 990049	Brake System: ATE
318 i 318 tds	83 - 09/90→11/98 85 66 01/95→02/98	+ ABS; Required quantity: 2	2	11.8171-0008.1 990049	Brake System: ATE
		Payload: for increased payload; Required quantity: 2	2	11.8171-0008.1 990049	Brake System: ATE
318 is	103 09/93→05/98	Payload: not for increased payload; Required quantity: 2; Fitting Position: Front Axle	2	11.8171-0008.1 990049	Brake System: ATE
		Required quantity: 2	2	11.8171-0008.1 990049	Brake System: ATE
323 i	125 05/95→11/98				
325 i	141 09/90→12/95				
325 tds	105 05/93→02/98				
328 i	142 01/95→04/98				
M3 3.0	210 10/94→07/95				
M3 3.2	236 10/95→01/98				
320 i 325 td	110 01/91→02/98 85 09/91→02/98	Required quantity: 2; Fitting Position: Front Axle	2	11.8171-0008.1 990049	Brake System: ATE
		Required quantity: 2; Fitting Position: Rear Axle	2	11.8171-0008.1 990049	Brake System: ATE
BMW - 3 (E46) 12/97→05/05					
Guide Bolt, brake caliper					
316 i	77 04/00→02/05	Required quantity: 2	2	11.8171-0008.1 990049	Brake System: ATE
		Required quantity: 2; Fitting Position: Rear Axle	2	11.8171-0008.1 990049	Brake System: ATE
316 i 318 i	77 - 12/98→02/05 85 87 12/97→09/01	Required quantity: 2	2	11.8171-0008.1 990049	Brake System: ATE
		Payload: for increased payload; Required quantity: 2	2	11.8171-0008.1 990049	Brake System: ATE
318 d	85 09/01→02/05	Payload: not for increased payload; Required quantity: 2; Fitting Position: Rear Axle	2	11.8171-0008.1 990049	Brake System: ATE
		Required quantity: 2	2	11.8171-0008.1 990049	Brake System: ATE
318 i	100 - 09/01→02/05				
320 d	105				
320 i	95 - 02/98→05/05				
	110				
323 i	110 - 03/98→02/05				
	125				
325 i	120 - 03/98→09/00				
	125				
325 i →	141 09/00→02/05				

	kW				
BMW - 3 (E46) 12/97→05/05					
Guide Bolt, brake caliper					
325 xi	141	09/00→02/05	Required quantity: 2	2	11.8171-0008.1 990049 Brake System: ATE
328 i	142	02/98→06/00			
330 d	135 -	10/99→02/05			
	150				
330 i	170	06/00→02/05			
330 xi	170	06/00→02/05			
330 i	168	01/01→04/05	→ Construction year to: 02/05; Required quantity: 2	2	11.8171-0008.1 990049 Brake System: ATE
330 xd	135	01/00→02/03	Construction year from: 06/00 →; Required quantity: 2	2	11.8171-0008.1 990049 Brake System: ATE
330 xd	150	09/02→12/04	Construction year from: 03/03 →; Required quantity: 2	2	11.8171-0008.1 990049 Brake System: ATE
BMW - 3 (E90) 02/04→02/12					
Guide Bolt, brake caliper					
316 d	85	07/09→12/11	Required quantity: 2	2	11.8171-0008.1 990049 Brake System: ATE
316 i	90	09/07→10/11			
318 d	100	09/07→10/11			
318 i	100 -	09/07→10/11			
	105				
320 d	120	12/04→10/11			
316 i	85	09/05→10/11	→ Construction year to: 08/07; Required quantity: 2	2	11.8171-0008.1 990049 Brake System: ATE
318 d	90	03/05→08/07	Construction year from: 09/05 →; Required quantity: 2	2	11.8171-0008.1 990049 Brake System: ATE
318 d	105	02/07→10/11	Construction year from: 09/07 →; Required quantity: 2	2	11.8171-0008.1 990049 Brake System: ATE
320 i	120	03/07→12/11			
318 i	95	09/05→08/07	Construction year from: 03/07 →; Engine Code: N46N; Required quantity: 2	2	11.8171-0008.1 990049 Brake System: ATE
320 i	110	12/04→08/07	Engine Code: N46; Required quantity: 2	2	11.8171-0008.1 990049 Brake System: ATE
320 d	110	12/04→09/07	Required quantity: 2;	2	11.8171-0008.1 990049 Brake System: ATE
320 d xDrive	120 -	09/08→10/11	Fitting Position: Front Axle		
	135		Special Purpose Vehicle: for government vehicles; Required quantity: 2; Fitting Position: Rear Axle	2	11.8171-0008.1 990049 Brake System: ATE
320 d	115	12/04→09/07	Required quantity: 2;	2	11.8171-0008.1 990049 Brake System: ATE
320 i	125	09/07→10/11	Fitting Position: Front Axle		
320 d	130 -	09/07→10/11	Required quantity: 2	2	11.8171-0008.1 990049 Brake System: ATE
	135		Special Purpose Vehicle: for government vehicles; Required quantity: 2; Fitting Position: Rear Axle	2	11.8171-0008.1 990049 Brake System: ATE
320 i	115	02/07→12/11	Construction year from: 03/07 → → Construction year to: 08/07; Engine Code: N46N; Required quantity: 2	2	11.8171-0008.1 990049 Brake System: ATE
			→ Construction year to: 08/07; Engine Code: N46; Required quantity: 2	2	11.8171-0008.1 990049 Brake System: ATE
320 si	127	09/05→08/06	Construction year from: 06/06 →; Required quantity: 2	2	11.8171-0008.1 990049 Brake System: ATE
323 i	130 -	09/05→12/11	Required quantity: 2;	2	11.8171-0008.1 990049 Brake System: ATE
	140		Fitting Position: Front Axle		
325 i	155	01/06→12/11	Payload: for increased payload; Required quantity: 2;	2	11.8171-0008.1 990049 Brake System: ATE
328 i	172	09/06→12/11	Fitting Position: Rear Axle		
325 d	145 -	09/06→10/11	Required quantity: 2;	2	11.8171-0008.1 990049 Brake System: ATE
	150		Fitting Position: Front Axle		
325 xi	160	09/05→08/06	Required quantity: 2;	2	11.8171-0008.1 990049 Brake System: ATE
330 d	155 -	09/05→12/11	Fitting Position: Rear Axle		
	180				
330 d xDrive	180	09/08→10/11			
330 i xDrive	200	09/08→10/11			
330 xd	170	09/05→08/08			
330 xi	190 -	09/05→08/08			
	200				
335 i xDrive	225	09/08→10/11			
325 i	160	12/04→12/11	Required quantity: 2	2	11.8171-0008.1 990049 Brake System: ATE
			Payload: for increased payload; Required quantity: 2; Fitting Position: Rear Axle	2	11.8171-0008.1 990049 Brake System: ATE
325 i xDrive	155 -	09/08→10/11	Payload: not for increased payload; Required quantity: 2; Fitting Position: Front Axle	2	11.8171-0008.1 990049 Brake System: ATE
	160		Payload: for increased payload; Required quantity: 2; Fitting Position: Rear Axle	2	11.8171-0008.1 990049 Brake System: ATE
→					

	kW				
BMW - 3 (E90) 02/04→02/12					
Guide Bolt, brake caliper					
325 xi	160 09/05→08/08	→ Construction year to: 08/07; Payload: not for increased payload; Engine Code: N52; Required quantity: 2	2	11.8171-0008.1 990049	Brake System: ATE
		Payload: not for increased payload; Engine Code: N52N; Required quantity: 2	2	11.8171-0008.1 990049	Brake System: ATE
		Payload: for increased payload; Required quantity: 2; Fitting Position: Rear Axle	2	11.8171-0008.1 990049	Brake System: ATE
325 xi	160 09/07→08/08	Payload: not for increased payload; Engine Code: N52N; Required quantity: 2	2	11.8171-0008.1 990049	Brake System: ATE
		Required quantity: 2	2	11.8171-0008.1 990049	Brake System: ATE
		Payload: not for increased payload; Engine Code: N52; Required quantity: 2	2	11.8171-0008.1 990049	Brake System: ATE
		Engine Code: N53; Payload: not for increased payload; Required quantity: 2	2	11.8171-0008.1 990049	Brake System: ATE
		Payload: for increased payload; Required quantity: 2; Fitting Position: Rear Axle	2	11.8171-0008.1 990049	Brake System: ATE
330 d	170 09/05→09/08	Required quantity: 2	2	11.8171-0008.1 990049	Brake System: ATE
335 d	210 09/06→12/11	Required quantity: 2; Fitting Position: Rear Axle	2	11.8171-0008.1 990049	Brake System: ATE
335 i	225 09/06→12/11				
335 i xDrive	224 - 05/08→10/11				
335 xi	225 03/07→08/08				
M3	309 12/07→10/11				
M3 CRT	331 03/11→12/11				
330 i	190 12/04→10/11	Payload: not for increased payload; Required quantity: 2	2	11.8171-0008.1 990049	Brake System: ATE
		Required quantity: 2; Fitting Position: Rear Axle	2	11.8171-0008.1 990049	Brake System: ATE
330 i	200 03/07→12/11	Payload: for increased payload; Required quantity: 2; Fitting Position: Front Axle	2	11.8171-0008.1 990049	Brake System: ATE
		Required quantity: 2; Fitting Position: Rear Axle	2	11.8171-0008.1 990049	Brake System: ATE
335 i	220 - 03/06→12/11	Construction year from: 09/06 →; Required quantity: 2	2	11.8171-0008.1 990049	Brake System: ATE
	240				
		Construction year from: 09/06 →; Required quantity: 2; Fitting Position: Rear Axle	2	11.8171-0008.1 990049	Brake System: ATE
335 i	224 03/06→12/11	Construction year from: 09/06 →; Required quantity: 2; Fitting Position: Front Axle	2	11.8171-0008.1 990049	Brake System: ATE
		Construction year from: 09/06 →; Required quantity: 2; Fitting Position: Rear Axle	2	11.8171-0008.1 990049	Brake System: ATE
335 xi	224 - 09/06→06/08	Construction year from: 03/07 →; Required quantity: 2	2	11.8171-0008.1 990049	Brake System: ATE
	240				
		Construction year from: 03/07 →; Required quantity: 2; Fitting Position: Rear Axle	2	11.8171-0008.1 990049	Brake System: ATE
BMW - 3 (G20, G80, G28) 11/18→					
 Brake Pad Set, disc brake					
320 e Plug-in-Hybrid	120 - 07/20→ 150	Braking System: for vehicles without M-sport brakes; Fitting Position: Rear Axle		13.0460-5525.2 605525	Brake System: Mando Wear Warning Contact: prepared for wear indicator / excl. wear warning contact Supplementary Article/Supplementary Info: with accessories
				13.0470-5525.2 LD5525	Brake System: Mando Wear Warning Contact: prepared for wear indicator / excl. wear warning contact Supplementary Article/Supplementary Info: with accessories Ceramic
320 i xDrive	135 07/19→	Braking System: for vehicles without M-sport brakes; Fitting Position: Front Axle		13.0460-7345.2 607345	Brake System: ATE Wear Warning Contact: prepared for wear indicator / excl. wear warning contact
330 d	195 03/19→				
330 d Mild-Hybrid	210 11/20→				
330 d Mild-Hybrid xDrive	210 11/20→				
330 d xDrive	195 07/19→				
330 e Plug-in-Hybrid	135 - 07/19→ 215				
→					



	kW				
BMW - 3 (G20, G80, G28) 11/18→					
 Brake Pad Set, disc brake					
330 e Plug-in-Hybrid xDrive	135 - 07/20→ 215	Braking System: for vehicles without M-sport brakes; Fitting Position: Front Axle		13.0470-7345.2 LD7345	Brake System: ATE Wear Warning Contact: prepared for wear indicator / excl. wear warning contact Ceramic
330 i	190 11/18→	Braking System: for vehicles without M-sport brakes; Fitting Position: Rear Axle		13.0460-5525.2 605525	Brake System: Mando Wear Warning Contact: prepared for wear indicator / excl. wear warning contact Supplementary Article/Supplementary Info: with accessories
330 i xDrive	190 11/18→			13.0470-5525.2 LD5525	Brake System: Mando Wear Warning Contact: prepared for wear indicator / excl. wear warning contact Supplementary Article/Supplementary Info: with accessories Ceramic
BMW - 3 Compact (E36) 01/94→08/00					
Guide Bolt, brake caliper					
316 g	75 02/96→08/00	Required quantity: 2		2 11.8171-0008.1 990049	Brake System: ATE
316 i	75 - 01/94→08/00 77				
318 tds	66 06/95→08/00	Required quantity: 2; Fitting Position: Front Axle		2 11.8171-0008.1 990049	Brake System: ATE
318 ti	103 09/94→12/95				
323 ti	120 - 09/97→08/00 125				
318 ti	103 01/96→08/99	Required quantity: 2; Fitting Position: Rear Axle		2 11.8171-0008.1 990049	Brake System: ATE
		Required quantity: 2; Fitting Position: Front Axle		2 11.8171-0008.1 990049	Brake System: ATE
BMW - 3 Compact (E46) 03/01→02/05					
Guide Bolt, brake caliper					
316 ti	77 - 06/01→02/05 85	Required quantity: 2		2 11.8171-0008.1 990049	Brake System: ATE
318 td	85 03/03→02/05				
320 td	100 - 09/01→02/05 110	Construction year from: 09/01 →; Required quantity: 2		2 11.8171-0008.1 990049	Brake System: ATE
325 ti	141 04/01→12/04				
318 ti	100 - 03/01→12/04 105				
BMW - 3 Convertible (E30) 09/82→11/93					
Guide Bolt, brake caliper					
316 i Baur TC	73 09/87→12/89	+ ABS; Special Purpose Vehicle: for government vehicles; Required quantity: 2; Fitting Position: Rear Axle		2 11.8171-0008.1 990049	Brake System: ATE
318 i	83 09/90→10/93	→ Construction year to: 05/93; Required quantity: 2; Fitting Position: Rear Axle		2 11.8171-0008.1 990049	Brake System: ATE
320 i	95 05/86→11/93	→ Construction year to: 12/92; Required quantity: 2; Fitting Position: Front Axle		2 11.8171-0008.1 990049	Brake System: ATE
325 i	125 08/87→11/93				
		→ Construction year to: 12/92; Required quantity: 2; Fitting Position: Rear Axle		2 11.8171-0008.1 990049	Brake System: ATE
325 i	126 12/85→12/87	Required quantity: 2; Fitting Position: Front Axle		2 11.8171-0008.1 990049	Brake System: ATE
M3 2.3	143 06/88→06/91				
		Required quantity: 2; Fitting Position: Rear Axle		2 11.8171-0008.1 990049	Brake System: ATE
BMW - 3 Convertible (E36) 03/93→11/99					
Guide Bolt, brake caliper					
318 i	85 03/94→11/99	Required quantity: 2		2 11.8171-0008.1 990049	Brake System: ATE
323 i	125 05/95→11/99				
325 i	141 03/93→08/95				
328 i	142 01/95→11/99				
M3 3.0	210 04/94→07/95				
M3 3.2	236 03/96→09/99				
320 i	110 12/93→11/99	Required quantity: 2		2 11.8171-0008.1 990049	Brake System: ATE
		Engine Code: M52 B20 (206S3); Required quantity: 2		2 11.8171-0008.1 990049	Brake System: ATE
		Engine Code: M50 B20 (206S2); Required quantity: 2		2 11.8171-0008.1 990049	Brake System: ATE



BMW - 3 Convertible (E46) 04/00→12/07						
Guide Bolt, brake caliper						
318 Ci	100 12/00→08/06	Construction year from: 09/01 →; Required quantity: 2	2	11.8171-0008.1	990049	Brake System: ATE
		Construction year from: 09/01 →; Required quantity: 2; Fitting Position: Rear Axle	2	11.8171-0008.1	990049	Brake System: ATE
318 Ci	105 09/01→12/07	→ Construction year to: 09/06; Required quantity: 2	2	11.8171-0008.1	990049	Brake System: ATE
330 Cd	150 08/05→12/07	→ Construction year to: 09/06; Required quantity: 2; Fitting Position: Rear Axle	2	11.8171-0008.1	990049	Brake System: ATE
		Required quantity: 2	2	11.8171-0008.1	990049	Brake System: ATE
318 Ci	110 03/04→08/06	Required quantity: 2;	2	11.8171-0008.1	990049	Brake System: ATE
330 Ci	170 06/00→08/06	Required quantity: 2; Fitting Position: Rear Axle	2	11.8171-0008.1	990049	Brake System: ATE
M3	252 03/01→08/06	→ Construction year to: 09/06; Required quantity: 2	2	11.8171-0008.1	990049	Brake System: ATE
320 Cd	110 02/05→12/07	Required quantity: 2	2	11.8171-0008.1	990049	Brake System: ATE
320 Ci	120 - 09/00→12/07 125	→ Construction year to: 09/06; Required quantity: 2	2	11.8171-0008.1	990049	Brake System: ATE
323 Ci	120 - 04/00→09/00 125	Required quantity: 2	2	11.8171-0008.1	990049	Brake System: ATE
325 Ci	141 09/00→08/06					
BMW - 3 Convertible (E93) 05/06→12/13						
Guide Bolt, brake caliper						
318 i	105 03/10→12/13	Required quantity: 2;	2	11.8171-0008.1	990049	Brake System: ATE
320 d	120 - 09/07→12/13 147	Fitting Position: Front Axle				
323 i	140 03/07→09/11	Required quantity: 2;	2	11.8171-0008.1	990049	Brake System: ATE
325 d	145 - 03/07→09/13 155	Fitting Position: Rear Axle				
330 d	180 01/09→12/13					
335 i	225 - 05/06→10/13 240					
M3	309 03/08→10/13					
320 i	115 - 09/06→10/13 125	Construction year from: 03/08 →; Required quantity: 2; Fitting Position: Front Axle	2	11.8171-0008.1	990049	Brake System: ATE
		→ Construction year to: 02/08; Required quantity: 2; Fitting Position: Front Axle	2	11.8171-0008.1	990049	Brake System: ATE
		Required quantity: 2; Fitting Position: Rear Axle	2	11.8171-0008.1	990049	Brake System: ATE
325 i	155 - 10/06→12/13 160	Engine Code: N53/N52N; Required quantity: 2;	2	11.8171-0008.1	990049	Brake System: ATE
330 i	200 03/07→02/10	Fitting Position: Front Axle				
		Required quantity: 2; Fitting Position: Rear Axle	2	11.8171-0008.1	990049	Brake System: ATE
325 i	160 03/07→12/13	Engine Code: N52N/N53; Required quantity: 2; Fitting Position: Front Axle	2	11.8171-0008.1	990049	Brake System: ATE
		Required quantity: 2; Fitting Position: Rear Axle	2	11.8171-0008.1	990049	Brake System: ATE
330 d	170 03/07→12/13	Construction year from: 09/09 →; Required quantity: 2;	2	11.8171-0008.1	990049	Brake System: ATE
330 i	200 03/07→10/13	Fitting Position: Front Axle				
		→ Construction year to: 08/09; Required quantity: 2; Fitting Position: Front Axle	2	11.8171-0008.1	990049	Brake System: ATE
		Required quantity: 2; Fitting Position: Rear Axle	2	11.8171-0008.1	990049	Brake System: ATE
330 i	190 03/10→10/13	Engine Code: N52N; Required quantity: 2; Fitting Position: Front Axle	2	11.8171-0008.1	990049	Brake System: ATE
		Engine Code: N53; Required quantity: 2; Fitting Position: Front Axle	2	11.8171-0008.1	990049	Brake System: ATE
		Required quantity: 2; Fitting Position: Rear Axle	2	11.8171-0008.1	990049	Brake System: ATE
BMW - 3 Coupe (E36) 10/91→05/99						
Guide Bolt, brake caliper						
316 i	75 09/93→11/98	Required quantity: 2	2	11.8171-0008.1	990049	Brake System: ATE
318 is	103 01/92→04/99					
323 i	125 05/95→04/99					
325 i	141 10/91→02/95					
328 i	142 01/95→04/99					
M3 3.0	210 - 11/92→07/95 217					
M3 3.2	236 10/95→11/98					
320 i	110 12/91→11/98	Required quantity: 2	2	11.8171-0008.1	990049	Brake System: ATE
→						

	kW				
BMW - 3 Coupe (E36) 10/91→05/99					
Guide Bolt, brake caliper					
320 i	110	12/91→11/98	Engine Code: M50; Required quantity: 2	2	11.8171-0008.1 990049 Brake System: ATE
			Engine Code: M52 B20 (206S3); Required quantity: 2	2	11.8171-0008.1 990049 Brake System: ATE
BMW - 3 Coupe (E46) 12/98→07/06					
Guide Bolt, brake caliper					
316 Ci	77 - 85	04/00→07/06	Required quantity: 2	2	11.8171-0008.1 990049 Brake System: ATE
318 Ci	85 - 110	12/99→05/06			
320 Cd	110	11/03→07/06			
323 Ci	120 - 125	04/99→09/00			
325 Ci	141	09/00→05/06			
328 Ci	142	12/98→05/00			
318 Ci	100	12/00→05/06	Construction year from: 09/01 →; Required quantity: 2	2	11.8171-0008.1 990049 Brake System: ATE
320 Ci	110	02/99→08/01	Construction year from: 08/99 → → Construction year to: 09/00; Required quantity: 2	2	11.8171-0008.1 990049 Brake System: ATE
320 Ci	120 - 125	01/00→05/06	Construction year from: 09/00 →; Required quantity: 2	2	11.8171-0008.1 990049 Brake System: ATE
330 Cd	150	03/03→07/06	Required quantity: 2;	2	11.8171-0008.1 990049 Brake System: ATE
330 Ci	170	06/00→05/06	Fitting Position: Rear Axle		
330 xi	170	06/00→07/06			
M3	252	07/00→05/06			
M3 CSL	265	05/03→12/03			
BMW - 3 Coupe (E92) 01/05→12/13					
Guide Bolt, brake caliper					
316 i	90	09/07→06/13	Required quantity: 2;	2	11.8171-0008.1 990049 Brake System: ATE
335 i	224	03/07→06/13	Fitting Position: Front Axle		
318 i	105	03/10→12/13	Required quantity: 2;	2	11.8171-0008.1 990049 Brake System: ATE
320 d	120 - 147	09/06→06/13	Fitting Position: Front Axle		
320 d xDrive	120 - 147	09/08→06/13	Required quantity: 2; Fitting Position: Rear Axle	2	11.8171-0008.1 990049 Brake System: ATE
320 i	115 - 125	01/07→12/13			
323 i	140	04/06→02/12			
325 d	150 - 155	02/07→12/13			
325 i	150 - 160	06/06→10/13			
325 i xDrive	155 - 160	09/08→12/13			
325 xi	155 - 160	09/06→02/10			
330 d	170 - 180	03/06→12/13			
330 i xDrive	200	03/10→06/13			
330 xd	170	03/06→08/08			
330 xi	190 - 200	09/06→02/10			
335 i	225 - 240	06/06→06/13			
335 i xDrive	224 - 240	11/08→12/13			
335 xi	225 - 240	03/07→02/10			
M3	309	06/07→06/13			
320 d	130	09/06→02/10	Construction year from: 03/07 →; Required quantity: 2	2	11.8171-0008.1 990049 Brake System: ATE
325 d	145	02/07→02/10	Construction year from: 03/07 →; Required quantity: 2; Fitting Position: Rear Axle	2	11.8171-0008.1 990049 Brake System: ATE
325 i	155	03/10→06/13	Engine Code: N53; Required quantity: 2;	2	11.8171-0008.1 990049 Brake System: ATE
325 i xDrive	150	03/10→04/13	Fitting Position: Front Axle		
330 i	190 - 200	09/06→06/13	Engine Code: N52N; Required quantity: 2; Fitting Position: Front Axle	2	11.8171-0008.1 990049 Brake System: ATE
			Required quantity: 2; Fitting Position: Rear Axle	2	11.8171-0008.1 990049 Brake System: ATE
328 i	172	06/06→06/13	Required quantity: 2	2	11.8171-0008.1 990049 Brake System: ATE
328 i xDrive	172	09/08→06/13	Required quantity: 2;	2	11.8171-0008.1 990049 Brake System: ATE
328 xi	172	09/06→08/08	Fitting Position: Rear Axle		
330 d xDrive	180	02/10→06/13	Required quantity: 2; Fitting Position: Rear Axle	2	11.8171-0008.1 990049 Brake System: ATE
→					

	kW				
BMW - 3 Coupe (E92) 01/05→12/13					
Guide Bolt, brake caliper					
330 i	200	09/07→06/13	Engine Code: N52N; Required quantity: 2	2	11.8171-0008.1 990049 Brake System: ATE
			Engine Code: N53; Required quantity: 2; Fitting Position: Front Axle	2	11.8171-0008.1 990049 Brake System: ATE
			Required quantity: 2; Fitting Position: Rear Axle	2	11.8171-0008.1 990049 Brake System: ATE
330 xd	180	03/08→02/10	Construction year from: 09/09 →; Required quantity: 2; Fitting Position: Front Axle	2	11.8171-0008.1 990049 Brake System: ATE
			→ Construction year to: 08/09; Required quantity: 2; Fitting Position: Front Axle	2	11.8171-0008.1 990049 Brake System: ATE
			Required quantity: 2; Fitting Position: Rear Axle	2	11.8171-0008.1 990049 Brake System: ATE
335 d	210	03/06→03/13	Construction year from: 09/06 →; Required quantity: 2; Fitting Position: Rear Axle	2	11.8171-0008.1 990049 Brake System: ATE
M3 GTS	331	03/07→12/13	→ Construction year to: 06/13; Required quantity: 2	2	11.8171-0008.1 990049 Brake System: ATE
			→ Construction year to: 06/13; Required quantity: 2; Fitting Position: Rear Axle	2	11.8171-0008.1 990049 Brake System: ATE
BMW - 3 Touring (E30) 07/87→10/94					
Guide Bolt, brake caliper					
316 i	73 - 75	09/91→06/94	Required quantity: 2; Fitting Position: Rear Axle	2	11.8171-0008.1 990049 Brake System: ATE
318 i	83 - 85	09/87→06/94			
320 i	95	01/88→12/91	Required quantity: 2;	2	11.8171-0008.1 990049 Brake System: ATE
324 td	85	01/88→06/93	Fitting Position: Front Axle		
325 i	125	07/87→03/93	Required quantity: 2; Fitting Position: Rear Axle	2	11.8171-0008.1 990049 Brake System: ATE
325 i X	125	06/88→10/93	→ Construction year to: 09/93; Required quantity: 2; Fitting Position: Rear Axle	2	11.8171-0008.1 990049 Brake System: ATE
BMW - 3 Touring (E36) 08/94→12/99					
Guide Bolt, brake caliper					
316 i	75	03/97→05/99	Required quantity: 2	2	11.8171-0008.1 990049 Brake System: ATE
318 i	85	09/95→04/99			
318 tds	66	03/95→04/99			
320 i	110	01/95→04/99			
323 i	125	12/95→04/99			
325 tds	105	03/95→04/99			
328 i	142	02/95→04/99			
BMW - 3 Touring (E46) 06/99→07/05					
Guide Bolt, brake caliper					
316 i	85	03/02→02/05	Required quantity: 2	2	11.8171-0008.1 990049 Brake System: ATE
318 d	85	10/02→02/05			
318 i	85 - 105	10/99→07/05			
320 d	100 - 110	03/00→02/05			
320 i	110 - 125	10/99→02/05			
325 i	141	09/00→02/05			
325 xi	141	09/00→02/05			
328 i	142	06/99→05/00			
330 xi	170	06/00→02/05			
330 d	135 - 150	10/99→02/05	Required quantity: 2	2	11.8171-0008.1 990049 Brake System: ATE
330 i	170	06/00→02/05	Required quantity: 2; Fitting Position: Rear Axle	2	11.8171-0008.1 990049 Brake System: ATE
330 xd	135	01/00→03/03	Construction year from: 06/00 →; Required quantity: 2	2	11.8171-0008.1 990049 Brake System: ATE
330 xd	150	08/02→05/05	Construction year from: 03/03 → → Construction year to: 02/05; Required quantity: 2	2	11.8171-0008.1 990049 Brake System: ATE
BMW - 3 Touring (E91) 12/04→12/12					
Guide Bolt, brake caliper					
316 d	85	09/09→06/12	Required quantity: 2;	2	11.8171-0008.1 990049 Brake System: ATE
316 i	90	09/08→06/12	Fitting Position: Front Axle		
318 d	90 - 105	09/05→06/12	Required quantity: 2; Fitting Position: Rear Axle	2	11.8171-0008.1 990049 Brake System: ATE
→					

	kW				
BMW - 3 Touring (E91) 12/04→12/12					
Guide Bolt, brake caliper					
318 i	95 - 01/06→03/12 100	Required quantity: 2; Fitting Position: Front Axle	2	11.8171-0008.1 990049	Brake System: ATE
320 d	110 - 12/04→06/12 147	Required quantity: 2; Fitting Position: Rear Axle	2	11.8171-0008.1 990049	Brake System: ATE
320 d xDrive	120 - 02/08→06/12 147				
320 i	120 - 02/07→12/12 125				
323 i	140 09/06→07/08				
325 d	145 - 09/06→06/12 150				
325 i	155 - 12/04→06/12 160				
330 d	155 - 06/05→05/12 180				
330 d xDrive	180 01/09→06/12				
330 i	190 - 08/05→06/12 200				
330 i xDrive	200 09/07→06/12				
330 xd	170 09/05→06/12				
330 xi	190 - 09/05→06/12 200				
335 d	210 09/06→06/12				
335 i	225 - 09/06→06/12 240				
335 i xDrive	225 - 09/08→06/12 240				
335 xi	225 - 03/07→08/08 240				
318 i	105 05/07→05/12	Payload: for increased payload; Required quantity: 2; Fitting Position: Front Axle	2	11.8171-0008.1 990049	Brake System: ATE
		Payload: not for increased payload; Required quantity: 2; Fitting Position: Front Axle	2	11.8171-0008.1 990049	Brake System: ATE
		Required quantity: 2; Fitting Position: Rear Axle	2	11.8171-0008.1 990049	Brake System: ATE
320 i	110 - 09/05→06/12 115	Engine Code: N46N; Required quantity: 2; Fitting Position: Front Axle	2	11.8171-0008.1 990049	Brake System: ATE
		Engine Code: N46; Required quantity: 2; Fitting Position: Front Axle	2	11.8171-0008.1 990049	Brake System: ATE
		Required quantity: 2; Fitting Position: Rear Axle	2	11.8171-0008.1 990049	Brake System: ATE
323 i	130 04/06→06/07	Construction year from: 09/06 →; Required quantity: 2	2	11.8171-0008.1 990049	Brake System: ATE
325 i	160 09/07→06/12	Payload: for increased payload; Required quantity: 2; Fitting Position: Front Axle	2	11.8171-0008.1 990049	Brake System: ATE
		Engine Code: N52N/N53; Payload: not for increased payload; Required quantity: 2; Fitting Position: Front Axle	2	11.8171-0008.1 990049	Brake System: ATE
		Payload: for increased payload; Required quantity: 2; Fitting Position: Rear Axle	2	11.8171-0008.1 990049	Brake System: ATE
325 i xDrive	155 - 09/08→06/12 160	Engine Code: N52/N53/N25N; Required quantity: 2; Fitting Position: Front Axle	2	11.8171-0008.1 990049	Brake System: ATE
		Engine Code: N52/N53/N25N; Required quantity: 2; Fitting Position: Rear Axle	2	11.8171-0008.1 990049	Brake System: ATE
325 xi	155 - 08/05→08/08 160	Engine Code: N52N; Required quantity: 2; Fitting Position: Front Axle	2	11.8171-0008.1 990049	Brake System: ATE
		Engine Code: N52/N53; Required quantity: 2; Fitting Position: Front Axle	2	11.8171-0008.1 990049	Brake System: ATE
		Engine Code: N52N; Payload: for increased payload; Required quantity: 2; Fitting Position: Rear Axle	2	11.8171-0008.1 990049	Brake System: ATE
		Engine Code: N52/N53; Required quantity: 2; Fitting Position: Rear Axle	2	11.8171-0008.1 990049	Brake System: ATE
330 d	170 12/04→08/08	Construction year from: 09/07 →; Required quantity: 2; Fitting Position: Front Axle	2	11.8171-0008.1 990049	Brake System: ATE
→					

	kW				
BMW - 3 Touring (E91) 12/04→12/12					
Guide Bolt, brake caliper					
330 d	170 12/04→08/08	→ Construction year to: 08/07; Required quantity: 2; Fitting Position: Front Axle	2	11.8171-0008.1 990049	Brake System: ATE
		Required quantity: 2; Fitting Position: Rear Axle	2	11.8171-0008.1 990049	Brake System: ATE
BMW - 3 Touring (G21, G81) 07/19→					
 Brake Pad Set, disc brake					
318 d Mild-Hybrid	100 - 08/20→ 110	Braking System: for vehicles without M-sport brakes; Fitting Position: Rear Axle		13.0460-5525.2 605525	Brake System: Mando Wear Warning Contact: prepared for wear indicator / excl. wear warning contact Supplementary Article/Supplementary Info: with accessories
320 e Plug-in-Hybrid	120 - 07/20→ 150				
320 e Plug-in-Hybrid xDrive	120 - 03/21→ 150				
330 d	195 11/19→	Braking System: for vehicles without M-sport brakes; Fitting Position: Front Axle		13.0460-7345.2 607345	Brake System: ATE Wear Warning Contact: prepared for wear indicator / excl. wear warning contact
330 d Mild-Hybrid	210 11/20→				
330 d Mild-Hybrid xDrive	210 11/20→				
330 d xDrive	195 07/19→				
330 e Plug-in-Hybrid	135 - 07/20→ 215				
330 e Plug-in-Hybrid xDrive	135 - 07/20→ 215				
330 i	190 07/19→	Braking System: for vehicles without M-sport brakes; Fitting Position: Rear Axle		13.0460-5525.2 605525	Brake System: Mando Wear Warning Contact: prepared for wear indicator / excl. wear warning contact Supplementary Article/Supplementary Info: with accessories
330 i xDrive	190 07/19→				
BMW - 3 Touring Van (G21) 07/19→					
 Brake Pad Set, disc brake					
330 d	195 11/19→	Braking System: for vehicles without M-sport brakes; Fitting Position: Front Axle		13.0460-7345.2 607345	Brake System: ATE Wear Warning Contact: prepared for wear indicator / excl. wear warning contact
330 d xDrive	195 11/19→				
330 i	190 07/19→				
		Braking System: for vehicles without M-sport brakes; Fitting Position: Rear Axle		13.0460-5525.2 605525	Brake System: Mando Wear Warning Contact: prepared for wear indicator / excl. wear warning contact Supplementary Article/Supplementary Info: with accessories
BMW - 4 Convertible (G23, G83) 11/20→					
 Brake Pad Set, disc brake					
430 d Mild-Hybrid	210 07/21→	Braking System: for vehicles without M-sport brakes; Fitting Position: Front Axle		13.0460-7345.2 607345	Brake System: ATE Wear Warning Contact: prepared for wear indicator / excl. wear warning contact
→					

	kW			
BMW - 4 Convertible (G23, G83) 11/20→				
 Brake Pad Set, disc brake				
430 d Mild-Hybrid	210 07/21→	Braking System: for vehicles without M-sport brakes; Fitting Position: Front Axle	13.0470-7345.2 LD7345	Brake System: ATE Wear Warning Contact: prepared for wear indicator / excl. wear warning contact Ceramic
430 i 430 i xDrive	180 - 11/20→ 190 180 07/21→	Braking System: for vehicles without M-sport brakes; Fitting Position: Front Axle	13.0460-7345.2 607345 13.0470-7345.2 LD7345	Brake System: ATE Wear Warning Contact: prepared for wear indicator / excl. wear warning contact Brake System: ATE Wear Warning Contact: prepared for wear indicator / excl. wear warning contact Ceramic
		Braking System: for vehicles without M-sport brakes; Fitting Position: Rear Axle	13.0460-5525.2 605525 13.0470-5525.2 LD5525	Brake System: Mando Wear Warning Contact: prepared for wear indicator / excl. wear warning contact Supplementary Article/Supplementary Info: with accessories Brake System: Mando Wear Warning Contact: prepared for wear indicator / excl. wear warning contact Supplementary Article/Supplementary Info: with accessories Ceramic
BMW - 4 Coupe (G22, G82) 07/20→				
 Brake Pad Set, disc brake				
430 d Mild-Hybrid xDrive	210 03/21→	Braking System: for vehicles without M-sport brakes; Fitting Position: Front Axle	13.0460-7345.2 607345 13.0470-7345.2 LD7345	Brake System: ATE Wear Warning Contact: prepared for wear indicator / excl. wear warning contact Brake System: ATE Wear Warning Contact: prepared for wear indicator / excl. wear warning contact Ceramic
430 i 430 i xDrive	180 - 07/20→ 190 180 - 07/21→ 190	Braking System: for vehicles without M-sport brakes; Fitting Position: Front Axle	13.0460-7345.2 607345 13.0470-7345.2 LD7345	Brake System: ATE Wear Warning Contact: prepared for wear indicator / excl. wear warning contact Brake System: ATE Wear Warning Contact: prepared for wear indicator / excl. wear warning contact Ceramic
		Braking System: for vehicles without M-sport brakes; Fitting Position: Rear Axle	13.0460-5525.2 605525 13.0470-5525.2 LD5525	Brake System: Mando Wear Warning Contact: prepared for wear indicator / excl. wear warning contact Supplementary Article/Supplementary Info: with accessories Brake System: Mando Wear Warning Contact: prepared for wear indicator / excl. wear warning contact Supplementary Article/Supplementary Info: with accessories Ceramic
BMW - 4 Gran Coupe (G26) 07/21→				
 Brake Pad Set, disc brake				
2.0 430 i xDrive 430 i	180 03/22→ 180 07/21→	Braking System: for vehicles without M-sport brakes; Fitting Position: Front Axle	13.0460-7345.2 607345 13.0470-7345.2 LD7345	Brake System: ATE Wear Warning Contact: prepared for wear indicator / excl. wear warning contact Brake System: ATE Wear Warning Contact: prepared for wear indicator / excl. wear warning contact Ceramic
		Braking System: for vehicles without M-sport brakes; Fitting Position: Rear Axle	13.0460-5525.2 605525	Brake System: Mando Wear Warning Contact: prepared for wear indicator / excl. wear warning contact Supplementary Article/Supplementary Info: with accessories
→				

	kW				
BMW - 4 Gran Coupe (G26) 07/21→					
 Brake Pad Set, disc brake					
2.0 430 i xDrive 430 i	180 03/22→ 180 07/21→		Braking System: for vehicles without M-sport brakes; Fitting Position: Rear Axle	13.0470-5525.2 LD5525	Brake System: Mando Wear Warning Contact: prepared for wear indicator / excl. wear warning contact Supplementary Article/Supplementary Info: with accessories Ceramic
BMW - 5 (E28) 05/81→12/87					
Guide Bolt, brake caliper					
518	66 06/81→09/84		- ABS; Special Purpose Vehicle: not for government vehicles; Required quantity: 2; Fitting Position: Front Axle	2 11.8171-0008.1 990049	Brake System: ATE
			+ ABS; Special Purpose Vehicle: for government vehicles; Required quantity: 2; Fitting Position: Front Axle	2 11.8171-0008.1 990049	Brake System: ATE
			+ ABS; Required quantity: 2; Fitting Position: Rear Axle	2 11.8171-0008.1 990049	Brake System: ATE
518 i	75 - 05/81→12/87 77		Construction year from: 11/83 →; - ABS; Special Purpose Vehicle: not for government vehicles; Required quantity: 2; Fitting Position: Front Axle	2 11.8171-0008.1 990049	Brake System: ATE
			Construction year from: 11/83 →; + ABS; Special Purpose Vehicle: for government vehicles; Required quantity: 2; Fitting Position: Front Axle	2 11.8171-0008.1 990049	Brake System: ATE
			Construction year from: 11/83 →; + ABS; Required quantity: 2; Fitting Position: Rear Axle	2 11.8171-0008.1 990049	Brake System: ATE
520 i 524 td	92 06/81→12/87 85 09/83→12/87		Construction year from: 09/84 →; - ABS; Required quantity: 2; Fitting Position: Front Axle	2 11.8171-0008.1 990049	Brake System: ATE
			→ Construction year to: 08/84; - ABS; Special Purpose Vehicle: not for government vehicles; Required quantity: 2; Fitting Position: Front Axle	2 11.8171-0008.1 990049	Brake System: ATE
			+ ABS; Special Purpose Vehicle: for government vehicles; Required quantity: 2; Fitting Position: Front Axle	2 11.8171-0008.1 990049	Brake System: ATE
			→ Construction year to: 03/86; + ABS; Required quantity: 2; Fitting Position: Rear Axle	2 11.8171-0008.1 990049	Brake System: ATE
			Construction year from: 04/86 →; Required quantity: 2; Fitting Position: Rear Axle	2 11.8171-0008.1 990049	Brake System: ATE
520 i	95 08/85→12/87		- ABS; Required quantity: 2; Fitting Position: Front Axle	2 11.8171-0008.1 990049	Brake System: ATE
			+ ABS; Special Purpose Vehicle: for government vehicles; Required quantity: 2; Fitting Position: Front Axle	2 11.8171-0008.1 990049	Brake System: ATE
			→ Construction year to: 03/86; + ABS; Required quantity: 2; Fitting Position: Rear Axle	2 11.8171-0008.1 990049	Brake System: ATE
			Construction year from: 04/86 →; Required quantity: 2; Fitting Position: Rear Axle	2 11.8171-0008.1 990049	Brake System: ATE
520 i	110 12/86→12/87		- ABS; Required quantity: 2; Fitting Position: Front Axle	2 11.8171-0008.1 990049	Brake System: ATE
			+ ABS; Special Purpose Vehicle: for government vehicles; Required quantity: 2; Fitting Position: Front Axle	2 11.8171-0008.1 990049	Brake System: ATE
			Required quantity: 2; Fitting Position: Rear Axle	2 11.8171-0008.1 990049	Brake System: ATE
524 d	63 03/86→12/87		Construction year from: 05/86 →; Required quantity: 2; Fitting Position: Front Axle	2 11.8171-0008.1 990049	Brake System: ATE
			Construction year from: 05/86 →; Required quantity: 2; Fitting Position: Rear Axle	2 11.8171-0008.1 990049	Brake System: ATE
525 e	90 - 09/81→12/87 95		Required quantity: 2; Fitting Position: Front Axle	2 11.8171-0008.1 990049	Brake System: ATE
525 i	110 06/81→12/87		Required quantity: 2; Fitting Position: Rear Axle	2 11.8171-0008.1 990049	Brake System: ATE
→					

	kW				
BMW - 5 (E28) 05/81→12/87					
Guide Bolt, brake caliper					
535 i	136 - 01/85→12/87 162	Required quantity: 2; Fitting Position: Front Axle	2	11.8171-0008.1 990049	Brake System: ATE
M 535 i	136 - 01/85→12/87 141	Required quantity: 2; Fitting Position: Rear Axle	2	11.8171-0008.1 990049	Brake System: ATE
528 i	135 06/81→12/87	Construction year from: 06/84 →; Required quantity: 2; Fitting Position: Front Axle	2	11.8171-0008.1 990049	Brake System: ATE
		→ Construction year to: 05/84; Required quantity: 2; Fitting Position: Front Axle	2	11.8171-0008.1 990049	Brake System: ATE
		Required quantity: 2; Fitting Position: Rear Axle	2	11.8171-0008.1 990049	Brake System: ATE
M5	210 08/85→12/87	Required quantity: 2; Fitting Position: Rear Axle	2	11.8171-0008.1 990049	Brake System: ATE
BMW - 5 (E34) 02/87→12/95					
Guide Bolt, brake caliper					
518 i	83 - 09/89→08/95 85	Required quantity: 2; Fitting Position: Front Axle	2	11.8171-0008.1 990049	Brake System: ATE
		+ ABS; Required quantity: 2; Fitting Position: Rear Axle	2	11.8171-0008.1 990049	Brake System: ATE
520 i	95 06/87→09/90	Required quantity: 2; Fitting Position: Front Axle	2	11.8171-0008.1 990049	Brake System: ATE
520 i 24V	110 04/90→08/95	Required quantity: 2; Fitting Position: Front Axle	2	11.8171-0008.1 990049	Brake System: ATE
524 td	85 03/88→08/91	Required quantity: 2; Fitting Position: Rear Axle	2	11.8171-0008.1 990049	Brake System: ATE
525 i	125 02/88→08/90	Required quantity: 2; Fitting Position: Rear Axle	2	11.8171-0008.1 990049	Brake System: ATE
525 i 24V	141 03/90→08/95				
525 iX 24V	141 10/91→08/95				
525 td	85 03/93→08/95				
525 tds	105 09/91→08/95				
530 i	138 01/88→04/90				
530 i V8	160 09/92→12/95				
535 i	155 11/87→02/93				
540 i V8	210 09/92→12/95				
M5	232 09/88→03/92	Required quantity: 2; Fitting Position: Front Axle	2	11.8171-0008.1 990049	Brake System: ATE
		Construction year from: 01/90 →; Required quantity: 2; Fitting Position: Rear Axle	2	11.8171-0008.1 990049	Brake System: ATE
		→ Construction year to: 12/89; Required quantity: 2; Fitting Position: Rear Axle	2	11.8171-0008.1 990049	Brake System: ATE
M5	250 01/92→07/95	→ Construction year to: 05/94; Required quantity: 2; Fitting Position: Front Axle	2	11.8171-0008.1 990049	Brake System: ATE
		Construction year from: 06/94 →; Required quantity: 2; Fitting Position: Rear Axle	2	11.8171-0008.1 990049	Brake System: ATE
		→ Construction year to: 05/94; Required quantity: 2; Fitting Position: Rear Axle	2	11.8171-0008.1 990049	Brake System: ATE
BMW - 5 (E39) 09/95→07/03					
Guide Bolt, brake caliper					
520 d 525 d	100 02/00→06/03 120 02/00→06/03	Construction year from: 04/00 →; Required quantity: 2; Fitting Position: Front Axle	2	11.8171-0008.1 990049	Brake System: ATE
		Construction year from: 04/00 →; Required quantity: 2; Fitting Position: Rear Axle	2	11.8171-0008.1 990049	Brake System: ATE
520 i	100 01/96→06/03	→ Construction year to: 03/00; Special Purpose Vehicle: for government vehicles; Required quantity: 2	2	11.8171-0008.1 990049	Brake System: ATE
		Construction year from: 04/00 →; Special Purpose Vehicle: for government vehicles; Required quantity: 2; Fitting Position: Front Axle	2	11.8171-0008.1 990049	Brake System: ATE
		Special Purpose Vehicle: not for government vehicles; Required quantity: 2; Fitting Position: Front Axle	2	11.8171-0008.1 990049	Brake System: ATE
		Required quantity: 2; Fitting Position: Rear Axle	2	11.8171-0008.1 990049	Brake System: ATE
520 i	110 01/96→06/03	Construction year from: 03/96 → → Construction year to: 03/00; Special Purpose Vehicle: for government vehicles; Required quantity: 2	2	11.8171-0008.1 990049	Brake System: ATE
		Construction year from: 11/96 →; Special Purpose Vehicle: not for govern-	2	11.8171-0008.1 990049	Brake System: ATE
→					

	kW				
BMW - 5 (E39) 09/95→07/03					
Guide Bolt, brake caliper					
520 i	110 01/96→06/03	ment vehicles; Required quantity: 2; Fitting Position: Front Axle			
		Construction year from: 04/00 →; Special Purpose Vehicle: for government vehicles; Required quantity: 2; Fitting Position: Front Axle	2	11.8171-0008.1 990049	Brake System: ATE
		Construction year from: 03/96 → → Construction year to: 10/96; Special Purpose Vehicle: not for govern- ment vehicles; Required quantity: 2; Fitting Position: Front Axle	2	11.8171-0008.1 990049	Brake System: ATE
520 i	120 - 09/00→06/03 125	Construction year from: 03/96 →; Required quantity: 2; Fitting Position: Rear Axle	2	11.8171-0008.1 990049	Brake System: ATE
		Special Purpose Vehicle: not for govern- ment vehicles; Required quantity: 2; Fitting Position: Front Axle	2	11.8171-0008.1 990049	Brake System: ATE
		Special Purpose Vehicle: for government vehicles; Required quantity: 2; Fitting Position: Front Axle	2	11.8171-0008.1 990049	Brake System: ATE
523 i	125 09/95→08/00	Required quantity: 2; Fitting Position: Rear Axle	2	11.8171-0008.1 990049	Brake System: ATE
		Construction year from: 12/95 → → Construction year to: 10/96; Required quantity: 2; Fitting Position: Front Axle	2	11.8171-0008.1 990049	Brake System: ATE
		Construction year from: 11/96 →; Required quantity: 2; Fitting Position: Front Axle	2	11.8171-0008.1 990049	Brake System: ATE
525 i 530 i	141 09/00→06/03 170 09/00→06/03	Construction year from: 12/95 → → Construction year to: 08/98; Required quantity: 2; Fitting Position: Rear Axle	2	11.8171-0008.1 990049	Brake System: ATE
		Construction year from: 09/98 →; Required quantity: 2; Fitting Position: Rear Axle	2	11.8171-0008.1 990049	Brake System: ATE
		Construction year from: 10/00 →; Required quantity: 2; Fitting Position: Front Axle	2	11.8171-0008.1 990049	Brake System: ATE
525 td	85 01/97→06/03	Construction year from: 10/00 →; Required quantity: 2; Fitting Position: Rear Axle	2	11.8171-0008.1 990049	Brake System: ATE
		→ Construction year to: 09/00; Required quantity: 2; Fitting Position: Front Axle	2	11.8171-0008.1 990049	Brake System: ATE
525 tds	105 01/96→06/03	→ Construction year to: 09/00; Required quantity: 2; Fitting Position: Rear Axle	2	11.8171-0008.1 990049	Brake System: ATE
		Construction year from: 11/96 → → Construction year to: 09/00; Required quantity: 2; Fitting Position: Front Axle	2	11.8171-0008.1 990049	Brake System: ATE
		Construction year from: 02/96 → → Construction year to: 10/96; Required quantity: 2; Fitting Position: Front Axle	2	11.8171-0008.1 990049	Brake System: ATE
528 i	142 09/95→08/00	Construction year from: 02/96 → → Construction year to: 09/00; Required quantity: 2; Fitting Position: Rear Axle	2	11.8171-0008.1 990049	Brake System: ATE
		Construction year from: 12/95 → → Construction year to: 10/96; Required quantity: 2; Fitting Position: Front Axle	2	11.8171-0008.1 990049	Brake System: ATE
		Construction year from: 11/96 →; Required quantity: 2; Fitting Position: Front Axle	2	11.8171-0008.1 990049	Brake System: ATE
530 d	135 08/98→09/00	Construction year from: 12/95 →; Required quantity: 2; Fitting Position: Rear Axle	2	11.8171-0008.1 990049	Brake System: ATE
		Construction year from: 09/98 →; Required quantity: 2; Fitting Position: Front Axle	2	11.8171-0008.1 990049	Brake System: ATE
530 d	142 09/98→06/03	Construction year from: 09/98 →; Required quantity: 2; Fitting Position: Rear Axle	2	11.8171-0008.1 990049	Brake System: ATE
530 d	142 09/98→06/03	Construction year from: 10/00 →; Required quantity: 2; Fitting Position: Front Axle	2	11.8171-0008.1 990049	Brake System: ATE
→					

	kW				
BMW - 5 (E39) 09/95→07/03					
Guide Bolt, brake caliper					
530 d	142	09/98→06/03	→ Construction year to: 09/00; Required quantity: 2; Fitting Position: Front Axle	2	11.8171-0008.1 990049 Brake System: ATE
			Required quantity: 2; Fitting Position: Rear Axle	2	11.8171-0008.1 990049 Brake System: ATE
535 i	173	06/96→08/98	Construction year from: 09/97 →; Required quantity: 2	2	11.8171-0008.1 990049 Brake System: ATE
			Construction year from: 11/96 → → Construction year to: 08/97; Required quantity: 2; Fitting Position: Front Axle	2	11.8171-0008.1 990049 Brake System: ATE
			→ Construction year to: 10/96; Required quantity: 2; Fitting Position: Front Axle	2	11.8171-0008.1 990049 Brake System: ATE
			Required quantity: 2; Fitting Position: Rear Axle	2	11.8171-0008.1 990049 Brake System: ATE
535 i	180	09/98→06/03	→ Construction year to: 03/00; Required quantity: 2	2	11.8171-0008.1 990049 Brake System: ATE
			Construction year from: 04/00 →; Required quantity: 2; Fitting Position: Front Axle	2	11.8171-0008.1 990049 Brake System: ATE
			Required quantity: 2; Fitting Position: Rear Axle	2	11.8171-0008.1 990049 Brake System: ATE
540 i	210	03/96→06/03	Construction year from: 05/96 → → Construction year to: 03/00; Required quantity: 2	2	11.8171-0008.1 990049 Brake System: ATE
			Construction year from: 04/00 →; Required quantity: 2; Fitting Position: Front Axle	2	11.8171-0008.1 990049 Brake System: ATE
			Construction year from: 05/96 →; Required quantity: 2; Fitting Position: Rear Axle	2	11.8171-0008.1 990049 Brake System: ATE
M5	294	10/98→06/03	Required quantity: 2; Fitting Position: Front Axle	2	11.8171-0008.1 990049 Brake System: ATE
			Required quantity: 2; Fitting Position: Rear Axle	2	11.8171-0008.1 990049 Brake System: ATE
BMW - 5 (E60) 12/01→03/10					
Guide Bolt, brake caliper					
520 d	110 -	09/05→12/09	Required quantity: 2	2	11.8171-0008.1 990049 Brake System: ATE
525 d xDrive	145	09/07→12/09			
525 i	141	09/03→02/05			
525 xi	160	04/05→12/09			
530 d xDrive	173	09/07→12/09			
530 i xDrive	200	09/08→12/09			
530 xd	173	03/07→08/07			
530 xi	200	03/07→10/09			
520 i	125	07/03→03/10	Transmission Type: Manual Transmis- sion; → Construction year to: 03/05; Required quantity: 2	2	11.8171-0008.1 990049 Brake System: ATE
			Transmission Type: Automatic Transmis- sion; → Construction year to: 03/05; Required quantity: 2	2	11.8171-0008.1 990049 Brake System: ATE
			→ Construction year to: 03/05; Required quantity: 2	2	11.8171-0008.1 990049 Brake System: ATE
523 i	130	10/04→02/07	Construction year from: 07/05 →;	2	11.8171-0008.1 990049 Brake System: ATE
530 xd	170	02/05→02/07	Required quantity: 2		
530 xi	190	09/04→02/07			
523 i	140	03/07→12/09	Required quantity: 2	2	11.8171-0008.1 990049 Brake System: ATE
			Engine Code: N52N; Required quantity: 2	2	11.8171-0008.1 990049 Brake System: ATE
			Engine Code: N53; Required quantity: 2	2	11.8171-0008.1 990049 Brake System: ATE
525 d	120 -	06/04→03/10	Transmission Type: Manual Transmis- sion; → Construction year to: 03/07; Required quantity: 2	2	11.8171-0008.1 990049 Brake System: ATE
			Transmission Type: Automatic Transmis- sion; → Construction year to: 03/07; Required quantity: 2	2	11.8171-0008.1 990049 Brake System: ATE
			→ Construction year to: 03/07; Required quantity: 2	2	11.8171-0008.1 990049 Brake System: ATE
525 d	145	01/07→03/10	Construction year from: 03/07 → → Construction year to: 02/10; Required quantity: 2	2	11.8171-0008.1 990049 Brake System: ATE
			Construction year from: 03/07 → → Construction year to: 02/10; Special Purpose Vehicle: for government	2	11.8171-0008.1 990049 Brake System: ATE
→					

	kW				
BMW - 5 (E60) 12/01→03/10					
Guide Bolt, brake caliper					
525 d	145	01/07→03/10	vehicles; Required quantity: 2; Fitting Position: Rear Axle		
525 i	137	07/03→12/09	Construction year from: 07/05 → → Construction year to: 03/07; Required quantity: 2	2	11.8171-0008.1 990049 Brake System: ATE
525 i	155 - 160	07/05→03/10	Construction year from: 03/07 → → Construction year to: 02/10; Engine Code: N52N; Required quantity: 2	2	11.8171-0008.1 990049 Brake System: ATE
			Construction year from: 03/07 → → Construction year to: 02/10; Engine Code: N53; Required quantity: 2	2	11.8171-0008.1 990049 Brake System: ATE
			Construction year from: 03/07 → ; Engine Code: N53; Special Purpose Vehicle: not for govern- ment vehicles; → Construction year to: 02/10; Required quantity: 2	2	11.8171-0008.1 990049 Brake System: ATE
			→ Construction year to: 03/07; Required quantity: 2	2	11.8171-0008.1 990049 Brake System: ATE
			Construction year from: 03/07 → → Construction year to: 02/10; Engine Code: N53; Special Purpose Vehicle: for government vehicles; Required quantity: 2; Fitting Position: Rear Axle	2	11.8171-0008.1 990049 Brake System: ATE
525 i	160	03/05→12/09	Construction year from: 07/05 → → Construction year to: 03/07; Required quantity: 2	2	11.8171-0008.1 990049 Brake System: ATE
			Construction year from: 03/07 → ; Engine Code: N52N; Required quantity: 2	2	11.8171-0008.1 990049 Brake System: ATE
			Construction year from: 03/07 → ; Engine Code: N53; Special Purpose Vehicle: not for govern- ment vehicles; Required quantity: 2	2	11.8171-0008.1 990049 Brake System: ATE
			Construction year from: 03/07 → ; Engine Code: N53; Required quantity: 2	2	11.8171-0008.1 990049 Brake System: ATE
			Construction year from: 03/07 → ; Engine Code: N53; Special Purpose Vehicle: for government vehicles; Required quantity: 2; Fitting Position: Rear Axle	2	11.8171-0008.1 990049 Brake System: ATE
525 i 530 i	160	03/05→03/07 03/05→03/07	Construction year from: 07/05 → ; Required quantity: 2	2	11.8171-0008.1 990049 Brake System: ATE
			Construction year from: 07/05 → ; Special Purpose Vehicle: for government vehicles; Required quantity: 2; Fitting Position: Rear Axle	2	11.8171-0008.1 990049 Brake System: ATE
525 i xDrive	160	09/08→03/10	→ Construction year to: 02/10; Required quantity: 2	2	11.8171-0008.1 990049 Brake System: ATE
525 xd 530 xi	145	11/06→08/07 02/07→08/08	Construction year from: 03/07 → ; Required quantity: 2	2	11.8171-0008.1 990049 Brake System: ATE
528 i 530 i	172 200	03/07→12/09 03/07→12/09	Engine Code: N53; Required quantity: 2	2	11.8171-0008.1 990049 Brake System: ATE
			Engine Code: N52N; Required quantity: 2	2	11.8171-0008.1 990049 Brake System: ATE
			Special Purpose Vehicle: for government vehicles; Engine Code: N52N; Required quantity: 2; Fitting Position: Rear Axle	2	11.8171-0008.1 990049 Brake System: ATE
530 d	155 - 160	09/02→12/09	Construction year from: 07/03 → → Construction year to: 08/05; Required quantity: 2	2	11.8171-0008.1 990049 Brake System: ATE
			Construction year from: 07/03 → ; Special Purpose Vehicle: for government vehicles; → Construction year to: 08/05; Required quantity: 2; Fitting Position: Rear Axle	2	11.8171-0008.1 990049 Brake System: ATE
530 d	170	09/05→03/07	Required quantity: 2	2	11.8171-0008.1 990049 Brake System: ATE
			Special Purpose Vehicle: for government vehicles; Required quantity: 2; Fitting Position: Rear Axle	2	11.8171-0008.1 990049 Brake System: ATE
530 d	173	02/07→12/09	Construction year from: 03/07 → ; Required quantity: 2	2	11.8171-0008.1 990049 Brake System: ATE
			Construction year from: 03/07 → ; Special Purpose Vehicle: for government	2	11.8171-0008.1 990049 Brake System: ATE

	kW				
BMW - 5 (E60) 12/01→03/10					
Guide Bolt, brake caliper					
530 d	173	02/07→12/09	vehicles; Required quantity: 2; Fitting Position: Rear Axle		
530 i	170	12/01→02/05	Construction year from: 07/03 →; Required quantity: 2	2	11.8171-0008.1 990049 Brake System: ATE
530 i	187	03/05→03/10	Construction year from: 07/05 → → Construction year to: 03/07; Required quantity: 2	2	11.8171-0008.1 990049 Brake System: ATE
			Construction year from: 07/05 → → Construction year to: 03/07; Special Purpose Vehicle: for government vehicles; Required quantity: 2; Fitting Position: Rear Axle	2	11.8171-0008.1 990049 Brake System: ATE
535 d	200	09/04→03/10	→ Construction year to: 03/07; Required quantity: 2; Fitting Position: Rear Axle	2	11.8171-0008.1 990049 Brake System: ATE
535 d	210	01/07→03/10	Construction year from: 03/07 → → Construction year to: 02/10; Required quantity: 2; Fitting Position: Rear Axle	2	11.8171-0008.1 990049 Brake System: ATE
535 i	225	04/06→12/09	→ Construction year to: 03/07; Required quantity: 2	2	11.8171-0008.1 990049 Brake System: ATE
			Construction year from: 03/07 →; Payload: not for increased payload; Required quantity: 2	2	11.8171-0008.1 990049 Brake System: ATE
			Construction year from: 03/07 →; Required quantity: 2; Fitting Position: Rear Axle	2	11.8171-0008.1 990049 Brake System: ATE
			→ Construction year to: 03/07; Required quantity: 2; Fitting Position: Rear Axle	2	11.8171-0008.1 990049 Brake System: ATE
540 i	220	09/05→02/07	Required quantity: 2	2	11.8171-0008.1 990049 Brake System: ATE
545 i	245	09/03→08/05	Required quantity: 2; Fitting Position: Rear Axle	2	11.8171-0008.1 990049 Brake System: ATE
540 i	225	03/07→12/09	Payload: not for increased payload; Required quantity: 2	2	11.8171-0008.1 990049 Brake System: ATE
			Required quantity: 2; Fitting Position: Rear Axle	2	11.8171-0008.1 990049 Brake System: ATE
550 i	270	09/05→12/09	Required quantity: 2;	2	11.8171-0008.1 990049 Brake System: ATE
M5	373	09/04→12/09	Fitting Position: Rear Axle		
BMW - 5 (F10) 01/09→10/16					
Guide Bolt, brake caliper					
518 d	100	07/13→10/16	Required quantity: 2	2	11.8171-0008.1 990049 Brake System: ATE
520 d	100	06/10→10/16	110		
			151		
520 d xDrive	100	01/13→10/16	151		
			151		
520 i	120	09/11→10/16	135		
			135		
518 d	120	10/13→10/16	Construction year from: 07/14 →;	2	11.8171-0008.1 990049 Brake System: ATE
520 d	155	10/13→10/16	Required quantity: 2		
520 d xDrive	155	10/13→10/16			
520 d xDrive	147	01/13→06/14	Construction year from: 02/13 →; Required quantity: 2	2	11.8171-0008.1 990049 Brake System: ATE
523 i	150	06/09→08/11	155		
			155		
525 d	150	03/10→10/16	160		
			160		
525 d xDrive	155	09/11→10/16	Braking System: not for vehicles with reinforced brakes; Required quantity: 2	2	11.8171-0008.1 990049 Brake System: ATE
528 i	180	03/10→10/16	190		
			190		
528 i xDrive	180	09/11→10/16			
530 d	190	09/11→10/16			
530 d xDrive	190	03/11→10/16			
530 d	180	01/10→08/11	Construction year from: 03/10 →; Braking System: not for vehicles with reinforced brakes; Required quantity: 2	2	11.8171-0008.1 990049 Brake System: ATE
530 d	210	09/10→10/16	Construction year from: 10/15 →;	2	11.8171-0008.1 990049 Brake System: ATE
530 d xDrive	210	03/11→10/16	Braking System: not for vehicles with reinforced brakes; Required quantity: 2		
530 i	190	03/10→06/13	200		
			200		
			Construction year from: 09/11 →; Braking System: not for vehicles with reinforced brakes; Required quantity: 2	2	11.8171-0008.1 990049 Brake System: ATE

	kW				
BMW - 5 (G30, F90) 09/16→					
 Brake Pad Set, disc brake					
520 E PLUG-IN-HYBRID	120 - 03/21→ 150	Vehicle Equipment: for vehicles without sports package; Fitting Position: Front Axle		13.0460-7345.2 607345	Brake System: ATE Wear Warning Contact: prepared for wear indicator / excl. wear warning contact
525 d	155 - 07/17→06/19 170				
530 d	195 09/16→06/20				
530 d xDrive	183 - 09/16→06/20 195				
530 e Plug-in-Hybrid	120 - 03/17→ 185				
530 e Plug-in-Hybrid xDrive	120 - 03/17→ 185				
530 i	185 09/16→06/20			13.0470-7345.2 LD7345	Brake System: ATE Wear Warning Contact: prepared for wear indicator / excl. wear warning contact Ceramic
530 i xDrive	183 - 09/16→ 185				
530 d Mild-Hybrid	183 - 07/20→ 210	Braking System: for vehicles without M-sport brakes; Fitting Position: Front Axle		13.0460-7345.2 607345	Brake System: ATE Wear Warning Contact: prepared for wear indicator / excl. wear warning contact
530 d Mild-Hybrid xDrive	183 - 07/20→ 210				
530 e Plug-in-Hybrid	200 - 07/20→ 215				
530 e Plug-in-Hybrid xDrive	200 - 07/20→ 215				
530 i Mild-Hybrid	185 07/20→				
530 i Mild-Hybrid xDrive	185 07/20→				
M 550 i xDrive	390 07/19→	Vehicle Equipment: for vehicles without sports package; Fitting Position: Front Axle		13.0460-7345.2 607345	Brake System: ATE Wear Warning Contact: prepared for wear indicator / excl. wear warning contact
BMW - 5 Gran Turismo (F07) 01/09→02/17					
Guide Bolt, brake caliper					
520 d	100 - 07/12→02/17 120	Required quantity: 2; Fitting Position: Rear Axle		2 11.8171-0008.1 990049	Brake System: ATE
530 d	155 - 09/10→02/17 190				
530 d xDrive	190 07/12→02/17				
535 d	220 - 03/10→02/17 230				
535 d xDrive	230 07/12→02/17				
535 i xDrive	225 09/10→02/17				
550 i	330 07/12→02/17				
550 i xDrive	330 07/12→02/17				
520 d	135 04/11→02/17	Construction year from: 10/11 →; Required quantity: 2; Fitting Position: Rear Axle		2 11.8171-0008.1 990049	Brake System: ATE
528 i	180 07/13→02/17	Construction year from: 08/13 →; Required quantity: 2; Fitting Position: Rear Axle		2 11.8171-0008.1 990049	Brake System: ATE
530 d	180 08/09→06/12	Construction year from: 10/09 →; Required quantity: 2; Fitting Position: Rear Axle		2 11.8171-0008.1 990049	Brake System: ATE
535 i	225 01/09→02/17				
550 i	300 08/09→06/12				
530 d xDrive	180 06/10→06/12	Construction year from: 09/10 →; Required quantity: 2; Fitting Position: Rear Axle		2 11.8171-0008.1 990049	Brake System: ATE
535 d xDrive	220 03/10→06/12				
550 i xDrive	300 06/10→06/12				
BMW - 5 Touring (E34) 07/91→07/96					
Guide Bolt, brake caliper					
518 g	85 02/96→07/96	Required quantity: 2; Fitting Position: Rear Axle		2 11.8171-0008.1 990049	Brake System: ATE
M5	250 04/92→07/95				
518 i	83 04/93→04/94	Required quantity: 2; Fitting Position: Front Axle		2 11.8171-0008.1 990049	Brake System: ATE
520 i	110 07/91→07/96				
525 i	141 07/91→07/96	Required quantity: 2; Fitting Position: Rear Axle		2 11.8171-0008.1 990049	Brake System: ATE
525 ix	141 01/92→03/96				
525 td	85 03/93→07/96				
525 tds	105 12/91→07/96				
530 i	160 09/92→07/96				
540 i	210 09/93→07/96				
518 i	85 05/94→07/96	→ Construction year to: 09/95; Required quantity: 2; Fitting Position: Front Axle		2 11.8171-0008.1 990049	Brake System: ATE
		Required quantity: 2; Fitting Position: Rear Axle		2 11.8171-0008.1 990049	Brake System: ATE
BMW - 5 Touring (E39) 09/96→06/04					
Guide Bolt, brake caliper					
520 d	100 02/00→09/03	Construction year from: 04/00 → → Construction year to: 07/03;		2 11.8171-0008.1 990049	Brake System: ATE
525 d	120 02/00→05/04				
→					



	kW				
BMW - 5 Touring (E39) 09/96→06/04					
Guide Bolt, brake caliper					
520 d 525 d	100 02/00→09/03 120 02/00→05/04	Required quantity: 2; Fitting Position: Front Axle			
		Construction year from: 04/00 → → Construction year to: 07/03; Required quantity: 2; Fitting Position: Rear Axle	2	11.8171-0008.1 990049	Brake System: ATE
520 i	100 03/97→08/01	→ Construction year to: 03/00; Special Purpose Vehicle: for government vehicles; Required quantity: 2	2	11.8171-0008.1 990049	Brake System: ATE
		Construction year from: 04/00 →; Special Purpose Vehicle: for government vehicles; Required quantity: 2; Fitting Position: Front Axle	2	11.8171-0008.1 990049	Brake System: ATE
		Special Purpose Vehicle: not for govern- ment vehicles; Required quantity: 2; Fitting Position: Front Axle	2	11.8171-0008.1 990049	Brake System: ATE
		Required quantity: 2; Fitting Position: Rear Axle	2	11.8171-0008.1 990049	Brake System: ATE
520 i	110 03/97→08/01	Construction year from: 05/97 → → Construction year to: 03/00; Special Purpose Vehicle: for government vehicles; Required quantity: 2	2	11.8171-0008.1 990049	Brake System: ATE
		Construction year from: 04/00 →; Special Purpose Vehicle: for government vehicles; Required quantity: 2; Fitting Position: Front Axle	2	11.8171-0008.1 990049	Brake System: ATE
		Construction year from: 05/97 →; Special Purpose Vehicle: not for govern- ment vehicles; Required quantity: 2; Fitting Position: Front Axle	2	11.8171-0008.1 990049	Brake System: ATE
		Construction year from: 05/97 →; Required quantity: 2; Fitting Position: Rear Axle	2	11.8171-0008.1 990049	Brake System: ATE
520 i	120 - 09/00→12/03 125	→ Construction year to: 07/03; Special Purpose Vehicle: for government vehicles; Required quantity: 2; Fitting Position: Front Axle	2	11.8171-0008.1 990049	Brake System: ATE
		→ Construction year to: 07/03; Special Purpose Vehicle: not for govern- ment vehicles; Required quantity: 2; Fitting Position: Front Axle	2	11.8171-0008.1 990049	Brake System: ATE
		→ Construction year to: 07/03; Required quantity: 2; Fitting Position: Rear Axle	2	11.8171-0008.1 990049	Brake System: ATE
523 i	120 09/98→08/00	Required quantity: 2; Fitting Position: Front Axle	2	11.8171-0008.1 990049	Brake System: ATE
		Required quantity: 2; Fitting Position: Rear Axle	2	11.8171-0008.1 990049	Brake System: ATE
523 i 528 i	125 03/97→08/00 142 11/96→08/00	Construction year from: 05/97 →; Required quantity: 2; Fitting Position: Front Axle	2	11.8171-0008.1 990049	Brake System: ATE
		Construction year from: 05/97 →; Required quantity: 2; Fitting Position: Rear Axle	2	11.8171-0008.1 990049	Brake System: ATE
525 i 530 i	141 09/00→05/04 170 09/00→12/03	Construction year from: 10/00 → → Construction year to: 07/03; Required quantity: 2; Fitting Position: Front Axle	2	11.8171-0008.1 990049	Brake System: ATE
		Construction year from: 10/00 → → Construction year to: 07/03; Required quantity: 2; Fitting Position: Rear Axle	2	11.8171-0008.1 990049	Brake System: ATE
525 tds	105 03/97→05/04	Construction year from: 06/98 → → Construction year to: 09/00; Required quantity: 2; Fitting Position: Front Axle	2	11.8171-0008.1 990049	Brake System: ATE
		Construction year from: 06/98 → → Construction year to: 09/00; Required quantity: 2; Fitting Position: Rear Axle	2	11.8171-0008.1 990049	Brake System: ATE
530 d	135 08/98→09/00	Construction year from: 09/98 →; Required quantity: 2; Fitting Position: Front Axle	2	11.8171-0008.1 990049	Brake System: ATE
		Construction year from: 09/98 →; Required quantity: 2; Fitting Position: Rear Axle	2	11.8171-0008.1 990049	Brake System: ATE
530 d	142 09/00→05/04	Construction year from: 10/00 → → Construction year to: 07/03;	2	11.8171-0008.1 990049	Brake System: ATE
→					

	kW				
BMW - 5 Touring (E39) 09/96→06/04					
Guide Bolt, brake caliper					
530 d	142	09/00→05/04	Required quantity: 2; Fitting Position: Front Axle		
			→ Construction year to: 09/00; Required quantity: 2; Fitting Position: Front Axle	2	11.8171-0008.1 990049 Brake System: ATE
			→ Construction year to: 07/03; Required quantity: 2; Fitting Position: Rear Axle	2	11.8171-0008.1 990049 Brake System: ATE
540 i	210	04/97→12/03	Construction year from: 05/97 → → Construction year to: 03/00; Required quantity: 2	2	11.8171-0008.1 990049 Brake System: ATE
			Construction year from: 04/00 → → Construction year to: 07/03; Required quantity: 2; Fitting Position: Front Axle	2	11.8171-0008.1 990049 Brake System: ATE
			Construction year from: 05/97 → → Construction year to: 07/03; Required quantity: 2; Fitting Position: Rear Axle	2	11.8171-0008.1 990049 Brake System: ATE
BMW - 5 Touring (E61) 03/04→12/10					
Guide Bolt, brake caliper					
520 d 525 d 525 d xDrive 525 xd 530 d xDrive 530 i xDrive 530 xd 530 xi	110 - 130 145 145 173 200 173 200	09/05→05/10 03/07→05/10 09/08→05/10 09/07→09/08 09/07→05/10 09/08→05/10 03/07→08/07 09/06→05/10	Required quantity: 2	2	11.8171-0008.1 990049 Brake System: ATE
			Required quantity: 2; Fitting Position: Rear Axle	2	11.8171-0008.1 990049 Brake System: ATE
			Construction year from: 07/05 → ; Required quantity: 2	2	11.8171-0008.1 990049 Brake System: ATE
			Construction year from: 07/05 → ; Required quantity: 2; Fitting Position: Rear Axle	2	11.8171-0008.1 990049 Brake System: ATE
			→ Construction year to: 05/10; Required quantity: 2	2	11.8171-0008.1 990049 Brake System: ATE
			→ Construction year to: 05/10; Required quantity: 2; Fitting Position: Rear Axle	2	11.8171-0008.1 990049 Brake System: ATE
			Construction year from: 03/07 → → Construction year to: 05/10; Engine Code: N53; Required quantity: 2	2	11.8171-0008.1 990049 Brake System: ATE
520 i 523 i	120 - 130 170	07/07→12/10 10/04→02/07 02/05→02/07	Construction year from: 03/07 → → Construction year to: 05/10; Engine Code: N52N; Required quantity: 2	2	11.8171-0008.1 990049 Brake System: ATE
			Construction year from: 03/07 → → Construction year to: 05/10; Required quantity: 2; Fitting Position: Rear Axle	2	11.8171-0008.1 990049 Brake System: ATE
			Construction year from: 03/07 → → Construction year to: 05/10; Required quantity: 2	2	11.8171-0008.1 990049 Brake System: ATE
523 i	140	03/07→01/10	Engine Code: N52N; Required quantity: 2	2	11.8171-0008.1 990049 Brake System: ATE
			Engine Code: N53; Required quantity: 2	2	11.8171-0008.1 990049 Brake System: ATE
			Required quantity: 2; Fitting Position: Rear Axle	2	11.8171-0008.1 990049 Brake System: ATE
525 d	120	03/04→03/07	Construction year from: 12/04 → ; Required quantity: 2	2	11.8171-0008.1 990049 Brake System: ATE
			Construction year from: 12/04 → ; Required quantity: 2; Fitting Position: Rear Axle	2	11.8171-0008.1 990049 Brake System: ATE
525 d 530 d	130 155 - 160	03/04→03/07 03/04→05/10	Construction year from: 05/04 → ; Required quantity: 2	2	11.8171-0008.1 990049 Brake System: ATE
			Construction year from: 05/04 → ; Required quantity: 2; Fitting Position: Rear Axle	2	11.8171-0008.1 990049 Brake System: ATE
525 i	141	06/04→12/10	→ Construction year to: 03/05; Required quantity: 2	2	11.8171-0008.1 990049 Brake System: ATE
			→ Construction year to: 03/05; Required quantity: 2; Fitting Position: Rear Axle	2	11.8171-0008.1 990049 Brake System: ATE
525 i	155	03/05→05/10	Construction year from: 03/07 → ; Engine Code: N52N; Required quantity: 2	2	11.8171-0008.1 990049 Brake System: ATE
			Construction year from: 03/07 → ; Engine Code: N53; Required quantity: 2	2	11.8171-0008.1 990049 Brake System: ATE
→					

	kW				
BMW - 5 Touring (E61) 03/04→12/10					
Guide Bolt, brake caliper					
525 i	155	03/05→05/10	→ Construction year to: 03/07; Required quantity: 2	2	11.8171-0008.1 990049 Brake System: ATE
			→ Construction year to: 03/07; Required quantity: 2; Fitting Position: Rear Axle	2	11.8171-0008.1 990049 Brake System: ATE
			Construction year from: 03/07 →; Engine Code: N52N; Required quantity: 2; Fitting Position: Rear Axle	2	11.8171-0008.1 990049 Brake System: ATE
			Construction year from: 03/07 →; Engine Code: N53; Required quantity: 2; Fitting Position: Rear Axle	2	11.8171-0008.1 990049 Brake System: ATE
525 i	160	03/05→05/10	Construction year from: 03/07 →; Engine Code: N52N; Required quantity: 2	2	11.8171-0008.1 990049 Brake System: ATE
			Construction year from: 07/05 → → Construction year to: 03/07; Required quantity: 2	2	11.8171-0008.1 990049 Brake System: ATE
			Construction year from: 03/07 →; Engine Code: N53; Required quantity: 2	2	11.8171-0008.1 990049 Brake System: ATE
			Construction year from: 07/05 → → Construction year to: 03/07; Required quantity: 2; Fitting Position: Rear Axle	2	11.8171-0008.1 990049 Brake System: ATE
			Construction year from: 03/07 →; Engine Code: N52N; Required quantity: 2; Fitting Position: Rear Axle	2	11.8171-0008.1 990049 Brake System: ATE
			Construction year from: 03/07 →; Engine Code: N53; Required quantity: 2; Fitting Position: Rear Axle	2	11.8171-0008.1 990049 Brake System: ATE
525 i	155 - 01/07→12/10 160		Construction year from: 03/07 → → Construction year to: 05/10; Engine Code: N53; Required quantity: 2	2	11.8171-0008.1 990049 Brake System: ATE
			Construction year from: 03/07 → → Construction year to: 05/10; Engine Code: N52N; Required quantity: 2	2	11.8171-0008.1 990049 Brake System: ATE
			→ Construction year to: 03/07; Required quantity: 2	2	11.8171-0008.1 990049 Brake System: ATE
			Construction year from: 03/07 → → Construction year to: 05/10; Engine Code: N53; Required quantity: 2; Fitting Position: Rear Axle	2	11.8171-0008.1 990049 Brake System: ATE
			→ Construction year to: 03/07; Required quantity: 2; Fitting Position: Rear Axle	2	11.8171-0008.1 990049 Brake System: ATE
			Construction year from: 03/07 → → Construction year to: 05/10; Engine Code: N52N; Required quantity: 2; Fitting Position: Rear Axle	2	11.8171-0008.1 990049 Brake System: ATE
530 d	173	02/07→05/10	Construction year from: 03/07 →; Required quantity: 2	2	11.8171-0008.1 990049 Brake System: ATE
			Construction year from: 03/07 →; Required quantity: 2; Fitting Position: Rear Axle	2	11.8171-0008.1 990049 Brake System: ATE
530 i	200	09/06→03/10	Construction year from: 03/07 →; Engine Code: N52N; Required quantity: 2	2	11.8171-0008.1 990049 Brake System: ATE
			Construction year from: 03/07 →; Engine Code: N53; Required quantity: 2	2	11.8171-0008.1 990049 Brake System: ATE
			Construction year from: 03/07 →; Engine Code: N52N; Required quantity: 2; Fitting Position: Rear Axle	2	11.8171-0008.1 990049 Brake System: ATE
			Construction year from: 03/07 →; Engine Code: N53; Required quantity: 2; Fitting Position: Rear Axle	2	11.8171-0008.1 990049 Brake System: ATE
530 i	200	01/07→12/10	Construction year from: 03/07 → → Construction year to: 05/10; Engine Code: N53; Required quantity: 2	2	11.8171-0008.1 990049 Brake System: ATE
			Construction year from: 03/07 → → Construction year to: 05/10; Engine Code: N52N; Required quantity: 2	2	11.8171-0008.1 990049 Brake System: ATE
			Construction year from: 03/07 → → Construction year to: 05/10;	2	11.8171-0008.1 990049 Brake System: ATE



→





	kW				
BMW - 5 Touring (E61) 03/04→12/10					
Guide Bolt, brake caliper					
530 i	200 01/07→12/10	Engine Code: N53; Required quantity: 2; Fitting Position: Rear Axle			
		Construction year from: 03/07 → → Construction year to: 05/10; Engine Code: N52N; Required quantity: 2; Fitting Position: Rear Axle	2	11.8171-0008.1 990049	Brake System: ATE
535 d	200 09/04→12/10	→ Construction year to: 03/07; Required quantity: 2; Fitting Position: Rear Axle	2	11.8171-0008.1 990049	Brake System: ATE
535 d	210 01/07→12/10	Construction year from: 03/07 → → Construction year to: 05/10; Required quantity: 2; Fitting Position: Rear Axle	2	11.8171-0008.1 990049	Brake System: ATE
545 i	245 06/04→12/10	→ Construction year to: 08/05; Required quantity: 2	2	11.8171-0008.1 990049	Brake System: ATE
		→ Construction year to: 08/05; Required quantity: 2; Fitting Position: Rear Axle	2	11.8171-0008.1 990049	Brake System: ATE
550 i	270 07/05→12/10	Construction year from: 03/07 → → Construction year to: 05/10; Required quantity: 2	2	11.8171-0008.1 990049	Brake System: ATE
		→ Construction year to: 05/10; Required quantity: 2; Fitting Position: Rear Axle	2	11.8171-0008.1 990049	Brake System: ATE
M5	373 02/07→12/10	→ Construction year to: 05/10; Required quantity: 2; Fitting Position: Rear Axle	2	11.8171-0008.1 990049	Brake System: ATE
BMW - 5 Touring (F11) 11/09→02/17					
Guide Bolt, brake caliper					
518 d	100 - 07/13→02/17 120	Required quantity: 2	2	11.8171-0008.1 990049	Brake System: ATE
520 d xDrive	100 - 07/13→02/17 147				
520 i	120 09/11→02/17				
525 d	150 09/10→08/11				
528 i	180 09/11→02/17				
528 i xDrive	180 09/11→02/17				
520 d	100 - 06/10→02/17 147	Construction year from: 09/10 → ; Required quantity: 2	2	11.8171-0008.1 990049	Brake System: ATE
523 i	150 11/09→08/11				
528 i	190 11/09→08/11				
530 d	180 06/10→08/11				
520 d	140 - 07/14→02/17 155	Braking System: not for vehicles with reinforced brakes; Required quantity: 2	2	11.8171-0008.1 990049	Brake System: ATE
520 d xDrive	140 - 07/14→02/17 155				
525 d	155 - 09/11→02/17 160				
525 d xDrive	155 - 07/13→02/17 160				
530 d	190 09/11→02/17				
530 d xDrive	190 03/11→02/17				
520 i	135 10/10→02/17	Construction year from: 09/11 → ; Required quantity: 2	2	11.8171-0008.1 990049	Brake System: ATE
530 i	190 - 03/10→06/13 200				
530 d	210 09/11→02/17	Construction year from: 10/15 → ; Braking System: not for vehicles with reinforced brakes; Required quantity: 2	2	11.8171-0008.1 990049	Brake System: ATE
530 d xDrive	210 03/11→02/17				
BMW - 5 Touring (G31) 03/17→					
 Brake Pad Set, disc brake					
520 E PLUG-IN-HYBRID	120 - 03/21→ 150	Vehicle Equipment: for vehicles without sports package; Fitting Position: Front Axle		13.0460-7345.2 607345	Brake System: ATE Wear Warning Contact: prepared for wear indicator / excl. wear warning contact
525 d	155 - 07/17→06/19 170				
530 d	195 03/17→06/20			13.0470-7345.2 LD7345	Brake System: ATE Wear Warning Contact: prepared for wear indicator / excl. wear warning contact Ceramic
530 d xDrive	195 03/17→06/20				
530 e Plug-in-Hybrid	120 11/20→				
530 e Plug-in-Hybrid xDrive	120 11/20→				
530 i	185 03/17→06/20				
530 i xDrive	185 07/17→06/20				
530 e Plug-in-Hybrid	135 - 11/20→ 215	Braking System: for vehicles without M- sport brakes; Fitting Position: Front Axle		13.0460-7345.2 607345	Brake System: ATE Wear Warning Contact: prepared for wear indicator / excl. wear warning contact
530 e Plug-in-Hybrid xDrive	135 - 11/20→ 215				
530 i Mild-Hybrid →	185 07/20→				



	kW				
BMW - 5 Touring (G31) 03/17→					
 Brake Pad Set, disc brake					
530 i Mild-Hybrid xDrive	185 07/20→		Braking System: for vehicles without M-sport brakes; Fitting Position: Front Axle	13.0470-7345.2 LD7345	Brake System: ATE Wear Warning Contact: prepared for wear indicator / excl. wear warning contact Ceramic
BMW - 5 Touring Van (G31) 03/17→					
 Brake Pad Set, disc brake					
530 d	195 03/17→		Vehicle Equipment: for vehicles without sports package; Fitting Position: Front Axle	13.0460-7345.2 607345	Brake System: ATE Wear Warning Contact: prepared for wear indicator / excl. wear warning contact
530 d xDrive	195 03/17→			13.0470-7345.2 LD7345	Brake System: ATE Wear Warning Contact: prepared for wear indicator / excl. wear warning contact Ceramic
530 i	185 03/17→				
530 i xDrive	185 07/17→				
BMW - 6 (E24) 10/75→04/89					
Guide Bolt, brake caliper					
628 CSi	135 09/79→08/87		Construction year from: 05/82 → → Construction year to: 05/87; Required quantity: 2; Fitting Position: Front Axle	2 11.8171-0008.1 990049	Brake System: ATE
			Construction year from: 05/82 → → Construction year to: 05/87; Required quantity: 2; Fitting Position: Rear Axle	2 11.8171-0008.1 990049	Brake System: ATE
635 CSi	136 - 06/78→04/89 162		Required quantity: 2; Fitting Position: Front Axle	2 11.8171-0008.1 990049	Brake System: ATE
			Required quantity: 2; Fitting Position: Rear Axle	2 11.8171-0008.1 990049	Brake System: ATE
635 CSi	141 12/77→04/89		Construction year from: 05/82 → →; Required quantity: 2; Fitting Position: Front Axle	2 11.8171-0008.1 990049	Brake System: ATE
			Construction year from: 05/82 → →; Required quantity: 2; Fitting Position: Rear Axle	2 11.8171-0008.1 990049	Brake System: ATE
M 635 CSi	191 - 04/84→02/89 210		Required quantity: 2; Fitting Position: Rear Axle	2 11.8171-0008.1 990049	Brake System: ATE
BMW - 6 (E63) 09/03→12/10					
Guide Bolt, brake caliper					
630 i	190 - 09/04→08/10 200		Required quantity: 2	2 11.8171-0008.1 990049	Brake System: ATE
645 Ci	245 09/03→08/05		Required quantity: 2; Fitting Position: Rear Axle	2 11.8171-0008.1 990049	Brake System: ATE
635 d	210 07/07→07/10		Construction year from: 09/07 → →; Required quantity: 2; Fitting Position: Rear Axle	2 11.8171-0008.1 990049	Brake System: ATE
650 i	270 09/05→08/10		Required quantity: 2;	2 11.8171-0008.1 990049	Brake System: ATE
M	373 09/05→07/10		Fitting Position: Rear Axle		
BMW - 6 Convertible (E64) 03/04→12/10					
Guide Bolt, brake caliper					
630 i	190 - 09/04→08/10 200		Required quantity: 2	2 11.8171-0008.1 990049	Brake System: ATE
645 Ci	245 04/04→08/05		Required quantity: 2; Fitting Position: Rear Axle	2 11.8171-0008.1 990049	Brake System: ATE
635 d	210 07/07→07/10		Construction year from: 09/07 → →; Required quantity: 2; Fitting Position: Rear Axle	2 11.8171-0008.1 990049	Brake System: ATE
650 i	270 09/05→08/10		Required quantity: 2;	2 11.8171-0008.1 990049	Brake System: ATE
M6	373 09/06→08/10		Fitting Position: Rear Axle		
BMW - 6 Gran Turismo (G32) 06/17→					
 Brake Pad Set, disc brake					
620 d	120 - 07/18→06/20 140		Fitting Position: Front Axle	13.0460-7345.2 607345	Brake System: ATE Wear Warning Contact: prepared for wear indicator / excl. wear warning contact
620 d xDrive	120 - 07/18→06/20 140			13.0470-7345.2 LD7345	Brake System: ATE Wear Warning Contact: prepared for wear indicator / excl. wear warning contact Ceramic
→					

	kW				
BMW - 6 Gran Turismo (G32) 06/17→					
 Brake Pad Set, disc brake					
620 d Mild-Hybrid	120 - 07/20→ 140		Braking System: for vehicles without M-sport brakes; Fitting Position: Front Axle	2	13.0460-7345.2 607345 Brake System: ATE Wear Warning Contact: prepared for wear indicator / excl. wear warning contact
620 d Mild-Hybrid xDrive	140 07/20→				
630 d Mild-Hybrid	155 - 07/20→ 210				
630 d Mild-Hybrid xDrive	210 07/20→				
					13.0470-7345.2 LD7345 Brake System: ATE Wear Warning Contact: prepared for wear indicator / excl. wear warning contact Ceramic
BMW - 7 (E23) 05/77→04/88					
Guide Bolt, brake caliper					
728 i	135 09/77→08/86	Construction year from: 09/81 → → Construction year to: 05/86; Required quantity: 2; Fitting Position: Rear Axle		2	11.8171-0008.1 990049 Brake System: ATE
732 i	145 09/79→08/86	Construction year from: 09/81 → → Construction year to: 04/86; Required quantity: 2; Fitting Position: Rear Axle		2	11.8171-0008.1 990049 Brake System: ATE
733 i	145 05/77→08/86	Construction year from: 09/81 → → Construction year to: 07/82; Required quantity: 2; Fitting Position: Rear Axle		2	11.8171-0008.1 990049 Brake System: ATE
		Construction year from: 09/81 → → Construction year to: 04/86; Required quantity: 2; Fitting Position: Rear Axle		2	11.8171-0008.1 990049 Brake System: ATE
735 i	136 - 09/82→09/86 160	→ Construction year to: 04/86; Required quantity: 2; Fitting Position: Rear Axle		2	11.8171-0008.1 990049 Brake System: ATE
735 i	160 09/79→09/82	Required quantity: 2; Fitting Position: Rear Axle		2	11.8171-0008.1 990049 Brake System: ATE
745 i	185 04/80→04/83	Construction year from: 09/81 → →; Required quantity: 2; Fitting Position: Rear Axle		2	11.8171-0008.1 990049 Brake System: ATE
745 i	185 05/83→08/86	→ Construction year to: 05/86; Required quantity: 2; Fitting Position: Rear Axle		2	11.8171-0008.1 990049 Brake System: ATE
BMW - 7 (E32) 03/85→10/94					
Guide Bolt, brake caliper					
730 i iL	138 - 03/85→03/94 145	Construction year from: 11/87 → →; Required quantity: 2; Fitting Position: Front Axle		2	11.8171-0008.1 990049 Brake System: ATE
		→ Construction year to: 10/87; Required quantity: 2; Fitting Position: Front Axle		2	11.8171-0008.1 990049 Brake System: ATE
	138 - 03/85→03/94 145	Construction year from: 12/87 → →; Required quantity: 2; Fitting Position: Front Axle		2	11.8171-0008.1 990049 Brake System: ATE
		Construction year from: 12/87 → →; Required quantity: 2; Fitting Position: Rear Axle		2	11.8171-0008.1 990049 Brake System: ATE
		Construction year from: 11/87 → →; Required quantity: 2; Fitting Position: Rear Axle		2	11.8171-0008.1 990049 Brake System: ATE
		→ Construction year to: 10/87; Required quantity: 2; Fitting Position: Rear Axle		2	11.8171-0008.1 990049 Brake System: ATE
730 i iL V8	160 04/92→09/94 160 04/92→09/94	Construction year from: 06/92 → → Construction year to: 06/94; Required quantity: 2; Fitting Position: Front Axle		2	11.8171-0008.1 990049 Brake System: ATE
		→ Construction year to: 06/94; Required quantity: 2; Fitting Position: Front Axle		2	11.8171-0008.1 990049 Brake System: ATE
	160 04/92→09/94 160 04/92→09/94	Construction year from: 06/92 → → Construction year to: 06/94; Required quantity: 2; Fitting Position: Rear Axle		2	11.8171-0008.1 990049 Brake System: ATE
		→ Construction year to: 06/94; Required quantity: 2; Fitting Position: Rear Axle		2	11.8171-0008.1 990049 Brake System: ATE
iL	155 - 06/86→07/92 162	Required quantity: 2; Fitting Position: Front Axle		2	11.8171-0008.1 990049 Brake System: ATE
735 i	155 - 06/86→07/92 162	Required quantity: 2; Fitting Position: Rear Axle		2	11.8171-0008.1 990049 Brake System: ATE
→					



	kW				
BMW - 7 (E32) 03/85→10/94					
Guide Bolt, brake caliper					
740 i iL V8	210 05/92→03/94 210 05/92→03/94	Required quantity: 2; Fitting Position: Front Axle	2	11.8171-0008.1 990049	Brake System: ATE
		Required quantity: 2; Fitting Position: Rear Axle	2	11.8171-0008.1 990049	Brake System: ATE
iL V12 750 i	220 09/87→09/94 220 09/87→09/94	Construction year from: 01/90 → → Construction year to: 06/94; Required quantity: 2; Fitting Position: Front Axle	2	11.8171-0008.1 990049	Brake System: ATE
		→ Construction year to: 12/89; Required quantity: 2; Fitting Position: Front Axle	2	11.8171-0008.1 990049	Brake System: ATE
		Construction year from: 01/90 → → Construction year to: 06/94; Required quantity: 2; Fitting Position: Rear Axle	2	11.8171-0008.1 990049	Brake System: ATE
		→ Construction year to: 12/89; Required quantity: 2; Fitting Position: Rear Axle	2	11.8171-0008.1 990049	Brake System: ATE
BMW - 7 (E38) 03/94→11/01					
Guide Bolt, brake caliper					
725 tds	105 04/96→11/01	Construction year from: 05/96 →; Required quantity: 2; Fitting Position: Rear Axle	2	11.8171-0008.1 990049	Brake System: ATE
iL 728 i	142 08/95→11/01 142 08/95→11/01	Construction year from: 01/96 →; Required quantity: 2; Fitting Position: Rear Axle	2	11.8171-0008.1 990049	Brake System: ATE
		Required quantity: 2; Fitting Position: Rear Axle	2	11.8171-0008.1 990049	Brake System: ATE
728i X 730 d 730 i	142 11/95→09/01 142 04/00→11/01 155 - 03/94→11/01 160	Required quantity: 2; Fitting Position: Rear Axle	2	11.8171-0008.1 990049	Brake System: ATE
iL 735 i	155 - 03/94→11/01 175 173 - 03/96→07/01 175				
730 d	135 08/98→04/00	Construction year from: 09/98 →; Required quantity: 2; Fitting Position: Rear Axle	2	11.8171-0008.1 990049	Brake System: ATE
740 d 740 i	180 05/99→11/01 210 03/94→02/96	Required quantity: 2; Fitting Position: Front Axle	2	11.8171-0008.1 990049	Brake System: ATE
iL 750 i	210 - 03/94→07/01 240 240 11/94→07/01	Required quantity: 2; Fitting Position: Rear Axle	2	11.8171-0008.1 990049	Brake System: ATE
740 i iL	210 02/96→07/01 210 02/96→07/01	Required quantity: 2; Fitting Position: Front Axle	2	11.8171-0008.1 990049	Brake System: ATE
		Construction year from: 09/96 →; Required quantity: 2; Fitting Position: Rear Axle	2	11.8171-0008.1 990049	Brake System: ATE
BMW - 7 (E65, E66, E67) 07/01→12/09					
Guide Bolt, brake caliper					
730 d 730 i Li	150 09/02→08/03 170 03/03→07/08 170 - 11/01→07/08 200	Required quantity: 2; Fitting Position: Rear Axle	2	11.8171-0008.1 990049	Brake System: ATE
735 i 745 d	200 11/01→02/05 220 - 03/05→07/08 242				
730 d	155 09/03→08/08	→ Construction year to: 02/05; Required quantity: 2; Fitting Position: Rear Axle	2	11.8171-0008.1 990049	Brake System: ATE
730 d	160 06/02→02/05	Construction year from: 09/02 →; Required quantity: 2; Fitting Position: Rear Axle	2	11.8171-0008.1 990049	Brake System: ATE
730 i Li	184 - 03/05→08/08 190 184 - 03/05→08/08 190	Construction year from: 07/05 →; Required quantity: 2; Fitting Position: Rear Axle	2	11.8171-0008.1 990049	Brake System: ATE
730 Ld 735 i	170 07/05→08/08 225 03/05→12/09	Required quantity: 2	2	11.8171-0008.1 990049	Brake System: ATE
740 d 740 i Li	190 10/02→02/05 225 03/05→08/08 225 - 07/01→08/08 270	Required quantity: 2; Fitting Position: Rear Axle	2	11.8171-0008.1 990049	Brake System: ATE
745 i 750 i	245 07/01→03/05 270 03/05→08/08				
→					

	kW				
BMW - 7 (E65, E66, E67) 07/01→12/09					
Guide Bolt, brake caliper					
760 i	320 - 01/03→08/08 327	Construction year from: 03/03 →; Required quantity: 2	2	11.8171-0008.1 990049	Brake System: ATE
Li	327 01/03→08/08	Construction year from: 03/03 →; Required quantity: 2; Fitting Position: Rear Axle	2	11.8171-0008.1 990049	Brake System: ATE
BMW - 7 (F01, F02, F03, F04) 02/08→12/15					
Guide Bolt, brake caliper					
730 d	155 02/08→05/15	Construction year from: 09/08 →; Required quantity: 2; Fitting Position: Rear Axle	2	11.8171-0008.1 990049	Brake System: ATE
730 d	180 - 09/08→05/15 190	Required quantity: 2; Fitting Position: Rear Axle	2	11.8171-0008.1 990049	Brake System: ATE
730 i	190 09/09→06/15				
Li	190 - 09/08→12/15 400				
740 d	225 - 09/09→06/15 230				
740 d xDrive	225 - 09/10→06/15 230				
740 i	224 - 09/08→12/15 240				
Li xDrive	235 - 09/09→12/15 330				
750 d xDrive	280 07/12→12/15				
750 i	300 - 09/09→06/15 331				
760 i	400 09/09→12/15				
ActiveHybrid 7	235 - 04/10→06/15 342				
730 d xDrive	155 - 11/11→05/15 190	Construction year from: 06/12 →; Required quantity: 2; Fitting Position: Rear Axle	2	11.8171-0008.1 990049	Brake System: ATE
750 i	300 09/08→06/12	Construction year from: 12/08 →; Required quantity: 2; Fitting Position: Rear Axle	2	11.8171-0008.1 990049	Brake System: ATE
Li	300 09/08→06/12	→ Construction year to: 11/08; Required quantity: 2; Fitting Position: Rear Axle	2	11.8171-0008.1 990049	Brake System: ATE
BMW - 7 (G11, G12) 07/15→					
 Brake Pad Set, disc brake					
725 d	155 - 07/16→02/19 170	Braking System: for vehicles without Performance brakes; Fitting Position: Front Axle		13.0460-7345.2 607345	Brake System: ATE Wear Warning Contact: prepared for wear indicator / excl. wear warning contact
Ld	155 - 07/16→02/19 170			13.0470-7345.2 LD7345	Brake System: ATE Wear Warning Contact: prepared for wear indicator / excl. wear warning contact Ceramic
730 i	183 - 11/15→ 190				
Li	190 11/15→02/19				
BMW - 8 (E31) 01/90→12/99					
Guide Bolt, brake caliper					
840 Ci	210 03/96→06/99	Required quantity: 2; Fitting Position: Rear Axle	2	11.8171-0008.1 990049	Brake System: ATE
840 i	210 03/93→02/96	→ Construction year to: 02/94;	2	11.8171-0008.1 990049	Brake System: ATE
850 i	220 01/90→08/94	Required quantity: 2;			
Ci	220 01/90→08/94	Fitting Position: Front Axle			
		Required quantity: 2; Fitting Position: Rear Axle	2	11.8171-0008.1 990049	Brake System: ATE
850 Ci	240 09/94→12/99	Required quantity: 2; Fitting Position: Front Axle	2	11.8171-0008.1 990049	Brake System: ATE
		Required quantity: 2; Fitting Position: Rear Axle	2	11.8171-0008.1 990049	Brake System: ATE
BMW - i4 (G26) 11/21→					
 Brake Pad Set, disc brake					
eDrive40	250 11/21→	Braking System: for vehicles without M- sport brakes; Fitting Position: Front Axle		13.0460-7345.2 607345	Brake System: ATE Wear Warning Contact: prepared for wear indicator / excl. wear warning contact
		Braking System: for vehicles without M- sport brakes; Fitting Position: Rear Axle		13.0460-5525.2 605525	Brake System: Mando Wear Warning Contact: prepared for wear indicator / excl. wear warning contact Supplementary Article/Supple- mentary Info: with accessories

	kW				
BMW - iX3 (G08) 09/20→					
 Brake Pad Set, disc brake					
Electric	80 - 09/20→ 210	Fitting Position: Front Axle		13.0460-7345.2 607345	Brake System: ATE Wear Warning Contact: prepared for wear indicator / excl. wear warning contact
				13.0470-7345.2 LD7345	Brake System: ATE Wear Warning Contact: prepared for wear indicator / excl. wear warning contact Ceramic
BMW - X1 (E84) 03/09→06/15					
Guide Bolt, brake caliper					
sDrive 16 d xDrive 25 d	85 04/12→06/15 160 10/09→06/15	Construction year from: 07/12 →; Required quantity: 2	2	11.8171-0008.1 990049	Brake System: ATE
sDrive 16 i sDrive 18 d sDrive 18 i	105 03/13→06/15 105 12/09→06/15 100 - 03/10→06/15 110	Required quantity: 2	2	11.8171-0008.1 990049	Brake System: ATE
sDrive 20 d	120 - 10/09→06/15 135				
sDrive 20 i sDrive 28 i xDrive 18 d xDrive 20 d	135 09/11→06/15 180 09/12→06/15 105 10/09→06/15 120 - 09/09→06/15 135				
xDrive 20 i xDrive 25 i xDrive 28 i	135 09/11→06/15 160 03/10→08/11 194 03/10→06/11				
sDrive 18 d xDrive 18 d	100 03/09→06/15 100 03/09→06/15	Construction year from: 10/09 →; Required quantity: 2	2	11.8171-0008.1 990049	Brake System: ATE
xDrive 23 d xDrive 28 i	150 10/09→06/15 180 03/11→06/15	→ Construction year to: 02/12; Required quantity: 2	2	11.8171-0008.1 990049	Brake System: ATE
xDrive 28 i Flex xDrive 35 i	180 04/11→06/15 225 03/11→06/15	Construction year from: 03/12 →; Required quantity: 2	2	11.8171-0008.1 990049	Brake System: ATE
		Required quantity: 2	2	11.8171-0008.1 990049	Brake System: ATE
xDrive 28 i	190 09/09→08/11	Required quantity: 2	2	11.8171-0008.1 990049	Brake System: ATE
		Required quantity: 2; Fitting Position: Rear Axle	2	11.8171-0008.1 990049	Brake System: ATE
BMW - X1 (F48) 11/14→					
 Brake Hose					
sDrive 16 d sDrive 18 d xDrive 18 d	85 11/14→ 100 07/15→ 100 - 11/14→ 110	Construction year from: 09/15 →; Required quantity: 2; Fitting Position: Front Axle	2	24.5134-0420.3 331648	Length [mm]: 465
xDrive 20 i xDrive 25 d xDrive 25 i	141 07/15→11/15 170 11/14→ 170 07/15→				
sDrive 18 d sDrive 18 i	110 07/15→ 100 - 11/15→ 103	Required quantity: 2; Fitting Position: Front Axle	2	24.5134-0420.3 331648	Length [mm]: 465
sDrive 20 d	120 - 11/15→ 140				
sDrive 20 i	131 - 07/15→ 141				
xDrive 20 d xDrive 20 i xDrive 25 e Plug-in-Hybrid	140 07/15→ 131 11/20→ 92 - 03/20→ 162				
xDrive 20 d	120 07/15→	Construction year from: 11/15 →; Required quantity: 2; Fitting Position: Front Axle	2	24.5134-0420.3 331648	Length [mm]: 465
BMW - X1 Van (F48) 07/15→					
 Brake Hose					
sDrive 18 d sDrive 18 i sDrive 20 d sDrive 20 i xDrive 20 d	110 07/15→ 103 07/17→ 140 11/15→ 141 07/17→ 140 07/15→	Required quantity: 2; Fitting Position: Front Axle	2	24.5134-0420.3 331648	Length [mm]: 465
BMW - X2 (F39) 11/17→					
 Brake Hose					
M35 i sDrive 16 d sDrive 18 d	225 11/18→ 85 11/18→ 100 - 03/18→ 110	Required quantity: 2; Fitting Position: Front Axle	2	24.5134-0420.3 331648	Length [mm]: 465
→					





	kW				
BMW - X2 (F39) 11/17→					
 Brake Hose					
sDrive 18 i	100 - 03/18→ 103	Required quantity: 2; Fitting Position: Front Axle	2	24.5134-0420.3 331648	Length [mm]: 465
sDrive 20 d	120 - 11/18→ 140				
sDrive 20 i	131 - 11/17→ 141				
xDrive 18 d	100 - 03/18→ 110				
xDrive 20 d	120 - 11/17→ 140				
xDrive 20 i	131 - 03/18→ 141				
xDrive 25 d	170 11/17→				
xDrive 25 e Plug-in-Hybrid	92 - 03/20→ 162				
BMW - X3 (E83) 01/03→12/11					
Guide Bolt, brake caliper					
2.0 d	110 09/04→08/07	Required quantity: 2; Fitting Position: Front Axle	2	11.8171-0008.1 990049	Brake System: ATE
2.0 i	110 07/05→08/08				
2.0 sd	130 09/07→08/08	Required quantity: 2; Fitting Position: Rear Axle	2	11.8171-0008.1 990049	Brake System: ATE
2.5 i	141 03/04→07/06				
2.5 si	160 08/06→08/08				
2.5 si xDrive	155 08/06→08/08				
3.0 d	150 - 01/04→08/08 160				
3.0 i xDrive	170 09/03→07/06				
3.0 sd	210 09/06→08/08				
3.0 si	194 - 08/06→08/08 200				
xDrive 20 d	120 - 09/08→08/10 130				
xDrive 25 i	155 - 09/08→08/10 160				
xDrive 30 d	155 - 09/08→08/10 160				
xDrive 30 i	194 - 09/08→08/10 200				
xDrive 18 d	100 - 09/08→12/11 105	→ Construction year to: 08/10; Required quantity: 2; Fitting Position: Front Axle	2	11.8171-0008.1 990049	Brake System: ATE
xDrive 20 i	110 09/08→08/11				
xDrive 35 d	210 09/08→08/11	→ Construction year to: 08/10; Required quantity: 2; Fitting Position: Rear Axle	2	11.8171-0008.1 990049	Brake System: ATE
xDrive 30 i	160 08/06→08/10	Required quantity: 2; Fitting Position: Front Axle	2	11.8171-0008.1 990049	Brake System: ATE
BMW - X3 (G01, F97) 07/17→					
 Brake Pad Set, disc brake					
xDrive 20 i Mild Hybrid	135 08/21→	Vehicle Equipment: for vehicles without sports package; Fitting Position: Front Axle		13.0460-7345.2 607345	Brake System: ATE Wear Warning Contact: prepared for wear indicator / excl. wear warning contact
xDrive 25 d	155 - 04/18→ 170				
xDrive 30d	183 - 08/17→06/20 195			13.0470-7345.2 LD7345	Brake System: ATE Wear Warning Contact: prepared for wear indicator / excl. wear warning contact Ceramic
xDrive 30d Mild-Hybrid	183 - 07/20→ 210				
xDrive 30 i Mild Hybrid	180 08/21→				
xDrive 30 e Plug-in-Hybrid	120 - 12/19→ 185	Braking System: for vehicles without M-sport brakes; Fitting Position: Front Axle		13.0460-7345.2 607345	Brake System: ATE Wear Warning Contact: prepared for wear indicator / excl. wear warning contact
				13.0470-7345.2 LD7345	Brake System: ATE Wear Warning Contact: prepared for wear indicator / excl. wear warning contact Ceramic
BMW - X3 Van (G01) 07/17→					
 Brake Pad Set, disc brake					
xDrive 30 d	195 08/17→	Vehicle Equipment: for vehicles without sports package; Fitting Position: Front Axle		13.0460-7345.2 607345	Brake System: ATE Wear Warning Contact: prepared for wear indicator / excl. wear warning contact
				13.0470-7345.2 LD7345	Brake System: ATE Wear Warning Contact: prepared for wear indicator / excl. wear warning contact Ceramic



	kW				
BMW - X4 (G02, F98) 04/18→					
 Brake Pad Set, disc brake					
xDrive 25 d	155 04/18→	Vehicle Equipment: for vehicles without sports package; Fitting Position: Front Axle		13.0460-7345.2 607345	Brake System: ATE Wear Warning Contact: prepared for wear indicator / excl. wear warning contact
		Vehicle Equipment: for vehicles with sports package; Fitting Position: Front Axle		13.0470-7345.2 LD7345	Brake System: ATE Wear Warning Contact: prepared for wear indicator / excl. wear warning contact Ceramic
xDrive 25 d xDrive 30 d xDrive 30 d Mild-Hybrid	170 04/18→ 183 - 04/18→06/20 195 183 - 07/20→ 210	Vehicle Equipment: for vehicles without sports package; Fitting Position: Front Axle		13.0460-7345.2 607345 13.0470-7345.2 LD7345	Brake System: ATE Wear Warning Contact: prepared for wear indicator / excl. wear warning contact Brake System: ATE Wear Warning Contact: prepared for wear indicator / excl. wear warning contact Ceramic
BMW - X5 (E53) 01/00→12/06					
Guide Bolt, brake caliper					
3.0 d 4.4 i	135 04/01→09/03 210 01/00→09/03	Required quantity: 2; Fitting Position: Front Axle	2	11.8171-0008.1 990049	Brake System: ATE
		Required quantity: 2; Fitting Position: Rear Axle	2	11.8171-0008.1 990049	Brake System: ATE
3.0 d 3.0 i	155 - 10/03→09/06 160 170 04/00→10/06	Construction year from: 11/05 →; Required quantity: 2; Fitting Position: Front Axle	2	11.8171-0008.1 990049	Brake System: ATE
		→ Construction year to: 10/05; Required quantity: 2; Fitting Position: Front Axle	2	11.8171-0008.1 990049	Brake System: ATE
		Required quantity: 2; Fitting Position: Rear Axle	2	11.8171-0008.1 990049	Brake System: ATE
4.4 i	235 10/03→10/06	→ Construction year to: 10/05; Special Purpose Vehicle: not for special-purpose vehicles; Required quantity: 2; Fitting Position: Front Axle	2	11.8171-0008.1 990049	Brake System: ATE
		Construction year from: 11/05 →; Special Purpose Vehicle: not for special-purpose vehicles; Required quantity: 2; Fitting Position: Front Axle	2	11.8171-0008.1 990049	Brake System: ATE
		Required quantity: 2; Fitting Position: Rear Axle	2	11.8171-0008.1 990049	Brake System: ATE
4.6 is 4.8 is	255 10/01→09/03 265 04/04→09/06	Required quantity: 2; Fitting Position: Rear Axle	2	11.8171-0008.1 990049	Brake System: ATE
BMW - X5 (E70) 02/06→07/13					
Guide Bolt, brake caliper					
3.0 3.0d 3.0 d 3.0 sd 3.0 si 4.8 i xDrive xDrive 30 d xDrive 30 i xDrive 35 d xDrive 35 i xDrive 40 d xDrive 40 i xDrive 48 i xDrive 50 i M 50 d	155 02/07→09/08 173 12/06→09/08 210 10/07→09/08 200 10/06→09/08 261 10/06→09/08 155 - 10/08→07/13 173 172 - 02/07→12/12 200 210 10/08→07/13 225 - 04/10→07/13 235 225 09/10→06/13 225 01/12→06/13 261 10/08→03/10 300 04/10→07/13 280 08/11→06/13	Required quantity: 2	2	11.8171-0008.1 990049	Brake System: ATE
xDrive 30 d	180 04/10→07/13	Construction year from: 09/10 →; Required quantity: 2	2	11.8171-0008.1 990049	Brake System: ATE
BMW - X5 (F15, F85) 08/13→07/18					
Guide Bolt, brake caliper					
M 50 d sDrive 25 d sDrive 35 i xDrive 25 d xDrive 28 i →	280 12/13→07/18 155 - 12/13→07/18 170 225 08/13→07/18 155 - 12/13→07/18 170 180 06/15→07/18	Required quantity: 2	2	11.8171-0008.1 990049	Brake System: ATE







	kW				
BMW - X5 (F15, F85) 08/13→07/18					
Guide Bolt, brake caliper					
xDrive 30 d	183 - 08/13→07/18 210	Required quantity: 2	2	11.8171-0008.1 990049	Brake System: ATE
xDrive 35 i	225 - 12/13→07/18 240				
xDrive 40 d	230 12/13→07/18				
xDrive 40e	155 - 08/15→07/18 230				
xDrive 50 i	330 08/13→07/18				
BMW - X5 (G05, F95) 08/18→					
 Brake Pad Set, disc brake					
xDrive 25 d	155 - 08/19→ 170	Braking System: for vehicles without M-sport brakes; Fitting Position: Front Axle		13.0460-7345.2 607345	Brake System: ATE Wear Warning Contact: prepared for wear indicator / excl. wear warning contact
				13.0470-7345.2 LD7345	Brake System: ATE Wear Warning Contact: prepared for wear indicator / excl. wear warning contact Ceramic
xDrive 30 d Mild-Hybrid	183 - 08/20→ 210	Braking System: for vehicles without M-sport brakes; Vehicle Equipment: for vehicles without 3rd seating row; Fitting Position: Front Axle		13.0460-7345.2 607345	Brake System: ATE Wear Warning Contact: prepared for wear indicator / excl. wear warning contact
				13.0470-7345.2 LD7345	Brake System: ATE Wear Warning Contact: prepared for wear indicator / excl. wear warning contact Ceramic
xDrive 40 i	250 08/18→	Vehicle Equipment: for vehicles without sports package; Fitting Position: Front Axle		13.0460-7345.2 607345	Brake System: ATE Wear Warning Contact: prepared for wear indicator / excl. wear warning contact
xDrive 45 e Plug-in-Hybrid	235 - 06/19→ 290				
xDrive 45 e Plug-in-Hybrid	155 - 06/19→ 210	Vehicle Equipment: for vehicles without sports package; Fitting Position: Front Axle		13.0460-7345.2 607345	Brake System: ATE Wear Warning Contact: prepared for wear indicator / excl. wear warning contact
				13.0470-7345.2 LD7345	Brake System: ATE Wear Warning Contact: prepared for wear indicator / excl. wear warning contact Ceramic
BMW - X5 Van (G05) 11/19→					
 Brake Pad Set, disc brake					
xDrive 40 i	250 11/19→	Vehicle Equipment: for vehicles without sports package; Fitting Position: Front Axle		13.0460-7345.2 607345	Brake System: ATE Wear Warning Contact: prepared for wear indicator / excl. wear warning contact
BMW - X6 (E71, E72) 06/07→07/14					
Guide Bolt, brake caliper					
ActiveHybrid	357 01/09→10/11	Construction year from: 10/10 →; Required quantity: 2	2	11.8171-0008.1 990049	Brake System: ATE
ActiveHybrid xDrive	300 01/09→10/11				
xDrive 40 d	225 07/09→06/14				
M 50 d	280 08/11→06/14	Construction year from: 06/12 →; Required quantity: 2	2	11.8171-0008.1 990049	Brake System: ATE
xDrive 30 d	155 04/10→07/14	Required quantity: 2	2	11.8171-0008.1 990049	Brake System: ATE
xDrive 30 d	173 04/08→03/10	Construction year from: 11/08 →; Required quantity: 2	2	11.8171-0008.1 990049	Brake System: ATE
		Construction year from: 09/08 →; Required quantity: 2	2	11.8171-0008.1 990049	Brake System: ATE
xDrive 30 d	180 04/10→07/14	Construction year from: 09/10 →; Required quantity: 2	2	11.8171-0008.1 990049	Brake System: ATE
xDrive 35 d	210 01/08→03/10	Construction year from: 09/08 → → Construction year to: 09/09; Required quantity: 2	2	11.8171-0008.1 990049	Brake System: ATE
		Construction year from: 11/08 →; Required quantity: 2	2	11.8171-0008.1 990049	Brake System: ATE
xDrive 35 i	224 - 06/07→07/14 240	Construction year from: 10/09 →; Required quantity: 2	2	11.8171-0008.1 990049	Brake System: ATE
		Construction year from: 11/08 →; Required quantity: 2	2	11.8171-0008.1 990049	Brake System: ATE
xDrive 35 i	235 07/09→06/14	→ Construction year to: 09/09; Required quantity: 2	2	11.8171-0008.1 990049	Brake System: ATE
		Construction year from: 10/09 →; Required quantity: 2	2	11.8171-0008.1 990049	Brake System: ATE
		Required quantity: 2	2	11.8171-0008.1 990049	Brake System: ATE
→					





	kW				
BMW - X6 (E71, E72) 06/07→07/14					
Guide Bolt, brake caliper					
xDrive 50 i	300 - 10/07→07/14 330	Construction year from: 09/08 → → Construction year to: 09/09; Required quantity: 2	2	11.8171-0008.1 990049	Brake System: ATE
		Construction year from: 10/09 →; Required quantity: 2	2	11.8171-0008.1 990049	Brake System: ATE
BMW - X6 (G06, F96) 08/19→					
 Brake Pad Set, disc brake					
xDrive 30 d	155 - 08/19→07/20 195	Braking System: for vehicles without M-sport brakes; Fitting Position: Front Axle	2	13.0460-7345.2 607345	Brake System: ATE Wear Warning Contact: prepared for wear indicator / excl. wear warning contact
xDrive 30 d Mild-Hybrid	155 - 08/20→ 210				
				13.0470-7345.2 LD7345	Brake System: ATE Wear Warning Contact: prepared for wear indicator / excl. wear warning contact Ceramic
BMW - Z1 Roadster 06/88→06/91					
Guide Bolt, brake caliper					
2.5	125 06/88→06/91	Construction year from: 07/88 →; Required quantity: 2; Fitting Position: Front Axle	2	11.8171-0008.1 990049	Brake System: ATE
		Construction year from: 07/88 → → Construction year to: 08/90; Required quantity: 2; Fitting Position: Rear Axle	2	11.8171-0008.1 990049	Brake System: ATE
		Construction year from: 09/90 →; Required quantity: 2; Fitting Position: Rear Axle	2	11.8171-0008.1 990049	Brake System: ATE
BMW - Z3 Coupe (E36) 04/97→06/03					
Guide Bolt, brake caliper					
2.8 i	142 01/98→05/00	Required quantity: 2; Fitting Position: Front Axle	2	11.8171-0008.1 990049	Brake System: ATE
M	236 02/98→06/01				
M 3.2	176 02/98→06/00				
3.0 i	170 06/00→06/03	→ Construction year to: 12/02; Required quantity: 2; Fitting Position: Front Axle	2	11.8171-0008.1 990049	Brake System: ATE
M	239 06/01→06/03	→ Construction year to: 12/02; Required quantity: 2; Fitting Position: Rear Axle	2	11.8171-0008.1 990049	Brake System: ATE
BMW - Z3 Roadster (E36) 10/95→01/03					
Guide Bolt, brake caliper					
1.8 i	85 10/95→10/98	Required quantity: 2; Fitting Position: Front Axle	2	11.8171-0008.1 990049	Brake System: ATE
1.9 i	103 11/95→03/99				
2.2 i	125 10/00→06/02	Required quantity: 2; Fitting Position: Rear Axle	2	11.8171-0008.1 990049	Brake System: ATE
2.5 i	141 10/00→08/02				
2.8 i	142 11/96→05/00	→ Construction year to: 12/02; Required quantity: 2; Fitting Position: Front Axle	2	11.8171-0008.1 990049	Brake System: ATE
M 3.2	179 - 01/97→06/00 236				
1.9 i	85 - 07/98→01/03 87	→ Construction year to: 12/02; Required quantity: 2; Fitting Position: Front Axle	2	11.8171-0008.1 990049	Brake System: ATE
3.0 i	170 06/00→01/03	→ Construction year to: 12/02; Required quantity: 2; Fitting Position: Rear Axle	2	11.8171-0008.1 990049	Brake System: ATE
M 3.2	239 06/01→01/03				
2.0 i	110 04/99→01/03	→ Construction year to: 08/00; Required quantity: 2; Fitting Position: Front Axle	2	11.8171-0008.1 990049	Brake System: ATE
		→ Construction year to: 08/00; Required quantity: 2; Fitting Position: Rear Axle	2	11.8171-0008.1 990049	Brake System: ATE
2.2 i	120 08/00→01/03	Construction year from: 10/00 → → Construction year to: 12/02; Required quantity: 2; Fitting Position: Front Axle	2	11.8171-0008.1 990049	Brake System: ATE
		Construction year from: 10/00 → → Construction year to: 12/02; Required quantity: 2; Fitting Position: Rear Axle	2	11.8171-0008.1 990049	Brake System: ATE
2.8 i	143 01/96→07/00	Construction year from: 05/97 → → Construction year to: 06/00; Required quantity: 2; Fitting Position: Front Axle	2	11.8171-0008.1 990049	Brake System: ATE
→					

	kW				
BMW - Z3 Roadster (E36) 10/95→01/03					
Guide Bolt, brake caliper					
2.8 i	143 01/96→07/00	Construction year from: 05/97 → → Construction year to: 06/00; Required quantity: 2; Fitting Position: Rear Axle	2	11.8171-0008.1 990049	Brake System: ATE
BMW - Z4 Coupe (E86) 03/06→01/09					
Guide Bolt, brake caliper					
3.0 si M	195 04/06→08/08 252 04/06→08/08	Required quantity: 2; Fitting Position: Front Axle	2	11.8171-0008.1 990049	Brake System: ATE
		Required quantity: 2; Fitting Position: Rear Axle	2	11.8171-0008.1 990049	Brake System: ATE
BMW - Z4 Roadster (E85) 09/02→12/09					
Guide Bolt, brake caliper					
2.0 i	110 03/05→02/09	Construction year from: 04/05 → → Construction year to: 12/08; Required quantity: 2; Fitting Position: Front Axle	2	11.8171-0008.1 990049	Brake System: ATE
		Construction year from: 04/05 → → Construction year to: 12/08; Required quantity: 2; Fitting Position: Rear Axle	2	11.8171-0008.1 990049	Brake System: ATE
2.2 i	125 10/03→10/05	Required quantity: 2; Fitting Position: Front Axle	2	11.8171-0008.1 990049	Brake System: ATE
2.5 i	141 12/02→12/05				
2.5 si	160 01/06→08/08	Required quantity: 2; Fitting Position: Rear Axle	2	11.8171-0008.1 990049	Brake System: ATE
3.0 i	170 12/02→12/05				
3.0 si	195 01/06→08/08				
M	252 01/06→08/08				
2.5 i	130 09/05→02/09	Construction year from: 01/06 → → Construction year to: 12/08; Required quantity: 2; Fitting Position: Front Axle	2	11.8171-0008.1 990049	Brake System: ATE
2.5 si	155 09/05→02/09	Construction year from: 01/06 → → Construction year to: 12/08; Required quantity: 2; Fitting Position: Rear Axle	2	11.8171-0008.1 990049	Brake System: ATE
BMW - Z4 Roadster (E89) 02/09→08/16					
Guide Bolt, brake caliper					
sDrive 18 i	115 04/13→08/16	Required quantity: 2	2	11.8171-0008.1 990049	Brake System: ATE
sDrive 20 i	120 - 09/11→08/16				
	135				
sDrive 23 i	150 03/09→08/11				
sDrive 28 i	180 09/11→08/16				
sDrive 30 i	190 - 02/09→08/11				
	195				
sDrive 35 i	224 - 02/09→08/16				
	225				
sDrive 35 is	250 03/10→08/16				
BMW - Z4 Roadster (G29) 11/18→					
 Brake Pad Set, disc brake					
sDrive 20 i	120 - 11/18→	Braking System: for vehicles without M-sport brakes; Fitting Position: Rear Axle	2	13.0460-5525.2 605525	Brake System: Mando Wear Warning Contact: prepared for wear indicator / excl. wear warning contact Supplementary Article/Supplementary Info: with accessories
	145				
sDrive 30 i	190 11/18→			13.0470-5525.2 LD5525	Brake System: Mando Wear Warning Contact: prepared for wear indicator / excl. wear warning contact Supplementary Article/Supplementary Info: with accessories Ceramic
BMW - Z8 Roadster (E52) 01/00→12/03					
Guide Bolt, brake caliper					
4.9	294 01/00→12/03	Required quantity: 2; Fitting Position: Front Axle	2	11.8171-0008.1 990049	Brake System: ATE
		Required quantity: 2; Fitting Position: Rear Axle	2	11.8171-0008.1 990049	Brake System: ATE

	kW				
CHEVROLET - AVEO Hatchback (T300) 03/11→					
 Brake Disc					
1.2	51 - 03/11→ 63	Rim Size [in]: 15; Fitting Position: Front Axle	24.0326-0165.1 526165	Outer diameter [mm]: 276 Brake Disc Thickness [mm] 26 Minimum thickness [mm] 23 Brake Disc Type: Vented Supplementary Article/Info 2: with bolts/screws	
1.2 LPG	63 11/12→12/15				
1.3 D	55 - 07/11→12/15 70				
1.4	74 03/11→				
1.6	85 03/11→				
1.4 Turbo	103 08/13→	Fitting Position: Front Axle	24.0326-0165.1 526165	Outer diameter [mm]: 276 Brake Disc Thickness [mm] 26 Minimum thickness [mm] 23 Brake Disc Type: Vented Supplementary Article/Info 2: with bolts/screws	
		Fitting Position: Rear Axle	24.0312-0188.1 512188	Outer diameter [mm]: 268 Brake Disc Thickness [mm] 12 Minimum thickness [mm] 10 Brake Disc Type: Solid Supplementary Article/Info 2: with bolts/screws	
CHEVROLET - AVEO Saloon (T300) 03/11→					
 Brake Disc					
1.2	51 - 03/11→ 63	Rim Size [in]: 15; Fitting Position: Front Axle	24.0326-0165.1 526165	Outer diameter [mm]: 276 Brake Disc Thickness [mm] 26 Minimum thickness [mm] 23 Brake Disc Type: Vented Supplementary Article/Info 2: with bolts/screws	
1.2 LPG	63 11/12→12/15				
1.3 D	55 - 07/11→12/15 70				
1.4	74 - 07/11→ 103				
1.6	85 03/11→				
CHEVROLET - CORSA Estate 01/96→12/10					
Guide Sleeve Kit, brake caliper					
1.7 D	44 08/00→07/02	→ Construction year to: 09/00; Fitting Position: Front Axle	11.0101-5407.2 260011	Brake System: ATE	
Guide Bolt, brake caliper					
1.7 D	44 08/00→07/02	→ Construction year to: 09/00; Required quantity: 2; Fitting Position: Front Axle	2 11.8171-0008.1 990049	Brake System: ATE	
CHEVROLET - CRUZE (J300) 05/09→					
 Brake Disc					
1.4	74 - 09/10→ 103	Fitting Position: Front Axle	24.0326-0165.1 526165	Outer diameter [mm]: 276 Brake Disc Thickness [mm] 26 Minimum thickness [mm] 23 Brake Disc Type: Vented Supplementary Article/Info 2: with bolts/screws	
1.6	80 - 05/09→ 91				
1.7 D	96 01/12→				
1.7 TD	81 11/13→				
1.8	104 05/09→		24.0326-0166.1 526166	Outer diameter [mm]: 300 Brake Disc Thickness [mm] 26 Minimum thickness [mm] 23 Brake Disc Type: Vented Supplementary Article/Info 2: with bolts/screws	
1.8 LPG	104 06/11→				
2.0 CDI	92 - 05/09→ 120				
2.0 VCDi	122 03/12→11/18	Fitting Position: Rear Axle	24.0312-0188.1 512188	Outer diameter [mm]: 268 Brake Disc Thickness [mm] 12 Minimum thickness [mm] 10 Brake Disc Type: Solid Supplementary Article/Info 2: with bolts/screws	
			24.0312-0189.1 512189	Outer diameter [mm]: 292 Brake Disc Thickness [mm] 12 Minimum thickness [mm] 10 Brake Disc Type: Solid Supplementary Article/Info 2: with bolts/screws	
CHEVROLET - CRUZE Hatchback (J305) 12/10→					
 Brake Disc					
1.4	74 07/13→12/15	Fitting Position: Front Axle	24.0326-0165.1 526165	Outer diameter [mm]: 276 Brake Disc Thickness [mm] 26 Minimum thickness [mm] 23 Brake Disc Type: Vented Supplementary Article/Info 2: with bolts/screws	
1.6	83 - 06/11→ 91				
1.7 D	96 01/12→12/15				
1.7 TD	81 08/13→12/15				
1.8	104 06/11→				
→					

		kW					
CHEVROLET - CRUZE Hatchback (J305) 12/10→							
 Brake Disc							
1.8 LPG 2.0 CDI	104 06/11→12/15	Fitting Position: Front Axle		24.0326-0166.1 526166	Outer diameter [mm]: 300 Brake Disc Thickness [mm] 26 Minimum thickness [mm] 23 Brake Disc Type: Vented Supplementary Article/Info 2: with bolts/screws		
	120 06/11→	Fitting Position: Rear Axle			24.0312-0188.1 512188	Outer diameter [mm]: 268 Brake Disc Thickness [mm] 12 Minimum thickness [mm] 10 Brake Disc Type: Solid Supplementary Article/Info 2: with bolts/screws	
				24.0312-0189.1 512189	Outer diameter [mm]: 292 Brake Disc Thickness [mm] 12 Minimum thickness [mm] 10 Brake Disc Type: Solid Supplementary Article/Info 2: with bolts/screws		
1.4	103 06/12→	Construction year from: 08/12 →; Fitting Position: Front Axle		24.0326-0165.1 526165	Outer diameter [mm]: 276 Brake Disc Thickness [mm] 26 Minimum thickness [mm] 23 Brake Disc Type: Vented Supplementary Article/Info 2: with bolts/screws		
		Construction year from: 08/12 →; Fitting Position: Rear Axle			24.0312-0188.1 512188	Outer diameter [mm]: 268 Brake Disc Thickness [mm] 12 Minimum thickness [mm] 10 Brake Disc Type: Solid Supplementary Article/Info 2: with bolts/screws	
				24.0312-0189.1 512189	Outer diameter [mm]: 292 Brake Disc Thickness [mm] 12 Minimum thickness [mm] 10 Brake Disc Type: Solid Supplementary Article/Info 2: with bolts/screws		
CHEVROLET - CRUZE Station Wagon (J308) 08/12→							
 Brake Disc							
1.4 1.6 1.7 TD 1.8 2.0 TD	74 - 08/12→ 103	Fitting Position: Front Axle		24.0326-0165.1 526165	Outer diameter [mm]: 276 Brake Disc Thickness [mm] 26 Minimum thickness [mm] 23 Brake Disc Type: Vented Supplementary Article/Info 2: with bolts/screws		
	86 - 08/12→12/15 91				24.0312-0188.1 512188	Outer diameter [mm]: 268 Brake Disc Thickness [mm] 12 Minimum thickness [mm] 10 Brake Disc Type: Solid Supplementary Article/Info 2: with bolts/screws	
	81 - 08/12→ 96			24.0312-0189.1 512189	Outer diameter [mm]: 292 Brake Disc Thickness [mm] 12 Minimum thickness [mm] 10 Brake Disc Type: Solid Supplementary Article/Info 2: with bolts/screws		
	104 08/12→ 120 08/12→	Fitting Position: Rear Axle		24.0326-0166.1 526166	Outer diameter [mm]: 300 Brake Disc Thickness [mm] 26 Minimum thickness [mm] 23 Brake Disc Type: Vented Supplementary Article/Info 2: with bolts/screws		

	kW				
CHEVROLET - ORLANDO (J309) 12/10→					
 Brake Disc					
1.4 1.8 1.8 LPG 2.0 D	103 06/12→ 104 02/11→ 104 06/11→12/15 96 - 02/11→ 120	Fitting Position: Front Axle	24.0326-0166.1 526166	Outer diameter [mm]: 300 Brake Disc Thickness [mm] 26 Minimum thickness [mm] 23 Brake Disc Type: Vented Supplementary Article/Info 2: with bolts/screws	
		Fitting Position: Rear Axle	24.0312-0189.1 512189	Outer diameter [mm]: 292 Brake Disc Thickness [mm] 12 Minimum thickness [mm] 10 Brake Disc Type: Solid Supplementary Article/Info 2: with bolts/screws	
CHEVROLET - TRAX 12/12→					
 Brake Pad Set, disc brake					
1.4 1.4 AWD 1.6 1.8 1.8 AWD	103 12/12→ 103 12/12→ 85 12/12→ 103 03/13→ 103 03/13→	Production date from: 2018 →; Fitting Position: Front Axle	13.0460-5527.2 605527	Brake System: Mando Wear Warning Contact: with acoustic wear warning Supplementary Article/Supplementary Info: with accessories	
 Brake Disc					
1.4 1.4 AWD 1.4 LPG 1.6 1.7 TD 1.7 TD AWD 1.8	103 12/12→ 103 12/12→ 103 04/13→ 85 12/12→ 96 12/12→ 96 12/12→ 103 03/13→	Fitting Position: Rear Axle	24.0312-0188.1 512188	Outer diameter [mm]: 268 Brake Disc Thickness [mm] 12 Minimum thickness [mm] 10 Brake Disc Type: Solid Supplementary Article/Info 2: with bolts/screws	
CHEVROLET - VOLT 04/11→					
 Brake Disc					
EV 150	111 11/11→	Fitting Position: Front Axle	24.0326-0166.1 526166	Outer diameter [mm]: 300 Brake Disc Thickness [mm] 26 Minimum thickness [mm] 23 Brake Disc Type: Vented Supplementary Article/Info 2: with bolts/screws	
		Vehicle Equipment: for vehicles with electric parking brake; Fitting Position: Rear Axle	24.0312-0189.1 512189	Outer diameter [mm]: 292 Brake Disc Thickness [mm] 12 Minimum thickness [mm] 10 Brake Disc Type: Solid Supplementary Article/Info 2: with bolts/screws	
CHEVROLET - ZAFIRA (F75) 02/99→12/12					
Guide Sleeve Kit, brake caliper					
2.0	89 08/04→12/12	→ Construction year to: 06/05; Fitting Position: Front Axle	11.0101-5407.2 260011	Brake System: ATE	
Guide Bolt, brake caliper					
2.0	89 08/04→12/12	→ Construction year to: 06/05; Required quantity: 2; Fitting Position: Front Axle	2 11.8171-0008.1 990049	Brake System: ATE	
CHRYSLER - 200 Convertible 01/10→					
 Brake Caliper					
2.4 3.6 3.6 Flexfuel	129 01/11→12/14 211 09/11→12/12 211 09/10→	Equipment Code: BRF / BRG; Fitting Position: Front Axle Left	24.3571-1815.5 241485	Supplementary Article/Supplementary Info: without holder Brake Caliper Type: Fist-type Caliper	
		Equipment Code: BRF / BRG; Fitting Position: Front Axle Right	24.3571-1816.5 241486	Supplementary Article/Supplementary Info: without holder Brake Caliper Type: Fist-type Caliper	
CHRYSLER - 200 Saloon 01/10→					
 Brake Caliper					
3.6 Flexfuel	211 09/10→	Equipment Code: BRF / BRG; Fitting Position: Front Axle Left	24.3571-1815.5 241485	Supplementary Article/Supplementary Info: without holder Brake Caliper Type: Fist-type Caliper	
→					

	kW				
CHRYSLER - 200 Saloon 01/10→					
 Brake Caliper					
3.6 Flexfuel	211 09/10→	Equipment Code: BRF / BRG; Fitting Position: Front Axle Right		24.3571-1816.5 241486	Supplementary Article/Supplementary Info: without holder Brake Caliper Type: Fist-type Caliper
CHRYSLER - 200 Saloon 06/14→					
 Brake Caliper					
2.4	129 07/14→	Equipment Code: BRF / BRG; Fitting Position: Front Axle Left		24.3571-1816.5 241486	Supplementary Article/Supplementary Info: without holder Brake Caliper Type: Fist-type Caliper
		Equipment Code: BRF / BRG; Fitting Position: Front Axle Right		24.3571-1816.5 241486	Supplementary Article/Supplementary Info: without holder Brake Caliper Type: Fist-type Caliper
CHRYSLER - DELTA 08/11→					
Guide Bolt, brake caliper					
2.0 D Multijet	121 08/11→	Required quantity: 2	2	11.8171-0008.1 990049	Brake System: ATE
CHRYSLER - SEBRING (JS) 09/06→12/10					
 Brake Caliper					
2.0 CRD	103 07/07→12/10	Fitting Position: Front Axle Left		24.3571-1816.5 241486	Supplementary Article/Supplementary Info: without holder Brake Caliper Type: Fist-type Caliper
2.0 VVT	115 07/07→12/10				
2.4	128 09/06→12/10				
2.4 VVT	125 07/07→12/10				
2.7	138 07/07→12/10	Fitting Position: Front Axle Right		24.3571-1816.5 241486	Supplementary Article/Supplementary Info: without holder Brake Caliper Type: Fist-type Caliper
2.7 VVT	137 07/07→09/10				
3.5	175 09/06→12/08				
2.7 VVT	141 09/06→12/10	Construction year from: 07/07 →; Fitting Position: Front Axle Left		24.3571-1816.5 241486	Supplementary Article/Supplementary Info: without holder Brake Caliper Type: Fist-type Caliper
		Construction year from: 07/07 →; Fitting Position: Front Axle Right		24.3571-1816.5 241486	Supplementary Article/Supplementary Info: without holder Brake Caliper Type: Fist-type Caliper
CHRYSLER - SEBRING Convertible (JS) 05/07→12/10					
 Brake Caliper					
2.0 CRD	103 07/07→12/10	Fitting Position: Front Axle Left		24.3571-1816.5 241486	Supplementary Article/Supplementary Info: without holder Brake Caliper Type: Fist-type Caliper
2.4	128 05/07→12/10				
2.4 VVT	125 07/07→12/10				
2.7	137 07/07→12/10				
2.7 Flexfuel	137 05/07→09/10	Fitting Position: Front Axle Right		24.3571-1816.5 241486	Supplementary Article/Supplementary Info: without holder Brake Caliper Type: Fist-type Caliper
2.7 VVT	141 07/07→12/10				
3.5	175 05/07→12/10				
CHRYSLER - YPSILON 05/11→					
Guide Bolt, brake caliper					
0.9 Twinair	63 05/11→	Required quantity: 2	2	11.8171-0008.1 990049	Brake System: ATE
1.2	51 05/11→				
1.3 Multijet	70 05/11→				
CITROËN - BERLINGO / BERLINGO FIRST Box Body/MPV (M_) 07/96→12/11					
Spring, brake caliper					
Electric	42 01/11→12/11	Required quantity: 2	2	11.8116-0356.1 390586	Brake System: ATE
Guide Bolt, brake caliper					
Electric	42 01/11→12/11	Required quantity: 2	2	11.8171-0008.1 990049	Brake System: ATE
CITROËN - BERLINGO (ER_, EC_) 06/18→					
Guide Sleeve Kit, brake caliper					
1.2 PureTech 110	81 06/18→	Fitting Position: Front Axle		11.0101-5407.2 260011	Brake System: ATE
1.2 PureTech 130	96 07/19→				
1.5 BlueHDi 100	75 06/18→				
1.5 BlueHDi 130	96 06/18→				
1.5 BlueHDi 75	56 06/18→				
e-Berlingo	100 07/21→				
→					

	kW								
CITROËN - BERLINGO (ER_, EC_) 06/18→									
Guide Bolt, brake caliper									
1.2 PureTech 110	81 06/18→	Required quantity: 2; Fitting Position: Front Axle	2	11.8171-0008.1 990049	Brake System: ATE				
1.2 PureTech 130	96 07/19→								
1.5 BlueHDi 100	75 06/18→								
1.5 BlueHDi 130	96 06/18→								
1.5 BlueHDi 75	56 06/18→								
e-Berlingo	100 07/21→								
CITROËN - BERLINGO Box Body/MPV (B9) 04/08→									
Spring, brake caliper									
1.6	66 - 04/08→ 80	Required quantity: 2	2	11.8116-0356.1 390586	Brake System: ATE				
1.6 BlueHDi 100	73 12/14→								
1.6 BlueHDi 100 4x4	73 12/14→								
1.6 BlueHDi 120	88 12/14→								
1.6 HDi 110	80 - 04/08→ 82								
1.6 HDi 115	84 07/10→								
1.6 HDi 115 4x4	84 02/12→								
1.6 HDi 75	55 04/08→								
1.6 HDi 75 4x4	55 02/12→								
1.6 HDi 90	66 - 07/10→ 68								
1.6 HDi 90 16V	66 04/08→								
1.6 HDi 90 4x4	66 02/12→								
1.6 VTi 120	88 11/09→								
1.6 VTi 95	72 07/10→								
Electric	49 01/13→								
1.6 HDi / BlueHDi 75	55 07/10→					Construction year from: 04/15 →; Required quantity: 2	2	11.8116-0356.1 390586	Brake System: ATE
Electric	35 01/13→					Construction year from: 02/13 →; Required quantity: 2	2	11.8116-0356.1 390586	Brake System: ATE
PureTech 110	81 01/18→					Fitting Position: Front Axle		11.8116-0356.1 390586	Brake System: ATE
Guide Bolt, brake caliper									
1.6	66 - 04/08→ 80					Required quantity: 2	2	11.8171-0008.1 990049	Brake System: ATE
1.6 BlueHDi 100	73 12/14→								
1.6 BlueHDi 100 4x4	73 12/14→								
1.6 BlueHDi 120	88 12/14→								
1.6 HDi 110	80 - 04/08→ 82								
1.6 HDi 115	84 07/10→								
1.6 HDi 115 4x4	84 02/12→								
1.6 HDi 75	55 04/08→								
1.6 HDi 75 4x4	55 02/12→								
1.6 HDi 90	66 - 07/10→ 68								
1.6 HDi 90 16V	66 04/08→								
1.6 HDi 90 4x4	66 02/12→								
1.6 VTi 120	88 11/09→								
1.6 VTi 95	72 07/10→								
Electric	49 01/13→								
1.6 HDi / BlueHDi 75	55 07/10→	Construction year from: 04/15 →; Required quantity: 2	2	11.8171-0008.1 990049	Brake System: ATE				
Electric	35 01/13→	Construction year from: 02/13 →; Required quantity: 2	2	11.8171-0008.1 990049	Brake System: ATE				
PureTech 110	81 01/18→	Fitting Position: Front Axle		11.8171-0008.1 990049	Brake System: ATE				
CITROËN - BERLINGO Box Body/MPV (K9) 06/18→									
Guide Sleeve Kit, brake caliper									
1.5 BlueHDi 100	75 06/18→	Fitting Position: Front Axle		11.0101-5407.2 260011	Brake System: ATE				
1.5 BlueHDi 130	96 06/18→								
1.5 BlueHDi 130 4x4	96 06/18→								
1.5 BlueHDi 75	55 10/19→								
1.6 BlueHDi 100	73 06/18→								
1.6 BlueHDi 75	55 06/18→								
e-Berlingo	100 07/21→								
PureTech 110	81 06/18→								
PureTech 130	96 10/19→								
Guide Bolt, brake caliper									
1.5 BlueHDi 100	75 06/18→					Required quantity: 2; Fitting Position: Front Axle	2	11.8171-0008.1 990049	Brake System: ATE
1.5 BlueHDi 130	96 06/18→								
1.5 BlueHDi 130 4x4	96 06/18→								
1.5 BlueHDi 75	55 10/19→								
1.6 BlueHDi 100	73 06/18→								
1.6 BlueHDi 75	55 06/18→								
e-Berlingo	100 07/21→								
PureTech 110	81 06/18→								
PureTech 130	96 10/19→								

	kW				
CITROËN - BERLINGO MULTISPACE (B9) 04/08→					
Spring, brake caliper					
1.2 PureTech 110 1.6	81 02/16→ 66 - 04/08→ 81	Required quantity: 2	2	11.8116-0356.1 390586	Brake System: ATE
1.6 BlueHDi 100 1.6 BlueHDi 120 1.6 HDi 110	73 12/14→ 88 12/14→ 80 - 04/08→ 82				
1.6 HDi 115 1.6 HDi 115 4x4 1.6 HDi 75 16V 1.6 HDi 90	84 07/10→ 84 02/12→ 55 04/08→ 66 - 04/08→ 68				
1.6 HDi 90 4x4 1.6 VTi 120 1.6 VTi 95	66 02/12→12/14 88 11/09→ 72 07/10→				
1.6 HDi 75 / BlueHDi 75	55 04/08→	Construction year from: 04/15 →; Required quantity: 2	2	11.8116-0356.1 390586	Brake System: ATE
Electric	49 09/17→	Fitting Position: Front Axle		11.8116-0356.1 390586	Brake System: ATE
Guide Bolt, brake caliper					
1.2 PureTech 110 1.6	81 02/16→ 66 - 04/08→ 81	Required quantity: 2	2	11.8171-0008.1 990049	Brake System: ATE
1.6 BlueHDi 100 1.6 BlueHDi 120 1.6 HDi 110	73 12/14→ 88 12/14→ 80 - 04/08→ 82				
1.6 HDi 115 1.6 HDi 115 4x4 1.6 HDi 75 16V 1.6 HDi 90	84 07/10→ 84 02/12→ 55 04/08→ 66 - 04/08→ 68				
1.6 HDi 90 4x4 1.6 VTi 120 1.6 VTi 95	66 02/12→12/14 88 11/09→ 72 07/10→				
1.6 HDi 75 / BlueHDi 75	55 04/08→	Construction year from: 04/15 →; Required quantity: 2	2	11.8171-0008.1 990049	Brake System: ATE
Electric	49 09/17→	Fitting Position: Front Axle		11.8171-0008.1 990049	Brake System: ATE
CITROËN - BERLINGO Platform/Chassis (B9) 04/08→					
Spring, brake caliper					
1.6 BlueHDi 100 1.6 HDi 90 1.6 HDi 90 16V 1.6 HDi 92	73 12/14→ 66 07/10→ 66 04/08→ 68 07/10→12/17	Required quantity: 2	2	11.8116-0356.1 390586	Brake System: ATE
Guide Bolt, brake caliper					
1.6 BlueHDi 100 1.6 HDi 90 1.6 HDi 90 16V 1.6 HDi 92	73 12/14→ 66 07/10→ 66 04/08→ 68 07/10→12/17	Required quantity: 2	2	11.8171-0008.1 990049	Brake System: ATE
CITROËN - C4 I (LC_) 11/04→11/14					
Spring, brake caliper					
2.0 16V 2.0 HDi	130 11/04→07/08 100 - 11/04→07/11 103	for RPO number (vehicle manufacturing date) from: 11578 →; Required quantity: 2	2	11.8116-0356.1 390586	Brake System: ATE
Guide Bolt, brake caliper					
2.0 16V 2.0 HDi	130 11/04→07/08 100 - 11/04→07/11 103	for RPO number (vehicle manufacturing date) from: 11578 →; Required quantity: 2	2	11.8171-0008.1 990049	Brake System: ATE
		→ for RPO number (vehicle manufacturing date) up to: 10487; Required quantity: 2; Fitting Position: Front Axle	2	11.8171-0008.1 990049	Brake System: ATE
		for RPO number (vehicle manufacturing date) from: 10488 → → for RPO number (vehicle manufacturing date) up to: 11577; Required quantity: 2; Fitting Position: Front Axle	2	11.8171-0008.1 990049	Brake System: ATE
CITROËN - C4 I Hatchback Van (LR_) 02/05→12/10					
Spring, brake caliper					
2.0 HDi	100 02/05→12/10	for RPO number (vehicle manufacturing date) from: 11578 →; Required quantity: 2	2	11.8116-0356.1 390586	Brake System: ATE
→					

	kW				
CITROËN - C4 GRAND PICASSO I (UA_) 10/06→12/13					
Spring, brake caliper					
1.6 16V 2.0 HDi 138 2.0 i 16V	110 10/08→08/13 100 10/06→12/13 103 - 10/06→08/13 105	→ for RPO number (vehicle manufacturing date) up to: 11920; Required quantity: 2; Fitting Position: Front Axle	2	11.8116-0356.1 390586	Brake System: ATE
1.6 HDi 1.8 i 16V 1.8 i 16V CNG 1.8 i 16V Flex	80 10/06→06/11 92 10/06→12/10 86 03/09→12/11 86 06/09→01/13	for RPO number (vehicle manufacturing date) from: 11767 →; Required quantity: 2	2	11.8116-0356.1 390586	Brake System: ATE
		→ for RPO number (vehicle manufacturing date) up to: 11766; Required quantity: 2; Fitting Position: Front Axle	2	11.8116-0356.1 390586	Brake System: ATE
1.6 HDi 110 2.0 HDi 150	82 09/10→08/13 110 07/09→08/13	→ Construction year to: 07/13; Required quantity: 2	2	11.8116-0356.1 390586	Brake System: ATE
1.6 THP 155 2.0 HDi 165	115 09/10→08/13 120 09/10→08/13	Construction year from: 11/10 → → Construction year to: 07/13; Required quantity: 2	2	11.8116-0356.1 390586	Brake System: ATE
1.6 VTi 120	88 07/08→08/13	for RPO number (vehicle manufacturing date) from: 11767 →; → Construction year to: 07/13; Required quantity: 2	2	11.8116-0356.1 390586	Brake System: ATE
		→ for RPO number (vehicle manufacturing date) up to: 11766; Required quantity: 2; Fitting Position: Front Axle	2	11.8116-0356.1 390586	Brake System: ATE
Guide Bolt, brake caliper					
1.6 16V	103 07/08→12/10	for RPO number (vehicle manufacturing date) from: 11921 →; Required quantity: 2	2	11.8171-0008.1 990049	Brake System: ATE
		→ for RPO number (vehicle manufacturing date) up to: 11920; Required quantity: 2; Fitting Position: Front Axle	2	11.8171-0008.1 990049	Brake System: ATE
1.6 16V 2.0 HDi 138 2.0 i 16V	110 10/08→08/13 100 10/06→12/13 103 - 10/06→08/13 105	for RPO number (vehicle manufacturing date) from: 11921 →; → Construction year to: 07/13; Required quantity: 2	2	11.8171-0008.1 990049	Brake System: ATE
		→ for RPO number (vehicle manufacturing date) up to: 11920; Required quantity: 2; Fitting Position: Front Axle	2	11.8171-0008.1 990049	Brake System: ATE
1.6 HDi 1.8 i 16V 1.8 i 16V CNG 1.8 i 16V Flex	80 10/06→06/11 92 10/06→12/10 86 03/09→12/11 86 06/09→01/13	for RPO number (vehicle manufacturing date) from: 11767 →; Required quantity: 2	2	11.8171-0008.1 990049	Brake System: ATE
		→ for RPO number (vehicle manufacturing date) up to: 11766; Required quantity: 2; Fitting Position: Front Axle	2	11.8171-0008.1 990049	Brake System: ATE
1.6 HDi 110 2.0 HDi 150	82 09/10→08/13 110 07/09→08/13	→ Construction year to: 07/13; Required quantity: 2	2	11.8171-0008.1 990049	Brake System: ATE
1.6 THP 155 2.0 HDi 165	115 09/10→08/13 120 09/10→08/13	Construction year from: 11/10 → → Construction year to: 07/13; Required quantity: 2	2	11.8171-0008.1 990049	Brake System: ATE
1.6 VTi 120	88 07/08→08/13	for RPO number (vehicle manufacturing date) from: 11767 →; → Construction year to: 07/13; Required quantity: 2	2	11.8171-0008.1 990049	Brake System: ATE
		→ for RPO number (vehicle manufacturing date) up to: 11766; Required quantity: 2; Fitting Position: Front Axle	2	11.8171-0008.1 990049	Brake System: ATE
CITROËN - C4 GRAND PICASSO II (DA_, DE_) 06/13→					
Guide Sleeve Kit, brake caliper					
1.2 THP 130 1.6 BlueHDi 100 1.6 BlueHDi 120 1.6 HDi / BlueHDi 115 1.6 HDi 90 1.6 THP 150 1.6 THP 155 1.6 THP 165 1.6 VTi 120 2.0 BlueHDi 135 2.0 BlueHDi 150 →	96 04/14 → 73 01/15 → 88 07/14 → 85 09/13 → 68 09/13 → 110 09/14 → 115 09/13 → 121 07/14 → 88 09/13 → 100 09/13 → 110 06/13 → →	for brake disc diameter [mm]: 283 / 304; Fitting Position: Front Axle		11.0101-5407.2 260011	Brake System: ATE

	kW				
CITROËN - C4 PICASSO I MPV (UD_) 10/06→12/15					
Guide Bolt, brake caliper					
1.8 Bifuel 1.8 i 16V	92 01/09→10/12 92 02/07→12/11	for RPO number (vehicle manufacturing date) from: 11767 →; Required quantity: 2	2	11.8171-0008.1 990049	Brake System: ATE
		→ for RPO number (vehicle manufacturing date) up to: 11766; Required quantity: 2; Fitting Position: Front Axle	2	11.8171-0008.1 990049	Brake System: ATE
2.0 HDi 138	100 10/06→08/13	for RPO number (vehicle manufacturing date) from: 11921 →; → Construction year to: 07/13; Required quantity: 2	2	11.8171-0008.1 990049	Brake System: ATE
		Construction year from: 02/07 →; → for RPO number (vehicle manufacturing date) up to: 11920; Required quantity: 2; Fitting Position: Front Axle	2	11.8171-0008.1 990049	Brake System: ATE
2.0 HDi 150	110 07/09→08/13	→ Construction year to: 07/13; Required quantity: 2	2	11.8171-0008.1 990049	Brake System: ATE
2.0 i 16V	105 05/08→05/13	for RPO number (vehicle manufacturing date) from: 11921 →; Required quantity: 2	2	11.8171-0008.1 990049	Brake System: ATE
		→ for RPO number (vehicle manufacturing date) up to: 11920; Required quantity: 2; Fitting Position: Front Axle	2	11.8171-0008.1 990049	Brake System: ATE
CITROËN - C4 PICASSO II 01/13→					
Guide Sleeve Kit, brake caliper					
1.2 THP 110 1.2 THP 130 1.6 BlueHDi 100 1.6 BlueHDi 120 1.6 HDi / BlueHDi 115 1.6 HDi 90 1.6 THP 150 1.6 THP 155 1.6 THP 165 1.6 VTi 120 2.0 BlueHDi 135 2.0 BlueHDi 150	81 04/16→ 96 04/14→ 73 12/14→ 88 07/14→ 85 02/13→ 68 02/13→ 110 09/14→ 115 02/13→ 121 07/14→ 88 02/13→ 100 09/13→ 110 09/13→	for brake disc diameter [mm]: 283 / 304; Fitting Position: Front Axle	2	11.0101-5407.2 260011	Brake System: ATE
Guide Bolt, brake caliper					
1.2 THP 110 1.2 THP 130 1.6 BlueHDi 100 1.6 BlueHDi 120 1.6 HDi / BlueHDi 115 1.6 HDi 90 1.6 THP 150 1.6 THP 155 1.6 THP 165 1.6 VTi 120 2.0 BlueHDi 135 2.0 BlueHDi 150	81 04/16→ 96 04/14→ 73 12/14→ 88 07/14→ 85 02/13→ 68 02/13→ 110 09/14→ 115 02/13→ 121 07/14→ 88 02/13→ 100 09/13→ 110 09/13→	for brake disc diameter [mm]: 283 / 304; Required quantity: 2; Fitting Position: Front Axle	2	11.8171-0008.1 990049	Brake System: ATE
CITROËN - C4 PICASSO II Van (DD_) 01/13→					
Guide Sleeve Kit, brake caliper					
BlueHDi 150 e-HDi HDi / e-HDi THP 155 VTi 120	110 09/13→ 85 02/13→ 68 02/13→ 115 02/13→ 88 02/13→	for brake disc diameter [mm]: 283 / 304; Fitting Position: Front Axle	2	11.0101-5407.2 260011	Brake System: ATE
Guide Bolt, brake caliper					
BlueHDi 150 e-HDi HDi / e-HDi THP 155 VTi 120	110 09/13→ 85 02/13→ 68 02/13→ 115 02/13→ 88 02/13→	for brake disc diameter [mm]: 283 / 304; Required quantity: 2; Fitting Position: Front Axle	2	11.8171-0008.1 990049	Brake System: ATE
CITROËN - C4 SPACETOURER (3D_) 04/18→					
Guide Sleeve Kit, brake caliper					
1.2 PureTech 110 1.2 PureTech 130 1.5 BlueHDi 130 1.6 BlueHDi 100 1.6 BlueHDi 120 1.6 THP 165 2.0 BlueHDi 150 →	81 04/18→ 96 04/18→ 96 05/18→ 73 04/18→ 88 04/18→ 121 04/18→ 110 04/18→	for brake disc diameter [mm]: 283 / 304; Fitting Position: Front Axle	2	11.0101-5407.2 260011	Brake System: ATE

	kW				
CITROËN - C4 SPACETOURER (3D_) 04/18→					
Guide Sleeve Kit, brake caliper					
2.0 BlueHDi 160	120 04/18→	for brake disc diameter [mm]: 283 / 304; Fitting Position: Front Axle		11.0101-5407.2 260011	Brake System: ATE
Guide Bolt, brake caliper					
1.2 PureTech 110	81 04/18→	for brake disc diameter [mm]: 283 / 304; Required quantity: 2; Fitting Position: Front Axle	2	11.8171-0008.1 990049	Brake System: ATE
1.2 PureTech 130	96 04/18→				
1.5 BlueHDi 130	96 05/18→				
1.6 BlueHDi 100	73 04/18→				
1.6 BlueHDi 120	88 04/18→				
1.6 THP 165	121 04/18→				
2.0 BlueHDi 150	110 04/18→				
2.0 BlueHDi 160	120 04/18→				
CITROËN - C4 SPACETOURER Van (3D_) 04/18→					
Guide Sleeve Kit, brake caliper					
BlueHDi 120	88 05/19→	for brake disc diameter [mm]: 283 / 304; Fitting Position: Front Axle		11.0101-5407.2 260011	Brake System: ATE
BlueHDi 130	96 05/19→				
PureTech 130	96 05/19→				
Guide Bolt, brake caliper					
BlueHDi 120	88 05/19→	for brake disc diameter [mm]: 283 / 304; Required quantity: 2; Fitting Position: Front Axle	2	11.8171-0008.1 990049	Brake System: ATE
BlueHDi 130	96 05/19→				
PureTech 130	96 05/19→				
CITROËN - C5 III (RD_) 02/08→					
Spring, brake caliper					
1.6	120 03/11→	for RPO number (vehicle manufacturing date) from: 12999 →; Required quantity: 2; Fitting Position: Front Axle	2	11.8116-0356.1 390586	Brake System: ATE
1.6 HDi 110	80 - 02/08→ 82				
1.6 HDi 115	84 01/12→	→ for RPO number (vehicle manufacturing date) up to: 12998; Required quantity: 2; Fitting Position: Front Axle	2	11.8116-0356.1 390586	Brake System: ATE
1.6 THP 150	110 07/10→				
1.6 THP 155	115 04/09→				
1.6 VTi 120	88 07/10→				
1.8 16V	92 02/08→				
2.0 16V	103 02/08→				
2.0 16V BioFlex	103 02/08→12/12				
2.0 HDi	100 - 02/08→ 101				
2.0 HDi 140	103 11/08→				
2.0 HDi 165	120 04/09→				
2.0 HDi 150 / BlueHDi 150	110 04/09→02/15		Required quantity: 2; Fitting Position: Front Axle	2	11.8116-0356.1 390586
Guide Sleeve Kit, brake caliper					
1.6	120 03/11→	→ for RPO number (vehicle manufacturing date) up to: 12998; Fitting Position: Front Axle		11.0101-5407.2 260011	Brake System: ATE
1.6 HDi 110	80 - 02/08→ 82				
1.6 HDi 115	84 01/12→	Vehicle Equipment: for vehicles with electric parking brake; Fitting Position: Rear Axle		11.0101-5407.2 260011	Brake System: ATE
1.6 THP 150	110 07/10→				
1.6 THP 155	115 04/09→				
1.6 VTi 120	88 07/10→				
1.8 16V	92 02/08→				
2.0 16V	103 02/08→				
2.0 16V BioFlex	103 02/08→12/12				
2.0 HDi	100 - 02/08→ 101				
2.0 HDi 140	103 11/08→				
2.0 HDi 165	120 04/09→				
2.0 HDi 150 / BlueHDi 150	110 04/09→02/15		Vehicle Equipment: for vehicles with electric parking brake; Fitting Position: Rear Axle		11.0101-5407.2 260011
2.2 HDi	120 - 02/08→12/11 125				
2.7 HDi	150 02/08→				
3.0 V6	155 02/08→				
2.0 HDi 180	133 03/15→	Fitting Position: Front Axle		11.0101-5407.2 260011	Brake System: ATE
		Vehicle Equipment: for vehicles with electric parking brake; Fitting Position: Rear Axle		11.0101-5407.2 260011	Brake System: ATE
2.2 HDi 200	150 07/10→	→ for RPO number (vehicle manufacturing date) up to: 12774; Fitting Position: Front Axle		11.0101-5407.2 260011	Brake System: ATE
3.0 HDi 240	177 04/09→10/14				
		Vehicle Equipment: for vehicles with electric parking brake; Fitting Position: Rear Axle		11.0101-5407.2 260011	Brake System: ATE
Guide Bolt, brake caliper					
1.6	120 03/11→	for RPO number (vehicle manufacturing date) from: 12999 →;	2	11.8171-0008.1 990049	Brake System: ATE
1.6 HDi 110	80 - 02/08→ 82				

	kW				
CITROËN - C5 III (RD_) 02/08→					
Guide Bolt, brake caliper					
1.6 HDi 115	84 01/12→		Required quantity: 2;		
1.6 THP 150	110 07/10→		Fitting Position: Front Axle		
1.6 THP 155	115 04/09→		→ for RPO number (vehicle manufacturing date) up to: 12998;	2	11.8171-0008.1 990049 Brake System: ATE
1.6 VTi 120	88 07/10→		Required quantity: 2;		
1.8 16V	92 02/08→		Fitting Position: Front Axle		
2.0 16V	103 02/08→				
2.0 16V BioFlex	103 02/08→12/12		Vehicle Equipment: for vehicles with electric parking brake;	2	11.8171-0008.1 990049 Brake System: ATE
2.0 HDi	100 - 02/08→		Required quantity: 2;		
2.0 HDi 140	103 11/08→		Fitting Position: Rear Axle		
2.0 HDi 165	120 04/09→				
2.0 HDi 150 / BlueHDi 150	110 04/09→02/15		Required quantity: 2;	2	11.8171-0008.1 990049 Brake System: ATE
			Fitting Position: Front Axle		
			Vehicle Equipment: for vehicles with electric parking brake;	2	11.8171-0008.1 990049 Brake System: ATE
			Required quantity: 2;		
			Fitting Position: Rear Axle		
2.0 HDi 180	133 03/15→		Required quantity: 2	2	11.8171-0008.1 990049 Brake System: ATE
			Vehicle Equipment: for vehicles with electric parking brake;	2	11.8171-0008.1 990049 Brake System: ATE
			Required quantity: 2;		
			Fitting Position: Rear Axle		
2.2 HDi	120 - 02/08→12/11		Vehicle Equipment: for vehicles with electric parking brake;	2	11.8171-0008.1 990049 Brake System: ATE
2.7 HDi	125		Required quantity: 2;		
3.0 V6	150 02/08→		Fitting Position: Rear Axle		
	155 02/08→				
2.2 HDi 200	150 07/10→		→ for RPO number (vehicle manufacturing date) up to: 12774;	2	11.8171-0008.1 990049 Brake System: ATE
3.0 HDi 240	177 04/09→10/14		Required quantity: 2		
			Vehicle Equipment: for vehicles with electric parking brake;	2	11.8171-0008.1 990049 Brake System: ATE
			Required quantity: 2;		
			Fitting Position: Rear Axle		
CITROËN - C5 III Break (RW_) 02/08→					
Spring, brake caliper					
1.6 HDi 110	80 - 02/08→		for RPO number (vehicle manufacturing date) from: 12999 →;	2	11.8116-0356.1 390586 Brake System: ATE
	82		Required quantity: 2;		
1.6 HDi 115	84 01/12→		Fitting Position: Front Axle		
1.6 THP 150	110 04/09→				
1.6 THP 155	115 04/09→		→ for RPO number (vehicle manufacturing date) up to: 12998;	2	11.8116-0356.1 390586 Brake System: ATE
1.6 VTi 120	88 07/10→		Required quantity: 2;		
1.8 16V	92 02/08→12/09		Fitting Position: Front Axle		
2.0 16V	103 02/08→12/11				
2.0 16V BioFlex	103 02/08→				
2.0 HDi	100 02/08→				
2.0 HDi 140	103 04/09→				
2.0 HDi 150 / BlueHDi 150	110 04/09→02/15				
2.0 HDi 165	120 04/09→				
Guide Sleeve Kit, brake caliper					
1.6 HDi 110	80 - 02/08→		→ for RPO number (vehicle manufacturing date) up to: 12998;		11.0101-5407.2 260011 Brake System: ATE
	82		Fitting Position: Front Axle		
1.6 HDi 115	84 01/12→				
1.6 THP 150	110 04/09→		Vehicle Equipment: for vehicles with electric parking brake;		11.0101-5407.2 260011 Brake System: ATE
1.6 THP 155	115 04/09→		Fitting Position: Rear Axle		
1.6 VTi 120	88 07/10→				
1.8 16V	92 02/08→12/09				
2.0 16V	103 02/08→12/11				
2.0 16V BioFlex	103 02/08→				
2.0 HDi	100 02/08→				
2.0 HDi 140	103 04/09→				
2.0 HDi 150 / BlueHDi 150	110 04/09→02/15				
2.0 HDi 165	120 04/09→				
2.0 HDi 180	133 03/15→		Fitting Position: Front Axle		11.0101-5407.2 260011 Brake System: ATE
2.2 HDi 200	150 07/10→				
3.0 HDi 240	177 04/09→10/14		Vehicle Equipment: for vehicles with electric parking brake;		11.0101-5407.2 260011 Brake System: ATE
			Fitting Position: Rear Axle		
2.2 HDi	125 02/08→12/11		Vehicle Equipment: for vehicles with electric parking brake;		11.0101-5407.2 260011 Brake System: ATE
2.2 HDi 165	120 02/08→		Fitting Position: Rear Axle		
2.7 HDi	150 02/08→				
3.0 V6	155 02/08→12/10				
Guide Bolt, brake caliper					
1.6 HDi 110	80 - 02/08→		for RPO number (vehicle manufacturing date) from: 12999 →;	2	11.8171-0008.1 990049 Brake System: ATE
	82		Required quantity: 2;		
1.6 HDi 115	84 01/12→		Fitting Position: Front Axle		
1.6 THP 150	110 04/09→				
→					







	kW				
CITROËN - C5 III Break (RW_) 02/08→					
Guide Bolt, brake caliper					
1.6 THP 155	115 04/09→		→ for RPO number (vehicle manufacturing date) up to: 12998;	2	11.8171-0008.1 990049 Brake System: ATE
1.6 VTI 120	88 07/10→		Required quantity: 2;		
1.8 16V	92 02/08→12/09		Fitting Position: Front Axle		
2.0 16V	103 02/08→12/11				
2.0 16V BioFlex	103 02/08→		Vehicle Equipment: for vehicles with electric parking brake;	2	11.8171-0008.1 990049 Brake System: ATE
2.0 HDi	100 02/08→		Required quantity: 2;		
2.0 HDi 140	103 04/09→		Fitting Position: Rear Axle		
2.0 HDi 150 / BlueHDi 150	110 04/09→02/15				
2.0 HDi 165	120 04/09→				
2.0 HDi 180	133 03/15→		Required quantity: 2	2	11.8171-0008.1 990049 Brake System: ATE
2.2 HDi 200	150 07/10→		Vehicle Equipment: for vehicles with electric parking brake;	2	11.8171-0008.1 990049 Brake System: ATE
3.0 HDi 240	177 04/09→10/14		Required quantity: 2;		
			Fitting Position: Rear Axle		
2.2 HDi	125 02/08→12/11		Vehicle Equipment: for vehicles with electric parking brake;	2	11.8171-0008.1 990049 Brake System: ATE
2.2 HDi 165	120 02/08→		Required quantity: 2;		
2.7 HDi	150 02/08→		Fitting Position: Rear Axle		
3.0 V6	155 02/08→12/10				
CITROËN - C5 AIRCROSS (A_) 11/18→					
Guide Sleeve Kit, brake caliper					
1.2 PureTech 130	96 11/18→		for brake disc diameter [mm]: 304;		11.0101-5407.2 260011 Brake System: ATE
1.5 BlueHDi 130	96 11/18→		→ for RPO number (vehicle manufacturing date) up to: 16354;		
1.6 Hybrid 225	133 - 04/20→		Fitting Position: Front Axle		
	165				
1.6 PureTech 180	133 11/18→				
1.6 THP 150	110 09/19→				
1.6 THP 165	121 05/19→				
2.0 BlueHDi 180	130 11/18→				
Guide Bolt, brake caliper					
1.2 PureTech 130	96 11/18→		for brake disc diameter [mm]: 304;	2	11.8171-0008.1 990049 Brake System: ATE
1.5 BlueHDi 130	96 11/18→		→ for RPO number (vehicle manufacturing date) up to: 16354;		
1.6 Hybrid 225	133 - 04/20→		Required quantity: 2;		
	165		Fitting Position: Front Axle		
1.6 PureTech 180	133 11/18→				
1.6 THP 150	110 09/19→				
1.6 THP 165	121 05/19→				
2.0 BlueHDi 180	130 11/18→				
CITROËN - C6 (TD_) 09/05→12/12					
Guide Sleeve Kit, brake caliper					
3.0 HDi	155 06/09→12/10		Fitting Position: Front Axle		11.0101-5407.2 260011 Brake System: ATE
3.0 HDi	177 04/09→12/12		Construction year from: 07/09 →;		11.0101-5407.2 260011 Brake System: ATE
			Fitting Position: Front Axle		
Guide Bolt, brake caliper					
3.0 HDi	155 06/09→12/10		Required quantity: 2	2	11.8171-0008.1 990049 Brake System: ATE
3.0 HDi	177 04/09→12/12		Construction year from: 07/09 →;	2	11.8171-0008.1 990049 Brake System: ATE
			Required quantity: 2		
CITROËN - DS4 (NX_) 03/11→07/15					
Spring, brake caliper					
1.2 THP 130	96 07/14→07/15		Required quantity: 2;	2	11.8116-0356.1 390586 Brake System: ATE
1.6 BlueHDi 120	88 07/14→07/15		Fitting Position: Front Axle		
1.6 HDi 110	82 04/11→07/15				
1.6 HDi 115	84 08/12→07/15				
1.6 HDi 90	68 05/11→07/15				
1.6 THP 150	110 04/11→07/15				
1.6 THP 155	115 04/11→07/15				
1.6 THP 160	120 04/12→07/15				
1.6 THP 165	121 01/12→07/15				
1.6 VTI 120	88 04/11→07/15				
2.0 BlueHDi 150	110 07/14→07/15				
1.6 BlueHDi 115	85 07/14→07/15		Construction year from: 08/14 →;	2	11.8116-0356.1 390586 Brake System: ATE
			Required quantity: 2;		
			Fitting Position: Front Axle		
2.0 BlueHDi 180	133 07/14→07/15		not for rim size [in]: 19;	2	11.8116-0356.1 390586 Brake System: ATE
2.0 HDi / BlueHDi 135	100 09/11→07/15		Required quantity: 2;		
2.0 HDi 165	120 04/11→07/15		Fitting Position: Front Axle		
Guide Sleeve Kit, brake caliper					
1.6 THP 200	147 04/11→07/15		Fitting Position: Front Axle		11.0101-5407.2 260011 Brake System: ATE
2.0 BlueHDi 180	133 07/14→07/15		Rim Size [in]: 19;		11.0101-5407.2 260011 Brake System: ATE
2.0 HDi / BlueHDi 135	100 09/11→07/15		Fitting Position: Front Axle		
2.0 HDi 165	120 04/11→07/15				
→					





	kW				
CITROËN - DS4 (NX_) 03/11→07/15					
Guide Bolt, brake caliper					
1.2 THP 130	96 07/14→07/15	Required quantity: 2	2	11.8171-0008.1 990049	Brake System: ATE
1.6 BlueHDi 120	88 07/14→07/15				
1.6 HDi 110	82 04/11→07/15				
1.6 HDi 115	84 08/12→07/15				
1.6 HDi 90	68 05/11→07/15				
1.6 THP 150	110 04/11→07/15				
1.6 THP 155	115 04/11→07/15				
1.6 THP 160	120 04/12→07/15				
1.6 THP 165	121 01/12→07/15				
1.6 THP 200	147 04/11→07/15				
1.6 VTi 120	88 04/11→07/15				
2.0 BlueHDi 150	110 07/14→07/15				
1.6 BlueHDi 115	85 07/14→07/15	Construction year from: 08/14 →; Required quantity: 2	2	11.8171-0008.1 990049	Brake System: ATE
2.0 BlueHDi 180	133 07/14→07/15	Rim Size [in]: 19; Required quantity: 2	2	11.8171-0008.1 990049	Brake System: ATE
2.0 HDi / BlueHDi 135	100 09/11→07/15	not for rim size [in]: 19;	2	11.8171-0008.1 990049	Brake System: ATE
2.0 HDi 165	120 04/11→07/15	Required quantity: 2			
CITROËN - DS5 09/11→12/16					
Spring, brake caliper					
1.6 BlueHDi 120	88 07/14→07/15	Required quantity: 2	2	11.8116-0356.1 390586	Brake System: ATE
1.6 HDi	85 11/13→07/15				
1.6 THP 150	110 11/11→07/15				
1.6 THP 155	115 11/11→07/15				
1.6 THP 165	121 01/12→07/15				
1.6 THP 165 Hybrid	121 06/12→07/15				
1.6 THP 200	147 11/11→07/15				
2.0 BlueHDi 150	110 07/14→07/15				
2.0 BlueHDi 180	133 08/13→07/15				
2.0 HDi 135	100 11/11→07/15				
2.0 HDi 165	120 11/11→07/15				
2.0 HDi 165 Hybrid4 4x4	120 12/11→07/15				
2.0 HDi 200 Hybrid4 All-wheel Drive	147 12/11→07/15				
1.6 HDi 110	82 11/11→07/15	for RPO number (vehicle manufacturing date) from: 13343 →; Required quantity: 2	2	11.8116-0356.1 390586	Brake System: ATE
		→ for RPO number (vehicle manufacturing date) up to: 13342; Required quantity: 2	2	11.8116-0356.1 390586	Brake System: ATE
1.6 HDi 115	84 06/12→07/15	for RPO number (vehicle manufacturing date) from: 13343 →; Required quantity: 2	2	11.8116-0356.1 390586	Brake System: ATE
		Construction year from: 08/12 →; → for RPO number (vehicle manufacturing date) up to: 13342; Required quantity: 2	2	11.8116-0356.1 390586	Brake System: ATE
Guide Sleeve Kit, brake caliper					
1.6 HDi 110	82 11/11→07/15	Fitting Position: Front Axle		11.0101-5407.2 260011	Brake System: ATE
1.6 THP 150	110 11/11→07/15				
1.6 THP 155	115 11/11→07/15				
1.6 THP 165	121 01/12→07/15				
1.6 THP 165 Hybrid	121 06/12→07/15				
1.6 THP 200	147 11/11→07/15				
2.0 BlueHDi 150	110 07/14→07/15				
2.0 BlueHDi 180	133 08/13→07/15				
2.0 HDi 135	100 11/11→07/15				
2.0 HDi 165	120 11/11→07/15				
2.0 HDi 165 Hybrid4 4x4	120 12/11→07/15				
2.0 HDi 200 Hybrid4 All-wheel Drive	147 12/11→07/15				
1.6 HDi 115	84 06/12→07/15	Construction year from: 08/12 →; Fitting Position: Front Axle		11.0101-5407.2 260011	Brake System: ATE
Guide Bolt, brake caliper					
1.6 BlueHDi 120	88 07/14→07/15	Required quantity: 2	2	11.8171-0008.1 990049	Brake System: ATE
1.6 HDi	85 11/13→07/15				
1.6 THP 150	110 11/11→07/15				
1.6 THP 155	115 11/11→07/15				
1.6 THP 165	121 01/12→07/15				
1.6 THP 165 Hybrid	121 06/12→07/15				
1.6 THP 200	147 11/11→07/15				
2.0 BlueHDi 150	110 07/14→07/15				
2.0 BlueHDi 180	133 08/13→07/15				
2.0 HDi 135	100 11/11→07/15				
2.0 HDi 165	120 11/11→07/15				
2.0 HDi 165 Hybrid4 4x4	120 12/11→07/15				
2.0 HDi 200 Hybrid4 All-wheel Drive	147 12/11→07/15				
→					



	kW				
CITROËN - DS5 09/11→12/16					
Guide Bolt, brake caliper					
1.6 HDi 110	82	11/11→07/15	for RPO number (vehicle manufacturing date) from: 13343 →; Required quantity: 2	2	11.8171-0008.1 990049 Brake System: ATE
			Required quantity: 2	2	11.8171-0008.1 990049 Brake System: ATE
			→ for RPO number (vehicle manufacturing date) up to: 13342; Required quantity: 2	2	11.8171-0008.1 990049 Brake System: ATE
1.6 HDi 115	84	06/12→07/15	Construction year from: 08/12 →; Required quantity: 2	2	11.8171-0008.1 990049 Brake System: ATE
			for RPO number (vehicle manufacturing date) from: 13343 →; Required quantity: 2	2	11.8171-0008.1 990049 Brake System: ATE
			Construction year from: 08/12 →; → for RPO number (vehicle manufacturing date) up to: 13342; Required quantity: 2	2	11.8171-0008.1 990049 Brake System: ATE
CITROËN - EVASION MPV (22, U6) 03/94→07/02					
Guide Sleeve Kit, brake caliper					
1.8	73 - 76	02/96→07/02	+ ABS; Fitting Position: Rear Axle		11.0101-5407.2 260011 Brake System: ATE
1.9 TD	68	10/95→12/98			
2.0	89	06/94→07/02			
2.0 16V	100	05/00→07/02			
2.0 HDI	80 - 81	08/99→07/02			
2.0 HDI 16V	80	09/99→07/02			
2.1 TD	80	05/96→07/02			
1.9 TD	66	11/94→07/02	Construction year from: 02/95 →; + ABS; Fitting Position: Rear Axle	2	11.0101-5407.2 260011 Brake System: ATE
2.0 16V	97	05/98→04/00	Construction year from: 12/98 →; + ABS; Fitting Position: Rear Axle	2	11.0101-5407.2 260011 Brake System: ATE
2.0 Turbo C.T.	108	06/94→07/02	Fitting Position: Rear Axle		11.0101-5407.2 260011 Brake System: ATE
Guide Bolt, brake caliper					
1.8	73 - 76	02/96→07/02	+ ABS; Required quantity: 2	2	11.8171-0008.1 990049 Brake System: ATE
1.9 TD	68	10/95→12/98			
2.0	89	06/94→07/02			
2.0 16V	100	05/00→07/02			
2.0 HDI	80 - 81	08/99→07/02			
2.0 HDI 16V	80	09/99→07/02			
2.1 TD	80	05/96→07/02			
1.9 TD	66	11/94→07/02	Construction year from: 02/95 →; + ABS; Required quantity: 2	2	11.8171-0008.1 990049 Brake System: ATE
2.0 16V	97	05/98→04/00	Construction year from: 12/98 →; + ABS; Required quantity: 2	2	11.8171-0008.1 990049 Brake System: ATE
2.0 Turbo C.T.	108	06/94→07/02	Required quantity: 2	2	11.8171-0008.1 990049 Brake System: ATE
CITROËN - GRAND C4 SPACETOURER (3A_, 3E_) 04/18→					
Guide Sleeve Kit, brake caliper					
1.2 PureTech 130	96	04/18→	for brake disc diameter [mm]: 283 / 304; Fitting Position: Front Axle		11.0101-5407.2 260011 Brake System: ATE
1.5 BlueHDi 130	96	05/18→			
1.6 BlueHDi 100	73	04/18→			
1.6 BlueHDi 120	88	04/18→			
1.6 HDi 115	85	04/18→			
1.6 PureTech 180	133	04/18→			
1.6 THP 165	110 - 121	04/18→			
2.0 BlueHDi 150	110	04/18→			
2.0 BlueHDi 160	120	04/18→			
Guide Bolt, brake caliper					
1.2 PureTech 130	96	04/18→	for brake disc diameter [mm]: 283 / 304; Required quantity: 2;	2	11.8171-0008.1 990049 Brake System: ATE
1.5 BlueHDi 130	96	05/18→	Fitting Position: Front Axle		
1.6 BlueHDi 100	73	04/18→			
1.6 BlueHDi 120	88	04/18→			
1.6 HDi 115	85	04/18→			
1.6 PureTech 180	133	04/18→			
1.6 THP 165	110 - 121	04/18→			
2.0 BlueHDi 150	110	04/18→			
2.0 BlueHDi 160	120	04/18→			



	kW				
CITROËN - GRAND C4 SPACETOURER Van (3A_, 3E_) 04/18→					
Guide Sleeve Kit, brake caliper					
BlueHDi 130	96 05/19→	for brake disc diameter [mm]: 283 / 304;		11.0101-5407.2 260011	Brake System: ATE
BlueHDi 160	120 05/19→	Fitting Position: Front Axle			
PureTech 130	96 05/19→				
Guide Bolt, brake caliper					
BlueHDi 130	96 05/19→	for brake disc diameter [mm]: 283 / 304;	2	11.8171-0008.1 990049	Brake System: ATE
BlueHDi 160	120 05/19→	Required quantity: 2;			
PureTech 130	96 05/19→	Fitting Position: Front Axle			
CITROËN - SAXO (S0, S1) 02/96→04/04					
Guide Sleeve Kit, brake caliper					
1.4 VTS	55 05/96→06/03	Fitting Position: Front Axle		11.0101-5407.2 260011	Brake System: ATE
1.6	66 - 02/96→04/04				
	88				
VTR	65 05/96→06/03				
1.6 VTL	65 05/96→06/03				
1.6 VTS	72 09/00→09/03				
Electric	20 11/96→06/03				
1.6 VTS	87 06/96→09/03	Construction year from: 07/96 →;		11.0101-5407.2 260011	Brake System: ATE
		Fitting Position: Front Axle			
Guide Bolt, brake caliper					
1.4 VTS	55 05/96→06/03	Required quantity: 2	2	11.8171-0008.1 990049	Brake System: ATE
1.6	66 - 02/96→04/04				
	88				
VTR	65 05/96→06/03				
1.6 VTL	65 05/96→06/03				
1.6 VTS	72 09/00→09/03				
Electric	20 11/96→06/03				
1.6 VTS	87 06/96→09/03	Construction year from: 07/96 →;	2	11.8171-0008.1 990049	Brake System: ATE
		Required quantity: 2			
CITROËN - XSARA (N1) 04/97→12/05					
Guide Sleeve Kit, brake caliper					
1.4 i	55 04/97→03/05	→ Construction year to: 08/00; + ABS;		11.0101-5407.2 260011	Brake System: ATE
1.5 D	42 04/97→09/00	Fitting Position: Front Axle			
1.4 LPG	55 05/98→08/00	+ ABS; Fitting Position: Front Axle		11.0101-5407.2 260011	Brake System: ATE
1.6 i	65 04/97→09/00	→ Construction year to: 08/00;		11.0101-5407.2 260011	Brake System: ATE
1.8 D	43 04/97→09/00	Fitting Position: Front Axle			
1.8 i	66 04/97→09/00				
1.8 i Aut.	74 04/97→09/00				
1.9 D	50 - 04/97→04/05				
	52				
1.9 SD	55 01/98→09/00				
1.9 TD	66 04/97→09/00				
Guide Bolt, brake caliper					
1.4 i	55 04/97→03/05	→ Construction year to: 08/00; + ABS;	2	11.8171-0008.1 990049	Brake System: ATE
1.5 D	42 04/97→09/00	Required quantity: 2			
1.4 LPG	55 05/98→08/00	+ ABS; Required quantity: 2	2	11.8171-0008.1 990049	Brake System: ATE
1.6 i	65 04/97→09/00	→ Construction year to: 08/00;	2	11.8171-0008.1 990049	Brake System: ATE
1.8 D	43 04/97→09/00	Required quantity: 2			
1.8 i	66 04/97→09/00				
1.8 i Aut.	74 04/97→09/00				
1.9 D	50 - 04/97→04/05				
	52				
1.9 SD	55 01/98→09/00				
1.9 TD	66 04/97→09/00				
CITROËN - XSARA Break (N2) 10/97→03/10					
Guide Sleeve Kit, brake caliper					
1.4 i	55 10/97→08/05	→ Construction year to: 08/00; - ABS;		11.0101-5407.2 260011	Brake System: ATE
1.5 D	42 10/97→09/00	Fitting Position: Front Axle			
1.6 i	65 10/97→09/00				
1.8 D	43 10/97→09/00				
1.9 D	50 - 10/97→08/05				
	51				
Guide Bolt, brake caliper					
1.4 i	55 10/97→08/05	→ Construction year to: 08/00; - ABS;	2	11.8171-0008.1 990049	Brake System: ATE
1.5 D	42 10/97→09/00	Required quantity: 2			
1.6 i	65 10/97→09/00				
1.8 D	43 10/97→09/00				
1.9 D	50 - 10/97→08/05				
	51				

	kW				
CITROËN - XSARA Coupe (N0) 01/98→04/05					
Guide Sleeve Kit, brake caliper					
1.4 i	55	03/98→03/05	→ Construction year to: 08/00; + ABS; Fitting Position: Front Axle	11.0101-5407.2 260011	Brake System: ATE
1.6 i	65	02/98→09/00	→ Construction year to: 08/00; Fitting Position: Front Axle	11.0101-5407.2 260011	Brake System: ATE
1.8 i	66 - 74	02/98→09/00			
1.9 D	50 - 51	02/98→03/05			
1.9 TD	66	02/98→09/00			
1.9 D	55	02/98→05/99	Fitting Position: Front Axle	11.0101-5407.2 260011	Brake System: ATE
Guide Bolt, brake caliper					
1.4 i	55	03/98→03/05	→ Construction year to: 08/00; + ABS; Required quantity: 2	2 11.8171-0008.1 990049	Brake System: ATE
1.6 i	65	02/98→09/00	→ Construction year to: 08/00; Required quantity: 2	2 11.8171-0008.1 990049	Brake System: ATE
1.8 i	66 - 74	02/98→09/00			
1.9 D	50 - 51	02/98→03/05			
1.9 TD	66	02/98→09/00			
1.9 D	55	02/98→05/99	Required quantity: 2	2 11.8171-0008.1 990049	Brake System: ATE
CITROËN - XSARA Estate Van 05/98→08/05					
Guide Sleeve Kit, brake caliper					
1.8 D	43	05/98→05/99	- ABS; Fitting Position: Front Axle	11.0101-5407.2 260011	Brake System: ATE
1.9 D	51	06/99→08/05	→ Construction year to: 08/00; - ABS; Fitting Position: Front Axle	11.0101-5407.2 260011	Brake System: ATE
Guide Bolt, brake caliper					
1.8 D	43	05/98→05/99	- ABS; Required quantity: 2	2 11.8171-0008.1 990049	Brake System: ATE
1.9 D	51	06/99→08/05	→ Construction year to: 08/00; - ABS; Required quantity: 2	2 11.8171-0008.1 990049	Brake System: ATE
CITROËN - XSARA Hatchback Van (N3_) 05/98→03/05					
Guide Sleeve Kit, brake caliper					
1.4	55	05/98→10/04	→ Construction year to: 08/00; + ABS; Fitting Position: Front Axle	11.0101-5407.2 260011	Brake System: ATE
1.4 LPG	55	06/99→08/00	+ ABS; Fitting Position: Front Axle	11.0101-5407.2 260011	Brake System: ATE
1.8 D	43	05/98→05/99	Fitting Position: Front Axle	11.0101-5407.2 260011	Brake System: ATE
1.9 D	65	05/98→08/00			
1.9 D	51	06/99→03/05	→ Construction year to: 08/00; Fitting Position: Front Axle	11.0101-5407.2 260011	Brake System: ATE
Guide Bolt, brake caliper					
1.4	55	05/98→10/04	→ Construction year to: 08/00; + ABS; Required quantity: 2	2 11.8171-0008.1 990049	Brake System: ATE
1.4 LPG	55	06/99→08/00	+ ABS; Required quantity: 2	2 11.8171-0008.1 990049	Brake System: ATE
1.8 D	43	05/98→05/99	Required quantity: 2	2 11.8171-0008.1 990049	Brake System: ATE
1.9 D	65	05/98→08/00			
1.9 D	51	06/99→03/05	→ Construction year to: 08/00; Required quantity: 2	2 11.8171-0008.1 990049	Brake System: ATE
CUPRA - ATECA (KH7, KHP) 09/18→					
 Wheel Speed Sensor					
2.0 TSI 4Drive	221 - 257	09/18→	Fitting Position: Front Axle Left	24.0711-5273.3 360303	
			Fitting Position: Front Axle Right	24.0711-5274.3 360304	
			Fitting Position: Rear Axle Left	24.0711-5401.3 360330	
			Fitting Position: Rear Axle Right	24.0711-5402.3 360331	
Control Element, parking brake caliper					
2.0 TSI 4Drive	221 - 257	09/18→	for PR number: 1KY; Fitting Position: Rear Axle Left	11.9282-1001.3 250159	Brake System: ATE
			for PR number: 1KY; Fitting Position: Rear Axle Right	11.9282-1002.3 250160	Brake System: ATE
CUPRA - BORN (K11) 08/21→					
Warning Contact, brake pad wear					
45	110	08/21→	Required quantity: 1; Fitting Position: Front Axle	1 24.8190-0830.2 620830	
58	150	08/21→			
58 e-boost	170	08/21→			
77 e-boost	170	08/21→			
→					

	kW				
CUPRA - BORN (K11) 08/21→					
 Wheel Speed Sensor					
45	110 08/21→		Fitting Position: Front Axle Left	24.0711-5401.3 360330	
58	150 08/21→		Fitting Position: Front Axle Right	24.0711-5402.3 360331	
58 e-boost	170 08/21→		Fitting Position: Rear Axle Left	24.0711-5401.3 360330	
77 e-boost	170 08/21→		Fitting Position: Rear Axle Right	24.0711-5402.3 360331	
CUPRA - FORMENTOR (KM7) 07/20→					
 Brake Caliper					
1.4 e-Hybrid	110 - 01/21→ 150		for PR number: 1ZK; Fitting Position: Front Axle Left	24.3571-1801.5 241387	Supplementary Article/Supplementary Info: without holder Brake Caliper Type: Fist-type Caliper
1.5 TSI	110 11/20→				
2.0 TDI	110 03/21→				
2.0 TDI 4Drive	110 03/21→				
2.0 TSI	180 03/21→		for PR number: 1ZK; Fitting Position: Front Axle Right	24.3571-1802.5 241388	Supplementary Article/Supplementary Info: without holder Brake Caliper Type: Fist-type Caliper
2.0 TSI 4Drive	140 - 07/20→ 228				
2.5 VZ5 4Drive	287 10/21→				
VZ 1.4 e-Hybrid	180 02/21→				
 Brake Disc					
1.4 e-Hybrid	110 - 01/21→ 150		for PR number: 1ZK; Fitting Position: Front Axle	24.0125-0158.1 425158	Outer diameter [mm]: 312 Brake Disc Thickness [mm] 25 Minimum thickness [mm] 22 Brake Disc Type: Vented Supplementary Article/Info 2: with bolts/screws
1.5 TSI	110 11/20→				
2.0 TDI	110 03/21→				
2.0 TDI 4Drive	110 03/21→				
2.0 TSI	180 03/21→				
2.0 TSI 4Drive	140 - 07/20→ 228		for PR number: 1KE; Fitting Position: Rear Axle	24.0110-0356.1 410356	Outer diameter [mm]: 272 Brake Disc Thickness [mm] 9.7 Minimum thickness [mm] 8 Brake Disc Type: Solid Supplementary Article/Info 2: with bolts/screws
2.5 VZ5 4Drive	287 10/21→				
VZ 1.4 e-Hybrid	180 02/21→				
 Wheel Speed Sensor					
1.4 e-Hybrid	110 - 01/21→ 150		Fitting Position: Front Axle Left	24.0711-5273.3 360303	
1.5 TSI	110 11/20→		Fitting Position: Front Axle Right	24.0711-5274.3 360304	
2.0 TDI	110 03/21→				
2.0 TSI	180 03/21→				
VZ 1.4 e-Hybrid	180 02/21→				
2.0 TDI 4Drive	110 03/21→		Fitting Position: Front Axle Left	24.0711-5273.3 360303	
2.0 TSI 4Drive	140 - 07/20→ 228		Fitting Position: Front Axle Right	24.0711-5274.3 360304	
2.5 VZ5 4Drive	287 10/21→		Fitting Position: Rear Axle Left	24.0711-5401.3 360330	
			Fitting Position: Rear Axle Right	24.0711-5402.3 360331	
CUPRA - LEON (KL1) 09/20→					
 Brake Caliper					
1.4 e-HYBRID	110 - 09/20→ 150		for PR number: 1ZK; Fitting Position: Front Axle Left	24.3571-1801.5 241387	Supplementary Article/Supplementary Info: without holder Brake Caliper Type: Fist-type Caliper
2.0 TSI	180 - 06/21→ 221				
VZ 1.4 e-HYBRID	180 09/20→		for PR number: 1ZK; Fitting Position: Front Axle Right	24.3571-1802.5 241388	Supplementary Article/Supplementary Info: without holder Brake Caliper Type: Fist-type Caliper
 Brake Disc					
1.4 e-HYBRID	110 - 09/20→ 150		for PR number: 1ZE; Fitting Position: Front Axle	24.0125-0145.1 425145	Outer diameter [mm]: 288 Brake Disc Thickness [mm] 25 Minimum thickness [mm] 22 Brake Disc Type: Vented Supplementary Article/Info 2: with bolts/screws
2.0 TSI	180 - 06/21→ 221				
VZ 1.4 e-HYBRID	180 09/20→				
			for PR number: 1ZK; Fitting Position: Front Axle	24.0125-0158.1 425158	Outer diameter [mm]: 312 Brake Disc Thickness [mm] 25 Minimum thickness [mm] 22 Brake Disc Type: Vented Supplementary Article/Info 2: with bolts/screws
			for PR number: 1KE; Fitting Position: Rear Axle	24.0110-0356.1 410356	Outer diameter [mm]: 272 Brake Disc Thickness [mm] 9.7 Minimum thickness [mm] 8 Brake Disc Type: Solid Supplementary Article/Info 2: with bolts/screws

	kW				
CUPRA - LEON (KL1) 09/20→					
 Wheel Speed Sensor					
1.4 e-HYBRID	110 - 09/20→ 150		Fitting Position: Front Axle Left	24.0711-5273.3	360303
2.0 TSI	180 - 06/21→ 221		Fitting Position: Front Axle Right	24.0711-5274.3	360304
VZ 1.4 e-HYBRID	180 09/20→		Required quantity: 2; Fitting Position: Rear Axle	2	24.0711-6337.3 360390
CUPRA - LEON Sportstourer (KL8) 09/20→					
 Brake Caliper					
1.4 e-HYBRID	110 - 09/20→ 150		for PR number: 1ZK; Fitting Position: Front Axle Left	24.3571-1801.5	241387
2.0 TSI	180 - 06/21→ 221				Supplementary Article/Supplementary Info: without holder Brake Caliper Type: Fist-type Caliper
2.0 TSI 4Drive VZ 1.4 e-HYBRID	228 06/21→ 180 09/20→		for PR number: 1ZK; Fitting Position: Front Axle Right	24.3571-1802.5	241388
					Supplementary Article/Supplementary Info: without holder Brake Caliper Type: Fist-type Caliper
 Brake Disc					
1.4 e-HYBRID	110 - 09/20→ 150		for PR number: 1ZE; Fitting Position: Front Axle	24.0125-0145.1	425145
2.0 TSI	180 - 06/21→ 221				Outer diameter [mm]: 288 Brake Disc Thickness [mm] 25 Minimum thickness [mm] 22 Brake Disc Type: Vented Supplementary Article/Info 2: with bolts/screws
2.0 TSI 4Drive VZ 1.4 e-HYBRID	228 06/21→ 180 09/20→		for PR number: 1ZK; Fitting Position: Front Axle	24.0125-0158.1	425158
					Outer diameter [mm]: 312 Brake Disc Thickness [mm] 25 Minimum thickness [mm] 22 Brake Disc Type: Vented Supplementary Article/Info 2: with bolts/screws
			for PR number: 1KE; Fitting Position: Rear Axle	24.0110-0356.1	410356
					Outer diameter [mm]: 272 Brake Disc Thickness [mm] 9.7 Minimum thickness [mm] 8 Brake Disc Type: Solid Supplementary Article/Info 2: with bolts/screws
 Wheel Speed Sensor					
1.4 e-HYBRID	110 - 09/20→ 150		Fitting Position: Front Axle Left	24.0711-5273.3	360303
2.0 TSI	180 - 06/21→ 221		Fitting Position: Front Axle Right	24.0711-5274.3	360304
VZ 1.4 e-HYBRID	180 09/20→		Required quantity: 2; Fitting Position: Rear Axle	2	24.0711-6337.3 360390
2.0 TSI 4Drive	228 06/21→		Fitting Position: Front Axle Left	24.0711-5273.3	360303
			Fitting Position: Front Axle Right	24.0711-5274.3	360304
			Fitting Position: Rear Axle Left	24.0711-5401.3	360330
			Fitting Position: Rear Axle Right	24.0711-5402.3	360331
				24.0711-5401.3	360330
				24.0711-5402.3	360331
DACIA - DOKKER Express Box Body/MPV 11/12→					
Spring, brake caliper					
1.2 TCe 115	84 - 12/12→ 85		Required quantity: 2; Fitting Position: Front Axle	2	11.8116-0356.1 390586
1.3 TCe 100	75 08/19→				Brake System: ATE
1.3 TCe 130	96 08/19→				
1.5 Blue dCi 95	70 06/19→		Equipment Code: CHANOR / ENPC01; Required quantity: 2; Fitting Position: Front Axle	2	11.8116-0356.1 390586
			Equipment Code: CHAAUG; Required quantity: 2; Fitting Position: Front Axle	2	11.8116-0356.1 390586
1.5 dCi	62 - 11/12→ 66		+ ESP; Required quantity: 2; Fitting Position: Front Axle	2	11.8116-0356.1 390586
1.5 dCi 75 / Blue dCi 75	55 12/12→				Brake System: ATE
1.6	61 - 12/12→ 75		- ESP; Required quantity: 2; Payload: for increased payload; Fitting Position: Front Axle	2	11.8116-0356.1 390586
1.6 LPG	61 - 11/13→ 75				
1.6 LPG	80 08/18→		Equipment Code: CHANOR / ENPC01 / CHAAUG; Required quantity: 2; Fitting Position: Front Axle	2	11.8116-0356.1 390586
→					



	kW				
DACIA - DOKKER Express Box Body/MPV 11/12→					
 Brake Disc					
1.5 Blue dCi 95	70 06/19→	Equipment Code: CHANOR / ENPA01 / ENPB01 / ENPH01; Fitting Position: Front Axle		24.0122-0270.1 422270	Outer diameter [mm]: 258 Brake Disc Thickness [mm] 22 Minimum thickness [mm] 19.8 Brake Disc Type: Vented Supplementary Article/Info 2: with bolts/screws
1.5 dCi	62 - 11/12→ 66	- ESP; Payload: not for increased payload; Fitting Position: Front Axle		24.0122-0270.1 422270	Outer diameter [mm]: 258 Brake Disc Thickness [mm] 22 Minimum thickness [mm] 19.8 Brake Disc Type: Vented Supplementary Article/Info 2: with bolts/screws
1.5 dCi 75 / Blue dCi 75	55 12/12→				
1.6	61 - 12/12→ 75				
1.6 LPG	61 - 11/13→ 75				
1.6 LPG	80 08/18→	Equipment Code: CHANOR; Fitting Position: Front Axle		24.0122-0270.1 422270	Outer diameter [mm]: 258 Brake Disc Thickness [mm] 22 Minimum thickness [mm] 19.8 Brake Disc Type: Vented Supplementary Article/Info 2: with bolts/screws
DACIA - DOKKER MPV (KE_) 11/12→					
Spring, brake caliper					
1.2 TCe	85 11/12→	Required quantity: 2; Fitting Position: Front Axle		2 11.8116-0356.1 390586	Brake System: ATE
1.3 TCe 100	75 08/19→				
1.3 TCe 130	96 03/19→				
1.5 Blue dCi 95	70 12/18→	Equipment Code: CHANOR / ENPC01; Required quantity: 2; Fitting Position: Front Axle		2 11.8116-0356.1 390586	Brake System: ATE
		Equipment Code: CHAAUG; Required quantity: 2; Fitting Position: Front Axle		2 11.8116-0356.1 390586	Brake System: ATE
1.5 dCi / Blue dCi 75	55 11/12→	+ ESP; Required quantity: 2; Fitting Position: Front Axle		2 11.8116-0356.1 390586	Brake System: ATE
1.5 dCi	63 - 11/12→ 66				
1.6	61 - 11/12→ 75				
1.6 LPG	61 - 11/13→ 75				
1.6 LPG	80 08/18→	Equipment Code: CHANOR / ENPC01 / CHAAUG; Required quantity: 2; Fitting Position: Front Axle		2 11.8116-0356.1 390586	Brake System: ATE
 Brake Disc					
1.5 Blue dCi 95	70 12/18→	Equipment Code: CHANOR / ENPA01 / ENPB01 / ENPH01; Fitting Position: Front Axle		24.0122-0270.1 422270	Outer diameter [mm]: 258 Brake Disc Thickness [mm] 22 Minimum thickness [mm] 19.8 Brake Disc Type: Vented Supplementary Article/Info 2: with bolts/screws
1.5 dCi / Blue dCi 75	55 11/12→	- ESP; Payload: not for increased payload; Fitting Position: Front Axle		24.0122-0270.1 422270	Outer diameter [mm]: 258 Brake Disc Thickness [mm] 22 Minimum thickness [mm] 19.8 Brake Disc Type: Vented Supplementary Article/Info 2: with bolts/screws
1.5 dCi	63 - 11/12→ 66				
1.6	61 - 11/12→ 75				
1.6 LPG	61 - 11/13→ 75				
1.6 LPG	80 08/18→	Equipment Code: CHANOR; Fitting Position: Front Axle		24.0122-0270.1 422270	Outer diameter [mm]: 258 Brake Disc Thickness [mm] 22 Minimum thickness [mm] 19.8 Brake Disc Type: Vented Supplementary Article/Info 2: with bolts/screws
DACIA - DUSTER (HM_) 10/17→					
Spring, brake caliper					
1.0 LPG	74 01/19→	for brake disc diameter [mm]: 280; Required quantity: 2; Fitting Position: Front Axle		2 11.8116-0356.1 390586	Brake System: ATE
1.0 TCe 100	74 01/19→				
1.0 TCe 90	67 05/21→				
1.6 SCe 115	84 10/17→				
1.6 SCe 115 LPG	80 10/17→				
1.0 TCe 100 4x4	74 01/19→	Required quantity: 2; Fitting Position: Front Axle		2 11.8116-0356.1 390586	Brake System: ATE
1.2 TCe 125	92 10/17→				
1.2 TCe 125 4x4	92 10/17→				
1.3 TCe 130	96 01/19→				
1.3 TCe 130 4x4	96 01/19→				
1.3 TCe 150	110 01/19→				
1.3 TCe 150 4x4	110 01/19→				
1.5 dCi 110	80 10/17→				
→					



	kW				
DACIA - DUSTER (HM_) 10/17→					
Spring, brake caliper					
1.5 dCi 110 4x4	80 10/17→	Required quantity: 2; Fitting Position: Front Axle	2	11.8116-0356.1 390586	Brake System: ATE
1.5 dCi 115	85 10/17→				
1.5 dCi 115 4x4	84 - 10/17→				
	85				
1.5 dCi 90	66 10/17→				
1.5 dCi 95	70 10/17→				
1.6 SCe 115 4x4	84 10/17→				
2.0 16V 4x4	101 04/18→				
 Wheel Speed Sensor					
1.0 LPG	74 01/19→	Fitting Position: Rear Axle Right		24.0710-2099.3 360648	Length [mm]: 592
1.0 TCe 100	74 01/19→				
1.0 TCe 90	67 05/21→				
1.2 TCe 125	92 10/17→				
1.3 TCe 130	96 01/19→				
1.3 TCe 150	110 01/19→				
1.5 dCi 110	80 10/17→				
1.5 dCi 115	85 10/17→				
1.5 dCi 90	66 10/17→				
1.5 dCi 95	70 10/17→				
1.6 SCe 115	84 10/17→				
1.6 SCe 115 LPG	80 10/17→				
DACIA - DUSTER (HS_) 04/10→01/18					
Spring, brake caliper					
1.2 TCe 125	92 10/13→01/18	Required quantity: 2; Fitting Position: Front Axle	2	11.8116-0356.1 390586	Brake System: ATE
1.2 TCe 125 4x4	92 06/15→01/18				
1.5 dCi 4x4	66 10/10→01/18				
1.5 dCi	63 - 04/10→01/18	+ ABS; Required quantity: 2; Fitting Position: Front Axle	2	11.8116-0356.1 390586	Brake System: ATE
1.5 dCi 4x4	79				
	80 - 10/10→01/18				
	81				
1.5 dCi	80 - 08/13→01/18	Construction year from: 09/13 →; + ABS; Required quantity: 2; Fitting Position: Front Axle	2	11.8116-0356.1 390586	Brake System: ATE
	81				
1.6 16V	77 04/10→01/18	+ ESP; Required quantity: 2; Fitting Position: Front Axle	2	11.8116-0356.1 390586	Brake System: ATE
1.6 16V 4x4	77 06/10→01/18				
1.6 16V LPG	77 04/11→01/18				
1.6 SCe 115	84 06/15→01/18				
1.6 SCe 115 4x4	84 06/15→01/18				
1.6 SCe 115 LPG	84 06/15→01/18				
1.6 16V Hi-Flex	77 08/10→01/18	Construction year from: 04/11 →; + ESP; Required quantity: 2; Fitting Position: Front Axle	2	11.8116-0356.1 390586	Brake System: ATE
 Wheel Speed Sensor					
1.2 TCe 125	92 10/13→01/18	Fitting Position: Rear Axle Right		24.0710-2099.3 360648	Length [mm]: 592
1.5 dCi	63 - 04/10→01/18				
	79				
1.6 16V	77 04/10→01/18				
1.6 16V LPG	77 04/11→01/18				
1.6 SCe 115	84 06/15→01/18				
1.6 SCe 115 LPG	84 06/15→01/18				
1.5 dCi	80 - 08/13→01/18	Construction year from: 09/13 →; Fitting Position: Rear Axle Right		24.0710-2099.3 360648	Length [mm]: 592
	81				
1.6 16V Hi-Flex	77 08/10→01/18	Construction year from: 04/11 →;		24.0710-2099.3 360648	Length [mm]: 592
DACIA - DUSTER SUV Van 04/11→					
Spring, brake caliper					
1.2 TCe 125 4x4	92 10/13→	Construction year from: 06/15 →; Required quantity: 2; Fitting Position: Front Axle	2	11.8116-0356.1 390586	Brake System: ATE
1.5 dCi	66 04/11→	+ ABS; Required quantity: 2; Fitting Position: Front Axle	2	11.8116-0356.1 390586	Brake System: ATE
1.5 dCi	80 04/13→	Construction year from: 09/13 →; + ABS; Required quantity: 2; Fitting Position: Front Axle	2	11.8116-0356.1 390586	Brake System: ATE
1.5 dCi 4x4	66 04/11→	Required quantity: 2; Fitting Position: Front Axle	2	11.8116-0356.1 390586	Brake System: ATE
1.5 dCi 4x4	80 04/13→	Construction year from: 08/13 →; + ABS; Required quantity: 2; Fitting Position: Front Axle	2	11.8116-0356.1 390586	Brake System: ATE
1.6 16V	77 04/11→	+ ESP; Required quantity: 2; Fitting Position: Front Axle	2	11.8116-0356.1 390586	Brake System: ATE
1.6 16V 4x4	77 04/11→				
1.6 16V Hi-Flex	77 04/11→				
1.6 SCe 115	84 06/15→				
1.6 SCe 115 4x4	84 06/15→01/18				
→					



	kW				
DACIA - SANDERO II 10/12→					
Guide Bolt, brake caliper					
1.2 LPG	55 10/12→	Fitting Position: Front Axle		11.8171-0008.1 990049	Brake System: ATE
1.5 Blue dCi 95	70 08/18→				
1.5 dCi	63 - 10/12→				
	66				
1.5 dCi 75 / Blue dCi 75	55 10/12→				
1.6	63 11/12→				
TCe 90	66 10/12→				
TCe 90 LPG	66 09/15→				
DACIA - SANDERO III 01/21→					
Spring, brake caliper					
1.0 TCe 100	74 01/21→	Country-spec. model: Turkey;	2	11.8116-0356.1 390586	Brake System: ATE
1.0 TCe 100 ECO-G	74 01/21→	Required quantity: 2;			
1.0 TCe 90	67 01/21→	Fitting Position: Front Axle			
1.0 TCe 90 ECO-G	67 01/21→				
Guide Bolt, brake caliper					
1.0 TCe 100	74 01/21→	Country-spec. model: Turkey;		11.8171-0008.1 990049	Brake System: ATE
1.0 TCe 100 ECO-G	74 01/21→	Fitting Position: Front Axle			
1.0 TCe 90	67 01/21→				
1.0 TCe 90 ECO-G	67 01/21→				
DAEWOO - ESPERO (KLEJ) 10/91→09/99					
Guide Sleeve Kit, brake caliper					
1.5	55 10/97→08/99	→ Construction year to: 06/99;		11.0101-5407.2 260011	Brake System: ATE
1.8	66 02/95→09/99	Fitting Position: Front Axle			
1.5 16V	66 02/95→06/99	Fitting Position: Front Axle		11.0101-5407.2 260011	Brake System: ATE
1.8	70 02/95→06/99				
2.0	77 02/95→06/99				
Guide Bolt, brake caliper					
1.5	55 10/97→08/99	→ Construction year to: 06/99;	2	11.8171-0008.1 990049	Brake System: ATE
1.8	66 02/95→09/99	Required quantity: 2			
1.5 16V	66 02/95→06/99	Required quantity: 2	2	11.8171-0008.1 990049	Brake System: ATE
1.8	70 02/95→06/99				
2.0	77 02/95→06/99				
DAEWOO - LANOS (KLAT) 04/97→					
Guide Sleeve Kit, brake caliper					
1.3	55 05/97→	→ Vehicle Identification Number to:		11.0101-5407.2 260011	Brake System: ATE
1.5	63 - 05/97→	447433; Fitting Position: Front Axle			
	73				
1.6 16V	78 05/97→				
Guide Bolt, brake caliper					
1.3	55 05/97→	→ Vehicle Identification Number to:	2	11.8171-0008.1 990049	Brake System: ATE
1.5	63 - 05/97→	447433; Required quantity: 2;			
	73	Fitting Position: Front Axle			
1.6 16V	78 05/97→	→ Vehicle Identification Number to:	2	11.8171-0008.1 990049	Brake System: ATE
		447433; Required quantity: 2			
DAEWOO - LANOS Saloon (KLAT) 02/97→					
Guide Sleeve Kit, brake caliper					
1.3	55 05/97→	→ Vehicle Identification Number to:		11.0101-5407.2 260011	Brake System: ATE
1.5	63 - 05/97→	447433; Fitting Position: Front Axle			
	73				
1.6 16V	78 02/97→	Construction year from: 05/97 →;		11.0101-5407.2 260011	Brake System: ATE
		→ Vehicle Identification Number to:			
		447433; Fitting Position: Front Axle			
Guide Bolt, brake caliper					
1.3	55 05/97→	→ Vehicle Identification Number to:	2	11.8171-0008.1 990049	Brake System: ATE
1.5	63 - 05/97→	447433; Required quantity: 2;			
	73	Fitting Position: Front Axle			
1.6 16V	78 02/97→	Construction year from: 05/97 →;	2	11.8171-0008.1 990049	Brake System: ATE
		→ Vehicle Identification Number to:			
		447433; Required quantity: 2			
DAEWOO - NEXIA 02/95→08/97					
Guide Sleeve Kit, brake caliper					
1.5	44 - 02/95→08/97	Fitting Position: Front Axle		11.0101-5407.2 260011	Brake System: ATE
	55				
1.5 16V	66 02/95→08/97				
→					





	kW							
DS - DS 4 / DS 4 CROSSBACK (NX_) 07/15→12/18								
Guide Bolt, brake caliper								
1.6 THP 160	120 07/15→12/18	Required quantity: 2; Fitting Position: Front Axle	2	11.8171-0008.1 990049	Brake System: ATE			
1.6 THP 165	121 07/15→12/18							
1.6 THP 210	155 07/15→12/18							
2.0 BlueHDi 150	110 07/15→12/18							
2.0 BlueHDi 180	133 07/15→12/18	not for rim size [in]: 19; Required quantity: 2; Fitting Position: Front Axle	2	11.8171-0008.1 990049	Brake System: ATE			
		Rim Size [in]: 19; Required quantity: 2; Fitting Position: Front Axle	2	11.8171-0008.1 990049	Brake System: ATE			
DS - DS 5 (KF_) 04/15→12/18								
Spring, brake caliper								
1.6 BlueHDi 115	85 06/15→12/18	Required quantity: 2; Hub Diameter [mm]: 82; Fitting Position: Front Axle	2	11.8116-0356.1 390586	Brake System: ATE			
1.6 BlueHDi 120	88 06/15→12/18							
1.6 THP 165	121 07/15→12/18							
1.6 THP 210	155 04/15→12/18							
2.0 BlueHDi 135	100 06/15→12/18							
2.0 BlueHDi 150	110 04/15→12/18							
2.0 BlueHDi 180	133 04/15→12/18							
2.0 Hybrid4	147 04/15→12/18							
2.0 Hybrid4 4x4	120 04/15→12/18							
Guide Sleeve Kit, brake caliper								
1.6 THP 165	121 07/15→12/18	Hub Diameter [mm]: 83; Fitting Position: Front Axle	11.0101-5407.2 260011	Brake System: ATE				
1.6 THP 210	155 04/15→12/18							
2.0 BlueHDi 135	100 06/15→12/18							
2.0 BlueHDi 150	110 04/15→12/18							
2.0 BlueHDi 180	133 04/15→12/18							
2.0 Hybrid4	147 04/15→12/18							
2.0 Hybrid4 4x4	120 04/15→12/18							
Guide Bolt, brake caliper								
1.6 BlueHDi 115	85 06/15→12/18	Required quantity: 2; Fitting Position: Front Axle	2	11.8171-0008.1 990049	Brake System: ATE			
1.6 BlueHDi 120	88 06/15→12/18							
1.6 THP 165	121 07/15→12/18							
1.6 THP 210	155 04/15→12/18							
2.0 BlueHDi 135	100 06/15→12/18							
2.0 BlueHDi 150	110 04/15→12/18							
2.0 BlueHDi 180	133 04/15→12/18							
2.0 Hybrid4	147 04/15→12/18							
2.0 Hybrid4 4x4	120 04/15→12/18							
DS - DS 7 Crossback (J_) 09/17→								
Guide Sleeve Kit, brake caliper								
1.5 BlueHDi 130	96 09/17→	for brake disc diameter [mm]: 304; → for RPO number (vehicle manufacturing date) up to: 16246; Fitting Position: Front Axle	11.0101-5407.2 260011	Brake System: ATE				
1.6 PureTech 165	121 07/18→							
1.6 PureTech 180	133 04/18→							
1.6 PureTech 225	165 09/17→							
2.0 BlueHDi 180	130 09/17→							
2.0 HDi 180	132 07/18→							
E-TENSE	133 - 10/19→ 147							
E-TENSE 225	133 - 05/21→ 165							
E-TENSE 4x4	147 - 05/19→ 221							
PureTech 130	96 10/18→							
Guide Bolt, brake caliper								
1.5 BlueHDi 130	96 09/17→				for brake disc diameter [mm]: 304; → for RPO number (vehicle manufacturing date) up to: 16246; Fitting Position: Front Axle	11.8171-0008.1 990049	Brake System: ATE	
1.6 PureTech 165	121 07/18→							
1.6 PureTech 180	133 04/18→							
1.6 PureTech 225	165 09/17→							
2.0 BlueHDi 180	130 09/17→							
2.0 HDi 180	132 07/18→							
E-TENSE	133 - 10/19→ 147							
E-TENSE 225	133 - 05/21→ 165							
E-TENSE 4x4	147 - 05/19→ 221							
PureTech 130	96 10/18→							
FERRARI - 208/308 Coupe 09/74→10/89								
Guide Sleeve Kit, brake caliper								
308 GTB Qv	177 09/82→06/85	Fitting Position: Front Axle	11.0101-5407.2 260011	Brake System: ATE				
308 GTS Qv	177 09/82→06/85	Fitting Position: Rear Axle	11.0101-5407.2 260011	Brake System: ATE				
→								



	kw				
FERRARI - 208/308 Coupe 09/74→10/89					
Guide Bolt, brake caliper					
308 GTB Qv	177	09/82→06/85	Required quantity: 2; Fitting Position: Front Axle	2	11.8171-0008.1 990049 Brake System: ATE
308 GTS Qv	177	09/82→06/85	Required quantity: 2; Fitting Position: Rear Axle	2	11.8171-0008.1 990049 Brake System: ATE
FERRARI - 328 GTB 09/85→09/89					
Guide Sleeve Kit, brake caliper					
3.2	199	09/85→09/89	→ Construction year to: 08/89; Fitting Position: Front Axle		11.0101-5407.2 260011 Brake System: ATE
			→ Construction year to: 08/89; Fitting Position: Rear Axle		11.0101-5407.2 260011 Brake System: ATE
Guide Bolt, brake caliper					
3.2	199	09/85→09/89	→ Construction year to: 08/89; Required quantity: 2; Fitting Position: Front Axle	2	11.8171-0008.1 990049 Brake System: ATE
			→ Construction year to: 08/89; Required quantity: 2; Fitting Position: Rear Axle	2	11.8171-0008.1 990049 Brake System: ATE
FERRARI - 328 GTS 09/85→09/89					
Guide Sleeve Kit, brake caliper					
3.2	199	09/85→09/89	→ Construction year to: 08/89; Fitting Position: Front Axle		11.0101-5407.2 260011 Brake System: ATE
			→ Construction year to: 08/89; Fitting Position: Rear Axle		11.0101-5407.2 260011 Brake System: ATE
Guide Bolt, brake caliper					
3.2	199	09/85→09/89	→ Construction year to: 08/89; Required quantity: 2; Fitting Position: Front Axle	2	11.8171-0008.1 990049 Brake System: ATE
			→ Construction year to: 08/89; Required quantity: 2; Fitting Position: Rear Axle	2	11.8171-0008.1 990049 Brake System: ATE
FERRARI - MONDIAL 07/80→12/93					
Guide Sleeve Kit, brake caliper					
3.2 Quattrovalvole	199	10/85→12/88	Fitting Position: Front Axle		11.0101-5407.2 260011 Brake System: ATE
8 Quattrovalvole	177	10/82→07/87	Fitting Position: Rear Axle		11.0101-5407.2 260011 Brake System: ATE
8	158	07/80→09/83	Construction year from: 04/81 →; Fitting Position: Front Axle		11.0101-5407.2 260011 Brake System: ATE
			Construction year from: 04/81 →; Fitting Position: Rear Axle		11.0101-5407.2 260011 Brake System: ATE
Guide Bolt, brake caliper					
3.2 Quattrovalvole	199	10/85→12/88	Required quantity: 2; Fitting Position: Front Axle	2	11.8171-0008.1 990049 Brake System: ATE
8 Quattrovalvole	177	10/82→07/87	Required quantity: 2; Fitting Position: Rear Axle	2	11.8171-0008.1 990049 Brake System: ATE
8	158	07/80→09/83	Construction year from: 04/81 →; Required quantity: 2; Fitting Position: Front Axle	2	11.8171-0008.1 990049 Brake System: ATE
			Construction year from: 04/81 →; Required quantity: 2; Fitting Position: Rear Axle	2	11.8171-0008.1 990049 Brake System: ATE
FERRARI - MONDIAL Convertible 03/83→12/93					
Guide Sleeve Kit, brake caliper					
3.2 Quattrovalvole	199	09/85→12/88	Fitting Position: Front Axle		11.0101-5407.2 260011 Brake System: ATE
3.4 T	221	01/89→12/93	Fitting Position: Rear Axle		11.0101-5407.2 260011 Brake System: ATE
8 Quattrovalvole	177	03/84→07/87			
Guide Bolt, brake caliper					
3.2 Quattrovalvole	199	09/85→12/88	Required quantity: 2; Fitting Position: Front Axle	2	11.8171-0008.1 990049 Brake System: ATE
3.4 T	221	01/89→12/93	Required quantity: 2; Fitting Position: Rear Axle	2	11.8171-0008.1 990049 Brake System: ATE
8 Quattrovalvole	177	03/84→07/87			

	kW				
FIAT - 500 (312_) 07/07→					
 Brake Caliper					
1.3 D Multijet	55 10/07→	Fitting Position: Front Axle Left		24.3481-1823.5 241477	Brake System: Bosch Supplementary Article/Supplementary Info: without holder Brake Caliper Type: Fist-type Caliper
		Fitting Position: Front Axle Right		24.3481-1824.5 241478	Brake System: Bosch Supplementary Article/Supplementary Info: without holder Brake Caliper Type: Fist-type Caliper
Guide Bolt, brake caliper					
0.9	44 - 07/10→ 63	Required quantity: 2	2	11.8171-0008.1 990049	Brake System: ATE
1.0 Mild Hybrid	51 01/20→	Required quantity: 2; Fitting Position: Front Axle	2	11.8171-0008.1 990049	Brake System: ATE
FIAT - 500 C (312_) 09/09→					
 Brake Caliper					
1.2	51 09/09→	→ Construction year to: 05/15; Fitting Position: Front Axle Left		24.3481-1823.5 241477	Brake System: Bosch Supplementary Article/Supplementary Info: without holder Brake Caliper Type: Fist-type Caliper
		→ Construction year to: 05/15; Fitting Position: Front Axle Right		24.3481-1824.5 241478	Brake System: Bosch Supplementary Article/Supplementary Info: without holder Brake Caliper Type: Fist-type Caliper
1.3 D Multijet	55 09/09→	Fitting Position: Front Axle Left		24.3481-1823.5 241477	Brake System: Bosch Supplementary Article/Supplementary Info: without holder Brake Caliper Type: Fist-type Caliper
		Fitting Position: Front Axle Right		24.3481-1824.5 241478	Brake System: Bosch Supplementary Article/Supplementary Info: without holder Brake Caliper Type: Fist-type Caliper
Guide Bolt, brake caliper					
0.9	44 - 09/09→ 63	Required quantity: 2	2	11.8171-0008.1 990049	Brake System: ATE
1.0 Mild Hybrid	51 01/20→	Required quantity: 2; Fitting Position: Front Axle	2	11.8171-0008.1 990049	Brake System: ATE
FIAT - 500e (332_) 10/20→					
Guide Bolt, brake caliper					
Elektro Elektro 3+1	70 10/20→ 87 10/20→	Required quantity: 2; Fitting Position: Front Axle	2	11.8171-0008.1 990049	Brake System: ATE
FIAT - 500e Convertible (332_) 10/20→					
Guide Bolt, brake caliper					
Elektro	70 - 10/20→ 87	Required quantity: 2; Fitting Position: Front Axle	2	11.8171-0008.1 990049	Brake System: ATE
FIAT - 500L (351_, 352_) 09/12→					
Guide Bolt, brake caliper					
1.4	88 - 09/13→ 119	Construction year from: 01/14 →; Required quantity: 2	2	11.8171-0008.1 990049	Brake System: ATE
1.4 LPG 1.6 D Multijet	88 02/14→ 88 09/13→	Required quantity: 2	2	11.8171-0008.1 990049	Brake System: ATE
FIAT - 500X (334_) 09/14→					
Guide Bolt, brake caliper					
1.3 D Multijet 1.4 1.4 LPG 1.6 D Multijet	70 11/14→ 100 - 09/14→ 103 88 03/17→09/18 84 - 09/14→ 88	Required quantity: 2	2	11.8171-0008.1 990049	Brake System: ATE

	kW				
FIAT - CROMA (194_) 06/05→					
Spring, brake caliper					
1.8 16V 1.9 D Multijet	103 12/05→ 85 - 06/05→ 88	Construction year from: 03/06 → → Construction year to: 11/10; Required quantity: 2; Fitting Position: Front Axle	2	11.8116-0356.1 390586	Brake System: ATE
2.2 16V 1.9 D Multijet	108 06/05→ 100 - 06/05→ 110	Vehicle Identification Number from: 2060169 →; → Construction year to: 11/10; Required quantity: 2; Fitting Position: Front Axle	2	11.8116-0356.1 390586	Brake System: ATE
Guide Bolt, brake caliper					
1.8 16V	103 12/05→	Construction year from: 01/06 → → Construction year to: 02/06; Required quantity: 2	2	11.8171-0008.1 990049	Brake System: ATE
1.9 D Multijet 2.2 16V	85 - 06/05→ 88 108 06/05→	→ Construction year to: 02/06; Required quantity: 2	2	11.8171-0008.1 990049	Brake System: ATE
FIAT - CROMA Estate Van (194_) 04/06→12/11					
Spring, brake caliper					
1.9 MJTD	88 04/06→12/11	→ Construction year to: 11/10; Required quantity: 2; Fitting Position: Front Axle	2	11.8116-0356.1 390586	Brake System: ATE
FIAT - DOBLO Bus (263_) 11/09→					
 Brake Master Cylinder					
1.3 D Multijet 1.4 1.4 Natural Power 1.6 D Multijet	66 - 02/10→ 70 70 - 02/10→ 88 88 02/10→ 66 - 02/10→ 88	Left-/right-hand drive vehicles: for right-hand drive vehicles; + ESP		24.4123-1731.3 011094	Diameter [mm]: 23.8 Supplementary Article/Info 2: without brake fluid reservoir
1.6 D Multijet 2.0 D Multijet	77 01/10→ 99 01/10→	Construction year from: 02/10 → ; Left-/right-hand drive vehicles: for right-hand drive vehicles; + ESP		24.4123-1731.3 011094	Diameter [mm]: 23.8 Supplementary Article/Info 2: without brake fluid reservoir
Guide Bolt, brake caliper					
1.3 D Multijet 1.4 1.4 Natural Power 1.6 D Multijet 2.0 D Multijet	66 - 02/10→ 70 70 - 02/10→ 88 88 02/10→ 66 - 01/10→ 88 99 01/10→	for brake disc diameter [mm]: 305; Required quantity: 2	2	11.8171-0008.1 990049	Brake System: ATE
FIAT - DOBLO Cargo (263_) 02/10→					
 Brake Master Cylinder					
1.3 D Multijet 1.4 1.4 Natural Power 1.6 D Multijet 2.0 D Multijet	55 - 02/10→ 70 70 - 02/10→ 88 88 06/10→ 66 - 02/10→ 88 99 02/10→	Left-/right-hand drive vehicles: for right-hand drive vehicles; + ESP		24.4123-1731.3 011094	Diameter [mm]: 23.8 Supplementary Article/Info 2: without brake fluid reservoir
Guide Bolt, brake caliper					
1.3 D Multijet 1.4 1.4 Natural Power 1.6 D Multijet 2.0 D Multijet	55 - 02/10→ 70 70 - 02/10→ 88 88 06/10→ 66 - 02/10→ 88 99 02/10→	for brake disc diameter [mm]: 305; Required quantity: 2	2	11.8171-0008.1 990049	Brake System: ATE
FIAT - DOBLO Platform/Chassis (263_) 02/10→					
 Brake Master Cylinder					
1.3 D Multijet 1.4 1.4 Natural Power 1.6 D Multijet →	55 - 02/10→ 70 70 - 04/10→ 88 88 06/10→ 66 - 02/10→ 88	Left-/right-hand drive vehicles: for right-hand drive vehicles; + ESP		24.4123-1731.3 011094	Diameter [mm]: 23.8 Supplementary Article/Info 2: without brake fluid reservoir

	kW				
FIAT - DOBLO Platform/Chassis (263_) 02/10→					
 Brake Master Cylinder					
2.0 D Multijet	99 02/10→	Left-/right-hand drive vehicles: for right-hand drive vehicles; + ESP		24.4123-1731.3 011094	Diameter [mm]: 23.8 Supplementary Article/Info 2: without brake fluid reservoir
Guide Bolt, brake caliper					
1.3 D Multijet	55 - 02/10→	for brake disc diameter [mm]: 305; Required quantity: 2	2	11.8171-0008.1 990049	Brake System: ATE
1.4	70 - 04/10→				
1.4 Natural Power	88 06/10→				
1.6 D Multijet	66 - 02/10→				
	88				
2.0 D Multijet	99 02/10→				
FIAT - PANDA (169_) 09/03→					
 Brake Caliper					
1.2 4x4	44 10/04→	→ Construction year to: 06/13; Fitting Position: Front Axle Left		24.3481-1823.5 241477	Brake System: Bosch Supplementary Article/Supplementary Info: without holder Brake Caliper Type: Fist-type Caliper
1.2 LPG	44 - 04/09→				
1.3 D Multijet	51 09/03→				
	55				
1.4 Natural Power	57 09/10→08/13	→ Construction year to: 06/13; Fitting Position: Front Axle Right		24.3481-1824.5 241478	Brake System: Bosch Supplementary Article/Supplementary Info: without holder Brake Caliper Type: Fist-type Caliper
1.2 4x4	51 04/10→08/13	Construction year from: 10/10 → → Construction year to: 06/13; Fitting Position: Front Axle Left		24.3481-1823.5 241477	Brake System: Bosch Supplementary Article/Supplementary Info: without holder Brake Caliper Type: Fist-type Caliper
		Construction year from: 10/10 → → Construction year to: 06/13; Fitting Position: Front Axle Right		24.3481-1824.5 241478	Brake System: Bosch Supplementary Article/Supplementary Info: without holder Brake Caliper Type: Fist-type Caliper
1.2 Natural Power	44 01/07→12/11	Fitting Position: Front Axle Left		24.3481-1823.5 241477	Brake System: Bosch Supplementary Article/Supplementary Info: without holder Brake Caliper Type: Fist-type Caliper
		Fitting Position: Front Axle Right		24.3481-1824.5 241478	Brake System: Bosch Supplementary Article/Supplementary Info: without holder Brake Caliper Type: Fist-type Caliper
FIAT - PANDA (312_, 319_) 02/12→					
Guide Bolt, brake caliper					
0.9	44 - 02/12→	Required quantity: 2	2	11.8171-0008.1 990049	Brake System: ATE
	48				
1.2	51 02/12→				
1.2 LPG	51 06/12→				
1.0 Mild Hybrid	51 01/20→	Required quantity: 2; Fitting Position: Front Axle	2	11.8171-0008.1 990049	Brake System: ATE
FIAT - PANDA Hatchback Van (169_) 03/04→					
 Brake Caliper					
1.2 4x4	44 09/04→	Construction year from: 10/04 → → Construction year to: 06/13; Fitting Position: Front Axle Left		24.3481-1823.5 241477	Brake System: Bosch Supplementary Article/Supplementary Info: without holder Brake Caliper Type: Fist-type Caliper
		Construction year from: 10/04 → → Construction year to: 06/13; Fitting Position: Front Axle Right		24.3481-1824.5 241478	Brake System: Bosch Supplementary Article/Supplementary Info: without holder Brake Caliper Type: Fist-type Caliper
1.2 4x4	51 09/10→	Construction year from: 10/10 → → Construction year to: 06/13; Fitting Position: Front Axle Left		24.3481-1823.5 241477	Brake System: Bosch Supplementary Article/Supplementary Info: without holder Brake Caliper Type: Fist-type Caliper
→					

	kW				
FIAT - PANDA Hatchback Van (169_) 03/04→					
 Brake Caliper					
1.2 4x4	51 09/10→	Construction year from: 10/10 → → Construction year to: 06/13; Fitting Position: Front Axle Right		24.3481-1824.5 241478	Brake System: Bosch Supplementary Article/Supplementary Info: without holder Brake Caliper Type: Fist-type Caliper
1.2 LPG 1.3 D Multijet 1.4 Natural Power	44 04/09→ 51 03/04→ 57 10/09→	→ Construction year to: 06/13; Fitting Position: Front Axle Left		24.3481-1823.5 241477	Brake System: Bosch Supplementary Article/Supplementary Info: without holder Brake Caliper Type: Fist-type Caliper
		→ Construction year to: 06/13; Fitting Position: Front Axle Right		24.3481-1824.5 241478	Brake System: Bosch Supplementary Article/Supplementary Info: without holder Brake Caliper Type: Fist-type Caliper
1.2 LPG	51 09/10→	Construction year from: 11/10 → → Construction year to: 06/13; Fitting Position: Front Axle Left		24.3481-1823.5 241477	Brake System: Bosch Supplementary Article/Supplementary Info: without holder Brake Caliper Type: Fist-type Caliper
		Construction year from: 11/10 → → Construction year to: 06/13; Fitting Position: Front Axle Right		24.3481-1824.5 241478	Brake System: Bosch Supplementary Article/Supplementary Info: without holder Brake Caliper Type: Fist-type Caliper
1.2 Natural Power	44 01/07→11/09	Fitting Position: Front Axle Left		24.3481-1823.5 241477	Brake System: Bosch Supplementary Article/Supplementary Info: without holder Brake Caliper Type: Fist-type Caliper
		Fitting Position: Front Axle Right		24.3481-1824.5 241478	Brake System: Bosch Supplementary Article/Supplementary Info: without holder Brake Caliper Type: Fist-type Caliper
1.3 D Multijet	55 01/06→	Construction year from: 06/06 → → Construction year to: 06/13; Fitting Position: Front Axle Left		24.3481-1823.5 241477	Brake System: Bosch Supplementary Article/Supplementary Info: without holder Brake Caliper Type: Fist-type Caliper
		Construction year from: 06/06 → → Construction year to: 06/13; Fitting Position: Front Axle Right		24.3481-1824.5 241478	Brake System: Bosch Supplementary Article/Supplementary Info: without holder Brake Caliper Type: Fist-type Caliper
FIAT - PANDA VAN (312_, 519_) 02/12→					
Guide Bolt, brake caliper					
0.9 1.2 1.2 LPG	48 02/12→ 51 02/12→ 51 06/12→	Required quantity: 2	2	11.8171-0008.1 990049	Brake System: ATE
FIAT - TALENTO Bus (296_) 06/16→					
 Brake Pad Set, disc brake					
1.6 D 2.0 EcoJet	70 - 06/16→ 107 88 - 07/19→ 107	Fitting Position: Rear Axle		13.0460-2840.2 602840	Brake System: Lucas / TRW 23980 16,5 Wear Warning Contact: prepared for wear indicator / excl. wear warning contact
 Brake Disc					
1.6 D 2.0 EcoJet	70 - 06/16→ 107 88 - 07/19→ 107	Fitting Position: Front Axle		24.0128-0287.1 428287	Outer diameter [mm]: 296 Brake Disc Thickness [mm] 28 Minimum thickness [mm] 23.4 Brake Disc Type: Vented Supplementary Article/Info 2: with bolts/screws
FIAT - TALENTO Platform/Chassis (296_) 06/16→					
 Brake Pad Set, disc brake					
1.6 D 2.0 EcoJet	89 - 06/16→ 107 107 - 07/19→ 125	Fitting Position: Rear Axle		13.0460-2840.2 602840	Brake System: Lucas / TRW 23980 16,5 Wear Warning Contact: prepared for wear indicator / excl. wear warning contact
→					

	kW				
FIAT - TALENTO Platform/Chassis (296_) 06/16→					
 Brake Disc					
1.6 D	89 - 06/16→ 107	Fitting Position: Front Axle	24.0128-0287.1 428287	Outer diameter [mm]: 296 Brake Disc Thickness [mm] 28 Minimum thickness [mm] 23.4 Brake Disc Type: Vented Supplementary Article/Info 2: with bolts/screws	
2.0 EcoJet	107 - 07/19→ 125				
FIAT - TALENTO Van (296_) 06/16→					
 Brake Pad Set, disc brake					
1.6 D	70 - 06/16→ 107	Fitting Position: Rear Axle	13.0460-2840.2 602840	Brake System: Lucas / TRW 23980 16,5 Wear Warning Contact: prepared for wear indicator / excl. wear warning contact	
2.0 EcoJet	88 - 07/19→ 125				
 Brake Disc					
1.6 D	70 - 06/16→ 107	Fitting Position: Front Axle	24.0128-0287.1 428287	Outer diameter [mm]: 296 Brake Disc Thickness [mm] 28 Minimum thickness [mm] 23.4 Brake Disc Type: Vented Supplementary Article/Info 2: with bolts/screws	
2.0 EcoJet	88 - 07/19→ 125				
FIAT - ULYSSE (220_) 06/94→08/02					
Guide Sleeve Kit, brake caliper					
1.8	73 05/97→08/02	→ Construction year to: 07/02; + ABS;	11.0101-5407.2 260011	Brake System: ATE	
1.9 TD	66 02/95→08/02	Fitting Position: Rear Axle			
2.0	89 06/94→08/02				
2.0 JTD	80 10/99→08/02				
1.9 TD	68 05/97→12/99	+ ABS; Fitting Position: Rear Axle	11.0101-5407.2 260011	Brake System: ATE	
2.0 16V	97 05/98→09/00	Fitting Position: Rear Axle	11.0101-5407.2 260011	Brake System: ATE	
2.0 16V	100 09/00→08/02	→ Construction year to: 07/02;	11.0101-5407.2 260011	Brake System: ATE	
2.0 Turbo	108 06/94→08/02	Fitting Position: Rear Axle			
2.0 JTD 16V	80 05/99→08/02	Construction year from: 10/99 → → Construction year to: 07/02; + ABS;	11.0101-5407.2 260011	Brake System: ATE	
		Fitting Position: Rear Axle			
2.1 TD	80 03/96→10/99	Construction year from: 06/96 →; + ABS;	11.0101-5407.2 260011	Brake System: ATE	
		Fitting Position: Rear Axle			
Guide Bolt, brake caliper					
1.8	73 05/97→08/02	→ Construction year to: 07/02; + ABS;	2 11.8171-0008.1 990049	Brake System: ATE	
1.9 TD	66 02/95→08/02	Required quantity: 2			
2.0	89 06/94→08/02				
2.0 JTD	80 10/99→08/02				
1.9 TD	68 05/97→12/99	+ ABS; Required quantity: 2	2 11.8171-0008.1 990049	Brake System: ATE	
2.0 16V	97 05/98→09/00	Required quantity: 2	2 11.8171-0008.1 990049	Brake System: ATE	
2.0 16V	100 09/00→08/02	→ Construction year to: 07/02;	2 11.8171-0008.1 990049	Brake System: ATE	
2.0 Turbo	108 06/94→08/02	Required quantity: 2			
2.0 JTD 16V	80 05/99→08/02	Construction year from: 10/99 → → Construction year to: 07/02; + ABS;	2 11.8171-0008.1 990049	Brake System: ATE	
		Required quantity: 2			
2.1 TD	80 03/96→10/99	Construction year from: 06/96 →; + ABS;	2 11.8171-0008.1 990049	Brake System: ATE	
		Required quantity: 2			
FORD - C-MAX (DM2) 02/07→09/10					
Spring, brake caliper					
1.6	74 02/07→09/10	Construction year from: 03/07 →;	2 11.8116-0356.1 390586	Brake System: ATE	
1.6 TDCi	66 - 02/07→09/10 80	Required quantity: 2; Fitting Position: Front Axle			
1.8	90 - 02/07→09/10 92				
1.8 Flexifuel	92 02/07→09/10				
1.8 TDCi	85 02/07→09/10				
2.0	107 02/07→09/10				
2.0 TDCi	98 - 02/07→09/10 100				
1.6	85 04/07→09/10	Required quantity: 2;	2 11.8116-0356.1 390586	Brake System: ATE	
2.0 CNG	107 04/09→09/10	Fitting Position: Front Axle			
2.0 LPG	107 06/08→09/10				
2.0 TDCi	81 02/08→09/10				
Guide Sleeve Kit, brake caliper					
1.6	74 02/07→09/10	Construction year from: 03/07 →;	11.0101-5407.2 260011	Brake System: ATE	
1.6 TDCi	66 - 02/07→09/10 80	Fitting Position: Front Axle			
→					

	kW				
FORD - C-MAX (DM2) 02/07→09/10					
Guide Sleeve Kit, brake caliper					
1.8	90 - 02/07→09/10 92	Construction year from: 03/07 →; Fitting Position: Rear Axle		11.0101-5407.2 260011	Brake System: ATE
1.8 Flexifuel	92 02/07→09/10				
1.8 TDCi	85 02/07→09/10				
2.0	107 02/07→09/10				
2.0 TDCi	98 - 02/07→09/10 100				
1.6	85 04/07→09/10	Fitting Position: Front Axle		11.0101-5407.2 260011	Brake System: ATE
2.0 CNG	107 04/09→09/10	Fitting Position: Rear Axle		11.0101-5407.2 260011	Brake System: ATE
2.0 LPG	107 06/08→09/10				
2.0 TDCi	81 02/08→09/10				
Guide Bolt, brake caliper					
1.6	74 02/07→09/10	Construction year from: 03/07 →;	2	11.8171-0008.1 990049	Brake System: ATE
1.6 TDCi	66 - 02/07→09/10 80	Required quantity: 2; Fitting Position: Front Axle			
1.8	90 - 02/07→09/10 92	Construction year from: 03/07 →;	2	11.8171-0008.1 990049	Brake System: ATE
1.8 Flexifuel	92 02/07→09/10	Required quantity: 2; Fitting Position: Rear Axle			
1.6	85 04/07→09/10	Required quantity: 2; Fitting Position: Front Axle	2	11.8171-0008.1 990049	Brake System: ATE
		Required quantity: 2; Fitting Position: Rear Axle	2	11.8171-0008.1 990049	Brake System: ATE
1.8 TDCi	85 02/07→09/10	Construction year from: 03/07 →;	2	11.8171-0008.1 990049	Brake System: ATE
2.0	107 02/07→09/10	Required quantity: 2			
2.0 TDCi	98 - 02/07→09/10 100	Construction year from: 03/07 →; Required quantity: 2; Fitting Position: Front Axle	2	11.8171-0008.1 990049	Brake System: ATE
2.0 CNG	107 04/09→09/10	Required quantity: 2	2	11.8171-0008.1 990049	Brake System: ATE
2.0 LPG	107 06/08→09/10				
2.0 TDCi	81 02/08→09/10	Required quantity: 2; Fitting Position: Front Axle	2	11.8171-0008.1 990049	Brake System: ATE
FORD - C-MAX II (DXA/CB7, DXA/CEU) 04/10→06/19					
Spring, brake caliper					
1.0 EcoBoost	74 - 10/12→06/19 92	Required quantity: 2	2	11.8116-0356.1 390586	Brake System: ATE
1.5 EcoBoost	110 - 03/15→06/19 134				
1.5 TDCi	70 - 03/15→06/19 88				
1.5 TDCi ECONetic	77 03/15→06/19				
1.6 CNG	86 01/13→12/14				
1.6 EcoBoost	110 - 12/10→06/19 134				
1.6 Flexifuel	88 02/11→06/19				
1.6 LPG	86 - 02/12→06/19 88				
1.6 TDCi	70 - 12/10→06/19 85				
1.6 Ti	63 - 12/10→06/19 92				
2.0 TDCi	85 - 04/10→06/19 125				
Guide Sleeve Kit, brake caliper					
1.0 EcoBoost	74 - 10/12→06/19 92	Fitting Position: Front Axle		11.0101-5407.2 260011	Brake System: ATE
1.5 EcoBoost	110 - 03/15→06/19 134				
1.5 TDCi	70 - 03/15→06/19 88				
1.5 TDCi ECONetic	77 03/15→06/19				
1.6 CNG	86 01/13→12/14				
1.6 EcoBoost	110 - 12/10→06/19 134				
1.6 Flexifuel	88 02/11→06/19				
1.6 LPG	86 - 02/12→06/19 88				
1.6 TDCi	70 - 12/10→06/19 85				
1.6 Ti	63 - 12/10→06/19 92				
2.0 TDCi	85 - 04/10→06/19 125				
Guide Bolt, brake caliper					
1.0 EcoBoost	74 - 10/12→06/19 92	Required quantity: 2	2	11.8171-0008.1 990049	Brake System: ATE
1.5 EcoBoost	110 - 03/15→06/19 134				
→					

	kW			
FORD - C-MAX II (DXA/CB7, DXA/CEU) 04/10→06/19				
Guide Bolt, brake caliper				
1.5 TDCi	70 - 03/15→06/19 88	Required quantity: 2	2	11.8171-0008.1 990049 Brake System: ATE
1.5 TDCi ECONetic	77 03/15→06/19			
1.6 CNG	86 01/13→12/14			
1.6 EcoBoost	110 - 12/10→06/19 134			
1.6 Flexifuel	88 02/11→06/19			
1.6 LPG	86 - 02/12→06/19 88			
1.6 TDCi	70 - 12/10→06/19 85			
1.6 Ti	63 - 12/10→06/19 92			
2.0 TDCi	85 - 04/10→06/19 125			
FORD - C-MAX II Van 10/10→06/19				
Spring, brake caliper				
1.0 EcoBoost	74 - 10/12→06/19 92	Required quantity: 2	2	11.8116-0356.1 390586 Brake System: ATE
1.5 EcoBoost	110 - 03/15→06/19 134			
1.5 TDCi	88 03/15→06/19			
1.5 TDCi ECONetic	77 03/15→06/19			
1.6 EcoBoost	110 - 12/10→06/19 134			
1.6 TDCi	70 - 12/10→06/19 85			
1.6 Ti	77 10/10→06/19			
2.0 TDCi	85 - 12/10→06/19 125			
Guide Sleeve Kit, brake caliper				
1.0 EcoBoost	74 - 10/12→06/19 92	Fitting Position: Front Axle		11.0101-5407.2 260011 Brake System: ATE
1.5 EcoBoost	110 - 03/15→06/19 134			
1.5 TDCi	88 03/15→06/19			
1.5 TDCi ECONetic	77 03/15→06/19			
1.6 EcoBoost	110 - 12/10→06/19 134			
1.6 TDCi	70 - 12/10→06/19 85			
1.6 Ti	77 10/10→06/19			
2.0 TDCi	85 - 12/10→06/19 125			
Guide Bolt, brake caliper				
1.0 EcoBoost	74 - 10/12→06/19 92	Required quantity: 2	2	11.8171-0008.1 990049 Brake System: ATE
1.5 EcoBoost	110 - 03/15→06/19 134			
1.5 TDCi	88 03/15→06/19			
1.5 TDCi ECONetic	77 03/15→06/19			
1.6 EcoBoost	110 - 12/10→06/19 134			
1.6 TDCi	70 - 12/10→06/19 85			
1.6 Ti	77 10/10→06/19			
2.0 TDCi	85 - 12/10→06/19 125			
FORD - COUGAR (EC_) 08/98→12/01				
Guide Sleeve Kit, brake caliper				
2.0 16V	96 08/98→12/01	Construction year from: 09/98 →;		11.0101-5407.2 260011 Brake System: ATE
2.5 V6 24V	125 08/98→12/01	Fitting Position: Front Axle		
2.5 ST 200	151 01/00→12/01	Fitting Position: Front Axle		11.0101-5407.2 260011 Brake System: ATE
2.5 V6 24V	125 06/00→12/01			
Guide Bolt, brake caliper				
2.0 16V	96 08/98→12/01	Construction year from: 09/98 →;	2	11.8171-0008.1 990049 Brake System: ATE
2.5 V6 24V	125 08/98→12/01	Required quantity: 2; Fitting Position: Front Axle		
2.5 ST 200	151 01/00→12/01	Required quantity: 2;	2	11.8171-0008.1 990049 Brake System: ATE
2.5 V6 24V	125 06/00→12/01	Fitting Position: Front Axle		

	kW				
FORD - ESCORT IV Express (AVF) 02/86→07/90					
Guide Sleeve Kit, brake caliper					
1.1	37 05/86→07/90	Fitting Position: Front Axle		11.0101-5407.2 260011	Brake System: ATE
1.3	44 - 02/86→07/90 46				
1.4 i	54 02/86→07/90				
1.6	60 02/86→07/90				
1.6 D	40 02/86→07/90	→ Construction year to: 03/89; Fitting Position: Front Axle		11.0101-5407.2 260011	Brake System: ATE
1.8 D	44 07/88→07/90	Construction year from: 04/89 →; Fitting Position: Front Axle		11.0101-5407.2 260011	Brake System: ATE
Guide Bolt, brake caliper					
1.1	37 05/86→07/90	Required quantity: 2;	2	11.8171-0008.1 990049	Brake System: ATE
1.3	44 - 02/86→07/90 46	Fitting Position: Front Axle			
1.4 i	54 02/86→07/90				
1.6	60 02/86→07/90				
1.6 D	40 02/86→07/90	→ Construction year to: 03/89; Required quantity: 2; Fitting Position: Front Axle	2	11.8171-0008.1 990049	Brake System: ATE
1.8 D	44 07/88→07/90	Construction year from: 04/89 →; Required quantity: 2; Fitting Position: Front Axle	2	11.8171-0008.1 990049	Brake System: ATE
FORD - ESCORT IV Turnier (AWF, AVF) 10/85→10/90					
Guide Sleeve Kit, brake caliper					
1.1	37 10/85→09/90	Construction year from: 01/86 → →		11.0101-5407.2 260011	Brake System: ATE
1.4	51 10/85→10/90	Construction year to: 08/90; Fitting Position: Front Axle			
1.3	44 - 01/86→07/90 51	Fitting Position: Front Axle		11.0101-5407.2 260011	Brake System: ATE
1.4	54 01/86→07/90				
1.6	58 01/86→07/90				
1.6 D	40 01/86→01/89				
1.6 i	66 01/86→07/90				
1.8 D	44 01/89→07/90	Construction year from: 04/89 →; Fitting Position: Front Axle		11.0101-5407.2 260011	Brake System: ATE
Guide Bolt, brake caliper					
1.1	37 10/85→09/90	Construction year from: 01/86 → →	2	11.8171-0008.1 990049	Brake System: ATE
1.4	51 10/85→10/90	Construction year to: 08/90; Required quantity: 2; Fitting Position: Front Axle			
1.3	44 - 01/86→07/90 51	Required quantity: 2; Fitting Position: Front Axle	2	11.8171-0008.1 990049	Brake System: ATE
1.4	54 01/86→07/90				
1.6	58 01/86→07/90				
1.6 D	40 01/86→01/89				
1.6 i	66 01/86→07/90				
1.8 D	44 01/89→07/90	Construction year from: 04/89 →; Required quantity: 2; Fitting Position: Front Axle	2	11.8171-0008.1 990049	Brake System: ATE
FORD - ESCORT V (AAL, ABL) 07/90→09/96					
Guide Sleeve Kit, brake caliper					
1.8 16V XR3i	96 02/92→01/95	Fitting Position: Front Axle		11.0101-5407.2 260011	Brake System: ATE
1.8 XR3i 16V 4x4	96 08/93→01/95				
RS 2000	110 05/91→01/95				
RS Cosworth 4x4	162 10/91→01/95				
Guide Bolt, brake caliper					
1.8 16V XR3i	96 02/92→01/95	Required quantity: 2;	2	11.8171-0008.1 990049	Brake System: ATE
1.8 XR3i 16V 4x4	96 08/93→01/95	Fitting Position: Front Axle			
RS 2000	110 05/91→01/95				
RS Cosworth 4x4	162 10/91→01/95				
FORD - ESCORT V Convertible (ALL) 07/90→01/95					
Guide Sleeve Kit, brake caliper					
1.8 16V XR3i	96 02/92→01/95	Fitting Position: Front Axle		11.0101-5407.2 260011	Brake System: ATE
Guide Bolt, brake caliper					
1.8 16V XR3i	96 02/92→01/95	Required quantity: 2; Fitting Position: Front Axle	2	11.8171-0008.1 990049	Brake System: ATE
FORD - ESCORT V Turnier (ANL) 07/90→01/95					
Guide Sleeve Kit, brake caliper					
1.8 i 16V	96 02/93→01/95	Fitting Position: Front Axle		11.0101-5407.2 260011	Brake System: ATE
→					

	kW				
FORD - ESCORT V Turnier (ANL) 07/90→01/95					
Guide Bolt, brake caliper					
1.8 i 16V	96	02/93→01/95	Required quantity: 2; Fitting Position: Front Axle	2	11.8171-0008.1 990049 Brake System: ATE
FORD - ESCORT VI (GAL, AAL, ABL) 01/95→10/02					
Guide Sleeve Kit, brake caliper					
RS 2000	110	02/95→02/98	Fitting Position: Front Axle		11.0101-5407.2 260011 Brake System: ATE
			→ Construction year to: 12/95; Fitting Position: Front Axle		11.0101-5407.2 260011 Brake System: ATE
RS 2000 4x4	110	02/95→10/98	Fitting Position: Front Axle		11.0101-5407.2 260011 Brake System: ATE
RS Cosworth 4x4	162	02/95→10/98	→ Construction year to: 12/95; Fitting Position: Front Axle		11.0101-5407.2 260011 Brake System: ATE
Guide Bolt, brake caliper					
RS 2000	110	02/95→02/98	→ Construction year to: 12/95; Required quantity: 2; Fitting Position: Front Axle	2	11.8171-0008.1 990049 Brake System: ATE
			Required quantity: 2; Fitting Position: Front Axle	2	11.8171-0008.1 990049 Brake System: ATE
RS 2000 4x4	110	02/95→10/98	Required quantity: 2; Fitting Position: Front Axle	2	11.8171-0008.1 990049 Brake System: ATE
RS Cosworth 4x4	162	02/95→10/98	→ Construction year to: 12/95; Required quantity: 2; Fitting Position: Front Axle	2	11.8171-0008.1 990049 Brake System: ATE
FORD - ESCORT VI Convertible (ALL) 03/94→08/00					
Guide Sleeve Kit, brake caliper					
1.8 16V XR3i	96	02/95→08/00	→ Construction year to: 02/99; Fitting Position: Front Axle		11.0101-5407.2 260011 Brake System: ATE
Guide Bolt, brake caliper					
1.8 16V XR3i	96	02/95→08/00	→ Construction year to: 02/99; Required quantity: 2; Fitting Position: Front Axle	2	11.8171-0008.1 990049 Brake System: ATE
FORD - FIESTA I (GFBT) 05/76→08/83					
Guide Sleeve Kit, brake caliper					
0.9	29 -	05/76→08/83	Construction year from: 08/83 →; Fitting Position: Front Axle		11.0101-5407.2 260011 Brake System: ATE
1.1	39 -	05/76→08/83			
	40				
1.3	49	08/77→08/83			
1.6 XR2	62	08/81→08/83	Construction year from: 09/81 →; Fitting Position: Front Axle		11.0101-5407.2 260011 Brake System: ATE
1.6 XR2	71	09/81→08/83	Fitting Position: Front Axle		11.0101-5407.2 260011 Brake System: ATE
Guide Bolt, brake caliper					
0.9	29 -	05/76→08/83	Construction year from: 08/83 →; Required quantity: 2; Fitting Position: Front Axle	2	11.8171-0008.1 990049 Brake System: ATE
1.1	39 -	05/76→08/83			
	40				
1.3	49	08/77→08/83			
1.6 XR2	62	08/81→08/83	Construction year from: 09/81 →; Required quantity: 2	2	11.8171-0008.1 990049 Brake System: ATE
1.6 XR2	71	09/81→08/83	Required quantity: 2	2	11.8171-0008.1 990049 Brake System: ATE
FORD - FIESTA II (FBD) 09/83→11/89					
Guide Sleeve Kit, brake caliper					
1.0	33	09/83→02/89	Fitting Position: Front Axle		11.0101-5407.2 260011 Brake System: ATE
1.1	36 -	09/83→02/89			
	37				
1.4	52 -	10/86→02/89			
	54				
1.6 D	40	04/84→02/89			
1.6 XR2	70 -	03/84→02/89			
	71				
1.3	51	09/83→01/87	→ Construction year to: 08/86; Fitting Position: Front Axle		11.0101-5407.2 260011 Brake System: ATE
1.4	51	09/83→01/87	Construction year from: 01/86 →; Fitting Position: Front Axle		11.0101-5407.2 260011 Brake System: ATE
1.4	55	10/85→11/89	Construction year from: 01/86 → → Construction year to: 04/89; Fitting Position: Front Axle		11.0101-5407.2 260011 Brake System: ATE
→					

	kW				
FORD - FIESTA II (FBD) 09/83→11/89					
Guide Bolt, brake caliper					
1.0	33	09/83→02/89	Required quantity: 2;	2	11.8171-0008.1 990049 Brake System: ATE
1.1	36 - 37	09/83→02/89	Fitting Position: Front Axle		
1.4	52 - 54	10/86→02/89			
1.6 D	40	04/84→02/89			
1.3	51	09/83→01/87	→ Construction year to: 08/86; Required quantity: 2; Fitting Position: Front Axle	2	11.8171-0008.1 990049 Brake System: ATE
1.4	51	09/83→01/87	Construction year from: 01/86 →; Required quantity: 2; Fitting Position: Front Axle	2	11.8171-0008.1 990049 Brake System: ATE
1.4	55	10/85→11/89	Construction year from: 01/86 → → Construction year to: 04/89; Required quantity: 2; Fitting Position: Front Axle	2	11.8171-0008.1 990049 Brake System: ATE
1.6 XR2	70 - 71	03/84→02/89	Required quantity: 2	2	11.8171-0008.1 990049 Brake System: ATE
FORD - FIESTA III (GFJ) 01/89→01/97					
Guide Sleeve Kit, brake caliper					
1.0	33	03/89→12/95	→ Construction year to: 10/95;		11.0101-5407.2 260011 Brake System: ATE
1.3	44	03/89→12/95	Fitting Position: Front Axle		
1.4	52 - 54	03/89→12/95	Construction year from: 11/95 →; Fitting Position: Front Axle		11.0101-5407.2 260011 Brake System: ATE
1.6 i 16V	65	01/94→12/95			
1.8 16V	77	02/92→12/95			
1.8 TD	55	03/93→12/95			
1.8 XR2i 16V	96	02/92→12/95			
1.1	37 - 40	03/89→12/95	Construction year from: 05/89 → → Construction year to: 10/95;		11.0101-5407.2 260011 Brake System: ATE
1.8 D	44	03/89→12/95	Fitting Position: Front Axle		
			Construction year from: 11/95 →; Fitting Position: Front Axle		11.0101-5407.2 260011 Brake System: ATE
1.3	44	03/89→12/92	Fitting Position: Front Axle		11.0101-5407.2 260011 Brake System: ATE
1.6	65 - 66	01/89→01/94			
1.6 Turbo	96	03/90→10/92			
1.6 XR2i	76 - 81	03/89→01/94			
1.3 Cat	44	05/91→01/97	Construction year from: 11/95 → →		11.0101-5407.2 260011 Brake System: ATE
1.4	55	11/92→12/96	Construction year to: 11/96; Fitting Position: Front Axle		
			→ Construction year to: 10/95; Fitting Position: Front Axle		11.0101-5407.2 260011 Brake System: ATE
Guide Bolt, brake caliper					
1.0	33	03/89→12/95	→ Construction year to: 10/95;	2	11.8171-0008.1 990049 Brake System: ATE
1.3	44	03/89→12/95	Required quantity: 2		
1.4	52 - 54	03/89→12/95	Construction year from: 11/95 →; Required quantity: 2	2	11.8171-0008.1 990049 Brake System: ATE
1.6 i 16V	65	01/94→12/95			
1.8 16V	77	02/92→12/95			
1.8 TD	55	03/93→12/95			
1.8 XR2i 16V	96	02/92→12/95			
1.1	37 - 40	03/89→12/95	Construction year from: 05/89 → → Construction year to: 10/95;	2	11.8171-0008.1 990049 Brake System: ATE
1.8 D	44	03/89→12/95	Required quantity: 2		
			Construction year from: 11/95 →; Required quantity: 2	2	11.8171-0008.1 990049 Brake System: ATE
1.3	44	03/89→12/92	Required quantity: 2	2	11.8171-0008.1 990049 Brake System: ATE
1.6	65 - 66	01/89→01/94			
1.6 Turbo	96	03/90→10/92			
1.6 XR2i	76 - 81	03/89→01/94			
1.3 Cat	44	05/91→01/97	Construction year from: 11/95 → →	2	11.8171-0008.1 990049 Brake System: ATE
1.4	55	11/92→12/96	Construction year to: 11/96; Required quantity: 2		
			→ Construction year to: 10/95; Required quantity: 2	2	11.8171-0008.1 990049 Brake System: ATE
FORD - FIESTA IV (JA_, JB_) 08/95→06/06					
Guide Sleeve Kit, brake caliper					
1.0 i	38	04/96→09/99	Fitting Position: Front Axle		11.0101-5407.2 260011 Brake System: ATE
1.6 16V Sport	76	02/00→01/02			
1.0 i	48	09/99→01/02	→ Construction year to: 01/00;		11.0101-5407.2 260011 Brake System: ATE
1.4 i 16V	66	04/96→01/02	Fitting Position: Front Axle		
→					

	kW				
FORD - FIESTA IV (JA_, JB_) 08/95→06/06					
Guide Sleeve Kit, brake caliper					
1.0 i 1.4 i 16V	48 09/99→01/02 66 04/96→01/02	Construction year from: 02/00 →; Fitting Position: Front Axle		11.0101-5407.2 260011	Brake System: ATE
1.25 i 16V	55 08/95→01/02	Construction year from: 01/96 → → Construction year to: 01/00; Transmission Type: Manual Transmis- sion; Fitting Position: Front Axle		11.0101-5407.2 260011	Brake System: ATE
		Construction year from: 01/96 → → Construction year to: 01/00; Transmission Type: Automatic Transmis- sion; Fitting Position: Front Axle		11.0101-5407.2 260011	Brake System: ATE
		Construction year from: 02/00 →; Fitting Position: Front Axle		11.0101-5407.2 260011	Brake System: ATE
1.3 i 1.8 D	37 - 08/95→01/02 44 44 08/95→04/00	Construction year from: 01/96 → → Construction year to: 01/00; Fitting Position: Front Axle		11.0101-5407.2 260011	Brake System: ATE
		Construction year from: 02/00 →; Fitting Position: Front Axle		11.0101-5407.2 260011	Brake System: ATE
1.8 DI	55 04/00→01/02	- ABS; Fitting Position: Front Axle		11.0101-5407.2 260011	Brake System: ATE
		+ ABS; Fitting Position: Front Axle		11.0101-5407.2 260011	Brake System: ATE
Guide Bolt, brake caliper					
1.0 i 1.6 16V Sport	38 04/96→09/99 76 02/00→01/02	Required quantity: 2; Fitting Position: Front Axle	2	11.8171-0008.1 990049	Brake System: ATE
1.0 i 1.4 i 16V	48 09/99→01/02 66 04/96→01/02	Construction year from: 02/00 →; Required quantity: 2; Fitting Position: Front Axle	2	11.8171-0008.1 990049	Brake System: ATE
		→ Construction year to: 01/00; Required quantity: 2; Fitting Position: Front Axle	2	11.8171-0008.1 990049	Brake System: ATE
1.25 i 16V	55 08/95→01/02	Construction year from: 01/96 → → Construction year to: 01/00; Transmission Type: Manual Transmis- sion; Required quantity: 2; Fitting Position: Front Axle	2	11.8171-0008.1 990049	Brake System: ATE
		Construction year from: 01/96 → → Construction year to: 01/00; Transmission Type: Automatic Transmis- sion; Required quantity: 2; Fitting Position: Front Axle	2	11.8171-0008.1 990049	Brake System: ATE
		Construction year from: 02/00 →; Required quantity: 2; Fitting Position: Front Axle	2	11.8171-0008.1 990049	Brake System: ATE
1.3 i 1.8 D	37 - 08/95→01/02 44 44 08/95→04/00	Construction year from: 01/96 → → Construction year to: 01/00; Required quantity: 2; Fitting Position: Front Axle	2	11.8171-0008.1 990049	Brake System: ATE
		Construction year from: 02/00 →; Required quantity: 2; Fitting Position: Front Axle	2	11.8171-0008.1 990049	Brake System: ATE
1.8 DI	55 04/00→01/02	- ABS; Required quantity: 2; Fitting Position: Front Axle	2	11.8171-0008.1 990049	Brake System: ATE
		+ ABS; Required quantity: 2; Fitting Position: Front Axle	2	11.8171-0008.1 990049	Brake System: ATE
FORD - FIESTA V (JH_, JD_) 11/01→12/14					
Guide Sleeve Kit, brake caliper					
1.25 16V 1.3 ROCAM 1.6 1.6 TDCi	51 - 05/02→06/08 55 55 01/02→12/04 72 05/02→06/08 66 11/04→06/08	Fitting Position: Front Axle		11.0101-5407.2 260011	Brake System: ATE
1.3 1.4 16V 1.4 TDCi 1.6 16V	44 - 11/01→06/08 51 59 11/01→06/08 50 11/01→06/08 74 11/01→06/08	Construction year from: 04/02 →; Fitting Position: Front Axle		11.0101-5407.2 260011	Brake System: ATE
Guide Bolt, brake caliper					
1.25 16V 1.3 ROCAM 1.6 1.6 TDCi	51 - 05/02→06/08 55 55 01/02→12/04 72 05/02→06/08 66 11/04→06/08	Required quantity: 2	2	11.8171-0008.1 990049	Brake System: ATE
1.3 1.4 16V 1.4 TDCi 1.6 16V	44 - 11/01→06/08 51 59 11/01→06/08 50 11/01→06/08 74 11/01→06/08	Construction year from: 04/02 →; Required quantity: 2	2	11.8171-0008.1 990049	Brake System: ATE

	kw				
FORD - FIESTA V Van 05/02→12/10					
Guide Sleeve Kit, brake caliper					
1.3	44 - 05/02→08/08 51	Fitting Position: Front Axle		11.0101-5407.2 260011	Brake System: ATE
1.4	59 05/02→09/05				
1.4 TDCi	50 10/03→12/10	→ Construction year to: 08/08;		11.0101-5407.2 260011	Brake System: ATE
1.6 TDCi	66 04/07→09/09	Fitting Position: Front Axle			
Guide Bolt, brake caliper					
1.3	44 - 05/02→08/08 51	Required quantity: 2	2	11.8171-0008.1 990049	Brake System: ATE
1.4	59 05/02→09/05				
1.4 TDCi	50 10/03→12/10	→ Construction year to: 08/08;	2	11.8171-0008.1 990049	Brake System: ATE
1.6 TDCi	66 04/07→09/09	Required quantity: 2			
FORD - FIESTA Box Body/MPV (F3L, F5L) 04/89→02/96					
Guide Sleeve Kit, brake caliper					
1.3	44 09/91→02/96	→ Construction year to: 10/95;		11.0101-5407.2 260011	Brake System: ATE
1.8 D	44 09/91→02/96	Fitting Position: Front Axle			
		Construction year from: 11/95 →;	2	11.0101-5407.2 260011	Brake System: ATE
		Fitting Position: Front Axle			
Guide Bolt, brake caliper					
1.3	44 09/91→02/96	→ Construction year to: 10/95;	2	11.8171-0008.1 990049	Brake System: ATE
1.8 D	44 09/91→02/96	Required quantity: 2			
		Construction year from: 11/95 →;	2	11.8171-0008.1 990049	Brake System: ATE
		Required quantity: 2			
FORD - FIESTA Box Body/MPV (J5_, J3_) 02/96→					
Guide Sleeve Kit, brake caliper					
1.3	44 02/96→08/03	Construction year from: 02/00 → →		11.0101-5407.2 260011	Brake System: ATE
1.8 D	44 02/96→04/02	Construction year to: 03/02;			
		Fitting Position: Front Axle			
		→ Construction year to: 01/00;	2	11.0101-5407.2 260011	Brake System: ATE
		Fitting Position: Front Axle			
1.4 i	66 04/96→10/99	Fitting Position: Front Axle		11.0101-5407.2 260011	Brake System: ATE
1.8 DI	55 09/00→08/03	→ Construction year to: 03/02; - ABS;		11.0101-5407.2 260011	Brake System: ATE
		Fitting Position: Front Axle			
		→ Construction year to: 03/02; + ABS;	2	11.0101-5407.2 260011	Brake System: ATE
		Fitting Position: Front Axle			
Guide Bolt, brake caliper					
1.3	44 02/96→08/03	Construction year from: 02/00 → →	2	11.8171-0008.1 990049	Brake System: ATE
1.8 D	44 02/96→04/02	Construction year to: 03/02;			
		Required quantity: 2;			
		Fitting Position: Front Axle			
		→ Construction year to: 01/00;	2	11.8171-0008.1 990049	Brake System: ATE
		Required quantity: 2;			
		Fitting Position: Front Axle			
1.4 i	66 04/96→10/99	Required quantity: 2;	2	11.8171-0008.1 990049	Brake System: ATE
		Fitting Position: Front Axle			
1.8 DI	55 09/00→08/03	→ Construction year to: 03/02; - ABS;	2	11.8171-0008.1 990049	Brake System: ATE
		Required quantity: 2;			
		Fitting Position: Front Axle			
		→ Construction year to: 03/02; + ABS;	2	11.8171-0008.1 990049	Brake System: ATE
		Required quantity: 2;			
		Fitting Position: Front Axle			
FORD - FIESTA Box Body/MPV (JV_) 05/98→08/03					
Guide Sleeve Kit, brake caliper					
D 1.8	44 05/98→04/02	Construction year from: 02/00 → →		11.0101-5407.2 260011	Brake System: ATE
		Construction year to: 03/02;			
		Fitting Position: Front Axle			
		→ Construction year to: 01/00;	2	11.0101-5407.2 260011	Brake System: ATE
		Fitting Position: Front Axle			
Guide Bolt, brake caliper					
D 1.8	44 05/98→04/02	Construction year from: 02/00 → →	2	11.8171-0008.1 990049	Brake System: ATE
		Construction year to: 03/02;			
		Required quantity: 2;			
		Fitting Position: Front Axle			
		→ Construction year to: 01/00;	2	11.8171-0008.1 990049	Brake System: ATE
		Required quantity: 2;			
		Fitting Position: Front Axle			

	kW				
FORD - FIESTA Hatchback Van (FVD) 03/83→12/95					
Guide Sleeve Kit, brake caliper					
1.0	33	08/83→11/89	→ Construction year to: 04/89; Fitting Position: Front Axle	11.0101-5407.2	260011 Brake System: ATE
1.4	52	09/86→09/89			
1.6 D	40	09/83→09/89	Construction year from: 03/84 → → Construction year to: 04/89; Fitting Position: Front Axle	11.0101-5407.2	260011 Brake System: ATE
1.8 D	43	03/89→12/95	Construction year from: 09/91 → → Construction year to: 10/95; Fitting Position: Front Axle	11.0101-5407.2	260011 Brake System: ATE
			Construction year from: 11/95 → →; Fitting Position: Front Axle	11.0101-5407.2	260011 Brake System: ATE
Guide Bolt, brake caliper					
1.0	33	08/83→11/89	→ Construction year to: 04/89;	2	11.8171-0008.1 990049 Brake System: ATE
1.4	52	09/86→09/89	Required quantity: 2; Fitting Position: Front Axle		
1.6 D	40	09/83→09/89	Construction year from: 03/84 → → Construction year to: 04/89; Required quantity: 2; Fitting Position: Front Axle	2	11.8171-0008.1 990049 Brake System: ATE
1.8 D	43	03/89→12/95	Construction year from: 09/91 → → Construction year to: 10/95; Required quantity: 2	2	11.8171-0008.1 990049 Brake System: ATE
			Construction year from: 11/95 → →; Required quantity: 2	2	11.8171-0008.1 990049 Brake System: ATE
FORD - FIESTA Hatchback Van (WFVT) 05/76→11/86					
Guide Sleeve Kit, brake caliper					
1.0	29	10/77→11/86	Construction year from: 08/83 → →;	11.0101-5407.2	260011 Brake System: ATE
1.1	39	10/77→11/86	Fitting Position: Front Axle		
Guide Bolt, brake caliper					
1.0	29	10/77→11/86	Construction year from: 08/83 → →;	2	11.8171-0008.1 990049 Brake System: ATE
1.1	39	10/77→11/86	Required quantity: 2; Fitting Position: Front Axle		
FORD - FIESTA Saloon 09/00→12/14					
Guide Sleeve Kit, brake caliper					
1.0	70	09/04→12/06	Fitting Position: Front Axle	11.0101-5407.2	260011 Brake System: ATE
1.4 TDCi	50	05/02→11/11			
1.6	73	05/02→11/13			
Guide Bolt, brake caliper					
1.0	70	09/04→12/06	Required quantity: 2	2	11.8171-0008.1 990049 Brake System: ATE
1.4 TDCi	50	05/02→11/11			
1.6	73	05/02→11/13			
FORD - FOCUS I (DAW, DBW) 09/98→11/09					
Guide Sleeve Kit, brake caliper					
1.4 16V	55	10/98→09/99	Fitting Position: Front Axle	11.0101-5407.2	260011 Brake System: ATE
1.6	76	07/03→06/07			
1.8 16V BiFuel	85	09/02→07/04			
1.4 16V	55	10/98→11/04	→ Construction year to: 09/04;	11.0101-5407.2	260011 Brake System: ATE
1.6 16V	74	10/98→11/04	Fitting Position: Front Axle		
1.6 16V Flexifuel	75	01/02→11/04			
1.8 16V	85	10/98→11/04			
1.8 DI / TDDi	55	08/99→11/04			
1.8 TDCi	74 -	03/01→11/04			
	85				
1.8 Turbo DI / TDDi	66	10/98→11/04			
2.0 16V	96	10/98→11/04			
Guide Bolt, brake caliper					
1.4 16V	55	10/98→09/99	Required quantity: 2;	2	11.8171-0008.1 990049 Brake System: ATE
1.6	76	07/03→06/07	Fitting Position: Front Axle		
1.8 16V BiFuel	85	09/02→07/04			
1.4 16V	55	10/98→11/04	→ Construction year to: 09/04;	2	11.8171-0008.1 990049 Brake System: ATE
1.6 16V	74	10/98→11/04	Required quantity: 2;		
1.6 16V Flexifuel	75	01/02→11/04	Fitting Position: Front Axle		
1.8 16V	85	10/98→11/04			
1.8 DI / TDDi	55	08/99→11/04			
1.8 TDCi	74 -	03/01→11/04			
	85				
1.8 Turbo DI / TDDi	66	10/98→11/04			
2.0 16V	96	10/98→11/04			

FORD - FOCUS I Estate Van (DNW) 08/98→03/05							
Guide Sleeve Kit, brake caliper							
1.4	55	04/99→03/05	→ Construction year to: 09/04;			11.0101-5407.2	260011 Brake System: ATE
1.6	74	04/99→03/05	Fitting Position: Front Axle				
1.8	85	04/99→03/05					
1.8 TDCi	74 -	08/01→03/05					
	85						
1.8 TDDi	55 -	08/98→03/05					
	66						
Guide Bolt, brake caliper							
1.4	55	04/99→03/05	→ Construction year to: 09/04;	2		11.8171-0008.1	990049 Brake System: ATE
1.6	74	04/99→03/05	Required quantity: 2;				
1.8	85	04/99→03/05	Fitting Position: Front Axle				
1.8 TDCi	74 -	08/01→03/05					
	85						
1.8 TDDi	55 -	08/98→03/05					
	66						
FORD - FOCUS I Saloon (DFW) 02/99→11/09							
Guide Sleeve Kit, brake caliper							
1.4 16V	55	02/99→11/04	→ Construction year to: 09/04;			11.0101-5407.2	260011 Brake System: ATE
1.6 16V	74	02/99→11/04	Fitting Position: Front Axle				
1.8 16V	85	02/99→11/04					
1.8 TDCi	74 -	03/01→11/04					
	85						
1.8 Turbo DI / TDDi	55 -	02/99→03/05					
	66						
2.0 16V	96	02/99→11/04					
Guide Bolt, brake caliper							
1.4 16V	55	02/99→11/04	→ Construction year to: 09/04;	2		11.8171-0008.1	990049 Brake System: ATE
1.6 16V	74	02/99→11/04	Required quantity: 2;				
1.8 16V	85	02/99→11/04	Fitting Position: Front Axle				
1.8 TDCi	74 -	03/01→11/04					
	85						
1.8 Turbo DI / TDDi	55 -	02/99→03/05					
	66						
2.0 16V	96	02/99→11/04					
FORD - FOCUS I Turnier (DNW) 02/99→12/07							
Guide Sleeve Kit, brake caliper							
1.4 16V	55	02/99→11/04	→ Construction year to: 09/04;			11.0101-5407.2	260011 Brake System: ATE
1.6 16V	74	02/99→11/04	Fitting Position: Front Axle				
1.6 16V Flexifuel	75	01/02→11/04					
1.8 16V	85	02/99→11/04					
1.8 DI / TDDi	55	08/99→11/04					
1.8 TDCi	74 -	03/01→11/04					
	85						
1.8 Turbo DI / TDDi	66	02/99→11/04					
2.0 16V	96	02/99→11/04					
1.8 BiFuel	82	02/03→01/05	Fitting Position: Front Axle			11.0101-5407.2	260011 Brake System: ATE
Guide Bolt, brake caliper							
1.4 16V	55	02/99→11/04	→ Construction year to: 09/04;	2		11.8171-0008.1	990049 Brake System: ATE
1.6 16V	74	02/99→11/04	Required quantity: 2;				
1.6 16V Flexifuel	75	01/02→11/04	Fitting Position: Front Axle				
1.8 16V	85	02/99→11/04					
1.8 DI / TDDi	55	08/99→11/04					
1.8 TDCi	74 -	03/01→11/04					
	85						
1.8 Turbo DI / TDDi	66	02/99→11/04					
2.0 16V	96	02/99→11/04					
1.8 BiFuel	82	02/03→01/05	Required quantity: 2;	2		11.8171-0008.1	990049 Brake System: ATE
			Fitting Position: Front Axle				
FORD - FOCUS II (DA_, HCP, DP) 07/04→09/13							
Spring, brake caliper							
1.4	59	07/04→09/12	Construction year from: 10/04 → →	2		11.8116-0356.1	390586 Brake System: ATE
1.6	74	07/04→09/12	Construction year to: 02/11;				
1.6 TDCi	74 -	07/04→09/12	Required quantity: 2;				
	80		Fitting Position: Front Axle				
1.6 Ti	85	07/04→09/12					
2.0	107	07/04→09/12					
2.0 TDCi	100	07/04→09/12					
1.6	81	01/10→09/12	Required quantity: 2;	2		11.8116-0356.1	390586 Brake System: ATE
2.0	104	06/05→09/08	Fitting Position: Front Axle				
2.0 Flex	107	10/08→03/10					
1.6 LPG	85	10/09→07/11	→ Construction year to: 02/11;	2		11.8116-0356.1	390586 Brake System: ATE
1.6 TDCi	66	01/05→09/12	Required quantity: 2;				
1.8	92	03/06→09/12	Fitting Position: Front Axle				
→							

	kW				
FORD - FOCUS II (DA_, HCP, DP) 07/04→09/13					
Spring, brake caliper					
1.8 Flexifuel	92	01/06→09/12	→ Construction year to: 02/11; Required quantity: 2; Fitting Position: Front Axle	2	11.8116-0356.1 390586 Brake System: ATE
1.8 TDCi	85	01/05→09/12			
2.0 CNG	107	04/09→07/11			
2.0 LPG	107	06/08→07/11			
2.0 TDCi	81	02/08→07/11			
2.0 TDCi	98	07/04→01/08	Construction year from: 10/04 →; Required quantity: 2; Fitting Position: Front Axle	2	11.8116-0356.1 390586 Brake System: ATE
Guide Sleeve Kit, brake caliper					
1.4	59	07/04→09/12	Construction year from: 10/04 → → Construction year to: 02/11; Fitting Position: Front Axle	2	11.0101-5407.2 260011 Brake System: ATE
1.6	74	07/04→09/12			
1.6 TDCi	74 - 80	07/04→09/12	Construction year from: 10/04 → → Construction year to: 02/11; Fitting Position: Rear Axle	2	11.0101-5407.2 260011 Brake System: ATE
1.6 Ti	85	07/04→09/12			
2.0	107	07/04→09/12	Fitting Position: Rear Axle	2	11.0101-5407.2 260011 Brake System: ATE
2.0 TDCi	100	07/04→09/12			
1.6	81	01/10→09/12	Fitting Position: Front Axle	2	11.0101-5407.2 260011 Brake System: ATE
2.0	104	06/05→09/08	Fitting Position: Rear Axle	2	11.0101-5407.2 260011 Brake System: ATE
2.0 Flex	107	10/08→03/10		2	11.0101-5407.2 260011 Brake System: ATE
1.6 LPG	85	10/09→07/11	→ Construction year to: 02/11; Fitting Position: Front Axle	2	11.0101-5407.2 260011 Brake System: ATE
1.6 TDCi	66	01/05→09/12			
1.8	92	03/06→09/12	→ Construction year to: 02/11; Fitting Position: Rear Axle	2	11.0101-5407.2 260011 Brake System: ATE
1.8 Flexifuel	92	01/06→09/12			
1.8 TDCi	85	01/05→09/12	Construction year from: 10/04 → →; Fitting Position: Front Axle	2	11.0101-5407.2 260011 Brake System: ATE
2.0 CNG	107	04/09→07/11			
2.0 LPG	107	06/08→07/11			
2.0 TDCi	81	02/08→07/11			
2.5 ST	166	10/05→09/12			
2.0 TDCi	98	07/04→01/08			
			Construction year from: 10/04 → →; Fitting Position: Rear Axle	2	11.0101-5407.2 260011 Brake System: ATE
Guide Bolt, brake caliper					
1.4	59	07/04→09/12	Construction year from: 10/04 → → Construction year to: 02/11; Required quantity: 2	2	11.8171-0008.1 990049 Brake System: ATE
1.6	74	07/04→09/12			
1.6 TDCi	74 - 80	07/04→09/12	Required quantity: 2	2	11.8171-0008.1 990049 Brake System: ATE
1.6 Ti	85	07/04→09/12			
2.0	107	07/04→09/12	Required quantity: 2	2	11.8171-0008.1 990049 Brake System: ATE
2.0 TDCi	100	07/04→09/12			
1.6	81	01/10→09/12	→ Construction year to: 02/11; Required quantity: 2	2	11.8171-0008.1 990049 Brake System: ATE
2.0	104	06/05→09/08			
2.0 Flex	107	10/08→03/10			
1.6 LPG	85	10/09→07/11			
1.6 TDCi	66	01/05→09/12			
1.8	92	03/06→09/12			
1.8 Flexifuel	92	01/06→09/12			
1.8 TDCi	85	01/05→09/12			
2.0 CNG	107	04/09→07/11			
2.0 LPG	107	06/08→07/11			
2.0 TDCi	81	02/08→07/11			
2.5 ST	166	10/05→09/12			
2.0 TDCi	98	07/04→01/08	Construction year from: 10/04 → →; Required quantity: 2	2	11.8171-0008.1 990049 Brake System: ATE
FORD - FOCUS II Convertible 10/06→09/10					
Spring, brake caliper					
1.6	74	10/06→09/10	Required quantity: 2; Fitting Position: Front Axle	2	11.8116-0356.1 390586 Brake System: ATE
2.0	107	10/06→09/10			
2.0 TDCi	100	10/06→09/10			
Guide Sleeve Kit, brake caliper					
1.6	74	10/06→09/10	Fitting Position: Front Axle	2	11.0101-5407.2 260011 Brake System: ATE
2.0	107	10/06→09/10	Fitting Position: Rear Axle	2	11.0101-5407.2 260011 Brake System: ATE
2.0 TDCi	100	10/06→09/10		2	11.0101-5407.2 260011 Brake System: ATE
Guide Bolt, brake caliper					
1.6	74	10/06→09/10	Required quantity: 2	2	11.8171-0008.1 990049 Brake System: ATE
2.0	107	10/06→09/10			
2.0 TDCi	100	10/06→09/10			
FORD - FOCUS II Estate Van 07/04→07/11					
Spring, brake caliper					
1.4	59	09/05→07/11	Required quantity: 2; Fitting Position: Front Axle	2	11.8116-0356.1 390586 Brake System: ATE
1.6	74	09/05→07/11			
1.8 Flexifuel	92	06/09→07/11			
→					

	kW				
FORD - FOCUS II Estate Van 07/04→07/11					
Spring, brake caliper					
1.6 TDCi	66 - 07/04→07/11		→ Construction year to: 02/11; Required quantity: 2;	2	11.8116-0356.1 390586 Brake System: ATE
1.6 Ti-VCT	85 09/05→07/11		Fitting Position: Front Axle		
2.0 TDCi	81 - 09/05→07/11				
	100				
Guide Sleeve Kit, brake caliper					
1.4	59 09/05→07/11		Fitting Position: Front Axle		11.0101-5407.2 260011 Brake System: ATE
1.6	74 09/05→07/11				
1.8 Flexifuel	92 06/09→07/11		Fitting Position: Rear Axle		11.0101-5407.2 260011 Brake System: ATE
1.6 TDCi	66 - 07/04→07/11		→ Construction year to: 02/11; Fitting Position: Front Axle		11.0101-5407.2 260011 Brake System: ATE
1.6 Ti-VCT	85 09/05→07/11				
2.0 TDCi	81 - 09/05→07/11		→ Construction year to: 02/11; Fitting Position: Rear Axle		11.0101-5407.2 260011 Brake System: ATE
	100				
Guide Bolt, brake caliper					
1.4	59 09/05→07/11		Required quantity: 2	2	11.8171-0008.1 990049 Brake System: ATE
1.6	74 09/05→07/11				
1.8 Flexifuel	92 06/09→07/11				
1.6 TDCi	66 - 07/04→07/11		→ Construction year to: 02/11; Required quantity: 2	2	11.8171-0008.1 990049 Brake System: ATE
1.6 Ti-VCT	85 09/05→07/11				
2.0 TDCi	81 - 09/05→07/11				
	100				
FORD - FOCUS II Saloon (DB_, FCH, DH) 04/05→					
Spring, brake caliper					
1.4	59 04/05→09/12		→ Construction year to: 02/11;	2	11.8116-0356.1 390586 Brake System: ATE
1.6	74 04/05→09/12		Required quantity: 2;		
1.6 TDCi	66 - 04/05→09/12		Fitting Position: Front Axle		
	80				
1.6 Ti	85 04/05→09/12				
1.8	92 03/06→09/12				
1.8 Flexifuel	92 06/06→07/11				
1.8 TDCi	85 04/05→09/12				
2.0	107 04/05→07/11				
2.0 TDCi	81 - 04/05→09/12				
	100				
1.6	81 03/10→		Required quantity: 2;	2	11.8116-0356.1 390586 Brake System: ATE
1.6 Flex	85 01/10→09/13		Fitting Position: Front Axle		
1.8 Flexifuel	96 12/05→01/08		Construction year from: 01/06 →; Required quantity: 2; Fitting Position: Front Axle	2	11.8116-0356.1 390586 Brake System: ATE
Guide Sleeve Kit, brake caliper					
1.4	59 04/05→09/12		→ Construction year to: 02/11;		11.0101-5407.2 260011 Brake System: ATE
1.6	74 04/05→09/12		Fitting Position: Front Axle		
1.6 TDCi	66 - 04/05→09/12		→ Construction year to: 02/11; Fitting Position: Rear Axle		11.0101-5407.2 260011 Brake System: ATE
1.6 Ti	85 04/05→09/12				
1.8	92 03/06→09/12				
1.8 Flexifuel	92 06/06→07/11				
1.8 TDCi	85 04/05→09/12				
2.0	107 04/05→07/11				
2.0 TDCi	81 - 04/05→09/12				
	100				
1.6	81 03/10→		Fitting Position: Front Axle		11.0101-5407.2 260011 Brake System: ATE
1.6 Flex	85 01/10→09/13		Fitting Position: Rear Axle		11.0101-5407.2 260011 Brake System: ATE
1.8 Flexifuel	96 12/05→01/08		Construction year from: 01/06 →; Fitting Position: Front Axle		11.0101-5407.2 260011 Brake System: ATE
			Construction year from: 01/06 →; Fitting Position: Rear Axle		11.0101-5407.2 260011 Brake System: ATE
Guide Bolt, brake caliper					
1.4	59 04/05→09/12		→ Construction year to: 02/11;	2	11.8171-0008.1 990049 Brake System: ATE
1.6	74 04/05→09/12		Required quantity: 2		
1.6 TDCi	66 - 04/05→09/12				
	80				
1.6 Ti	85 04/05→09/12				
1.8	92 03/06→09/12				
1.8 Flexifuel	92 06/06→07/11				
1.8 TDCi	85 04/05→09/12				
2.0	107 04/05→07/11				
2.0 TDCi	81 - 04/05→09/12				
	100				
1.6	81 03/10→		Required quantity: 2	2	11.8171-0008.1 990049 Brake System: ATE
1.6 Flex	85 01/10→09/13				
1.8 Flexifuel	96 12/05→01/08		Construction year from: 01/06 →; Required quantity: 2	2	11.8171-0008.1 990049 Brake System: ATE

	kW				
FORD - FOCUS II Turnier (DA_, FFS, DS) 07/04→09/12					
Spring, brake caliper					
1.4	59	07/04→09/12	Construction year from: 10/04 → → Construction year to: 02/11; Required quantity: 2; Fitting Position: Front Axle	2	11.8116-0356.1 390586 Brake System: ATE
1.6	74	07/04→07/11			
1.6 TDCi	74 - 07/04→09/12	80			
1.6 Ti	85	07/04→09/12			
2.0	107	07/04→09/12			
2.0 TDCi	100	07/04→09/12			
1.6 LPG	85	10/09→09/12	→ Construction year to: 02/11; Required quantity: 2; Fitting Position: Front Axle	2	11.8116-0356.1 390586 Brake System: ATE
1.6 TDCi	81	12/07→09/12			
1.8	92	03/06→09/12			
1.8 Flexifuel	92	01/06→09/12			
2.0 LPG	107	06/08→07/11			
2.0 TDCi	81	02/08→07/11			
1.6 TDCi	66	07/04→09/12	Construction year from: 01/05 → → Construction year to: 02/11; Required quantity: 2; Fitting Position: Front Axle	2	11.8116-0356.1 390586 Brake System: ATE
1.8 TDCi	85	07/04→09/12			
2.0 TDCi	98	07/04→01/08	Construction year from: 10/04 → ; Required quantity: 2; Fitting Position: Front Axle	2	11.8116-0356.1 390586 Brake System: ATE
Guide Sleeve Kit, brake caliper					
1.4	59	07/04→09/12	Construction year from: 10/04 → → Construction year to: 02/11; Fitting Position: Front Axle		11.0101-5407.2 260011 Brake System: ATE
1.6	74	07/04→07/11			
1.6 TDCi	74 - 07/04→09/12	80	Construction year from: 10/04 → → Construction year to: 02/11; Fitting Position: Rear Axle		11.0101-5407.2 260011 Brake System: ATE
1.6 Ti	85	07/04→09/12			
2.0	107	07/04→09/12	→ Construction year to: 02/11; Fitting Position: Front Axle		11.0101-5407.2 260011 Brake System: ATE
2.0 TDCi	100	07/04→09/12			
1.6 LPG	85	10/09→09/12			
1.6 TDCi	81	12/07→09/12			
1.8	92	03/06→09/12			
1.8 Flexifuel	92	01/06→09/12			
2.0 LPG	107	06/08→07/11	→ Construction year to: 02/11; Fitting Position: Rear Axle		11.0101-5407.2 260011 Brake System: ATE
2.0 TDCi	81	02/08→07/11			
1.6 TDCi	66	07/04→09/12	Construction year from: 01/05 → → Construction year to: 02/11; Fitting Position: Front Axle		11.0101-5407.2 260011 Brake System: ATE
1.8 TDCi	85	07/04→09/12			
			Construction year from: 01/05 → → Construction year to: 02/11; Fitting Position: Rear Axle		11.0101-5407.2 260011 Brake System: ATE
2.0 TDCi	98	07/04→01/08	Construction year from: 10/04 → ; Fitting Position: Front Axle		11.0101-5407.2 260011 Brake System: ATE
			Construction year from: 10/04 → ; Fitting Position: Rear Axle		11.0101-5407.2 260011 Brake System: ATE
Guide Bolt, brake caliper					
1.4	59	07/04→09/12	Construction year from: 10/04 → → Construction year to: 02/11; Required quantity: 2	2	11.8171-0008.1 990049 Brake System: ATE
1.6	74	07/04→07/11			
1.6 TDCi	74 - 07/04→09/12	80			
1.6 Ti	85	07/04→09/12			
2.0	107	07/04→09/12			
2.0 TDCi	100	07/04→09/12			
1.6 LPG	85	10/09→09/12	→ Construction year to: 02/11; Required quantity: 2	2	11.8171-0008.1 990049 Brake System: ATE
1.6 TDCi	81	12/07→09/12			
1.8	92	03/06→09/12			
1.8 Flexifuel	92	01/06→09/12			
2.0 LPG	107	06/08→07/11			
2.0 TDCi	81	02/08→07/11			
1.6 TDCi	66	07/04→09/12	Construction year from: 01/05 → → Construction year to: 02/11; Required quantity: 2	2	11.8171-0008.1 990049 Brake System: ATE
1.8 TDCi	85	07/04→09/12			
2.0 TDCi	98	07/04→01/08	Construction year from: 10/04 → ; Required quantity: 2	2	11.8171-0008.1 990049 Brake System: ATE
FORD - FOCUS III 07/10→					
Spring, brake caliper					
1.0 EcoBoost	74 - 02/12→12/17		Required quantity: 2	2	11.8116-0356.1 390586 Brake System: ATE
	92				
1.5 EcoBoost	110 - 09/14→12/17				
	134				
1.5 TDCi	70 - 09/14→12/17				
	88				
1.5 TDCi ECONetic	77	09/14→12/17			
1.6 Flexifuel	110	07/13→			
1.6 LPG	86 - 02/12→				
	88				
1.6 TDCi ECONetic	77	05/12→			
	→				

	kW				
FORD - FOCUS III 07/10→					
Spring, brake caliper					
1.6 Ti	63 - 08/11→12/17 88	Required quantity: 2	2	11.8116-0356.1 390586	Brake System: ATE
2.0	110 - 09/11→12/17 119				
2.0 TDCi	110 11/14→12/17				
2.0 TDCi ST	136 11/14→12/17				
2.0 Ti-GDi	125 08/11→				
Electric	107 07/13→12/17				
1.0 EcoBoost	103 10/17→06/19	Required quantity: 2; Fitting Position: Front Axle	2	11.8116-0356.1 390586	Brake System: ATE
1.6 EcoBoost	110 - 07/10→06/14 134	Construction year from: 03/11 →; Required quantity: 2	2	11.8116-0356.1 390586	Brake System: ATE
1.6 Flexifuel	88 07/10→				
1.6 TDCi	70 - 07/10→12/17 85				
1.6 Ti	77 - 07/10→05/18 92				
2.0 TDCi	85 - 07/10→06/14 120				
Guide Sleeve Kit, brake caliper					
1.0 EcoBoost	74 - 02/12→12/17 92	Fitting Position: Front Axle		11.0101-5407.2 260011	Brake System: ATE
1.5 EcoBoost	110 - 09/14→12/17 134	→ Construction year to: 05/17; Fitting Position: Rear Axle		11.0101-5407.2 260011	Brake System: ATE
1.5 TDCi	70 - 09/14→12/17 88				
1.5 TDCi ECONetic	77 09/14→12/17				
1.6 Flexifuel	110 07/13→				
1.6 LPG	86 - 02/12→ 88				
1.6 TDCi ECONetic	77 05/12→				
1.6 Ti	63 - 08/11→12/17 88				
2.0	110 - 09/11→12/17 119				
2.0 ST	184 07/12→12/17				
2.0 TDCi	110 11/14→12/17				
2.0 TDCi ST	136 11/14→12/17				
2.0 Ti-GDi	125 08/11→				
Electric	107 07/13→12/17				
1.0 EcoBoost	103 10/17→06/19	Fitting Position: Front Axle		11.0101-5407.2 260011	Brake System: ATE
		Fitting Position: Rear Axle		11.0101-5407.2 260011	Brake System: ATE
1.6 EcoBoost	110 - 07/10→06/14 134	Construction year from: 03/11 →; Fitting Position: Front Axle		11.0101-5407.2 260011	Brake System: ATE
2.0 TDCi	85 - 07/10→06/14 120	Construction year from: 03/11 →; Fitting Position: Rear Axle		11.0101-5407.2 260011	Brake System: ATE
1.6 Flexifuel	88 07/10→	Construction year from: 03/11 →; Fitting Position: Front Axle		11.0101-5407.2 260011	Brake System: ATE
1.6 TDCi	70 - 07/10→12/17 85	Construction year from: 03/11 → → Construction year to: 05/17; Fitting Position: Rear Axle		11.0101-5407.2 260011	Brake System: ATE
1.6 Ti	77 - 07/10→05/18 92				
2.3 RS AWD	257 07/15→	→ Construction year to: 05/17; Fitting Position: Rear Axle		11.0101-5407.2 260011	Brake System: ATE
Guide Bolt, brake caliper					
1.0 EcoBoost	74 - 02/12→12/17 92	→ Construction year to: 05/17; Required quantity: 2	2	11.8171-0008.1 990049	Brake System: ATE
1.5 EcoBoost	110 - 09/14→12/17 134	Required quantity: 2	2	11.8171-0008.1 990049	Brake System: ATE
1.5 TDCi	70 - 09/14→12/17 88				
1.5 TDCi ECONetic	77 09/14→12/17				
1.6 Flexifuel	110 07/13→				
1.6 LPG	86 - 02/12→ 88				
1.6 TDCi ECONetic	77 05/12→				
1.6 Ti	63 - 08/11→12/17 88				
2.0	110 - 09/11→12/17 119				
2.0 ST	184 07/12→12/17				
2.0 TDCi	110 11/14→12/17				
2.0 TDCi ST	136 11/14→12/17				
2.0 Ti-GDi	125 08/11→				
Electric	107 07/13→12/17				
1.0 EcoBoost	103 10/17→06/19	Required quantity: 2; Fitting Position: Front Axle	2	11.8171-0008.1 990049	Brake System: ATE
		Required quantity: 2; Fitting Position: Rear Axle	2	11.8171-0008.1 990049	Brake System: ATE
→					

	kW				
FORD - FOCUS III 07/10→					
Guide Bolt, brake caliper					
1.6 EcoBoost	110 - 07/10→06/14 134	Construction year from: 03/11 →; Required quantity: 2	2	11.8171-0008.1 990049	Brake System: ATE
2.0 TDCi	85 - 07/10→06/14 120				
1.6 Flexifuel	88 07/10→	Construction year from: 03/11 → →	2	11.8171-0008.1 990049	Brake System: ATE
1.6 TDCi	70 - 07/10→12/17 85	Construction year to: 05/17; Required quantity: 2			
1.6 Ti	77 - 07/10→05/18 92	Construction year from: 03/11 →; Required quantity: 2	2	11.8171-0008.1 990049	Brake System: ATE
2.3 RS AWD	257 07/15→	→ Construction year to: 05/17; Required quantity: 2	2	11.8171-0008.1 990049	Brake System: ATE
FORD - FOCUS III Estate Van 02/12→					
Spring, brake caliper					
1.0 EcoBoost	74 - 02/12→ 92	Required quantity: 2	2	11.8116-0356.1 390586	Brake System: ATE
1.5 EcoBoost	110 - 09/14→ 134				
1.5 TDCi	70 - 09/14→ 88				
1.5 TDCi ECONetic	77 09/14→				
2.0 TDCi	110 11/14→				
Guide Sleeve Kit, brake caliper					
1.0 EcoBoost	74 - 02/12→ 92	Fitting Position: Front Axle		11.0101-5407.2 260011	Brake System: ATE
1.5 EcoBoost	110 - 09/14→ 134	→ Construction year to: 05/17; Fitting Position: Rear Axle		11.0101-5407.2 260011	Brake System: ATE
1.5 TDCi	70 - 09/14→ 88				
1.5 TDCi ECONetic	77 09/14→				
2.0 TDCi	110 11/14→				
Guide Bolt, brake caliper					
1.0 EcoBoost	74 - 02/12→ 92	→ Construction year to: 05/17; Required quantity: 2	2	11.8171-0008.1 990049	Brake System: ATE
1.5 EcoBoost	110 - 09/14→ 134	Required quantity: 2	2	11.8171-0008.1 990049	Brake System: ATE
1.5 TDCi	70 - 09/14→ 88				
1.5 TDCi ECONetic	77 09/14→				
2.0 TDCi	110 11/14→				
FORD - FOCUS III Hatchback Van 01/11→					
Spring, brake caliper					
1.0 EcoBoost	74 - 02/12→ 92	Required quantity: 2	2	11.8116-0356.1 390586	Brake System: ATE
1.5 EcoBoost	110 - 09/14→ 134				
1.5 TDCi	70 - 09/14→ 88				
1.5 TDCi ECONetic	77 09/14→				
1.6 EcoBoost	110 - 11/11→06/14 134				
1.6 TDCi	85 02/12→				
2.0 TDCi	110 11/14→				
1.6 TDCi	70 01/11→	Construction year from: 03/11 →; Required quantity: 2	2	11.8116-0356.1 390586	Brake System: ATE
1.6 Ti	77 01/11→				
2.0 TDCi	85 - 01/11→06/14 120				
Guide Sleeve Kit, brake caliper					
1.0 EcoBoost	74 - 02/12→ 92	Fitting Position: Front Axle		11.0101-5407.2 260011	Brake System: ATE
1.5 EcoBoost	110 - 09/14→ 134	→ Construction year to: 05/17; Fitting Position: Rear Axle		11.0101-5407.2 260011	Brake System: ATE
1.5 TDCi	70 - 09/14→ 88				
1.5 TDCi ECONetic	77 09/14→				
1.6 TDCi	85 02/12→				
2.0 TDCi	110 11/14→				
1.6 EcoBoost	110 - 11/11→06/14 134	Fitting Position: Front Axle		11.0101-5407.2 260011	Brake System: ATE
		Fitting Position: Rear Axle		11.0101-5407.2 260011	Brake System: ATE
1.6 TDCi	70 01/11→	Construction year from: 03/11 →; Fitting Position: Front Axle		11.0101-5407.2 260011	Brake System: ATE
1.6 Ti	77 01/11→	Construction year from: 03/11 → → Construction year to: 05/17; Fitting Position: Rear Axle		11.0101-5407.2 260011	Brake System: ATE
→					

	kW				
FORD - FOCUS III Hatchback Van 01/11→					
Guide Sleeve Kit, brake caliper					
2.0 TDCi	85 - 01/11→06/14 120	Construction year from: 03/11 →; Fitting Position: Front Axle		11.0101-5407.2 260011	Brake System: ATE
		Construction year from: 03/11 →; Fitting Position: Rear Axle		11.0101-5407.2 260011	Brake System: ATE
Guide Bolt, brake caliper					
1.0 EcoBoost	74 - 02/12→ 92	→ Construction year to: 05/17; Required quantity: 2	2	11.8171-0008.1 990049	Brake System: ATE
1.5 EcoBoost	110 - 09/14→ 134	Required quantity: 2	2	11.8171-0008.1 990049	Brake System: ATE
1.5 TDCi	70 - 09/14→ 88				
1.5 TDCi ECONetic	77 09/14→				
1.6 TDCi	85 02/12→				
2.0 TDCi	110 11/14→				
1.6 EcoBoost	110 - 11/11→06/14 134	Required quantity: 2	2	11.8171-0008.1 990049	Brake System: ATE
1.6 TDCi	70 01/11→	Construction year from: 03/11 → →	2	11.8171-0008.1 990049	Brake System: ATE
1.6 Ti	77 01/11→	Construction year to: 05/17; Required quantity: 2			
		Construction year from: 03/11 →; Required quantity: 2	2	11.8171-0008.1 990049	Brake System: ATE
2.0 TDCi	85 - 01/11→06/14 120	Construction year from: 03/11 →; Required quantity: 2	2	11.8171-0008.1 990049	Brake System: ATE
FORD - FOCUS III Saloon 07/10→					
Spring, brake caliper					
1.0 EcoBoost	74 - 02/12→ 92	Required quantity: 2	2	11.8116-0356.1 390586	Brake System: ATE
1.5 EcoBoost	110 - 11/14→ 134				
1.5 TDCi	70 - 11/14→ 88				
1.5 TDCi ECONetic	77 11/14→				
1.6 Flexifuel	110 07/13→				
1.6 TDCi	77 05/12→				
1.6 Ti	63 08/11→				
2.0	110 10/13→				
2.0 GDi	125 08/11→				
2.0 TDCi	110 11/14→				
1.0 EcoBoost	103 10/17→	Required quantity: 2; Fitting Position: Front Axle	2	11.8116-0356.1 390586	Brake System: ATE
1.6 EcoBoost	110 - 07/10→ 134	Construction year from: 03/11 →; Required quantity: 2	2	11.8116-0356.1 390586	Brake System: ATE
1.6 Flexifuel	88 07/10→				
1.6 TDCi	70 - 07/10→ 85				
1.6 Ti	77 - 07/10→ 92				
2.0 TDCi	85 - 07/10→ 120				
Guide Sleeve Kit, brake caliper					
1.0 EcoBoost	74 - 02/12→ 92	Fitting Position: Front Axle		11.0101-5407.2 260011	Brake System: ATE
1.5 EcoBoost	110 - 11/14→ 134	→ Construction year to: 05/17; Fitting Position: Rear Axle		11.0101-5407.2 260011	Brake System: ATE
1.5 TDCi	70 - 11/14→ 88				
1.5 TDCi ECONetic	77 11/14→				
1.6 Flexifuel	110 07/13→				
1.6 TDCi	77 05/12→				
1.6 Ti	63 08/11→				
2.0	110 10/13→				
2.0 GDi	125 08/11→				
2.0 TDCi	110 11/14→				
1.0 EcoBoost	103 10/17→	Fitting Position: Front Axle		11.0101-5407.2 260011	Brake System: ATE
		Fitting Position: Rear Axle		11.0101-5407.2 260011	Brake System: ATE
1.6 EcoBoost	110 - 07/10→ 134	Construction year from: 03/11 →; Fitting Position: Front Axle		11.0101-5407.2 260011	Brake System: ATE
1.6 Flexifuel	88 07/10→				
1.6 TDCi	70 - 07/10→ 85	Construction year from: 03/11 → → Construction year to: 05/17; Fitting Position: Rear Axle		11.0101-5407.2 260011	Brake System: ATE
1.6 Ti	77 - 07/10→ 92				
2.0 TDCi	85 - 07/10→ 120				
→					

	kW				
FORD - FOCUS III Saloon 07/10→					
Guide Bolt, brake caliper					
1.0 EcoBoost	74 - 02/12→ 92		→ Construction year to: 05/17; Required quantity: 2	2	11.8171-0008.1 990049 Brake System: ATE
1.5 EcoBoost	110 - 11/14→ 134		Required quantity: 2	2	11.8171-0008.1 990049 Brake System: ATE
1.5 TDCi	70 - 11/14→ 88				
1.5 TDCi ECONetic	77 11/14→				
1.6 Flexifuel	110 07/13→				
1.6 TDCi	77 05/12→				
1.6 Ti	63 08/11→				
2.0	110 10/13→				
2.0 GDi	125 08/11→				
2.0 TDCi	110 11/14→				
1.0 EcoBoost	103 10/17→		Required quantity: 2; Fitting Position: Front Axle	2	11.8171-0008.1 990049 Brake System: ATE
			Required quantity: 2; Fitting Position: Rear Axle	2	11.8171-0008.1 990049 Brake System: ATE
1.6 EcoBoost	110 - 07/10→ 134		Construction year from: 03/11 → → Construction year to: 05/17; Required quantity: 2	2	11.8171-0008.1 990049 Brake System: ATE
1.6 Flexifuel	88 07/10→				
1.6 TDCi	70 - 07/10→ 85		Construction year from: 03/11 → →; Required quantity: 2	2	11.8171-0008.1 990049 Brake System: ATE
1.6 Ti	77 - 07/10→ 92				
2.0 TDCi	85 - 07/10→ 120				
FORD - FOCUS III Turnier 07/10→					
Spring, brake caliper					
1.0 EcoBoost	74 - 02/12→ 92		Required quantity: 2	2	11.8116-0356.1 390586 Brake System: ATE
1.5 EcoBoost	110 - 09/14→ 134				
1.5 TDCi	70 - 09/14→ 88				
1.5 TDCi ECONetic	77 09/14→				
1.6 Flexifuel	110 07/13→				
1.6 LPG	86 - 02/12→ 88				
1.6 TDCi ECONetic	77 05/12→				
1.6 Ti	63 - 08/11→ 88				
2.0	110 10/13→				
2.0 TDCi	110 11/14→				
2.0 TDCi ST	136 11/14→				
1.0 EcoBoost	103 10/17→		Required quantity: 2; Fitting Position: Front Axle	2	11.8116-0356.1 390586 Brake System: ATE
1.6 EcoBoost	110 - 07/10→ 134		Construction year from: 03/11 → →; Required quantity: 2	2	11.8116-0356.1 390586 Brake System: ATE
1.6 Flexifuel	88 07/10→				
1.6 TDCi	70 - 07/10→ 85				
1.6 Ti	77 - 07/10→ 92				
2.0 TDCi	85 - 07/10→ 120				
2.0 Ti-GDi	125 07/10→		Construction year from: 08/11 → →; Required quantity: 2	2	11.8116-0356.1 390586 Brake System: ATE
Guide Sleeve Kit, brake caliper					
1.0 EcoBoost	74 - 02/12→ 92		Fitting Position: Front Axle		11.0101-5407.2 260011 Brake System: ATE
1.5 EcoBoost	110 - 09/14→ 134		→ Construction year to: 05/17; Fitting Position: Rear Axle		11.0101-5407.2 260011 Brake System: ATE
1.5 TDCi	70 - 09/14→ 88				
1.5 TDCi ECONetic	77 09/14→				
1.6 Flexifuel	110 07/13→				
1.6 LPG	86 - 02/12→ 88				
1.6 TDCi ECONetic	77 05/12→				
1.6 Ti	63 - 08/11→ 88				
2.0	110 10/13→				
2.0 ST	184 07/12→				
2.0 TDCi	110 11/14→				
2.0 TDCi ST	136 11/14→				
1.0 EcoBoost	103 10/17→		Fitting Position: Front Axle		11.0101-5407.2 260011 Brake System: ATE
			Fitting Position: Rear Axle		11.0101-5407.2 260011 Brake System: ATE
→					

	kW				
FORD - FOCUS III Turnier 07/10→					
Guide Sleeve Kit, brake caliper					
1.6 EcoBoost	110 - 07/10→ 134		Construction year from: 03/11 →; Fitting Position: Front Axle	11.0101-5407.2 260011	Brake System: ATE
1.6 Flexifuel	88 07/10→		Construction year from: 03/11 → → Construction year to: 05/17; Fitting Position: Rear Axle	11.0101-5407.2 260011	Brake System: ATE
1.6 TDCi	70 - 07/10→ 85				
1.6 Ti	77 - 07/10→ 92				
2.0 TDCi	85 - 07/10→ 120				
2.0 Ti-GDi	125 07/10→		Construction year from: 08/11 →; Fitting Position: Front Axle	11.0101-5407.2 260011	Brake System: ATE
			Construction year from: 08/11 → → Construction year to: 05/17; Fitting Position: Rear Axle	11.0101-5407.2 260011	Brake System: ATE
Guide Bolt, brake caliper					
1.0 EcoBoost	74 - 02/12→ 92		→ Construction year to: 05/17; Required quantity: 2	2 11.8171-0008.1 990049	Brake System: ATE
1.5 EcoBoost	110 - 09/14→ 134		Required quantity: 2	2 11.8171-0008.1 990049	Brake System: ATE
1.5 TDCi	70 - 09/14→ 88				
1.5 TDCi ECONetic	77 09/14→				
1.6 Flexifuel	110 07/13→				
1.6 LPG	86 - 02/12→ 88				
1.6 TDCi ECONetic	77 05/12→				
1.6 Ti	63 - 08/11→ 88				
2.0	110 10/13→				
2.0 ST	184 07/12→				
2.0 TDCi	110 11/14→				
2.0 TDCi ST	136 11/14→				
1.0 EcoBoost	103 10/17→		Required quantity: 2; Fitting Position: Front Axle	2 11.8171-0008.1 990049	Brake System: ATE
			Required quantity: 2; Fitting Position: Rear Axle	2 11.8171-0008.1 990049	Brake System: ATE
1.6 EcoBoost	110 - 07/10→ 134		Construction year from: 03/11 → → Construction year to: 05/17; Required quantity: 2	2 11.8171-0008.1 990049	Brake System: ATE
1.6 Flexifuel	88 07/10→				
1.6 TDCi	70 - 07/10→ 85		Construction year from: 03/11 →; Required quantity: 2	2 11.8171-0008.1 990049	Brake System: ATE
1.6 Ti	77 - 07/10→ 92				
2.0 TDCi	85 - 07/10→ 120				
2.0 Ti-GDi	125 07/10→		Construction year from: 08/11 → → Construction year to: 05/17; Required quantity: 2	2 11.8171-0008.1 990049	Brake System: ATE
			Construction year from: 08/11 →; Required quantity: 2	2 11.8171-0008.1 990049	Brake System: ATE
FORD - FOCUS IV (HN) 01/18→					
Spring, brake caliper					
1.0 EcoBoost	63 - 01/18→ 92		Required quantity: 2; Fitting Position: Front Axle	2 11.8116-0356.1 390586	Brake System: ATE
1.5 EcoBlue	70 - 01/18→ 88				
2.0 EcoBlue	110 01/18→				
Guide Sleeve Kit, brake caliper					
1.0 EcoBoost	63 - 01/18→ 92		Fitting Position: Front Axle	11.0101-5407.2 260011	Brake System: ATE
1.5 EcoBlue	70 - 01/18→ 88		Vehicle Equipment: for vehicles without electric parking brake;	11.0101-5407.2 260011	Brake System: ATE
2.0 EcoBlue	110 01/18→		Fitting Position: Rear Axle		
Guide Bolt, brake caliper					
1.0 EcoBoost	63 - 01/18→ 92		Required quantity: 2; Fitting Position: Front Axle	2 11.8171-0008.1 990049	Brake System: ATE
1.5 EcoBlue	70 - 01/18→ 88		Vehicle Equipment: for vehicles without electric parking brake;	2 11.8171-0008.1 990049	Brake System: ATE
2.0 EcoBlue	110 01/18→		Required quantity: 2; Fitting Position: Rear Axle		
FORD - FOCUS IV Saloon (HM) 11/18→					
Spring, brake caliper					
1.0 EcoBoost	74 - 11/18→ 92		Required quantity: 2; Fitting Position: Front Axle	2 11.8116-0356.1 390586	Brake System: ATE
→					

	kW				
FORD - FOCUS IV Saloon (HM) 11/18→					
Spring, brake caliper					
1.5 EcoBlue	70 11/18→	Required quantity: 2; Fitting Position: Front Axle	2	11.8116-0356.1 390586	Brake System: ATE
Guide Sleeve Kit, brake caliper					
1.0 EcoBoost	74 - 11/18→	Fitting Position: Front Axle		11.0101-5407.2 260011	Brake System: ATE
1.5 EcoBlue	92 70 11/18→	Vehicle Equipment: for vehicles without electric parking brake; Fitting Position: Rear Axle		11.0101-5407.2 260011	Brake System: ATE
Guide Bolt, brake caliper					
1.0 EcoBoost	74 - 11/18→	Required quantity: 2; Fitting Position: Front Axle	2	11.8171-0008.1 990049	Brake System: ATE
1.5 EcoBlue	92 70 11/18→	Vehicle Equipment: for vehicles without electric parking brake; Required quantity: 2; Fitting Position: Rear Axle	2	11.8171-0008.1 990049	Brake System: ATE
FORD - FOCUS IV Turnier (HP) 09/18→					
Spring, brake caliper					
1.0 EcoBoost	63 - 09/18→	Required quantity: 2; Fitting Position: Front Axle	2	11.8116-0356.1 390586	Brake System: ATE
1.5 EcoBlue	92 70 - 09/18→				
1.5 Ti-VCT	88 90 09/18→				
2.0 EcoBlue	110 09/18→				
Guide Sleeve Kit, brake caliper					
1.0 EcoBoost	63 - 09/18→	Fitting Position: Front Axle		11.0101-5407.2 260011	Brake System: ATE
1.5 EcoBlue	92 70 - 09/18→	Vehicle Equipment: for vehicles without electric parking brake; Fitting Position: Rear Axle		11.0101-5407.2 260011	Brake System: ATE
1.5 Ti-VCT	88 90 09/18→				
2.0 EcoBlue	110 09/18→				
Guide Bolt, brake caliper					
1.0 EcoBoost	63 - 09/18→	Required quantity: 2; Fitting Position: Front Axle	2	11.8171-0008.1 990049	Brake System: ATE
1.5 EcoBlue	92 70 - 09/18→	Vehicle Equipment: for vehicles without electric parking brake; Required quantity: 2; Fitting Position: Rear Axle	2	11.8171-0008.1 990049	Brake System: ATE
1.5 Ti-VCT	88 90 09/18→				
2.0 EcoBlue	110 09/18→				
FORD - FOCUS C-MAX (DM2) 10/03→03/07					
Spring, brake caliper					
1.6	74 10/03→03/07	Required quantity: 2; Fitting Position: Front Axle	2	11.8116-0356.1 390586	Brake System: ATE
1.6 TDCi	66 - 10/03→03/07				
1.6 Ti	80 85 08/04→03/07				
1.8	88 - 10/03→03/07				
1.8 Flexifuel	92 92 01/06→03/07				
1.8 TDCi	85 01/05→03/07				
2.0 TDCi	98 - 10/03→03/07				
2.0	100 107 03/04→03/07	Construction year from: 04/04 →; Required quantity: 2; Fitting Position: Front Axle	2	11.8116-0356.1 390586	Brake System: ATE
Guide Sleeve Kit, brake caliper					
1.6	74 10/03→03/07	Fitting Position: Front Axle		11.0101-5407.2 260011	Brake System: ATE
1.6 TDCi	66 - 10/03→03/07	Fitting Position: Rear Axle		11.0101-5407.2 260011	Brake System: ATE
1.6 Ti	80 85 08/04→03/07				
1.8	88 - 10/03→03/07				
1.8 Flexifuel	92 92 01/06→03/07				
1.8 TDCi	85 01/05→03/07				
2.0 TDCi	98 - 10/03→03/07				
2.0	100 107 03/04→03/07	Construction year from: 04/04 →; Fitting Position: Front Axle		11.0101-5407.2 260011	Brake System: ATE
		Construction year from: 04/04 →; Fitting Position: Rear Axle		11.0101-5407.2 260011	Brake System: ATE
Guide Bolt, brake caliper					
1.6	74 10/03→03/07	Required quantity: 2	2	11.8171-0008.1 990049	Brake System: ATE
1.6 TDCi	66 - 10/03→03/07				
→	80				

	kW				
FORD - FOCUS C-MAX (DM2) 10/03→03/07					
Guide Bolt, brake caliper					
1.6 Ti 1.8	85 08/04→03/07 88 - 10/03→03/07 92	Required quantity: 2	2	11.8171-0008.1 990049	Brake System: ATE
1.8 Flexifuel 1.8 TDCi 2.0 TDCi	92 01/06→03/07 85 01/05→03/07 98 - 10/03→03/07 100				
2.0	107 03/04→03/07	Construction year from: 04/04 →; Required quantity: 2	2	11.8171-0008.1 990049	Brake System: ATE
FORD - FUSION (JU_) 08/02→12/12					
Guide Sleeve Kit, brake caliper					
1.25 1.4	55 08/04→12/12 59 08/02→12/12	→ Construction year to: 09/12; Fitting Position: Front Axle		11.0101-5407.2 260011	Brake System: ATE
1.4 LPG 1.4 TDCi 1.6 TDCi	59 01/10→12/12 50 08/02→12/12 66 11/04→12/12				
1.3 1.6	44 11/02→07/05 74 08/02→11/09	Fitting Position: Front Axle		11.0101-5407.2 260011	Brake System: ATE
Guide Bolt, brake caliper					
1.25 1.4	55 08/04→12/12 59 08/02→12/12	→ Construction year to: 09/12; Required quantity: 2	2	11.8171-0008.1 990049	Brake System: ATE
1.4 LPG 1.4 TDCi 1.6 TDCi	59 01/10→12/12 50 08/02→12/12 66 11/04→12/12				
1.3 1.6	44 11/02→07/05 74 08/02→11/09	Required quantity: 2	2	11.8171-0008.1 990049	Brake System: ATE
FORD - GALAXY I (WGR) 03/95→05/06					
Guide Sleeve Kit, brake caliper					
1.9 TDI	66 03/95→05/06	Construction year from: 01/96 → → Construction year to: 04/01; Fitting Position: Front Axle		11.0101-5407.2 260011	Brake System: ATE
		Construction year from: 05/01 → → Construction year to: 04/06; Fitting Position: Front Axle		11.0101-5407.2 260011	Brake System: ATE
1.9 TDI	81 08/97→04/00	Construction year from: 10/97 →; Fitting Position: Front Axle		11.0101-5407.2 260011	Brake System: ATE
1.9 TDI 2.0 i 2.3 16V	85 04/00→05/06 85 11/95→05/06 107 01/97→05/06	Construction year from: 05/01 → → Construction year to: 04/06; Fitting Position: Front Axle		11.0101-5407.2 260011	Brake System: ATE
		→ Construction year to: 04/01; Fitting Position: Front Axle		11.0101-5407.2 260011	Brake System: ATE
1.9 TDI 2.3 16V	96 02/03→05/06 103 09/01→05/06	→ Construction year to: 04/06; Fitting Position: Front Axle		11.0101-5407.2 260011	Brake System: ATE
1.9 TDI 2.8 i V6 2.8 i V6 4x4	110 05/05→05/06 128 11/95→04/00 128 04/96→04/00	Fitting Position: Front Axle		11.0101-5407.2 260011	Brake System: ATE
Guide Bolt, brake caliper					
1.9 TDI	66 03/95→05/06	Construction year from: 01/96 → → Construction year to: 04/01; Required quantity: 2	2	11.8171-0008.1 990049	Brake System: ATE
		Construction year from: 05/01 → → Construction year to: 04/06; Required quantity: 2	2	11.8171-0008.1 990049	Brake System: ATE
1.9 TDI	81 08/97→04/00	Construction year from: 10/97 →; Required quantity: 2	2	11.8171-0008.1 990049	Brake System: ATE
1.9 TDI 2.0 i 2.3 16V	85 04/00→05/06 85 11/95→05/06 107 01/97→05/06	Construction year from: 05/01 → → Construction year to: 04/06; Required quantity: 2	2	11.8171-0008.1 990049	Brake System: ATE
		→ Construction year to: 04/01; Required quantity: 2	2	11.8171-0008.1 990049	Brake System: ATE
1.9 TDI 2.3 16V	96 02/03→05/06 103 09/01→05/06	→ Construction year to: 04/06; Required quantity: 2	2	11.8171-0008.1 990049	Brake System: ATE
1.9 TDI 2.8 i V6 2.8 i V6 4x4	110 05/05→05/06 128 11/95→04/00 128 04/96→04/00	Required quantity: 2	2	11.8171-0008.1 990049	Brake System: ATE
FORD - GALAXY II (WA6) 05/06→06/15					
Guide Sleeve Kit, brake caliper					
1.6 TDCi 1.8 TDCi	85 02/11→06/15 74 - 05/06→06/15 92	Fitting Position: Front Axle		11.0101-5407.2 260011	Brake System: ATE
2.0 2.0 Flexifuel →	107 05/06→06/15 107 05/06→06/15				

	kW				
FORD - GALAXY II (WA6) 05/06→06/15					
Guide Sleeve Kit, brake caliper					
2.0 TDCi	85 - 05/06→06/15 120	Fitting Position: Front Axle		11.0101-5407.2 260011	Brake System: ATE
2.3	118 09/07→06/15				
Guide Bolt, brake caliper					
1.6 EcoBoost	118 11/10→06/15	Construction year from: 02/11 →; Required quantity: 2	2	11.8171-0008.1 990049	Brake System: ATE
1.6 TDCi	85 02/11→06/15	Required quantity: 2	2	11.8171-0008.1 990049	Brake System: ATE
1.8 TDCi	74 - 05/06→06/15 92				
2.0	107 05/06→06/15				
2.0 EcoBoost	146 - 03/10→06/15 149				
2.0 Flexifuel	107 05/06→06/15				
2.0 TDCi	85 - 05/06→06/15 120				
2.2 TDCi	147 11/10→06/15				
2.3	118 09/07→06/15				
2.2 TDCi	129 03/08→12/12	Construction year from: 04/08 → → Construction year to: 10/08; Required quantity: 2	2	11.8171-0008.1 990049	Brake System: ATE
		Construction year from: 11/08 →; Required quantity: 2	2	11.8171-0008.1 990049	Brake System: ATE
FORD - GALAXY MK I VAN (WGR) 03/95→05/06					
Guide Sleeve Kit, brake caliper					
2.3	103 11/02→03/06	Fitting Position: Front Axle		11.0101-5407.2 260011	Brake System: ATE
Guide Bolt, brake caliper					
2.3	103 11/02→03/06	Required quantity: 2	2	11.8171-0008.1 990049	Brake System: ATE
FORD - GALAXY MK II VAN (WA6) 05/06→06/15					
Guide Sleeve Kit, brake caliper					
2.0 TDCi	107 05/06→06/15 85 - 05/06→06/15 120	Fitting Position: Front Axle		11.0101-5407.2 260011	Brake System: ATE
Guide Bolt, brake caliper					
2.0	107 05/06→06/15	Required quantity: 2	2	11.8171-0008.1 990049	Brake System: ATE
2.0 EcoBoost	149 03/10→06/15				
EcoBoost	118 02/11→06/15				
TDCi	85 - 05/06→06/15 147				
TDCi	85 01/07→06/15	Construction year from: 02/11 →; Required quantity: 2	2	11.8171-0008.1 990049	Brake System: ATE
FORD - GRAND C-MAX (DXA/CB7, DXA/CEU) 12/10→06/19					
Spring, brake caliper					
1.0 EcoBoost	74 - 10/12→06/19 92	Required quantity: 2	2	11.8116-0356.1 390586	Brake System: ATE
1.5 EcoBoost	110 - 03/15→06/19 134				
1.5 TDCi	70 - 03/15→06/19 88				
1.6 EcoBoost	110 - 12/10→06/19 134				
1.6 TDCi	70 - 12/10→06/19 85				
1.6 Ti	63 - 12/10→06/19 92				
2.0 TDCi	85 - 12/10→06/19 125				
Guide Sleeve Kit, brake caliper					
1.0 EcoBoost	74 - 10/12→06/19 92	Fitting Position: Front Axle		11.0101-5407.2 260011	Brake System: ATE
1.5 EcoBoost	110 - 03/15→06/19 134				
1.5 TDCi	70 - 03/15→06/19 88				
1.6 EcoBoost	110 - 12/10→06/19 134				
1.6 TDCi	70 - 12/10→06/19 85				
1.6 Ti	63 - 12/10→06/19 92				
2.0 TDCi	85 - 12/10→06/19 125				
→					

	kW				
FORD - GRAND C-MAX (DXA/CB7, DXA/CEU) 12/10→06/19					
Guide Bolt, brake caliper					
1.0 EcoBoost	74 - 10/12→06/19 92	Required quantity: 2	2	11.8171-0008.1 990049	Brake System: ATE
1.5 EcoBoost	110 - 03/15→06/19 134				
1.5 TDCi	70 - 03/15→06/19 88				
1.6 EcoBoost	110 - 12/10→06/19 134				
1.6 TDCi	70 - 12/10→06/19 85				
1.6 Ti	63 - 12/10→06/19 92				
2.0 TDCi	85 - 12/10→06/19 125				
FORD - GRAND C-MAX Van 12/10→06/19					
Spring, brake caliper					
1.0 EcoBoost	74 - 10/12→06/19 92	Required quantity: 2	2	11.8116-0356.1 390586	Brake System: ATE
1.5 EcoBoost	110 03/15→06/19				
1.5 TDCi	88 03/15→06/19				
1.6 EcoBoost	110 - 12/10→06/19 134				
1.6 TDCi	70 - 12/10→06/19 85				
1.6 Ti	92 12/10→12/14				
2.0 TDCi	103 - 12/10→06/19 125				
2.0 TDCI	85 02/11→06/19				
Guide Sleeve Kit, brake caliper					
1.0 EcoBoost	74 - 10/12→06/19 92	Fitting Position: Front Axle		11.0101-5407.2 260011	Brake System: ATE
1.5 EcoBoost	110 03/15→06/19				
1.5 TDCi	88 03/15→06/19				
1.6 EcoBoost	110 - 12/10→06/19 134				
1.6 TDCi	70 - 12/10→06/19 85				
1.6 Ti	92 12/10→12/14				
2.0 TDCi	103 - 12/10→06/19 125				
2.0 TDCI	85 02/11→06/19				
Guide Bolt, brake caliper					
1.0 EcoBoost	74 - 10/12→06/19 92	Required quantity: 2	2	11.8171-0008.1 990049	Brake System: ATE
1.5 EcoBoost	110 03/15→06/19				
1.5 TDCi	88 03/15→06/19				
1.6 EcoBoost	110 - 12/10→06/19 134				
1.6 TDCi	70 - 12/10→06/19 85				
1.6 Ti	92 12/10→12/14				
2.0 TDCi	103 - 12/10→06/19 125				
2.0 TDCI	85 02/11→06/19				
FORD - KA (RB_) 09/96→11/08					
Guide Sleeve Kit, brake caliper					
1.0 i	38 07/97→09/99	Fitting Position: Front Axle		11.0101-5407.2 260011	Brake System: ATE
1.3 i ROCAM	51 08/02→11/08				
1.6 i	71 11/05→09/08				
1.0 i	48 09/99→11/08	→ Construction year to: 01/00;		11.0101-5407.2 260011	Brake System: ATE
1.3 i	36 06/98→11/08	Fitting Position: Front Axle			
		Construction year from: 02/00 →;		11.0101-5407.2 260011	Brake System: ATE
		Fitting Position: Front Axle			
1.3 i	37 - 09/96→11/08 44	Construction year from: 11/96 → → Construction year to: 01/00;		11.0101-5407.2 260011	Brake System: ATE
		Fitting Position: Front Axle			
		Construction year from: 02/00 →;		11.0101-5407.2 260011	Brake System: ATE
		Fitting Position: Front Axle			
1.6 i	70 02/01→11/08	Construction year from: 08/03 →;		11.0101-5407.2 260011	Brake System: ATE
		Fitting Position: Front Axle			
Guide Bolt, brake caliper					
1.0 i	38 07/97→09/99	Required quantity: 2;	2	11.8171-0008.1 990049	Brake System: ATE
1.3 i ROCAM	51 08/02→11/08	Fitting Position: Front Axle			
→					

	kW				
FORD - KUGA II (DM2) 05/12→					
Spring, brake caliper					
1.6 EcoBoost 4x4 2.5	110 03/13→09/14 110 - 09/13→ 125	Required quantity: 2; Fitting Position: Front Axle	2	11.8116-0356.1 390586	Brake System: ATE
Guide Sleeve Kit, brake caliper					
1.5 EcoBoost	88 - 09/14→ 134	Fitting Position: Front Axle		11.0101-5407.2 260011	Brake System: ATE
1.5 EcoBoost 4x4	110 - 09/14→ 134	Vehicle Equipment: for vehicles without electric parking brake; Fitting Position: Rear Axle		11.0101-5407.2 260011	Brake System: ATE
1.5 TDCi	88 07/16→06/19				
1.6 EcoBoost	110 03/13→09/14				
1.6 EcoBoost 4x4	110 - 10/12→04/15 134				
2.0 TDCi	85 - 03/13→ 110				
2.0 TDCi 4x4	100 - 03/13→ 132				
2.5	110 - 09/13→ 125				
Guide Bolt, brake caliper					
1.5 EcoBoost	88 - 09/14→ 134	Required quantity: 2	2	11.8171-0008.1 990049	Brake System: ATE
1.5 EcoBoost 4x4	110 - 09/14→ 134	Vehicle Equipment: for vehicles without electric parking brake; Required quantity: 2	2	11.8171-0008.1 990049	Brake System: ATE
1.5 TDCi	88 07/16→06/19				
1.6 EcoBoost	110 03/13→09/14				
1.6 EcoBoost 4x4	110 - 10/12→04/15 134				
2.0 TDCi	85 - 03/13→ 110				
2.0 TDCi 4x4	100 - 03/13→ 132				
2.5	110 - 09/13→ 125				
 Brake Hose					
1.5 EcoBoost	88 - 09/14→ 134	Required quantity: 2; Vehicle Equipment: for vehicles with electric parking brake; Fitting Position: Rear Axle	2	24.5296-0540.3 331645	Length [mm]: 540
1.5 EcoBoost 4x4	110 - 09/14→ 134				
1.5 TDCi	88 07/16→06/19				
1.6 EcoBoost	110 03/13→09/14				
1.6 EcoBoost 4x4	110 - 10/12→04/15 134				
2.0 4x4	179 03/13→06/16				
2.0 EcoBoost 4x4	169 - 08/17→ 178				
2.0 TDCi	85 - 03/13→ 110				
2.0 TDCi 4x4	100 - 03/13→ 132				
2.5	110 01/14→				
1.5 EcoBoost 4x4	129 08/18→06/19	Required quantity: 2; Fitting Position: Rear Axle	2	24.5296-0540.3 331645	Length [mm]: 540
1.5 EcoBoost E85	110 02/19→11/19				
2.5	125 09/13→	Construction year from: 01/14 →; Required quantity: 2; Vehicle Equipment: for vehicles with electric parking brake; Fitting Position: Rear Axle	2	24.5296-0540.3 331645	Length [mm]: 540
FORD - KUGA II VAN 05/12→					
Spring, brake caliper					
1.5 EcoBoost	88 - 09/14→ 110	Required quantity: 2; Fitting Position: Front Axle	2	11.8116-0356.1 390586	Brake System: ATE
1.5 EcoBoost 4x4	129 06/19→				
Guide Sleeve Kit, brake caliper					
1.5 EcoBoost	88 - 09/14→ 110	Fitting Position: Front Axle		11.0101-5407.2 260011	Brake System: ATE
1.5 EcoBoost 4x4	129 - 09/14→ 134	Vehicle Equipment: for vehicles without electric parking brake; Fitting Position: Rear Axle		11.0101-5407.2 260011	Brake System: ATE
1.5 TDCi	88 01/19→				
2.0 TDCi	88 - 09/14→ 110				
2.0 TDCi 4x4	110 - 09/14→ 132				
→					

	kW				
FORD - KUGA II VAN 05/12→					
Guide Bolt, brake caliper					
1.5 EcoBoost	88 - 09/14→ 110		Required quantity: 2	2	11.8171-0008.1 990049 Brake System: ATE
1.5 EcoBoost 4x4	129 - 09/14→ 134		Vehicle Equipment: for vehicles without electric parking brake; Required quantity: 2	2	11.8171-0008.1 990049 Brake System: ATE
1.5 TDCi	88 01/19→				
2.0 TDCi	88 - 09/14→ 110				
2.0 TDCi 4x4	110 - 09/14→ 132				
 Brake Hose					
1.5 EcoBoost	88 06/19→		Required quantity: 2;	2	24.5296-0540.3 331645 Length [mm]: 540
1.5 EcoBoost 4x4	129 06/19→		Fitting Position: Rear Axle		
1.5 EcoBoost	110 09/14→		Required quantity: 2;	2	24.5296-0540.3 331645 Length [mm]: 540
1.5 EcoBoost 4x4	134 09/14→		Vehicle Equipment: for vehicles with electric parking brake;		
1.5 TDCi	88 01/19→		Fitting Position: Rear Axle		
2.0 TDCi	88 - 09/14→ 110				
2.0 TDCi 4x4	110 - 09/14→ 132				
FORD - KUGA III (DFK) 07/19→					
Spring, brake caliper					
1.5 EcoBoost	134 09/19→		Required quantity: 2; Fitting Position: Front Axle	2	11.8116-0356.1 390586 Brake System: ATE
FORD - MONDEO I (GBP) 02/93→08/96					
Guide Sleeve Kit, brake caliper					
1.6 i 16V	65 - 02/93→08/96 66		Fitting Position: Front Axle		11.0101-5407.2 260011 Brake System: ATE
1.8 i 16V	82 - 02/93→08/96 85				
1.8 i 16V 4x4	85 02/93→08/96				
1.8 TD	65 - 06/93→08/96 66				
2.0 i 16V	97 - 02/93→08/96 100				
2.0 i 16V 4x4	97 - 04/93→08/96 100				
2.5 i 24V	125 07/94→08/96		Construction year from: 08/94 →; Fitting Position: Front Axle		11.0101-5407.2 260011 Brake System: ATE
Guide Bolt, brake caliper					
1.6 i 16V	65 - 02/93→08/96 66		Required quantity: 2; Fitting Position: Front Axle	2	11.8171-0008.1 990049 Brake System: ATE
1.8 i 16V	82 - 02/93→08/96 85				
1.8 i 16V 4x4	85 02/93→08/96				
1.8 TD	65 - 06/93→08/96 66				
2.0 i 16V	97 - 02/93→08/96 100				
2.0 i 16V 4x4	97 - 04/93→08/96 100				
2.5 i 24V	125 07/94→08/96		Construction year from: 08/94 →; Required quantity: 2; Fitting Position: Front Axle	2	11.8171-0008.1 990049 Brake System: ATE
FORD - MONDEO I Saloon (GBP) 01/93→08/96					
Guide Sleeve Kit, brake caliper					
1.6 i 16V	65 - 02/93→08/96 66		Fitting Position: Front Axle		11.0101-5407.2 260011 Brake System: ATE
1.8 4x4	85 02/93→08/96				
1.8 i 16V	82 - 02/93→08/96 85				
1.8 TD	65 - 06/93→08/96 66				
2.0 i 16V	100 02/93→08/96				
2.0 i 16V 4x4	97 12/94→08/96				
2.0 i 16V 4x4	100 02/93→08/96		Construction year from: 04/93 →; Fitting Position: Front Axle		11.0101-5407.2 260011 Brake System: ATE
2.5 i 24V	125 07/94→08/96		Construction year from: 08/94 →; Fitting Position: Front Axle		11.0101-5407.2 260011 Brake System: ATE
Guide Bolt, brake caliper					
1.6 i 16V	65 - 02/93→08/96 66		Required quantity: 2; Fitting Position: Front Axle	2	11.8171-0008.1 990049 Brake System: ATE
1.8 4x4 →	85 02/93→08/96				

	kW				
FORD - MONDEO I Saloon (GBP) 01/93→08/96					
Guide Bolt, brake caliper					
1.8 i 16V	82 - 02/93→08/96 85	Required quantity: 2; Fitting Position: Front Axle	2	11.8171-0008.1 990049	Brake System: ATE
1.8 TD	65 - 06/93→08/96 66				
2.0 i 16V	100 02/93→08/96				
2.0 i 16V 4x4	97 12/94→08/96				
2.0 i 16V 4x4	100 02/93→08/96	Construction year from: 04/93 →; Required quantity: 2; Fitting Position: Front Axle	2	11.8171-0008.1 990049	Brake System: ATE
2.5 i 24V	125 07/94→08/96	Construction year from: 08/94 →; Required quantity: 2; Fitting Position: Front Axle	2	11.8171-0008.1 990049	Brake System: ATE
FORD - MONDEO I Turnier (BNP) 01/93→08/96					
Guide Sleeve Kit, brake caliper					
1.6 i 16V	65 - 04/93→08/96 66	Fitting Position: Front Axle		11.0101-5407.2 260011	Brake System: ATE
1.8 i 16V	82 - 04/93→08/96 85				
1.8 i 16V 4x4	85 04/93→08/96				
1.8 TD	65 - 06/93→08/96 66				
2.0 i 16V	97 - 01/93→08/96 100				
2.0 i 16V 4x4	97 - 04/93→08/96 100				
2.5 i 24V	125 07/94→08/96	Construction year from: 08/94 →; Fitting Position: Front Axle		11.0101-5407.2 260011	Brake System: ATE
Guide Bolt, brake caliper					
1.6 i 16V	65 - 04/93→08/96 66	Required quantity: 2; Fitting Position: Front Axle	2	11.8171-0008.1 990049	Brake System: ATE
1.8 i 16V	82 - 04/93→08/96 85				
1.8 i 16V 4x4	85 04/93→08/96				
1.8 TD	65 - 06/93→08/96 66				
2.0 i 16V	97 - 01/93→08/96 100				
2.0 i 16V 4x4	97 - 04/93→08/96 100				
2.5 i 24V	125 07/94→08/96	Construction year from: 08/94 →; Required quantity: 2; Fitting Position: Front Axle	2	11.8171-0008.1 990049	Brake System: ATE
FORD - MONDEO II (BAP) 08/96→09/00					
Guide Sleeve Kit, brake caliper					
1.6 i	66 08/96→09/00	Construction year from: 10/96 →; Fitting Position: Front Axle		11.0101-5407.2 260011	Brake System: ATE
1.8 i	85 08/96→09/00				
1.8 TD	66 08/96→09/00				
2.0 i	96 08/96→09/00				
1.6 i 16V	70 05/98→09/00	Fitting Position: Front Axle		11.0101-5407.2 260011	Brake System: ATE
2.5 24V	125 06/00→09/00				
2.5 ST 200	151 05/99→09/00				
2.5 24V	125 08/96→09/00	Construction year from: 10/96 → → Construction year to: 11/97; Fitting Position: Front Axle		11.0101-5407.2 260011	Brake System: ATE
		Construction year from: 12/97 →; Fitting Position: Front Axle		11.0101-5407.2 260011	Brake System: ATE
Guide Bolt, brake caliper					
1.6 i	66 08/96→09/00	Construction year from: 10/96 →;	2	11.8171-0008.1 990049	Brake System: ATE
1.8 i	85 08/96→09/00	Required quantity: 2;			
1.8 TD	66 08/96→09/00	Fitting Position: Front Axle			
2.0 i	96 08/96→09/00				
1.6 i 16V	70 05/98→09/00	Required quantity: 2;	2	11.8171-0008.1 990049	Brake System: ATE
2.5 24V	125 06/00→09/00	Fitting Position: Front Axle			
2.5 ST 200	151 05/99→09/00				
2.5 24V	125 08/96→09/00	Construction year from: 10/96 → → Construction year to: 11/97; Required quantity: 2; Fitting Position: Front Axle	2	11.8171-0008.1 990049	Brake System: ATE
		Construction year from: 12/97 →; Required quantity: 2; Fitting Position: Front Axle	2	11.8171-0008.1 990049	Brake System: ATE

	kW							
FORD - MONDEO II Saloon (BFP) 08/96→09/00								
Guide Sleeve Kit, brake caliper								
1.6 i	66 08/96→09/00	Construction year from: 10/96 →; Fitting Position: Front Axle	11.0101-5407.2 260011	Brake System: ATE				
1.8 i	85 08/96→09/00							
1.8 TD	66 08/96→09/00							
2.0 i	96 08/96→09/00							
1.6 i 16V	70 05/98→09/00	Fitting Position: Front Axle	11.0101-5407.2 260011	Brake System: ATE				
2.5 24V	125 06/00→09/00							
2.5 ST 200	151 05/99→09/00							
2.5 24V	125 08/96→09/00	Construction year from: 10/96 → → Construction year to: 11/97; Fitting Position: Front Axle	11.0101-5407.2 260011	Brake System: ATE				
					Construction year from: 12/97 → →; Fitting Position: Front Axle	11.0101-5407.2 260011	Brake System: ATE	
Guide Bolt, brake caliper								
1.6 i	66 08/96→09/00	Construction year from: 10/96 → →; Required quantity: 2; Fitting Position: Front Axle	2 11.8171-0008.1 990049	Brake System: ATE				
1.8 i	85 08/96→09/00							
1.8 TD	66 08/96→09/00							
2.0 i	96 08/96→09/00							
1.6 i 16V	70 05/98→09/00	Required quantity: 2; Fitting Position: Front Axle	2 11.8171-0008.1 990049	Brake System: ATE				
2.5 24V	125 06/00→09/00							
2.5 ST 200	151 05/99→09/00							
2.5 24V	125 08/96→09/00	Construction year from: 10/96 → → Construction year to: 11/97; Required quantity: 2; Fitting Position: Front Axle	2 11.8171-0008.1 990049	Brake System: ATE				
					Construction year from: 12/97 → →; Required quantity: 2; Fitting Position: Front Axle	2 11.8171-0008.1 990049	Brake System: ATE	
FORD - MONDEO II Turnier (BNP) 08/96→09/00								
Guide Sleeve Kit, brake caliper								
1.6 i	66 08/96→09/00	Construction year from: 10/96 → →; Fitting Position: Front Axle	11.0101-5407.2 260011	Brake System: ATE				
1.8 i	85 08/96→09/00							
1.8 TD	66 08/96→09/00							
2.0 i	96 08/96→09/00							
1.6 i 16V	70 05/98→09/00	Fitting Position: Front Axle	11.0101-5407.2 260011	Brake System: ATE				
2.5 24V	125 10/99→09/00							
2.5 ST 200	151 05/99→09/00							
2.5 24V	125 08/96→09/00	Construction year from: 10/96 → → Construction year to: 11/97; Fitting Position: Front Axle	11.0101-5407.2 260011	Brake System: ATE				
					Construction year from: 12/97 → →; Fitting Position: Front Axle	11.0101-5407.2 260011	Brake System: ATE	
Guide Bolt, brake caliper								
1.6 i	66 08/96→09/00	Construction year from: 10/96 → →; Required quantity: 2; Fitting Position: Front Axle	2 11.8171-0008.1 990049	Brake System: ATE				
1.8 i	85 08/96→09/00							
1.8 TD	66 08/96→09/00							
2.0 i	96 08/96→09/00							
1.6 i 16V	70 05/98→09/00	Required quantity: 2; Fitting Position: Front Axle	2 11.8171-0008.1 990049	Brake System: ATE				
2.5 24V	125 10/99→09/00							
2.5 ST 200	151 05/99→09/00							
2.5 24V	125 08/96→09/00	Construction year from: 10/96 → → Construction year to: 11/97; Required quantity: 2; Fitting Position: Front Axle	2 11.8171-0008.1 990049	Brake System: ATE				
					Construction year from: 12/97 → →; Required quantity: 2; Fitting Position: Front Axle	2 11.8171-0008.1 990049	Brake System: ATE	
FORD - MONDEO IV (BA7) 03/07→01/15								
Guide Sleeve Kit, brake caliper								
1.6 TDCi	85 02/11→01/15	→ Construction year to: 09/14; Fitting Position: Front Axle	11.0101-5407.2 260011	Brake System: ATE				
1.6 Ti	88 07/10→01/15							
1.8 TDCi	92 06/07→01/15							
2.0 Flexifuel	107 03/09→01/15							
2.0 LPG	107 07/09→01/15							
2.0 SCTi	149 03/10→01/15							
2.0 TDCi	85 - 03/07→01/15							
	120							
2.3	118 07/07→01/15							
1.6 Ti	81 - 03/07→01/15				Construction year from: 04/07 → → Construction year to: 09/14; Fitting Position: Front Axle	11.0101-5407.2 260011	Brake System: ATE	
	92							
1.8 TDCi	74 03/07→01/15							
2.0	107 03/07→01/15							
2.0 TDCi	96 - 03/07→01/15							
	103							
→								

	kW						
FORD - MONDEO IV (BA7) 03/07→01/15							
Guide Bolt, brake caliper							
1.6 EcoBoost	118	02/11→01/15	→ Construction year to: 09/14; Required quantity: 2	2	11.8171-0008.1 990049 Brake System: ATE		
1.6 TDCi	85	02/11→01/15					
1.6 Ti	88	07/10→01/15					
1.8 TDCi	92	06/07→01/15					
2.0 EcoBoost	176	07/10→01/15					
2.0 Flexifuel	107	03/09→01/15					
2.0 LPG	107	07/09→01/15					
2.0 SCTi	149	03/10→01/15					
2.0 TDCi	85 - 120	03/07→01/15					
2.3	118	07/07→01/15					
1.6 Ti	81 - 92	03/07→01/15	Construction year from: 04/07 → → Construction year to: 09/14; Required quantity: 2	2	11.8171-0008.1 990049 Brake System: ATE		
1.8 TDCi	74	03/07→01/15					
2.0	107	03/07→01/15					
2.0 TDCi	96 - 103	03/07→01/15					
2.5	162	03/07→01/15					
2.2 TDCi	129	03/08→10/10	Construction year from: 04/08 → ; Required quantity: 2	2	11.8171-0008.1 990049 Brake System: ATE		
2.2 TDCi	147	07/10→01/15	Construction year from: 11/10 → → Construction year to: 09/14; Required quantity: 2				
FORD - MONDEO IV Saloon (BA7) 03/07→01/15							
Guide Sleeve Kit, brake caliper							
1.6 TDCi	85	12/10→01/15	Construction year from: 02/11 → → Construction year to: 09/14; Fitting Position: Front Axle	11.0101-5407.2	260011	Brake System: ATE	
1.6 Ti	81 - 92	03/07→01/15	Construction year from: 04/07 → → Construction year to: 09/14; Fitting Position: Front Axle				
1.8 TDCi	74	03/07→01/15	→ Construction year to: 09/14; Fitting Position: Front Axle	11.0101-5407.2	260011	Brake System: ATE	
2.0	107	03/07→01/15					
2.0 TDCi	96 - 103	03/07→01/15					
1.6 Ti	88	03/10→01/15					
1.8 TDCi	92	06/07→01/15					
2.0 Flexifuel	107	03/09→01/15	→ Construction year to: 09/14; Fitting Position: Front Axle	11.0101-5407.2	260011	Brake System: ATE	
2.0 LPG	107	07/09→01/15					
2.0 SCTi	149	03/10→01/15					
2.0 TDCi	85 - 120	11/07→01/15					
2.3	118	07/07→01/15					
2.0 TDCi	100	08/08→12/14					Fitting Position: Front Axle
Guide Bolt, brake caliper							
1.6 EcoBoost	118	11/10→01/15	Construction year from: 02/11 → → Construction year to: 09/14; Required quantity: 2	2	11.8171-0008.1 990049 Brake System: ATE		
1.6 TDCi	85	12/10→01/15					
1.6 Ti	81 - 92	03/07→01/15	Construction year from: 04/07 → → Construction year to: 09/14; Required quantity: 2	2	11.8171-0008.1 990049 Brake System: ATE		
1.8 TDCi	74	03/07→01/15					
2.0	107	03/07→01/15					
2.0 TDCi	96 - 103	03/07→01/15					
2.5	162	03/07→01/15					
1.6 Ti	88	03/10→01/15	→ Construction year to: 09/14; Required quantity: 2	2	11.8171-0008.1 990049 Brake System: ATE		
1.8 TDCi	92	06/07→01/15					
2.0 Flexifuel	107	03/09→01/15					
2.0 LPG	107	07/09→01/15					
2.0 SCTi	149	03/10→01/15					
2.0 TDCi	85 - 120	11/07→01/15					
2.3	118	07/07→01/15					
2.0 EcoBoost	176	03/10→09/14				Required quantity: 2	
2.0 TDCi	100	08/08→12/14					
2.2 TDCi	129	03/08→10/10				Construction year from: 04/08 → ; Required quantity: 2	2
2.2 TDCi	147	10/10→01/15	Construction year from: 11/10 → → Construction year to: 09/14; Required quantity: 2				
FORD - MONDEO IV Turnier (BA7) 03/07→01/15							
Guide Sleeve Kit, brake caliper							
1.6 TDCi	85	02/11→01/15	→ Construction year to: 09/14; Fitting Position: Front Axle	11.0101-5407.2	260011	Brake System: ATE	
1.6 Ti	88	07/10→01/15					
2.0 Flexifuel	107	03/09→01/15					
2.0 LPG	107	07/09→01/15					
2.0 SCTi	149	03/10→01/15					

	kW				
FORD - MONDEO IV Turnier (BA7) 03/07→01/15					
Guide Sleeve Kit, brake caliper					
2.0 TDCi	85 - 03/07→01/15 120	→ Construction year to: 09/14; Fitting Position: Front Axle		11.0101-5407.2 260011	Brake System: ATE
2.3	118 07/07→01/15				
1.6 Ti	81 - 03/07→12/12 92	Construction year from: 04/07 →; Fitting Position: Front Axle		11.0101-5407.2 260011	Brake System: ATE
1.8 TDCi	74 03/07→12/12				
2.0 TDCi	96 03/07→12/12				
1.8 TDCi	92 06/07→12/12	Fitting Position: Front Axle		11.0101-5407.2 260011	Brake System: ATE
2.0	107 03/07→01/15	Construction year from: 04/07 → →		11.0101-5407.2 260011	Brake System: ATE
2.0 TDCi	103 03/07→01/15	Construction year to: 09/14; Fitting Position: Front Axle			
Guide Bolt, brake caliper					
1.6 EcoBoost	118 02/11→01/15	→ Construction year to: 09/14;	2	11.8171-0008.1 990049	Brake System: ATE
1.6 TDCi	85 02/11→01/15	Required quantity: 2			
1.6 Ti	88 07/10→01/15				
2.0 EcoBoost	176 07/10→01/15				
2.0 Flexifuel	107 03/09→01/15				
2.0 LPG	107 07/09→01/15				
2.0 SCTi	149 03/10→01/15				
2.0 TDCi	85 - 03/07→01/15 120				
2.3	118 07/07→01/15				
1.6 Ti	81 - 03/07→12/12 92	Construction year from: 04/07 →; Required quantity: 2	2	11.8171-0008.1 990049	Brake System: ATE
1.8 TDCi	74 03/07→12/12				
2.0 TDCi	96 03/07→12/12				
2.5	162 03/07→12/12				
1.8 TDCi	92 06/07→12/12	Required quantity: 2	2	11.8171-0008.1 990049	Brake System: ATE
2.0	107 03/07→01/15	Construction year from: 04/07 → →	2	11.8171-0008.1 990049	Brake System: ATE
2.0 TDCi	103 03/07→01/15	Construction year to: 09/14; Required quantity: 2			
2.2 TDCi	129 03/08→10/10	Construction year from: 04/08 →; Required quantity: 2	2	11.8171-0008.1 990049	Brake System: ATE
2.2 TDCi	147 07/10→01/15	Construction year from: 11/10 → → Construction year to: 09/14; Required quantity: 2	2	11.8171-0008.1 990049	Brake System: ATE
FORD - MONDEO IV Van 03/07→01/15					
Guide Sleeve Kit, brake caliper					
1.6 TDCi	85 03/13→09/14	Fitting Position: Front Axle		11.0101-5407.2 260011	Brake System: ATE
2.0 EcoBoost	149 03/10→09/14				
2.0 TDCi	85 - 11/07→09/14 120				
2.0	107 03/07→09/14	Construction year from: 04/07 →;		11.0101-5407.2 260011	Brake System: ATE
2.0 TDCi	103 03/07→09/14	Fitting Position: Front Axle			
Guide Bolt, brake caliper					
1.6 EcoBoost	118 11/10→09/14	Required quantity: 2	2	11.8171-0008.1 990049	Brake System: ATE
1.6 TDCi	85 03/13→09/14				
2.0 EcoBoost	149 - 03/10→09/14 176				
2.0 TDCi	85 - 11/07→09/14 120				
2.2 TDCi	147 03/13→09/14				
2.0	107 03/07→09/14	Construction year from: 04/07 →;	2	11.8171-0008.1 990049	Brake System: ATE
2.0 TDCi	103 03/07→09/14	Required quantity: 2			
FORD - ORION I (AFD) 07/83→03/86					
Guide Sleeve Kit, brake caliper					
1.3	51 07/83→03/86	→ Construction year to: 12/85;		11.0101-5407.2 260011	Brake System: ATE
1.6	58 07/83→03/86	Fitting Position: Front Axle			
1.6 D	40 02/84→03/86				
Guide Bolt, brake caliper					
1.3	51 07/83→03/86	→ Construction year to: 12/85;	2	11.8171-0008.1 990049	Brake System: ATE
1.6	58 07/83→03/86	Required quantity: 2;			
1.6 D	40 02/84→03/86	Fitting Position: Front Axle			
FORD - ORION II (AFF) 12/85→07/90					
Guide Sleeve Kit, brake caliper					
1.3	44 12/85→07/90	Construction year from: 01/86 →;		11.0101-5407.2 260011	Brake System: ATE
1.4	55 12/85→07/90	Fitting Position: Front Axle			
1.6	66 12/85→07/90				
1.6 D	40 12/85→01/89				
1.3	51 11/86→07/88	Fitting Position: Front Axle		11.0101-5407.2 260011	Brake System: ATE
→					

	kW				
FORD - ORION II (AFF) 12/85→07/90					
Guide Sleeve Kit, brake caliper					
1.4	52 - 01/86→07/90 54	Fitting Position: Front Axle		11.0101-5407.2 260011	Brake System: ATE
1.4 Cat	54 02/87→07/90				
1.6	65 03/86→07/90				
1.6 i	75 02/86→07/90				
1.6 i Cat	66 03/86→07/90				
1.8 D	44 01/89→07/90	Construction year from: 04/89 →; Fitting Position: Front Axle		11.0101-5407.2 260011	Brake System: ATE
Guide Bolt, brake caliper					
1.3	44 12/85→07/90	Construction year from: 01/86 →;	2	11.8171-0008.1 990049	Brake System: ATE
1.4	55 12/85→07/90	Required quantity: 2;			
1.6	66 12/85→07/90	Fitting Position: Front Axle			
1.6 D	40 12/85→01/89				
1.3	51 11/86→07/88	Required quantity: 2;	2	11.8171-0008.1 990049	Brake System: ATE
1.4	52 - 01/86→07/90 54	Fitting Position: Front Axle			
1.4 Cat	54 02/87→07/90				
1.6	65 03/86→07/90				
1.6 i	75 02/86→07/90				
1.6 i Cat	66 03/86→07/90				
1.8 D	44 01/89→07/90	Construction year from: 04/89 →; Required quantity: 2; Fitting Position: Front Axle	2	11.8171-0008.1 990049	Brake System: ATE
FORD - ORION III (GAL) 01/90→09/96					
Guide Sleeve Kit, brake caliper					
1.8 i 16V	96 01/92→12/93	Fitting Position: Front Axle		11.0101-5407.2 260011	Brake System: ATE
Guide Bolt, brake caliper					
1.8 i 16V	96 01/92→12/93	Required quantity: 2; Fitting Position: Front Axle	2	11.8171-0008.1 990049	Brake System: ATE
FORD - PUMA (EC_) 03/97→06/02					
Guide Sleeve Kit, brake caliper					
1.4 16V	66 11/97→10/00	Construction year from: 02/98 → → Construction year to: 01/00; Fitting Position: Front Axle		11.0101-5407.2 260011	Brake System: ATE
		Construction year from: 02/00 →; Fitting Position: Front Axle		11.0101-5407.2 260011	Brake System: ATE
1.6 16V	76 08/00→06/02	→ Construction year to: 12/01; Fitting Position: Front Axle		11.0101-5407.2 260011	Brake System: ATE
1.7 16V	92 03/97→06/02	Construction year from: 06/97 → → Construction year to: 01/00; Fitting Position: Front Axle		11.0101-5407.2 260011	Brake System: ATE
		Construction year from: 02/00 → → Construction year to: 12/01; Fitting Position: Front Axle		11.0101-5407.2 260011	Brake System: ATE
Racing ST 160	114 06/99→06/02	Construction year from: 02/00 → → Construction year to: 12/01; Fitting Position: Front Axle		11.0101-5407.2 260011	Brake System: ATE
		→ Construction year to: 01/00; Fitting Position: Front Axle		11.0101-5407.2 260011	Brake System: ATE
Guide Bolt, brake caliper					
1.4 16V	66 11/97→10/00	Construction year from: 02/98 → → Construction year to: 01/00; Required quantity: 2; Fitting Position: Front Axle	2	11.8171-0008.1 990049	Brake System: ATE
		Construction year from: 02/00 →; Required quantity: 2; Fitting Position: Front Axle	2	11.8171-0008.1 990049	Brake System: ATE
1.6 16V	76 08/00→06/02	→ Construction year to: 12/01; Required quantity: 2; Fitting Position: Front Axle	2	11.8171-0008.1 990049	Brake System: ATE
1.7 16V	92 03/97→06/02	Construction year from: 06/97 → → Construction year to: 01/00; Required quantity: 2; Fitting Position: Front Axle	2	11.8171-0008.1 990049	Brake System: ATE
		Construction year from: 02/00 → → Construction year to: 12/01; Required quantity: 2; Fitting Position: Front Axle	2	11.8171-0008.1 990049	Brake System: ATE
Racing ST 160	114 06/99→06/02	Construction year from: 02/00 → → Construction year to: 12/01; Required quantity: 2; Fitting Position: Front Axle	2	11.8171-0008.1 990049	Brake System: ATE
→					

FORD - PUMA (EC_) 03/97→06/02							
Guide Bolt, brake caliper							
Racing ST 160	114	06/99→06/02	→ Construction year to: 01/00; Required quantity: 2; Fitting Position: Front Axle	2	11.8171-0008.1	990049	Brake System: ATE
FORD - PUMA (J2K, CF7) 09/19→							
Spring, brake caliper							
1.0 Flexifuel	92	12/21→	Required quantity: 2; Fitting Position: Front Axle	2	11.8116-0356.1	390586	Brake System: ATE
FORD - SCORPIO I (GAE, GGE) 04/85→09/94							
Guide Sleeve Kit, brake caliper							
2.0	77	04/85→08/89	Fitting Position: Front Axle		11.0101-5407.2	260011	Brake System: ATE
2.0 i	74 - 85	10/85→09/94					
2.4 i	96	09/86→09/88					
2.8 i	110	04/85→11/86					
2.0 i	85 - 88	04/85→09/94	→ Construction year to: 01/92; Fitting Position: Front Axle	2	11.0101-5407.2	260011	Brake System: ATE
2.4 i	92	10/88→02/92					
2.4 i Cat	92	10/88→09/94					
2.5 D	51	12/85→02/92					
2.9 i 4x4	107 - 110	09/86→09/94					
2.9 i Cat	107	10/87→09/94					
2.5 TD	68	06/88→07/93	→ Construction year to: 01/92; Fitting Position: Front Axle		11.0101-5407.2	260011	Brake System: ATE
2.9 i	107 - 110	09/86→09/94					
2.9 i 24V	143	04/91→09/94	Construction year from: 02/92 →; Fitting Position: Front Axle		11.0101-5407.2	260011	Brake System: ATE
Guide Bolt, brake caliper							
2.0	77	04/85→08/89	Required quantity: 2; Fitting Position: Front Axle	2	11.8171-0008.1	990049	Brake System: ATE
2.0 i	74 - 85	10/85→09/94					
2.4 i	96	09/86→09/88					
2.8 i	110	04/85→11/86					
2.0 i	85 - 88	04/85→09/94	→ Construction year to: 01/92; Required quantity: 2; Fitting Position: Front Axle	2	11.8171-0008.1	990049	Brake System: ATE
2.4 i	92	10/88→02/92					
2.4 i Cat	92	10/88→09/94					
2.5 D	51	12/85→02/92					
2.9 i Cat	107	10/87→09/94					
2.5 TD	68	06/88→07/93	Construction year from: 02/92 →; Required quantity: 2; Fitting Position: Front Axle	2	11.8171-0008.1	990049	Brake System: ATE
2.9 i	107 - 110	09/86→09/94					
2.9 i 24V	143	04/91→09/94	→ Construction year to: 01/92; Required quantity: 2; Fitting Position: Front Axle	2	11.8171-0008.1	990049	Brake System: ATE
2.9 i 4x4	107 - 110	09/86→09/94	Construction year from: 02/92 →; Required quantity: 2; Fitting Position: Front Axle	2	11.8171-0008.1	990049	Brake System: ATE
FORD - SCORPIO I Saloon (GGE) 01/86→12/94							
Guide Sleeve Kit, brake caliper							
2.0	85	11/92→09/93	Fitting Position: Front Axle		11.0101-5407.2	260011	Brake System: ATE
2.0 i	85	02/92→09/94					
2.0 i	88 - 92	05/89→09/94	→ Construction year to: 01/92; Fitting Position: Front Axle		11.0101-5407.2	260011	Brake System: ATE
2.4 i	92	10/88→10/94					
2.5 D	51	12/89→12/94					
2.5 TD	68	06/88→07/93	→ Construction year to: 01/92; Fitting Position: Front Axle		11.0101-5407.2	260011	Brake System: ATE
2.9 i 24V	143	04/91→09/94	Construction year from: 02/92 →; Fitting Position: Front Axle		11.0101-5407.2	260011	Brake System: ATE
2.9 i	107	09/86→12/94	Construction year from: 02/92 → → Construction year to: 09/94; Fitting Position: Front Axle		11.0101-5407.2	260011	Brake System: ATE
			→ Construction year to: 01/92; Fitting Position: Front Axle		11.0101-5407.2	260011	Brake System: ATE
Guide Bolt, brake caliper							
2.0	85	11/92→09/93	Required quantity: 2; Fitting Position: Front Axle	2	11.8171-0008.1	990049	Brake System: ATE
2.0 i	85	02/92→09/94					
2.0 i	88 - 92	05/89→09/94	→ Construction year to: 01/92; Required quantity: 2; Fitting Position: Front Axle	2	11.8171-0008.1	990049	Brake System: ATE
2.4 i	92	10/88→10/94					
→							

	kW				
FORD - SCORPIO I Saloon (GGE) 01/86→12/94					
Guide Bolt, brake caliper					
2.5 D	51 12/89→12/94	Construction year from: 02/92 →; Required quantity: 2; Fitting Position: Front Axle	2	11.8171-0008.1 990049	Brake System: ATE
2.5 TD 2.9 i 24V	68 06/88→07/93 143 04/91→09/94	Construction year from: 02/92 →; Required quantity: 2; Fitting Position: Front Axle	2	11.8171-0008.1 990049	Brake System: ATE
		→ Construction year to: 01/92; Required quantity: 2; Fitting Position: Front Axle	2	11.8171-0008.1 990049	Brake System: ATE
2.9 i	107 09/86→12/94	Construction year from: 02/92 → → Construction year to: 09/94; Required quantity: 2; Fitting Position: Front Axle	2	11.8171-0008.1 990049	Brake System: ATE
		→ Construction year to: 01/92; Required quantity: 2; Fitting Position: Front Axle	2	11.8171-0008.1 990049	Brake System: ATE
FORD - SCORPIO I Turnier (GGE) 05/88→09/94					
Guide Sleeve Kit, brake caliper					
2.0 i	85 - 09/91→09/94 88	→ Construction year to: 01/92; Fitting Position: Front Axle		11.0101-5407.2 260011	Brake System: ATE
2.5 TD 2.9 i	68 09/91→07/93 107 09/91→09/94	Construction year from: 02/92 →; Fitting Position: Front Axle		11.0101-5407.2 260011	Brake System: ATE
2.4 i	92 09/91→09/94	→ Construction year to: 01/92; Fitting Position: Front Axle		11.0101-5407.2 260011	Brake System: ATE
2.9 24V	143 08/93→09/94	Fitting Position: Front Axle		11.0101-5407.2 260011	Brake System: ATE
Guide Bolt, brake caliper					
2.0 i	85 - 09/91→09/94 88	Construction year from: 02/92 →; Required quantity: 2; Fitting Position: Front Axle	2	11.8171-0008.1 990049	Brake System: ATE
2.5 TD 2.9 i	68 09/91→07/93 107 09/91→09/94	→ Construction year to: 01/92; Required quantity: 2; Fitting Position: Front Axle	2	11.8171-0008.1 990049	Brake System: ATE
2.4 i	92 09/91→09/94	→ Construction year to: 01/92; Required quantity: 2; Fitting Position: Front Axle	2	11.8171-0008.1 990049	Brake System: ATE
2.9 24V	143 08/93→09/94	Required quantity: 2; Fitting Position: Front Axle	2	11.8171-0008.1 990049	Brake System: ATE
FORD - SCORPIO II (GFR, GGR) 10/94→08/98					
Guide Sleeve Kit, brake caliper					
2.0 i	85 10/94→08/98	Fitting Position: Front Axle		11.0101-5407.2 260011	Brake System: ATE
2.0 i 16V	100 10/94→08/98				
2.3 i 16V	108 06/96→08/98				
2.5 TD	85 10/94→08/98				
2.9 i	110 02/95→08/98				
2.9 i 24V	152 10/94→08/98				
Guide Bolt, brake caliper					
2.0 i	85 10/94→08/98	Required quantity: 2;	2	11.8171-0008.1 990049	Brake System: ATE
2.0 i 16V	100 10/94→08/98	Fitting Position: Front Axle			
2.3 i 16V	108 06/96→08/98				
2.5 TD	85 10/94→08/98				
2.9 i	110 02/95→08/98				
2.9 i 24V	152 10/94→08/98				
FORD - SCORPIO II Turnier (GFR, GGR) 10/94→08/98					
Guide Sleeve Kit, brake caliper					
2.0 i	85 10/94→08/98	Fitting Position: Front Axle		11.0101-5407.2 260011	Brake System: ATE
2.0 i 16V	100 10/94→08/98				
2.3 i 16V	108 06/96→08/98				
2.5 TD	85 10/94→08/98				
2.9 i	110 02/95→08/98				
2.9 i 24V	152 10/94→08/98				
Guide Bolt, brake caliper					
2.0 i	85 10/94→08/98	Required quantity: 2;	2	11.8171-0008.1 990049	Brake System: ATE
2.0 i 16V	100 10/94→08/98	Fitting Position: Front Axle			
2.3 i 16V	108 06/96→08/98				
2.5 TD	85 10/94→08/98				
2.9 i	110 02/95→08/98				
2.9 i 24V	152 10/94→08/98				





	kW				
FORD - SIERRA II (GBG, GB4) 01/87→02/93					
Guide Sleeve Kit, brake caliper					
2.9 i	110	08/88→02/93	→ Construction year to: 01/92; Fitting Position: Front Axle	2	11.0101-5407.2 260011 Brake System: ATE
Guide Bolt, brake caliper					
1.6	53	01/87→02/93	Required quantity: 2; Fitting Position: Front Axle	2	11.8171-0008.1 990049 Brake System: ATE
1.6 i	59	10/89→02/93			
1.8	59	01/87→02/93			
	66				
2.0	77	01/87→02/93			
	80				
2.0 16V Cosworth 4x4	162	01/90→02/93			
2.0 4x4	88	01/90→02/93			
	92				
2.3 D	49	01/87→09/89			
2.9 4x4	107	08/88→02/93			
	110				
2.9 i	107	08/88→02/93			
1.8 TD	55	08/88→02/93	Construction year from: 01/90 →; Required quantity: 2; Fitting Position: Front Axle	2	11.8171-0008.1 990049 Brake System: ATE
2.0 i	74	01/87→02/93	- ABS; Required quantity: 2; Fitting Position: Front Axle	2	11.8171-0008.1 990049 Brake System: ATE
	92				
2.0 i Cat	74	01/87→02/93			
2.0 i DOHC	85	12/91→02/93			
2.8 i	105	08/87→02/93	→ Construction year to: 08/88; Required quantity: 2; Fitting Position: Front Axle	2	11.8171-0008.1 990049 Brake System: ATE
2.9 i	110	08/88→02/93	Construction year from: 02/92 →; Required quantity: 2; Fitting Position: Front Axle	2	11.8171-0008.1 990049 Brake System: ATE
FORD - SIERRA II Hatchback (GBC, GBG) 01/87→03/93					
Guide Sleeve Kit, brake caliper					
1.6	53	01/87→02/93	Fitting Position: Front Axle	2	11.0101-5407.2 260011 Brake System: ATE
	55				
1.6 i	59	10/89→02/93			
1.8	59	01/87→02/93			
	66				
2.0	77	01/87→02/93			
2.0 16V Cosworth 4x4	162	01/90→02/93			
2.0 16V Cosworth Cat 4x4	162	01/90→02/93			
2.3 D	49	01/87→09/89			
2.9 i	107	08/88→02/93			
1.8 TD	55	08/88→02/93	Construction year from: 01/90 →; Fitting Position: Front Axle	2	11.0101-5407.2 260011 Brake System: ATE
2.0 4x4	88	10/91→03/93	→ Construction year to: 02/93; Fitting Position: Front Axle	2	11.0101-5407.2 260011 Brake System: ATE
2.0 i	74	01/87→02/93	- ABS; Fitting Position: Front Axle	2	11.0101-5407.2 260011 Brake System: ATE
	92				
2.0 i Cat	74	01/87→02/93			
2.0 i DOHC	85	12/91→02/93			
2.8	110	03/87→09/89			
2.8 i	105	01/87→02/93	→ Construction year to: 08/88; Fitting Position: Front Axle	2	11.0101-5407.2 260011 Brake System: ATE
2.9 i XR 4x4	107	08/88→02/93	→ Construction year to: 01/92; Fitting Position: Front Axle	2	11.0101-5407.2 260011 Brake System: ATE
	110				
Guide Bolt, brake caliper					
1.6	53	01/87→02/93	Required quantity: 2; Fitting Position: Front Axle	2	11.8171-0008.1 990049 Brake System: ATE
	55				
1.6 i	59	10/89→02/93			
1.8	59	01/87→02/93			
	66				
2.0	77	01/87→02/93			
2.0 16V Cosworth 4x4	162	01/90→02/93			
2.0 16V Cosworth Cat 4x4	162	01/90→02/93			
2.3 D	49	01/87→09/89			
2.9 i	107	08/88→02/93			
1.8 TD	55	08/88→02/93	Construction year from: 01/90 →; Required quantity: 2; Fitting Position: Front Axle	2	11.8171-0008.1 990049 Brake System: ATE
2.0 4x4	88	10/91→03/93	→ Construction year to: 02/93; Required quantity: 2; Fitting Position: Front Axle	2	11.8171-0008.1 990049 Brake System: ATE
2.0 i	74	01/87→02/93	- ABS; Required quantity: 2; Fitting Position: Front Axle	2	11.8171-0008.1 990049 Brake System: ATE
	92				
2.0 i Cat	74	01/87→02/93			
2.0 i DOHC	85	12/91→02/93			
→					







	kW				
FORD - SIERRA II Hatchback (GBC, GBG) 01/87→03/93					
Guide Bolt, brake caliper					
2.8 2.8 i	110 03/87→09/89 105 01/87→02/93	→ Construction year to: 08/88; Required quantity: 2; Fitting Position: Front Axle	2	11.8171-0008.1 990049	Brake System: ATE
2.9 i XR 4x4	107 - 08/88→02/93 110	Construction year from: 02/92 →; Required quantity: 2; Fitting Position: Front Axle	2	11.8171-0008.1 990049	Brake System: ATE
FORD - SIERRA II Turnier (BNG) 01/87→02/93					
Guide Sleeve Kit, brake caliper					
1.6 1.6 i 1.8 1.8 TD 2.0 2.0 4x4 2.3 D 2.8 4x4 2.8 i 2.8 i 4x4 2.9 2.9 4x4 2.9 i	53 - 01/87→02/93 55 59 10/89→02/93 59 - 01/87→02/93 66 55 08/88→02/93 77 01/87→02/93 88 02/90→02/93 49 01/87→02/93 110 01/87→08/88 105 - 01/87→02/93 107 107 01/87→02/93 107 08/88→02/93 107 - 08/88→02/93 110 110 08/88→02/93	Fitting Position: Front Axle		11.0101-5407.2 260011	Brake System: ATE
2.0 4x4	92 05/89→02/93	Construction year from: 01/90 →; Fitting Position: Front Axle		11.0101-5407.2 260011	Brake System: ATE
2.0 i 2.0 i Cat 2.0 i DOHC	74 - 01/87→02/93 92 74 01/87→02/93 85 12/91→02/93	- ABS; Fitting Position: Front Axle		11.0101-5407.2 260011	Brake System: ATE
Guide Bolt, brake caliper					
1.6 1.6 i 1.8 1.8 TD 2.0 2.0 4x4 2.3 D 2.8 4x4 2.8 i 2.8 i 4x4 2.9 2.9 4x4 2.9 i	53 - 01/87→02/93 55 59 10/89→02/93 59 - 01/87→02/93 66 55 08/88→02/93 77 01/87→02/93 88 02/90→02/93 49 01/87→02/93 110 01/87→08/88 105 - 01/87→02/93 107 107 01/87→02/93 107 08/88→02/93 107 - 08/88→02/93 110 110 08/88→02/93	Required quantity: 2; Fitting Position: Front Axle	2	11.8171-0008.1 990049	Brake System: ATE
2.0 4x4	92 05/89→02/93	Construction year from: 01/90 →; Required quantity: 2; Fitting Position: Front Axle	2	11.8171-0008.1 990049	Brake System: ATE
2.0 i 2.0 i Cat 2.0 i DOHC	74 - 01/87→02/93 92 74 01/87→02/93 85 12/91→02/93	- ABS; Required quantity: 2; Fitting Position: Front Axle	2	11.8171-0008.1 990049	Brake System: ATE
FORD - SIERRA Turnier (BNC) 08/82→12/86					
Guide Sleeve Kit, brake caliper					
1.6	55 08/82→12/86	Construction year from: 03/86 →; + ABS; Fitting Position: Front Axle		11.0101-5407.2 260011	Brake System: ATE
		Construction year from: 05/86 →; - ABS; Fitting Position: Front Axle		11.0101-5407.2 260011	Brake System: ATE
1.8 2.0	66 10/84→12/86 74 - 08/82→12/86 85	Construction year from: 03/86 →; + ABS; Fitting Position: Front Axle		11.0101-5407.2 260011	Brake System: ATE
2.3 2.3 D	84 08/82→12/86 49 08/82→12/86	- ABS; Fitting Position: Front Axle		11.0101-5407.2 260011	Brake System: ATE
2.0	66 08/82→10/84	- ABS; Fitting Position: Front Axle		11.0101-5407.2 260011	Brake System: ATE
2.8 XR4i	105 08/82→12/86	Construction year from: 03/86 →; + ABS; Fitting Position: Front Axle		11.0101-5407.2 260011	Brake System: ATE
		Construction year from: 04/83 → → Construction year to: 03/85; Fitting Position: Front Axle		11.0101-5407.2 260011	Brake System: ATE
2.8 XR4i	107 08/82→12/86	Construction year from: 04/83 → → Construction year to: 03/85; Fitting Position: Front Axle		11.0101-5407.2 260011	Brake System: ATE
→					







	kW				
FORD - SIERRA Turnier (BNC) 08/82→12/86					
Guide Bolt, brake caliper					
1.6	55 08/82→12/86	Construction year from: 05/86 →; - ABS; Required quantity: 2; Fitting Position: Front Axle	2	11.8171-0008.1 990049	Brake System: ATE
		Construction year from: 03/86 →; + ABS; Required quantity: 2; Fitting Position: Front Axle	2	11.8171-0008.1 990049	Brake System: ATE
1.8	66 10/84→12/86	- ABS; Required quantity: 2; Fitting Position: Front Axle	2	11.8171-0008.1 990049	Brake System: ATE
2.0	74 - 08/82→12/86				
	85				
2.3	84 08/82→12/86	Construction year from: 03/86 →; + ABS; Required quantity: 2; Fitting Position: Front Axle	2	11.8171-0008.1 990049	Brake System: ATE
2.3 D	49 08/82→12/86				
2.0	66 08/82→10/84	- ABS; Required quantity: 2; Fitting Position: Front Axle	2	11.8171-0008.1 990049	Brake System: ATE
2.8 XR4i	105 08/82→12/86	Construction year from: 04/83 → → Construction year to: 03/85; Required quantity: 2	2	11.8171-0008.1 990049	Brake System: ATE
		Construction year from: 03/86 →; + ABS; Required quantity: 2; Fitting Position: Front Axle	2	11.8171-0008.1 990049	Brake System: ATE
2.8 XR4i	107 08/82→12/86	Construction year from: 04/83 → → Construction year to: 03/85; Required quantity: 2	2	11.8171-0008.1 990049	Brake System: ATE
FORD - S-MAX (WA6) 05/06→12/14					
Guide Sleeve Kit, brake caliper					
1.6 TDCi	85 02/11→12/14	Fitting Position: Front Axle		11.0101-5407.2 260011	Brake System: ATE
1.8 TDCi	74 - 05/06→12/14				
	92				
2.0	107 05/06→12/14				
2.0 Flexifuel	107 05/06→12/14				
2.0 TDCi	85 - 05/06→12/14				
	120				
2.3	118 07/07→12/14				
Guide Bolt, brake caliper					
1.6 EcoBoost	118 02/11→12/14	Required quantity: 2	2	11.8171-0008.1 990049	Brake System: ATE
1.6 TDCi	85 02/11→12/14				
1.8 TDCi	74 - 05/06→12/14				
	92				
2.0	107 05/06→12/14				
2.0 Flexifuel	107 05/06→12/14				
2.0 TDCi	85 - 05/06→12/14				
	120				
2.2 TDCi	147 07/10→12/14				
2.3	118 07/07→12/14				
2.2 TDCi	129 03/08→12/12	Construction year from: 11/08 →; Required quantity: 2	2	11.8171-0008.1 990049	Brake System: ATE
FORD - S-MAX VAN (WA6) 05/06→12/14					
Guide Sleeve Kit, brake caliper					
2.0	107 03/10→12/14	Fitting Position: Front Axle		11.0101-5407.2 260011	Brake System: ATE
2.0 TDCi	85 - 01/07→12/14				
	120				
Guide Bolt, brake caliper					
1.6	118 02/11→12/14	Required quantity: 2	2	11.8171-0008.1 990049	Brake System: ATE
2.0	107 03/10→12/14				
2.0 TDCi	85 - 01/07→12/14				
	120				
FORD - STREET KA (RL2) 03/03→07/05					
Guide Sleeve Kit, brake caliper					
1.6	70 05/03→07/05	Fitting Position: Front Axle		11.0101-5407.2 260011	Brake System: ATE
Guide Bolt, brake caliper					
1.6	70 05/03→07/05	Required quantity: 2	2	11.8171-0008.1 990049	Brake System: ATE
FORD - TOURNEO CONNECT 06/02→12/13					
Guide Sleeve Kit, brake caliper					
1.8 16V	85 06/02→12/13	→ Construction year to: 08/13;		11.0101-5407.2 260011	Brake System: ATE
1.8 TDCi	66 - 06/02→12/13	Fitting Position: Rear Axle			
	81				
1.8 TDCi /TDDi /DI	55 06/02→12/13				
→					









FORD - TOURNEO CONNECT 06/02→12/13								
Guide Bolt, brake caliper								
1.8 16V	85	06/02→12/13	→ Construction year to: 08/13;	2	11.8171-0008.1	990049	Brake System: ATE	
1.8 TDCi	66 - 81	06/02→12/13	Required quantity: 2					
1.8 TDCi /TDDi /DI	55	06/02→12/13						
FORD - TOURNEO CONNECT / GRAND TOURNEO CONNECT V408 MPV 09/13→								
Spring, brake caliper								
1.0 EcoBoost	74	11/13→	Payload: not for increased payload;	2	11.8116-0356.1	390586	Brake System: ATE	
1.5 TDCi	55 - 88	05/15→	Required quantity: 2					
1.6 EcoBoost	110	11/13→						
1.6 TDCi	55 - 85	09/13→						
Guide Sleeve Kit, brake caliper								
1.0 EcoBoost	74	11/13→	Payload: not for increased payload;		11.0101-5407.2	260011	Brake System: ATE	
1.5 TDCi	55 - 88	05/15→	Fitting Position: Front Axle					
1.6 EcoBoost	110	11/13→	Fitting Position: Rear Axle		11.0101-5407.2	260011	Brake System: ATE	
1.6 TDCi	55 - 85	09/13→						
Guide Bolt, brake caliper								
1.0 EcoBoost	74	11/13→	Required quantity: 2	2	11.8171-0008.1	990049	Brake System: ATE	
1.5 TDCi	55 - 88	05/15→	Payload: not for increased payload;	2	11.8171-0008.1	990049	Brake System: ATE	
1.6 EcoBoost	110	11/13→	Required quantity: 2					
1.6 TDCi	55 - 85	09/13→						
FORD - TRANSIT CONNECT (P65_, P70_, P80_) 06/02→								
Guide Sleeve Kit, brake caliper								
1.8 16V	85	06/02→12/13	Fitting Position: Rear Axle		11.0101-5407.2	260011	Brake System: ATE	
1.8 16V LPG	85	06/02→12/13						
1.8 Di	55	06/02→12/13						
1.8 TDCi	66 - 81	06/02→12/13						
Guide Bolt, brake caliper								
1.8 16V	85	06/02→12/13	Required quantity: 2	2	11.8171-0008.1	990049	Brake System: ATE	
1.8 16V LPG	85	06/02→12/13						
1.8 Di	55	06/02→12/13						
1.8 TDCi	66 - 81	06/02→12/13						
FORD - TRANSIT CONNECT MPV 02/13→								
Spring, brake caliper								
1.5 TDCi	55 - 88	05/15→	Payload: not for increased payload;	2	11.8116-0356.1	390586	Brake System: ATE	
1.6 TDCi	55 - 85	02/13→	Required quantity: 2					
Guide Sleeve Kit, brake caliper								
1.5 TDCi	55 - 88	05/15→	Payload: not for increased payload;		11.0101-5407.2	260011	Brake System: ATE	
1.6 TDCi	55 - 85	02/13→	Fitting Position: Front Axle					
			Fitting Position: Rear Axle		11.0101-5407.2	260011	Brake System: ATE	
Guide Bolt, brake caliper								
1.5 TDCi	55 - 88	05/15→	Required quantity: 2	2	11.8171-0008.1	990049	Brake System: ATE	
1.6 TDCi	55 - 85	02/13→	Payload: not for increased payload;	2	11.8171-0008.1	990049	Brake System: ATE	
			Required quantity: 2					
FORD - TRANSIT CONNECT V408 Box Body/MPV 02/13→								
Spring, brake caliper								
1.0 EcoBoost	74	02/13→	Construction year from: 09/13 →;	2	11.8116-0356.1	390586	Brake System: ATE	
1.5 TDCi	55 - 88	05/15→	Payload: not for increased payload;	2	11.8116-0356.1	390586	Brake System: ATE	
1.6 EcoBoost	110	11/13→	Required quantity: 2					
1.6 TDCi	55 - 85	02/13→	Payload: not for increased payload;					
			Required quantity: 2					
→								







	kW				
FORD - TRANSIT CONNECT V408 Box Body/MPV 02/13→					
Guide Sleeve Kit, brake caliper					
1.0 EcoBoost	74	02/13→	Construction year from: 09/13 →; Payload: not for increased payload; Fitting Position: Front Axle	11.0101-5407.2	260011 Brake System: ATE
			Construction year from: 09/13 →; Fitting Position: Rear Axle	11.0101-5407.2	260011 Brake System: ATE
1.5 TDCi	55 - 88	05/15→	Payload: not for increased payload; Fitting Position: Front Axle	11.0101-5407.2	260011 Brake System: ATE
1.6 EcoBoost	110	11/13→	Fitting Position: Rear Axle	11.0101-5407.2	260011 Brake System: ATE
1.6 TDCi	55 - 85	02/13→			
Guide Bolt, brake caliper					
1.0 EcoBoost	74	02/13→	Construction year from: 09/13 →; Required quantity: 2	2 11.8171-0008.1	990049 Brake System: ATE
			Construction year from: 09/13 →; Payload: not for increased payload; Required quantity: 2	2 11.8171-0008.1	990049 Brake System: ATE
1.5 TDCi	55 - 88	05/15→	Required quantity: 2	2 11.8171-0008.1	990049 Brake System: ATE
1.6 EcoBoost	110	11/13→	Payload: not for increased payload; Required quantity: 2	2 11.8171-0008.1	990049 Brake System: ATE
1.6 TDCi	55 - 85	02/13→			
HONDA - ACCORD VII (CL, CN) 01/03→09/12					
Spring, brake caliper					
2.0	110 - 114	02/03→05/08	Required quantity: 2	2 11.8116-0356.1	390586 Brake System: ATE
2.0 All-wheel Drive	114	02/03→05/08			
2.4	113 - 140	02/03→05/08			
2.4 i 16V	115	02/03→05/08			
3.0	182	04/06→05/08			
Guide Sleeve Kit, brake caliper					
2.0	110 - 114	02/03→05/08	Fitting Position: Front Axle	11.0101-5407.2	260011 Brake System: ATE
2.0 All-wheel Drive	114	02/03→05/08			
2.4	113 - 140	02/03→05/08			
2.4 i 16V	115	02/03→05/08			
3.0	182	04/06→05/08			
Guide Bolt, brake caliper					
2.0	110 - 114	02/03→05/08	Required quantity: 2	2 11.8171-0008.1	990049 Brake System: ATE
2.0 All-wheel Drive	114	02/03→05/08			
2.4	113 - 140	02/03→05/08			
2.4 i 16V	115	02/03→05/08			
3.0	182	04/06→05/08			
HONDA - ACCORD VII (CM) 09/02→05/08					
Spring, brake caliper					
2.4 Vtec E	118	09/02→12/05	Construction year from: 02/03 → → Construction year to: 09/05; Required quantity: 2	2 11.8116-0356.1	390586 Brake System: ATE
2.4 Vtec E	125	06/06→01/08	Required quantity: 2	2 11.8116-0356.1	390586 Brake System: ATE
3.0	177 - 182	05/03→12/07			
Guide Sleeve Kit, brake caliper					
2.4 Vtec E	118	09/02→12/05	Construction year from: 02/03 → → Construction year to: 09/05; Fitting Position: Front Axle	11.0101-5407.2	260011 Brake System: ATE
2.4 Vtec E	125	06/06→01/08	Fitting Position: Front Axle	11.0101-5407.2	260011 Brake System: ATE
3.0	177 - 182	05/03→12/07			
Guide Bolt, brake caliper					
2.4 Vtec E	118	09/02→12/05	Construction year from: 02/03 → → Construction year to: 09/05; Required quantity: 2	2 11.8171-0008.1	990049 Brake System: ATE
2.4 Vtec E	125	06/06→01/08	Required quantity: 2	2 11.8171-0008.1	990049 Brake System: ATE
3.0	177 - 182	05/03→12/07			









	kW				
HONDA - ACCORD VII Tourer (CM, CN) 04/03→05/08					
Spring, brake caliper					
2.0	114	04/03→05/08	Required quantity: 2	2	11.8116-0356.1 390586 Brake System: ATE
2.2 i-CTDi	103	01/04→05/08			
2.4	140	04/03→05/08			
2.4 Vtec T	147	09/03→05/08			
Guide Sleeve Kit, brake caliper					
2.0	114	04/03→05/08	Fitting Position: Front Axle		11.0101-5407.2 260011 Brake System: ATE
2.2 i-CTDi	103	01/04→05/08			
2.4	140	04/03→05/08			
2.4 Vtec T	147	09/03→05/08			
Guide Bolt, brake caliper					
2.0	114	04/03→05/08	Required quantity: 2	2	11.8171-0008.1 990049 Brake System: ATE
2.2 i-CTDi	103	01/04→05/08			
2.4	140	04/03→05/08			
2.4 Vtec T	147	09/03→05/08			
HONDA - CR-V II (RD_) 09/01→07/07					
 Brake Hose					
2.4 Vtec 4WD	118	09/01→09/06	Construction year from: 01/05 →; Required quantity: 2; Fitting Position: Rear Axle	2	24.5270-0450.3 331183 Length [mm]: 450
HONDA - CR-V III (RE_) 06/06→					
 Brake Hose					
2.0 i-VTEC	105 - 110	01/07→06/12	Required quantity: 2; Fitting Position: Rear Axle	2	24.5270-0450.3 331183 Length [mm]: 450
2.0 i-VTEC 4WD	110	10/06→06/12			
2.4	124	06/06→			
2.2 i-CTDi 4WD	103	01/07→	→ Construction year to: 09/12;	2	24.5270-0450.3 331183 Length [mm]: 450
2.2 i-DTEC 4WD	110	01/07→	Required quantity: 2;		
2.4	125	04/07→	Fitting Position: Rear Axle		
2.4 i-Vtec 4WD	125	04/07→			
2.4 i-VTEC 4WD	122	09/09→			
2.4 4WD	124	09/06→	Construction year from: 09/07 → → Construction year to: 09/12; Required quantity: 2; Fitting Position: Rear Axle	2	24.5270-0450.3 331183 Length [mm]: 450
2.4 i-VTEC 4WD	118	10/06→	Construction year from: 01/07 → → Construction year to: 09/12; Required quantity: 2; Fitting Position: Rear Axle	2	24.5270-0450.3 331183 Length [mm]: 450
HONDA - CR-V IV (RM_) 01/12→					
 Brake Hose					
2.4 AWD	132	01/12→	Required quantity: 2; Fitting Position: Rear Axle	2	24.5270-0450.3 331183 Length [mm]: 450
HYUNDAI - CRETA 01/16→01/21					
 Brake Disc					
1.6	90	01/16→01/21	Vehicle Production Country: Russia-made; Fitting Position: Rear Axle	24.0110-0368.1 410368	Outer diameter [mm]: 262 Brake Disc Thickness [mm] 10 Minimum thickness [mm] 8.4 Brake Disc Type: Solid
2.0	110	01/16→01/21	Fitting Position: Rear Axle	24.0110-0368.1 410368	Outer diameter [mm]: 262 Brake Disc Thickness [mm] 10 Minimum thickness [mm] 8.4 Brake Disc Type: Solid
HYUNDAI - CRETA (SU2_) 03/20→					
 Brake Disc					
1.6 MPI	90	09/21→	Fitting Position: Rear Axle	24.0110-0368.1 410368	Outer diameter [mm]: 262 Brake Disc Thickness [mm] 10 Minimum thickness [mm] 8.4 Brake Disc Type: Solid
2.0 MPI	110	09/21→			
1.6 MPI 4WD	89	09/21→	Vehicle Equipment: for vehicles with electric parking brake; Transmission Type: 6-Speed Automatic Transmission; Fitting Position: Rear Axle	24.0110-0400.1 410400	Outer diameter [mm]: 284 Brake Disc Thickness [mm] 10 Minimum thickness [mm] 8.4 Brake Disc Type: Solid
			Vehicle Equipment: for vehicles without electric parking brake; Transmission Type: 6-Speed Automatic Transmission; Fitting Position: Rear Axle	24.0110-0408.1 410408	Outer diameter [mm]: 262 Brake Disc Thickness [mm] 10 Minimum thickness [mm] 8.4 Brake Disc Type: Solid
→					





	kW				
HYUNDAI - CRETA (SU2_) 03/20→					
 Brake Disc					
1.6 MPI 4WD	89 09/21→	Transmission Type: 6-Speed Manual Transmission; Fitting Position: Rear Axle	24.0110-0408.1 410408	Outer diameter [mm]: 262 Brake Disc Thickness [mm] 10 Minimum thickness [mm] 8.4 Brake Disc Type: Solid	
2.0 MPI 4WD	110 09/21→	Vehicle Equipment: for vehicles with electric parking brake; Fitting Position: Rear Axle	24.0110-0400.1 410400	Outer diameter [mm]: 284 Brake Disc Thickness [mm] 10 Minimum thickness [mm] 8.4 Brake Disc Type: Solid	
		Vehicle Equipment: for vehicles without electric parking brake; Fitting Position: Rear Axle	24.0110-0408.1 410408	Outer diameter [mm]: 262 Brake Disc Thickness [mm] 10 Minimum thickness [mm] 8.4 Brake Disc Type: Solid	
HYUNDAI - ELANTRA IV Saloon (HD) 11/05→					
 Brake Disc					
1.6 CVVT	89 01/16→	Fitting Position: Rear Axle	24.0110-0368.1 410368	Outer diameter [mm]: 262 Brake Disc Thickness [mm] 10 Minimum thickness [mm] 8.4 Brake Disc Type: Solid	
HYUNDAI - ELANTRA V Coupe (JK) 09/12→					
 Brake Disc					
1.6 1.8	96 12/14→ 108 - 09/12→ 110	→ Construction year to: 08/15; Fitting Position: Rear Axle	24.0110-0368.1 410368	Outer diameter [mm]: 262 Brake Disc Thickness [mm] 10 Minimum thickness [mm] 8.4 Brake Disc Type: Solid	
HYUNDAI - ELANTRA V Saloon (MD, UD) 09/10→					
 Brake Disc					
1.6	94 - 04/11→04/16 97	→ Construction year to: 08/15; Fitting Position: Rear Axle	24.0110-0368.1 410368	Outer diameter [mm]: 262 Brake Disc Thickness [mm] 10 Minimum thickness [mm] 8.4 Brake Disc Type: Solid	
1.6 1.6 CRDi 1.8	103 06/11→08/15 94 02/11→12/15 110 09/10→	Fitting Position: Rear Axle	24.0110-0368.1 410368	Outer diameter [mm]: 262 Brake Disc Thickness [mm] 10 Minimum thickness [mm] 8.4 Brake Disc Type: Solid	
HYUNDAI - ELANTRA VI Saloon (AD, ADA) 09/15→					
 Brake Disc					
1.6 1.6 D 1.6 SR Turbo	94 - 09/15→ 97 100 02/16→ 150 02/16→	Fitting Position: Rear Axle	24.0110-0408.1 410408	Outer diameter [mm]: 262 Brake Disc Thickness [mm] 10 Minimum thickness [mm] 8.4 Brake Disc Type: Solid	
2.0 2.0 MPI	110 02/16→ 115 10/17→	Fitting Position: Rear Axle	24.0110-0368.1 410368	Outer diameter [mm]: 262 Brake Disc Thickness [mm] 10 Minimum thickness [mm] 8.4 Brake Disc Type: Solid	
2.0	112 10/15→	Fitting Position: Rear Axle	24.0110-0368.1 410368 24.0110-0408.1 410408	Outer diameter [mm]: 262 Brake Disc Thickness [mm] 10 Minimum thickness [mm] 8.4 Brake Disc Type: Solid Outer diameter [mm]: 262 Brake Disc Thickness [mm] 10 Minimum thickness [mm] 8.4 Brake Disc Type: Solid	
HYUNDAI - ELANTRA VII Saloon (CN7) 03/20→					
 Brake Disc					
1.6 2.0	90 03/20→ 110 03/21→	Fitting Position: Rear Axle	24.0110-0408.1 410408	Outer diameter [mm]: 262 Brake Disc Thickness [mm] 10 Minimum thickness [mm] 8.4 Brake Disc Type: Solid	
HYUNDAI - GRANDEUR (HG) 01/11→					
 Brake Disc					
2.2 D 2.4 2.4 16V 2.4 GDI 2.4 Hybrid →	147 - 01/11→ 149 132 07/11→ 148 01/11→10/16 140 02/11→04/16 117 07/11→	Vehicle Equipment: for vehicles with electric parking brake; Fitting Position: Rear Axle	24.0110-0400.1 410400	Outer diameter [mm]: 284 Brake Disc Thickness [mm] 10 Minimum thickness [mm] 8.4 Brake Disc Type: Solid	



	kw				
HYUNDAI - GRANDEUR (HG) 01/11→					
 Brake Disc					
3.0 3.0 LPG 3.0 MPI 3.3	199 02/11→10/16 173 01/11→12/11 184 07/11→ 216 02/11→10/16	Vehicle Equipment: for vehicles with electric parking brake; Fitting Position: Rear Axle	24.0110-0400.1 410400	Outer diameter [mm]: 284 Brake Disc Thickness [mm] 10 Minimum thickness [mm] 8.4 Brake Disc Type: Solid	
HYUNDAI - GRANDEUR (IG) 11/16→					
 Brake Disc					
2.2 CRDi 2.4 GDI 2.4 Hybrid	149 11/16→ 140 11/16→ 117 04/17→	Fitting Position: Rear Axle	24.0110-0400.1 410400	Outer diameter [mm]: 284 Brake Disc Thickness [mm] 10 Minimum thickness [mm] 8.4 Brake Disc Type: Solid	
HYUNDAI - i20 III (BC3, BI3) 08/20→					
 Brake Disc					
1.6 T-GDi	150 11/20→	Fitting Position: Rear Axle	24.0110-0408.1 410408	Outer diameter [mm]: 262 Brake Disc Thickness [mm] 10 Minimum thickness [mm] 8.4 Brake Disc Type: Solid	
HYUNDAI - i30 (PDE, PD, PDEN) 11/16→					
 Brake Pad Set, disc brake					
1.0 T-GDI 1.0 T-GDI hybrid 48V 1.4 T-GDI 1.5 T-GDI hybrid 48V 1.6 CRDi 1.6 CRDi hybrid 48V	88 11/16→ 88 03/20→ 103 11/16→ 118 03/20→ 70 - 11/16→ 100 100 03/20→	Brake Size: 15" / 16"; Fitting Position: Front Axle	13.0460-5510.2 605510	Brake System: Mobis Wear Warning Contact: with acoustic wear warning Supplementary Article/Supplementary Info: with accessories	
1.4 MPI 1.6 CRDi	74 11/16→ 100 11/16→	Brake Size: 16" / 15"; Fitting Position: Front Axle	13.0460-5510.2 605510	Brake System: Mobis Wear Warning Contact: with acoustic wear warning Supplementary Article/Supplementary Info: with accessories	
1.5	81 06/20→	Brake Size: 16"; Fitting Position: Front Axle	13.0460-5510.2 605510	Brake System: Mobis Wear Warning Contact: with acoustic wear warning Supplementary Article/Supplementary Info: with accessories	
 Brake Disc					
1.0 T-GDI 1.4 MPI 1.4 T-GDI 1.6 CRDi	88 11/16→ 74 11/16→ 103 11/16→ 70 - 11/16→ 100	Construction year from: 01/17 →; Vehicle Equipment: for vehicles with electric parking brake; Fitting Position: Rear Axle	24.0110-0400.1 410400	Outer diameter [mm]: 284 Brake Disc Thickness [mm] 10 Minimum thickness [mm] 8.4 Brake Disc Type: Solid	
1.0 T-GDI hybrid 48V 1.5 1.5 T-GDI hybrid 48V 1.6 CRDi 1.6 CRDi hybrid 48V	88 03/20→ 81 06/20→ 118 03/20→ 70 - 08/18→ 100 100 03/20→	Vehicle Equipment: for vehicles with electric parking brake; Fitting Position: Rear Axle	24.0110-0400.1 410400	Outer diameter [mm]: 284 Brake Disc Thickness [mm] 10 Minimum thickness [mm] 8.4 Brake Disc Type: Solid	
HYUNDAI - i30 Estate (PDE) 03/17→					
 Brake Pad Set, disc brake					
1.0 T-GDI 1.0 T-GDI hybrid 48V 1.4 T-GDI 1.5 T-GDI Hybrid 48V 1.6 CRDi 1.6 CRDi hybrid 48V	88 03/17→ 88 03/20→ 103 03/17→ 118 03/20→ 81 - 03/17→ 100 100 03/20→	Brake Size: 15" / 16"; Fitting Position: Front Axle	13.0460-5510.2 605510	Brake System: Mobis Wear Warning Contact: with acoustic wear warning Supplementary Article/Supplementary Info: with accessories	
1.4 MPI	74 03/17→	Brake Size: 16"; Fitting Position: Front Axle	13.0460-5510.2 605510	Brake System: Mobis Wear Warning Contact: with acoustic wear warning Supplementary Article/Supplementary Info: with accessories	
1.5	81 06/20→	Brake Size: 16"; Fitting Position: Front Axle	13.0460-5510.2 605510	Brake System: Mobis Wear Warning Contact: with acoustic wear warning Supplementary Article/Supplementary Info: with accessories	
→					



	kW				
HYUNDAI - i30 Estate (PDE) 03/17→					
 Brake Pad Set, disc brake					
1.5	81 06/20→	Brake Size: 15"; Fitting Position: Front Axle	13.0460-5510.2 605510	Brake System: Mobis Wear Warning Contact: with acoustic wear warning Supplementary Article/Supplementary Info: with accessories	
 Brake Disc					
1.0 T-GDI 1.4 T-GDI 1.6 CRDi	88 03/17→ 103 03/17→ 81 - 03/17→ 100	Construction year from: 06/17 →; Vehicle Equipment: for vehicles with electric parking brake; Fitting Position: Rear Axle	24.0110-0400.1 410400	Outer diameter [mm]: 284 Brake Disc Thickness [mm] 10 Minimum thickness [mm] 8.4 Brake Disc Type: Solid	
1.0 T-GDI hybrid 48V 1.4 MPI 1.5 1.5 T-GDI Hybrid 48V 1.6 CRDi 1.6 CRDi hybrid 48V	88 03/20→ 74 03/17→ 81 06/20→ 118 03/20→ 81 - 08/18→ 100 100 03/20→	Vehicle Equipment: for vehicles with electric parking brake; Fitting Position: Rear Axle	24.0110-0400.1 410400	Outer diameter [mm]: 284 Brake Disc Thickness [mm] 10 Minimum thickness [mm] 8.4 Brake Disc Type: Solid	
HYUNDAI - i30 FASTBACK (PDE, PDEN) 06/17→					
 Brake Pad Set, disc brake					
1.0 T-GDI 1.4 T-GDI 1.5 T-GDI Hybrid 48V 1.6 CRDi 1.6 CRDi hybrid 48V	88 06/17→ 103 06/17→ 118 03/20→ 100 08/18→ 100 03/20→	Brake Size: 15" / 16"; Fitting Position: Front Axle	13.0460-5510.2 605510	Brake System: Mobis Wear Warning Contact: with acoustic wear warning Supplementary Article/Supplementary Info: with accessories	
1.0 T-GDI hybrid 48V	88 06/17→	Brake Size: 15"; Fitting Position: Front Axle	13.0460-5510.2 605510	Brake System: Mobis Wear Warning Contact: with acoustic wear warning Supplementary Article/Supplementary Info: with accessories	
		Brake Size: 16"; Fitting Position: Front Axle	13.0460-5510.2 605510	Brake System: Mobis Wear Warning Contact: with acoustic wear warning Supplementary Article/Supplementary Info: with accessories	
 Brake Disc					
1.0 T-GDI 1.0 T-GDI hybrid 48V 1.4 T-GDI 1.5 T-GDI Hybrid 48V 1.6 CRDi 1.6 CRDi hybrid 48V	88 06/17→ 88 06/17→ 103 06/17→ 118 03/20→ 100 08/18→ 100 03/20→	Vehicle Equipment: for vehicles with electric parking brake; Fitting Position: Rear Axle	24.0110-0400.1 410400	Outer diameter [mm]: 284 Brake Disc Thickness [mm] 10 Minimum thickness [mm] 8.4 Brake Disc Type: Solid	
HYUNDAI - i30 Hatchback Van (PDE) 11/16→					
 Brake Pad Set, disc brake					
1.0 T-GDi 1.4 T-GDi	88 11/16→ 103 11/16→	Brake Size: 15" / 16"; Fitting Position: Front Axle	13.0460-5510.2 605510	Brake System: Mobis Wear Warning Contact: with acoustic wear warning Supplementary Article/Supplementary Info: with accessories	
 Brake Disc					
1.0 T-GDi 1.4 T-GDi	88 11/16→ 103 11/16→	Vehicle Equipment: for vehicles with electric parking brake; Fitting Position: Rear Axle	24.0110-0400.1 410400	Outer diameter [mm]: 284 Brake Disc Thickness [mm] 10 Minimum thickness [mm] 8.4 Brake Disc Type: Solid	
HYUNDAI - i30 Kombi Van (PDE) 03/17→					
 Brake Pad Set, disc brake					
1.0 T-GDi 1.4 T-GDi 1.6 CRDi VGT	88 03/17→ 103 03/17→ 81 - 03/17→ 100	Brake Size: 15" / 16"; Fitting Position: Front Axle	13.0460-5510.2 605510	Brake System: Mobis Wear Warning Contact: with acoustic wear warning Supplementary Article/Supplementary Info: with accessories	
 Brake Disc					
1.0 T-GDi 1.4 T-GDi 1.6 CRDi VGT	88 03/17→ 103 03/17→ 81 - 03/17→ 100	Construction year from: 06/17 →; Vehicle Equipment: for vehicles with electric parking brake; Fitting Position: Rear Axle	24.0110-0400.1 410400	Outer diameter [mm]: 284 Brake Disc Thickness [mm] 10 Minimum thickness [mm] 8.4 Brake Disc Type: Solid	



	kW				
HYUNDAI - IONIQ (AE) 03/16→					
 Brake Disc					
1.6 GDI Hybrid	77 - 03/16→ 104	Fitting Position: Rear Axle	24.0110-0400.1 410400	Outer diameter [mm]: 284 Brake Disc Thickness [mm] 10 Minimum thickness [mm] 8.4 Brake Disc Type: Solid	
1.6 GDI Plug-in Hybrid Electric	77 03/16→ 88 - 03/16→ 100				
Elektro	25 03/16→		24.0110-0408.1 410408	Outer diameter [mm]: 262 Brake Disc Thickness [mm] 10 Minimum thickness [mm] 8.4 Brake Disc Type: Solid	
HYUNDAI - KONA (OS, OSE, OSI) 06/17→					
 Brake Disc					
1.0 T-GDi	88 07/17→	Brake Size: 14"; Fitting Position: Rear Axle	24.0110-0368.1 410368	Outer diameter [mm]: 262 Brake Disc Thickness [mm] 10 Minimum thickness [mm] 8.4 Brake Disc Type: Solid	
1.0 T-GDi Hybrid 48V	88 11/20→				
1.6 GDi Hybrid	77 - 06/19→ 104	Fitting Position: Rear Axle	24.0110-0400.1 410400	Outer diameter [mm]: 284 Brake Disc Thickness [mm] 10 Minimum thickness [mm] 8.4 Brake Disc Type: Solid	
HYUNDAI - KONA SUV Van (OS, OSE, OSI) 06/17→					
 Brake Disc					
1.0 T-GDi	88 07/17→	Brake Size: 14"; Fitting Position: Rear Axle	24.0110-0368.1 410368	Outer diameter [mm]: 262 Brake Disc Thickness [mm] 10 Minimum thickness [mm] 8.4 Brake Disc Type: Solid	
1.6 GDi Hybrid	77 - 06/19→ 104	Fitting Position: Rear Axle	24.0110-0400.1 410400	Outer diameter [mm]: 284 Brake Disc Thickness [mm] 10 Minimum thickness [mm] 8.4 Brake Disc Type: Solid	
HYUNDAI - SONATA VII (LF) 06/14→					
 Brake Disc					
2.0	113 - 06/14→ 180	Vehicle Equipment: for vehicles with electric parking brake; Brake Size: 15"; Fitting Position: Rear Axle	24.0110-0400.1 410400	Outer diameter [mm]: 284 Brake Disc Thickness [mm] 10 Minimum thickness [mm] 8.4 Brake Disc Type: Solid	
2.0 CVVL	124 09/14→				
2.0 Hybrid	110 - 09/14→ 153				
2.0 LPG	111 - 06/14→ 113				
2.0 MPI	115 06/14→				
2.4	126 - 09/14→ 138				
2.0 CVVT	110 11/14→	Vehicle Equipment: for vehicles with electric parking brake; Fitting Position: Rear Axle	24.0110-0400.1 410400	Outer diameter [mm]: 284 Brake Disc Thickness [mm] 10 Minimum thickness [mm] 8.4 Brake Disc Type: Solid	
HYUNDAI - VELOSTER (FS) 03/11→12/17					
 Brake Disc					
1.6	94 06/11→12/17	Fitting Position: Rear Axle	24.0110-0368.1 410368	Outer diameter [mm]: 262 Brake Disc Thickness [mm] 10 Minimum thickness [mm] 8.4 Brake Disc Type: Solid	
1.6 GDi	95 10/11→12/17				
1.6 GDI	103 03/11→12/17				
1.6 MPI	97 04/11→12/17				
1.6 T-GDI	137 - 08/12→12/17 150				
ISUZU - D-MAX I (TFR, TFS) 05/02→12/12					
 Wheel Brake Cylinder					
2.5	56 10/06→10/12	Required quantity: 2; Suspension: for vehicles with increased ground clearance; Fitting Position: Rear Axle	2 24.3223-1710.3 020557	Material: Aluminium	
2.5 DiTD	85 - 10/06→06/12 100	Construction year from: 10/07 → → Construction year to: 05/12;	2 24.3223-1710.3 020557	Material: Aluminium	
2.5 DiTD 4x4	85 10/06→06/12	Required quantity: 2;			
3.0 DiTD	120 01/07→06/12	Fitting Position: Rear Axle			
2.5 DiTD 4x4	100 01/07→06/12	→ Construction year to: 05/12;	2 24.3223-1710.3 020557	Material: Aluminium	
3.0 DiTD 4x4	120 01/07→06/12	Required quantity: 2; Fitting Position: Rear Axle			
3.0 D 4WD	88 06/03→10/04	Required quantity: 2;	2 24.3223-1710.3 020557	Material: Aluminium	
3.0 DiTD 4x4	100 06/03→12/12	Fitting Position: Rear Axle			
3.0 DiTD 4x4	96 05/02→06/12	Construction year from: 06/03 → → Construction year to: 05/12;	2 24.3223-1710.3 020557	Material: Aluminium	
→					



	kw				
ISUZU - D-MAX I (TFR, TFS) 05/02→12/12					
 Wheel Brake Cylinder					
3.0 DiTD 4x4	96 05/02→06/12	Required quantity: 2; Fitting Position: Rear Axle			
ISUZU - D-MAX I Platform/Chassis (TFR, TFS) 10/06→10/12					
 Wheel Brake Cylinder					
2.5 DiTD	100 10/06→06/12	Required quantity: 2; Suspension: for vehicles with increased ground clearance; Fitting Position: Rear Axle	2	24.3223-1710.3 020557	Material: Aluminium
2.5 DiTD 4x4	100 10/06→10/12	Required quantity: 2; Fitting Position: Rear Axle	2	24.3223-1710.3 020557	Material: Aluminium
3.0 D 4x4	120 01/07→06/12	→ Construction year to: 05/12; Fitting Position: Rear Axle		24.3223-1710.3 020557	Material: Aluminium
ISUZU - D-MAX II (TFR, TFS) 06/12→					
 Wheel Brake Cylinder					
1.9 Ddi 1.9 Ddi 4x4	120 03/17→ 120 03/17→	Required quantity: 2; Suspension: for vehicles with increased ground clearance; Fitting Position: Rear Axle	2	24.3223-1710.3 020557	Material: Aluminium
2.5 CRDi 2.5 CRDi 4x4	58 - 06/12→ 120 80 - 06/12→ 120	Required quantity: 2; Fitting Position: Rear Axle	2	24.3223-1710.3 020557	Material: Aluminium
ISUZU - D-MAX II Platform/Chassis (TFR, TFS) 06/12→					
 Wheel Brake Cylinder					
2.5 CRDi 2.5 CRDi 4WD	120 06/12→ 120 06/12→	Fitting Position: Rear Axle		24.3223-1710.3 020557	Material: Aluminium
ISUZU - D-MAX III (TFR, TFS) 11/19→					
 Wheel Brake Cylinder					
1.9 DDI 1.9 DDI 4x4 3.0 DDI 4x4	110 - 11/19→ 120 110 - 11/19→ 120 130 11/19→	Required quantity: 2; Fitting Position: Rear Axle	2	24.3223-1710.3 020557	Material: Aluminium
ISUZU - KB 07/02→					
 Wheel Brake Cylinder					
3.0 D-TEQ 4WD	120 08/10→	Required quantity: 2; Fitting Position: Rear Axle	2	24.3223-1710.3 020557	Material: Aluminium
IVECO - DAILY II Dump Truck 01/89→05/99					
 Brake Pad Set, disc brake					
35-12 K	90 09/96→08/98	Fitting Position: Front Axle		13.0460-4966.2 604966	Brake System: Brembo 29121 20,3 Wear Warning Contact: prepared for wear indicator / excl. wear warning contact
		Fitting Position: Rear Axle		13.0460-4966.2 604966	Brake System: Brembo 29121 20,3 Wear Warning Contact: prepared for wear indicator / excl. wear warning contact
 Brake Shoe Set, parking brake					
35-12 K	90 09/96→08/98	Fitting Position: Rear Axle		03.0137-3005.2 653005	Brake diameter, inside [mm]: 172 Width [mm] 42 Supplementary Article/Supple- mentary Info: without lever
IVECO - DAILY II Platform/Chassis 01/89→05/99					
 Brake Pad Set, disc brake					
35-10 35-12 49-12	76 - 01/89→12/96 80 85 01/90→04/96 85 06/90→04/96	Construction year from: 01/96 →; Fitting Position: Front Axle		13.0460-4966.2 604966	Brake System: Brembo 29121 20,3 Wear Warning Contact: prepared for wear indicator / excl. wear warning contact
→					

	kW				
IVECO - DAILY II Platform/Chassis 01/89→05/99					
 Brake Pad Set, disc brake					
35-10 35-12 49-12	76 - 01/89→12/96 80 85 01/90→04/96 85 06/90→04/96	Construction year from: 01/96 →; Fitting Position: Rear Axle	13.0460-4966.2 604966	Brake System: Brembo 29121 20,3 Wear Warning Contact: prepared for wear indicator / excl. wear warning contact	
35-10 35-12 49-12	76 01/96→05/99 90 05/96→05/99 90 05/96→05/99	→ Construction year to: 04/99; Fitting Position: Front Axle	13.0460-4966.2 604966	Brake System: Brembo 29121 20,3 Wear Warning Contact: prepared for wear indicator / excl. wear warning contact	
		→ Construction year to: 04/99; Fitting Position: Rear Axle	13.0460-4966.2 604966	Brake System: Brembo 29121 20,3 Wear Warning Contact: prepared for wear indicator / excl. wear warning contact	
 Brake Shoe Set, parking brake					
35-10 35-12 49-12	76 - 01/89→12/96 80 85 01/90→04/96 85 06/90→04/96	Construction year from: 01/96 →; Fitting Position: Rear Axle	03.0137-3005.2 653005	Brake diameter, inside [mm]: 172 Width [mm] 42 Supplementary Article/Supple- mentary Info: without lever	
35-10 35-12 49-12	76 01/96→05/99 90 05/96→05/99 90 05/96→05/99	→ Construction year to: 04/99; Fitting Position: Rear Axle	03.0137-3005.2 653005	Brake diameter, inside [mm]: 172 Width [mm] 42 Supplementary Article/Supple- mentary Info: without lever	
IVECO - DAILY II Van 01/89→08/09					
 Brake Pad Set, disc brake					
35-10 35-12 49-12 V	76 - 01/89→08/98 80 85 01/90→04/96 85 06/90→04/96	Construction year from: 01/96 →; Fitting Position: Front Axle	13.0460-4966.2 604966	Brake System: Brembo 29121 20,3 Wear Warning Contact: prepared for wear indicator / excl. wear warning contact	
		Construction year from: 01/96 →; Fitting Position: Rear Axle	13.0460-4966.2 604966	Brake System: Brembo 29121 20,3 Wear Warning Contact: prepared for wear indicator / excl. wear warning contact	
35-10 49-12 V	76 01/96→05/99 90 05/96→05/99	→ Construction year to: 04/99; Fitting Position: Front Axle	13.0460-4966.2 604966	Brake System: Brembo 29121 20,3 Wear Warning Contact: prepared for wear indicator / excl. wear warning contact	
		→ Construction year to: 04/99; Fitting Position: Rear Axle	13.0460-4966.2 604966	Brake System: Brembo 29121 20,3 Wear Warning Contact: prepared for wear indicator / excl. wear warning contact	
 Brake Shoe Set, parking brake					
35-10 35-12 49-12 V	76 - 01/89→08/98 80 85 01/90→04/96 85 06/90→04/96	Construction year from: 01/96 →; Fitting Position: Rear Axle	03.0137-3005.2 653005	Brake diameter, inside [mm]: 172 Width [mm] 42 Supplementary Article/Supple- mentary Info: without lever	
35-10 49-12 V	76 01/96→05/99 90 05/96→05/99	→ Construction year to: 04/99; Fitting Position: Rear Axle	03.0137-3005.2 653005	Brake diameter, inside [mm]: 172 Width [mm] 42 Supplementary Article/Supple- mentary Info: without lever	
IVECO - DAILY III Platform/Chassis 03/98→10/09					
 Brake Pad Set, disc brake					
29 L 10 29 L 11 29 L 12 29 L 13 29 L 14 29 L 9	70 09/02→04/06 78 05/99→04/06 85 09/02→04/06 92 11/01→04/06 100 11/05→04/06 62 - 05/99→04/06 66	Fitting Position: Front Axle	13.0460-4966.2 604966	Brake System: Brembo 29121 20,3 Wear Warning Contact: prepared for wear indicator / excl. wear warning contact	
35 C 11 35 S 11 35 S 13 35 C 13 35 S 9 35 C 9	78 05/99→04/06 78 05/99→04/06 92 05/99→04/06 92 05/99→04/06 62 05/99→04/06 62 05/99→04/06	Fitting Position: Rear Axle	13.0460-4996.2 604996	Brake System: Brembo 29123 20,3 Wear Warning Contact: prepared for wear indicator / excl. wear warning contact	
→					

	kW				
IVECO - DAILY III Platform/Chassis 03/98→10/09					
 Brake Pad Set, disc brake					
35 S 10 V	70	09/02→04/06	Fitting Position: Front Axle	13.0460-4966.2 604966	Brake System: Brembo 29121 20,3 Wear Warning Contact: prepared for wear indicator / excl. wear warning contact
35 C 10 V	70	09/02→04/06			
35 S 12	85	09/02→04/06			
35 C 12	85	09/02→04/06			
35 C 14	100	09/04→04/06			
35 S 14	100	01/05→04/06	Fitting Position: Rear Axle	13.0460-4966.2 604966	Brake System: Brembo 29121 20,3 Wear Warning Contact: prepared for wear indicator / excl. wear warning contact
35 C 15	107	11/01→04/06			
35 C 17	122	01/05→04/06			
35 S 17	122	01/05→04/06			
35 C 9	66	11/01→04/06			
35 S 9	66	11/01→04/06			
50 C 13	92	05/99→04/06			
50 C 11	78	05/99→04/06	Fitting Position: Rear Axle	13.0460-4996.2 604996	Brake System: Brembo 29123 20,3 Wear Warning Contact: prepared for wear indicator / excl. wear warning contact
50 C 14	100	09/04→04/06			
50 C 17	122	09/04→04/06			
50 C 15	107	01/01→04/06	Fitting Position: Front Axle	13.0460-4966.2 604966	Brake System: Brembo 29121 20,3 Wear Warning Contact: prepared for wear indicator / excl. wear warning contact
			Fitting Position: Rear Axle		
65 C 15	107	11/01→04/06	Fitting Position: Rear Axle	13.0460-4966.2 604966	Brake System: Brembo 29121 20,3 Wear Warning Contact: prepared for wear indicator / excl. wear warning contact
65 C 17	122	09/04→04/06			
 Brake Shoe Set, parking brake					
29 L 10	70	09/02→04/06	Fitting Position: Rear Axle	03.0137-3005.2 653005	Brake diameter, inside [mm]: 172 Width [mm] 42 Supplementary Article/Supplementary Info: without lever
29 L 11	78	05/99→04/06			
29 L 12	85	09/02→04/06			
29 L 13	92	11/01→04/06			
29 L 14	100	11/05→04/06			
29 L 9	62 - 05/99→04/06 66				
35 S 10 V	70	09/02→04/06			
35 C 10 V	70	09/02→04/06			
35 S 12	85	09/02→04/06			
35 C 12	85	09/02→04/06			
35 C 14	100	09/04→04/06			
35 S 14	100	01/05→04/06			
35 C 15	107	11/01→04/06			
35 C 17	122	01/05→04/06			
35 S 17	122	01/05→04/06			
35 C 9	66	11/01→04/06			
35 S 9	66	11/01→04/06			
50 C 11	78	05/99→04/06			
50 C 13	92	05/99→04/06			
50 C 14	100	09/04→04/06			
50 C 17	122	09/04→04/06			
50 C 15	107	01/01→04/06	→ Vehicle Identification Number to: 12947747; Fitting Position: Rear Axle		
IVECO - DAILY III Van 05/99→10/09					
 Brake Pad Set, disc brake					
29 L 10 V	70	09/02→07/07	→ Construction year to: 04/06;	13.0460-4966.2 604966	Brake System: Brembo 29121 20,3 Wear Warning Contact: prepared for wear indicator / excl. wear warning contact
29 L 11 V	78	05/99→07/07	Fitting Position: Front Axle		
29 L 12 V	85	09/02→07/07			
29 L 13	92	05/01→07/07			
29 L 9 V	62	05/99→07/07			
35 S 10	70	09/02→07/07	→ Construction year to: 04/06;	13.0460-4996.2 604996	Brake System: Brembo 29123 20,3 Wear Warning Contact: prepared for wear indicator / excl. wear warning contact
35 S 11 V	78	05/99→07/07	Fitting Position: Rear Axle		
35 C 11 V	78	05/99→07/07			
35 C 13 V	92	05/99→07/07			
35 S 13 V	92	05/99→07/07			
35 S 15 V	107	11/02→07/07			
35 C 15 V	107	11/02→07/07			
35 C 9 V	62	05/99→07/07			
→					

	kW				
IVECO - DAILY III Van 05/99→10/09					
 Brake Pad Set, disc brake					
35 S 9 V	62 05/99→07/07	→ Construction year to: 04/06; Fitting Position: Front Axle	13.0460-4966.2 604966	Brake System: Brembo 29121 20,3 Wear Warning Contact: prepared for wear indicator / excl. wear warning contact	
		→ Construction year to: 04/06; Fitting Position: Rear Axle	13.0460-4996.2 604996	Brake System: Brembo 29123 20,3 Wear Warning Contact: prepared for wear indicator / excl. wear warning contact	
29 L 14 29 L 9 V 35 S 9 V	100 01/05→04/06 66 11/01→04/06 66 11/01→04/06	Fitting Position: Front Axle	13.0460-4966.2 604966	Brake System: Brembo 29121 20,3 Wear Warning Contact: prepared for wear indicator / excl. wear warning contact	
		Fitting Position: Rear Axle	13.0460-4996.2 604996	Brake System: Brembo 29123 20,3 Wear Warning Contact: prepared for wear indicator / excl. wear warning contact	
35 C 12 V 35 S 12 V	85 09/02→07/07 85 09/02→07/07	→ Construction year to: 04/06; Fitting Position: Front Axle	13.0460-4966.2 604966	Brake System: Brembo 29121 20,3 Wear Warning Contact: prepared for wear indicator / excl. wear warning contact	
		→ Construction year to: 04/06; Fitting Position: Rear Axle	13.0460-4966.2 604966 13.0460-4996.2 604996	Brake System: Brembo 29121 20,3 Wear Warning Contact: prepared for wear indicator / excl. wear warning contact Brake System: Brembo 29123 20,3 Wear Warning Contact: prepared for wear indicator / excl. wear warning contact	
35 C 14 35 S 14 35 C 17 35 S 17	100 09/04→04/06 100 01/05→04/06 122 01/05→04/06 122 01/05→04/06	Fitting Position: Front Axle	13.0460-4966.2 604966	Brake System: Brembo 29121 20,3 Wear Warning Contact: prepared for wear indicator / excl. wear warning contact	
		Fitting Position: Rear Axle	13.0460-4966.2 604966 13.0460-4996.2 604996	Brake System: Brembo 29121 20,3 Wear Warning Contact: prepared for wear indicator / excl. wear warning contact Brake System: Brembo 29123 20,3 Wear Warning Contact: prepared for wear indicator / excl. wear warning contact	
50 C 11 50 C 13	78 05/99→07/07 92 05/99→07/07	→ Construction year to: 04/06; Fitting Position: Rear Axle	13.0460-4996.2 604996	Brake System: Brembo 29123 20,3 Wear Warning Contact: prepared for wear indicator / excl. wear warning contact	
50 C 14 50 C 15 50 C 17	100 09/04→04/06 107 01/01→04/06 122 09/04→04/06	Fitting Position: Rear Axle	13.0460-4996.2 604996	Brake System: Brembo 29123 20,3 Wear Warning Contact: prepared for wear indicator / excl. wear warning contact	
65 C 14 65 C 15 65 C 17	100 09/04→04/06 107 11/01→04/06 122 09/04→04/06	Fitting Position: Rear Axle	13.0460-4966.2 604966	Brake System: Brembo 29121 20,3 Wear Warning Contact: prepared for wear indicator / excl. wear warning contact	
 Brake Shoe Set, parking brake					
29 L 10 V 29 L 11 V 29 L 12 V 29 L 13 29 L 9 V 35 C 12 V 35 S 12 V 50 C 11 50 C 13	70 09/02→07/07 78 05/99→07/07 85 09/02→07/07 92 05/01→07/07 62 05/99→07/07 85 09/02→07/07 85 09/02→07/07 78 05/99→07/07 92 05/99→07/07	→ Construction year to: 04/06; Fitting Position: Rear Axle	03.0137-3005.2 653005	Brake diameter, inside [mm]: 172 Width [mm] 42 Supplementary Article/Supplementary Info: without lever	
→					

	kW				
IVECO - DAILY III Van 05/99→10/09					
 Brake Shoe Set, parking brake					
29 L 14	100 01/05→04/06	Fitting Position: Rear Axle	03.0137-3005.2 653005	Brake diameter, inside [mm]: 172 Width [mm] 42 Supplementary Article/Supplementary Info: without lever	
29 L 9 V	66 11/01→04/06				
35 C 14	100 09/04→04/06				
35 S 14	100 01/05→04/06				
35 C 17	122 01/05→04/06				
35 S 17	122 01/05→04/06				
50 C 14	100 09/04→04/06				
50 C 15	107 01/01→04/06				
50 C 17	122 09/04→04/06				
IVECO - DAILY IV Bus 05/06→08/11					
 Brake Pad Set, disc brake					
35S14	100 05/06→08/11	Fitting Position: Front Axle	13.0460-4830.2 604830	Brake System: Brembo 29229 20,7 Wear Warning Contact: prepared for wear indicator / excl. wear warning contact Supplementary Article/Supplementary Info: with accessories	
35S14 /P	100 05/06→08/11				
		Fitting Position: Rear Axle	13.0460-4996.2 604996	Brake System: Brembo 29123 20,3 Wear Warning Contact: prepared for wear indicator / excl. wear warning contact	
Brake Disc					
35S14	100 05/06→08/11	Rim Hole Number: 6; Fitting Position: Front Axle	24.0128-0238.1 428238	Outer diameter [mm]: 300 Brake Disc Thickness [mm] 28 Minimum thickness [mm] 25 Brake Disc Type: Vented	
35S14 /P	100 05/06→08/11				
		Fitting Position: Front Axle	24.0128-0239.1 428239	Outer diameter [mm]: 290 Brake Disc Thickness [mm] 28 Minimum thickness [mm] 25 Brake Disc Type: Vented	
IVECO - DAILY IV Platform/Chassis 05/06→03/12					
 Brake Pad Set, disc brake					
29L10	70 05/06→08/11	Fitting Position: Front Axle	13.0460-4830.2 604830	Brake System: Brembo 29229 20,7 Wear Warning Contact: prepared for wear indicator / excl. wear warning contact Supplementary Article/Supplementary Info: with accessories	
29L12	85 05/06→08/11				
29L14	100 05/06→08/11				
35C10	70 05/06→08/11				
35S10	70 05/06→08/11				
35S11 /P	78 07/07→08/11				
35S11 D	78 07/07→08/11				
35C11	78 07/07→08/11				
35S11	78 07/07→08/11	Fitting Position: Rear Axle	13.0460-4996.2 604996	Brake System: Brembo 29123 20,3 Wear Warning Contact: prepared for wear indicator / excl. wear warning contact	
35C12	85 05/06→08/11				
35S12	85 05/06→08/11				
35S13 D	93 07/07→08/11				
35C13	93 07/07→08/11				
35C13 /P	93 07/07→08/11				
35S13	93 07/07→08/11				
35S13 /P	93 07/07→08/11				
35C14	100 - 05/06→08/11 103				
35S14 D/P	103 09/09→08/11				
35C14 /P	103 09/09→08/11				
35S14	100 - 05/06→08/11 103				
35S14 /P	100 - 05/06→08/11 103				
35S14 D	103 09/09→08/11				
35S14 G/P	100 07/07→08/11				
35C14 G/P	100 07/07→08/11				
35S14 G	100 07/07→08/11				
35C14 GD	100 07/07→08/11				
35C14 G	100 07/07→08/11				
...	100 07/07→08/11				
35C15	107 05/06→08/11				
35C17	125 07/07→08/11				
35C17 /P	125 07/07→08/11				
35S17 D	125 07/07→08/11				
35S17 /P	125 07/07→08/11				
35S17	125 07/07→08/11				
35S18	130 05/06→08/11				
35C18	130 05/06→08/11				
35S17 WD	125 07/07→08/11				
35S17 W	125 07/07→08/11				
→					

	kW				
IVECO - DAILY IV Platform/Chassis 05/06→03/12					
 Brake Pad Set, disc brake					
40C10	70 05/06→08/11	Code: 40C; Fitting Position: Front Axle	13.0460-4830.2 604830	Brake System: Brembo 29229 20,7 Wear Warning Contact: prepared for wear indicator / excl. wear warning contact Supplementary Article/Supplementary Info: with accessories	
40C11	78 07/07→08/11				
40C11 D	78 07/07→08/11				
40C12	85 05/06→08/11				
40C13	93 07/07→08/11				
40C13 /P	93 07/07→08/11				
40C14 /P	103 09/09→08/11				
40C14	103 09/09→08/11	Code: 40C; Fitting Position: Rear Axle	13.0460-4966.2 604966	Brake System: Brembo 29121 20,3 Wear Warning Contact: prepared for wear indicator / excl. wear warning contact	
40C14 G	100 07/07→08/11				
40C14 G/P	100 07/07→08/11				
40C15	107 05/06→08/11				
40C17 /P	125 07/07→08/11				
40C17	125 07/07→08/11				
40C18	130 05/06→08/11				
45C14	103 09/09→08/11	Code: 45C; Fitting Position: Front Axle	13.0460-4830.2 604830	Brake System: Brembo 29229 20,7 Wear Warning Contact: prepared for wear indicator / excl. wear warning contact Supplementary Article/Supplementary Info: with accessories	
45C14 /P	103 09/09→08/11				
45C15	107 05/06→08/11				
45C17 /P	125 07/07→08/11				
45C17	125 07/07→08/11				
45C18 /P	130 05/06→08/11				
45C18 D	130 05/06→08/11	Code: 45C; Fitting Position: Rear Axle	13.0460-4966.2 604966	Brake System: Brembo 29121 20,3 Wear Warning Contact: prepared for wear indicator / excl. wear warning contact	
45C18 D/P	130 05/06→08/11				
45C18	130 05/06→08/11				
50C14	103 09/09→08/11	Code: 50C; Fitting Position: Front Axle	13.0460-4830.2 604830	Brake System: Brembo 29229 20,7 Wear Warning Contact: prepared for wear indicator / excl. wear warning contact Supplementary Article/Supplementary Info: with accessories	
50C14 /P	103 09/09→08/11				
50C14 G	100 07/07→08/11				
50C14 GD	100 07/07→08/11				
50C14 GD/P	100 07/07→08/11				
50C14 G/P	100 07/07→08/11				
50C15	107 05/06→08/11				
50C17 /P	125 07/07→08/11	Code: 50C; Fitting Position: Rear Axle	13.0460-4966.2 604966	Brake System: Brembo 29121 20,3 Wear Warning Contact: prepared for wear indicator / excl. wear warning contact	
50C17	125 07/07→08/11				
50C18	130 05/06→08/11	Fitting Position: Front Axle	13.0460-4830.2 604830	Brake System: Brembo 29229 20,7 Wear Warning Contact: prepared for wear indicator / excl. wear warning contact Supplementary Article/Supplementary Info: with accessories	
		Fitting Position: Rear Axle	13.0460-4966.2 604966	Brake System: Brembo 29121 20,3 Wear Warning Contact: prepared for wear indicator / excl. wear warning contact	
55S17 WD	125 07/07→08/11	Code: 55S; Fitting Position: Front Axle	13.0460-4966.2 604966	Brake System: Brembo 29121 20,3 Wear Warning Contact: prepared for wear indicator / excl. wear warning contact	
55S17 W	125 07/07→08/11				
55S18W	130 06/06→08/11	Code: 55S; Fitting Position: Front Axle	13.0460-4830.2 604830	Brake System: Brembo 29229 20,7 Wear Warning Contact: prepared for wear indicator / excl. wear warning contact Supplementary Article/Supplementary Info: with accessories	
			13.0460-4966.2 604966	Brake System: Brembo 29121 20,3 Wear Warning Contact: prepared for wear indicator / excl. wear warning contact	
		Code: 55S; Fitting Position: Rear Axle	13.0460-4996.2 604996	Brake System: Brembo 29123 20,3 Wear Warning Contact: prepared for wear indicator / excl. wear warning contact	
 Brake Disc					
29L10	70 05/06→08/11	Rim Hole Number: 6;	24.0128-0238.1 428238	Outer diameter [mm]: 300 Brake Disc Thickness [mm] 28 Minimum thickness [mm] 25 Brake Disc Type: Vented	
29L12	85 05/06→08/11	Fitting Position: Front Axle			
29L14	100 05/06→08/11				
35C10	70 05/06→08/11				
35S10	70 05/06→08/11				
→					



kW

IVECO - DAILY IV Platform/Chassis 05/06→03/12







Brake Disc



35S11 /P	78 07/07→08/11	Fitting Position: Front Axle	24.0128-0239.1 428239	Outer diameter [mm]: 290 Brake Disc Thickness [mm] 28 Minimum thickness [mm] 25 Brake Disc Type: Vented
35S11 D	78 07/07→08/11			
35C11	78 07/07→08/11			
35S11	78 07/07→08/11			
35C12	85 05/06→08/11			
35S12	85 05/06→08/11			
35S13 D	93 07/07→08/11			
35C13	93 07/07→08/11			
35C13 /P	93 07/07→08/11			
35S13	93 07/07→08/11			
35S13 /P	93 07/07→08/11			
35C14	100 - 05/06→08/11			
	103			
35S14 D/P	103 09/09→08/11			
35C14 /P	103 09/09→08/11			
35S14	100 - 05/06→08/11			
	103			
35S14 /P	100 - 05/06→08/11			
	103			
35S14 D	103 09/09→08/11			
35S14 G/P	100 07/07→08/11			
35C14 G/P	100 07/07→08/11			
35S14 G	100 07/07→08/11			
35C14 GD	100 07/07→08/11			
35C14 G	100 07/07→08/11			
...	100 07/07→08/11			
35C15	107 05/06→08/11			
35C17	125 07/07→08/11			
35C17 /P	125 07/07→08/11			
35S17 D	125 07/07→08/11			
35S17 /P	125 07/07→08/11			
35S17	125 07/07→08/11			
35S18	130 05/06→08/11			
35C18	130 05/06→08/11			
35S17 WD	125 07/07→08/11			
35S17 W	125 07/07→08/11			
40C10	70 05/06→08/11	Code: 40C; Fitting Position: Front Axle	24.0128-0239.1 428239	Outer diameter [mm]: 290 Brake Disc Thickness [mm] 28 Minimum thickness [mm] 25 Brake Disc Type: Vented
40C11	78 07/07→08/11			
40C11 D	78 07/07→08/11			
40C12	85 05/06→08/11			
40C13	93 07/07→08/11			
40C13 /P	93 07/07→08/11			
40C14 /P	103 09/09→08/11			
40C14	103 09/09→08/11			
40C14 G	100 07/07→08/11			
40C14 G/P	100 07/07→08/11			
40C15	107 05/06→08/11			
40C17 /P	125 07/07→08/11			
40C17	125 07/07→08/11			
40C18	130 05/06→08/11			
45C14	103 09/09→08/11	Code: 45C; Fitting Position: Front Axle	24.0128-0239.1 428239	Outer diameter [mm]: 290 Brake Disc Thickness [mm] 28 Minimum thickness [mm] 25 Brake Disc Type: Vented
45C14 /P	103 09/09→08/11			
45C15	107 05/06→08/11			
45C17 /P	125 07/07→08/11			
45C17	125 07/07→08/11			
45C18 /P	130 05/06→08/11			
45C18 D	130 05/06→08/11			
45C18 D/P	130 05/06→08/11			
45C18	130 05/06→08/11			
50C14	103 09/09→08/11	Code: 50C; Fitting Position: Front Axle	24.0128-0239.1 428239	Outer diameter [mm]: 290 Brake Disc Thickness [mm] 28 Minimum thickness [mm] 25 Brake Disc Type: Vented
50C14 /P	103 09/09→08/11			
50C14 G	100 07/07→08/11			
50C14 GD	100 07/07→08/11			
50C14 GD/P	100 07/07→08/11			
50C14 G/P	100 07/07→08/11			
50C15	107 05/06→08/11			
50C17 /P	125 07/07→08/11			
50C17	125 07/07→08/11			
50C18	130 05/06→08/11	Fitting Position: Front Axle	24.0128-0239.1 428239	Outer diameter [mm]: 290 Brake Disc Thickness [mm] 28 Minimum thickness [mm] 25 Brake Disc Type: Vented
55S18W	130 06/06→08/11	Code: 55S; Fitting Position: Front Axle	24.0128-0238.1 428238	Outer diameter [mm]: 300 Brake Disc Thickness [mm] 28 Minimum thickness [mm] 25 Brake Disc Type: Vented
65C14 /P	103 09/09→08/11	Fitting Position: Front Axle	24.0128-0238.1 428238	Outer diameter [mm]: 300 Brake Disc Thickness [mm] 28 Minimum thickness [mm] 25 Brake Disc Type: Vented
65C14	103 09/09→08/11			
65C14 G	100 07/07→08/11			
65C14 G/P	100 07/07→08/11			
65C14 GD/P	100 07/07→08/11			
65C14 GD	100 07/07→08/11			
→				



		kW					
IVECO - DAILY IV Platform/Chassis 05/06→03/12							
 Brake Disc							
65C15 /P	107 05/06→08/11	Fitting Position: Front Axle		24.0128-0238.1 428238		Outer diameter [mm]: 300 Brake Disc Thickness [mm] 28 Minimum thickness [mm] 25 Brake Disc Type: Vented	
65C15 D	107 05/06→08/11						
65C15	107 05/06→08/11						
65C15 D/P	107 05/06→08/11						
65C17	125 07/07→08/11						
65C17 /P	125 07/07→08/11						
65C18	130 05/06→08/11						
 Brake Shoe Set, parking brake							
40C10	70 05/06→08/11	Code: 40C; → Vehicle Identification Number to: 12947747; Fitting Position: Rear Axle		03.0137-3005.2 653005		Brake diameter, inside [mm]: 172 Width [mm] 42 Supplementary Article/Supplementary Info: without lever	
40C11	78 07/07→08/11						
40C11 D	78 07/07→08/11						
40C12	85 05/06→08/11						
40C13	93 07/07→08/11						
40C13 /P	93 07/07→08/11						
40C15	107 05/06→08/11						
40C17 /P	125 07/07→08/11						
40C17	125 07/07→08/11						
40C18	130 05/06→08/11						
40C14 /P	103 09/09→08/11	Code: 40C; → Vehicle Identification Number to: 5853305 / D436247; Fitting Position: Rear Axle		03.0137-3005.2 653005		Brake diameter, inside [mm]: 172 Width [mm] 42 Supplementary Article/Supplementary Info: without lever	
40C14	103 09/09→08/11						
40C14 G	100 07/07→08/11	Code: 40C; → Vehicle Identification Number to: 5853305 / D436247 / 12947747; Fitting Position: Rear Axle		03.0137-3005.2 653005		Brake diameter, inside [mm]: 172 Width [mm] 42 Supplementary Article/Supplementary Info: without lever	
40C14 G/P	100 07/07→08/11						
45C14	103 09/09→08/11	Code: 45C; → Vehicle Identification Number to: 12947747; Fitting Position: Rear Axle		03.0137-3005.2 653005		Brake diameter, inside [mm]: 172 Width [mm] 42 Supplementary Article/Supplementary Info: without lever	
45C14 /P	103 09/09→08/11						
45C15	107 05/06→08/11						
45C17 /P	125 07/07→08/11						
45C17	125 07/07→08/11						
45C18 /P	130 05/06→08/11						
45C18 D	130 05/06→08/11						
45C18 D/P	130 05/06→08/11						
45C18	130 05/06→08/11						
50C14	103 09/09→08/11	Code: 50C; → Vehicle Identification Number to: 12947747; Fitting Position: Rear Axle		03.0137-3005.2 653005		Brake diameter, inside [mm]: 172 Width [mm] 42 Supplementary Article/Supplementary Info: without lever	
50C14 /P	103 09/09→08/11						
50C14 G	100 07/07→08/11						
50C14 GD	100 07/07→08/11						
50C14 GD/P	100 07/07→08/11						
50C14 G/P	100 07/07→08/11						
50C15	107 05/06→08/11						
50C17 /P	125 07/07→08/11						
50C17	125 07/07→08/11						
50C18	130 05/06→08/11	→ Vehicle Identification Number to: 12947747; Fitting Position: Rear Axle		03.0137-3005.2 653005		Brake diameter, inside [mm]: 172 Width [mm] 42 Supplementary Article/Supplementary Info: without lever	
IVECO - DAILY IV Van 05/06→03/12							
 Brake Pad Set, disc brake							
29L10 V	70 05/06→08/11	Fitting Position: Front Axle		13.0460-4830.2 604830		Brake System: Brembo 29229 20,7 Wear Warning Contact: prepared for wear indicator / excl. wear warning contact Supplementary Article/Supplementary Info: with accessories	
29L12 V/P	85 05/06→08/11						
29L12 V	85 05/06→08/11						
29L14 C/P	100 05/06→08/11						
29L14 C	100 05/06→08/11						
29L14 V/P	100 05/06→08/11						
29L14 V	100 05/06→08/11						
35C10	70 05/06→08/11	Fitting Position: Rear Axle		13.0460-4996.2 604996		Brake System: Brembo 29123 20,3 Wear Warning Contact: prepared for wear indicator / excl. wear warning contact	
35S10	70 05/06→08/11						
35S11 V	78 07/07→08/11						
35C11 V	78 07/07→08/11						
35C12 V/P	85 05/06→08/11						
35S12 V/P	85 05/06→08/11						
35C12 V	85 05/06→08/11						
35S12 V	85 05/06→08/11						
35C13 V/P	93 07/07→08/11						
35S13 V/P	93 07/07→08/11						
35C13 V	93 07/07→08/11						
35S13 V	93 07/07→08/11						
35C14 GV/P	100 07/07→08/11						
35S14 GV/P	100 07/07→08/11						
35S14 GV	100 07/07→08/11						
35C14 GV	100 07/07→08/11						
35C14 V/P	103 09/09→08/11						
35S14 V/P	100 - 05/06→08/11						
	103						
35S14 V	100 - 05/06→08/11						
	103						
→							



	kW				
IVECO - DAILY IV Van 05/06→03/12					
 Brake Pad Set, disc brake					
35C14 V	100 - 05/06→08/11 103	Fitting Position: Front Axle	13.0460-4830.2 604830	Brake System: Brembo 29229 20,7 Wear Warning Contact: prepared for wear indicator / excl. wear warning contact Supplementary Article/Supplementary Info: with accessories	
35C15 V/P	107 05/06→08/11				
35C15 V	107 05/06→08/11				
35S17 V/P	125 07/07→08/11				
35C17 V	125 07/07→08/11				
35C17 V/P	125 07/07→08/11				
35S17 V	125 07/07→08/11	Fitting Position: Rear Axle	13.0460-4996.2 604996	Brake System: Brembo 29123 20,3 Wear Warning Contact: prepared for wear indicator / excl. wear warning contact	
35S18 V/P	130 05/06→08/11				
35S18 V	130 05/06→08/11				
35C18 V	130 05/06→08/11				
35C18 V/P	130 05/06→08/11				
35S14 C	100 05/06→08/11				
35S14 C/P	100 05/06→08/11				
...	100 05/06→08/11				
35S15	107 06/06→08/11	Code: 35S; Fitting Position: Front Axle	13.0460-4830.2 604830	Brake System: Brembo 29229 20,7 Wear Warning Contact: prepared for wear indicator / excl. wear warning contact Supplementary Article/Supplementary Info: with accessories	
40C10 V	70 05/06→08/11	Code: 40C; Fitting Position: Front Axle	13.0460-4830.2 604830	Brake System: Brembo 29229 20,7 Wear Warning Contact: prepared for wear indicator / excl. wear warning contact Supplementary Article/Supplementary Info: with accessories	
40C14 V/P	85 - 05/06→08/11 103				
40C12 V	85 05/06→08/11				
40C13 V	93 07/07→08/11				
40C13 V/P	93 07/07→08/11				
40C14 GV	100 07/07→08/11				
40C14 GV/P	100 07/07→08/11	Code: 40C; Fitting Position: Rear Axle	13.0460-4966.2 604966	Brake System: Brembo 29121 20,3 Wear Warning Contact: prepared for wear indicator / excl. wear warning contact	
40C14 V	103 09/09→08/11				
40C15 V	107 05/06→08/11				
40C15 V/P	107 05/06→08/11				
40C17 V	125 07/07→08/11				
40C17 V/P	125 07/07→08/11				
40C18 V	130 05/06→08/11				
40C18 V/P	130 05/06→08/11				
40C11 V	78 07/07→08/11	Code: 40C; Fitting Position: Front Axle	13.0460-4830.2 604830	Brake System: Brembo 29229 20,7 Wear Warning Contact: prepared for wear indicator / excl. wear warning contact Supplementary Article/Supplementary Info: with accessories	
45C15 V	107 05/06→08/11	Code: 45C; Fitting Position: Front Axle	13.0460-4830.2 604830	Brake System: Brembo 29229 20,7 Wear Warning Contact: prepared for wear indicator / excl. wear warning contact Supplementary Article/Supplementary Info: with accessories	
45C17 V	125 07/07→08/11				
45C17 V/P	125 07/07→08/11				
45C18	130 05/06→08/11				
		Code: 45C; Fitting Position: Rear Axle	13.0460-4966.2 604966	Brake System: Brembo 29121 20,3 Wear Warning Contact: prepared for wear indicator / excl. wear warning contact	
50C14 GV	100 07/07→08/11	Code: 50C; Fitting Position: Front Axle	13.0460-4830.2 604830	Brake System: Brembo 29229 20,7 Wear Warning Contact: prepared for wear indicator / excl. wear warning contact Supplementary Article/Supplementary Info: with accessories	
50C14 GV/P	100 07/07→08/11				
50C14 V	103 09/09→08/11				
50C14 V/P	103 09/09→08/11				
50C15 V	107 05/06→08/11				
50C15 V/P	107 05/06→08/11				
50C17 V/P	125 07/07→08/11				
50C17 V	125 07/07→08/11				
50C18 V/P	130 05/06→08/11	Code: 50C; Fitting Position: Rear Axle	13.0460-4966.2 604966	Brake System: Brembo 29121 20,3 Wear Warning Contact: prepared for wear indicator / excl. wear warning contact	
50C18 V	130 05/06→08/11				
 Brake Disc					
29L10 V	70 05/06→08/11	Rim Hole Number: 6; Fitting Position: Front Axle	24.0128-0238.1 428238	Outer diameter [mm]: 300 Brake Disc Thickness [mm] 28 Minimum thickness [mm] 25 Brake Disc Type: Vented	
29L12 V/P	85 05/06→08/11				
29L12 V	85 05/06→08/11				
29L14 C/P	100 05/06→08/11				
29L14 C	100 05/06→08/11	Fitting Position: Front Axle	24.0128-0239.1 428239	Outer diameter [mm]: 290 Brake Disc Thickness [mm] 28 Minimum thickness [mm] 25 Brake Disc Type: Vented	
29L14 V/P	100 05/06→08/11				
29L14 V	100 05/06→08/11				
35C10	70 05/06→08/11				
35S10	70 05/06→08/11				
35S11 V	78 07/07→08/11				
35C11 V	78 07/07→08/11				



	kW				
IVECO - DAILY IV Van 05/06→03/12					
 Brake Disc					
35C12 V/P	85 05/06→08/11		Rim Hole Number: 6;	24.0128-0238.1 428238	Outer diameter [mm]: 300 Brake Disc Thickness [mm] 28 Minimum thickness [mm] 25 Brake Disc Type: Vented
35S12 V/P	85 05/06→08/11		Fitting Position: Front Axle		
35C12 V	85 05/06→08/11			24.0128-0239.1 428239	Outer diameter [mm]: 290 Brake Disc Thickness [mm] 28 Minimum thickness [mm] 25 Brake Disc Type: Vented
35S12 V	85 05/06→08/11		Fitting Position: Front Axle		
35C13 V/P	93 07/07→08/11			24.0128-0239.1 428239	Outer diameter [mm]: 290 Brake Disc Thickness [mm] 28 Minimum thickness [mm] 25 Brake Disc Type: Vented
35S13 V/P	93 07/07→08/11		Fitting Position: Front Axle		
35C13 V	93 07/07→08/11			24.0128-0239.1 428239	Outer diameter [mm]: 290 Brake Disc Thickness [mm] 28 Minimum thickness [mm] 25 Brake Disc Type: Vented
35S13 V	93 07/07→08/11		Fitting Position: Front Axle		
35C14 GV/P	100 07/07→08/11			24.0128-0239.1 428239	Outer diameter [mm]: 290 Brake Disc Thickness [mm] 28 Minimum thickness [mm] 25 Brake Disc Type: Vented
35S14 GV/P	100 07/07→08/11		Fitting Position: Front Axle		
35S14 GV	100 07/07→08/11			24.0128-0239.1 428239	Outer diameter [mm]: 290 Brake Disc Thickness [mm] 28 Minimum thickness [mm] 25 Brake Disc Type: Vented
35C14 GV	100 07/07→08/11		Fitting Position: Front Axle		
35C14 V/P	103 09/09→08/11			24.0128-0239.1 428239	Outer diameter [mm]: 290 Brake Disc Thickness [mm] 28 Minimum thickness [mm] 25 Brake Disc Type: Vented
35S14 V/P	100 - 05/06→08/11 103		Fitting Position: Front Axle		
35S14 V	100 - 05/06→08/11 103			24.0128-0239.1 428239	Outer diameter [mm]: 290 Brake Disc Thickness [mm] 28 Minimum thickness [mm] 25 Brake Disc Type: Vented
35C14 V	100 - 05/06→08/11 103		Fitting Position: Front Axle		
35C15 V/P	107 05/06→08/11			24.0128-0239.1 428239	Outer diameter [mm]: 290 Brake Disc Thickness [mm] 28 Minimum thickness [mm] 25 Brake Disc Type: Vented
35S15 V/P	107 05/06→08/11		Fitting Position: Front Axle		
35C15 V	107 05/06→08/11			24.0128-0239.1 428239	Outer diameter [mm]: 290 Brake Disc Thickness [mm] 28 Minimum thickness [mm] 25 Brake Disc Type: Vented
35S17 V/P	125 07/07→08/11		Fitting Position: Front Axle		
35C17 V	125 07/07→08/11			24.0128-0239.1 428239	Outer diameter [mm]: 290 Brake Disc Thickness [mm] 28 Minimum thickness [mm] 25 Brake Disc Type: Vented
35C17 V/P	125 07/07→08/11		Fitting Position: Front Axle		
35S17 V	125 07/07→08/11			24.0128-0239.1 428239	Outer diameter [mm]: 290 Brake Disc Thickness [mm] 28 Minimum thickness [mm] 25 Brake Disc Type: Vented
35S18 V/P	130 05/06→08/11		Fitting Position: Front Axle		
35S18 V	130 05/06→08/11			24.0128-0239.1 428239	Outer diameter [mm]: 290 Brake Disc Thickness [mm] 28 Minimum thickness [mm] 25 Brake Disc Type: Vented
35C18 V	130 05/06→08/11		Fitting Position: Front Axle		
35C18 V/P	130 05/06→08/11			24.0128-0239.1 428239	Outer diameter [mm]: 290 Brake Disc Thickness [mm] 28 Minimum thickness [mm] 25 Brake Disc Type: Vented
35S14 C	100 05/06→08/11		Fitting Position: Front Axle		
35S14 C/P	100 05/06→08/11			24.0128-0239.1 428239	Outer diameter [mm]: 290 Brake Disc Thickness [mm] 28 Minimum thickness [mm] 25 Brake Disc Type: Vented
...	100 05/06→08/11		Fitting Position: Front Axle		
35S15	107 06/06→08/11		Code: 35S; Fitting Position: Front Axle	24.0128-0239.1 428238	Outer diameter [mm]: 300 Brake Disc Thickness [mm] 28 Minimum thickness [mm] 25 Brake Disc Type: Vented
40C10 V	70 05/06→08/11		Code: 40C; Fitting Position: Front Axle		
40C11 V	78 07/07→08/11			24.0128-0239.1 428239	Outer diameter [mm]: 290 Brake Disc Thickness [mm] 28 Minimum thickness [mm] 25 Brake Disc Type: Vented
40C14 V/P	85 - 05/06→08/11 103		Fitting Position: Front Axle		
40C12 V	85 05/06→08/11			24.0128-0239.1 428239	Outer diameter [mm]: 290 Brake Disc Thickness [mm] 28 Minimum thickness [mm] 25 Brake Disc Type: Vented
40C13 V	93 07/07→08/11		Fitting Position: Front Axle		
40C13 V/P	93 07/07→08/11			24.0128-0239.1 428239	Outer diameter [mm]: 290 Brake Disc Thickness [mm] 28 Minimum thickness [mm] 25 Brake Disc Type: Vented
40C14 GV	100 07/07→08/11		Fitting Position: Front Axle		
40C14 GV/P	100 07/07→08/11			24.0128-0239.1 428239	Outer diameter [mm]: 290 Brake Disc Thickness [mm] 28 Minimum thickness [mm] 25 Brake Disc Type: Vented
40C14 V	103 09/09→08/11		Fitting Position: Front Axle		
40C15 V	107 05/06→08/11			24.0128-0239.1 428239	Outer diameter [mm]: 290 Brake Disc Thickness [mm] 28 Minimum thickness [mm] 25 Brake Disc Type: Vented
40C15 V/P	107 05/06→08/11		Fitting Position: Front Axle		
40C17 V	125 07/07→08/11			24.0128-0239.1 428239	Outer diameter [mm]: 290 Brake Disc Thickness [mm] 28 Minimum thickness [mm] 25 Brake Disc Type: Vented
40C17 V/P	125 07/07→08/11		Fitting Position: Front Axle		
40C18 V	130 05/06→08/11			24.0128-0239.1 428239	Outer diameter [mm]: 290 Brake Disc Thickness [mm] 28 Minimum thickness [mm] 25 Brake Disc Type: Vented
40C18 V/P	130 05/06→08/11		Fitting Position: Front Axle		
45C15 V	107 05/06→08/11		Code: 45C; Fitting Position: Front Axle	24.0128-0239.1 428239	Outer diameter [mm]: 290 Brake Disc Thickness [mm] 28 Minimum thickness [mm] 25 Brake Disc Type: Vented
45C17 V	125 07/07→08/11		Code: 40C; Fitting Position: Front Axle		
45C17 V/P	125 07/07→08/11			24.0128-0239.1 428239	Outer diameter [mm]: 290 Brake Disc Thickness [mm] 28 Minimum thickness [mm] 25 Brake Disc Type: Vented
45C18	130 05/06→08/11		Fitting Position: Front Axle		
50C14 GV	100 07/07→08/11		Code: 50C; Fitting Position: Front Axle	24.0128-0239.1 428239	Outer diameter [mm]: 290 Brake Disc Thickness [mm] 28 Minimum thickness [mm] 25 Brake Disc Type: Vented
50C14 GV/P	100 07/07→08/11		Code: 50C; Fitting Position: Front Axle		
50C14 V	103 09/09→08/11			24.0128-0239.1 428239	Outer diameter [mm]: 290 Brake Disc Thickness [mm] 28 Minimum thickness [mm] 25 Brake Disc Type: Vented
50C14 V/P	103 09/09→08/11		Fitting Position: Front Axle		
50C15 V	107 05/06→08/11			24.0128-0239.1 428239	Outer diameter [mm]: 290 Brake Disc Thickness [mm] 28 Minimum thickness [mm] 25 Brake Disc Type: Vented
50C15 V/P	107 05/06→08/11		Fitting Position: Front Axle		
50C17 V/P	125 07/07→08/11			24.0128-0239.1 428239	Outer diameter [mm]: 290 Brake Disc Thickness [mm] 28 Minimum thickness [mm] 25 Brake Disc Type: Vented
50C17 V	125 07/07→08/11		Fitting Position: Front Axle		
50C18 V/P	130 05/06→08/11			24.0128-0239.1 428239	Outer diameter [mm]: 290 Brake Disc Thickness [mm] 28 Minimum thickness [mm] 25 Brake Disc Type: Vented
50C18 V	130 05/06→08/11		Fitting Position: Front Axle		
65C14 V	103 09/09→08/11		Fitting Position: Front Axle	24.0128-0238.1 428238	Outer diameter [mm]: 300 Brake Disc Thickness [mm] 28 Minimum thickness [mm] 25 Brake Disc Type: Vented
65C14 V/P	103 09/09→08/11		Code: 40C;		
65C15	107 05/06→08/11		→ Vehicle Identification Number to:	03.0137-3005.2 653005	Brake diameter, inside [mm]: 172 Width [mm] 42 Supplementary Article/Supplementary Info: without lever
65C17 V/P	125 07/07→08/11		12947747; Fitting Position: Rear Axle		
65C17 V	125 07/07→08/11			03.0137-3005.2 653005	Brake diameter, inside [mm]: 172 Width [mm] 42 Supplementary Article/Supplementary Info: without lever
65C18	130 05/06→08/11		Fitting Position: Front Axle		
 Brake Shoe Set, parking brake					
40C14 V/P	85 - 05/06→08/11 103		Code: 40C;	03.0137-3005.2 653005	Brake diameter, inside [mm]: 172 Width [mm] 42 Supplementary Article/Supplementary Info: without lever
40C12 V	85 05/06→08/11		→ Vehicle Identification Number to:		
40C13 V	93 07/07→08/11		12947747; Fitting Position: Rear Axle	03.0137-3005.2 653005	Brake diameter, inside [mm]: 172 Width [mm] 42 Supplementary Article/Supplementary Info: without lever
40C13 V/P	93 07/07→08/11		Code: 40C;		
40C14 GV	100 07/07→08/11		→ Vehicle Identification Number to:	03.0137-3005.2 653005	Brake diameter, inside [mm]: 172 Width [mm] 42 Supplementary Article/Supplementary Info: without lever
40C14 GV/P	100 07/07→08/11		12947747; Fitting Position: Rear Axle		
40C14 V	103 09/09→08/11			03.0137-3005.2 653005	Brake diameter, inside [mm]: 172 Width [mm] 42 Supplementary Article/Supplementary Info: without lever
→			Fitting Position: Front Axle		

	kW				
IVECO - DAILY IV Van 05/06→03/12					
 Brake Shoe Set, parking brake					
40C17 V 40C17 V/P 40C18 V 40C18 V/P	125 07/07→08/11 125 07/07→08/11 130 05/06→08/11 130 05/06→08/11	Code: 40C; → Vehicle Identification Number to: 12947747; Fitting Position: Rear Axle	03.0137-3005.2 653005	Brake diameter, inside [mm]: 172 Width [mm] 42 Supplementary Article/Supplementary Info: without lever	
40C15 V 40C15 V/P	107 05/06→08/11 107 05/06→08/11	Code: 40C; → Vehicle Identification Number to: D436247; Fitting Position: Rear Axle	03.0137-3005.2 653005	Brake diameter, inside [mm]: 172 Width [mm] 42 Supplementary Article/Supplementary Info: without lever	
45C15 V	107 05/06→08/11	Code: 45C; → Vehicle Identification Number to: 5853305 / D436247; Fitting Position: Rear Axle	03.0137-3005.2 653005	Brake diameter, inside [mm]: 172 Width [mm] 42 Supplementary Article/Supplementary Info: without lever	
45C17 V 45C17 V/P 45C18	125 07/07→08/11 125 07/07→08/11 130 05/06→08/11	Code: 45C; → Vehicle Identification Number to: 12947747; Fitting Position: Rear Axle	03.0137-3005.2 653005	Brake diameter, inside [mm]: 172 Width [mm] 42 Supplementary Article/Supplementary Info: without lever	
50C14 GV 50C14 GV/P 50C14 V 50C14 V/P 50C15 V 50C15 V/P 50C17 V/P 50C17 V 50C18 V/P 50C18 V	100 07/07→08/11 100 07/07→08/11 103 09/09→08/11 103 09/09→08/11 107 05/06→08/11 107 05/06→08/11 125 07/07→08/11 125 07/07→08/11 130 05/06→08/11 130 05/06→08/11	Code: 50C; → Vehicle Identification Number to: 12947747; Fitting Position: Rear Axle	03.0137-3005.2 653005	Brake diameter, inside [mm]: 172 Width [mm] 42 Supplementary Article/Supplementary Info: without lever	
IVECO - DAILY V Bus 09/11→02/14					
 Brake Pad Set, disc brake					
45C17 40C17 35S17 50C17	125 09/11→02/14 125 09/11→02/14 125 09/11→02/14 125 09/11→02/14	Code: 35S / 40C / 45C / 50C; Fitting Position: Front Axle	13.0460-4830.2 604830	Brake System: Brembo 29229 20,7 Wear Warning Contact: prepared for wear indicator / excl. wear warning contact Supplementary Article/Supplementary Info: with accessories	
		Code: 40C / 45C / 50C; Fitting Position: Rear Axle	13.0460-4966.2 604966	Brake System: Brembo 29121 20,3 Wear Warning Contact: prepared for wear indicator / excl. wear warning contact	
		Code: 35S; Fitting Position: Rear Axle	13.0460-4996.2 604996	Brake System: Brembo 29123 20,3 Wear Warning Contact: prepared for wear indicator / excl. wear warning contact	
50C15 Natural Power 50C14	107 09/11→02/14 100 09/11→02/14	Code: 50C; Fitting Position: Front Axle	13.0460-4830.2 604830	Brake System: Brembo 29229 20,7 Wear Warning Contact: prepared for wear indicator / excl. wear warning contact Supplementary Article/Supplementary Info: with accessories	
		Code: 50C; Fitting Position: Rear Axle	13.0460-4966.2 604966	Brake System: Brembo 29121 20,3 Wear Warning Contact: prepared for wear indicator / excl. wear warning contact	
 Brake Disc					
45C17 40C17 35S17 50C17	125 09/11→02/14 125 09/11→02/14 125 09/11→02/14 125 09/11→02/14	Code: 35S; Fitting Position: Front Axle	24.0128-0238.1 428238	Outer diameter [mm]: 300 Brake Disc Thickness [mm] 28 Minimum thickness [mm] 25 Brake Disc Type: Vented	
		Code: 40C / 45C / 50C; Fitting Position: Front Axle	24.0128-0239.1 428239	Outer diameter [mm]: 290 Brake Disc Thickness [mm] 28 Minimum thickness [mm] 25 Brake Disc Type: Vented	
50C15 Natural Power 50C14	107 09/11→02/14 100 09/11→02/14	Code: 50C; Fitting Position: Front Axle	24.0128-0239.1 428239	Outer diameter [mm]: 290 Brake Disc Thickness [mm] 28 Minimum thickness [mm] 25 Brake Disc Type: Vented	

	kW				
IVECO - DAILY V Platform/Chassis 09/11→02/14					
 Brake Pad Set, disc brake					
50C14 ...	100 09/11→02/14 100 09/11→02/14	Code: 35C / 35S / 40C / 45C / 50C; Fitting Position: Front Axle	13.0460-4830.2 604830	Brake System: Brembo 29229 20,7 Wear Warning Contact: prepared for wear indicator / excl. wear warning contact Supplementary Article/Supple- mentary Info: with accessories	
		Code: 40C / 45C / 50C; Fitting Position: Rear Axle	13.0460-4966.2 604966	Brake System: Brembo 29121 20,3 Wear Warning Contact: prepared for wear indicator / excl. wear warning contact	
		Code: 35S; Fitting Position: Rear Axle	13.0460-4996.2 604996	Brake System: Brembo 29123 20,3 Wear Warning Contact: prepared for wear indicator / excl. wear warning contact	
35S60E Electric	60 09/11→02/14	Code: 35S; Fitting Position: Front Axle	13.0460-4830.2 604830	Brake System: Brembo 29229 20,7 Wear Warning Contact: prepared for wear indicator / excl. wear warning contact Supplementary Article/Supple- mentary Info: with accessories	
		Code: 35S; Fitting Position: Rear Axle	13.0460-4996.2 604996	Brake System: Brembo 29123 20,3 Wear Warning Contact: prepared for wear indicator / excl. wear warning contact	
50C80E Electric	80 09/11→02/14	Fitting Position: Front Axle	13.0460-4830.2 604830	Brake System: Brembo 29229 20,7 Wear Warning Contact: prepared for wear indicator / excl. wear warning contact Supplementary Article/Supple- mentary Info: with accessories	
		Fitting Position: Rear Axle	13.0460-4966.2 604966	Brake System: Brembo 29121 20,3 Wear Warning Contact: prepared for wear indicator / excl. wear warning contact	
55S17W 4x4	125 09/11→02/14	Fitting Position: Front Axle	13.0460-4966.2 604966	Brake System: Brembo 29121 20,3 Wear Warning Contact: prepared for wear indicator / excl. wear warning contact	
 Brake Disc					
26L11 35C11D 40C11 29S11 35S11 29L11 35C13D 29S13 29L13D 40C13 35S13 29L13	78 09/11→02/14 78 09/11→02/14 78 09/11→02/14 78 09/11→02/14 78 09/11→02/14 78 09/11→02/14 93 09/11→02/14 93 09/11→02/14 93 09/11→02/14 93 09/11→02/14 93 09/11→02/14 93 09/11→02/14	Code: 29L / 29S / 35S; Fitting Position: Front Axle	24.0128-0238.1 428238	Outer diameter [mm]: 300 Brake Disc Thickness [mm] 28 Minimum thickness [mm] 25 Brake Disc Type: Vented	
29L15 35C15 40C15 35S15 50C15	107 09/11→02/14 107 09/11→02/14 107 09/11→02/14 107 09/11→02/14 107 09/11→02/14	Code: 29L / 29S / 35S; Fitting Position: Front Axle	24.0128-0238.1 428238	Outer diameter [mm]: 300 Brake Disc Thickness [mm] 28 Minimum thickness [mm] 25 Brake Disc Type: Vented	
		Code: 35C / 40C / 50C; Fitting Position: Front Axle	24.0128-0239.1 428239	Outer diameter [mm]: 290 Brake Disc Thickness [mm] 28 Minimum thickness [mm] 25 Brake Disc Type: Vented	
35C15 60C15 45C15 70C15 40C15 65C15 35S15 50C15 35C17 60C17 65C17 →	107 09/11→02/14 107 09/11→02/14 107 09/11→02/14 107 09/11→02/14 107 09/11→02/14 107 09/11→02/14 107 09/11→02/14 107 09/11→02/14 125 09/11→02/14 125 09/11→02/14 125 09/11→02/14	Code: 35S; Fitting Position: Front Axle	24.0128-0238.1 428238	Outer diameter [mm]: 300 Brake Disc Thickness [mm] 28 Minimum thickness [mm] 25 Brake Disc Type: Vented	
		Code: 35C / 40C / 45C / 50C; Fitting Position: Front Axle	24.0128-0239.1 428239	Outer diameter [mm]: 290 Brake Disc Thickness [mm] 28 Minimum thickness [mm] 25 Brake Disc Type: Vented	

	kW				
IVECO - DAILY V Platform/Chassis 09/11→02/14					
 Brake Disc					
45C17	125 09/11→02/14	Code: 35S; Fitting Position: Front Axle	24.0128-0238.1 428238	Outer diameter [mm]: 300 Brake Disc Thickness [mm] 28 Minimum thickness [mm] 25 Brake Disc Type: Vented	
70C17	125 09/11→02/14				
40C17	125 09/11→02/14				
35S17	125 09/11→02/14				
50C17	125 09/11→02/14				
65C21	150 09/11→02/14	Code: 35C / 40C / 45C / 50C; Fitting Position: Front Axle	24.0128-0239.1 428239	Outer diameter [mm]: 290 Brake Disc Thickness [mm] 28 Minimum thickness [mm] 25 Brake Disc Type: Vented	
45C21	150 09/11→02/14				
70C21	150 09/11→02/14				
40C21	150 09/11→02/14				
50C21	150 09/11→02/14				
35C21	150 09/11→02/14				
60C21	150 09/11→02/14				
35S21	150 09/11→02/14				
35C14	100 09/11→02/14				
60C14	100 09/11→02/14				
65C14	100 09/11→02/14				
40C14	100 09/11→02/14				
NaturalPower 35S14	100 09/11→02/14				
50C14	100 09/11→02/14				
...	100 09/11→02/14				
35S60E Electric	60 09/11→02/14	Code: 35S; Fitting Position: Front Axle	24.0128-0238.1 428238	Outer diameter [mm]: 300 Brake Disc Thickness [mm] 28 Minimum thickness [mm] 25 Brake Disc Type: Vented	
50C80E Electric	80 09/11→02/14	Fitting Position: Front Axle	24.0128-0239.1 428239	Outer diameter [mm]: 290 Brake Disc Thickness [mm] 28 Minimum thickness [mm] 25 Brake Disc Type: Vented	
IVECO - DAILY V Van 09/11→02/14					
 Brake Pad Set, disc brake					
35C15L V	107 09/11→02/14	Fitting Position: Front Axle	13.0460-4830.2 604830	Brake System: Brembo 29229 20,7 Wear Warning Contact: prepared for wear indicator / excl. wear warning contact Supplementary Article/Supple- mentary Info: with accessories	
35S15 V	107 09/11→02/14				
29L15 V	107 09/11→02/14				
40C15L V	107 09/11→02/14				
50C15L V	107 09/11→02/14				
35C13	93 09/11→02/14				
29S13	93 09/11→02/14				
40C13	93 09/11→02/14	Code: 40C; Fitting Position: Rear Axle	13.0460-4966.2 604966	Brake System: Brembo 29121 20,3 Wear Warning Contact: prepared for wear indicator / excl. wear warning contact	
40S13	93 09/11→02/14				
35S13	93 09/11→02/14				
29L13	93 09/11→02/14	Code: 29L / 29S / 35S; Fitting Position: Rear Axle	13.0460-4996.2 604996	Brake System: Brembo 29123 20,3 Wear Warning Contact: prepared for wear indicator / excl. wear warning contact	
40C11	78 09/11→02/14	Fitting Position: Front Axle	13.0460-4830.2 604830	Brake System: Brembo 29229 20,7 Wear Warning Contact: prepared for wear indicator / excl. wear warning contact Supplementary Article/Supple- mentary Info: with accessories	
35C11	78 09/11→02/14				
29S11	78 09/11→02/14				
35S11	78 09/11→02/14				
29L11	78 09/11→02/14	Code: 40C; Fitting Position: Rear Axle	13.0460-4966.2 604966	Brake System: Brembo 29121 20,3 Wear Warning Contact: prepared for wear indicator / excl. wear warning contact	
		Code: 29L / 29S / 35C / 35S; Fitting Position: Rear Axle	13.0460-4996.2 604996	Brake System: Brembo 29123 20,3 Wear Warning Contact: prepared for wear indicator / excl. wear warning contact	
45C15 V	107 09/11→02/14	Code: 35C / 35S / 40C / 45C / 50C; Fitting Position: Front Axle	13.0460-4830.2 604830	Brake System: Brembo 29229 20,7 Wear Warning Contact: prepared for wear indicator / excl. wear warning contact Supplementary Article/Supple- mentary Info: with accessories	
40C15 V	107 09/11→02/14				
60C15 V	107 09/11→02/14				
65C15 V	107 09/11→02/14				
50C15 V	107 09/11→02/14				
35C15 V	107 09/11→02/14				
35C17	125 09/11→02/14				
60C17	125 09/11→02/14	Code: 40C / 45C / 50C; Fitting Position: Rear Axle	13.0460-4966.2 604966	Brake System: Brembo 29121 20,3 Wear Warning Contact: prepared for wear indicator / excl. wear warning contact	
65C17	125 09/11→02/14				
45C17	125 09/11→02/14				
70C17	125 09/11→02/14				
40C17	125 09/11→02/14				
35S17	125 09/11→02/14				
50C17	125 09/11→02/14				
→					



	kW				
IVECO - DAILY V Van 09/11→02/14					
 Brake Pad Set, disc brake					
35C21 V	150 09/11→02/14	Code: 35S; Fitting Position: Rear Axle	13.0460-4996.2 604996	Brake System: Brembo 29123 20,3 Wear Warning Contact: prepared for wear indicator / excl. wear warning contact	
35S21 V	150 09/11→02/14				
50C21 V	150 09/11→02/14				
40C21 V	150 09/11→02/14				
45C21 V	150 09/11→02/14				
70C14	100 09/11→02/14				
35C14	100 09/11→02/14				
65C14	100 09/11→02/14				
40C14	100 09/11→02/14				
50C14	100 09/11→02/14				
Natural Power 35S14	100 09/11→02/14				
35S14	110 04/12→02/14	Code: 35S; Fitting Position: Front Axle	13.0460-4830.2 604830	Brake System: Brembo 29229 20,7 Wear Warning Contact: prepared for wear indicator / excl. wear warning contact Supplementary Article/Supplementary Info: with accessories	
		Code: 35S; Fitting Position: Rear Axle	13.0460-4996.2 604996	Brake System: Brembo 29123 20,3 Wear Warning Contact: prepared for wear indicator / excl. wear warning contact	
35S60E Electric	60 09/11→02/14	Fitting Position: Front Axle	13.0460-4830.2 604830	Brake System: Brembo 29229 20,7 Wear Warning Contact: prepared for wear indicator / excl. wear warning contact Supplementary Article/Supplementary Info: with accessories	
		Fitting Position: Rear Axle	13.0460-4996.2 604996	Brake System: Brembo 29123 20,3 Wear Warning Contact: prepared for wear indicator / excl. wear warning contact	
 Brake Disc					
35C15L V	107 09/11→02/14	Code: 29L / 29S / 35S; Fitting Position: Front Axle	24.0128-0238.1 428238	Outer diameter [mm]: 300 Brake Disc Thickness [mm] 28 Minimum thickness [mm] 25 Brake Disc Type: Vented	
35S15 V	107 09/11→02/14				
29L15 V	107 09/11→02/14				
40C15L V	107 09/11→02/14				
50C15L V	107 09/11→02/14	Code: 35C / 40C; Fitting Position: Front Axle	24.0128-0239.1 428239	Outer diameter [mm]: 290 Brake Disc Thickness [mm] 28 Minimum thickness [mm] 25 Brake Disc Type: Vented	
35C13	93 09/11→02/14				
29S13	93 09/11→02/14				
40C13	93 09/11→02/14				
40S13	93 09/11→02/14				
35S13	93 09/11→02/14				
29L13	93 09/11→02/14				
40C11	78 09/11→02/14	Code: 29L / 29S / 35C / 35S; Fitting Position: Front Axle	24.0128-0238.1 428238	Outer diameter [mm]: 300 Brake Disc Thickness [mm] 28 Minimum thickness [mm] 25 Brake Disc Type: Vented	
35C11	78 09/11→02/14				
29S11	78 09/11→02/14				
35S11	78 09/11→02/14				
29L11	78 09/11→02/14	Code: 40C; Fitting Position: Front Axle	24.0128-0239.1 428239	Outer diameter [mm]: 290 Brake Disc Thickness [mm] 28 Minimum thickness [mm] 25 Brake Disc Type: Vented	
45C15 V	107 09/11→02/14	Code: 35S; Fitting Position: Front Axle	24.0128-0238.1 428238	Outer diameter [mm]: 300 Brake Disc Thickness [mm] 28 Minimum thickness [mm] 25 Brake Disc Type: Vented	
40C15 V	107 09/11→02/14				
60C15 V	107 09/11→02/14				
65C15 V	107 09/11→02/14				
50C15 V	107 09/11→02/14				
35C15 V	107 09/11→02/14	Code: 35C / 40C / 45C / 50C; Fitting Position: Front Axle	24.0128-0239.1 428239	Outer diameter [mm]: 290 Brake Disc Thickness [mm] 28 Minimum thickness [mm] 25 Brake Disc Type: Vented	
35C17	125 09/11→02/14				
60C17	125 09/11→02/14				
65C17	125 09/11→02/14				
45C17	125 09/11→02/14				
70C17	125 09/11→02/14				
40C17	125 09/11→02/14				
35S17	125 09/11→02/14				
50C17	125 09/11→02/14				
35C21 V	150 09/11→02/14				
35S21 V	150 09/11→02/14				
50C21 V	150 09/11→02/14				
40C21 V	150 09/11→02/14				
45C21 V	150 09/11→02/14				
70C14	100 09/11→02/14				
35C14	100 09/11→02/14				
65C14	100 09/11→02/14				
40C14	100 09/11→02/14				
50C14	100 09/11→02/14				
Natural Power 35S14	100 09/11→02/14				



	kW				
IVECO - DAILY V Van 09/11→02/14					
 Brake Disc					
35S14	110 04/12→02/14	Code: 35S; Fitting Position: Front Axle	24.0128-0238.1 428238	Outer diameter [mm]: 300 Brake Disc Thickness [mm] 28 Minimum thickness [mm] 25 Brake Disc Type: Vented	
35S60E Electric	60 09/11→02/14	Fitting Position: Front Axle	24.0128-0238.1 428238	Outer diameter [mm]: 300 Brake Disc Thickness [mm] 28 Minimum thickness [mm] 25 Brake Disc Type: Vented	
IVECO - DAILY VI Bus 03/14→					
 Brake Pad Set, disc brake					
60C15 40C15 50C15 60C17 40C17 50C17 50C80E NaturalPower 40C14 60C14 50C14	107 03/14→10/16 107 03/14→10/16 107 03/14→10/16 125 03/14→10/16 125 03/14→10/16 125 03/14→10/16 80 04/16→10/16 100 03/14→10/16 100 03/14→10/16 100 03/14→10/16	Fitting Position: Front Axle	13.0460-4830.2 604830	Brake System: Brembo 29229 20,7 Wear Warning Contact: prepared for wear indicator / excl. wear warning contact Supplementary Article/Supplementary Info: with accessories	
60C15 40C15 50C15	110 04/16→ 110 04/16→ 110 04/16→	Code: 40C15 / 50C15; Fitting Position: Front Axle	13.0460-4830.2 604830	Brake System: Brembo 29229 20,7 Wear Warning Contact: prepared for wear indicator / excl. wear warning contact Supplementary Article/Supplementary Info: with accessories	
		Code: 40C15 / 50C15; Fitting Position: Rear Axle	13.0460-4966.2 604966	Brake System: Brembo 29121 20,3 Wear Warning Contact: prepared for wear indicator / excl. wear warning contact	
40C18 50C18 60C18	132 04/16→ 132 04/16→ 132 04/16→	Code: 40C18 / 50C18; Fitting Position: Front Axle	13.0460-4830.2 604830	Brake System: Brembo 29229 20,7 Wear Warning Contact: prepared for wear indicator / excl. wear warning contact Supplementary Article/Supplementary Info: with accessories	
		Code: 40C18 / 50C18; Fitting Position: Rear Axle	13.0460-4966.2 604966	Brake System: Brembo 29121 20,3 Wear Warning Contact: prepared for wear indicator / excl. wear warning contact	
 Brake Disc					
60C15 40C15 50C15 60C17 40C17 50C17 50C80E NaturalPower 40C14 60C14 50C14	107 03/14→10/16 107 03/14→10/16 107 03/14→10/16 125 03/14→10/16 125 03/14→10/16 125 03/14→10/16 80 04/16→10/16 100 03/14→10/16 100 03/14→10/16 100 03/14→10/16	Fitting Position: Front Axle	24.0128-0239.1 428239	Outer diameter [mm]: 290 Brake Disc Thickness [mm] 28 Minimum thickness [mm] 25 Brake Disc Type: Vented	
60C15 40C15 50C15	110 04/16→ 110 04/16→ 110 04/16→	Code: 50C15; Fitting Position: Front Axle	24.0128-0239.1 428239	Outer diameter [mm]: 290 Brake Disc Thickness [mm] 28 Minimum thickness [mm] 25 Brake Disc Type: Vented	
		Code: 40C15; Spring Type: for vehicles with torsion bar suspension; Fitting Position: Front Axle	24.0128-0239.1 428239	Outer diameter [mm]: 290 Brake Disc Thickness [mm] 28 Minimum thickness [mm] 25 Brake Disc Type: Vented	
40C18 50C18 60C18	132 04/16→ 132 04/16→ 132 04/16→	Code: 50C18; Fitting Position: Front Axle	24.0128-0239.1 428239	Outer diameter [mm]: 290 Brake Disc Thickness [mm] 28 Minimum thickness [mm] 25 Brake Disc Type: Vented	
		Code: 40C18; Spring Type: for vehicles with torsion bar suspension; Fitting Position: Front Axle	24.0128-0239.1 428239	Outer diameter [mm]: 290 Brake Disc Thickness [mm] 28 Minimum thickness [mm] 25 Brake Disc Type: Vented	

	kW				
IVECO - DAILY VI Platform/Chassis 03/14→					
 Brake Pad Set, disc brake					
33S11 35C11 35S11	78 03/14→04/16 78 03/14→04/16 78 03/14→04/16	Fitting Position: Front Axle	13.0460-4830.2 604830	Brake System: Brembo 29229 20,7 Wear Warning Contact: prepared for wear indicator / excl. wear warning contact Supplementary Article/Supplementary Info: with accessories	
		Code: 33S11 / 35S11; Fitting Position: Rear Axle	13.0460-4996.2 604996	Brake System: Brembo 29123 20,3 Wear Warning Contact: prepared for wear indicator / excl. wear warning contact	
33S12 35C12 35S12	85 04/16→ 85 04/16→ 85 04/16→	Fitting Position: Front Axle	13.0460-4830.2 604830	Brake System: Brembo 29229 20,7 Wear Warning Contact: prepared for wear indicator / excl. wear warning contact Supplementary Article/Supplementary Info: with accessories	
		Code: 33S12 / 35S12; Fitting Position: Rear Axle	13.0460-4996.2 604996	Brake System: Brembo 29123 20,3 Wear Warning Contact: prepared for wear indicator / excl. wear warning contact	
33S13 35C13 35S13	93 03/14→04/16 93 03/14→04/16 93 03/14→04/16	Fitting Position: Front Axle	13.0460-4830.2 604830	Brake System: Brembo 29229 20,7 Wear Warning Contact: prepared for wear indicator / excl. wear warning contact Supplementary Article/Supplementary Info: with accessories	
		Code: 33S13 / 35S13; Fitting Position: Rear Axle	13.0460-4996.2 604996	Brake System: Brembo 29123 20,3 Wear Warning Contact: prepared for wear indicator / excl. wear warning contact	
33S14 35C14 35S14	100 04/16→ 100 04/16→ 100 04/16→	Fitting Position: Front Axle	13.0460-4830.2 604830	Brake System: Brembo 29229 20,7 Wear Warning Contact: prepared for wear indicator / excl. wear warning contact Supplementary Article/Supplementary Info: with accessories	
		Code: 33S14 / 35S14; Fitting Position: Rear Axle	13.0460-4996.2 604996	Brake System: Brembo 29123 20,3 Wear Warning Contact: prepared for wear indicator / excl. wear warning contact	
33S15 35C15 35S15	107 03/14→04/16 107 03/14→04/16 107 03/14→04/16	Fitting Position: Front Axle	13.0460-4830.2 604830	Brake System: Brembo 29229 20,7 Wear Warning Contact: prepared for wear indicator / excl. wear warning contact Supplementary Article/Supplementary Info: with accessories	
		Code: 33S15 / 35S15; Fitting Position: Rear Axle	13.0460-4996.2 604996	Brake System: Brembo 29123 20,3 Wear Warning Contact: prepared for wear indicator / excl. wear warning contact	
35C16 50C16 35S16 33S16 40C16	115 04/16→ 115 04/16→ 115 04/16→ 115 04/16→ 115 04/16→	Fitting Position: Front Axle	13.0460-4830.2 604830	Brake System: Brembo 29229 20,7 Wear Warning Contact: prepared for wear indicator / excl. wear warning contact Supplementary Article/Supplementary Info: with accessories	
		Code: 33S16 / 35S16; Fitting Position: Rear Axle	13.0460-4996.2 604996	Brake System: Brembo 29123 20,3 Wear Warning Contact: prepared for wear indicator / excl. wear warning contact	
35C15 60C5 40C15 40S14	107 - 03/14→ 110 107 03/14→04/16 107 - 03/14→ 110 107 03/14→04/16	Code: 35S15 / 35C15 / 40C15 / 50C15; Fitting Position: Front Axle	13.0460-4830.2 604830	Brake System: Brembo 29229 20,7 Wear Warning Contact: prepared for wear indicator / excl. wear warning contact Supplementary Article/Supplementary Info: with accessories	



	kW				
IVECO - DAILY VI Platform/Chassis 03/14→					
 Brake Pad Set, disc brake					
65C15	107 - 03/14→ 110	Code: 40C15 / 50C15; Fitting Position: Rear Axle	13.0460-4966.2 604966	Brake System: Brembo 29121 20,3 Wear Warning Contact: prepared for wear indicator / excl. wear warning contact	
35S14	107 03/14→04/16				
35S15	107 - 03/14→ 110				
50C15	107 - 03/14→ 110	Code: 35S15; Fitting Position: Rear Axle	13.0460-4996.2 604996	Brake System: Brembo 29123 20,3 Wear Warning Contact: prepared for wear indicator / excl. wear warning contact	
...	107 03/14→04/16				
60C15	110 04/16→				
70C15	110 04/16→				
70S15	107 03/14→	Fitting Position: Front Axle	13.0460-4966.2 604966	Brake System: Brembo 29121 20,3 Wear Warning Contact: prepared for wear indicator / excl. wear warning contact	
55S15	107 03/14→				
70C15	107 03/14→				
35S15	107 03/14→				
55S17 4x4	125 03/14→04/16				
35S17	125 03/14→04/16				
35S18	132 04/16→				
55C18	132 04/16→				
55S18	132 04/16→				
70C18 4x4	132 04/16→				
70S18	132 04/16→				
35C17	125 03/14→04/16	Code: 35C17 / 35S17 / 40C17 / 50C17; Fitting Position: Front Axle	13.0460-4830.2 604830	Brake System: Brembo 29229 20,7 Wear Warning Contact: prepared for wear indicator / excl. wear warning contact Supplementary Article/Supple- mentary Info: with accessories	
60C17	125 03/14→04/16				
65C17	125 03/14→04/16				
45C17	125 03/14→04/16				
40C17	125 03/14→04/16				
45S17	125 03/14→04/16				
...	125 03/14→04/16				
35S17	125 03/14→04/16	Code: 40C17 / 50C17; Fitting Position: Rear Axle	13.0460-4966.2 604966	Brake System: Brembo 29121 20,3 Wear Warning Contact: prepared for wear indicator / excl. wear warning contact	
50C17	125 03/14→04/16				
		Code: 35S17; Fitting Position: Rear Axle	13.0460-4996.2 604996	Brake System: Brembo 29123 20,3 Wear Warning Contact: prepared for wear indicator / excl. wear warning contact	
35S18	132 04/16→	Code: 35S18 / 35C18 / 40C18 / 50C18; Fitting Position: Front Axle	13.0460-4830.2 604830	Brake System: Brembo 29229 20,7 Wear Warning Contact: prepared for wear indicator / excl. wear warning contact Supplementary Article/Supple- mentary Info: with accessories	
65C18	132 04/16→				
70C18	132 04/16→				
40C18	132 04/16→				
50C18	132 04/16→				
35C18	132 04/16→				
60C18	132 04/16→				
		Code: 40C18 / 50C18; Fitting Position: Rear Axle	13.0460-4966.2 604966	Brake System: Brembo 29121 20,3 Wear Warning Contact: prepared for wear indicator / excl. wear warning contact	
		Code: 35S18; Fitting Position: Rear Axle	13.0460-4996.2 604996	Brake System: Brembo 29123 20,3 Wear Warning Contact: prepared for wear indicator / excl. wear warning contact	
65C21	150 03/14→	Code: 35S21 / 35C21 / 40C21 / 50C21; Fitting Position: Front Axle	13.0460-4830.2 604830	Brake System: Brembo 29229 20,7 Wear Warning Contact: prepared for wear indicator / excl. wear warning contact Supplementary Article/Supple- mentary Info: with accessories	
70C21	150 03/14→				
40C21	150 03/14→				
50C21	150 03/14→				
35C21	150 03/14→				
60C21	150 03/14→				
35S21	150 03/14→				
		Code: 40C21 / 50C21; Fitting Position: Rear Axle	13.0460-4966.2 604966	Brake System: Brembo 29121 20,3 Wear Warning Contact: prepared for wear indicator / excl. wear warning contact	
		Code: 35S21; Fitting Position: Rear Axle	13.0460-4996.2 604996	Brake System: Brembo 29123 20,3 Wear Warning Contact: prepared for wear indicator / excl. wear warning contact	
35S60E	60 10/15→	Fitting Position: Front Axle	13.0460-4830.2 604830	Brake System: Brembo 29229 20,7 Wear Warning Contact: prepared for wear indicator / excl. wear warning contact Supplementary Article/Supple- mentary Info: with accessories	
35C60E	60 10/15→				



→



	kW				
IVECO - DAILY VI Platform/Chassis 03/14→					
 Brake Pad Set, disc brake					
35S60E 35C60E	60 10/15→ 60 10/15→	Fitting Position: Rear Axle	13.0460-4996.2 604996	Brake System: Brembo 29123 20,3 Wear Warning Contact: prepared for wear indicator / excl. wear warning contact	
50C80E 45C80E	80 10/15→ 80 10/15→	Fitting Position: Front Axle	13.0460-4830.2 604830	Brake System: Brembo 29229 20,7 Wear Warning Contact: prepared for wear indicator / excl. wear warning contact Supplementary Article/Supplementary Info: with accessories	
		Fitting Position: Rear Axle	13.0460-4966.2 604966	Brake System: Brembo 29121 20,3 Wear Warning Contact: prepared for wear indicator / excl. wear warning contact	
35C14 60C14 65C14 40C14 NaturalPower 35S14 50C14 ...	100 03/14→ 100 03/14→ 100 03/14→ 100 03/14→ 100 03/14→ 100 03/14→ 100 03/14→	Code: 35S14 / 35C14 / 40C14 / 50C14; Fitting Position: Front Axle	13.0460-4830.2 604830	Brake System: Brembo 29229 20,7 Wear Warning Contact: prepared for wear indicator / excl. wear warning contact Supplementary Article/Supplementary Info: with accessories	
		Code: 40C14 / 50C14; Fitting Position: Rear Axle	13.0460-4966.2 604966	Brake System: Brembo 29121 20,3 Wear Warning Contact: prepared for wear indicator / excl. wear warning contact	
		Code: 35S14; Fitting Position: Rear Axle	13.0460-4996.2 604996	Brake System: Brembo 29123 20,3 Wear Warning Contact: prepared for wear indicator / excl. wear warning contact	
 Brake Disc					
33S11 35C11 35S11	78 03/14→04/16 78 03/14→04/16 78 03/14→04/16	Code: 35C11; Spring Type: for vehicles with torsion bar suspension; Fitting Position: Front Axle	24.0128-0239.1 428239	Outer diameter [mm]: 290 Brake Disc Thickness [mm] 28 Minimum thickness [mm] 25 Brake Disc Type: Vented	
33S12 35C12 35S12	85 04/16→ 85 04/16→ 85 04/16→	Code: 35C12; Spring Type: for vehicles with torsion bar suspension; Fitting Position: Front Axle	24.0128-0239.1 428239	Outer diameter [mm]: 290 Brake Disc Thickness [mm] 28 Minimum thickness [mm] 25 Brake Disc Type: Vented	
33S13 35C13 35S13	93 03/14→04/16 93 03/14→04/16 93 03/14→04/16	Code: 35C13; Spring Type: for vehicles with torsion bar suspension; Fitting Position: Front Axle	24.0128-0239.1 428239	Outer diameter [mm]: 290 Brake Disc Thickness [mm] 28 Minimum thickness [mm] 25 Brake Disc Type: Vented	
33S14 35C14 35S14	100 04/16→ 100 04/16→ 100 04/16→	Code: 35C14; Spring Type: for vehicles with torsion bar suspension; Fitting Position: Front Axle	24.0128-0239.1 428239	Outer diameter [mm]: 290 Brake Disc Thickness [mm] 28 Minimum thickness [mm] 25 Brake Disc Type: Vented	
33S15 35C15 35S15	107 03/14→04/16 107 03/14→04/16 107 03/14→04/16	Code: 35C15; Spring Type: for vehicles with torsion bar suspension; Fitting Position: Front Axle	24.0128-0239.1 428239	Outer diameter [mm]: 290 Brake Disc Thickness [mm] 28 Minimum thickness [mm] 25 Brake Disc Type: Vented	
35C16 50C16 35S16 33S16 40C16	115 04/16→ 115 04/16→ 115 04/16→ 115 04/16→ 115 04/16→	Code: 35C16; Spring Type: for vehicles with torsion bar suspension; Fitting Position: Front Axle	24.0128-0239.1 428239	Outer diameter [mm]: 290 Brake Disc Thickness [mm] 28 Minimum thickness [mm] 25 Brake Disc Type: Vented	
35C15 60C5 40C15	107 - 03/14→ 110 107 03/14→04/16 107 - 03/14→ 110	Code: 50C15; Fitting Position: Front Axle	24.0128-0239.1 428239	Outer diameter [mm]: 290 Brake Disc Thickness [mm] 28 Minimum thickness [mm] 25 Brake Disc Type: Vented	
40S14 65C15 35S14 35S15 50C15 ...	107 03/14→04/16 107 - 03/14→ 110 107 03/14→04/16 107 - 03/14→ 110 107 03/14→04/16 107 - 03/14→ 110 107 03/14→04/16 110 04/16→ 110 04/16→	Code: 35C15 / 40C15; Spring Type: for vehicles with torsion bar suspension; Fitting Position: Front Axle	24.0128-0239.1 428239	Outer diameter [mm]: 290 Brake Disc Thickness [mm] 28 Minimum thickness [mm] 25 Brake Disc Type: Vented	
70C15	110 04/16→				
→					



	kW				
IVECO - DAILY VI Platform/Chassis 03/14→					
 Brake Disc					
35C17	125 03/14→04/16	Code: 50C17; Fitting Position: Front Axle	24.0128-0239.1 428239	Outer diameter [mm]: 290 Brake Disc Thickness [mm] 28 Minimum thickness [mm] 25 Brake Disc Type: Vented	
60C17	125 03/14→04/16				
65C17	125 03/14→04/16				
45C17	125 03/14→04/16				
40C17	125 03/14→04/16				
45S17	125 03/14→04/16	Code: 35C17 / 40C17; Spring Type: for vehicles with torsion bar suspension; Fitting Position: Front Axle	24.0128-0239.1 428239	Outer diameter [mm]: 290 Brake Disc Thickness [mm] 28 Minimum thickness [mm] 25 Brake Disc Type: Vented	
...	125 03/14→04/16				
35S17	125 03/14→04/16				
50C17	125 03/14→04/16				
35S18	132 04/16→	Code: 50C18; Fitting Position: Front Axle	24.0128-0239.1 428239	Outer diameter [mm]: 290 Brake Disc Thickness [mm] 28 Minimum thickness [mm] 25 Brake Disc Type: Vented	
65C18	132 04/16→				
70C18	132 04/16→				
40C18	132 04/16→				
50C18	132 04/16→				
35C18	132 04/16→	Code: 35C18 / 40C18; Spring Type: for vehicles with torsion bar suspension; Fitting Position: Front Axle	24.0128-0239.1 428239	Outer diameter [mm]: 290 Brake Disc Thickness [mm] 28 Minimum thickness [mm] 25 Brake Disc Type: Vented	
60C18	132 04/16→				
65C21	150 03/14→	Code: 50C21; Fitting Position: Front Axle	24.0128-0239.1 428239	Outer diameter [mm]: 290 Brake Disc Thickness [mm] 28 Minimum thickness [mm] 25 Brake Disc Type: Vented	
70C21	150 03/14→				
40C21	150 03/14→				
50C21	150 03/14→				
35C21	150 03/14→	Code: 35C21 / 40C21; Spring Type: for vehicles with torsion bar suspension; Fitting Position: Front Axle	24.0128-0239.1 428239	Outer diameter [mm]: 290 Brake Disc Thickness [mm] 28 Minimum thickness [mm] 25 Brake Disc Type: Vented	
60C21	150 03/14→				
35S21	150 03/14→				
50C80E	80 10/15→	Fitting Position: Front Axle	24.0128-0239.1 428239	Outer diameter [mm]: 290 Brake Disc Thickness [mm] 28 Minimum thickness [mm] 25 Brake Disc Type: Vented	
45C80E	80 10/15→				
35C14	100 03/14→	Code: 50C14; Fitting Position: Front Axle	24.0128-0239.1 428239	Outer diameter [mm]: 290 Brake Disc Thickness [mm] 28 Minimum thickness [mm] 25 Brake Disc Type: Vented	
60C14	100 03/14→				
65C14	100 03/14→				
40C14	100 03/14→				
NaturalPower 35S14	100 03/14→	Code: 35C14 / 40C14; Spring Type: for vehicles with torsion bar suspension; Fitting Position: Front Axle	24.0128-0239.1 428239	Outer diameter [mm]: 290 Brake Disc Thickness [mm] 28 Minimum thickness [mm] 25 Brake Disc Type: Vented	
50C14	100 03/14→				
...	100 03/14→				
IVECO - DAILY VI Van 03/14→					
 Brake Pad Set, disc brake					
33S11	78 03/14→04/16	Fitting Position: Front Axle	13.0460-4830.2 604830	Brake System: Brembo 29229 20,7 Wear Warning Contact: prepared for wear indicator / excl. wear warning contact Supplementary Article/Supplementary Info: with accessories	
35C11	78 03/14→04/16				
35S11	78 03/14→04/16	Code: 33S11 / 35S11; Fitting Position: Rear Axle	13.0460-4996.2 604996	Brake System: Brembo 29123 20,3 Wear Warning Contact: prepared for wear indicator / excl. wear warning contact	
33S12	85 04/16→	Fitting Position: Front Axle	13.0460-4830.2 604830	Brake System: Brembo 29229 20,7 Wear Warning Contact: prepared for wear indicator / excl. wear warning contact Supplementary Article/Supplementary Info: with accessories	
35C12	85 04/16→				
35S12	85 04/16→	Code: 33S12 / 35S12; Fitting Position: Rear Axle	13.0460-4996.2 604996	Brake System: Brembo 29123 20,3 Wear Warning Contact: prepared for wear indicator / excl. wear warning contact	
33S13	93 03/14→04/16	Fitting Position: Front Axle	13.0460-4830.2 604830	Brake System: Brembo 29229 20,7 Wear Warning Contact: prepared for wear indicator / excl. wear warning contact Supplementary Article/Supplementary Info: with accessories	
35C13	93 03/14→04/16				
35S13	93 03/14→04/16	Code: 33S13 / 35S13; Fitting Position: Rear Axle	13.0460-4996.2 604996	Brake System: Brembo 29123 20,3 Wear Warning Contact: prepared for wear indicator / excl. wear warning contact	
→					



	kW				
IVECO - DAILY VI Van 03/14→					
 Brake Pad Set, disc brake					
33S14 35C14 35S14	100 04/16→ 100 04/16→ 100 04/16→	Fitting Position: Front Axle	13.0460-4830.2 604830	Brake System: Brembo 29229 20,7 Wear Warning Contact: prepared for wear indicator / excl. wear warning contact Supplementary Article/Supplementary Info: with accessories	
		Code: 33S14 / 35S14; Fitting Position: Rear Axle	13.0460-4996.2 604996	Brake System: Brembo 29123 20,3 Wear Warning Contact: prepared for wear indicator / excl. wear warning contact	
33S15 35C15 35S15	107 03/14→04/16 107 03/14→04/16 107 03/14→04/16	Fitting Position: Front Axle	13.0460-4830.2 604830	Brake System: Brembo 29229 20,7 Wear Warning Contact: prepared for wear indicator / excl. wear warning contact Supplementary Article/Supplementary Info: with accessories	
		Code: 33S15 / 35S15; Fitting Position: Rear Axle	13.0460-4996.2 604996	Brake System: Brembo 29123 20,3 Wear Warning Contact: prepared for wear indicator / excl. wear warning contact	
35C16 50C16 35S16 33S16 40C16	115 04/16→ 115 04/16→ 115 04/16→ 115 04/16→ 115 04/16→	Fitting Position: Front Axle	13.0460-4830.2 604830	Brake System: Brembo 29229 20,7 Wear Warning Contact: prepared for wear indicator / excl. wear warning contact Supplementary Article/Supplementary Info: with accessories	
		Code: 33S16 / 35S16; Fitting Position: Rear Axle	13.0460-4996.2 604996	Brake System: Brembo 29123 20,3 Wear Warning Contact: prepared for wear indicator / excl. wear warning contact	
35C15 45C15 70C15 40C15 65C15 35S15 50C15 60C15	107 - 03/14→ 110 107 03/14→04/16 107 - 03/14→ 110 107 - 03/14→ 110 107 - 03/14→ 110 110 04/16→	Code: 35S15 / 35C15 / 40C15 / 50C15; Fitting Position: Front Axle	13.0460-4830.2 604830	Brake System: Brembo 29229 20,7 Wear Warning Contact: prepared for wear indicator / excl. wear warning contact Supplementary Article/Supplementary Info: with accessories	
		Code: 40C15 / 50C15; Fitting Position: Rear Axle	13.0460-4966.2 604966	Brake System: Brembo 29121 20,3 Wear Warning Contact: prepared for wear indicator / excl. wear warning contact	
		Code: 35S15; Fitting Position: Rear Axle	13.0460-4996.2 604996	Brake System: Brembo 29123 20,3 Wear Warning Contact: prepared for wear indicator / excl. wear warning contact	
35C17 60C17 65C17 55C17 70C17 40C17 35S17 50C17	125 03/14→04/16 125 03/14→04/16 125 03/14→04/16 125 03/14→04/16 125 03/14→04/16 125 03/14→04/16 125 03/14→04/16 125 03/14→04/16	Code: 35C17 / 35S17 / 40C17 / 50C17; Fitting Position: Front Axle	13.0460-4830.2 604830	Brake System: Brembo 29229 20,7 Wear Warning Contact: prepared for wear indicator / excl. wear warning contact Supplementary Article/Supplementary Info: with accessories	
		Code: 40C17 / 50C17; Fitting Position: Rear Axle	13.0460-4966.2 604966	Brake System: Brembo 29121 20,3 Wear Warning Contact: prepared for wear indicator / excl. wear warning contact	
		Code: 35S17; Fitting Position: Rear Axle	13.0460-4996.2 604996	Brake System: Brembo 29123 20,3 Wear Warning Contact: prepared for wear indicator / excl. wear warning contact	
35S18 65C18 70C18 40C18 50C18 35C18 60C18	132 04/16→ 132 04/16→ 132 04/16→ 132 04/16→ 132 04/16→ 132 04/16→ 132 04/16→	Code: 35S18 / 35C18 / 40C18 / 50C18; Fitting Position: Front Axle	13.0460-4830.2 604830	Brake System: Brembo 29229 20,7 Wear Warning Contact: prepared for wear indicator / excl. wear warning contact Supplementary Article/Supplementary Info: with accessories	
→					



	kW			
IVECO - DAILY VI Van 03/14→				
 Brake Pad Set, disc brake				
35S18 65C18 70C18 40C18 50C18 35C18 60C18	132 04/16→ 132 04/16→ 132 04/16→ 132 04/16→ 132 04/16→ 132 04/16→ 132 04/16→	Code: 40C18 / 50C18; Fitting Position: Rear Axle	13.0460-4966.2 604966	Brake System: Brembo 29121 20,3 Wear Warning Contact: prepared for wear indicator / excl. wear warning contact
		Code: 35S18; Fitting Position: Rear Axle	13.0460-4996.2 604996	Brake System: Brembo 29123 20,3 Wear Warning Contact: prepared for wear indicator / excl. wear warning contact
65C21 70C21 40C21 50C21 35C21 35S21	150 03/14→ 150 03/14→ 150 03/14→ 150 03/14→ 150 03/14→ 150 03/14→	Code: 35S21 / 35C21 / 40C21 / 50C21; Fitting Position: Front Axle	13.0460-4830.2 604830	Brake System: Brembo 29229 20,7 Wear Warning Contact: prepared for wear indicator / excl. wear warning contact Supplementary Article/Supplementary Info: with accessories
		Code: 40C21 / 50C21; Fitting Position: Rear Axle	13.0460-4966.2 604966	Brake System: Brembo 29121 20,3 Wear Warning Contact: prepared for wear indicator / excl. wear warning contact
		Code: 35S21; Fitting Position: Rear Axle	13.0460-4996.2 604996	Brake System: Brembo 29123 20,3 Wear Warning Contact: prepared for wear indicator / excl. wear warning contact
35S60E	60 10/15→	Fitting Position: Front Axle	13.0460-4830.2 604830	Brake System: Brembo 29229 20,7 Wear Warning Contact: prepared for wear indicator / excl. wear warning contact Supplementary Article/Supplementary Info: with accessories
		Fitting Position: Rear Axle	13.0460-4996.2 604996	Brake System: Brembo 29123 20,3 Wear Warning Contact: prepared for wear indicator / excl. wear warning contact
50C80E 45C80E	80 10/15→ 80 10/15→	Fitting Position: Front Axle	13.0460-4830.2 604830	Brake System: Brembo 29229 20,7 Wear Warning Contact: prepared for wear indicator / excl. wear warning contact Supplementary Article/Supplementary Info: with accessories
		Fitting Position: Rear Axle	13.0460-4966.2 604966	Brake System: Brembo 29121 20,3 Wear Warning Contact: prepared for wear indicator / excl. wear warning contact
35C14 60C14 65C14 40C14 NaturalPower 35S14 50C14 ...	100 03/14→ 100 03/14→ 100 03/14→ 100 03/14→ 100 03/14→ 100 03/14→ 100 03/14→	Code: 35S14 / 35C14 / 40C14 / 50C14; Fitting Position: Front Axle	13.0460-4830.2 604830	Brake System: Brembo 29229 20,7 Wear Warning Contact: prepared for wear indicator / excl. wear warning contact Supplementary Article/Supplementary Info: with accessories
		Code: 40C14 / 50C14; Fitting Position: Rear Axle	13.0460-4966.2 604966	Brake System: Brembo 29121 20,3 Wear Warning Contact: prepared for wear indicator / excl. wear warning contact
		Code: 35S14; Fitting Position: Rear Axle	13.0460-4996.2 604996	Brake System: Brembo 29123 20,3 Wear Warning Contact: prepared for wear indicator / excl. wear warning contact
 Brake Disc				
33S11 35C11 35S11	78 03/14→04/16 78 03/14→04/16 78 03/14→04/16	Code: 35C11; Spring Type: for vehicles with torsion bar suspension; Fitting Position: Front Axle	24.0128-0239.1 428239	Outer diameter [mm]: 290 Brake Disc Thickness [mm] 28 Minimum thickness [mm] 25 Brake Disc Type: Vented
33S12 35C12 35S12	85 04/16→ 85 04/16→ 85 04/16→	Code: 35C12; Spring Type: for vehicles with torsion bar suspension; Fitting Position: Front Axle	24.0128-0239.1 428239	Outer diameter [mm]: 290 Brake Disc Thickness [mm] 28 Minimum thickness [mm] 25 Brake Disc Type: Vented
→				





	kW				
IVECO - DAILY VI Van 03/14→					
 Brake Disc					
33S13 35C13 35S13	93 03/14→04/16 93 03/14→04/16 93 03/14→04/16	Code: 35C13; Spring Type: for vehicles with torsion bar suspension; Fitting Position: Front Axle	24.0128-0239.1 428239	Outer diameter [mm]: 290 Brake Disc Thickness [mm] 28 Minimum thickness [mm] 25 Brake Disc Type: Vented	
33S14 35C14 35S14	100 04/16→ 100 04/16→ 100 04/16→	Code: 35C14; Spring Type: for vehicles with torsion bar suspension; Fitting Position: Front Axle	24.0128-0239.1 428239	Outer diameter [mm]: 290 Brake Disc Thickness [mm] 28 Minimum thickness [mm] 25 Brake Disc Type: Vented	
33S15 35C15 35S15	107 03/14→04/16 107 03/14→04/16 107 03/14→04/16	Code: 35C15; Spring Type: for vehicles with torsion bar suspension; Fitting Position: Front Axle	24.0128-0239.1 428239	Outer diameter [mm]: 290 Brake Disc Thickness [mm] 28 Minimum thickness [mm] 25 Brake Disc Type: Vented	
35C16 50C16 35S16 33S16 40C16	115 04/16→ 115 04/16→ 115 04/16→ 115 04/16→ 115 04/16→	Code: 35C16; Spring Type: for vehicles with torsion bar suspension; Fitting Position: Front Axle	24.0128-0239.1 428239	Outer diameter [mm]: 290 Brake Disc Thickness [mm] 28 Minimum thickness [mm] 25 Brake Disc Type: Vented	
35C15 45C15 70C15	107 - 03/14→ 110 107 03/14→04/16 107 - 03/14→ 110	Code: 50C15; Fitting Position: Front Axle	24.0128-0239.1 428239	Outer diameter [mm]: 290 Brake Disc Thickness [mm] 28 Minimum thickness [mm] 25 Brake Disc Type: Vented	
40C15 65C15 35S15 50C15 60C15	107 - 03/14→ 110 107 - 03/14→ 110 107 - 03/14→ 110 110 04/16→	Code: 35C15 / 40C15; Spring Type: for vehicles with torsion bar suspension; Fitting Position: Front Axle	24.0128-0239.1 428239	Outer diameter [mm]: 290 Brake Disc Thickness [mm] 28 Minimum thickness [mm] 25 Brake Disc Type: Vented	
35C17 60C17 65C17 55C17 70C17 40C17 35S17 50C17	125 03/14→04/16 125 03/14→04/16 125 03/14→04/16 125 03/14→04/16 125 03/14→04/16 125 03/14→04/16 125 03/14→04/16 125 03/14→04/16	Code: 50C17; Fitting Position: Front Axle	24.0128-0239.1 428239	Outer diameter [mm]: 290 Brake Disc Thickness [mm] 28 Minimum thickness [mm] 25 Brake Disc Type: Vented	
35S18 65C18 70C18 40C18 50C18 35C18 60C18	132 04/16→ 132 04/16→ 132 04/16→ 132 04/16→ 132 04/16→ 132 04/16→ 132 04/16→	Code: 50C18; Fitting Position: Front Axle	24.0128-0239.1 428239	Outer diameter [mm]: 290 Brake Disc Thickness [mm] 28 Minimum thickness [mm] 25 Brake Disc Type: Vented	
65C21 70C21 40C21 50C21 35C21 35S21	150 03/14→ 150 03/14→ 150 03/14→ 150 03/14→ 150 03/14→ 150 03/14→	Code: 50C21; Fitting Position: Front Axle	24.0128-0239.1 428239	Outer diameter [mm]: 290 Brake Disc Thickness [mm] 28 Minimum thickness [mm] 25 Brake Disc Type: Vented	
50C80E 45C80E	80 10/15→ 80 10/15→	Fitting Position: Front Axle	24.0128-0239.1 428239	Outer diameter [mm]: 290 Brake Disc Thickness [mm] 28 Minimum thickness [mm] 25 Brake Disc Type: Vented	
35C14 60C14 65C14 40C14 NaturalPower 35S14 50C14 ...	100 03/14→ 100 03/14→ 100 03/14→ 100 03/14→ 100 03/14→ 100 03/14→ 100 03/14→	Code: 50C14; Fitting Position: Front Axle	24.0128-0239.1 428239	Outer diameter [mm]: 290 Brake Disc Thickness [mm] 28 Minimum thickness [mm] 25 Brake Disc Type: Vented	
		Code: 35C14 / 40C14; Spring Type: for vehicles with torsion bar suspension; Fitting Position: Front Axle	24.0128-0239.1 428239	Outer diameter [mm]: 290 Brake Disc Thickness [mm] 28 Minimum thickness [mm] 25 Brake Disc Type: Vented	
JAGUAR - E-PACE (X540) 09/17→					
 Brake Caliper					
1.5 P160 MHEV 1.5 P300e Plug-in Hybrid AWD 2.0 AWD 2.0 D150 2.0 D150 AWD 2.0 D165 2.0 D165 MHEV AWD →	118 11/20→ 147 - 11/20→ 227 221 09/17→ 110 09/17→ 110 09/17→ 120 11/20→ 120 11/20→	→ Vehicle Identification Number to: L1Z99999; Brake Size: 16"; Fitting Position: Rear Axle Left	24.6238-7039.5 241313	Brake System: ATE Supplementary Article/Supplementary Info: without holder Brake Caliper Type: Fist-type Caliper / Brake caliper with adjusting element for electr. handbrake	







	kW			
JAGUAR - E-PACE (X540) 09/17→				
 Brake Caliper				
2.0 D180 AWD	132	09/17→	→ Vehicle Identification Number to: L1Z99999; Brake Size: 16"; Fitting Position: Rear Axle Left	24.6238-7039.5 241313 Brake System: ATE Supplementary Article/Supplementary Info: without holder Brake Caliper Type: Fist-type Caliper / Brake caliper with adjusting element for electr. handbrake
2.0 D200 MHEV AWD	150	11/20→		
2.0 D240 AWD	177	09/17→		
2.0 Flexfuel AWD	183	09/17→		
2.0 P200 AWD	147 -	09/17→		
	183			
2.0 P200 MHEV AWD	147	11/20→		
2.0 P250 MHEV AWD	184	11/20→		
2.0 P300 MHEV AWD	221	11/20→		
Guide Sleeve Kit, brake caliper				
1.5 P160 MHEV	118	11/20→	Fitting Position: Rear Axle	11.0101-5407.2 260011 Brake System: ATE
1.5 P300e Plug-in Hybrid AWD	147 -	11/20→		
	227			
2.0 AWD	221	09/17→		
2.0 D150	110	09/17→		
2.0 D150 AWD	110	09/17→		
2.0 D165	120	11/20→		
2.0 D165 MHEV AWD	120	11/20→		
2.0 D180 AWD	132	09/17→		
2.0 D200 MHEV AWD	150	11/20→		
2.0 D240 AWD	177	09/17→		
2.0 Flexfuel AWD	183	09/17→		
2.0 P200 AWD	147 -	09/17→		
	183			
2.0 P200 MHEV AWD	147	11/20→		
2.0 P250 MHEV AWD	184	11/20→		
2.0 P300 MHEV AWD	221	11/20→		
Guide Bolt, brake caliper				
1.5 P160 MHEV	118	11/20→	Fitting Position: Rear Axle	11.8171-0008.1 990049 Brake System: ATE
1.5 P300e Plug-in Hybrid AWD	147 -	11/20→		
	227			
2.0 AWD	221	09/17→		
2.0 D150	110	09/17→		
2.0 D150 AWD	110	09/17→		
2.0 D165	120	11/20→		
2.0 D165 MHEV AWD	120	11/20→		
2.0 D180 AWD	132	09/17→		
2.0 D200 MHEV AWD	150	11/20→		
2.0 D240 AWD	177	09/17→		
2.0 Flexfuel AWD	183	09/17→		
2.0 P200 AWD	147 -	09/17→		
	183			
2.0 P200 MHEV AWD	147	11/20→		
2.0 P250 MHEV AWD	184	11/20→		
2.0 P300 MHEV AWD	221	11/20→		
 Brake Pad Set, disc brake				
1.5 P160 MHEV	118	11/20→	Brake Size: 16"; Fitting Position: Rear Axle	13.0460-7326.2 607326 Brake System: ATE 22141 15,5 Wear Warning Contact: prepared for wear indicator / excl. wear warning contact
1.5 P300e Plug-in Hybrid AWD	147	11/20→		
	227			
2.0 AWD	221	09/17→		
2.0 D150	110	09/17→		
2.0 D150 AWD	110	09/17→		
2.0 D165	120	11/20→		
2.0 D165 MHEV AWD	120	11/20→		
2.0 D180 AWD	132	09/17→		
2.0 D200 MHEV AWD	150	11/20→		
2.0 D240 AWD	177	09/17→		
2.0 Flexfuel AWD	183	09/17→		
2.0 P200 AWD	147 -	09/17→		
	183			
2.0 P200 MHEV AWD	147	11/20→		
2.0 P250 MHEV AWD	184	11/20→		
2.0 P300 MHEV AWD	221	11/20→		
1.5 P300e Plug-in Hybrid AWD	227	11/20→	Brake Size: 16"; Fitting Position: Rear Axle	13.0460-7326.2 607326 Brake System: ATE 22141 15,5 Wear Warning Contact: prepared for wear indicator / excl. wear warning contact
JAGUAR - F-PACE (X761) 09/15→				
Guide Sleeve Kit, brake caliper				
2.0 D165 MHEV	120	10/20→	Fitting Position: Rear Axle	11.0101-5407.2 260011 Brake System: ATE
2.0 D200 MHEV	150	10/20→		
2.0 P400e Plug-in Hybrid	221 -	10/20→		
	297			
2.0 SD4 AWD	177	02/17→		
2.0 TD4	120 -	09/15→		
	132			
2.0 TD4 AWD	132	09/15→		
→				







		kW						
JAGUAR - F-PACE (X761) 09/15→								
Guide Sleeve Kit, brake caliper								
2.0 Ti4	177 - 05/16→ 184	Fitting Position: Rear Axle		11.0101-5407.2 260011	Brake System: ATE			
2.0 Ti4 AWD	184 - 02/17→ 221							
3.0 D300 MHEV	221 10/20→							
3.0 P400 MHEV	294 10/20→							
3.0 SCV6 AWD	250 - 09/15→ 280							
3.0 SDV6 AWD	221 09/15→							
5.0 SCV8 SVR AWD	405 08/18→							
5.0 SVR P550 MHEV	405 10/20→							
Guide Bolt, brake caliper								
2.0 D165 MHEV	120 10/20→	Fitting Position: Rear Axle		11.8171-0008.1 990049	Brake System: ATE			
2.0 D200 MHEV	150 10/20→							
2.0 P400e Plug-in Hybrid	221 - 10/20→ 297							
2.0 SD4 AWD	177 02/17→							
2.0 TD4	120 - 09/15→ 132							
2.0 TD4 AWD	132 09/15→							
2.0 Ti4	177 - 05/16→ 184							
2.0 Ti4 AWD	184 - 02/17→ 221							
3.0 D300 MHEV	221 10/20→							
3.0 P400 MHEV	294 10/20→							
3.0 SCV6 AWD	250 - 09/15→ 280							
3.0 SDV6 AWD	221 09/15→							
5.0 SCV8 SVR AWD	405 08/18→							
5.0 SVR P550 MHEV	405 10/20→							
 Brake Pad Set, disc brake								
2.0 D165 MHEV	120 10/20→	→ Vehicle Identification Number to: LA999999; Fitting Position: Rear Axle		13.0460-7326.2 607326	Brake System: ATE 22141 15,5 Wear Warning Contact: prepared for wear indicator / excl. wear warning contact			
2.0 D200 MHEV	150 10/20→							
2.0 P400e Plug-in Hybrid	221 10/20→							
2.0 SD4 AWD	177 02/17→							
2.0 TD4	120 - 09/15→ 132				13.0470-7326.2 LD7326	Brake System: ATE Wear Warning Contact: prepared for wear indicator / excl. wear warning contact Ceramic		
2.0 TD4 AWD	132 09/15→							
2.0 Ti4	177 - 05/16→ 184							
2.0 Ti4 AWD	184 - 02/17→ 221							
3.0 D300 MHEV	221 10/20→							
3.0 SDV6 AWD	221 09/15→							
2.0 P400e Plug-in Hybrid	297 10/20→	→ Vehicle Identification Number to: LA999999; Fitting Position: Rear Axle		13.0460-7326.2 607326	Brake System: ATE 22141 15,5 Wear Warning Contact: prepared for wear indicator / excl. wear warning contact			
3.0 P400 MHEV	294 10/20→							
3.0 SCV6 AWD	250 - 09/15→ 280							
 Brake Disc								
2.0 D165 MHEV	120 10/20→	Brake Size: 17"; → Vehicle Identification Number to: LA999999; Fitting Position: Front Axle		24.0130-0253.1 430253	Outer diameter [mm]: 325 Brake Disc Thickness [mm] 30 Minimum thickness [mm] 28 Brake Disc Type: Vented			
2.0 D200 MHEV	150 10/20→							
2.0 P400e Plug-in Hybrid	221 - 10/20→ 297							
2.0 SD4 AWD	177 02/17→							
2.0 TD4	120 - 09/15→ 132							
2.0 TD4 AWD	132 09/15→							
2.0 Ti4	177 - 05/16→ 184							
2.0 Ti4 AWD	184 - 02/17→ 221							
3.0 D300 MHEV	221 10/20→							
3.0 P400 MHEV	294 10/20→							
3.0 SCV6 AWD	250 - 09/15→ 280							
3.0 SDV6 AWD	221 09/15→							
JAGUAR - I-PACE (X590) 02/18→								
Guide Sleeve Kit, brake caliper								
EV320 AWD	236 10/20→	Fitting Position: Rear Axle		11.0101-5407.2 260011	Brake System: ATE			
EV400 AWD	294 02/18→							
Guide Bolt, brake caliper								
EV320 AWD	236 10/20→	Fitting Position: Rear Axle		11.8171-0008.1 990049	Brake System: ATE			
EV400 AWD	294 02/18→							







	kW				
JAGUAR - XE (X760) 03/15→					
 Brake Caliper					
2.0	147 - 03/15→ 184	Brake Size: 16"; Fitting Position: Rear Axle Left		24.6238-7039.5 241313	Brake System: ATE Supplementary Article/Supplementary Info: without holder Brake Caliper Type: Fist-type Caliper / Brake caliper with adjusting element for electr. handbrake
2.0 AWD	184 02/17→				
2.0 D	120 - 03/15→ 132				
2.0 D AWD	132 - 10/15→ 177				
Guide Sleeve Kit, brake caliper					
2.0	147 - 03/15→ 221	Fitting Position: Rear Axle		11.0101-5407.2 260011	Brake System: ATE
2.0 AWD	184 - 02/17→ 221				
2.0 D	120 - 03/15→ 132				
2.0 D200 MHEV	150 11/20→				
2.0 D200 MHEV AWD	150 11/20→				
2.0 D AWD	132 - 10/15→ 177				
3.0 S	250 - 03/15→ 280				
Guide Bolt, brake caliper					
2.0	147 - 03/15→ 221	Fitting Position: Rear Axle		11.8171-0008.1 990049	Brake System: ATE
2.0 AWD	184 - 02/17→ 221				
2.0 D	120 - 03/15→ 132				
2.0 D200 MHEV	150 11/20→				
2.0 D200 MHEV AWD	150 11/20→				
2.0 D AWD	132 - 10/15→ 177				
3.0 S	250 - 03/15→ 280				
 Brake Pad Set, disc brake					
2.0	147 - 03/15→ 221	Fitting Position: Rear Axle		13.0460-7326.2 607326	Brake System: ATE 22141 15,5 Wear Warning Contact: prepared for wear indicator / excl. wear warning contact
2.0 AWD	184 - 02/17→ 221				
2.0 D	120 - 03/15→ 132				
2.0 D200 MHEV	150 11/20→				
2.0 D200 MHEV AWD	150 11/20→			13.0470-7326.2 LD7326	Brake System: ATE Wear Warning Contact: prepared for wear indicator / excl. wear warning contact Ceramic
2.0 D AWD	132 - 10/15→ 177				
3.0 S	250 - 03/15→ 280	Fitting Position: Rear Axle		13.0460-7326.2 607326	Brake System: ATE 22141 15,5 Wear Warning Contact: prepared for wear indicator / excl. wear warning contact
JAGUAR - XF II (X260) 05/15→					
 Brake Caliper					
2.0 D	120 05/15→	Brake Size: 16"; Fitting Position: Rear Axle Left		24.6238-7039.5 241313	Brake System: ATE Supplementary Article/Supplementary Info: without holder Brake Caliper Type: Fist-type Caliper / Brake caliper with adjusting element for electr. handbrake
Guide Sleeve Kit, brake caliper					
2.0	147 - 05/15→ 221	Fitting Position: Rear Axle		11.0101-5407.2 260011	Brake System: ATE
2.0 AWD	184 - 03/17→ 221				
2.0 D	120 - 05/15→ 177				
2.0 D200 MHEV	150 11/20→				
2.0 D200 MHEV AWD	150 11/20→				
2.0 D AWD	132 - 03/16→ 177				
3.0	250 - 05/15→ 280				
3.0 AWD	250 - 07/15→ 280				
3.0 D	221 05/15→				
→					



	kW			
JAGUAR - XF II (X260) 05/15→				
Guide Bolt, brake caliper				
2.0	147 - 05/15→ 221	Fitting Position: Rear Axle	11.8171-0008.1 990049	Brake System: ATE
2.0 AWD	184 - 03/17→ 221			
2.0 D	120 - 05/15→ 177			
2.0 D200 MHEV	150 11/20→			
2.0 D200 MHEV AWD	150 11/20→			
2.0 D AWD	132 - 03/16→ 177			
3.0	250 - 05/15→ 280			
3.0 AWD	250 - 07/15→ 280			
3.0 D	221 05/15→			
 Brake Pad Set, disc brake				
2.0	147 - 05/15→ 221	Fitting Position: Rear Axle	13.0460-7326.2 607326	Brake System: ATE 22141 15,5 Wear Warning Contact: prepared for wear indicator / excl. wear warning contact
2.0 AWD	184 - 03/17→ 221			
2.0 D	120 - 05/15→ 177		13.0470-7326.2 LD7326	Brake System: ATE Wear Warning Contact: prepared for wear indicator / excl. wear warning contact Ceramic
2.0 D200 MHEV	150 11/20→			
2.0 D200 MHEV AWD	150 11/20→			
2.0 D AWD	132 - 03/16→ 177			
3.0 D	221 05/15→			
3.0	250 - 05/15→ 280	Fitting Position: Rear Axle	13.0460-7326.2 607326	Brake System: ATE 22141 15,5 Wear Warning Contact: prepared for wear indicator / excl. wear warning contact
3.0 AWD	250 - 07/15→ 280			
JAGUAR - XF SPORTBRAKE (X260) 07/17→				
 Brake Caliper				
2.0 D	120 07/17→	Brake Size: 16"; Fitting Position: Rear Axle Left	24.6238-7039.5 241313	Brake System: ATE Supplementary Article/Supple- mentary Info: without holder Brake Caliper Type: Fist-type Caliper / Brake caliper with adjusting element for electr. handbrake
Guide Sleeve Kit, brake caliper				
2.0	147 - 07/17→ 184	Fitting Position: Rear Axle	11.0101-5407.2 260011	Brake System: ATE
2.0 AWD	184 - 08/18→ 221			
2.0 D	120 - 07/17→ 132			
2.0 D200 MHEV	150 11/20→			
2.0 D200 MHEV AWD	150 11/20→			
2.0 D AWD	132 - 07/17→ 177			
3.0	280 07/17→			
3.0 AWD	280 07/17→			
3.0 D	221 07/17→			
Guide Bolt, brake caliper				
2.0	147 - 07/17→ 184	Fitting Position: Rear Axle	11.8171-0008.1 990049	Brake System: ATE
2.0 AWD	184 - 08/18→ 221			
2.0 D	120 - 07/17→ 132			
2.0 D200 MHEV	150 11/20→			
2.0 D200 MHEV AWD	150 11/20→			
2.0 D AWD	132 - 07/17→ 177			
3.0	280 07/17→			
3.0 AWD	280 07/17→			
3.0 D	221 07/17→			
 Brake Pad Set, disc brake				
2.0	147 - 07/17→ 184	Fitting Position: Rear Axle	13.0460-7326.2 607326	Brake System: ATE 22141 15,5 Wear Warning Contact: prepared for wear indicator / excl. wear warning contact
2.0 AWD	184 - 08/18→ 221			
2.0 D	120 - 07/17→ 132			
→				





	kW				
JAGUAR - XF SPORTBRAKE (X260) 07/17→					
 Brake Pad Set, disc brake					
2.0 D200 MHEV 2.0 D200 MHEV AWD 2.0 D AWD 3.0 D	150 11/20→ 150 11/20→ 132 - 07/17→ 177 221 07/17→	Fitting Position: Rear Axle		13.0470-7326.2 LD7326	Brake System: ATE Wear Warning Contact: prepared for wear indicator / excl. wear warning contact Ceramic
3.0 3.0 AWD	280 07/17→ 280 07/17→	Fitting Position: Rear Axle		13.0460-7326.2 607326	Brake System: ATE 22141 15,5 Wear Warning Contact: prepared for wear indicator / excl. wear warning contact
JAGUAR - XJ (X300, X330) 09/94→12/99					
Guide Sleeve Kit, brake caliper					
12 6.0	229 09/94→09/97	Construction year from: 11/94 → → Construction year to: 07/97; Fitting Position: Front Axle		11.0101-5407.2 260011	Brake System: ATE
6 3.2 R Super Charged 4.0	155 11/94→07/97 235 11/94→07/97	Fitting Position: Front Axle		11.0101-5407.2 260011	Brake System: ATE
6 Sovereign 4.0	177 09/94→07/97	Construction year from: 11/94 → ; Fitting Position: Front Axle		11.0101-5407.2 260011	Brake System: ATE
Guide Bolt, brake caliper					
12 6.0	229 09/94→09/97	Construction year from: 11/94 → → Construction year to: 07/97; Required quantity: 2	2	11.8171-0008.1 990049	Brake System: ATE
6 3.2 R Super Charged 4.0	155 11/94→07/97 235 11/94→07/97	Required quantity: 2	2	11.8171-0008.1 990049	Brake System: ATE
6 Sovereign 4.0	177 09/94→07/97	Construction year from: 11/94 → ; Required quantity: 2	2	11.8171-0008.1 990049	Brake System: ATE
JAGUAR - XJ (X351) 10/09→					
 Brake Master Cylinder					
2.0 Ti4 3.0 SCV6 3.0 SCV6 AWD 3.0 SDV6 3.0 V6 5.0 SCV8 5.0 V8	177 05/12→ 250 03/12→ 250 10/12→ 202 - 10/09→ 221 175 01/11→ 346 - 10/09→ 405 283 10/09→	Left-/right-hand drive vehicles: for left-hand drive vehicles		24.4156-1076.3 011070	Brake System: ATE Diameter [mm]: 27 Supplementary Article/Info 2: without brake fluid reservoir
JEEP - COMPASS (MK49) 08/06→					
 Brake Caliper					
2.0 2.0 CRD 2.0 CRD 4x4	115 - 08/06→ 118 103 08/06→ 88 - 09/06→ 103	Fitting Position: Front Axle Left		24.3571-1815.5 241485	Supplementary Article/Supplementary Info: without holder Brake Caliper Type: Fist-type Caliper
2.2 CRD 2.2 CRD 4x4 2.4 4x4	100 05/11→ 100 - 12/10→ 120 125 - 08/06→ 128	Fitting Position: Front Axle Right		24.3571-1816.5 241486	Supplementary Article/Supplementary Info: without holder Brake Caliper Type: Fist-type Caliper
2.4	125 08/06→	Construction year from: 09/06 → ; Fitting Position: Front Axle Left		24.3571-1815.5 241485	Supplementary Article/Supplementary Info: without holder Brake Caliper Type: Fist-type Caliper
		Construction year from: 09/06 → ; Fitting Position: Front Axle Right		24.3571-1816.5 241486	Supplementary Article/Supplementary Info: without holder Brake Caliper Type: Fist-type Caliper
JEEP - COMPASS (MP, M6, MV, M7) 01/16→					
 Brake Master Cylinder					
1.6 Multijet	96 04/21→			24.4123-1731.3 011094	Diameter [mm]: 23.8 Supplementary Article/Info 2: without brake fluid reservoir
JEEP - PATRIOT (MK74) 02/07→12/17					
 Brake Caliper					
2.0 2.0 4x4 2.0 CRD 2.0 CRD 4x4	115 01/11→12/17 115 02/07→12/17 103 02/07→12/17 88 - 02/07→12/17 103	Fitting Position: Front Axle Left		24.3571-1815.5 241485	Supplementary Article/Supplementary Info: without holder Brake Caliper Type: Fist-type Caliper
→					







	kW							
JEEP - PATRIOT (MK74) 02/07→12/17								
 Brake Caliper								
2.2 CRD	100	01/11→12/17	Fitting Position: Front Axle Right	24.3571-1816.5 241486	Supplementary Article/Supplementary Info: without holder Brake Caliper Type: Fist-type Caliper			
2.2 CRD 4x4	100 - 120	01/11→12/17						
2.4	125	06/09→12/17						
2.4 4x4	125 - 128	02/07→12/17						
2.4 Eco + 4x4	125	07/08→12/17						
JEEP - RENEGADE SUV (BU, B1, BV) 07/14→								
 Brake Master Cylinder								
1.0 T-GDi	88	08/18→	Left-/right-hand drive vehicles: for right-hand drive vehicles	24.4123-1731.3 011094	Diameter [mm]: 23.8 Supplementary Article/Info 2: without brake fluid reservoir			
1.3 PHEV 4Xe	96 - 177	08/20→						
1.3 T-GDi	110	08/18→						
1.3 T-GDi 4x4	132	08/18→						
1.4	100 - 103	07/14→						
1.4 4x4	125	07/14→						
1.6	81	07/14→						
1.6 1.6 MultiJet	96	02/20→						
1.6 CRD	70 - 88	07/14→						
2.0 CRD 4x4	88 - 125	07/14→						
Guide Bolt, brake caliper								
1.6 1.6 MultiJet	96	02/20→				Required quantity: 2	2 11.8171-0008.1 990049	Brake System: ATE
1.6 CRD	70 - 88	07/14→						
2.0 CRD 4x4	88	07/14→						
JEEP - RENEGADE VAN (BU, B1) 07/14→								
 Brake Master Cylinder								
1.4	103	07/14→	Left-/right-hand drive vehicles: for right-hand drive vehicles	24.4123-1731.3 011094	Diameter [mm]: 23.8 Supplementary Article/Info 2: without brake fluid reservoir			
1.4 4x4	125	07/14→						
1.6 E-torQ	81	07/14→						
1.6 MultiJet	88	07/14→						
2.0 MultiJet 4x4	103 - 125	07/14→						
KIA - CADENZA I (VG) 01/10→								
 Brake Disc								
2.4	127 - 132	01/10→	Fitting Position: Rear Axle	24.0110-0400.1 410400	Outer diameter [mm]: 284 Brake Disc Thickness [mm] 10 Minimum thickness [mm] 8.4 Brake Disc Type: Solid			
3.0 GDI	175	01/10→12/15						
3.5 CVVT	213	01/10→12/15						
KIA - CADENZA II (YG) 01/16→								
 Brake Disc								
3.3	191	01/16→	Brake Size: 17"; Fitting Position: Rear Axle	24.0110-0400.1 410400	Outer diameter [mm]: 284 Brake Disc Thickness [mm] 10 Minimum thickness [mm] 8.4 Brake Disc Type: Solid			
3.3 GDI	213	01/16→06/19						
3.3 GDI	209	01/16→						
3.3 MPI	199	01/16→						
KIA - CEED (CD) 03/18→								
 Brake Pad Set, disc brake								
1.0 T-GDI	74 - 88	03/18→	Brake Size: 15" / 16"; Fitting Position: Front Axle	13.0460-5510.2 605510	Brake System: Mobis Wear Warning Contact: with acoustic wear warning Supplementary Article/Supplementary Info: with accessories			
1.4 T-GDI	103	03/18→						
1.5 T-GDI	118	01/21→						
1.6 CRDi 115	85	03/18→						
1.6 CRDi 115 Eco-Dynamics+	85	12/19→						
1.6 CRDi 136	100	03/18→						
1.6 CRDi 136 Eco-Dynamics+	100	12/19→						
1.4	73	03/18→	Brake Size: 16" / 15"; Fitting Position: Front Axle	13.0460-5510.2 605510	Brake System: Mobis Wear Warning Contact: with acoustic wear warning Supplementary Article/Supplementary Info: with accessories			
1.4 LPG	71	12/18→						
1.6	94	03/18→	Fitting Position: Front Axle	13.0460-5510.2 605510	Brake System: Mobis Wear Warning Contact: with acoustic wear warning Supplementary Article/Supplementary Info: with accessories			



	kW				
KIA - CEED (CD) 03/18→					
 Brake Disc					
1.0 T-GDI 1.4 1.4 LPG 1.4 T-GDI 1.5 T-GDI 1.6 1.6 CRDi 115 1.6 CRDi 115 Eco-Dynamics+ 1.6 CRDi 136 1.6 CRDi 136 Eco-Dynamics+ 1.6 T-GDI GT	74 - 03/18→ 88 73 03/18→ 71 12/18→ 103 03/18→ 118 01/21→ 94 03/18→ 85 03/18→ 85 12/19→ 100 03/18→ 100 12/19→ 150 10/18→	Vehicle Equipment: for vehicles with electric parking brake; Fitting Position: Rear Axle	24.0110-0400.1 410400	Outer diameter [mm]: 284 Brake Disc Thickness [mm] 10 Minimum thickness [mm] 8.4 Brake Disc Type: Solid	
KIA - CEED Combi Van (CD) 03/18→					
 Brake Pad Set, disc brake					
1.4 T-GDI CRDi 115 CRDi 136 T-GDI	103 04/18→ 85 05/18→ 100 05/18→ 88 05/18→	Brake Size: 15" / 16"; Fitting Position: Front Axle	13.0460-5510.2 605510	Brake System: Mobis Wear Warning Contact: with acoustic wear warning Supplementary Article/Supplementary Info: with accessories	
GDI Hybrid	77 - 12/19→ 104	Fitting Position: Front Axle	13.0460-5510.2 605510	Brake System: Mobis Wear Warning Contact: with acoustic wear warning Supplementary Article/Supplementary Info: with accessories	
 Brake Disc					
1.4 T-GDI CRDi 115 CRDi 136 T-GDI	103 04/18→ 85 05/18→ 100 05/18→ 88 05/18→	Vehicle Equipment: for vehicles with electric parking brake; Fitting Position: Rear Axle	24.0110-0400.1 410400	Outer diameter [mm]: 284 Brake Disc Thickness [mm] 10 Minimum thickness [mm] 8.4 Brake Disc Type: Solid	
GDI Hybrid	77 - 12/19→ 104	Fitting Position: Rear Axle	24.0110-0400.1 410400	Outer diameter [mm]: 284 Brake Disc Thickness [mm] 10 Minimum thickness [mm] 8.4 Brake Disc Type: Solid	
KIA - CEED Hatchback Van (CD) 03/18→					
 Brake Pad Set, disc brake					
1.4 T-GDI CRDi 115 CRDi 136 T-GDI	103 03/18→ 85 03/18→ 100 03/18→ 88 03/18→	Brake Size: 15" / 16"; Fitting Position: Front Axle	13.0460-5510.2 605510	Brake System: Mobis Wear Warning Contact: with acoustic wear warning Supplementary Article/Supplementary Info: with accessories	
 Brake Disc					
1.4 T-GDI CRDi 115 CRDi 136 T-GDI T-GDI GT	103 03/18→ 85 03/18→ 100 03/18→ 88 03/18→ 150 10/18→	Vehicle Equipment: for vehicles with electric parking brake; Fitting Position: Rear Axle	24.0110-0400.1 410400	Outer diameter [mm]: 284 Brake Disc Thickness [mm] 10 Minimum thickness [mm] 8.4 Brake Disc Type: Solid	
KIA - CEED Sportswagon (CD) 03/18→					
 Brake Pad Set, disc brake					
1.0 T-GDI 1.4 T-GDI 1.5 T-GDI 1.6 CRDi 115 1.6 CRDi 115 Eco-Dynamics+ 1.6 CRDi 136 1.6 CRDi 136 Eco-Dynamics+	74 - 05/18→ 88 103 04/18→ 118 01/21→ 85 05/18→ 85 12/19→ 100 05/18→ 100 12/19→	Brake Size: 15" / 16"; Fitting Position: Front Axle	13.0460-5510.2 605510	Brake System: Mobis Wear Warning Contact: with acoustic wear warning Supplementary Article/Supplementary Info: with accessories	
1.4 1.4 LPG	73 04/18→ 71 12/18→	Brake Size: 16" / 15"; Fitting Position: Front Axle	13.0460-5510.2 605510	Brake System: Mobis Wear Warning Contact: with acoustic wear warning Supplementary Article/Supplementary Info: with accessories	
1.6 1.6 GDI Hybrid	94 05/18→ 77 - 12/19→ 104	Fitting Position: Front Axle	13.0460-5510.2 605510	Brake System: Mobis Wear Warning Contact: with acoustic wear warning Supplementary Article/Supplementary Info: with accessories	
→					



	kW				
KIA - CEED Sportswagon (CD) 03/18→					
 Brake Disc					
1.0 T-GDI	74 - 05/18→ 88	Vehicle Equipment: for vehicles with electric parking brake; Fitting Position: Rear Axle	24.0110-0400.1 410400	Outer diameter [mm]: 284 Brake Disc Thickness [mm] 10 Minimum thickness [mm] 8.4 Brake Disc Type: Solid	
1.4	73 04/18→				
1.4 LPG	71 12/18→				
1.4 T-GDI	103 04/18→				
1.5 T-GDI	118 01/21→				
1.6	94 05/18→				
1.6 CRDi 115	85 05/18→				
1.6 CRDi 115 Eco-Dynamics+	85 12/19→				
1.6 CRDi 136	100 05/18→				
1.6 CRDi 136 Eco-Dynamics+	100 12/19→				
1.6 GDI Hybrid	77 - 12/19→ 104	Fitting Position: Rear Axle	24.0110-0400.1 410400	Outer diameter [mm]: 284 Brake Disc Thickness [mm] 10 Minimum thickness [mm] 8.4 Brake Disc Type: Solid	
KIA - CERATO III Hatchback (YD) 09/12→					
 Brake Disc					
1.6 CVVT	95 11/14→	Fitting Position: Rear Axle	24.0110-0368.1 410368	Outer diameter [mm]: 262 Brake Disc Thickness [mm] 10 Minimum thickness [mm] 8.4 Brake Disc Type: Solid	
KIA - CERATO III Saloon (YD) 09/12→					
 Brake Disc					
1.6 CRDi	100 08/16→	Fitting Position: Rear Axle	24.0110-0368.1 410368	Outer diameter [mm]: 262 Brake Disc Thickness [mm] 10 Minimum thickness [mm] 8.4 Brake Disc Type: Solid	
1.6 CVVT	94 - 11/14→ 95				
2.0 MPI	112 03/16→				
KIA - CERATO IV Saloon (BD, BDM) 02/18→					
 Brake Disc					
1.6 MPI	94 - 02/18→ 96	Axle: Rigid Axle; Fitting Position: Rear Axle	24.0110-0368.1 410368	Outer diameter [mm]: 262 Brake Disc Thickness [mm] 10 Minimum thickness [mm] 8.4 Brake Disc Type: Solid	
1.6 Tci	100 11/18→				
2.0 MPI	110 - 02/18→ 112	Axle: Multilink Axle; Fitting Position: Rear Axle	24.0110-0408.1 410408	Outer diameter [mm]: 262 Brake Disc Thickness [mm] 10 Minimum thickness [mm] 8.4 Brake Disc Type: Solid	
KIA - CERATO KOUP II (TD) 01/09→					
 Brake Disc					
1.6 CVVT	150 09/13→	Fitting Position: Rear Axle	24.0110-0368.1 410368	Outer diameter [mm]: 262 Brake Disc Thickness [mm] 10 Minimum thickness [mm] 8.4 Brake Disc Type: Solid	
KIA - CERATO KOUP III (YD) 12/13→					
 Brake Disc					
1.6 T-GDI	150 12/13→	Fitting Position: Rear Axle	24.0110-0368.1 410368	Outer diameter [mm]: 262 Brake Disc Thickness [mm] 10 Minimum thickness [mm] 8.4 Brake Disc Type: Solid	
KIA - NIRO (DE) 09/16→					
 Brake Disc					
1.6 GDI Hybrid	77 - 09/16→ 107	Construction year from: 05/19 →; Vehicle Equipment: for vehicles without electric parking brake; Fitting Position: Rear Axle	24.0110-0400.1 410400	Outer diameter [mm]: 284 Brake Disc Thickness [mm] 10 Minimum thickness [mm] 8.4 Brake Disc Type: Solid	
		→ Construction year to: 04/19; Fitting Position: Rear Axle	24.0110-0408.1 410408	Outer diameter [mm]: 262 Brake Disc Thickness [mm] 10 Minimum thickness [mm] 8.4 Brake Disc Type: Solid	



	kW				
KIA - NIRO VAN (DE) 09/16→					
 Brake Disc					
GDI Hybrid	77 09/16→	Construction year from: 05/19 →; Vehicle Equipment: for vehicles without electric parking brake; Fitting Position: Rear Axle	24.0110-0400.1 410400	Outer diameter [mm]: 284 Brake Disc Thickness [mm] 10 Minimum thickness [mm] 8.4 Brake Disc Type: Solid	
		→ Construction year to: 04/19; Fitting Position: Rear Axle	24.0110-0408.1 410408	Outer diameter [mm]: 262 Brake Disc Thickness [mm] 10 Minimum thickness [mm] 8.4 Brake Disc Type: Solid	
GDI Hybrid	104 09/16→	Fitting Position: Rear Axle	24.0110-0408.1 410408	Outer diameter [mm]: 262 Brake Disc Thickness [mm] 10 Minimum thickness [mm] 8.4 Brake Disc Type: Solid	
KIA - OPTIMA (FSGDS6B) 01/10→					
 Brake Disc					
1.7 CRDi 2.0 2.0 CVVL 2.0 CVVT Hybrid	100 03/12→ 125 03/12→ 121 03/12→ 110 - 03/12→ 140	→ Construction year to: 12/15; Vehicle Equipment: for vehicles with electric parking brake; Fitting Position: Rear Axle	24.0110-0400.1 410400	Outer diameter [mm]: 284 Brake Disc Thickness [mm] 10 Minimum thickness [mm] 8.4 Brake Disc Type: Solid	
2.4 2.4 CVVT	132 03/12→ 132 01/12→				
2.0 2.4 2.4 Hybrid	204 09/10→ 149 09/10→ 154 09/11→	Construction year from: 03/12 → → Construction year to: 12/15; Vehicle Equipment: for vehicles with electric parking brake; Fitting Position: Rear Axle	24.0110-0400.1 410400	Outer diameter [mm]: 284 Brake Disc Thickness [mm] 10 Minimum thickness [mm] 8.4 Brake Disc Type: Solid	
2.0 CVVT 2.4	110 - 01/11→12/15 121 129 06/10→12/15	Vehicle Equipment: for vehicles with electric parking brake; Fitting Position: Rear Axle	24.0110-0400.1 410400	Outer diameter [mm]: 284 Brake Disc Thickness [mm] 10 Minimum thickness [mm] 8.4 Brake Disc Type: Solid	
KIA - OPTIMA (JF) 09/15→					
 Brake Disc					
1.6 CRDi 1.6 T-GDI 1.7 CRDi	100 09/18→ 132 09/18→ 99 - 11/15→ 104	Rim Size [in]: 16 / 17; Fitting Position: Rear Axle	24.0110-0400.1 410400	Outer diameter [mm]: 284 Brake Disc Thickness [mm] 10 Minimum thickness [mm] 8.4 Brake Disc Type: Solid	
2.0 2.0 CVVL	110 - 09/15→ 113 120 - 09/15→ 124				
2.4 GDI 2.4 MPI	138 09/15→ 126 - 09/15→ 131				
2.0 GDI Hybrid	115 09/16→	Fitting Position: Rear Axle	24.0110-0400.1 410400	Outer diameter [mm]: 284 Brake Disc Thickness [mm] 10 Minimum thickness [mm] 8.4 Brake Disc Type: Solid	
2.0 GDI Hybrid	151 09/16→	Equipment Code: EV1; Fitting Position: Rear Axle	24.0110-0400.1 410400	Outer diameter [mm]: 284 Brake Disc Thickness [mm] 10 Minimum thickness [mm] 8.4 Brake Disc Type: Solid	
KIA - OPTIMA Sportswagon (JF) 09/16→					
 Brake Disc					
1.6 CRDi 1.6 T-GDI 1.7 CRDi	100 01/18→ 132 01/18→ 99 - 09/16→ 104	Rim Size [in]: 16 / 17; Fitting Position: Rear Axle	24.0110-0400.1 410400	Outer diameter [mm]: 284 Brake Disc Thickness [mm] 10 Minimum thickness [mm] 8.4 Brake Disc Type: Solid	
2.0 CVVL	120 09/16→				
2.0 GDi Hybrid 2.0 GDI Hybrid	115 04/17→ 151 04/17→	Equipment Code: EV1; Fitting Position: Rear Axle	24.0110-0400.1 410400	Outer diameter [mm]: 284 Brake Disc Thickness [mm] 10 Minimum thickness [mm] 8.4 Brake Disc Type: Solid	
KIA - PROCEED (CD) 10/18→					
 Brake Pad Set, disc brake					
1.0 T-GDI 1.4 T-GDI 1.6 CRDi 136	88 10/18→ 103 10/18→ 100 10/18→	Fitting Position: Front Axle	13.0460-5510.2 605510	Brake System: Mobis Wear Warning Contact: with acoustic wear warning Supplementary Article/Supplementary Info: with accessories	
→					





	kW				
KIA - PROCEED (CD) 10/18→					
 Brake Pad Set, disc brake					
1.5 T-GDI 1.6 CRDi 136 Eco-Dynamics+	118 01/21→ 100 12/19→	Brake Size: 15" / 16"; Fitting Position: Front Axle	13.0460-5510.2 605510	Brake System: Mobis Wear Warning Contact: with acoustic wear warning Supplementary Article/Supplementary Info: with accessories	
 Brake Disc					
1.0 T-GDI 1.4 T-GDI 1.5 T-GDI 1.6 CRDi 136 1.6 T-GDI 1.6 T-GDI GT	88 10/18→ 103 10/18→ 118 01/21→ 100 10/18→ 147 10/18→ 150 10/18→	Vehicle Equipment: for vehicles with electric parking brake; Fitting Position: Rear Axle	24.0110-0400.1 410400	Outer diameter [mm]: 284 Brake Disc Thickness [mm] 10 Minimum thickness [mm] 8.4 Brake Disc Type: Solid	
KIA - PROCEED Combi Van (CD) 10/18→					
 Brake Pad Set, disc brake					
1.4 T-GDI 1.6 CRDi 136	103 10/18→ 100 10/18→	Fitting Position: Front Axle	13.0460-5510.2 605510	Brake System: Mobis Wear Warning Contact: with acoustic wear warning Supplementary Article/Supplementary Info: with accessories	
 Brake Disc					
1.4 T-GDI 1.6 CRDi 136 1.6 T-GDI GT	103 10/18→ 100 10/18→ 150 10/18→	Vehicle Equipment: for vehicles with electric parking brake; Fitting Position: Rear Axle	24.0110-0400.1 410400	Outer diameter [mm]: 284 Brake Disc Thickness [mm] 10 Minimum thickness [mm] 8.4 Brake Disc Type: Solid	
KIA - SELTOS (SP2, SP2I) 08/19→					
 Brake Disc					
1.6 MPI 1.6 MPI 4WD 1.6 T-GDi 4WD	90 09/19→ 89 09/19→ 130 09/19→	→ Construction year to: 10/20; Fitting Position: Rear Axle	24.0110-0368.1 410368	Outer diameter [mm]: 262 Brake Disc Thickness [mm] 10 Minimum thickness [mm] 8.4 Brake Disc Type: Solid	
2.0 MPI	110 08/19→	Vehicle Equipment: for vehicles without electric parking brake; Fitting Position: Rear Axle	24.0110-0368.1 410368	Outer diameter [mm]: 262 Brake Disc Thickness [mm] 10 Minimum thickness [mm] 8.4 Brake Disc Type: Solid	
KIA - SEPHIA (FA) 01/95→10/97					
Guide Sleeve Kit, brake caliper					
1.5 i 1.8 i 16V	59 02/96→10/97 82 01/95→10/97	Fitting Position: Front Axle	11.0101-5407.2 260011	Brake System: ATE	
1.6 i	59 01/95→10/97	→ Construction year to: 06/96; Fitting Position: Front Axle	11.0101-5407.2 260011	Brake System: ATE	
Guide Bolt, brake caliper					
1.5 i 1.8 i 16V	59 02/96→10/97 82 01/95→10/97	Required quantity: 2; Fitting Position: Front Axle	2 11.8171-0008.1 990049	Brake System: ATE	
1.6 i	59 01/95→10/97	→ Construction year to: 06/96; Required quantity: 2; Fitting Position: Front Axle	2 11.8171-0008.1 990049	Brake System: ATE	
KIA - SEPHIA Saloon (FA) 01/92→09/01					
Guide Sleeve Kit, brake caliper					
1.5 i 1.8 i 16V	59 02/96→10/97 82 01/95→10/97	Fitting Position: Front Axle	11.0101-5407.2 260011	Brake System: ATE	
1.6 i	59 09/93→10/97	Construction year from: 10/93 → → Construction year to: 06/96; Fitting Position: Front Axle	11.0101-5407.2 260011	Brake System: ATE	
Guide Bolt, brake caliper					
1.5 i 1.8 i 16V	59 02/96→10/97 82 01/95→10/97	Required quantity: 2; Fitting Position: Front Axle	2 11.8171-0008.1 990049	Brake System: ATE	
1.6 i	59 09/93→10/97	Construction year from: 10/93 → → Construction year to: 06/96; Required quantity: 2; Fitting Position: Front Axle	2 11.8171-0008.1 990049	Brake System: ATE	



	kW				
KIA - SOUL II (PS) 02/14→					
 Brake Disc					
1.6 CRDi 128 1.6 CRDi 136 1.6 CVVT 1.6 CVVT Flex 1.6 GDI 1.6 LPG 1.6 MPi 2.0 CVVT 1.6 TGDI	94 02/14→ 100 04/15→ 91 - 02/14→ 95 94 09/14→ 97 02/14→ 87 - 12/14→ 96 90 07/18→ 110 08/16→ 150 11/16→	Brake Size: 14"; Fitting Position: Rear Axle	24.0110-0368.1 410368	Outer diameter [mm]: 262 Brake Disc Thickness [mm] 10 Minimum thickness [mm] 8.4 Brake Disc Type: Solid	
		Brake Size: 15"; Fitting Position: Rear Axle	24.0110-0368.1 410368	Outer diameter [mm]: 262 Brake Disc Thickness [mm] 10 Minimum thickness [mm] 8.4 Brake Disc Type: Solid	
2.0 CVVT	113 02/14→	Construction year from: 04/14 →; Brake Size: 14"; Fitting Position: Rear Axle	24.0110-0368.1 410368	Outer diameter [mm]: 262 Brake Disc Thickness [mm] 10 Minimum thickness [mm] 8.4 Brake Disc Type: Solid	
EV Electric	25 - 09/14→ 81	Fitting Position: Rear Axle	24.0110-0400.1 410400	Outer diameter [mm]: 284 Brake Disc Thickness [mm] 10 Minimum thickness [mm] 8.4 Brake Disc Type: Solid	
KIA - SOUL III (SK3) 01/19→					
 Brake Disc					
1.6 MPi 2.0 MPi	91 01/19→ 110 01/19→	Fitting Position: Rear Axle	24.0110-0368.1 410368	Outer diameter [mm]: 262 Brake Disc Thickness [mm] 10 Minimum thickness [mm] 8.4 Brake Disc Type: Solid	
KIA - XCEED (CD) 06/19→					
 Brake Pad Set, disc brake					
1.0 T-GDI 1.4 T-GDI 1.5 T-GDI 1.6 CRDi 115 1.6 CRDi 136	88 06/19→ 103 06/19→ 118 01/21→ 85 06/19→ 100 06/19→	Brake Size: 16" / 15"; Fitting Position: Front Axle	13.0460-5510.2 605510	Brake System: Mobis Wear Warning Contact: with acoustic wear warning Supplementary Article/Supple- mentary Info: with accessories	
1.6 CRDi 115 Eco- Dynamics+ 1.6 CRDi 136 Eco- Dynamics+	85 12/19→ 100 12/19→	Brake Size: 15" / 16"; Fitting Position: Front Axle	13.0460-5510.2 605510	Brake System: Mobis Wear Warning Contact: with acoustic wear warning Supplementary Article/Supple- mentary Info: with accessories	
1.6 GDI Hybrid	77 - 12/19→ 104	Fitting Position: Front Axle	13.0460-5510.2 605510	Brake System: Mobis Wear Warning Contact: with acoustic wear warning Supplementary Article/Supple- mentary Info: with accessories	
 Brake Disc					
1.0 T-GDI 1.4 T-GDI 1.5 T-GDI 1.6 CRDi 115 1.6 CRDi 115 Eco- Dynamics+ 1.6 CRDi 136 1.6 CRDi 136 Eco- Dynamics+ 1.6 GDI Hybrid 1.6 T-GDI	88 06/19→ 103 06/19→ 118 01/21→ 85 06/19→ 85 12/19→ 100 06/19→ 100 12/19→ 77 - 12/19→ 104 147 - 06/19→ 150	Vehicle Equipment: for vehicles with electric parking brake; Fitting Position: Rear Axle	24.0110-0400.1 410400	Outer diameter [mm]: 284 Brake Disc Thickness [mm] 10 Minimum thickness [mm] 8.4 Brake Disc Type: Solid	
KIA - XCEED Van (CD) 06/19→					
 Brake Pad Set, disc brake					
1.4 T-GDI 1.6 CRDi 1.6 GDI Hybrid 1.6 T-GDI	103 06/19→ 100 06/19→ 77 - 12/19→ 104 150 06/19→	Brake Size: 16"; Fitting Position: Front Axle	13.0460-5510.2 605510	Brake System: Mobis Wear Warning Contact: with acoustic wear warning Supplementary Article/Supple- mentary Info: with accessories	
 Brake Disc					
1.4 T-GDI 1.6 CRDi 1.6 GDI Hybrid 1.6 T-GDI	103 06/19→ 100 06/19→ 77 - 12/19→ 104 150 06/19→	Vehicle Equipment: for vehicles with electric parking brake; Fitting Position: Rear Axle	24.0110-0400.1 410400	Outer diameter [mm]: 284 Brake Disc Thickness [mm] 10 Minimum thickness [mm] 8.4 Brake Disc Type: Solid	



	kW				
LAND ROVER - DEFENDER Station Wagon (L316) 05/90→02/16					
 Brake Hose					
2.2 Td4 4x4	90	08/11→02/16 110	+ ABS; Fitting Position: Rear Axle Right	24.5177-0373.3 331541	Length [mm]: 373
2.4 Td4 4x4		103 07/07→02/16			
2.4 Td4 4x4	90	10/06→02/16	Construction year from: 05/07 →; + ABS; Fitting Position: Rear Axle Right	24.5177-0373.3 331541	Length [mm]: 373
LAND ROVER - DISCOVERY SPORT (L550) 09/14→					
 Brake Caliper					
1.5 P300e Hybrid 4x4	147	02/20→ 227	for brake disc diameter [mm]: 300; Brake Size: 16"; Fitting Position: Rear Axle Left	24.6238-7039.5 241313	Brake System: ATE Supplementary Article/Supplementary Info: without holder Brake Caliper Type: Fist-type Caliper / Brake caliper with adjusting element for electr. handbrake
2.0 4x4	176	11/14→ 213			
2.0 D		110 08/15→			
2.0 D150 MHEV 4x4		110 05/19→			
2.0 D165		120 07/20→			
2.0 D165 MHEV 4x4		120 07/20→			
2.0 D180 MHEV 4x4		132 05/19→			
2.0 D200 MHEV 4x4		150 07/20→			
2.0 D240 MHEV 4x4		177 05/19→			
2.0 D 4x4	110	12/14→ 177			
2.0 P200 4x4	147	07/20→			
2.0 P200 FLEX MHEV 4x4	147	09/20→			
2.0 P200 MHEV 4x4	147	05/19→			
2.0 P250 4x4	183	05/19→			
2.0 P250 MHEV 4x4	184	05/19→			
2.0 P290 MHEV 4x4	213	07/20→			
2.0 Si4 FLEX 4x4	177	12/18→			
2.2 D 4x4	110	09/14→ 140			
Guide Sleeve Kit, brake caliper					
1.5 P300e Hybrid 4x4	147	02/20→ 227	Fitting Position: Rear Axle	11.0101-5407.2 260011	Brake System: ATE
2.0 4x4	176	11/14→ 213			
2.0 D		110 08/15→			
2.0 D150 MHEV 4x4		110 05/19→			
2.0 D165		120 07/20→			
2.0 D165 MHEV 4x4		120 07/20→			
2.0 D180 MHEV 4x4		132 05/19→			
2.0 D200 MHEV 4x4		150 07/20→			
2.0 D240 MHEV 4x4		177 05/19→			
2.0 D 4x4	110	12/14→ 177			
2.0 P200 4x4	147	07/20→			
2.0 P200 FLEX MHEV 4x4	147	09/20→			
2.0 P200 MHEV 4x4	147	05/19→			
2.0 P250 4x4	183	05/19→			
2.0 P250 MHEV 4x4	184	05/19→			
2.0 P290 MHEV 4x4	213	07/20→			
2.0 Si4 FLEX 4x4	177	12/18→			
2.2 D 4x4	110	09/14→ 140			
Guide Bolt, brake caliper					
1.5 P300e Hybrid 4x4	147	02/20→ 227	Fitting Position: Rear Axle	11.8171-0008.1 990049	Brake System: ATE
2.0 4x4	176	11/14→ 213			
2.0 D		110 08/15→			
2.0 D150 MHEV 4x4		110 05/19→			
2.0 D165		120 07/20→			
2.0 D165 MHEV 4x4		120 07/20→			
2.0 D180 MHEV 4x4		132 05/19→			
2.0 D200 MHEV 4x4		150 07/20→			
2.0 D240 MHEV 4x4		177 05/19→			
2.0 D 4x4	110	12/14→ 177			
2.0 P200 4x4	147	07/20→			
2.0 P200 FLEX MHEV 4x4	147	09/20→			
2.0 P200 MHEV 4x4	147	05/19→			
2.0 P250 4x4	183	05/19→			
2.0 P250 MHEV 4x4	184	05/19→			
2.0 P290 MHEV 4x4	213	07/20→			
2.0 Si4 FLEX 4x4	177	12/18→			
2.2 D 4x4	110	09/14→ 140			
→					

	kW				
LAND ROVER - DISCOVERY SPORT (L550) 09/14→					
 Brake Pad Set, disc brake					
1.5 P300e Hybrid 4x4 2.0 4x4	147 02/20→ 176 - 11/14→ 213	Fitting Position: Rear Axle		13.0460-7326.2 607326	Brake System: ATE 22141 15,5 Wear Warning Contact: prepared for wear indicator / excl. wear warning contact
2.0 D 2.0 D150 MHEV 4x4 2.0 D165 2.0 D165 MHEV 4x4 2.0 D180 MHEV 4x4 2.0 D200 MHEV 4x4 2.0 D240 MHEV 4x4 2.0 D 4x4	110 08/15→ 110 05/19→ 120 07/20→ 120 07/20→ 132 05/19→ 150 07/20→ 177 05/19→ 110 - 12/14→ 177			13.0470-7326.2 LD7326	Brake System: ATE Wear Warning Contact: prepared for wear indicator / excl. wear warning contact Ceramic
2.0 P200 4x4 2.0 P200 FLEX MHEV 4x4 2.0 P200 MHEV 4x4 2.0 P250 4x4 2.0 P250 MHEV 4x4 2.0 P290 MHEV 4x4 2.0 Si4 FLEX 4x4 2.2 D 4x4	147 07/20→ 147 09/20→ 147 05/19→ 183 05/19→ 184 05/19→ 213 07/20→ 177 12/18→ 110 - 09/14→ 140				
1.5 P300e Hybrid 4x4	227 02/20→	Fitting Position: Rear Axle		13.0460-7326.2 607326	Brake System: ATE 22141 15,5 Wear Warning Contact: prepared for wear indicator / excl. wear warning contact
LAND ROVER - DISCOVERY SPORT VAN (L550) 09/14→					
 Brake Caliper					
eD4 E-Capability SD4 4x4 Si4 4x4 TD4 4x4	110 08/15→ 177 06/15→ 177 - 01/17→ 213 110 - 12/14→ 132	for brake disc diameter [mm]: 300; Brake Size: 16"; Fitting Position: Rear Axle Left		24.6238-7039.5 241313	Brake System: ATE Supplementary Article/Supplementary Info: without holder Brake Caliper Type: Fist-type Caliper / Brake caliper with adjusting element for electr. handbrake
Guide Sleeve Kit, brake caliper					
eD4 E-Capability SD4 4x4 Si4 4x4 TD4 4x4	110 08/15→ 177 06/15→ 177 - 01/17→ 213 110 - 12/14→ 132	Fitting Position: Rear Axle		11.0101-5407.2 260011	Brake System: ATE
Guide Bolt, brake caliper					
eD4 E-Capability SD4 4x4 Si4 4x4 TD4 4x4	110 08/15→ 177 06/15→ 177 - 01/17→ 213 110 - 12/14→ 132	Fitting Position: Rear Axle		11.8171-0008.1 990049	Brake System: ATE
 Brake Pad Set, disc brake					
eD4 E-Capability SD4 4x4 Si4 4x4 TD4 4x4	110 08/15→ 177 06/15→ 177 - 01/17→ 213 110 - 12/14→ 132	Fitting Position: Rear Axle		13.0460-7326.2 607326	Brake System: ATE 22141 15,5 Wear Warning Contact: prepared for wear indicator / excl. wear warning contact
				13.0470-7326.2 LD7326	Brake System: ATE Wear Warning Contact: prepared for wear indicator / excl. wear warning contact Ceramic
LAND ROVER - FREELANDER 2 (L359) 10/06→12/15					
Guide Sleeve Kit, brake caliper					
2.0 Si4 4x4 2.2 eD4 2.2 SD4 4x4 2.2 TD4 4x4 3.2 4x4	177 10/11→10/14 110 08/10→10/14 140 08/10→10/14 110 - 10/06→10/14 118 171 10/06→10/14	Fitting Position: Front Axle		11.0101-5407.2 260011	Brake System: ATE
Guide Bolt, brake caliper					
2.0 Si4 4x4 2.2 eD4 2.2 SD4 4x4 2.2 TD4 4x4 3.2 4x4	177 10/11→10/14 110 08/10→10/14 140 08/10→10/14 110 - 10/06→10/14 118 171 10/06→10/14	Required quantity: 2	2	11.8171-0008.1 990049	Brake System: ATE

	kW						
LAND ROVER - RANGE ROVER EVOQUE (L551) 12/18→							
Guide Sleeve Kit, brake caliper							
2.0 D200 MHEV 4x4	150 07/20→	Fitting Position: Rear Axle	11.0101-5407.2 260011	Brake System: ATE			
2.0 D240 MHEV 4x4	177 12/18→						
2.0 P200 4x4	147 12/18→						
2.0 P200 FLEX MHEV 4x4	147 09/20→						
2.0 P200 MHEV 4x4	147 12/18→						
2.0 P250 4x4	184 12/18→						
2.0 P250 MHEV 4x4	183 12/18→						
2.0 P300 4x4	221 07/20→						
2.0 P300 MHEV 4x4	221 12/18→						
Guide Bolt, brake caliper							
1.5 P160 MHEV	118 09/20→	Fitting Position: Rear Axle	11.8171-0008.1 990049	Brake System: ATE			
1.5 P300e Hybrid 4x4	147 - 02/20→ 227						
2.0 D150	110 12/18→						
2.0 D150 4x4	110 12/18→						
2.0 D150 MHEV 4x4	110 12/18→						
2.0 D165	120 07/20→						
2.0 D165 4x4	120 07/20→						
2.0 D165 MHEV 4x4	120 07/20→						
2.0 D180 4x4	132 12/18→						
2.0 D180 MHEV 4x4	132 12/18→						
2.0 D200 4x4	150 07/20→						
2.0 D200 MHEV 4x4	150 07/20→						
2.0 D240 MHEV 4x4	177 12/18→						
2.0 P200 4x4	147 12/18→						
2.0 P200 FLEX MHEV 4x4	147 09/20→						
2.0 P200 MHEV 4x4	147 12/18→						
2.0 P250 4x4	184 12/18→						
2.0 P250 MHEV 4x4	183 12/18→						
2.0 P300 4x4	221 07/20→						
2.0 P300 MHEV 4x4	221 12/18→						
 Brake Pad Set, disc brake							
1.5 P160 MHEV	118 09/20→				Fitting Position: Rear Axle	13.0460-7326.2 607326	Brake System: ATE 22141 15,5 Wear Warning Contact: prepared for wear indicator / excl. wear warning contact
1.5 P300e Hybrid 4x4	147 02/20→						
2.0 D150	110 12/18→						
2.0 D150 4x4	110 12/18→						
2.0 D150 MHEV 4x4	110 12/18→						
2.0 D165	120 07/20→						
2.0 D165 4x4	120 07/20→						
2.0 D165 MHEV 4x4	120 07/20→						
2.0 D180 4x4	132 12/18→						
2.0 D180 MHEV 4x4	132 12/18→						
2.0 D200 4x4	150 07/20→						
2.0 D200 MHEV 4x4	150 07/20→						
2.0 D240 MHEV 4x4	177 12/18→						
2.0 P200 4x4	147 12/18→						
2.0 P200 FLEX MHEV 4x4	147 09/20→						
2.0 P200 MHEV 4x4	147 12/18→						
2.0 P250 4x4	184 12/18→						
2.0 P250 MHEV 4x4	183 12/18→						
2.0 P300 4x4	221 07/20→						
2.0 P300 MHEV 4x4	221 12/18→						
1.5 P300e Hybrid 4x4	227 02/20→	Fitting Position: Rear Axle	13.0460-7326.2 607326	Brake System: ATE 22141 15,5 Wear Warning Contact: prepared for wear indicator / excl. wear warning contact			
LAND ROVER - RANGE ROVER EVOQUE Convertible (L538) 11/15→12/19							
 Brake Caliper							
2.0 4x4	177 11/15→12/19	Vehicle Identification Number from: GH000001 →; Fitting Position: Rear Axle Left	24.6238-7039.5 241313	Brake System: ATE Supplementary Article/Supplementary Info: without holder Brake Caliper Type: Fist-type Caliper / Brake caliper with adjusting element for electr. handbrake			
2.0 D 4x4	110 - 11/15→12/19 132						
2.0 4x4	177 08/17→12/19	Fitting Position: Rear Axle Left	24.6238-7039.5 241313	Brake System: ATE Supplementary Article/Supplementary Info: without holder Brake Caliper Type: Fist-type Caliper / Brake caliper with adjusting element for electr. handbrake			
2.0 D 4x4	177 08/17→12/19						
→							

	kW				
LAND ROVER - RANGE ROVER EVOQUE Convertible (L538) 11/15→12/19					
 Brake Pad Set, disc brake					
2.0 4x4 2.0 D 4x4	177 11/15→12/19 110 - 11/15→12/19 132	Vehicle Identification Number from: GH000001 →; Fitting Position: Rear Axle		13.0460-7326.2 607326 13.0470-7326.2 LD7326	Brake System: ATE 22141 15,5 Wear Warning Contact: prepared for wear indicator / excl. wear warning contact Brake System: ATE Wear Warning Contact: prepared for wear indicator / excl. wear warning contact Ceramic
2.0 4x4 2.0 D 4x4	177 08/17→12/19 177 08/17→12/19	Fitting Position: Rear Axle		13.0460-7326.2 607326 13.0470-7326.2 LD7326	Brake System: ATE 22141 15,5 Wear Warning Contact: prepared for wear indicator / excl. wear warning contact Brake System: ATE Wear Warning Contact: prepared for wear indicator / excl. wear warning contact Ceramic
LAND ROVER - RANGE ROVER EVOQUE VAN (L538) 06/11→12/19					
 Brake Caliper					
SD4 4x4 TD4 TD4 4x4	140 05/15→12/19 110 05/15→12/19 110 05/15→12/19	Vehicle Identification Number from: GH000001 →; Fitting Position: Rear Axle Left		24.6238-7039.5 241313	Brake System: ATE Supplementary Article/Supplementary Info: without holder Brake Caliper Type: Fist-type Caliper / Brake caliper with adjusting element for electr. handbrake
 Brake Pad Set, disc brake					
SD4 4x4 TD4 TD4 4x4	140 05/15→12/19 110 05/15→12/19 110 05/15→12/19	Vehicle Identification Number from: GH000001 →; Fitting Position: Rear Axle		13.0460-7326.2 607326 13.0470-7326.2 LD7326	Brake System: ATE 22141 15,5 Wear Warning Contact: prepared for wear indicator / excl. wear warning contact Brake System: ATE Wear Warning Contact: prepared for wear indicator / excl. wear warning contact Ceramic
LAND ROVER - RANGE ROVER VELAR (L560) 03/17→					
Guide Sleeve Kit, brake caliper					
2.0 D180 TD4 4x4 2.0 D200 4x4 2.0 D200 MHEV 4x4 2.0 D240 SD4 4x4 2.0 P250 Si4 4x4 2.0 P300 Si4 4x4 2.0 P400 Hybrid 4x4 3.0 D275 SDV6 4x4 3.0 D300 MHEV 4x4 3.0 D300 SDV6 4x4 3.0 P340 SCV6 4x4 3.0 P380 SCV6 4x4 3.0 P400 MHEV 4x4 5.0 SCV8 4x4	132 03/17→ 150 07/20→ 150 07/20→ 177 03/17→ 184 03/17→ 221 03/17→ 221 - 07/20→ 297 202 04/18→ 221 07/20→ 221 03/17→ 250 04/18→ 280 03/17→ 294 07/20→ 405 01/19→	Fitting Position: Rear Axle		11.0101-5407.2 260011	Brake System: ATE
Guide Bolt, brake caliper					
2.0 D180 TD4 4x4 2.0 D200 4x4 2.0 D200 MHEV 4x4 2.0 D240 SD4 4x4 2.0 P250 Si4 4x4 2.0 P300 Si4 4x4 2.0 P400 Hybrid 4x4 3.0 D275 SDV6 4x4 3.0 D300 MHEV 4x4 3.0 D300 SDV6 4x4 3.0 P340 SCV6 4x4 3.0 P380 SCV6 4x4 3.0 P400 MHEV 4x4 5.0 SCV8 4x4	132 03/17→ 150 07/20→ 150 07/20→ 177 03/17→ 184 03/17→ 221 03/17→ 221 - 07/20→ 297 202 04/18→ 221 07/20→ 221 03/17→ 250 04/18→ 280 03/17→ 294 07/20→ 405 01/19→	Fitting Position: Rear Axle		11.8171-0008.1 990049	Brake System: ATE
 Brake Pad Set, disc brake					
2.0 D180 TD4 4x4 2.0 D200 4x4 2.0 D200 MHEV 4x4 2.0 D240 SD4 4x4 2.0 P250 Si4 4x4	132 03/17→ 150 07/20→ 150 07/20→ 177 03/17→ 184 03/17→	Fitting Position: Rear Axle		13.0460-7326.2 607326	Brake System: ATE 22141 15,5 Wear Warning Contact: prepared for wear indicator / excl. wear warning contact

	kW				
LAND ROVER - RANGE ROVER VELAR (L560) 03/17→					
 Brake Pad Set, disc brake					
2.0 P300 Si4 4x4	221	03/17→	Fitting Position: Rear Axle	13.0470-7326.2 LD7326	Brake System: ATE Wear Warning Contact: prepared for wear indicator / excl. wear warning contact Ceramic
2.0 P400 Hybrid 4x4	221	07/20→			
3.0 D275 SDV6 4x4	202	04/18→			
3.0 D300 MHEV 4x4	221	07/20→			
3.0 D300 SDV6 4x4	221	03/17→			
2.0 P400 Hybrid 4x4	297	07/20→	Fitting Position: Rear Axle	13.0460-7326.2 607326	Brake System: ATE 22141 15,5 Wear Warning Contact: prepared for wear indicator / excl. wear warning contact
3.0 P340 SCV6 4x4	250	04/18→			
3.0 P380 SCV6 4x4	280	03/17→			
3.0 P400 MHEV 4x4	294	07/20→			
5.0 SCV8 4x4	405	01/19→			
 Brake Disc					
2.0 D180 TD4 4x4	132	03/17→	Brake Size: 17"; → Vehicle Identification Number to: LA999999; Fitting Position: Front Axle	24.0130-0253.1 430253	Outer diameter [mm]: 325 Brake Disc Thickness [mm] 30 Minimum thickness [mm] 28 Brake Disc Type: Vented
2.0 D200 4x4	150	07/20→			
2.0 D200 MHEV 4x4	150	07/20→			
2.0 D240 SD4 4x4	177	03/17→			
2.0 P250 Si4 4x4	184	03/17→			
2.0 P300 Si4 4x4	221	03/17→			
2.0 P400 Hybrid 4x4	221 - 297	07/20→			
3.0 D275 SDV6 4x4	202	04/18→			
3.0 D300 MHEV 4x4	221	07/20→			
3.0 D300 SDV6 4x4	221	03/17→			
3.0 P340 SCV6 4x4	250	04/18→			
3.0 P380 SCV6 4x4	280	03/17→			
3.0 P400 MHEV 4x4	294	07/20→			
MASERATI - 228 08/86→06/93					
Guide Sleeve Kit, brake caliper					
2.8	182	07/87→12/90	Construction year from: 01/89 →;	11.0101-5407.2 260011	Brake System: ATE
2.8 i	184	12/86→12/90	Fitting Position: Front Axle		
Guide Bolt, brake caliper					
2.8	182	07/87→12/90	Construction year from: 01/89 →;	2 11.8171-0008.1 990049	Brake System: ATE
2.8 i	184	12/86→12/90	Required quantity: 2		
MASERATI - BITURBO (69, 78, AF3, AM 332) 06/84→12/94					
Guide Sleeve Kit, brake caliper					
430	182	02/88→12/94	Construction year from: 01/89 →;	11.0101-5407.2 260011	Brake System: ATE
			Fitting Position: Front Axle		
Guide Bolt, brake caliper					
430	182	02/88→12/94	Construction year from: 01/89 →;	2 11.8171-0008.1 990049	Brake System: ATE
			Required quantity: 2		
MASERATI - BITURBO Coupe (AM 331) 12/81→06/93					
Guide Sleeve Kit, brake caliper					
222	162	01/89→12/92	Fitting Position: Front Axle	11.0101-5407.2 260011	Brake System: ATE
222 E	182	01/89→10/89			
222 SE	184	01/88→12/90			
Guide Bolt, brake caliper					
222	162	01/89→12/92	Required quantity: 2	2 11.8171-0008.1 990049	Brake System: ATE
222 E	182	01/89→10/89			
222 SE	184	01/88→12/90			
MASERATI - BITURBO Spider (AM 333) 07/85→12/94					
Guide Sleeve Kit, brake caliper					
2.8	165	01/89→12/94	Fitting Position: Front Axle	11.0101-5407.2 260011	Brake System: ATE
Guide Bolt, brake caliper					
2.8	165	01/89→12/94	Required quantity: 2	2 11.8171-0008.1 990049	Brake System: ATE
MASERATI - KARIF 04/88→06/00					
Guide Sleeve Kit, brake caliper					
2.8	165 - 182	04/88→12/92	Construction year from: 01/89 →;	11.0101-5407.2 260011	Brake System: ATE
			Fitting Position: Front Axle		
Guide Bolt, brake caliper					
2.8	165 - 182	04/88→12/92	Construction year from: 01/89 →;	2 11.8171-0008.1 990049	Brake System: ATE
			Required quantity: 2		

	kW				
MAZDA - 5 (CR19) 02/05→12/10					
Guide Sleeve Kit, brake caliper					
2.0 CD 2.3	105 02/05→05/10 122 02/05→09/08	Construction year from: 06/05 → → Construction year to: 11/06; Fitting Position: Front Axle		11.0101-5407.2 260011	Brake System: ATE
		Construction year from: 12/06 → ; Fitting Position: Front Axle		11.0101-5407.2 260011	Brake System: ATE
		Construction year from: 06/05 → ; Fitting Position: Rear Axle		11.0101-5407.2 260011	Brake System: ATE
Guide Bolt, brake caliper					
1.8 2.0 2.0 CD	85 02/05→05/10 107 02/05→05/10 81 02/05→05/10	Construction year from: 03/05 → → Construction year to: 11/06; Required quantity: 2	2	11.8171-0008.1 990049	Brake System: ATE
		Construction year from: 03/05 → ; Required quantity: 2	2	11.8171-0008.1 990049	Brake System: ATE
		Construction year from: 12/06 → ; Required quantity: 2	2	11.8171-0008.1 990049	Brake System: ATE
2.0 CD 2.3	105 02/05→05/10 122 02/05→09/08	Construction year from: 06/05 → → Construction year to: 11/06; Required quantity: 2	2	11.8171-0008.1 990049	Brake System: ATE
		Construction year from: 12/06 → ; Required quantity: 2	2	11.8171-0008.1 990049	Brake System: ATE
		Construction year from: 06/05 → ; Required quantity: 2	2	11.8171-0008.1 990049	Brake System: ATE
MAZDA - 5 (CW) 06/10→					
Spring, brake caliper					
1.6 CD 1.8 MZR 2.0	85 07/10→ 85 09/10→ 106 - 06/10→ 110	Required quantity: 2	2	11.8116-0356.1 390586	Brake System: ATE
Guide Sleeve Kit, brake caliper					
1.6 CD 1.8 MZR 2.0	85 07/10→ 85 09/10→ 106 - 06/10→ 110	Fitting Position: Front Axle		11.0101-5407.2 260011	Brake System: ATE
Guide Bolt, brake caliper					
1.6 CD 1.8 MZR 2.0	85 07/10→ 85 09/10→ 106 - 06/10→ 110	Required quantity: 2	2	11.8171-0008.1 990049	Brake System: ATE
MAZDA - 6 Estate (GJ, GL) 08/12→					
 Brake Pad Set, disc brake					
2.0 2.2 D 2.2 D 4WD 2.2 D AWD 2.5	107 - 12/12→ 121 110 - 08/12→ 129 129 07/14→ 110 - 12/12→ 129 141 12/12→	Vehicle Equipment: for vehicles without electric parking brake; Fitting Position: Rear Axle		13.0470-5654.2 LD5654	Brake System: Mando Wear Warning Contact: with acoustic wear warning Ceramic
MAZDA - 6 Estate Van (GJ) 01/13→05/16					
 Brake Pad Set, disc brake					
2.0 2.2 D 2.2 D AWD 2.5	107 - 04/15→05/16 121 110 - 04/15→05/16 129 110 - 01/13→05/16 129 141 04/15→05/16	Vehicle Equipment: for vehicles without electric parking brake; Fitting Position: Rear Axle		13.0470-5654.2 LD5654	Brake System: Mando Wear Warning Contact: with acoustic wear warning Ceramic
MAZDA - 6 Saloon (GJ, GL) 12/12→					
 Brake Pad Set, disc brake					
2.0 2.2 D 2.2 D 4WD 2.5 2.2 D	107 - 12/12→ 121 129 12/12→ 129 07/14→ 141 01/13→ 110 12/12→	Vehicle Equipment: for vehicles without electric parking brake; Fitting Position: Rear Axle		13.0470-5654.2 LD5654	Brake System: Mando Wear Warning Contact: with acoustic wear warning Ceramic
		Construction year from: 01/13 → ; Vehicle Equipment: for vehicles without electric parking brake; Fitting Position: Rear Axle		13.0470-5654.2 LD5654	Brake System: Mando Wear Warning Contact: with acoustic wear warning Ceramic

	kW				
MAZDA - 121 III (JASM, JBSM) 03/96→04/03					
Guide Sleeve Kit, brake caliper					
1.25	55	03/96→04/03	Transmission Type: Manual Transmission; → Construction year to: 01/00; Fitting Position: Front Axle	11.0101-5407.2	260011 Brake System: ATE
			→ Construction year to: 01/00; Transmission Type: Automatic Transmission; Fitting Position: Front Axle	11.0101-5407.2	260011 Brake System: ATE
			Construction year from: 02/00 → → Construction year to: 03/03; Fitting Position: Front Axle	11.0101-5407.2	260011 Brake System: ATE
1.3	37 - 44	03/96→04/03	Construction year from: 02/00 → → Construction year to: 03/03; Fitting Position: Front Axle	11.0101-5407.2	260011 Brake System: ATE
1.8 D	44	03/96→04/03	→ Construction year to: 01/00; Fitting Position: Front Axle	11.0101-5407.2	260011 Brake System: ATE
Guide Bolt, brake caliper					
1.25	55	03/96→04/03	→ Construction year to: 01/00; Transmission Type: Automatic Transmission; Required quantity: 2	2	11.8171-0008.1 990049 Brake System: ATE
			Transmission Type: Manual Transmission; → Construction year to: 01/00; Required quantity: 2; Fitting Position: Front Axle	2	11.8171-0008.1 990049 Brake System: ATE
			Construction year from: 02/00 → → Construction year to: 03/03; Required quantity: 2; Fitting Position: Front Axle	2	11.8171-0008.1 990049 Brake System: ATE
1.3	37 - 44	03/96→04/03	Construction year from: 02/00 → → Construction year to: 03/03; Required quantity: 2; Fitting Position: Front Axle	2	11.8171-0008.1 990049 Brake System: ATE
1.8 D	44	03/96→04/03	→ Construction year to: 01/00; Required quantity: 2; Fitting Position: Front Axle	2	11.8171-0008.1 990049 Brake System: ATE
MERCEDES-BENZ - A-CLASS (W176) 06/12→05/18					
Warning Contact, brake pad wear					
A 160	75	07/15→05/18	Required quantity: 1; Fitting Position: Front Axle	1	24.8190-0067.2 620067
A 160 CDI / d	66	06/13→05/18			
A 180	90	09/12→05/18			
A 180 CDI / d	80	06/12→05/18			
A 180 CDI	80	06/12→10/14			
A 200	115	06/12→05/18			
A 200 CDI / d	100	02/14→05/18			
A 200 CDI / d 4-matic	100	02/14→05/18			
A 220 4-matic	135	05/14→05/18			
A 220 CDI	120 - 125	09/12→05/18			
A 220 CDI 4-matic	125	02/14→05/18			
A 220 d	130	07/15→05/18			
A 220 d 4-matic	130	07/15→05/18			
A 250	155 - 160	06/12→05/18			
A 250 4-matic	155 - 160	06/13→05/18			
A 45 AMG 4-matic	265	06/13→05/18			
AMG A 45 4-matic	280	07/15→05/18			
A 200 CDI	100	06/12→10/14	→ Construction year to: 02/14; Required quantity: 1; Fitting Position: Front Axle	1	24.8190-0067.2 620067
MERCEDES-BENZ - A-CLASS (W177) 03/18→					
Warning Contact, brake pad wear					
A 160	80	06/18→	Required quantity: 1; Fitting Position: Front Axle	1	24.8190-0067.2 620067
A 160 d	70	05/19→			
A 180	100	06/18→			
A 180 d	85	03/18→			
A 200	110	06/18→			
A 200 d	110	11/18→			
A 200 d 4-matic	110	10/19→			
A 220	140	07/18→			
A 220 4-matic	140	07/18→10/19			
A 220 d	140	11/18→			
A 220 d 4-matic	140	10/19→			
A 250	165	03/18→			
A 250 4-matic	165	07/18→			
A 250 e	118 - 160	08/19→			
AMG A 35 4-matic	225	09/18→			
→					

	kW				
MERCEDES-BENZ - A-CLASS (W177) 03/18→					
Warning Contact, brake pad wear					
AMG A 45 4-matic+	285 07/19→		Required quantity: 1;	1	24.8190-0067.2 620067
AMG A 45 S 4-matic+	310 07/19→		Fitting Position: Front Axle		
A 200	120 03/18→		Required quantity: 2;	2	24.8190-0067.2 620067
A 200 4-matic	120 10/20→		Fitting Position: Front Axle		
MERCEDES-BENZ - A-CLASS Saloon (V177) 09/18→					
Warning Contact, brake pad wear					
A 160 d	70 10/19→		Required quantity: 1;	1	24.8190-0067.2 620067
A 180	100 04/19→		Fitting Position: Front Axle		
A 180 d	85 09/18→				
A 200	110 - 09/18→				
	120				
A 200 d	110 08/19→				
A 200 d 4-matic	110 10/19→				
A 220	140 01/19→				
A 220 4-matic	140 09/18→				
A 220 d	140 08/19→				
A 220 d 4-matic	140 10/19→				
A 250	165 09/18→				
A 250 4-matic	165 09/18→				
A 250 e	118 - 08/19→				
	160				
AMG A 35 4-matic	225 03/19→				
A 200 4-matic	120 10/20→		Required quantity: 2;	2	24.8190-0067.2 620067
			Fitting Position: Front Axle		
MERCEDES-BENZ - B-CLASS Sports Tourer (W245) 03/05→11/11					
Warning Contact, brake pad wear					
F-CELL	100 01/10→11/11		Required quantity: 1;	1	24.8190-0067.2 620067
			Fitting Position: Front Axle		
MERCEDES-BENZ - B-CLASS Sports Tourer (W246, W242) 10/11→12/18					
Warning Contact, brake pad wear					
B 160	75 07/15→12/18		Required quantity: 1;	1	24.8190-0067.2 620067
B 160 CDI / d	66 05/13→12/18		Fitting Position: Front Axle		
B 180	90 11/11→12/18				
B 180 CDI / d	80 02/13→12/18				
B 180 CDI	80 11/11→08/14				
B 200	115 11/11→12/18				
B 200 CDI / d	100 08/14→12/18				
B 200 CDI / d 4-matic	100 08/14→12/18				
B 200 CDI	100 11/11→08/14				
B 200 Natural Gas	115 11/12→12/17				
Drive / B 200 c					
B 220 4-matic	135 05/13→12/18				
B 220 CDI / d	120 - 06/13→12/18				
	130				
B 220 CDI / d 4-matic	130 08/14→12/18				
B 220 d 4-matic	125 06/18→12/18				
B 250 4-matic	155 08/14→12/18				
Electric Drive / B 250 e	65 - 11/14→10/17				
	132				
B 220 CDI / d	125 11/11→12/18		Construction year from: 12/12 →;	1	24.8190-0067.2 620067
			Required quantity: 1;		
			Fitting Position: Front Axle		
B 250	155 05/12→12/18		Construction year from: 09/12 →;	1	24.8190-0067.2 620067
			Required quantity: 1;		
			Fitting Position: Front Axle		
MERCEDES-BENZ - B-CLASS Sports Tourer (W247) 12/18→					
Warning Contact, brake pad wear					
B 160	80 04/19→		Required quantity: 1;	1	24.8190-0067.2 620067
B 160 d	70 05/19→		Fitting Position: Front Axle		
B 180	100 12/18→				
B 180 d	85 12/18→				
B 200	110 - 12/18→				
	120				
B 200 4-matic	120 10/20→				
B 200 d	110 12/18→				
B 200 d 4-matic	110 10/19→09/21				
B 220	140 04/19→				
B 220 4-matic	140 01/19→				
B 220 d	140 12/18→				
B 220 d 4-matic	140 10/19→				
B 250	165 01/19→				
B 250 4-matic	165 01/19→				
B 250 e	118 - 06/20→				
	160				

	kW							
MERCEDES-BENZ - C-CLASS (W202) 03/93→05/00								
Guide Sleeve Kit, brake caliper								
C 200 Kompressor	132 - 141	10/95→05/00	Fitting Position: Front Axle	11.0101-5407.2 260011	Brake System: ATE			
C 230 Kompressor	142	10/95→05/00						
C 240	125	06/97→05/00						
C 250 Turbo-D	110	10/95→05/00						
C 280	142 - 145	05/93→05/00	Vehicle Identification Number from: A344661 / F331441 →; Fitting Position: Front Axle	11.0101-5407.2 260011	Brake System: ATE			
Guide Bolt, brake caliper								
C 200 Kompressor	132 - 141	10/95→05/00	Required quantity: 2	2 11.8171-0008.1 990049	Brake System: ATE			
C 230 Kompressor	142	10/95→05/00						
C 240	125	06/97→05/00						
C 250 Turbo-D	110	10/95→05/00						
C 280	142 - 145	05/93→05/00	Vehicle Identification Number from: A344661 / F331441 →; Required quantity: 2	2 11.8171-0008.1 990049	Brake System: ATE			
MERCEDES-BENZ - C-CLASS (W204) 01/07→01/15								
Guide Sleeve Kit, brake caliper								
C 180 CDI	88	04/10→03/14	Vehicle Equipment: for vehicles with sports package / for vehicles with AMG Sports Package; Fitting Position: Rear Axle	11.0101-5407.2 260011	Brake System: ATE			
C 200 CDI	100	11/09→03/14						
C 250 CDI 4-matic	150	01/11→01/14						
			Vehicle Equipment: for vehicles without sports package / for vehicles without AMG sports package; Fitting Position: Rear Axle	11.0101-5407.2 260011	Brake System: ATE			
C 180 CGI	115	01/07→01/14	Construction year from: 04/09 →; Fitting Position: Rear Axle	11.0101-5407.2 260011	Brake System: ATE			
C 200 CGI	135	01/07→01/14						
C 300 4-matic	170	07/07→01/14						
C 180 Kompressor	115	01/08→01/14	Fitting Position: Rear Axle	11.0101-5407.2 260011	Brake System: ATE			
C 200	137	05/11→01/14						
C 220 CDI	120 - 125	10/08→01/14						
C 220 CDI 4-matic	125	02/13→01/14						
C 230 4-matic	150	07/07→01/14						
C 250 CDI	150	08/08→01/14						
C 250 CGI	150	07/09→01/14						
C 280 4-matic	170	07/07→01/14						
C 300	170 - 185	07/09→01/14						
C 300 4-matic	185	02/11→01/14						
C 300 CDI 4-matic	170	01/11→01/14						
C 320 CDI 4-matic	165	07/07→01/14						
C 350	225	01/11→01/14						
C 350 4-matic	200 - 225	07/07→01/14						
C 350 CDI	165 - 195	07/09→01/14						
C 350 CDI 4-matic	165 - 170	07/09→01/14						
C 350 CGI	215	09/08→01/14						
C 180 Kompressor	115	01/07→01/14				Construction year from: 03/07 →; Fitting Position: Rear Axle	11.0101-5407.2 260011	Brake System: ATE
C 200 CDI	100	01/07→12/09						
C 200 Kompressor	135	01/07→01/14						
C 220 CDI	120 - 125	01/07→11/08						
C 230	150	01/07→01/14						
C 280	170	01/07→01/14						
C 320 CDI	165	01/07→01/14						
C 350	200	01/07→01/14						
Guide Bolt, brake caliper								
C 180 CDI	88	04/10→03/14	Vehicle Equipment: for vehicles without sports package / for vehicles without AMG sports package; Required quantity: 2	2 11.8171-0008.1 990049	Brake System: ATE			
C 200 CDI	100	11/09→03/14						
C 250 CDI 4-matic	150	01/11→01/14						
			Vehicle Equipment: for vehicles with sports package / for vehicles with AMG Sports Package; Required quantity: 2	2 11.8171-0008.1 990049	Brake System: ATE			
C 180 CGI	115	01/07→01/14	Construction year from: 04/09 →; Required quantity: 2	2 11.8171-0008.1 990049	Brake System: ATE			
C 200 CGI	135	01/07→01/14						
C 300 4-matic	170	07/07→01/14						
C 180 Kompressor	115	01/08→01/14	Required quantity: 2	2 11.8171-0008.1 990049	Brake System: ATE			
C 200	137	05/11→01/14						
C 220 CDI	120 - 125	10/08→01/14						
C 220 CDI 4-matic	125	02/13→01/14						
→								

	kW			
MERCEDES-BENZ - C-CLASS (W204) 01/07→01/15				
Guide Bolt, brake caliper				
C 230 4-matic	150 07/07→01/14	Required quantity: 2	2	11.8171-0008.1 990049 Brake System: ATE
C 250 CDI	150 08/08→01/14			
C 250 CGI	150 07/09→01/14			
C 280 4-matic	170 07/07→01/14			
C 300	170 - 07/09→01/14			
	185			
C 300 4-matic	185 02/11→01/14			
C 300 CDI 4-matic	170 01/11→01/14			
C 320 CDI 4-matic	165 07/07→01/14			
C 350	225 01/11→01/14			
C 350 4-matic	200 - 07/07→01/14			
	225			
C 350 CDI	165 - 07/09→01/14			
	195			
C 350 CDI 4-matic	165 - 07/09→01/14			
	170			
C 350 CGI	215 09/08→01/14			
C 180 Kompressor	115 01/07→01/14	Construction year from: 03/07 →; Required quantity: 2	2	11.8171-0008.1 990049 Brake System: ATE
C 200 CDI	100 01/07→12/09			
C 200 Kompressor	135 01/07→01/14			
C 220 CDI	120 - 01/07→11/08			
	125			
C 230	150 01/07→01/14			
C 280	170 01/07→01/14			
C 320 CDI	165 01/07→01/14			
C 350	200 01/07→01/14			
MERCEDES-BENZ - C-CLASS (W205) 07/13→				
Guide Sleeve Kit, brake caliper				
AMG C 43 4-matic	270 - 04/16→	Fitting Position: Rear Axle		11.0101-5407.2 260011 Brake System: ATE
	287			
C 160	95 04/15→			
C 180	115 03/14→			
C 180 BlueTEC / d	85 05/14→05/18			
C 180 d	90 05/18→			
C 200	135 - 12/13→			
	150			
C 200 4-matic	135 - 04/15→			
	150			
C 200 BlueTEC / d	100 05/14→05/18			
C 200 d	100 - 10/15→			
	118			
C 200 EQ Boost	135 04/18→			
C 200 EQ Boost 4-matic	135 04/18→			
C 220 BlueTEC / d	120 - 02/14→05/18			
	125			
C 220 d	143 05/18→			
C 220 d 4-matic	125 - 04/15→			
	143			
C 250	155 03/14→05/18			
C 250 BlueTEC / d	150 02/14→05/18			
C 250 BlueTEC / d 4-matic	150 02/14→05/18			
C 300	180 - 09/15→			
	190			
C 300 4-matic	180 - 12/13→			
	190			
C 300 BlueTEC Hybrid / h	150 05/14→05/18			
C 300 d	180 06/18→			
C 300 d 4-matic	180 06/18→			
C 300 de	143 - 05/19→			
	225			
C 300 e	155 - 07/19→			
	235			
C 300 e 4-matic	155 - 07/19→			
	235			
C 300 EQ Boost	190 05/19→			
C 300 EQ Boost 4-matic	190 05/19→			
C 350 e	155 - 02/15→08/18			
	205			
C 450 AMG 4-matic	270 04/15→05/18			
Guide Bolt, brake caliper				
AMG C 43 4-matic	270 - 04/16→	Required quantity: 2; Fitting Position: Rear Axle	2	11.8171-0008.1 990049 Brake System: ATE
	287			
C 180 d	90 05/18→			
C 200 d	110 - 05/18→			
	118			
C 200 EQ Boost	135 04/18→			
C 200 EQ Boost 4-matic	135 04/18→			
C 220 d	143 05/18→			
C 220 d 4-matic	143 05/18→			
→				

	kW			
MERCEDES-BENZ - C-CLASS (W205) 07/13→				
Guide Bolt, brake caliper				
C 300	183 - 05/18→ 190	Required quantity: 2; Fitting Position: Rear Axle	2	11.8171-0008.1 990049 Brake System: ATE
C 300 d	180 06/18→			
C 300 d 4-matic	180 06/18→			
C 450 AMG 4-matic	270 04/15→05/18			
C 160	95 04/15→	Fitting Position: Rear Axle		11.8171-0008.1 990049 Brake System: ATE
C 180	115 03/14→			
C 180 BlueTEC / d	85 05/14→05/18			
C 200	135 - 12/13→ 150			
C 200 4-matic	135 - 04/15→ 150			
C 200 BlueTEC / d	100 05/14→05/18			
C 200 d	100 10/15→05/18			
C 220 BlueTEC / d	120 - 02/14→05/18 125			
C 220 d 4-matic	125 04/15→05/18			
C 250	155 03/14→05/18			
C 250 BlueTEC / d	150 02/14→05/18			
C 250 BlueTEC / d 4-matic	150 02/14→05/18			
C 300	180 09/15→08/18			
C 300 4-matic	180 - 12/13→ 190			
C 300 BlueTEC Hybrid / h	150 05/14→05/18			
C 300 de	143 - 05/19→ 225			
C 300 e	155 - 07/19→ 235			
C 300 e 4-matic	155 - 07/19→ 235			
C 300 EQ Boost	190 05/19→			
C 300 EQ Boost 4-matic	190 05/19→			
C 350 e	155 - 02/15→08/18 205			
Warning Contact, brake pad wear				
AMG C 43 4-matic	270 - 04/16→ 287	Required quantity: 1; Fitting Position: Front Axle	1	24.8190-0067.2 620067
C 160	95 04/15→			
C 180	110 - 03/14→ 115	Required quantity: 1; Fitting Position: Rear Axle	1	24.8190-0067.2 620067
C 180 BlueTEC / d	85 05/14→05/18			
C 180 d	90 05/18→			
C 200	150 08/19→			
C 200 4-matic	135 - 04/15→ 150			
C 200 BlueTEC / d	100 05/14→05/18			
C 200 d	100 - 10/15→ 118			
C 200 EQ Boost	135 04/18→			
C 200 EQ Boost 4-matic	135 04/18→			
C 220 BlueTEC / d	120 - 02/14→05/18 125			
C 220 d	143 05/18→			
C 220 d 4-matic	125 04/15→05/18			
C 250	155 03/14→05/18			
C 250 BlueTEC / d	150 02/14→05/18			
C 300	180 - 09/15→ 190			
C 300 4-matic	180 - 12/13→ 190			
C 300 BlueTEC Hybrid / h	150 05/14→05/18			
C 300 d	180 06/18→			
C 300 d 4-matic	180 06/18→			
C 300 de	143 - 05/19→ 225			
C 300 e	155 - 07/19→ 235			
C 300 e 4-matic	155 - 07/19→ 235			
C 300 EQ Boost	190 05/19→			
C 300 EQ Boost 4-matic	190 05/19→			
C 350 e	155 - 02/15→08/18 205			
C 400 4-matic	245 10/14→			
C 450 AMG 4-matic	270 04/15→05/18			
C 200	135 12/13→08/18	Construction year from: 02/14 →; Required quantity: 1; Fitting Position: Front Axle	1	24.8190-0067.2 620067
→				

	kW				
MERCEDES-BENZ - C-CLASS (W205) 07/13→					
Warning Contact, brake pad wear					
C 200	135 12/13→08/18	Construction year from: 02/14 →; Required quantity: 1; Fitting Position: Rear Axle	1	24.8190-0067.2 620067	
C 220 d 4-matic	143 05/18→	Required quantity: 2; Fitting Position: Front Axle	2	24.8190-0067.2 620067	
		Required quantity: 1; Fitting Position: Rear Axle	1	24.8190-0067.2 620067	
C 250 BlueTEC / d 4-matic	150 02/14→05/18	Vehicle Equipment: for vehicles with AMG Sports Package; Required quantity: 1; Braking System: for vehicles with sports brake system; Fitting Position: Front Axle	1	24.8190-0067.2 620067	
		Construction year from: 05/14 →; Vehicle Equipment: for vehicles without AMG sports package; Required quantity: 1; Braking System: for vehicles without sports brake system; Fitting Position: Front Axle	1	24.8190-0067.2 620067	
		Required quantity: 1; Fitting Position: Rear Axle	1	24.8190-0067.2 620067	
 Wheel Speed Sensor					
C 160	95 04/15→	Fitting Position: Front Axle Right		24.0710-2122.3 360650	Length [mm]: 1,073
C 180	110 - 03/14→ 115	Fitting Position: Front Axle Left		24.0710-2123.3 360651	Length [mm]: 1,049
C 180 BlueTEC / d	85 05/14→05/18				
C 180 d	90 05/18→				
C 200	150 08/19→				
C 200 BlueTEC / d	100 05/14→05/18				
C 200 d	100 - 10/15→ 118				
C 200 EQ Boost	135 04/18→				
C 220 BlueTEC / d	120 - 02/14→05/18 125				
C 220 d	143 05/18→				
C 250	155 03/14→05/18				
C 250 BlueTEC / d	150 02/14→05/18				
C 300	180 - 09/15→ 190				
C 300 BlueTEC Hybrid / h	150 05/14→05/18				
C 300 d	180 06/18→				
C 300 de	143 - 05/19→ 225				
C 300 e	155 - 07/19→ 235				
C 300 EQ Boost	190 05/19→				
C 350 e	155 - 02/15→08/18 205				
C 200	135 12/13→08/18	Construction year from: 02/14 →; Fitting Position: Front Axle Right		24.0710-2122.3 360650	Length [mm]: 1,073
		Construction year from: 02/14 →; Fitting Position: Front Axle Left		24.0710-2123.3 360651	Length [mm]: 1,049
MERCEDES-BENZ - C-CLASS (W206) 03/21→					
Warning Contact, brake pad wear					
AMG C 43 4-matic+	300 04/22→	Required quantity: 1;	1	24.8190-0067.2 620067	
C 300 e	150 - 12/21→ 230	Fitting Position: Front Axle			
		Required quantity: 1; Fitting Position: Rear Axle	1	24.8190-0067.2 620067	
C 180	125 03/21→	Braking System: for vehicles with sports brake system; Required quantity: 1;	1	24.8190-0067.2 620067	
C 200	150 03/21→	for SA code: ME10;			
C 200 4-matic	150 03/21→	Fitting Position: Front Axle			
C 220 d	147 03/21→				
C 300	190 03/21→	Braking System: for vehicles without sports brake system;	1	24.8190-0959.2 620959	
C 300 4-matic	190 03/21→	Required quantity: 1;			
C 300 d	195 03/21→	not for SA code: ME10; Fitting Position: Front Axle			
		Required quantity: 1; Fitting Position: Rear Axle	1	24.8190-0067.2 620067	
C 200 d	120 07/21→	Braking System: for vehicles with sports brake system; Required quantity: 1;	1	24.8190-0067.2 620067	
C 220 d 4-matic	147 07/21→	for SA code: ME10;			
C 300 d 4-matic	195 07/21→	Fitting Position: Front Axle			
		Braking System: for vehicles without sports brake system; Required quantity: 2;	2	24.8190-0959.2 620959	
→					

	kW				
MERCEDES-BENZ - C-CLASS (W206) 03/21→					
Warning Contact, brake pad wear					
C 200 d	120 07/21→		not for SA code: ME10;		
C 220 d 4-matic	147 07/21→		Fitting Position: Front Axle		
C 300 d 4-matic	195 07/21→		Required quantity: 1;	1	24.8190-0067.2 620067
			Fitting Position: Rear Axle		
MERCEDES-BENZ - C-CLASS All-Terrain (S206) 12/21→					
Warning Contact, brake pad wear					
C 200 4-matic	150 12/21→		for SA code: ME10;	1	24.8190-0067.2 620067
C 220 d 4-matic	147 12/21→		Braking System: for vehicles with sports brake system; Required quantity: 1;		
			Fitting Position: Front Axle		
			not for SA code: ME10;	1	24.8190-0959.2 620959
			Braking System: for vehicles without sports brake system;		
			Required quantity: 1;		
			Fitting Position: Front Axle		
			Required quantity: 1;	1	24.8190-0067.2 620067
			Fitting Position: Rear Axle		
MERCEDES-BENZ - C-CLASS Convertible (A205) 06/16→					
Guide Sleeve Kit, brake caliper					
AMG C 43 4-matic	270 - 10/16→ 287		Fitting Position: Rear Axle		11.0101-5407.2 260011 Brake System: ATE
C 180	115 06/16→				
C 200	135 - 06/16→ 150				
C 200 4-matic	135 06/16→05/18				
C 200 d	118 07/18→				
C 200 EQ Boost	135 05/18→				
C 200 EQ Boost 4-matic	135 05/18→				
C 220 d	120 - 06/16→ 143				
C 220 d 4-matic	125 - 06/16→ 143				
C 250	155 06/16→05/18				
C 250 d	150 06/16→05/18				
C 300	180 - 06/16→ 190				
C 300 d	180 07/18→				
C 300 EQ Boost	190 05/19→				
C 300 EQ Boost 4-matic	190 05/19→				
AMG C 63	350 10/16→		Braking System: for vehicles without ceramic brakes;		11.0101-5407.2 260011 Brake System: ATE
AMG C 63 S	375 10/16→		not for brake caliper colour: Red/Silver;		
			Fitting Position: Rear Axle		
Guide Bolt, brake caliper					
AMG C 43 4-matic	270 - 10/16→ 287		Required quantity: 2;	2	11.8171-0008.1 990049 Brake System: ATE
			Fitting Position: Rear Axle		
C 200 d	118 07/18→				
C 200 EQ Boost	135 05/18→				
C 200 EQ Boost 4-matic	135 05/18→				
C 220 d	143 04/18→				
C 220 d 4-matic	143 06/18→				
C 300	190 05/18→				
C 300 d	180 07/18→				
AMG C 63	350 10/16→		Braking System: for vehicles without ceramic brakes;	2	11.8171-0008.1 990049 Brake System: ATE
AMG C 63 S	375 10/16→		Brake Caliper Colour: Red / Silver;		
			Required quantity: 2;		
			Fitting Position: Rear Axle		
C 180	115 06/16→		Fitting Position: Rear Axle		11.8171-0008.1 990049 Brake System: ATE
C 200	135 - 06/16→ 150				
C 200 4-matic	135 06/16→05/18				
C 220 d	120 - 06/16→05/18 125				
C 220 d 4-matic	125 06/16→05/18				
C 250	155 06/16→05/18				
C 250 d	150 06/16→05/18				
C 300	180 06/16→05/18				
C 300 EQ Boost	190 05/19→				
C 300 EQ Boost 4-matic	190 05/19→				
Warning Contact, brake pad wear					
AMG C 43 4-matic	270 - 10/16→ 287		Required quantity: 1;	1	24.8190-0067.2 620067
			Fitting Position: Front Axle		
C 180	115 06/16→		Required quantity: 1;	1	24.8190-0067.2 620067
C 200	135 - 06/16→ 150		Fitting Position: Rear Axle		



	kW			
MERCEDES-BENZ - C-CLASS Convertible (A205) 06/16→				
Warning Contact, brake pad wear				
C 200 4-matic	135 06/16→05/18	Required quantity: 1;	1	24.8190-0067.2 620067
C 200 d	118 07/18→	Fitting Position: Front Axle		
C 200 EQ Boost	135 05/18→	Required quantity: 1;	1	24.8190-0067.2 620067
C 200 EQ Boost 4-matic	135 05/18→	Fitting Position: Rear Axle		
C 220 d	120 - 06/16→			
	143			
C 220 d 4-matic	125 - 06/16→			
	143			
C 250	155 06/16→05/18			
C 250 d	150 06/16→05/18			
C 300	180 - 06/16→			
	190			
C 300 d	180 07/18→			
C 300 EQ Boost	190 05/19→			
C 300 EQ Boost 4-matic	190 05/19→			
C 400 4-matic	245 06/16→			
 Wheel Speed Sensor				
C 180	115 06/16→	Fitting Position: Front Axle Right		24.0710-2122.3 360650 Length [mm]: 1,073
C 200	135 - 06/16→	Fitting Position: Front Axle Left		24.0710-2123.3 360651 Length [mm]: 1,049
	150			
C 200 d	118 07/18→			
C 200 EQ Boost	135 05/18→			
C 220 d	120 - 06/16→			
	143			
C 250	155 06/16→05/18			
C 250 d	150 06/16→05/18			
C 300	180 - 06/16→			
	190			
C 300 d	180 07/18→			
C 300 EQ Boost	190 05/19→			
MERCEDES-BENZ - C-CLASS Coupe (C204) 01/11→				
Guide Sleeve Kit, brake caliper				
C 180	115 06/11→	Vehicle Equipment: for vehicles without sports package / for vehicles without AMG sports package;		11.0101-5407.2 260011 Brake System: ATE
		Fitting Position: Rear Axle		
		Vehicle Equipment: for vehicles with sports package / for vehicles with AMG Sports Package;		11.0101-5407.2 260011 Brake System: ATE
		Fitting Position: Rear Axle		
C 200 CGI	135 06/11→	Fitting Position: Rear Axle		11.0101-5407.2 260011 Brake System: ATE
C 220 CDI	120 - 06/11→			
	125			
C 250	150 06/11→			
C 250 CDI	150 06/11→			
C 350	225 06/11→			
C 350 4-matic	225 09/13→			
Guide Bolt, brake caliper				
C 180	115 06/11→	Vehicle Equipment: for vehicles without sports package / for vehicles without AMG sports package;	2	11.8171-0008.1 990049 Brake System: ATE
		Required quantity: 2		
		Vehicle Equipment: for vehicles with sports package / for vehicles with AMG Sports Package;	2	11.8171-0008.1 990049 Brake System: ATE
		Required quantity: 2		
C 200 CGI	135 06/11→	Required quantity: 2	2	11.8171-0008.1 990049 Brake System: ATE
C 220 CDI	120 - 06/11→			
	125			
C 250	150 06/11→			
C 250 CDI	150 06/11→			
C 350	225 06/11→			
C 350 4-matic	225 09/13→			
MERCEDES-BENZ - C-CLASS Coupe (C205) 10/15→				
Guide Sleeve Kit, brake caliper				
AMG C 43 4-matic	287 05/18→	Fitting Position: Rear Axle		11.0101-5407.2 260011 Brake System: ATE
C 180	115 10/15→			
C 200	135 10/15→05/18			
C 200 4-matic	135 04/16→05/18			
C 200 d	118 07/18→			
C 200 EQ Boost	135 05/18→			
C 200 EQ Boost 4-matic	135 05/18→			
C 220 d	120 - 10/15→			
	143			
C 220 d 4-matic	125 - 04/16→			
	143			
C 250	155 10/15→05/18			
→				

	kW			
MERCEDES-BENZ - C-CLASS Coupe (C205) 10/15→				
Guide Sleeve Kit, brake caliper				
C 250 d	150 10/15→05/18	Fitting Position: Rear Axle	11.0101-5407.2 260011	Brake System: ATE
C 250 d 4-matic	150 04/16→05/18			
C 300	180 - 10/15→			
	190			
C 300 4-matic	190 05/18→			
C 300 d	180 07/18→			
C 300 d 4-matic	180 07/18→			
C 300 EQ Boost	190 05/19→			
C 300 EQ Boost 4-matic	190 05/19→			
Guide Bolt, brake caliper				
AMG C 43 4-matic	287 05/18→	Required quantity: 2;	2 11.8171-0008.1 990049	Brake System: ATE
C 200 d	118 07/18→	Fitting Position: Rear Axle		
C 200 EQ Boost	135 05/18→			
C 200 EQ Boost 4-matic	135 05/18→			
C 220 d	143 04/18→			
C 220 d 4-matic	143 06/18→			
C 300	190 05/18→			
C 300 d	180 07/18→			
C 300 d 4-matic	180 07/18→			
C 180	115 10/15→	Fitting Position: Rear Axle	11.8171-0008.1 990049	Brake System: ATE
C 200	135 10/15→05/18			
C 200 4-matic	135 04/16→05/18			
C 220 d	120 - 10/15→05/18			
	125			
C 220 d 4-matic	125 04/16→05/18			
C 250	155 10/15→05/18			
C 250 d	150 10/15→05/18			
C 250 d 4-matic	150 04/16→05/18			
C 300	180 10/15→12/18			
C 300 4-matic	190 05/18→			
C 300 EQ Boost	190 05/19→			
C 300 EQ Boost 4-matic	190 05/19→			
Warning Contact, brake pad wear				
AMG C 43 4-matic	270 - 04/16→	Required quantity: 1;	1 24.8190-0067.2 620067	
	287	Fitting Position: Front Axle		
C 180	110 - 10/15→	Required quantity: 1;	1 24.8190-0067.2 620067	
	115	Fitting Position: Rear Axle		
C 200	135 10/15→05/18			
C 200 4-matic	135 04/16→05/18			
C 200 d	118 07/18→			
C 200 EQ Boost	135 05/18→			
C 200 EQ Boost 4-matic	135 05/18→			
C 220 d	120 - 10/15→			
	143			
C 220 d 4-matic	125 - 04/16→			
	143			
C 250	155 10/15→05/18			
C 250 d	150 10/15→05/18			
C 250 d 4-matic	150 04/16→05/18			
C 300	180 - 10/15→			
	190			
C 300 4-matic	190 05/18→			
C 300 d	180 07/18→			
C 300 d 4-matic	180 07/18→			
C 300 EQ Boost	190 05/19→			
C 300 EQ Boost 4-matic	190 05/19→			
C 400 4-matic	245 04/16→			
Wheel Speed Sensor				
C 180	110 - 10/15→	Fitting Position: Front Axle Right	24.0710-2122.3 360650	Length [mm]: 1,073
	115			
C 200	135 10/15→05/18	Fitting Position: Front Axle Left	24.0710-2123.3 360651	Length [mm]: 1,049
C 200 d	118 07/18→			
C 200 EQ Boost	135 05/18→			
C 220 d	120 - 10/15→			
	143			
C 250	155 10/15→05/18			
C 250 d	150 10/15→05/18			
C 300	180 - 10/15→			
	190			
C 300 d	180 07/18→			
C 300 EQ Boost	190 05/19→			
MERCEDES-BENZ - C-CLASS T-Model (S202) 06/96→03/01				
Guide Sleeve Kit, brake caliper				
C 200 T	100 06/96→03/01	Fitting Position: Front Axle	11.0101-5407.2 260011	Brake System: ATE
C 200 T Kompressor	120 - 11/96→03/01			
	141			
C 230 T Kompressor	142 06/97→09/00			
C 240 T	125 06/97→03/01			
→				

	kW				
MERCEDES-BENZ - C-CLASS T-Model (S202) 06/96→03/01					
Guide Sleeve Kit, brake caliper					
C 250 T Turbo-D	110 06/96→03/01	Fitting Position: Front Axle		11.0101-5407.2 260011	Brake System: ATE
C 280 T	145 06/97→03/01				
Guide Bolt, brake caliper					
C 200 T	100 06/96→03/01	Required quantity: 2	2	11.8171-0008.1 990049	Brake System: ATE
C 200 T Kompressor	120 - 11/96→03/01 141				
C 230 T Kompressor	142 06/97→09/00				
C 240 T	125 06/97→03/01				
C 250 T Turbo-D	110 06/96→03/01				
C 280 T	145 06/97→03/01				
MERCEDES-BENZ - C-CLASS T-Model (S204) 08/07→08/14					
Guide Sleeve Kit, brake caliper					
C 180	115 02/12→08/14	Vehicle Equipment: for vehicles with sports package / for vehicles with AMG Sports Package;		11.0101-5407.2 260011	Brake System: ATE
C 180 CDI	88 04/10→08/14	Fitting Position: Rear Axle			
C 180 CGI	115 11/09→08/14				
C 180 Kompressor	115 01/08→08/14				
C 200 CDI	100 08/10→08/14	Vehicle Equipment: for vehicles without sports package / for vehicles without AMG sports package;		11.0101-5407.2 260011	Brake System: ATE
C 250 CDI 4-matic	150 04/10→08/14	Fitting Position: Rear Axle			
C 180 Kompressor	115 08/07→08/14	Construction year from: 09/07 →;		11.0101-5407.2 260011	Brake System: ATE
C 200 CDI	100 08/07→12/09	Vehicle Equipment: for vehicles without sports package / for vehicles without AMG sports package;			
		Fitting Position: Rear Axle			
		Construction year from: 09/07 →;		11.0101-5407.2 260011	Brake System: ATE
		Vehicle Equipment: for vehicles with sports package / for vehicles with AMG Sports Package;			
		Fitting Position: Rear Axle			
C 200 CGI	135 08/07→08/14	Construction year from: 04/09 →;		11.0101-5407.2 260011	Brake System: ATE
C 250 CDI	150 01/09→08/14	Fitting Position: Rear Axle			
C 200 Kompressor	135 08/07→08/14	Construction year from: 09/07 →;		11.0101-5407.2 260011	Brake System: ATE
C 220 CDI	125 08/07→11/08	Fitting Position: Rear Axle			
C 230	150 08/07→08/14				
C 280	170 08/07→08/14				
C 320 CDI	165 08/07→08/14				
C 320 CDI 4-matic	165 08/07→12/11				
C 350	200 08/07→08/14				
C 350 CDI 4-matic	165 08/07→12/11				
C 220 CDI	120 - 12/08→08/14 125	Fitting Position: Rear Axle		11.0101-5407.2 260011	Brake System: ATE
C 220 CDI 4-matic	125 02/13→08/14				
C 250	150 02/08→12/12				
C 250 CGI	150 07/09→08/14				
C 300	170 08/07→08/14				
C 300 CDI 4-matic	170 06/11→08/14				
C 350 CDI	165 - 08/07→08/14 195				
C 350 CDI 4-matic	170 10/09→08/14				
C 350 CGI	225 06/11→08/14				
C 220 CDI	120 08/07→11/08	Fitting Position: Rear Axle		11.0101-5407.2 260011	Brake System: ATE
		Construction year from: 09/07 →;		11.0101-5407.2 260011	Brake System: ATE
		Fitting Position: Rear Axle			
Guide Bolt, brake caliper					
C 180	115 02/12→08/14	Vehicle Equipment: for vehicles without sports package / for vehicles without AMG sports package;	2	11.8171-0008.1 990049	Brake System: ATE
C 180 CDI	88 04/10→08/14	Required quantity: 2			
C 180 CGI	115 11/09→08/14				
C 180 Kompressor	115 01/08→08/14				
C 200 CDI	100 08/10→08/14	Vehicle Equipment: for vehicles with sports package / for vehicles with AMG Sports Package; Required quantity: 2	2	11.8171-0008.1 990049	Brake System: ATE
C 250 CDI 4-matic	150 04/10→08/14				
C 180 Kompressor	115 08/07→08/14	Construction year from: 09/07 →;	2	11.8171-0008.1 990049	Brake System: ATE
C 200 CDI	100 08/07→12/09	Vehicle Equipment: for vehicles without sports package / for vehicles without AMG sports package;			
		Required quantity: 2			
		Construction year from: 09/07 →;	2	11.8171-0008.1 990049	Brake System: ATE
		Vehicle Equipment: for vehicles with sports package / for vehicles with AMG Sports Package; Required quantity: 2			
C 200 CGI	135 08/07→08/14	Construction year from: 04/09 →;	2	11.8171-0008.1 990049	Brake System: ATE
C 250 CDI	150 01/09→08/14	Required quantity: 2			
C 200 Kompressor	135 08/07→08/14	Construction year from: 09/07 →;	2	11.8171-0008.1 990049	Brake System: ATE
C 220 CDI	125 08/07→11/08	Required quantity: 2			
C 230	150 08/07→08/14				
→					

	kW			
MERCEDES-BENZ - C-CLASS T-Model (S204) 08/07→08/14				
Guide Bolt, brake caliper				
C 280	170 08/07→08/14	Construction year from: 09/07 →; Required quantity: 2	2	11.8171-0008.1 990049 Brake System: ATE
C 320 CDI	165 08/07→08/14			
C 320 CDI 4-matic	165 08/07→12/11			
C 350	200 08/07→08/14			
C 350 CDI 4-matic	165 08/07→12/11			
C 220 CDI	120 - 12/08→08/14 125	Required quantity: 2	2	11.8171-0008.1 990049 Brake System: ATE
C 220 CDI 4-matic	125 02/13→08/14			
C 250	150 02/08→12/12			
C 250 CGI	150 07/09→08/14			
C 300	170 08/07→08/14			
C 300 CDI 4-matic	170 06/11→08/14			
C 350 CDI	165 - 08/07→08/14 195			
C 350 CDI 4-matic	170 10/09→08/14			
C 350 CGI	225 06/11→08/14			
C 220 CDI	120 08/07→11/08	Construction year from: 09/07 →; Required quantity: 2	2	11.8171-0008.1 990049 Brake System: ATE
		Required quantity: 2	2	11.8171-0008.1 990049 Brake System: ATE
MERCEDES-BENZ - C-CLASS T-Model (S205) 09/14→				
Guide Sleeve Kit, brake caliper				
AMG C 43 4-matic	270 - 04/16→ 287	Fitting Position: Rear Axle		11.0101-5407.2 260011 Brake System: ATE
C 160	95 04/15→			
C 180	115 09/14→			
C 180 BlueTEC / d	85 09/14→05/18			
C 180 d	90 05/18→			
C 200	135 09/14→05/18			
C 200 4-matic	135 04/15→05/18			
C 200 BlueTEC / d	100 09/14→05/18			
C 200 d	100 - 10/15→ 118			
C 200 EQ Boost	135 04/18→			
C 200 EQ Boost 4-matic	135 04/18→			
C 220 BlueTEC / d	120 - 09/14→05/18 125			
C 220 d	143 04/18→			
C 220 d 4-matic	125 - 04/15→ 143			
C 250	155 09/14→05/18			
C 250 BlueTEC / d	150 09/14→05/18			
C 250 BlueTEC / d 4-matic	150 10/14→05/18			
C 300	180 - 09/15→ 190			
C 300 4-matic	190 05/18→			
C 300 BlueTEC Hybrid / h	150 10/14→05/18			
C 300 d	180 06/18→			
C 300 d 4-matic	180 06/18→			
C 300 de	143 - 05/19→ 225			
C 300 e	155 - 07/19→ 235			
C 300 EQ Boost	190 05/19→			
C 300 EQ Boost 4-matic	190 05/19→			
C 350 e	155 - 02/15→05/18 205			
Guide Bolt, brake caliper				
AMG C 43 4-matic	270 04/16→05/18	Fitting Position: Rear Axle		11.8171-0008.1 990049 Brake System: ATE
C 160	95 04/15→			
C 180	115 09/14→			
C 180 BlueTEC / d	85 09/14→05/18			
C 200	135 09/14→05/18			
C 200 4-matic	135 04/15→05/18			
C 200 BlueTEC / d	100 09/14→05/18			
C 200 d	100 10/15→05/18			
C 220 BlueTEC / d	120 - 09/14→05/18 125			
C 220 d 4-matic	125 04/15→05/18			
C 250	155 09/14→05/18			
C 250 BlueTEC / d	150 09/14→05/18			
C 250 BlueTEC / d 4-matic	150 10/14→05/18			
C 300	180 09/15→05/18			
C 300 4-matic	190 05/18→			
C 300 BlueTEC Hybrid / h	150 10/14→05/18			
C 300 de	143 - 05/19→ 225			
→				

	kW				
MERCEDES-BENZ - C-CLASS T-Model (S205) 09/14→					
Guide Bolt, brake caliper					
C 300 e	155 - 07/19→ 235	Fitting Position: Rear Axle		11.8171-0008.1 990049	Brake System: ATE
C 300 EQ Boost	190 05/19→				
C 300 EQ Boost 4-matic	190 05/19→				
C 350 e	155 - 02/15→05/18 205				
AMG C 43 4-matic	287 05/18→	Required quantity: 2;	2	11.8171-0008.1 990049	Brake System: ATE
C 180 d	90 05/18→	Fitting Position: Rear Axle			
C 200 d	110 - 05/18→ 118				
C 200 EQ Boost	135 04/18→				
C 200 EQ Boost 4-matic	135 04/18→				
C 220 d	143 04/18→				
C 220 d 4-matic	143 05/18→				
C 300	190 05/18→				
C 300 d	180 06/18→				
C 300 d 4-matic	180 06/18→				
Warning Contact, brake pad wear					
AMG C 43 4-matic	270 - 04/16→ 287	Required quantity: 1; Fitting Position: Front Axle	1	24.8190-0067.2 620067	
C 160	95 04/15→				
C 180	115 09/14→	Required quantity: 1; Fitting Position: Rear Axle	1	24.8190-0067.2 620067	
C 180 BlueTEC / d	85 09/14→05/18				
C 180 d	90 05/18→				
C 200	135 09/14→05/18				
C 200 4-matic	135 04/15→05/18				
C 200 BlueTEC / d	100 09/14→05/18				
C 200 d	100 - 10/15→ 118				
C 200 EQ Boost	135 04/18→				
C 200 EQ Boost 4-matic	135 04/18→				
C 220 BlueTEC / d	120 - 09/14→05/18 125				
C 220 d	143 04/18→				
C 220 d 4-matic	125 - 04/15→ 143				
C 250	155 09/14→05/18				
C 250 BlueTEC / d	150 09/14→05/18				
C 250 BlueTEC / d 4-matic	150 10/14→05/18				
C 300	180 - 09/15→ 190				
C 300 4-matic	190 05/18→				
C 300 BlueTEC Hybrid / h	150 10/14→05/18				
C 300 d	180 06/18→				
C 300 d 4-matic	180 06/18→				
C 300 de	143 - 05/19→ 225				
C 300 e	155 - 07/19→ 235				
C 300 EQ Boost	190 05/19→				
C 300 EQ Boost 4-matic	190 05/19→				
C 350 e	155 - 02/15→05/18 205				
C 400 4-matic	245 10/14→				
C 450 AMG 4-matic	270 04/15→05/18	Vehicle Equipment: for vehicles without AMG sports package; Required quantity: 1; Braking System: for vehicles without sports brake system; Fitting Position: Front Axle	1	24.8190-0067.2 620067	
		Required quantity: 1; Fitting Position: Rear Axle	1	24.8190-0067.2 620067	
 Wheel Speed Sensor					
C 160	95 04/15→	Fitting Position: Front Axle Right		24.0710-2122.3 360650	Length [mm]: 1,073
C 180	115 09/14→				
C 180 BlueTEC / d	85 09/14→05/18	Fitting Position: Front Axle Left		24.0710-2123.3 360651	Length [mm]: 1,049
C 180 d	90 05/18→				
C 200	135 09/14→05/18				
C 200 BlueTEC / d	100 09/14→05/18				
C 200 d	100 - 10/15→ 118				
C 200 EQ Boost	135 04/18→				
C 220 BlueTEC / d	120 - 09/14→05/18 125				
C 220 d	143 04/18→				
C 250	155 09/14→05/18				
C 250 BlueTEC / d	150 09/14→05/18				
→					

	kW				
MERCEDES-BENZ - C-CLASS T-Model (S205) 09/14→					
 Wheel Speed Sensor					
C 300	180 - 09/15→ 190		Fitting Position: Front Axle Right	24.0710-2122.3 360650	Length [mm]: 1,073
C 300 BlueTEC Hybrid / h	150 10/14→05/18		Fitting Position: Front Axle Left	24.0710-2123.3 360651	Length [mm]: 1,049
C 300 d	180 06/18→				
C 300 de	143 - 05/19→ 225				
C 300 e	155 - 07/19→ 235				
C 300 EQ Boost	190 05/19→				
C 350 e	155 - 02/15→05/18 205				
C 400 4-matic	245 10/14→				
MERCEDES-BENZ - C-CLASS T-MODEL (S206) 03/21→					
Warning Contact, brake pad wear					
AMG C 43 4-matic+	300 04/22→		Required quantity: 1;	1 24.8190-0067.2 620067	
C 300 e	150 - 12/21→ 230		Fitting Position: Front Axle		
			Required quantity: 1;	1 24.8190-0067.2 620067	
			Fitting Position: Rear Axle		
C 180	125 03/21→		Braking System: for vehicles with sports brake system; Required quantity: 1;	1 24.8190-0067.2 620067	
C 200	150 03/21→		for SA code: ME10;		
C 200 4-matic	150 10/21→		Fitting Position: Front Axle		
C 220 d	147 03/21→				
C 300 d	195 03/21→		Braking System: for vehicles without sports brake system; Required quantity: 1; not for SA code: ME10; Fitting Position: Front Axle	1 24.8190-0959.2 620959	
			Required quantity: 1;	1 24.8190-0067.2 620067	
			Fitting Position: Rear Axle		
C 200 d	120 07/21→		Braking System: for vehicles with sports brake system; Required quantity: 1;	1 24.8190-0067.2 620067	
C 220 d 4-matic	147 03/21→		for SA code: ME10;		
C 300	190 10/21→		Fitting Position: Front Axle		
C 300 4-matic	190 10/21→		Braking System: for vehicles without sports brake system; Required quantity: 2; not for SA code: ME10; Fitting Position: Front Axle	2 24.8190-0959.2 620959	
			Required quantity: 1;	1 24.8190-0067.2 620067	
			Fitting Position: Rear Axle		
MERCEDES-BENZ - CITAN Box Body/MPV (W415) 11/12→08/21					
 Brake Disc					
108 CDI	55 - 11/12→08/21 59		Rim Size [in]: 14;	24.0122-0270.1 422270	Outer diameter [mm]: 258
109 CDI	66 - 11/12→08/21 70		Fitting Position: Front Axle		Brake Disc Thickness [mm] 22
111 CDI	81 - 06/13→08/21 85				Minimum thickness [mm] 19.8
112	84 06/13→08/21				Brake Disc Type: Vented
					Supplementary Article/Info 2: with bolts/screws
MERCEDES-BENZ - CITAN Box Body/MPV (W420) 09/21→					
Guide Sleeve Kit, brake caliper					
1.3 110	75 09/21→		Fitting Position: Front Axle	11.0101-5407.2 260011	Brake System: ATE
1.3 113	96 09/21→		Fitting Position: Rear Axle	11.0101-5407.2 260011	Brake System: ATE
1.5 108 CDI	55 09/21→				
1.5 110 CDI	70 09/21→				
1.5 112 CDI	85 09/21→				
Guide Bolt, brake caliper					
1.3 110	75 09/21→		Fitting Position: Front Axle	11.8171-0008.1 990049	Brake System: ATE
1.3 113	96 09/21→				
1.5 108 CDI	55 09/21→				
1.5 110 CDI	70 09/21→				
1.5 112 CDI	85 09/21→				
MERCEDES-BENZ - CITAN Mixto (Double Cabin) (W415) 11/12→08/21					
 Brake Disc					
109 CDI	66 11/12→08/21		Rim Size [in]: 14;	24.0122-0270.1 422270	Outer diameter [mm]: 258
111 CDI	81 06/13→08/21		Fitting Position: Front Axle		Brake Disc Thickness [mm] 22
					Minimum thickness [mm] 19.8
					Brake Disc Type: Vented
					Supplementary Article/Info 2: with bolts/screws

	kW				
MERCEDES-BENZ - CITAN MPV (W415) 11/12→08/21					
 Brake Disc					
108 CDI	55 - 11/12→08/21	Rim Size [in]: 14; Fitting Position: Front Axle	24.0122-0270.1 422270	Outer diameter [mm]: 258 Brake Disc Thickness [mm] 22 Minimum thickness [mm] 19.8 Brake Disc Type: Vented Supplementary Article/Info 2: with bolts/screws	
109 CDI	59				
111 CDI	66 - 11/12→08/21				
112	70				
	81 - 06/13→08/21				
	85				
	84 06/13→08/21				
MERCEDES-BENZ - CITAN Tourer (W420) 09/21→					
Guide Sleeve Kit, brake caliper					
108 CDI	55 09/21→	Fitting Position: Front Axle	11.0101-5407.2 260011	Brake System: ATE	
110	75 09/21→				
110 CDI	70 09/21→	Fitting Position: Rear Axle	11.0101-5407.2 260011	Brake System: ATE	
113	96 09/21→				
Guide Bolt, brake caliper					
108 CDI	55 09/21→	Fitting Position: Front Axle	11.8171-0008.1 990049	Brake System: ATE	
110	75 09/21→				
110 CDI	70 09/21→				
113	96 09/21→				
MERCEDES-BENZ - CLA (C118) 03/19→					
Warning Contact, brake pad wear					
AMG CLA 35 4-matic	225 04/19→	Required quantity: 1; Fitting Position: Front Axle	1 24.8190-0067.2 620067		
AMG CLA 45 4-matic+	285 07/19→				
AMG CLA 45 S 4-matic+	310 07/19→				
CLA 180	100 03/19→				
CLA 180 d	85 03/19→				
CLA 200	110 - 03/19→				
	120				
CLA 200 4-matic	120 10/20→				
CLA 200 d	110 04/19→				
CLA 200 d 4-matic	110 04/19→				
CLA 220	140 03/19→				
CLA 220 4-matic	140 03/19→				
CLA 220 d	140 04/19→				
CLA 220 d 4-matic	140 07/20→				
CLA 250	165 03/19→				
CLA 250 4-matic	165 03/19→				
CLA 250 e	118 - 06/20→				
	160				
MERCEDES-BENZ - CLA Coupe (C117) 01/13→03/19					
Warning Contact, brake pad wear					
AMG CLA 45 4-matic	280 07/15→03/19	Required quantity: 1; Fitting Position: Front Axle	1 24.8190-0067.2 620067		
CLA 180	90 01/13→03/19				
CLA 180 CDI / d	80 10/13→05/18				
CLA 200	110 - 01/13→03/19				
	115				
CLA 200 CDI / d	100 07/14→03/19				
CLA 200 CDI / d 4-matic	100 07/14→03/19				
CLA 200 CDI	100 06/13→08/14				
CLA 220 4-matic	135 04/16→03/19				
CLA 220 CDI / d	120 - 01/13→03/19				
	130				
CLA 220 CDI / d 4-matic	120 - 08/14→03/19				
	130				
CLA 220 CDI 4-matic	125 07/14→03/19				
CLA 250	155 - 01/13→03/19				
	160				
CLA 250 4-matic	155 - 07/13→03/19				
	160				
CLA 45 AMG 4-matic	265 07/13→03/19				
MERCEDES-BENZ - CLA Shooting Brake (X117) 01/15→03/19					
Warning Contact, brake pad wear					
AMG CLA 45 4-matic	280 07/15→03/19	Required quantity: 1; Fitting Position: Front Axle	1 24.8190-0067.2 620067		
CLA 180	90 01/15→03/19				
CLA 180 d	80 07/15→05/18				
CLA 200	115 01/15→03/19				
CLA 200 CDI / d	100 01/15→03/19				
CLA 200 CDI / d 4-matic	100 01/15→03/19				
CLA 220 4-matic	135 04/16→03/19				
CLA 220 CDI / d	120 - 01/15→03/19				
	130				
CLA 220 CDI / d 4-matic	120 - 01/15→03/19				
	130				
CLA 220 d	125 07/18→03/19				
CLA 220 d 4-matic	125 07/18→03/19				
	→				

	kW				
MERCEDES-BENZ - CLA Shooting Brake (X117) 01/15→03/19					
Warning Contact, brake pad wear					
CLA 250	155	01/15→03/19	Required quantity: 1; Fitting Position: Front Axle	1	24.8190-0067.2 620067
CLA 250 4-matic	155	01/15→03/19			
	160				
CLA 45 AMG 4-matic	265	01/15→07/15			
MERCEDES-BENZ - CLA Shooting Brake (X118) 06/19→					
Warning Contact, brake pad wear					
AMG CLA 35 4-matic	225	06/19→	Required quantity: 1; Fitting Position: Front Axle	1	24.8190-0067.2 620067
AMG CLA 45 4-matic+	285	07/19→			
AMG CLA 45 S 4-matic+	310	07/19→			
CLA 180	100	06/19→			
CLA 180 d	85	06/19→			
CLA 200	110	06/19→			
	120				
CLA 200 d	110	06/19→			
CLA 200 d 4-matic	110	10/19→			
CLA 220	140	06/19→			
CLA 220 d	140	06/19→			
CLA 220 d 4-matic	140	10/19→			
CLA 250	165	06/19→			
CLA 250 4-matic	165	06/19→			
CLA 250 e	118	06/20→			
	160				
MERCEDES-BENZ - CLK (C208) 06/97→12/03					
Guide Sleeve Kit, brake caliper					
200	100	06/97→06/02	Fitting Position: Front Axle		11.0101-5407.2 260011 Brake System: ATE
200 Kompressor	120	06/97→06/02			
	141				
230 Kompressor	142	06/97→06/02			
	145				
320	160	06/97→06/02			
430	205	07/98→06/02			
Guide Bolt, brake caliper					
200	100	06/97→06/02	Required quantity: 2; Fitting Position: Front Axle	2	11.8171-0008.1 990049 Brake System: ATE
200 Kompressor	120	06/97→06/02			
	141				
230 Kompressor	142	06/97→06/02			
	145				
320	160	06/97→06/02			
430	205	07/98→06/02			
MERCEDES-BENZ - CLK Convertible (A208) 03/98→03/02					
Guide Sleeve Kit, brake caliper					
200	100	03/98→03/02	Construction year from: 06/98 →; Fitting Position: Front Axle		11.0101-5407.2 260011 Brake System: ATE
200 Kompressor	141	03/98→06/00			
230 Kompressor	142	03/98→06/00			
320	160	03/98→03/02			
200 Kompressor	120	06/00→03/02	Fitting Position: Front Axle		11.0101-5407.2 260011 Brake System: ATE
230 Kompressor	145	06/00→03/02			
Guide Bolt, brake caliper					
200	100	03/98→03/02	Construction year from: 06/98 →; Required quantity: 2	2	11.8171-0008.1 990049 Brake System: ATE
200 Kompressor	141	03/98→06/00			
230 Kompressor	142	03/98→06/00			
320	160	03/98→03/02			
200 Kompressor	120	06/00→03/02	Required quantity: 2	2	11.8171-0008.1 990049 Brake System: ATE
230 Kompressor	145	06/00→03/02			
430	205	09/98→03/02	Construction year from: 06/99 →; Required quantity: 2	2	11.8171-0008.1 990049 Brake System: ATE
MERCEDES-BENZ - CLS (C218) 01/11→12/17					
Guide Sleeve Kit, brake caliper					
CLS 350	225	01/11→08/14	Fitting Position: Rear Axle		11.0101-5407.2 260011 Brake System: ATE
CLS 350 BlueTEC / d	185	02/13→12/17			
	190				
CLS 350 BlueTEC / d 4-matic	185	02/13→12/17			
CLS 350 CDI / d	195	01/11→08/14			
CLS 350 CDI / d 4-matic	195	09/11→08/14			
CLS 350 d 4-matic	190	04/15→12/17			
CLS 400	245	05/14→12/17			
CLS 400 4-matic	245	05/14→12/17			
CLS 500	300	02/11→12/17			
CLS 500 4-matic	300	09/11→12/17			
→					

	kW				
MERCEDES-BENZ - CLS (C218) 01/11→12/17					
Guide Bolt, brake caliper					
CLS 350	225	01/11→08/14	Required quantity: 2	2	11.8171-0008.1 990049 Brake System: ATE
CLS 350 BlueTEC / d	185	02/13→12/17			
	190				
CLS 350 BlueTEC / d 4-matic	185	02/13→12/17			
CLS 350 CDI / d	195	01/11→08/14			
CLS 350 CDI / d 4-matic	195	09/11→08/14			
CLS 350 d 4-matic	190	04/15→12/17			
CLS 400	245	05/14→12/17			
CLS 400 4-matic	245	05/14→12/17			
CLS 500	300	02/11→12/17			
CLS 500 4-matic	300	09/11→12/17			
MERCEDES-BENZ - CLS (C219) 10/04→02/11					
Guide Sleeve Kit, brake caliper					
CLS 350	200	10/04→12/10	→ Construction year to: 10/10;		11.0101-5407.2 260011 Brake System: ATE
	215		Fitting Position: Rear Axle		
CLS 500	225	10/04→12/10			
	285				
Guide Bolt, brake caliper					
CLS 350	200	10/04→12/10	→ Construction year to: 10/10;	2	11.8171-0008.1 990049 Brake System: ATE
	215		Required quantity: 2;		
CLS 500	225	10/04→12/10	Fitting Position: Front Axle		
CLS 500	285	04/06→12/10	→ Construction year to: 10/10;	2	11.8171-0008.1 990049 Brake System: ATE
			Required quantity: 2		
MERCEDES-BENZ - CLS (C257) 12/17→					
Warning Contact, brake pad wear					
AMG CLS 53 EQ Boost 4-matic+	320	05/18→	Required quantity: 1;	1	24.8190-0959.2 620959
			Fitting Position: Front Axle		
			Required quantity: 1;	1	24.8190-0067.2 620067
			Fitting Position: Rear Axle		
CLS 220 d	143	06/18→	Required quantity: 1;	1	24.8190-0067.2 620067
CLS 300 d	180	04/18→	Fitting Position: Front Axle		
CLS 300 d 4-matic	195	04/21→	Required quantity: 1;	1	24.8190-0067.2 620067
CLS 350 d	210	08/18→	Fitting Position: Rear Axle		
CLS 350 d 4-matic	183	12/17→	Required quantity: 1;	1	24.8190-0067.2 620067
	210		Fitting Position: Rear Axle		
CLS 350 EQ Boost	220	08/18→			
CLS 350 EQ Boost 4-matic	220	08/18→			
CLS 400 d 4-matic	243	12/17→			
	250				
CLS 450 EQ Boost 4-matic	270	12/17→			
MERCEDES-BENZ - CLS Shooting Brake (X218) 10/12→12/17					
Guide Sleeve Kit, brake caliper					
CLS 220 BlueTEC / d	120	05/14→12/17	Fitting Position: Rear Axle		11.0101-5407.2 260011 Brake System: ATE
	130				
CLS 250 BlueTEC / d 4-matic	150	05/14→12/17			
CLS 250 CDI / BlueTEC / d	150	10/12→12/17			
CLS 350	225	10/12→08/14			
CLS 350 BlueTEC / d	185	05/14→12/17			
	190				
CLS 350 BlueTEC / d 4-matic	185	05/14→12/17			
CLS 350 CDI / d	195	10/12→08/14			
CLS 350 CDI / d 4-matic	195	10/12→08/14			
CLS 350 d 4-matic	190	04/15→12/17			
CLS 400	245	05/14→12/17			
CLS 400 4-matic	245	05/14→12/17			
CLS 500	300	10/12→12/17			
CLS 500 4-matic	300	10/12→12/17			
Guide Bolt, brake caliper					
CLS 220 BlueTEC / d	120	05/14→12/17	Required quantity: 2	2	11.8171-0008.1 990049 Brake System: ATE
	130				
CLS 250 BlueTEC / d 4-matic	150	05/14→12/17			
CLS 250 CDI / BlueTEC / d	150	10/12→12/17			
CLS 350	225	10/12→08/14			
CLS 350 BlueTEC / d	185	05/14→12/17			
	190				
→					

	kW				
MERCEDES-BENZ - CLS Shooting Brake (X218) 10/12→12/17					
Guide Bolt, brake caliper					
CLS 350 BlueTEC / d 4-matic	185	05/14→12/17	Required quantity: 2	2	11.8171-0008.1 990049 Brake System: ATE
CLS 350 CDI / d	195	10/12→08/14			
CLS 350 CDI / d 4-matic	195	10/12→08/14			
CLS 350 d 4-matic	190	04/15→12/17			
CLS 400	245	05/14→12/17			
CLS 400 4-matic	245	05/14→12/17			
CLS 500	300	10/12→12/17			
CLS 500 4-matic	300	10/12→12/17			
MERCEDES-BENZ - E-CLASS (W210) 06/95→08/03					
Guide Sleeve Kit, brake caliper					
E 200	100	06/95→08/00	Fitting Position: Front Axle		11.0101-5407.2 260011 Brake System: ATE
E 200 CDI	85	07/99→03/02			
E 200 Kompressor	120	08/00→03/02			
E 220 CDI	100 - 105	07/99→03/02			
E 230	110	06/95→06/97			
E 240	125	08/00→03/02			
E 270 CDI	120 - 125	07/99→03/02			
E 280	142 - 150	01/96→03/02			
E 280 4-matic	150	12/96→03/02			
E 290 Turbo-D	95	03/96→07/99			
E 300 D	100	06/95→06/97			
E 300 Turbo-D	130	12/96→07/99			
E 320	162 - 165	06/95→03/02			
E 320 4-matic	165	06/97→03/02			
E 320 CDI	145	07/99→03/02			
E 200 CDI	75	06/98→03/02	Construction year from: 07/98 →;		11.0101-5407.2 260011 Brake System: ATE
E 220 CDI	92	06/98→07/99	Fitting Position: Front Axle		
E 200 D	65	01/96→03/02	Construction year from: 10/96 →;		11.0101-5407.2 260011 Brake System: ATE
			Fitting Position: Front Axle		
E 200 Kompressor	137	06/97→03/02	Construction year from: 09/97 →;		11.0101-5407.2 260011 Brake System: ATE
E 240	125	06/97→08/00	Fitting Position: Front Axle		
E 250 Turbo-D	110	06/97→07/99			
E 220 D	55 - 70	06/95→03/02	→ Construction year to: 06/98;		11.0101-5407.2 260011 Brake System: ATE
			Fitting Position: Front Axle		
E 250 D	83	06/95→07/99	Fitting Position: Front Axle		11.0101-5407.2 260011 Brake System: ATE
			Left-/right-hand drive vehicles: for right-hand drive vehicles;		11.0101-5407.2 260011 Brake System: ATE
			Fitting Position: Front Axle		
Guide Bolt, brake caliper					
E 200	100	06/95→08/00	Required quantity: 2;	2	11.8171-0008.1 990049 Brake System: ATE
E 200 CDI	85	07/99→03/02	Fitting Position: Front Axle		
E 200 Kompressor	120	08/00→03/02			
E 220 CDI	100 - 105	07/99→03/02			
E 230	110	06/95→06/97			
E 240	125	08/00→03/02			
E 270 CDI	120 - 125	07/99→03/02			
E 280	142 - 150	01/96→03/02			
E 280 4-matic	150	12/96→03/02			
E 290 Turbo-D	95	03/96→07/99			
E 300 D	100	06/95→06/97			
E 300 Turbo-D	130	12/96→07/99			
E 320	162 - 165	06/95→03/02			
E 320 4-matic	165	06/97→03/02			
E 320 CDI	145	07/99→03/02			
E 200 CDI	75	06/98→03/02	Construction year from: 07/98 →;	2	11.8171-0008.1 990049 Brake System: ATE
E 220 CDI	92	06/98→07/99	Required quantity: 2;		
			Fitting Position: Front Axle		
E 200 D	65	01/96→03/02	Construction year from: 10/96 →;	2	11.8171-0008.1 990049 Brake System: ATE
			Required quantity: 2;		
			Fitting Position: Front Axle		
E 200 Kompressor	137	06/97→03/02	Construction year from: 09/97 →;	2	11.8171-0008.1 990049 Brake System: ATE
E 240	125	06/97→08/00	Required quantity: 2;		
E 250 Turbo-D	110	06/97→07/99	Fitting Position: Front Axle		
E 220 D	55 - 70	06/95→03/02	→ Construction year to: 06/98;	2	11.8171-0008.1 990049 Brake System: ATE
			Required quantity: 2;		
			Fitting Position: Front Axle		
E 250 D	83	06/95→07/99	Left-/right-hand drive vehicles: for right-hand drive vehicles; Required quantity: 2;	2	11.8171-0008.1 990049 Brake System: ATE
			Fitting Position: Front Axle		
→					

	kW				
MERCEDES-BENZ - E-CLASS (W210) 06/95→08/03					
Guide Bolt, brake caliper					
E 250 D	83 06/95→07/99	Required quantity: 2; Fitting Position: Front Axle	2	11.8171-0008.1 990049	Brake System: ATE
MERCEDES-BENZ - E-CLASS (W211) 03/02→03/09					
Guide Sleeve Kit, brake caliper					
E 420 CDI	231 01/06→12/08	Vehicle Equipment: for vehicles without sports package / for vehicles without AMG sports package; Fitting Position: Rear Axle		11.0101-5407.2 260011	Brake System: ATE
E 500	285 04/06→12/08	Fitting Position: Rear Axle		11.0101-5407.2 260011	Brake System: ATE
Guide Bolt, brake caliper					
E 240 4-matic	130 03/03→12/08	Required quantity: 2	2	11.8171-0008.1 990049	Brake System: ATE
E 320 4-matic	165 03/03→12/08				
E 500	285 04/06→12/08				
E 280 4-matic	170 01/06→12/08	Vehicle Equipment: for vehicles without sports package / for vehicles without AMG sports package;	2	11.8171-0008.1 990049	Brake System: ATE
E 280 CDI 4-matic	140 03/05→12/08				
E 320 CDI 4-matic	165 03/05→12/08				
E 350 4-matic	200 03/05→12/08	Required quantity: 2			
E 420 CDI	231 01/06→12/08				
MERCEDES-BENZ - E-CLASS (W212) 01/09→12/16					
Guide Sleeve Kit, brake caliper					
E 180	115 08/13→12/15	Fitting Position: Rear Axle		11.0101-5407.2 260011	Brake System: ATE
E 200	135 01/13→12/16				
E 200 CGI	135 08/09→12/15				
E 200 NGT	115 - 03/11→12/15				
	120				
E 220 BlueTEC	130 05/14→12/15				
E 220 BlueTEC 4-matic	125 01/15→12/15				
E 250	150 - 05/09→12/16				
	155				
E 250 CDI / BlueTEC 4-matic	150 01/11→12/15				
E 250 CGI	150 01/09→12/15				
E 300	185 07/11→12/15				
E 300 4-matic	185 07/11→12/15				
E 350	225 09/11→12/15				
E 350 4-matic	225 09/11→12/15				
E 350 BlueTEC	185 - 01/13→12/15				
	190				
E 350 BlueTEC 4-matic	185 - 01/13→12/15				
	190				
E 350 CDI	157 - 09/10→12/15				
	195				
E 350 CDI 4-matic	170 - 09/09→12/15				
	195				
E 400	245 01/13→12/16				
E 400 4-matic	245 01/13→12/16				
E 500	300 09/11→12/15				
E 500 4-matic	300 09/11→12/15				
E 200 CDI / BlueTEC	100 01/09→12/15	Construction year from: 03/09 →;		11.0101-5407.2 260011	Brake System: ATE
E 300	170 01/09→12/13	Fitting Position: Rear Axle			
E 350	200 01/09→12/13				
E 350 4-matic	200 01/09→08/11				
E 350 BlueTEC	155 01/09→12/15				
E 350 CDI	170 01/09→12/15				
E 350 CGI	215 01/09→08/11				
E 500	285 01/09→12/11				
E 500 4-matic	285 01/09→12/11				
E 220 CDI	120 01/09→12/15	Vehicle Identification Number from: A 007599 →; Fitting Position: Rear Axle		11.0101-5407.2 260011	Brake System: ATE
E 220 CDI / BlueTEC	125 01/09→12/16	Construction year from: 03/09 →;		11.0101-5407.2 260011	Brake System: ATE
		Fitting Position: Rear Axle			
E 250 CDI / BlueTEC	150 01/09→12/16	Construction year from: 03/09 →;		11.0101-5407.2 260011	Brake System: ATE
		→ Vehicle Identification Number to: A 007598; Fitting Position: Rear Axle			
E 300 CDI / BlueTEC	170 03/11→12/15	Construction year from: 04/11 →;		11.0101-5407.2 260011	Brake System: ATE
		Fitting Position: Rear Axle			
E 300 Hybrid / BlueTEC Hybrid	150 12/11→12/16	Construction year from: 06/12 →;		11.0101-5407.2 260011	Brake System: ATE
		Fitting Position: Rear Axle			
Guide Bolt, brake caliper					
E 180	115 08/13→12/15	Required quantity: 2;	2	11.8171-0008.1 990049	Brake System: ATE
E 200	135 01/13→12/16	Fitting Position: Rear Axle			
E 200 CGI	135 08/09→12/15				
E 200 NGT	115 - 03/11→12/15				
	120				
E 220 BlueTEC	130 05/14→12/15				
→					

	kW				
MERCEDES-BENZ - E-CLASS (W212) 01/09→12/16					
Guide Bolt, brake caliper					
E 220 BlueTEC 4-matic	125	01/15→12/15	Required quantity: 2; Fitting Position: Rear Axle	2	11.8171-0008.1 990049 Brake System: ATE
E 250	155	01/13→12/16			
E 250 CDI / BlueTEC 4-matic	150	01/11→12/15			
E 250 CGI	150	01/09→12/15			
E 300	185	07/11→12/15			
E 300 4-matic	185	07/11→12/15			
E 350	225	09/11→12/15			
E 350 4-matic	225	09/11→12/15			
E 350 BlueTEC	185 -	01/13→12/15			
	190				
E 350 BlueTEC 4-matic	185 -	01/13→12/15			
	190				
E 350 CDI	157 -	09/10→12/15			
	195				
E 350 CDI 4-matic	170 -	09/09→12/15			
	195				
E 400	245	01/13→12/16			
E 400 4-matic	245	01/13→12/16			
E 500	300	09/11→12/15			
E 500 4-matic	300	09/11→12/15			
E 200 CDI / BlueTEC	100	01/09→12/15	Construction year from: 03/09 →; Required quantity: 2; Fitting Position: Rear Axle	2	11.8171-0008.1 990049 Brake System: ATE
E 300	170	01/09→12/13			
E 350	200	01/09→12/13			
E 350 4-matic	200	01/09→08/11			
E 350 BlueTEC	155	01/09→12/15			
E 350 CDI	170	01/09→12/15			
E 350 CGI	215	01/09→08/11			
E 500	285	01/09→12/11			
E 500 4-matic	285	01/09→12/11			
E 220 CDI	120	01/09→12/15	Construction year from: 03/09 →; Required quantity: 2; Fitting Position: Rear Axle	2	11.8171-0008.1 990049 Brake System: ATE
E 220 CDI / BlueTEC	125	01/09→12/16			
			Vehicle Identification Number from: A 007599 →; Required quantity: 2; Fitting Position: Rear Axle	2	11.8171-0008.1 990049 Brake System: ATE
E 250	150	05/09→12/11	Fitting Position: Rear Axle		11.8171-0008.1 990049 Brake System: ATE
E 250 CDI / BlueTEC	150	01/09→12/16	Construction year from: 03/09 →; → Vehicle Identification Number to: A 007598; Required quantity: 2; Fitting Position: Rear Axle	2	11.8171-0008.1 990049 Brake System: ATE
E 300 CDI / BlueTEC	170	03/11→12/15	Construction year from: 04/11 →; Required quantity: 2; Fitting Position: Rear Axle	2	11.8171-0008.1 990049 Brake System: ATE
E 300 Hybrid / BlueTEC Hybrid	150	12/11→12/16	Construction year from: 06/12 →; Required quantity: 2; Fitting Position: Rear Axle	2	11.8171-0008.1 990049 Brake System: ATE
MERCEDES-BENZ - E-CLASS (W213) 01/16→					
Warning Contact, brake pad wear					
2.0 E 220 d	147	02/22→	Required quantity: 1; Fitting Position: Front Axle	1	24.8190-0067.2 620067
2.0 E 220 d 4-matic	147	02/22→			
AMG E 43 4-matic	295	07/16→	Required quantity: 1; Fitting Position: Rear Axle	1	24.8190-0067.2 620067
E 180	115	01/17→			
E 200	135 -	01/16→			
	145				
E 200 4-matic	135	07/16→			
E 200 d	110 -	07/16→			
	118				
E 200 EQ Boost	145	06/19→			
E 200 EQ Boost 4-matic	145	06/19→			
E 220 d	120 -	01/16→			
	143				
E 220 d 4-matic	120 -	10/16→			
	143				
E 250	155	07/16→			
E 300	180 -	07/16→			
	190				
E 300 4-matic	180	09/16→			
E 300 d	180	12/17→			
E 300 d 4-matic	195	01/21→			
E 300 de	143 -	10/18→			
	225				
E 300 de 4-matic	143 -	06/20→			
	225				
E 300 e	155 -	11/18→			
	235				
E 300 e 4-matic	155 -	07/20→			
	235				
E 300 EQ Boost	190	06/19→			
→					

	kW				
MERCEDES-BENZ - E-CLASS (W213) 01/16→					
Warning Contact, brake pad wear					
E 350 d	190 - 01/16→ 210	Required quantity: 1; Fitting Position: Front Axle	1	24.8190-0067.2	620067
E 350 d 4-matic	190 06/17→05/18	Required quantity: 1; Fitting Position: Rear Axle	1	24.8190-0067.2	620067
E 350 e	155 - 07/16→ 235				
E 350 EQ Boost	220 08/18→				
E 400 4-matic	245 07/16→				
E 400 d	250 12/18→				
E 400 d 4-matic	243 - 04/18→ 250				
E 450 4-matic	270 08/18→				
E 450 EQ Boost 4-matic	270 07/20→				
AMG E 53 EQ Boost 4-matic+	320 04/18→	Fitting Position: Front Axle		24.8190-0959.2	620959
		Required quantity: 1; Fitting Position: Rear Axle	1	24.8190-0067.2	620067
AMG E 63 4-matic+	420 01/17→	Required quantity: 1; Fitting Position: Rear Axle	1	24.8190-0067.2	620067
AMG E 63 S 4-matic+	450 01/17→				
E 400 4-matic	245 06/16→	Construction year from: 07/16 →; Required quantity: 1; Fitting Position: Front Axle	1	24.8190-0067.2	620067
		Construction year from: 07/16 →; Required quantity: 1; Fitting Position: Rear Axle	1	24.8190-0067.2	620067
MERCEDES-BENZ - E-CLASS All-Terrain (S213) 01/17→					
Warning Contact, brake pad wear					
E 200 EQ Boost	145 08/20→	Required quantity: 1; Fitting Position: Front Axle	1	24.8190-0067.2	620067
E 220 d 4-matic	143 - 01/17→ 147				
E 350 d 4-matic	190 06/17→	Required quantity: 1; Fitting Position: Rear Axle	1	24.8190-0067.2	620067
E 400 d 4-matic	243 - 08/18→ 250				
E 450 EQ Boost	270 08/20→				
MERCEDES-BENZ - E-CLASS Convertible (A207) 01/10→12/16					
Guide Sleeve Kit, brake caliper					
E 200	135 03/13→12/16	Fitting Position: Rear Axle		11.0101-5407.2	260011 Brake System: ATE
E 250	155 06/13→12/16				
E 300	185 04/11→12/16				
E 320	200 07/14→12/16				
E 350	200 - 03/10→12/14 225				
E 350 BlueTEC/ d	190 05/14→12/16				
E 350 BlueTEC	185 06/13→12/16				
E 350 CDI	195 04/11→12/13				
E 350 CGI	215 01/10→12/14				
E 400	245 06/13→12/16				
E 500	300 09/11→12/16				
E 350 CDI	170 01/10→12/11	Construction year from: 03/10 →;		11.0101-5407.2	260011 Brake System: ATE
E 500	285 01/10→12/11	Fitting Position: Rear Axle			
Guide Bolt, brake caliper					
E 300	185 04/11→12/16	Required quantity: 2	2	11.8171-0008.1	990049 Brake System: ATE
E 320	200 07/14→12/16				
E 350	200 - 03/10→12/14 225				
E 350 BlueTEC/ d	190 05/14→12/16				
E 350 BlueTEC	185 06/13→12/16				
E 350 CDI	195 04/11→12/13				
E 350 CGI	215 01/10→12/14				
E 400	245 06/13→12/16				
E 500	300 09/11→12/16				
E 350 CDI	170 01/10→12/11	Construction year from: 03/10 →;	2	11.8171-0008.1	990049 Brake System: ATE
E 500	285 01/10→12/11	Required quantity: 2			
MERCEDES-BENZ - E-CLASS Convertible (A238) 06/17→					
Warning Contact, brake pad wear					
AMG E53 EQ Boost 4-matic+	320 05/18→	Fitting Position: Front Axle		24.8190-0959.2	620959
		Required quantity: 1; Fitting Position: Rear Axle	1	24.8190-0067.2	620067
E 200	135 06/17→	Required quantity: 1; Fitting Position: Front Axle	1	24.8190-0067.2	620067
E 200 4-matic	135 10/17→				
E 200 EQ Boost	145 06/19→	Required quantity: 1; Fitting Position: Rear Axle	1	24.8190-0067.2	620067
E 200 EQ Boost 4-matic	145 06/19→				
E 220 d	120 - 06/17→ 143				
E 220 d 4-matic	143 10/17→				

	kW				
MERCEDES-BENZ - E-CLASS Convertible (A238) 06/17→					
Warning Contact, brake pad wear					
E 300	180 - 06/17→ 190		Required quantity: 1; Fitting Position: Front Axle	1	24.8190-0067.2 620067
E 300 d	180 05/18→			1	24.8190-0067.2 620067
E 300 d 4-matic	195 04/21→		Required quantity: 1; Fitting Position: Rear Axle		
E 300 EQ Boost	190 06/19→				
E 350 d	210 11/18→				
E 350 d 4-matic	190 06/17→				
E 350 EQ Boost	220 10/17→				
E 400 4-matic	245 06/17→				
E 400 d 4-matic	243 - 08/18→ 250				
E 450	270 07/20→				
E 450 4-matic	270 08/18→				
E 450 EQ Boost 4-matic	270 07/20→				
MERCEDES-BENZ - E-CLASS Coupe (C207) 01/09→12/16					
Guide Sleeve Kit, brake caliper					
E 200	135 06/13→12/16		Fitting Position: Rear Axle	11.0101-5407.2 260011	Brake System: ATE
E 250	155 06/13→12/16				
E 300	185 04/11→06/16				
E 320	200 07/14→12/16				
E 350	200 - 01/10→12/14 225				
E 350 4-matic	225 02/13→12/16				
E 350 BlueTEC / d	190 05/14→12/16				
E 350 BlueTEC	185 06/13→12/16				
E 350 CDI	195 06/11→06/13				
E 400	245 06/13→12/16				
E 500	300 09/11→12/16				
E 350 CDI	170 01/09→06/11		Construction year from: 05/09 →;	11.0101-5407.2 260011	Brake System: ATE
E 350 CGI	215 01/09→12/11		Fitting Position: Rear Axle		
E 500	285 01/09→12/16				
Guide Bolt, brake caliper					
E 300	185 04/11→06/16		Required quantity: 2	2	11.8171-0008.1 990049 Brake System: ATE
E 320	200 07/14→12/16				
E 350	200 - 01/10→12/14 225				
E 350 4-matic	225 02/13→12/16				
E 350 BlueTEC / d	190 05/14→12/16				
E 350 BlueTEC	185 06/13→12/16				
E 350 CDI	195 06/11→06/13				
E 400	245 06/13→12/16				
E 500	300 09/11→12/16				
E 350 CDI	170 01/09→06/11		Construction year from: 05/09 →;	2	11.8171-0008.1 990049 Brake System: ATE
E 350 CGI	215 01/09→12/11		Required quantity: 2		
E 500	285 01/09→12/16				
MERCEDES-BENZ - E-CLASS Coupe (C238) 12/16→					
Warning Contact, brake pad wear					
AMG E 53 EQ Boost 4-matic+	320 05/18→		Required quantity: 1; Fitting Position: Front Axle	1	24.8190-0959.2 620959
			Required quantity: 1; Fitting Position: Rear Axle	1	24.8190-0067.2 620067
E 200	135 12/16→		Required quantity: 1;	1	24.8190-0067.2 620067
E 200 4-matic	135 06/17→		Fitting Position: Front Axle		
E 200 EQ Boost	145 06/19→		Required quantity: 1;	1	24.8190-0067.2 620067
E 200 EQ Boost 4-matic	145 06/19→		Fitting Position: Rear Axle		
E 220 d	120 - 12/16→ 143				
E 220 d 4-matic	143 03/17→				
E 300	180 - 12/16→ 190				
E 300 d	180 05/18→				
E 300 d 4-matic	195 01/21→				
E 300 EQ Boost	190 06/19→				
E 350 d	210 11/18→				
E 350 d 4-matic	190 06/17→				
E 350 EQ Boost	220 10/17→				
E 400 4-matic	245 12/16→				
E 400 d 4-matic	243 - 08/18→ 250				
E 450	270 07/20→				
E 450 4-matic	270 08/18→				
E 450 EQ Boost 4-matic	270 07/20→				
MERCEDES-BENZ - E-CLASS T-Model (S210) 06/96→03/03					
Guide Sleeve Kit, brake caliper					
E 200 T	100 06/96→08/00		Fitting Position: Front Axle	11.0101-5407.2 260011	Brake System: ATE
E 200 T Kompressor	120 08/00→03/03				

	kW				
MERCEDES-BENZ - E-CLASS T-Model (S210) 06/96→03/03					
Guide Sleeve Kit, brake caliper					
E 230 T	110 06/96→06/97	Fitting Position: Front Axle		11.0101-5407.2 260011	Brake System: ATE
E 240 T	125 08/00→03/03				
E 270 T CDI	120 - 07/99→03/03				
	125				
E 280 T 4-matic	150 12/96→03/03				
E 300 T Turbo-D	130 12/96→07/99				
E 320 T	165 12/96→03/03				
E 320 T CDI	145 07/99→03/03				
E 200 T Kompressor	137 06/97→03/03	Construction year from: 09/97 →;		11.0101-5407.2 260011	Brake System: ATE
E 240 T	125 06/97→03/03	Fitting Position: Front Axle			
E 250 T Turbo-D	110 06/97→07/99				
E 220 T CDI	100 - 05/99→03/03	Wheelbase [mm]: 2,833;		11.0101-5407.2 260011	Brake System: ATE
	105	Fitting Position: Front Axle			
E 290 T Turbo-D	95 06/96→07/99	Wheelbase [mm]: 3,570;		11.0101-5407.2 260011	Brake System: ATE
		Fitting Position: Front Axle			
E 220 T CDI	92 06/98→07/99	Construction year from: 07/98 →;		11.0101-5407.2 260011	Brake System: ATE
		Wheelbase [mm]: 3,570;			
		Fitting Position: Front Axle			
		Construction year from: 07/98 →;		11.0101-5407.2 260011	Brake System: ATE
		Wheelbase [mm]: 2,833;			
		Fitting Position: Front Axle			
E 250 T D	83 06/96→07/99	Wheelbase [mm]: 2,833;		11.0101-5407.2 260011	Brake System: ATE
		Fitting Position: Front Axle			
		Wheelbase [mm]: 3,570;		11.0101-5407.2 260011	Brake System: ATE
		Fitting Position: Front Axle			
		Left-/right-hand drive vehicles: for right-hand drive vehicles;		11.0101-5407.2 260011	Brake System: ATE
		Wheelbase [mm]: 2,833;			
		Fitting Position: Front Axle			
E 280 T	150 12/96→03/03	Wheelbase [mm]: 3,570;		11.0101-5407.2 260011	Brake System: ATE
		Fitting Position: Front Axle			
E 320 T 4-matic	165 12/96→03/03	Construction year from: 06/97 →;		11.0101-5407.2 260011	Brake System: ATE
		Fitting Position: Front Axle			
Guide Bolt, brake caliper					
E 200 T	100 06/96→08/00	Required quantity: 2;	2	11.8171-0008.1 990049	Brake System: ATE
E 200 T Kompressor	120 08/00→03/03	Fitting Position: Front Axle			
E 230 T	110 06/96→06/97				
E 240 T	125 08/00→03/03				
E 270 T CDI	120 - 07/99→03/03				
	125				
E 280 T 4-matic	150 12/96→03/03				
E 300 T Turbo-D	130 12/96→07/99				
E 320 T	165 12/96→03/03				
E 320 T CDI	145 07/99→03/03				
E 200 T Kompressor	137 06/97→03/03	Construction year from: 09/97 →;	2	11.8171-0008.1 990049	Brake System: ATE
E 240 T	125 06/97→03/03	Required quantity: 2;			
E 250 T Turbo-D	110 06/97→07/99	Fitting Position: Front Axle			
E 220 T CDI	100 - 05/99→03/03	Wheelbase [mm]: 2,833;	2	11.8171-0008.1 990049	Brake System: ATE
	105	Required quantity: 2;			
E 290 T Turbo-D	95 06/96→07/99	Fitting Position: Front Axle			
		Wheelbase [mm]: 3,570;	2	11.8171-0008.1 990049	Brake System: ATE
		Required quantity: 2;			
		Fitting Position: Front Axle			
E 220 T CDI	92 06/98→07/99	Construction year from: 07/98 →;	2	11.8171-0008.1 990049	Brake System: ATE
		Wheelbase [mm]: 2,833;			
		Required quantity: 2;			
		Fitting Position: Front Axle			
		Construction year from: 07/98 →;	2	11.8171-0008.1 990049	Brake System: ATE
		Wheelbase [mm]: 3,570;			
		Required quantity: 2;			
		Fitting Position: Front Axle			
E 250 T D	83 06/96→07/99	Wheelbase [mm]: 2,833;	2	11.8171-0008.1 990049	Brake System: ATE
		Required quantity: 2;			
		Fitting Position: Front Axle			
		Wheelbase [mm]: 3,570;	2	11.8171-0008.1 990049	Brake System: ATE
		Required quantity: 2;			
		Fitting Position: Front Axle			
		Left-/right-hand drive vehicles: for right-hand drive vehicles;	2	11.8171-0008.1 990049	Brake System: ATE
		Wheelbase [mm]: 2,833;			
		Required quantity: 2;			
		Fitting Position: Front Axle			
E 280 T	150 12/96→03/03	Wheelbase [mm]: 3,570;	2	11.8171-0008.1 990049	Brake System: ATE
		Required quantity: 2;			
		Fitting Position: Front Axle			
E 320 T 4-matic	165 12/96→03/03	Construction year from: 06/97 →;	2	11.8171-0008.1 990049	Brake System: ATE
		Required quantity: 2;			
		Fitting Position: Front Axle			

	kW				
MERCEDES-BENZ - E-CLASS T-Model (S211) 02/03→07/09					
Guide Sleeve Kit, brake caliper					
E 500 T	285	04/06→07/09	Fitting Position: Rear Axle	11.0101-5407.2 260011	Brake System: ATE
Guide Bolt, brake caliper					
E 240 T 4-matic	130	07/03→07/09	Required quantity: 2	2 11.8171-0008.1 990049	Brake System: ATE
E 320 T 4-matic	165	07/03→07/09			
E 500 T	285	04/06→07/09			
E 280 T 4-matic	170	03/05→07/09	Construction year from: 05/05 →;	2 11.8171-0008.1 990049	Brake System: ATE
E 280 T CDI 4-matic	140	03/05→07/09	Vehicle Equipment: for vehicles without		
E 320 T CDI 4-matic	165	03/05→07/09	sports package / for vehicles without		
			AMG sports package;		
			Required quantity: 2		
E 350 T 4-matic	200	03/05→07/09	Vehicle Equipment: for vehicles without	2 11.8171-0008.1 990049	Brake System: ATE
			sports package / for vehicles without		
			AMG sports package;		
			Required quantity: 2		
MERCEDES-BENZ - E-CLASS T-Model (S212) 08/09→12/16					
Guide Sleeve Kit, brake caliper					
E 200	135	11/12→12/16	Construction year from: 03/13 →;	11.0101-5407.2 260011	Brake System: ATE
E 250	155	11/12→12/16	Fitting Position: Rear Axle		
E 200 CDI / BlueTEC	100	11/09→12/16	Fitting Position: Rear Axle	11.0101-5407.2 260011	Brake System: ATE
E 200 CGI	135	11/09→12/16			
E 220 BlueTEC	130	05/15→12/16			
E 220 BlueTEC 4-matic	125	12/14→12/16			
E 220 CDI / BlueTEC	125	11/09→12/16			
E 250 CDI / BlueTEC	150	11/09→12/16			
E 250 CDI / BlueTEC 4-	150	07/10→12/16			
matic					
E 250 CGI	150	11/09→12/13			
E 300	170 -	11/09→12/16			
	185				
E 300 4-matic	185	07/11→12/16			
E 300 CDI / BlueTEC	170	11/09→12/16			
E 350	225	09/11→12/14			
E 350 4-matic	200 -	11/09→12/16			
	225				
E 350 BlueTEC	155 -	11/09→12/16			
	190				
E 350 BlueTEC 4-matic	190	07/14→12/16			
E 350 CDI	170 -	11/09→12/13			
	195				
E 350 CDI 4-matic	170 -	11/09→12/13			
	195				
E 350 CGI	215	11/09→12/11			
E 400	245	01/13→12/16			
E 400 4-matic	245	01/13→12/16			
E 500	285 -	11/09→12/16			
	300				
E 500 4-matic	300	09/11→12/16			
E 220 CDI	120	08/09→08/14	Construction year from: 11/09 →;	11.0101-5407.2 260011	Brake System: ATE
E 350	200	08/09→12/11	Fitting Position: Rear Axle		
E 300 Hybrid / BlueTEC	150	12/11→12/16	Construction year from: 06/12 →;	11.0101-5407.2 260011	Brake System: ATE
Hybrid			Fitting Position: Rear Axle		
E 350 BlueTEC	185	11/12→12/16	Construction year from: 01/13 →;	11.0101-5407.2 260011	Brake System: ATE
E 350 BlueTEC 4-matic	185	11/12→12/16	Fitting Position: Rear Axle		
Guide Bolt, brake caliper					
E 300	170 -	11/09→12/16	Required quantity: 2;	2 11.8171-0008.1 990049	Brake System: ATE
	185		Fitting Position: Rear Axle		
E 300 4-matic	185	07/11→12/16			
E 300 CDI / BlueTEC	170	11/09→12/16			
E 350	225	09/11→12/14			
E 350 4-matic	200 -	11/09→12/16			
	225				
E 350 BlueTEC	155 -	11/09→12/16			
	190				
E 350 BlueTEC 4-matic	190	07/14→12/16			
E 350 CDI	170 -	11/09→12/13			
	195				
E 350 CDI 4-matic	170 -	11/09→12/13			
	195				
E 350 CGI	215	11/09→12/11			
E 400	245	01/13→12/16			
E 400 4-matic	245	01/13→12/16			
E 500	285 -	11/09→12/16			
	300				
E 500 4-matic	300	09/11→12/16			
E 300 Hybrid / BlueTEC	150	12/11→12/16	Construction year from: 06/12 →;	2 11.8171-0008.1 990049	Brake System: ATE
Hybrid			Required quantity: 2;		
			Fitting Position: Rear Axle		
→					

	kW				
MERCEDES-BENZ - E-CLASS T-Model (S212) 08/09→12/16					
Guide Bolt, brake caliper					
E 350	200 08/09→12/11	Construction year from: 11/09 →; Required quantity: 2; Fitting Position: Rear Axle	2	11.8171-0008.1 990049	Brake System: ATE
E 350 BlueTEC E 350 BlueTEC 4-matic	185 11/12→12/16 185 11/12→12/16	Construction year from: 01/13 →; Required quantity: 2; Fitting Position: Rear Axle	2	11.8171-0008.1 990049	Brake System: ATE
MERCEDES-BENZ - E-CLASS T-Model (S213) 07/16→					
Warning Contact, brake pad wear					
AMG E 43 4-matic E 200 E 200 4-matic E 200 d	295 10/16→ 135 07/16→ 135 01/17→ 110 - 10/16→ 118	Required quantity: 1; Fitting Position: Front Axle	1	24.8190-0067.2 620067	
E 200 EQ Boost E 200 EQ Boost 4-matic E 220 d	145 06/19→ 145 06/19→ 120 - 07/16→ 147	Required quantity: 1; Fitting Position: Rear Axle	1	24.8190-0067.2 620067	
E 220 d 4-matic	143 - 01/17→ 147				
E 250 E 300 d E 300 d 4-matic E 300 de	155 07/16→ 180 12/17→ 195 01/21→ 143 - 10/18→ 225				
E 300 de 4-matic E 300 e	143 - 08/20→ 225 155 - 06/20→ 235				
E 300 EQ Boost E 350 d	190 06/19→ 190 - 10/16→ 210				
E 350 d 4-matic E 400 4-matic E 400 d E 400 d 4-matic	190 06/17→ 245 10/16→ 250 02/19→ 243 - 04/18→ 250				
E 450 4-matic E 450 EQ Boost	270 08/18→ 270 08/20→				
AMG E 53 EQ Boost 4-matic+	320 04/18→	Required quantity: 1; Fitting Position: Front Axle	1	24.8190-0959.2 620959	
		Required quantity: 1; Fitting Position: Rear Axle	1	24.8190-0067.2 620067	
AMG E 63 4-matic+ AMG E 63 S 4-matic+	420 05/17→ 450 05/17→	Required quantity: 1; Fitting Position: Rear Axle	1	24.8190-0067.2 620067	
MERCEDES-BENZ - EQA (H243) 02/21→					
Warning Contact, brake pad wear					
EQA 250 EQA 250+ EQA 300 4-matic EQA 350 4-matic	140 02/21→ 140 03/22→ 168 05/21→ 215 05/21→	Required quantity: 1; Fitting Position: Front Axle	1	24.8190-0067.2 620067	
MERCEDES-BENZ - EQB (X243) 09/21→					
Warning Contact, brake pad wear					
EQB 250 EQB 300 4-matic EQB 350 4-matic	140 02/22→ 168 12/21→ 215 12/21→	Required quantity: 1; Fitting Position: Front Axle	1	24.8190-0067.2 620067	
MERCEDES-BENZ - EQC (N293) 05/19→					
Warning Contact, brake pad wear					
EQC 400 4-matic	300 05/19→	Required quantity: 1; Fitting Position: Front Axle	1	24.8190-0067.2 620067	
		Required quantity: 1; Fitting Position: Rear Axle	1	24.8190-0067.2 620067	
MERCEDES-BENZ - EQE (V295) 02/22→					
Warning Contact, brake pad wear					
EQE 350+ EQE 43 AMG 4-matic	215 02/22→ 350 02/22→	Required quantity: 1; Fitting Position: Front Axle	1	24.8190-0067.2 620067	
		Required quantity: 1; Fitting Position: Rear Axle	1	24.8190-0067.2 620067	

	kW				
MERCEDES-BENZ - EQS (V297) 08/21→					
Warning Contact, brake pad wear					
EQS 350	215 12/21→		Required quantity: 1;	1	24.8190-0067.2 620067
EQS 450+	245 08/21→		Fitting Position: Front Axle		
EQS 53 AMG 4-matic+	484 12/21→		Required quantity: 1;	1	24.8190-0067.2 620067
EQS 53 AMG Dynamic Plus 4-matic+	560 12/21→		Fitting Position: Rear Axle		
EQS 580 4-matic	385 08/21→				
MERCEDES-BENZ - G-CLASS (W463) 09/89→					
Warning Contact, brake pad wear					
G 500	310 06/15→		Required quantity: 2;	2	24.8190-0067.2 620067
			Fitting Position: Front Axle		
MERCEDES-BENZ - G-CLASS (W463) 01/18→					
Warning Contact, brake pad wear					
G 350 d 4-matic	183 - 01/19→		Required quantity: 1;	1	24.8190-0067.2 620067
	210		Fitting Position: Front Axle		
G 400 d 4-matic	243 07/19→		Required quantity: 1;	1	24.8190-0067.2 620067
G 500	310 01/18→		Fitting Position: Rear Axle		
MERCEDES-BENZ - GLA (H247) 02/20→					
Warning Contact, brake pad wear					
AMG GLA 35 4-matic	225 06/20→		Required quantity: 1;	1	24.8190-0067.2 620067
AMG GLA 45 4-matic+	285 06/20→		Fitting Position: Front Axle		
AMG GLA 45 S 4-matic+	310 06/20→				
GLA 180	100 07/20→				
GLA 180 d	85 03/20→				
GLA 200	120 02/20→				
GLA 200 4-matic	120 10/20→				
GLA 200 d	110 02/20→				
GLA 200 d 4-matic	110 02/20→				
GLA 220 d	140 02/20→				
GLA 220 d 4-matic	140 02/20→				
GLA 250	165 02/20→				
GLA 250 4-matic	165 02/20→				
GLA 250 e	118 - 06/20→				
	160				
MERCEDES-BENZ - GLA-CLASS (X156) 12/13→					
Warning Contact, brake pad wear					
AMG GLA 45 4-matic	280 07/15→		Required quantity: 1;	1	24.8190-0067.2 620067
GLA 180	90 02/15→		Fitting Position: Front Axle		
GLA 180 CDI / d	80 07/14→				
GLA 200	110 - 12/13→				
	115				
GLA 200 CDI / d	100 12/13→				
GLA 200 CDI 4-matic	100 12/13→				
GLA 220 4-matic	135 01/17→				
GLA 220 CDI / d	120 12/13→				
GLA 220 CDI / d 4-matic	120 12/13→				
GLA 220 CDI	125 12/13→				
GLA 220 CDI 4-matic	125 12/13→				
GLA 220 d	130 07/15→				
GLA 220 d 4-matic	130 07/15→				
GLA 250	155 12/13→				
GLA 250 4-matic	155 12/13→				
GLA 250 Flex	155 01/15→				
GLA 45 AMG 4-matic	265 05/14→				
MERCEDES-BENZ - GLB (X247) 07/19→					
Warning Contact, brake pad wear					
AMG GLB 35 4-matic	225 08/19→		Required quantity: 1;	1	24.8190-0067.2 620067
GLB 180	100 04/20→		Fitting Position: Front Axle		
GLB 180 d	85 08/19→				
GLB 200	120 08/19→				
GLB 200 4-matic	120 10/20→				
GLB 200 d	110 08/19→				
GLB 200 d 4-matic	110 08/19→				
GLB 220 d	140 12/19→				
GLB 220 d 4-matic	140 08/19→				
GLB 250	165 12/19→				
GLB 250 4-matic	165 08/19→				
MERCEDES-BENZ - GLC (X253) 06/15→					
Guide Sleeve Kit, brake caliper					
200 d	120 04/19→		Fitting Position: Rear Axle		11.0101-5407.2 260011 Brake System: ATE
200 d 4-matic	120 04/19→				
200 EQ Boost	145 04/19→				
200 EQ Boost 4-matic	145 04/19→				
→					

	kW			
MERCEDES-BENZ - GLC (X253) 06/15→				
Guide Sleeve Kit, brake caliper				
220 d	143 04/19→	Fitting Position: Rear Axle	11.0101-5407.2 260011	Brake System: ATE
220 d 4-matic	120 - 06/15→			
	143			
250 4-matic	155 06/15→04/19			
250 CNG 4-matic	155 06/15→04/19			
250 d 4-matic	150 06/15→04/19			
250 Flexfuel 4-matic	155 06/15→04/19			
300	180 01/16→04/19			
300 4-matic	180 07/15→04/19			
300 d 4-matic	180 04/19→			
300 de 4-matic	143 - 05/20→			
	225			
300 e 4-matic	155 - 11/19→			
	235			
300 EQ Boost 4-matic	190 04/19→			
350 d 4-matic	190 10/16→04/19			
350 e 4-matic	155 - 01/16→04/19			
	235			
400 d 4-matic	243 08/19→			
AMG 43 4-matic	270 - 04/16→			
	287			
F-CELL	80 - 10/18→04/20			
	155			
Guide Bolt, brake caliper				
200 d	120 04/19→	Fitting Position: Rear Axle	11.8171-0008.1 990049	Brake System: ATE
200 d 4-matic	120 04/19→			
200 EQ Boost	145 04/19→			
200 EQ Boost 4-matic	145 04/19→			
220 d	143 04/19→			
220 d 4-matic	120 - 06/15→			
	143			
250 4-matic	155 06/15→04/19			
250 CNG 4-matic	155 06/15→04/19			
250 d 4-matic	150 06/15→04/19			
250 Flexfuel 4-matic	155 06/15→04/19			
300	180 01/16→04/19			
300 4-matic	180 07/15→04/19			
300 d 4-matic	180 04/19→			
300 de 4-matic	143 - 05/20→			
	225			
300 e 4-matic	155 - 11/19→			
	235			
300 EQ Boost 4-matic	190 04/19→			
350 d 4-matic	190 10/16→04/19			
350 e 4-matic	155 - 01/16→04/19			
	235			
400 d 4-matic	243 08/19→			
AMG 43 4-matic	270 - 04/16→			
	287			
F-CELL	80 - 10/18→04/20			
	155			
Warning Contact, brake pad wear				
200 d	120 04/19→	Required quantity: 1;	1 24.8190-0067.2 620067	
200 d 4-matic	120 04/19→	Fitting Position: Front Axle		
200 EQ Boost	145 04/19→			
200 EQ Boost 4-matic	145 04/19→	Required quantity: 1;	1 24.8190-0067.2 620067	
220 d	143 04/19→	Fitting Position: Rear Axle		
220 d 4-matic	120 - 06/15→			
	143			
250 4-matic	155 06/15→04/19			
250 CNG 4-matic	155 06/15→04/19			
250 d 4-matic	150 06/15→04/19			
250 Flexfuel 4-matic	155 06/15→04/19			
300	180 01/16→04/19			
300 4-matic	180 07/15→04/19			
300 d 4-matic	180 04/19→			
300 de 4-matic	143 - 05/20→			
	225			
300 e 4-matic	155 - 11/19→			
	235			
300 EQ Boost 4-matic	190 04/19→			
350 d 4-matic	190 10/16→04/19			
350 e 4-matic	155 - 01/16→04/19			
	235			
400 d 4-matic	243 08/19→			
AMG 43 4-matic	270 - 04/16→			
	287			
F-CELL	80 - 10/18→04/20			
	155			
AMG 63 4-matic+	350 06/17→	Required quantity: 1;	1 24.8190-0067.2 620067	
AMG 63 S 4-matic+	375 06/17→	Fitting Position: Rear Axle		

	kW			
MERCEDES-BENZ - GLC Coupe (C253) 06/16→				
Guide Sleeve Kit, brake caliper				
200 d	120 04/19→	Fitting Position: Rear Axle	11.0101-5407.2 260011	Brake System: ATE
200 d 4-matic	120 04/19→			
200 EQ Boost	145 04/19→			
200 EQ Boost 4-matic	145 04/19→			
220 d 4-matic	120 - 06/16→			
	143			
250 4-matic	155 06/16→04/19			
250 d 4-matic	150 06/16→04/19			
260 4-matic	145 11/19→			
300 4-matic	180 - 10/16→			
	190			
300 d 4-matic	180 04/19→			
300 de 4-matic	143 - 05/20→			
	225			
300 e 4-matic	155 - 11/19→			
	235			
300 EQ Boost 4-matic	190 04/19→			
350 d 4-matic	190 10/16→04/19			
350 e 4-matic	155 - 10/16→04/19			
	235			
400 d 4-matic	243 08/19→			
AMG 43 4-matic	270 - 10/16→			
	287			
Guide Bolt, brake caliper				
200 d	120 04/19→	Fitting Position: Rear Axle	11.8171-0008.1 990049	Brake System: ATE
200 d 4-matic	120 04/19→			
200 EQ Boost	145 04/19→			
200 EQ Boost 4-matic	145 04/19→			
220 d 4-matic	120 - 06/16→			
	143			
250 4-matic	155 06/16→04/19			
250 d 4-matic	150 06/16→04/19			
260 4-matic	145 11/19→			
300 4-matic	180 - 10/16→			
	190			
300 d 4-matic	180 04/19→			
300 de 4-matic	143 - 05/20→			
	225			
300 e 4-matic	155 - 11/19→			
	235			
300 EQ Boost 4-matic	190 04/19→			
350 d 4-matic	190 10/16→04/19			
350 e 4-matic	155 - 10/16→04/19			
	235			
400 d 4-matic	243 08/19→			
AMG 43 4-matic	270 - 10/16→			
	287			
Warning Contact, brake pad wear				
200 d	120 04/19→	Required quantity: 1;	1 24.8190-0067.2 620067	
200 d 4-matic	120 04/19→	Fitting Position: Front Axle		
200 EQ Boost	145 04/19→			
200 EQ Boost 4-matic	145 04/19→	Required quantity: 1;	1 24.8190-0067.2 620067	
220 d 4-matic	120 - 06/16→	Fitting Position: Rear Axle		
	143			
250 4-matic	155 06/16→04/19			
250 d 4-matic	150 06/16→04/19			
260 4-matic	145 11/19→			
300 4-matic	180 - 10/16→			
	190			
300 d 4-matic	180 04/19→			
300 de 4-matic	143 - 05/20→			
	225			
300 e 4-matic	155 - 11/19→			
	235			
300 EQ Boost 4-matic	190 04/19→			
350 d 4-matic	190 10/16→04/19			
400 d 4-matic	243 08/19→			
AMG 43 4-matic	270 - 10/16→			
	287			
350 e 4-matic	155 - 10/16→04/19	Required quantity: 1;	1 24.8190-0067.2 620067	
	235	Fitting Position: Rear Axle		
AMG 63 4-matic+	350 06/17→			
AMG 63 S 4-matic+	375 06/17→			
MERCEDES-BENZ - GL-CLASS (X164) 09/06→12/12				
Guide Sleeve Kit, brake caliper				
GL 320 CDI / 350 BlueTEC 4-matic	155 12/09→08/12	→ Construction year to: 06/12;	11.0101-5407.2 260011	Brake System: ATE
GL 350 CDI 4-matic	165 - 05/09→08/12	Fitting Position: Rear Axle		
	195			
→				

	kW				
MERCEDES-BENZ - GL-CLASS (X164) 09/06→12/12					
Guide Sleeve Kit, brake caliper					
GL 450 4-matic	250	09/06→08/12	→ Construction year to: 06/12; Fitting Position: Rear Axle	11.0101-5407.2	260011 Brake System: ATE
GL 450 CDI 4-matic	225	05/09→08/12			
GL 500 4-matic	285	09/06→12/12			
GL 320 CDI 4-matic	160	09/06→12/09	Fitting Position: Rear Axle	11.0101-5407.2	260011 Brake System: ATE
GL 420 CDI 4-matic	165	09/06→05/09			
Guide Bolt, brake caliper					
GL 320 CDI / 350	155	12/09→08/12	→ Construction year to: 06/12; Required quantity: 2; Fitting Position: Rear Axle	2	11.8171-0008.1 990049 Brake System: ATE
BlueTEC 4-matic					
GL 350 CDI 4-matic	165	05/09→08/12	Required quantity: 2; Fitting Position: Rear Axle	2	11.8171-0008.1 990049 Brake System: ATE
GL 450 4-matic	250	09/06→08/12			
GL 450 CDI 4-matic	225	05/09→08/12			
GL 500 4-matic	285	09/06→12/12			
GL 320 CDI 4-matic	160	09/06→12/09	Required quantity: 2; Fitting Position: Rear Axle	2	11.8171-0008.1 990049 Brake System: ATE
GL 420 CDI 4-matic	225	09/06→05/09			
MERCEDES-BENZ - GLE (V167) 10/18→					
Warning Contact, brake pad wear					
AMG GLE 53 EQ Boost 4-matic+	320	04/19→	Braking System: for vehicles without sports brake system; not for brake caliper colour: Red; Required quantity: 1; Fitting Position: Front Axle	1	24.8190-0067.2 620067
AMG GLE 63 EQ Boost 4-matic+	420	11/19→	Required quantity: 1; Fitting Position: Rear Axle	1	24.8190-0067.2 620067
AMG GLE 63 S EQ Boost 4-matic+	450	11/19→			
GLE 300 d 4-matic	180	10/18→05/21	Required quantity: 1; Fitting Position: Front Axle	1	24.8190-0067.2 620067
GLE 300 d EQ Boost 4-matic	200	06/21→			
GLE 350 d 4-matic	200	12/18→05/21	Required quantity: 1; Fitting Position: Rear Axle	1	24.8190-0067.2 620067
GLE 350 de 4-matic	143	11/19→			
GLE 350 e 4-matic	155	06/20→			
GLE 400 d 4-matic	243	12/18→			
GLE 450 EQ Boost 4-matic	270	10/18→			
GLE 580 EQ Boost 4-matic	360	11/19→			
MERCEDES-BENZ - GLE Coupe (C167) 11/19→					
Warning Contact, brake pad wear					
AMG GLE 53 EQ Boost 4-matic+	320	11/19→	Braking System: for vehicles without sports brake system; not for brake caliper colour: Red; Required quantity: 1; Fitting Position: Front Axle	1	24.8190-0067.2 620067
AMG GLE 63 EQ Boost 4-matic+	420	03/20→	Required quantity: 1; Fitting Position: Rear Axle	1	24.8190-0067.2 620067
AMG GLE 63 S EQ Boost 4-matic	450				
GLE 300 d EQ Boost 4-matic	200	06/21→	Braking System: for vehicles without sports brake system; Required quantity: 1; Fitting Position: Front Axle	1	24.8190-0067.2 620067
GLE 350 d 4-matic	200	11/19→05/21	Required quantity: 1; Fitting Position: Front Axle	1	24.8190-0067.2 620067
GLE 350 de 4-matic	143	03/20→			
GLE 350 e 4-matic	155	06/20→	Required quantity: 1; Fitting Position: Rear Axle	1	24.8190-0067.2 620067
GLE 400 d 4-matic	243	11/19→			
MERCEDES-BENZ - GLS (X167) 04/19→					
Warning Contact, brake pad wear					
350 d 4-matic	210	04/19→	Required quantity: 1; Fitting Position: Front Axle	1	24.8190-0067.2 620067
400 d 4-matic	243	04/19→			
580 EQ Boost 4-matic	360	11/19→	Required quantity: 1; Fitting Position: Rear Axle	1	24.8190-0067.2 620067
Maybach 480 EQ Boost 4-matic	270	11/20→			
→					

	kW				
MERCEDES-BENZ - GLS (X167) 04/19→					
Warning Contact, brake pad wear					
450 EQ Boost 4-matic	270 06/19→		Required quantity: 1; Fitting Position: Front Axle	1	24.8190-0067.2 620067
			Required quantity: 2; Fitting Position: Rear Axle	2	24.8190-0067.2 620067
AMG 63 4Matic+ EQ Boost 4-matic+	450 11/19→		Required quantity: 1; Fitting Position: Rear Axle	1	24.8190-0067.2 620067
MERCEDES-BENZ - M-CLASS (W164) 02/05→12/12					
Guide Sleeve Kit, brake caliper					
ML 280 CDI 4-matic	140 07/05→07/09		Fitting Position: Rear Axle		11.0101-5407.2 260011 Brake System: ATE
ML 320 CDI 4-matic	155 - 07/05→07/11 165				
ML 350 CDI 4-matic	157 09/09→12/10				
ML 300 4-matic	170 03/10→12/11		→ Construction year to: 05/11;		11.0101-5407.2 260011 Brake System: ATE
ML 300 CDI 4-matic	140 - 07/09→12/11 150		Fitting Position: Rear Axle		
ML 350 4-matic	200 02/05→12/11				
ML 350 CDI 4-matic	155 - 07/09→12/11 170				
ML 450 CDI 4-matic	225 09/09→12/11				
ML 500 4-matic	225 - 07/05→12/11 285				
ML 420 CDI 4-matic	225 02/06→09/09		Construction year from: 04/06 →; Fitting Position: Rear Axle		11.0101-5407.2 260011 Brake System: ATE
Guide Bolt, brake caliper					
ML 280 CDI 4-matic	140 07/05→07/09		Required quantity: 2;	2	11.8171-0008.1 990049 Brake System: ATE
ML 320 CDI 4-matic	155 - 07/05→07/11 165		Fitting Position: Rear Axle		
ML 350 CDI 4-matic	157 09/09→12/10				
ML 300 4-matic	170 03/10→12/11		→ Construction year to: 05/11;	2	11.8171-0008.1 990049 Brake System: ATE
ML 300 CDI 4-matic	140 - 07/09→12/11 150		Required quantity: 2; Fitting Position: Rear Axle		
ML 350 4-matic	200 02/05→12/11				
ML 350 CDI 4-matic	155 - 07/09→12/11 170				
ML 450 CDI 4-matic	225 09/09→12/11				
ML 500 4-matic	225 - 07/05→12/11 285				
ML 420 CDI 4-matic	225 02/06→09/09		Construction year from: 04/06 →; Required quantity: 2; Fitting Position: Rear Axle	2	11.8171-0008.1 990049 Brake System: ATE
MERCEDES-BENZ - R-CLASS (W251, V251) 08/05→10/17					
Guide Sleeve Kit, brake caliper					
R 280	170 01/07→12/14		Fitting Position: Rear Axle		11.0101-5407.2 260011 Brake System: ATE
R 280 4-matic	170 05/07→12/11				
R 280 CDI	140 05/06→12/12				
R 280 CDI 4-matic	140 05/06→12/12				
R 300	170 07/09→12/14				
R 300 4-matic	170 07/09→12/11				
R 300 CDI	140 07/09→12/12				
R 300 CDI 4-matic	140 07/09→12/12				
R 320 CDI 4-matic	155 - 01/06→12/12 165				
R 350	200 01/07→12/12				
R 350 4-matic	200 08/05→12/12				
R 350 CDI 4-matic	165 - 07/09→12/14 195				
R 350 CGI 4-matic	225 10/11→12/14				
R 500 4-matic	225 - 08/05→12/14 285				
R 350 CDI 4-matic	155 01/06→12/14		Construction year from: 05/09 →; Fitting Position: Rear Axle		11.0101-5407.2 260011 Brake System: ATE
Guide Bolt, brake caliper					
R 280	170 01/07→12/14		Required quantity: 2	2	11.8171-0008.1 990049 Brake System: ATE
R 280 4-matic	170 05/07→12/11				
R 280 CDI	140 05/06→12/12				
R 280 CDI 4-matic	140 05/06→12/12				
R 300	170 07/09→12/14				
R 300 4-matic	170 07/09→12/11				
R 300 CDI	140 07/09→12/12				
R 300 CDI 4-matic	140 07/09→12/12				
R 320 CDI 4-matic	155 - 01/06→12/12 165				
R 350	200 01/07→12/12				
R 350 4-matic	200 08/05→12/12				
R 350 CDI 4-matic	165 - 07/09→12/14 195				
→					

	kW				
MERCEDES-BENZ - R-CLASS (W251, V251) 08/05→10/17					
Guide Bolt, brake caliper					
R 350 CGI 4-matic R 500 4-matic	225 10/11→12/14 225 - 08/05→12/14 285	Required quantity: 2	2	11.8171-0008.1 990049	Brake System: ATE
R 350 CDI 4-matic	155 01/06→12/14	Construction year from: 05/09 →; Required quantity: 2	2	11.8171-0008.1 990049	Brake System: ATE
MERCEDES-BENZ - S-CLASS (V223) 09/20→					
Warning Contact, brake pad wear					
S 350 d S 350 d 4-matic S 400 d 4-matic S 450 EQ Boost S 450 EQ Boost 4-matic S 500 EQ Boost 4-matic S 580 4-matic S 580 e	210 09/20→ 210 09/20→ 243 09/20→ 270 07/21→ 270 10/20→ 320 09/20→ 370 05/21→ 270 - 07/21→ 375	Required quantity: 1; Fitting Position: Front Axle Required quantity: 1; Fitting Position: Rear Axle	1	24.8190-0959.2 620959 24.8190-0067.2 620067	
MERCEDES-BENZ - S-CLASS (W220) 09/98→08/05					
Guide Bolt, brake caliper					
S 350 4-matic	180 06/03→08/05	Required quantity: 2	2	11.8171-0008.1 990049	Brake System: ATE
MERCEDES-BENZ - S-CLASS (W221) 09/05→12/13					
Guide Sleeve Kit, brake caliper					
S 250 CDI S 350 BlueTec S 350 BlueTEC 4-matic S 350 CGI S 350 CGI 4-matic S 500 CGI S 500 CGI 4-matic S 550	150 01/11→12/13 190 04/11→12/13 190 04/11→12/13 225 04/11→12/13 225 04/11→12/13 320 04/11→12/13 320 03/11→12/13 320 09/11→12/13	→ Construction year to: 05/13; Fitting Position: Rear Axle		11.0101-5407.2 260011	Brake System: ATE
S 280 S 300 S 320 CDI 4-matic S 350 4-matic S 350 CDI	170 08/06→12/13 170 08/06→12/13 173 10/06→12/13 200 02/08→12/13 155 - 06/09→12/13 173	Vehicle Identification Number from: A 265576 →; → Construction year to: 05/13; Fitting Position: Rear Axle → Vehicle Identification Number to: A 265575; Fitting Position: Rear Axle		11.0101-5407.2 260011	Brake System: ATE
S 320 CDI S 350	155 10/05→12/13 200 10/05→12/13	Vehicle Identification Number from: A 265576 →; → Construction year to: 05/13; Fitting Position: Rear Axle		11.0101-5407.2 260011	Brake System: ATE
		Construction year from: 12/05 →; → Vehicle Identification Number to: A 265575; Fitting Position: Rear Axle		11.0101-5407.2 260011	Brake System: ATE
S 320 CDI S 320 CDI 4-matic S 350 CDI 4-matic	173 12/05→06/09 155 10/05→12/13 155 - 01/09→07/13 173	Vehicle Identification Number from: A 265576 →; Fitting Position: Rear Axle → Vehicle Identification Number to: A 265575; Fitting Position: Rear Axle		11.0101-5407.2 260011	Brake System: ATE
S 400 Hybrid S 400 Hybrid	220 09/09→12/13 205 01/09→12/13	Vehicle Identification Number from: A 265576 →; → Construction year to: 05/13; Fitting Position: Rear Axle		11.0101-5407.2 260011	Brake System: ATE
		Construction year from: 06/09 →; → Vehicle Identification Number to: A 265575; Fitting Position: Rear Axle		11.0101-5407.2 260011	Brake System: ATE
S 420 CDI S 450 CDI	235 10/06→12/09 235 01/09→12/13	Fitting Position: Rear Axle		11.0101-5407.2 260011	Brake System: ATE
S 450 S 450 4-matic S 500 4-matic S 500	250 12/05→12/13 250 12/05→12/13 285 10/05→12/13 285 10/05→12/13	Construction year from: 04/06 → → Construction year to: 05/13; Fitting Position: Rear Axle Construction year from: 12/05 → → Construction year to: 05/13; Fitting Position: Rear Axle		11.0101-5407.2 260011	Brake System: ATE
Guide Bolt, brake caliper					
S 250 CDI S 350 BlueTec S 350 BlueTEC 4-matic S 350 CGI S 350 CGI 4-matic S 500 CGI S 500 CGI 4-matic S 550	150 01/11→12/13 190 04/11→12/13 190 04/11→12/13 225 04/11→12/13 225 04/11→12/13 320 04/11→12/13 320 03/11→12/13 320 09/11→12/13	→ Construction year to: 05/13; Required quantity: 2; Fitting Position: Rear Axle	2	11.8171-0008.1 990049	Brake System: ATE
S 280 S 300 S 320 CDI 4-matic →	170 08/06→12/13 170 08/06→12/13 173 10/06→12/13	Vehicle Identification Number from: A 265576 →; → Construction year to: 05/13;	2	11.8171-0008.1 990049	Brake System: ATE

	kW				
MERCEDES-BENZ - S-CLASS (W221) 09/05→12/13					
Guide Bolt, brake caliper					
S 350 4-matic	200	02/08→12/13	Required quantity: 2;		
S 350 CDI	155 - 173	06/09→12/13	Fitting Position: Rear Axle		
			→ Vehicle Identification Number to: A 265575; Required quantity: 2; Fitting Position: Rear Axle	2	11.8171-0008.1 990049 Brake System: ATE
S 320 CDI	155	10/05→12/13	Vehicle Identification Number from: A 265576 →;	2	11.8171-0008.1 990049 Brake System: ATE
S 350	200	10/05→12/13	→ Construction year to: 05/13; Required quantity: 2; Fitting Position: Rear Axle		
			Construction year from: 12/05 →;	2	11.8171-0008.1 990049 Brake System: ATE
			→ Vehicle Identification Number to: A 265575; Required quantity: 2; Fitting Position: Rear Axle		
S 320 CDI	173	12/05→06/09	Vehicle Identification Number from: A 265576 →; Required quantity: 2;	2	11.8171-0008.1 990049 Brake System: ATE
S 320 CDI 4-matic	155	10/05→12/13	Fitting Position: Rear Axle		
S 350 CDI 4-matic	155 - 173	01/09→07/13	→ Vehicle Identification Number to: A 265575; Required quantity: 2; Fitting Position: Rear Axle	2	11.8171-0008.1 990049 Brake System: ATE
S 400 Hybrid	220	09/09→12/13	Vehicle Identification Number from: A 265576 →;	2	11.8171-0008.1 990049 Brake System: ATE
			→ Construction year to: 05/13; Required quantity: 2; Fitting Position: Rear Axle		
			Construction year from: 06/09 →;	2	11.8171-0008.1 990049 Brake System: ATE
			→ Vehicle Identification Number to: A 265575; Required quantity: 2; Fitting Position: Rear Axle		
S 420 CDI	235	10/06→12/09	Required quantity: 2;	2	11.8171-0008.1 990049 Brake System: ATE
S 450 CDI	235	01/09→12/13	Fitting Position: Rear Axle		
S 450	250	12/05→12/13	Construction year from: 04/06 → →	2	11.8171-0008.1 990049 Brake System: ATE
S 450 4-matic	250	12/05→12/13	Construction year to: 05/13; Required quantity: 2;		
S 500 4-matic	285	10/05→12/13	Fitting Position: Rear Axle		
S 500	285	10/05→12/13	Construction year from: 12/05 → →	2	11.8171-0008.1 990049 Brake System: ATE
			Construction year to: 05/13; Required quantity: 2; Fitting Position: Rear Axle		
MERCEDES-BENZ - S-CLASS (W222, V222, X222) 05/13→					
 Brake Pad Set, disc brake					
S 300 BlueTEC Hybrid / h	150 - 170	02/14→05/17	Vehicle Equipment: for vehicles with AMG Sports Package;	13.0470-4870.2 LD4870	Brake System: Brembo
S 320	200	05/14→	Fitting Position: Front Axle		Wear Warning Contact: prepared for wear indicator / excl. wear warning contact Ceramic
S 350 BlueTEC / d	190	05/13→05/17			
S 350 BlueTEC / d 4-matic	190	02/14→05/17			
S 350 BlueTEC 4-matic	185	02/14→05/17			
S 350 d	210	07/17→	Vehicle Equipment: for vehicles with AMG Sports Package / for vehicles with sports package;	13.0470-4870.2 LD4870	Brake System: Brembo
S 350 d 4-matic	183 - 210	05/17→	Fitting Position: Front Axle		Wear Warning Contact: prepared for wear indicator / excl. wear warning contact Ceramic
Warning Contact, brake pad wear					
S 300 BlueTEC Hybrid / h	150 - 170	02/14→05/17	Required quantity: 2;	2	24.8190-0959.2 620959
S 320	200	05/14→	Fitting Position: Front Axle		
S 350 BlueTEC / d	190	05/13→05/17			
S 350 BlueTEC / d 4-matic	190	02/14→05/17			
S 350 BlueTEC 4-matic	185	02/14→05/17			
S 400	245	03/14→05/17			
S 400 4-matic	245	11/14→05/17			
S 400 Hybrid / h	225	05/13→05/17			
S 500	320 - 335	05/13→			
S 500 4-matic	320 - 335	05/13→05/17			
S 500 Hybrid / e	245	07/14→05/17			
S 350 d	210	07/17→	Required quantity: 1;	1	24.8190-0959.2 620959
S 350 d 4-matic	183 - 210	05/17→	Fitting Position: Front Axle		
S 400 d	250	07/17→			
S 400 Maybach 4-matic	245	01/15→05/17			
S 450	270	02/17→			
S 450 4-matic	270	02/17→			
S 450 EQ Boost	270	07/17→			
S 450 EQ Boost 4-matic	270	07/17→			
S 450 Maybach 4-matic	270	09/17→			
→					

	kW				
MERCEDES-BENZ - S-CLASS (W222, V222, X222) 05/13→					
Warning Contact, brake pad wear					
S 500 4-matic	320 11/17→	Required quantity: 1; Fitting Position: Front Axle	1	24.8190-0959.2	620959
S 500 EQ Boost	320 07/17→				
S 500 EQ Boost 4-matic	320 09/19→				
S 500 Maybach 4-matic	335 04/15→05/17				
S 560	345 07/17→				
S 560 4-matic	345 05/17→				
S 560 e	270 - 10/18→				
	350				
S 560 Maybach	345 07/17→				
S 560 Maybach 4-matic	345 07/17→				
S 400 d 4-matic	250 05/17→	Fitting Position: Front Axle		24.8190-0959.2	620959
S 500 Maybach	335 12/14→05/17	Special Purpose Vehicle: not for armoured vehicles; Required quantity: 2; Fitting Position: Front Axle	2	24.8190-0959.2	620959
S 650 Maybach	390 - 07/17→ 463	Special Purpose Vehicle: for armoured vehicles; Required quantity: 1; Fitting Position: Front Axle	1	24.8190-0959.2	620959
MERCEDES-BENZ - S-CLASS (W223) 09/20→					
Warning Contact, brake pad wear					
S 350 d	210 09/20→	Required quantity: 1; Fitting Position: Front Axle	1	24.8190-0959.2	620959
S 350 d 4-matic	210 09/20→				
S 400 d 4-matic	243 09/20→	Required quantity: 1; Fitting Position: Rear Axle	1	24.8190-0067.2	620067
S 450 EQ Boost	270 07/21→				
S 450 EQ Boost 4-matic	270 10/20→				
S 500 EQ Boost 4-matic	320 09/20→				
S 580 4-matic	370 05/21→				
S 580 e	270 - 07/21→				
	375				
S 580 e 4-matic	375 07/21→				
MERCEDES-BENZ - S-CLASS (Z223) 04/21→					
Warning Contact, brake pad wear					
S 580 Maybach 4-matic	370 05/21→	Required quantity: 1; Fitting Position: Front Axle	1	24.8190-0959.2	620959
S 580 Maybach EQ Boost 4-matic	370 08/21→				
S 680 Maybach 4-matic	450 05/21→	Required quantity: 1; Fitting Position: Rear Axle	1	24.8190-0067.2	620067
MERCEDES-BENZ - S-CLASS Convertible (A217) 12/15→					
Warning Contact, brake pad wear					
S 500	335 12/15→10/17	Fitting Position: Front Axle Right		24.8190-0959.2	620959
S 560	345 10/17→08/20				
MERCEDES-BENZ - S-CLASS Coupe (C216) 05/06→12/13					
Guide Sleeve Kit, brake caliper					
CL 500	285 06/06→12/13	Construction year from: 07/06 →;		11.0101-5407.2	260011
		Fitting Position: Rear Axle			
		Construction year from: 02/11 →;		11.0101-5407.2	260011
		Fitting Position: Rear Axle			Brake System: ATE
CL 500	320 02/11→12/13	Fitting Position: Rear Axle		11.0101-5407.2	260011
CL 500 4-matic	320 02/11→12/13				Brake System: ATE
CL 500 4-matic	285 02/08→12/13	Construction year from: 03/08 →;		11.0101-5407.2	260011
		Fitting Position: Rear Axle			Brake System: ATE
Guide Bolt, brake caliper					
CL 500	285 06/06→12/13	Construction year from: 07/06 →;	2	11.8171-0008.1	990049
		Required quantity: 2			
		Construction year from: 02/11 →;		11.8171-0008.1	990049
		Required quantity: 2			Brake System: ATE
CL 500	320 02/11→12/13	Required quantity: 2	2	11.8171-0008.1	990049
CL 500 4-matic	320 02/11→12/13				Brake System: ATE
CL 500 4-matic	285 02/08→12/13	Construction year from: 03/08 →;	2	11.8171-0008.1	990049
		Required quantity: 2			Brake System: ATE
MERCEDES-BENZ - S-CLASS Coupe (C217) 04/14→					
Warning Contact, brake pad wear					
S 400 4-matic	270 10/15→	Required quantity: 1; Fitting Position: Front Axle Right	1	24.8190-0959.2	620959
S 500	335 11/14→10/17				
S 500 4-matic	335 04/14→10/17				
S 450 4-matic	270 10/17→	Fitting Position: Front Axle Right		24.8190-0959.2	620959
S 560	345 10/17→				
S 560 4-matic	345 10/17→				



	kW				
MERCEDES-BENZ - SL (R230) 10/01→01/12					
Guide Sleeve Kit, brake caliper					
280	170	03/08→01/12	→ Construction year to: 11/11; Fitting Position: Rear Axle	11.0101-5407.2 260011	Brake System: ATE
300	170	04/09→01/12			
350	180	03/03→01/12			
		232			
500	225	10/01→01/12			
		285			
Guide Bolt, brake caliper					
280	170	03/08→01/12	→ Construction year to: 11/11; Required quantity: 2	2 11.8171-0008.1 990049	Brake System: ATE
300	170	04/09→01/12			
350	200	03/06→01/12			
		232			
500	225	10/01→01/12			
		285			
MERCEDES-BENZ - SL (R231) 12/11→					
 Brake Pad Set, disc brake					
350	225	02/12→	Construction year from: 03/12 → → Construction year to: 11/12; Vehicle Equipment: for vehicles with AMG Sports Package; Braking System: for vehicles with rein- forced brakes; Fitting Position: Front Axle	13.0470-4870.2 LD4870	Brake System: Brembo Wear Warning Contact: prepared for wear indicator / excl. wear warning contact Ceramic
			Construction year from: 12/12 → ; Vehicle Equipment: for vehicles with AMG Sports Package; Braking System: for vehicles with rein- forced brakes; Fitting Position: Front Axle	13.0470-4870.2 LD4870	Brake System: Brembo Wear Warning Contact: prepared for wear indicator / excl. wear warning contact Ceramic
Warning Contact, brake pad wear					
350	225	02/12→	Construction year from: 03/12 → → Construction year to: 11/12; Required quantity: 1; Fitting Position: Front Axle Right	1 24.8190-0959.2 620959	
500	320	01/12→			
			Construction year from: 12/12 → ; Required quantity: 1; Fitting Position: Front Axle Right	1 24.8190-0959.2 620959	
400	245	04/14→	Required quantity: 1; Fitting Position: Front Axle Right	1 24.8190-0959.2 620959	
		270			
500	335	04/15→			
MERCEDES-BENZ - SL (R232) 03/22→					
Warning Contact, brake pad wear					
43 AMG	280	05/22→	Required quantity: 2; Fitting Position: Front Axle	2 24.8190-0959.2 620959	
55 AMG 4-matic+	350	03/22→			
63 AMG 4-matic+	430	03/22→	Required quantity: 2; Fitting Position: Rear Axle	2 24.8190-0067.2 620067	
MERCEDES-BENZ - SLK (R170) 04/96→04/04					
Guide Sleeve Kit, brake caliper					
200	100	09/96→03/00	Fitting Position: Front Axle	11.0101-5407.2 260011	Brake System: ATE
200 Kompressor	141	10/96→03/00			
230 Kompressor	142	09/96→03/00			
200 Kompressor	120	03/00→04/04	→ Construction year to: 03/04; Fitting Position: Front Axle	11.0101-5407.2 260011	Brake System: ATE
230 Kompressor	145	03/00→04/04			
320	160	03/00→04/04	Construction year from: 04/00 → → Construction year to: 03/04; Fitting Position: Front Axle	11.0101-5407.2 260011	Brake System: ATE
Guide Bolt, brake caliper					
200	100	09/96→03/00	Required quantity: 2; Fitting Position: Front Axle	2 11.8171-0008.1 990049	Brake System: ATE
200 Kompressor	141	10/96→03/00			
230 Kompressor	142	09/96→03/00			
200 Kompressor	120	03/00→04/04	→ Construction year to: 03/04; Required quantity: 2; Fitting Position: Front Axle	2 11.8171-0008.1 990049	Brake System: ATE
230 Kompressor	145	03/00→04/04			
320	160	03/00→04/04	Construction year from: 04/00 → → Construction year to: 03/04; Required quantity: 2; Fitting Position: Front Axle	2 11.8171-0008.1 990049	Brake System: ATE
MERCEDES-BENZ - SPRINTER 2-t Bus (B901, B902) 01/95→05/06					
Guide Sleeve Kit, brake caliper					
208 CDI	60	04/00→05/06	Fitting Position: Rear Axle	11.0101-5407.2 260011	Brake System: ATE
208 D	58	02/95→04/00			
210 D	75	03/97→04/00			
211 CDI	80	04/00→05/06			
→					







	kW				
MERCEDES-BENZ - SPRINTER 2-t Bus (B901, B902) 01/95→05/06					
Guide Sleeve Kit, brake caliper					
212 D	90 02/95→04/00	Fitting Position: Rear Axle		11.8101-5407.2 260011	Brake System: ATE
213 CDI	95 04/00→05/06				
214	105 02/95→05/06				
214 NGT	95 02/95→05/06				
216 CDI	115 04/00→05/06				
Guide Bolt, brake caliper					
208 CDI	60 04/00→05/06	Required quantity: 2;	2	11.8171-0008.1 990049	Brake System: ATE
208 D	58 02/95→04/00	Fitting Position: Front Axle			
210 D	75 03/97→04/00	Required quantity: 2;	2	11.8171-0008.1 990049	Brake System: ATE
211 CDI	80 04/00→05/06	Fitting Position: Rear Axle			
212 D	90 02/95→04/00				
213 CDI	95 04/00→05/06				
214	105 02/95→05/06				
214 NGT	95 02/95→05/06				
216 CDI	115 04/00→05/06				
MERCEDES-BENZ - SPRINTER 2-t Platform/Chassis (B901, B902) 01/95→05/06					
Guide Sleeve Kit, brake caliper					
208 CDI	60 04/00→05/06	Fitting Position: Rear Axle		11.8101-5407.2 260011	Brake System: ATE
208 D	60 09/96→04/00				
210 D	75 01/97→04/00				
211 CDI	80 04/00→05/06				
212 D	90 02/95→04/00				
213 CDI	95 04/00→05/06				
214	105 02/95→05/06				
214 NGT	95 02/95→05/06				
216 CDI	115 04/00→05/06				
208 D	58 01/95→04/00	Construction year from: 02/95 →;		11.8101-5407.2 260011	Brake System: ATE
		Fitting Position: Rear Axle			
Guide Bolt, brake caliper					
208 CDI	60 04/00→05/06	Required quantity: 2;	2	11.8171-0008.1 990049	Brake System: ATE
208 D	60 09/96→04/00	Fitting Position: Front Axle			
210 D	75 01/97→04/00	Required quantity: 2;	2	11.8171-0008.1 990049	Brake System: ATE
211 CDI	80 04/00→05/06	Fitting Position: Rear Axle			
212 D	90 02/95→04/00				
213 CDI	95 04/00→05/06				
214	105 02/95→05/06				
214 NGT	95 02/95→05/06				
216 CDI	115 04/00→05/06				
208 D	58 01/95→04/00	Construction year from: 02/95 →;	2	11.8171-0008.1 990049	Brake System: ATE
		Required quantity: 2;			
		Fitting Position: Front Axle			
		Construction year from: 02/95 →;	2	11.8171-0008.1 990049	Brake System: ATE
		Required quantity: 2;			
		Fitting Position: Rear Axle			
MERCEDES-BENZ - SPRINTER 2-t Van (B901, B902) 01/95→05/06					
Guide Sleeve Kit, brake caliper					
208 CDI	60 04/00→05/06	Fitting Position: Rear Axle		11.8101-5407.2 260011	Brake System: ATE
208 D	58 - 02/95→04/00				
	60				
210 D	75 01/97→04/00				
211 CDI	80 04/00→05/06				
212 D	90 02/95→04/00				
213 CDI	95 04/00→05/06				
214	105 02/95→05/06				
214 NGT	95 02/95→05/06				
216 CDI	115 04/00→05/06				
Guide Bolt, brake caliper					
208 CDI	60 04/00→05/06	Required quantity: 2;	2	11.8171-0008.1 990049	Brake System: ATE
208 D	58 - 02/95→04/00	Fitting Position: Front Axle			
	60	Required quantity: 2;	2	11.8171-0008.1 990049	Brake System: ATE
210 D	75 01/97→04/00	Fitting Position: Rear Axle			
211 CDI	80 04/00→05/06				
212 D	90 02/95→04/00				
213 CDI	95 04/00→05/06				
214	105 02/95→05/06				
214 NGT	95 02/95→05/06				
216 CDI	115 04/00→05/06				
MERCEDES-BENZ - SPRINTER 3-t Bus (B903) 01/95→05/12					
Guide Sleeve Kit, brake caliper					
308 CDI	60 04/00→05/06	Fitting Position: Rear Axle		11.8101-5407.2 260011	Brake System: ATE
308 D	58 - 02/95→04/00				
	60				
310 D	75 01/97→12/99				
→					





	kW				
MERCEDES-BENZ - SPRINTER 3-t Bus (B903) 01/95→05/12					
Guide Sleeve Kit, brake caliper					
310 D 4x4	75	05/97→08/02	Fitting Position: Rear Axle	11.0101-5407.2 260011	Brake System: ATE
311 CDI	80	04/00→05/06			
311 CDI 4x4	80	08/02→05/06			
312 D 2.9	90	02/95→04/00			
312 D 2.9 4x4	90	05/97→08/02			
313 CDI	95	04/00→05/06			
313 CDI 4x4	95	08/02→05/06			
314	105	02/95→05/06			
314 4x4	105	08/02→05/06			
314 NGT	95	02/95→05/06			
316 CDI	115	04/00→05/06			
316 CDI 4x4	115	08/02→05/06			
Guide Bolt, brake caliper					
308 CDI	60	04/00→05/06	Required quantity: 2;	2	11.8171-0008.1 990049 Brake System: ATE
308 D	58 - 60	02/95→04/00	Fitting Position: Front Axle		
310 D	75	01/97→12/99	Required quantity: 2;	2	11.8171-0008.1 990049 Brake System: ATE
310 D 4x4	75	05/97→08/02	Fitting Position: Rear Axle		
311 CDI	80	04/00→05/06			
311 CDI 4x4	80	08/02→05/06			
312 D 2.9	90	02/95→04/00			
312 D 2.9 4x4	90	05/97→08/02			
313 CDI	95	04/00→05/06			
313 CDI 4x4	95	08/02→05/06			
314	105	02/95→05/06			
314 4x4	105	08/02→05/06			
314 NGT	95	02/95→05/06			
316 CDI	115	04/00→05/06			
316 CDI 4x4	115	08/02→05/06			
MERCEDES-BENZ - SPRINTER 3-t Platform/Chassis (B903) 01/95→05/12					
Guide Sleeve Kit, brake caliper					
308 CDI	60	04/00→05/06	Fitting Position: Rear Axle	11.0101-5407.2 260011	Brake System: ATE
308 D 2.3	58 - 60	02/95→04/00			
310 D 2.9	75	01/97→04/00			
311 CDI	80	04/00→05/06			
311 CDI 4x4	80	04/00→05/06			
312 D 2.9	85 - 90	02/95→09/01			
313 CDI	95	04/00→05/06			
313 CDI 4x4	95	04/00→05/06			
314	105	02/95→05/06			
314 4x4	105	08/02→05/06			
314 NGT	95	02/95→05/06			
316 CDI	115	04/00→05/06			
316 CDI 4x4	115	08/02→05/06			
Guide Bolt, brake caliper					
308 CDI	60	04/00→05/06	Required quantity: 2;	2	11.8171-0008.1 990049 Brake System: ATE
308 D 2.3	58 - 60	02/95→04/00	Fitting Position: Front Axle		
310 D 2.9	75	01/97→04/00	Required quantity: 2;	2	11.8171-0008.1 990049 Brake System: ATE
311 CDI	80	04/00→05/06	Fitting Position: Rear Axle		
311 CDI 4x4	80	04/00→05/06			
312 D 2.9	85 - 90	02/95→09/01			
313 CDI	95	04/00→05/06			
313 CDI 4x4	95	04/00→05/06			
314	105	02/95→05/06			
314 4x4	105	08/02→05/06			
314 NGT	95	02/95→05/06			
316 CDI	115	04/00→05/06			
316 CDI 4x4	115	08/02→05/06			
MERCEDES-BENZ - SPRINTER 3-t Van (B903) 01/95→05/12					
Guide Sleeve Kit, brake caliper					
308 CDI	60	04/00→05/06	Fitting Position: Rear Axle	11.0101-5407.2 260011	Brake System: ATE
308 D 2.3	58 - 60	02/95→04/00			
310 D 2.9	75	02/95→04/00			
311 CDI	80	04/00→05/06			
311 CDI 4x4	80	08/02→05/06			
312 D 2.9	90	02/95→04/00			
312 D 2.9 4x4	90	05/97→08/02			
313 CDI	95	04/00→05/06			
313 CDI 4x4	95	08/02→05/06			
314	105	02/95→05/06			
314 4x4	105	08/02→05/06			
314 NGT	95	02/95→05/06			
→					

	kW				
MERCEDES-BENZ - SPRINTER 3-t Van (B903) 01/95→05/12					
Guide Sleeve Kit, brake caliper					
316 CDI	115 04/00→05/06	Fitting Position: Rear Axle		11.0101-5407.2 260011	Brake System: ATE
316 CDI 4x4	115 02/01→05/06				
Guide Bolt, brake caliper					
308 CDI	60 04/00→05/06	Required quantity: 2;	2	11.8171-0008.1 990049	Brake System: ATE
308 D 2.3	58 - 02/95→04/00	Fitting Position: Front Axle			
	60				
310 D 2.9	75 02/95→04/00	Required quantity: 2;	2	11.8171-0008.1 990049	Brake System: ATE
311 CDI	80 04/00→05/06	Fitting Position: Rear Axle			
311 CDI 4x4	80 08/02→05/06				
312 D 2.9	90 02/95→04/00				
312 D 2.9 4x4	90 05/97→08/02				
313 CDI	95 04/00→05/06				
313 CDI 4x4	95 08/02→05/06				
314	105 02/95→05/06				
314 4x4	105 08/02→05/06				
314 NGT	95 02/95→05/06				
316 CDI	115 04/00→05/06				
316 CDI 4x4	115 02/01→05/06				
MERCEDES-BENZ - SPRINTER 4-t Bus (B904) 02/96→05/06					
Guide Bolt, brake caliper					
408 CDI	60 04/00→05/06	Required quantity: 2;	2	11.8171-0008.1 990049	Brake System: ATE
411 CDI	80 04/00→05/06	Fitting Position: Front Axle			
413 CDI	95 04/00→05/06				
414	105 02/96→05/06				
416 CDI	115 04/00→05/06				
MERCEDES-BENZ - SPRINTER 4-t Platform/Chassis (B904) 02/95→05/12					
Guide Bolt, brake caliper					
408 CDI	60 04/00→05/06	Required quantity: 2;	2	11.8171-0008.1 990049	Brake System: ATE
408 D	58 02/96→05/06	Fitting Position: Front Axle			
410 D 4x4	75 05/97→05/06				
411 CDI	80 04/00→05/06				
411 CDI 4x4	80 04/00→05/06				
412 D	85 - 02/96→05/06				
	90				
412 D 4x4	85 - 05/97→05/06				
	90				
413 CDI	95 04/00→05/06				
413 CDI 4x4	95 04/00→05/06				
414	105 02/95→05/06				
414 4x4	105 05/97→05/06				
416 CDI	115 04/00→05/06				
416 CDI 4x4	115 04/00→05/06				
410 D	75 02/96→05/06	Construction year from: 09/96 →; Required quantity: 2; Fitting Position: Front Axle	2	11.8171-0008.1 990049	Brake System: ATE
MERCEDES-BENZ - SPRINTER 4-t Van (B904) 02/95→05/12					
Guide Bolt, brake caliper					
408 CDI	60 04/00→05/06	Required quantity: 2;	2	11.8171-0008.1 990049	Brake System: ATE
408 D	58 02/96→05/06	Fitting Position: Front Axle			
410 D 4x4	75 05/97→05/06				
411 CDI	80 04/00→05/06				
411 CDI 4x4	80 04/00→05/06				
412 D	85 - 02/96→05/06				
	90				
412 D 4x4	85 - 05/97→05/06				
	90				
413 CDI	95 04/00→05/06				
413 CDI 4x4	95 04/00→05/06				
414	105 02/96→05/06				
414 4x4	105 05/97→05/06				
414 D 4x4	90 05/97→05/06				
414 NGT	95 02/95→05/06				
416 CDI	115 04/00→05/06				
416 CDI 4x4	115 04/00→05/06				
410 D	75 02/96→05/06	Construction year from: 09/96 →; Required quantity: 2; Fitting Position: Front Axle	2	11.8171-0008.1 990049	Brake System: ATE
MERCEDES-BENZ - SPRINTER CLASSIC 3,5-t Van (B909) 09/13→					
Guide Sleeve Kit, brake caliper					
311 CDI	80 09/13→	Fitting Position: Rear Axle		11.0101-5407.2 260011	Brake System: ATE
313 CDI	100 01/17→				
→					



	kW				
MERCEDES-BENZ - SPRINTER CLASSIC 3,5-t Van (B909) 09/13→					
Guide Bolt, brake caliper					
311 CDI	80 09/13→		Required quantity: 2;	2	11.8171-0008.1 990049 Brake System: ATE
313 CDI	100 01/17→		Fitting Position: Front Axle		
			Required quantity: 2;	2	11.8171-0008.1 990049 Brake System: ATE
			Fitting Position: Rear Axle		
MERCEDES-BENZ - SPRINTER CLASSIC 4,6-t Bus (B909) 09/13→					
Guide Bolt, brake caliper					
411 CDI	80 09/13→		Required quantity: 2;	2	11.8171-0008.1 990049 Brake System: ATE
			Fitting Position: Front Axle		
MERCEDES-BENZ - SPRINTER CLASSIC 4,6-t Van (B909) 01/17→					
Guide Bolt, brake caliper					
413 CDI	100 01/17→		Required quantity: 2;	2	11.8171-0008.1 990049 Brake System: ATE
			Fitting Position: Front Axle		
MERCEDES-BENZ - V-CLASS (638/2) 02/96→07/03					
Guide Bolt, brake caliper					
V 200	95 02/97→07/03		Required quantity: 2;	2	11.8171-0008.1 990049 Brake System: ATE
V 200 CDI	75 03/99→07/03		Fitting Position: Front Axle		
V 220 CDI	90 03/99→07/03				
V 230	105 10/96→07/03				
V 230 TD	72 09/96→07/03				
V 280	128 08/97→07/03		Construction year from: 09/97 →;	2	11.8171-0008.1 990049 Brake System: ATE
			Required quantity: 2;		
			Fitting Position: Front Axle		
MERCEDES-BENZ - VITO Bus (W638) 02/96→07/03					
Guide Bolt, brake caliper					
108 CDI 2.2	60 03/99→07/03		Required quantity: 2	2	11.8171-0008.1 990049 Brake System: ATE
110 CDI 2.2	75 03/99→07/03				
112 CDI 2.2	90 03/99→07/03				
114 2.3	105 12/96→07/03				
108 D 2.3	58 02/96→07/03		Construction year from: 03/96 →;	2	11.8171-0008.1 990049 Brake System: ATE
110 TD 2.3	72 02/96→07/03		Required quantity: 2		
113 2.0	95 02/96→07/03				
MERCEDES-BENZ - VITO Van (W638) 03/97→07/03					
Guide Bolt, brake caliper					
108 CDI 2.2	60 03/99→07/03		Required quantity: 2	2	11.8171-0008.1 990049 Brake System: ATE
108 D 2.3	58 03/97→07/03				
110 CDI 2.2	75 03/99→07/03				
110 D 2.3	72 03/97→07/03				
112 CDI 2.2	90 03/99→07/03				
113 2.0	95 03/97→07/03				
114 2.3	105 03/97→07/03				
MINI - MINI (R50, R53) 06/01→09/06					
Guide Sleeve Kit, brake caliper					
Cooper	85 06/01→09/06		→ Construction year to: 03/03;		11.0101-5407.2 260011 Brake System: ATE
One	66 06/01→09/06		Fitting Position: Rear Axle		
			Construction year from: 04/03 →;		11.0101-5407.2 260011 Brake System: ATE
			Fitting Position: Rear Axle		
Cooper S	120 03/02→09/06		Construction year from: 07/02 → →		11.0101-5407.2 260011 Brake System: ATE
			Construction year to: 03/03;		
			Fitting Position: Rear Axle		
			Construction year from: 04/03 →;		11.0101-5407.2 260011 Brake System: ATE
			Fitting Position: Rear Axle		
Cooper S	125 07/04→09/06		Fitting Position: Rear Axle		11.0101-5407.2 260011 Brake System: ATE
John Cooper Works	160 03/06→09/06				
One	55 04/03→09/06				
One D	55 - 06/03→09/06				
	65				
S Works	149 11/03→06/05				
Works	155 11/03→09/06				
Guide Bolt, brake caliper					
Cooper	85 06/01→09/06		→ Construction year to: 03/03;	2	11.8171-0008.1 990049 Brake System: ATE
One	66 06/01→09/06		Required quantity: 2		
			Construction year from: 04/03 →;	2	11.8171-0008.1 990049 Brake System: ATE
			Required quantity: 2		
			Required quantity: 2	2	11.8171-0008.1 990049 Brake System: ATE
Cooper S	120 03/02→09/06		Construction year from: 07/02 → →	2	11.8171-0008.1 990049 Brake System: ATE
			Construction year to: 03/03;		
			Required quantity: 2		
→					









	kW				
MINI - MINI (R50, R53) 06/01→09/06					
Guide Bolt, brake caliper					
Cooper S	120	03/02→09/06	Construction year from: 04/03 →; Required quantity: 2	2	11.8171-0008.1 990049 Brake System: ATE
			Construction year from: 07/02 →; Required quantity: 2	2	11.8171-0008.1 990049 Brake System: ATE
Cooper S	125	07/04→09/06	Required quantity: 2	2	11.8171-0008.1 990049 Brake System: ATE
John Cooper Works One	160	03/06→09/06			
One	55	04/03→09/06			
One D	55	06/03→09/06			
	65				
S Works	149	11/03→06/05			
Works	155	11/03→09/06			
MINI - MINI CLUBMAN (F54) 11/14→					
Warning Contact, brake pad wear					
Cooper S	131	11/20→	Required quantity: 1;	1	24.8190-0828.2 620828 Length 2 [mm]: 237
Cooper S ALL4	131	11/20→	Fitting Position: Front Axle Left		
 Brake Hose					
Cooper	100	12/14→	Construction year from: 07/15 →; Required quantity: 2;	2	24.5134-0420.3 331648 Length [mm]: 465
Cooper D	100	12/14→	Fitting Position: Front Axle		
	110				
Cooper S	120	11/14→			
	141				
Cooper S JCW	155	11/14→06/18			
Cooper S	131	11/20→	Required quantity: 2;	2	24.5134-0420.3 331648 Length [mm]: 465
Cooper S ALL4	131	11/20→	Fitting Position: Front Axle		
John Cooper Works	170	11/16→			
	225				
Cooper S ALL4	120	04/15→	Construction year from: 01/16 →; Required quantity: 2;	2	24.5134-0420.3 331648 Length [mm]: 465
	141		Fitting Position: Front Axle		
Cooper SD ALL4	120	04/15→			
	140				
Cooper S JCW ALL4	155	11/14→			
Cooper SD	120	02/15→	Construction year from: 11/15 →; Required quantity: 2;	2	24.5134-0420.3 331648 Length [mm]: 465
	140		Fitting Position: Front Axle		
One	75	02/15→			
One D	85	02/15→			
MINI - MINI Convertible (R52) 04/04→07/08					
Guide Sleeve Kit, brake caliper					
Cooper	85	04/04→07/08	Fitting Position: Front Axle		11.0101-5407.2 260011 Brake System: ATE
Cooper S	120	07/04→11/07	Fitting Position: Rear Axle		11.0101-5407.2 260011 Brake System: ATE
	125				
One	66	07/04→11/07			
John Cooper Works	155	07/04→11/07	Fitting Position: Rear Axle		11.0101-5407.2 260011 Brake System: ATE
Guide Bolt, brake caliper					
Cooper	85	04/04→07/08	Required quantity: 2	2	11.8171-0008.1 990049 Brake System: ATE
Cooper S	120	07/04→11/07			
	125				
John Cooper Works	155	07/04→11/07			
One	66	07/04→11/07			
MINI - MINI COUNTRYMAN (F60) 10/16→					
Warning Contact, brake pad wear					
Cooper S	131	07/20→	Required quantity: 1;	1	24.8190-0828.2 620828 Length 2 [mm]: 237
Cooper S ALL4	131	07/20→	Fitting Position: Front Axle Left		
 Brake Hose					
Cooper	100	10/16→	Required quantity: 2;	2	24.5134-0420.3 331648 Length [mm]: 465
Cooper ALL4	100	10/16→	Fitting Position: Front Axle		
Cooper D	100	10/16→			
	110				
Cooper D ALL4	100	10/16→			
	110				
Cooper S	120	10/16→			
	141				
Cooper S ALL4	120	10/16→			
	141				
Cooper SD	120	10/16→			
	140				
Cooper SD ALL4	120	10/16→			
	140				
Cooper SE ALL4	92	01/17→			
	165				
John Cooper Works ALL4	170	03/17→			
	225				
One	75	07/17→			
One D	85	07/17→			





	kW				
MITSUBISHI - ASX (GA_W_) 11/09→					
 Brake Caliper					
1.6 DI-D	84 07/15→		Fitting Position: Front Axle Left	24.3571-1815.5 241485	Supplementary Article/Supplementary Info: without holder Brake Caliper Type: Fist-type Caliper
1.6 DI-D 4WD	84 07/15→				
1.6 LPG	86 06/10→				
1.6 MIVEC	86 06/10→				
1.8	102 02/10→		Fitting Position: Front Axle Right	24.3571-1816.5 241486	Supplementary Article/Supplementary Info: without holder Brake Caliper Type: Fist-type Caliper
1.8 DI-D	85 - 06/10→ 110				
1.8 DI-D 4WD	85 - 06/10→ 110				
2.0 MIVEC	110 06/10→				
2.0 MIVEC 4WD	110 06/10→				
2.2 Di-D 4WD	110 04/13→				
1.6 MIVEC	85 05/10→		Construction year from: 06/10 →; Fitting Position: Front Axle Left	24.3571-1815.5 241485	Supplementary Article/Supplementary Info: without holder Brake Caliper Type: Fist-type Caliper
			Construction year from: 06/10 →; Fitting Position: Front Axle Right	24.3571-1816.5 241486	Supplementary Article/Supplementary Info: without holder Brake Caliper Type: Fist-type Caliper
 Brake Pad Set, disc brake					
1.6 DI-D	84 07/15→		Fitting Position: Rear Axle	13.0470-5654.2 LD5654	Brake System: Mando Wear Warning Contact: with acoustic wear warning Ceramic
1.6 DI-D 4WD	84 07/15→				
2.2 Di-D 4WD	110 04/13→				
1.6 LPG	86 06/10→		Construction year from: 07/12 →; Fitting Position: Rear Axle	13.0470-5654.2 LD5654	Brake System: Mando Wear Warning Contact: with acoustic wear warning Ceramic
1.6 MIVEC	85 - 05/10→ 86				
1.8	102 02/10→				
1.8 DI-D	85 - 06/10→ 110				
1.8 DI-D 4WD	85 - 06/10→ 110				
2.0 MIVEC	110 06/10→				
2.0 MIVEC 4WD	110 06/10→				
MITSUBISHI - ASX Van (GA_W_) 06/10→					
 Brake Caliper					
1.8 DI-D 4WD	110 06/10→		Fitting Position: Front Axle Left	24.3571-1815.5 241485	Supplementary Article/Supplementary Info: without holder Brake Caliper Type: Fist-type Caliper
			Fitting Position: Front Axle Right	24.3571-1816.5 241486	Supplementary Article/Supplementary Info: without holder Brake Caliper Type: Fist-type Caliper
 Brake Pad Set, disc brake					
1.8 DI-D 4WD	110 06/10→		Construction year from: 07/12 →; Fitting Position: Rear Axle	13.0470-5654.2 LD5654	Brake System: Mando Wear Warning Contact: with acoustic wear warning Ceramic
MITSUBISHI - ECLIPSE CROSS (GK_) 10/17→					
 Brake Pad Set, disc brake					
1.5	110 10/17→		Vehicle Equipment: for vehicles with electric parking brake; Fitting Position: Rear Axle	13.0460-5540.2 605540	Brake System: Advics Wear Warning Contact: with acoustic wear warning
1.5 4WD	110 10/17→				
1.5 T-Mivec	120 10/17→				
1.5 T-Mivec 4WD	112 - 10/17→ 120			13.0470-5540.2 LD5540	Brake System: Advics Wear Warning Contact: with acoustic wear warning Ceramic
2.0	110 05/18→				
2.2 DiD 4WD	109 03/19→				
Plug-in Hybrid 4WD	72 01/21→		Fitting Position: Rear Axle	13.0460-5540.2 605540	Brake System: Advics Wear Warning Contact: with acoustic wear warning
				13.0470-5540.2 LD5540	Brake System: Advics Wear Warning Contact: with acoustic wear warning Ceramic
MITSUBISHI - LANCER VII (CS_A, CT_A) 03/00→12/13					
 Brake Caliper					
2.0	92 08/05→12/13		Fitting Position: Front Axle Left	24.3571-1815.5 241485	Supplementary Article/Supplementary Info: without holder Brake Caliper Type: Fist-type Caliper
2.0 GDi	92 09/03→12/13				
2.0 i	113 10/07→12/13				
→					

	kW				
MITSUBISHI - LANCER VII (CS_A, CT_A) 03/00→12/13					
 Brake Caliper					
2.0	92	08/05→12/13	Fitting Position: Front Axle Right	24.3571-1816.5 241486	Supplementary Article/Supplementary Info: without holder Brake Caliper Type: Fist-type Caliper
2.0 GDi	92	09/03→12/13			
2.0 i	113	10/07→12/13			
MITSUBISHI - LANCER VIII (CY_A, CZ_A) 03/07→					
 Brake Caliper					
1.5	80	06/08→	Fitting Position: Front Axle Left	24.3571-1815.5 241485	Supplementary Article/Supplementary Info: without holder Brake Caliper Type: Fist-type Caliper
1.5 Bifuel	80	02/10→			
1.6 MIVEC	86	05/10→			
1.8	103	02/08→			
	105				
1.8 Bifuel	105	01/10→	Fitting Position: Front Axle Right	24.3571-1816.5 241486	Supplementary Article/Supplementary Info: without holder Brake Caliper Type: Fist-type Caliper
1.8 DI-D	85	05/10→			
	110				
1.8 Flexfuel	103	03/09→			
	105				
1.8 Mivec	110	11/09→			
1.8 MIVEC	102	03/09→			
2.0	108	01/09→			
	110				
2.0 DI-D	103	01/08→			
2.0 i	113	04/07→			
2.0 i 4WD	113	03/07→			
2.0 i Ralliart 4WD	177	10/08→			
MITSUBISHI - LANCER VIII Sportback (CX_A) 10/07→					
 Brake Caliper					
1.5	80	06/08→	Fitting Position: Front Axle Left	24.3571-1815.5 241485	Supplementary Article/Supplementary Info: without holder Brake Caliper Type: Fist-type Caliper
1.5 Bifuel	80	03/10→			
1.6 MIVEC	86	05/10→			
1.8	105	06/08→			
1.8 Bifuel	105	02/10→	Fitting Position: Front Axle Right	24.3571-1816.5 241486	Supplementary Article/Supplementary Info: without holder Brake Caliper Type: Fist-type Caliper
1.8 DI-D	85	05/10→			
	110				
1.8 Flex	103	03/09→			
1.8 MIVEC	103	03/09→			
2.0 DI-D	103	06/08→			
MITSUBISHI - OUTLANDER III (GG_W, GF_W, ZJ, ZL, ZK) 11/10→					
 Brake Caliper					
2.4	124	08/12→	Construction year from: 10/12 →; Fitting Position: Front Axle Left	24.3571-1815.5 241485	Supplementary Article/Supplementary Info: without holder Brake Caliper Type: Fist-type Caliper
			Construction year from: 10/12 →; Fitting Position: Front Axle Right	24.3571-1816.5 241486	Supplementary Article/Supplementary Info: without holder Brake Caliper Type: Fist-type Caliper
2.4 4WD	123	10/12→	Fitting Position: Front Axle Left	24.3571-1815.5 241485	Supplementary Article/Supplementary Info: without holder Brake Caliper Type: Fist-type Caliper
3.0 4WD	165	03/14→			
	169				
3.0 GT 4WD	167	08/12→	Fitting Position: Front Axle Right	24.3571-1816.5 241486	Supplementary Article/Supplementary Info: without holder Brake Caliper Type: Fist-type Caliper
 Brake Pad Set, disc brake					
2.0	105	10/12→	Fitting Position: Rear Axle	13.0470-5654.2 LD5654	Brake System: Mando Wear Warning Contact: with acoustic wear warning Ceramic
	107				
2.0 4WD	107	10/12→			
2.2 Di-D	110	08/12→			
2.4	124	08/12→			
2.4 4WD	123	10/12→			
	124				
3.0 4WD	165	03/14→			
2.0	110	08/12→	Construction year from: 04/18 →; Fitting Position: Rear Axle	13.0460-5540.2 605540	Brake System: Advics Wear Warning Contact: with acoustic wear warning
	112				
2.0 4WD	110	08/12→			
2.0 Bifuel	107	10/12→			
2.0 Bifuel 4WD	107	10/12→			
2.0 Hybrid 4WD	87	12/12→			
	139				
			→ Construction year to: 03/18; Fitting Position: Rear Axle	13.0470-5654.2 LD5654	Brake System: Mando Wear Warning Contact: with acoustic wear warning Ceramic
→					





	kW				
MITSUBISHI - OUTLANDER III (GG_W, GF_W, ZJ, ZL, ZK) 11/10→					
 Brake Pad Set, disc brake					
2.2 DiD 4WD 2.2 Di-D 4WD	132 05/15→ 110 - 08/12→ 121	Construction year from: 10/17 →; Fitting Position: Rear Axle		13.0460-5540.2 605540 13.0470-5540.2 LD5540	Brake System: Advics Wear Warning Contact: with acoustic wear warning Brake System: Advics Wear Warning Contact: with acoustic wear warning Ceramic
		→ Construction year to: 09/17; Fitting Position: Rear Axle		13.0470-5654.2 LD5654	Brake System: Mando Wear Warning Contact: with acoustic wear warning Ceramic
2.4 Hybrid 4WD	99 09/18→	Fitting Position: Rear Axle		13.0460-5540.2 605540 13.0470-5540.2 LD5540	Brake System: Advics Wear Warning Contact: with acoustic wear warning Brake System: Advics Wear Warning Contact: with acoustic wear warning Ceramic
3.0 4WD	169 03/14→	Construction year from: 04/14 →; Fitting Position: Rear Axle		13.0470-5654.2 LD5654	Brake System: Mando Wear Warning Contact: with acoustic wear warning Ceramic
3.0 GT 4WD	167 08/12→	→ Construction year to: 09/16; Fitting Position: Rear Axle		13.0470-5654.2 LD5654	Brake System: Mando Wear Warning Contact: with acoustic wear warning Ceramic
MITSUBISHI - OUTLANDER III Van (GF_W, GG_W) 11/10→					
 Brake Pad Set, disc brake					
Di-D 4WD	110 04/13→	Construction year from: 10/17 →; Fitting Position: Rear Axle		13.0460-5540.2 605540 13.0470-5540.2 LD5540	Brake System: Advics Wear Warning Contact: with acoustic wear warning Brake System: Advics Wear Warning Contact: with acoustic wear warning Ceramic
		→ Construction year to: 09/17; Fitting Position: Rear Axle		13.0470-5654.2 LD5654	Brake System: Mando Wear Warning Contact: with acoustic wear warning Ceramic
Hybrid 4WD	99 09/18→	Fitting Position: Rear Axle		13.0460-5540.2 605540 13.0470-5540.2 LD5540	Brake System: Advics Wear Warning Contact: with acoustic wear warning Brake System: Advics Wear Warning Contact: with acoustic wear warning Ceramic
NISSAN - INTERSTAR Platform/Chassis (X62B) 11/21→					
 Brake Caliper					
dCi 130 RWD dCi 145 dCi 145 RWD dCi 165 dCi 165 RWD	96 11/21→ 107 11/21→ 107 11/21→ 120 11/21→ 120 11/21→	Fitting Position: Front Axle Left		24.3481-1821.5 241355	Brake System: Brembo Supplementary Article/Supple- mentary Info: without holder Brake Caliper Type: Fist-type Caliper (2 pistons)
		Fitting Position: Front Axle Right		24.3481-1822.5 241356	Brake System: Brembo Supplementary Article/Supple- mentary Info: without holder Brake Caliper Type: Fist-type Caliper (2 pistons)
		Fitting Position: Rear Axle Left		24.3484-1703.5 241303	Brake System: Bosch Supplementary Article/Supple- mentary Info: without holder Brake Caliper Type: Fist-type Caliper
		Fitting Position: Rear Axle Right		24.3484-1704.5 241304	Brake System: Bosch Supplementary Article/Supple- mentary Info: without holder Brake Caliper Type: Fist-type Caliper
 Brake Disc					
dCi 130 RWD dCi 145 RWD dCi 165 RWD	96 11/21→ 107 11/21→ 120 11/21→	Fitting Position: Front Axle		24.0128-0252.1 428252	Outer diameter [mm]: 302 Brake Disc Thickness [mm] 28 Minimum thickness [mm] 24.5 Brake Disc Type: Vented Supplementary Article/Info 2: with bolts/screws
→					





	kW				
NISSAN - INTERSTAR Platform/Chassis (X62B) 11/21→					
 Brake Disc					
dCi 130 RWD dCi 145 RWD dCi 165 RWD	96 11/21→ 107 11/21→ 120 11/21→	Tyres: for single tyres; Fitting Position: Rear Axle	24.0112-0190.1 412190	Outer diameter [mm]: 305 Brake Disc Thickness [mm] 12 Minimum thickness [mm] 10 Brake Disc Type: Solid Supplementary Article/Info 2: with bolts/screws	
		Tyres: for dual tyres; Fitting Position: Rear Axle	24.0118-0153.1 418153	Outer diameter [mm]: 302 Brake Disc Thickness [mm] 18 Minimum thickness [mm] 15 Brake Disc Type: Solid	
dCi 145 dCi 165	107 11/21→ 120 11/21→	Fitting Position: Front Axle	24.0128-0252.1 428252	Outer diameter [mm]: 302 Brake Disc Thickness [mm] 28 Minimum thickness [mm] 24.5 Brake Disc Type: Vented Supplementary Article/Info 2: with bolts/screws	
		Fitting Position: Rear Axle	24.0112-0191.1 412191	Outer diameter [mm]: 305 Brake Disc Thickness [mm] 12 Minimum thickness [mm] 10 Brake Disc Type: Solid Supplementary Article/Info 2: with bolts/screws	
NISSAN - INTERSTAR Van (X62B) 11/21→					
 Brake Caliper					
dCi 110 dCi 130 RWD dCi 135 dCi 145 RWD dCi 150 dCi 165 RWD dCi 180	81 11/21→ 96 11/21→ 100 11/21→ 107 11/21→ 110 11/21→ 120 11/21→ 132 11/21→	Fitting Position: Front Axle Left	24.3481-1821.5 241355	Brake System: Brembo Supplementary Article/Supplementary Info: without holder Brake Caliper Type: Fist-type Caliper (2 pistons)	
		Fitting Position: Front Axle Right	24.3481-1822.5 241356	Brake System: Brembo Supplementary Article/Supplementary Info: without holder Brake Caliper Type: Fist-type Caliper (2 pistons)	
		Fitting Position: Rear Axle Left	24.3484-1703.5 241303	Brake System: Bosch Supplementary Article/Supplementary Info: without holder Brake Caliper Type: Fist-type Caliper	
		Fitting Position: Rear Axle Right	24.3484-1704.5 241304	Brake System: Bosch Supplementary Article/Supplementary Info: without holder Brake Caliper Type: Fist-type Caliper	
 Brake Disc					
dCi 110 dCi 135 dCi 150 dCi 180	81 11/21→ 100 11/21→ 110 11/21→ 132 11/21→	Fitting Position: Front Axle	24.0128-0252.1 428252	Outer diameter [mm]: 302 Brake Disc Thickness [mm] 28 Minimum thickness [mm] 24.5 Brake Disc Type: Vented Supplementary Article/Info 2: with bolts/screws	
		Fitting Position: Rear Axle	24.0112-0191.1 412191	Outer diameter [mm]: 305 Brake Disc Thickness [mm] 12 Minimum thickness [mm] 10 Brake Disc Type: Solid Supplementary Article/Info 2: with bolts/screws	
dCi 130 RWD dCi 145 RWD dCi 165 RWD	96 11/21→ 107 11/21→ 120 11/21→	Fitting Position: Front Axle	24.0128-0252.1 428252	Outer diameter [mm]: 302 Brake Disc Thickness [mm] 28 Minimum thickness [mm] 24.5 Brake Disc Type: Vented Supplementary Article/Info 2: with bolts/screws	
		Tyres: for single tyres; Fitting Position: Rear Axle	24.0112-0190.1 412190	Outer diameter [mm]: 305 Brake Disc Thickness [mm] 12 Minimum thickness [mm] 10 Brake Disc Type: Solid Supplementary Article/Info 2: with bolts/screws	
		Tyres: for dual tyres; Fitting Position: Rear Axle	24.0118-0153.1 418153	Outer diameter [mm]: 302 Brake Disc Thickness [mm] 18 Minimum thickness [mm] 15 Brake Disc Type: Solid	





	kW				
NISSAN - NV300 Platform/Chassis (X82) 09/16→					
 Brake Disc					
1.6 dci 125 1.6 dci 145 2.0 dCi 145 2.0 dCi 170	92 09/16→ 107 09/16→ 107 07/19→ 125 07/19→	Fitting Position: Front Axle	24.0128-0287.1 428287	Outer diameter [mm]: 296 Brake Disc Thickness [mm] 28 Minimum thickness [mm] 23.4 Brake Disc Type: Vented Supplementary Article/Info 2: with bolts/screws	
 Brake Hose					
1.6 dci 125 1.6 dci 145	92 09/16→ 107 09/16→	Required quantity: 2; Fitting Position: Rear Axle	2 24.5229-0200.3 330572	Length [mm]: 200	
NISSAN - NV300 Van (X82) 09/16→					
 Brake Caliper					
1.6 dci 120 1.6 dci 125 1.6 dci 145 1.6 dci 95 2.0 dCi 110 2.0 dCi 120 2.0 dCi 145 2.0 dCi 150 2.0 dCi 170	89 09/16→ 92 09/16→ 107 09/16→ 70 09/16→ 81 05/21→ 88 07/19→ 107 07/19→ 110 05/21→ 125 07/19→	Fitting Position: Rear Axle Left	24.3414-1707.5 240337	Brake System: Lucas / TRW Supplementary Article/Supplementary Info: without holder Brake Caliper Type: Fist-type Caliper	
		Fitting Position: Rear Axle Right	24.3414-1708.5 240338	Brake System: Lucas / TRW Supplementary Article/Supplementary Info: without holder Brake Caliper Type: Fist-type Caliper	
 Brake Pad Set, disc brake					
1.6 dci 120 1.6 dci 125 1.6 dci 145 1.6 dci 95 2.0 dCi 110 2.0 dCi 120 2.0 dCi 145 2.0 dCi 150 2.0 dCi 170	89 09/16→ 92 09/16→ 107 09/16→ 70 09/16→ 81 05/21→ 88 07/19→ 107 07/19→ 110 05/21→ 125 07/19→	Fitting Position: Rear Axle	13.0460-2840.2 602840	Brake System: Lucas / TRW 23980 16,5 Wear Warning Contact: prepared for wear indicator / excl. wear warning contact	
 Brake Disc					
1.6 dci 120 1.6 dci 125 1.6 dci 145 1.6 dci 95 2.0 dCi 110 2.0 dCi 120 2.0 dCi 145 2.0 dCi 150 2.0 dCi 170	89 09/16→ 92 09/16→ 107 09/16→ 70 09/16→ 81 05/21→ 88 07/19→ 107 07/19→ 110 05/21→ 125 07/19→	Fitting Position: Front Axle	24.0128-0287.1 428287	Outer diameter [mm]: 296 Brake Disc Thickness [mm] 28 Minimum thickness [mm] 23.4 Brake Disc Type: Vented Supplementary Article/Info 2: with bolts/screws	
 Brake Hose					
1.6 dci 120 1.6 dci 125 1.6 dci 145 1.6 dci 95 2.0 dCi 110 2.0 dCi 150	89 09/16→ 92 09/16→ 107 09/16→ 70 09/16→ 81 05/21→ 110 05/21→	Required quantity: 2; Fitting Position: Rear Axle	2 24.5229-0200.3 330572	Length [mm]: 200	
NISSAN - NV350 Van (E26) 05/12→					
 Brake Disc					
2.5 dCi	95 06/12→	Fitting Position: Front Axle	24.0128-0252.1 428252	Outer diameter [mm]: 302 Brake Disc Thickness [mm] 28 Minimum thickness [mm] 24.5 Brake Disc Type: Vented Supplementary Article/Info 2: with bolts/screws	
NISSAN - NV400 Bus (X62, X62B) 11/11→					
 Brake Caliper					
dCi 100 dCi 110 dCi 125 dCi 135 dCi 145 dCi 150 dCi 160 dCi 170 dCi 180	74 11/11→09/16 81 06/14→ 92 11/11→09/16 100 06/14→09/16 107 11/11→ 110 02/14→ 120 06/14→09/16 125 07/15→ 132 01/20→	Fitting Position: Front Axle Left	24.3481-1821.5 241355	Brake System: Brembo Supplementary Article/Supplementary Info: without holder Brake Caliper Type: Fist-type Caliper (2 pistons)	
		Fitting Position: Front Axle Right	24.3481-1822.5 241356	Brake System: Brembo Supplementary Article/Supplementary Info: without holder Brake Caliper Type: Fist-type Caliper (2 pistons)	
→					





	kW				
NISSAN - NV400 Bus (X62, X62B) 11/11→					
 Brake Caliper					
dCi 100	74	11/11→09/16	Fitting Position: Rear Axle Left	24.3484-1703.5	241303 Brake System: Bosch Supplementary Article/Supplementary Info: without holder Brake Caliper Type: Fist-type Caliper
dCi 110	81	06/14→			
dCi 125	92	11/11→09/16			
dCi 135	100	06/14→09/16			
dCi 145	107	11/11→			
dCi 150	110	02/14→	Fitting Position: Rear Axle Right	24.3484-1704.5	241304 Brake System: Bosch Supplementary Article/Supplementary Info: without holder Brake Caliper Type: Fist-type Caliper
dCi 160	120	06/14→09/16			
dCi 170	125	07/15→			
dCi 180	132	01/20→			
 Brake Disc					
dCi 100	74	11/11→09/16	Fitting Position: Front Axle	24.0128-0252.1	428252 Outer diameter [mm]: 302 Brake Disc Thickness [mm] 28 Minimum thickness [mm] 24.5 Brake Disc Type: Vented Supplementary Article/Info 2: with bolts/screws
dCi 110	81	06/14→			
dCi 125	92	11/11→09/16			
dCi 135	100	06/14→09/16			
dCi 145	107	11/11→			
dCi 150	110	02/14→	Fitting Position: Rear Axle	24.0112-0191.1	412191 Outer diameter [mm]: 305 Brake Disc Thickness [mm] 12 Minimum thickness [mm] 10 Brake Disc Type: Solid Supplementary Article/Info 2: with bolts/screws
dCi 160	120	06/14→09/16			
dCi 170	125	07/15→			
dCi 180	132	01/20→			
NISSAN - NV400 Platform/Chassis (X62, X62B) 11/11→					
 Brake Caliper					
dCi 100	74	11/11→09/16	Fitting Position: Front Axle Left	24.3481-1821.5	241355 Brake System: Brembo Supplementary Article/Supplementary Info: without holder Brake Caliper Type: Fist-type Caliper (2 pistons)
dCi 110	81	06/14→			
dCi 125	92	11/11→09/16			
dCi 130	96	06/16→			
dCi 135	100	06/14→06/16			
dCi 145	107	11/11→	Fitting Position: Front Axle Right	24.3481-1822.5	241356 Brake System: Brembo Supplementary Article/Supplementary Info: without holder Brake Caliper Type: Fist-type Caliper (2 pistons)
dCi 150	110	08/14→			
dCi 165	120	06/14→06/16			
dCi 170	125	06/16→			
dCi 180	132	01/20→			
			Fitting Position: Rear Axle Left	24.3484-1703.5	241303 Brake System: Bosch Supplementary Article/Supplementary Info: without holder Brake Caliper Type: Fist-type Caliper
			Fitting Position: Rear Axle Right	24.3484-1704.5	241304 Brake System: Bosch Supplementary Article/Supplementary Info: without holder Brake Caliper Type: Fist-type Caliper
dCi 125 RWD	92	11/11→09/16	Fitting Position: Front Axle Left	24.3481-1821.5	241355 Brake System: Brembo Supplementary Article/Supplementary Info: without holder Brake Caliper Type: Fist-type Caliper (2 pistons)
dCi 130 RWD	96	06/16→			
dCi 135 RWD	100	06/14→06/16			
dCi 145 RWD	107	11/11→			
dCi 150 RWD	110	08/14→06/16			
dCi 165 RWD	120	06/14→	Fitting Position: Front Axle Right	24.3481-1822.5	241356 Brake System: Brembo Supplementary Article/Supplementary Info: without holder Brake Caliper Type: Fist-type Caliper (2 pistons)
			Tyres: for single tyres; Fitting Position: Rear Axle Left	24.3484-1703.5	241303 Brake System: Bosch Supplementary Article/Supplementary Info: without holder Brake Caliper Type: Fist-type Caliper
			Tyres: for single tyres; Fitting Position: Rear Axle Right	24.3484-1704.5	241304 Brake System: Bosch Supplementary Article/Supplementary Info: without holder Brake Caliper Type: Fist-type Caliper
 Brake Disc					
dCi 100	74	11/11→09/16	Fitting Position: Front Axle	24.0128-0252.1	428252 Outer diameter [mm]: 302 Brake Disc Thickness [mm] 28 Minimum thickness [mm] 24.5 Brake Disc Type: Vented Supplementary Article/Info 2: with bolts/screws
dCi 110	81	06/14→			
dCi 125	92	11/11→09/16			
dCi 130	96	06/16→			
dCi 135	100	06/14→06/16			
dCi 145	107	11/11→			
dCi 150	110	08/14→			
dCi 165	120	06/14→06/16			
→					

	kW				
NISSAN - NV400 Platform/Chassis (X62, X62B) 11/11→					
 Brake Disc					
dCi 170 dCi 180	125 06/16→ 132 01/20→	Fitting Position: Rear Axle	24.0112-0191.1 412191	Outer diameter [mm]: 305 Brake Disc Thickness [mm] 12 Minimum thickness [mm] 10 Brake Disc Type: Solid Supplementary Article/Info 2: with bolts/screws	
dCi 125 RWD dCi 130 RWD dCi 135 RWD dCi 145 RWD dCi 150 RWD dCi 165 RWD	92 11/11→09/16 96 06/16→ 100 06/14→06/16 107 11/11→ 110 08/14→06/16 120 06/14→	Fitting Position: Front Axle	24.0128-0252.1 428252	Outer diameter [mm]: 302 Brake Disc Thickness [mm] 28 Minimum thickness [mm] 24.5 Brake Disc Type: Vented Supplementary Article/Info 2: with bolts/screws	
		Tyres: for single tyres; Fitting Position: Rear Axle	24.0112-0190.1 412190	Outer diameter [mm]: 305 Brake Disc Thickness [mm] 12 Minimum thickness [mm] 10 Brake Disc Type: Solid Supplementary Article/Info 2: with bolts/screws	
		Tyres: for dual tyres; Fitting Position: Rear Axle	24.0118-0153.1 418153	Outer diameter [mm]: 302 Brake Disc Thickness [mm] 18 Minimum thickness [mm] 15 Brake Disc Type: Solid	
NISSAN - NV400 Van (X62, X62B) 11/11→					
 Brake Caliper					
dCi 100 dCi 110 dCi 125 dCi 135 dCi 145 dCi 150 dCi 165 dCi 170 dCi 180	74 11/11→09/16 81 06/14→ 92 11/11→09/16 100 06/14→ 107 11/11→ 110 02/14→ 120 06/14→09/16 125 09/16→ 132 01/20→	Fitting Position: Front Axle Left	24.3481-1821.5 241355	Brake System: Brembo Supplementary Article/Supplementary Info: without holder Brake Caliper Type: Fist-type Caliper (2 pistons)	
		Fitting Position: Front Axle Right	24.3481-1822.5 241356	Brake System: Brembo Supplementary Article/Supplementary Info: without holder Brake Caliper Type: Fist-type Caliper (2 pistons)	
		Fitting Position: Rear Axle Left	24.3484-1703.5 241303	Brake System: Bosch Supplementary Article/Supplementary Info: without holder Brake Caliper Type: Fist-type Caliper	
		Fitting Position: Rear Axle Right	24.3484-1704.5 241304	Brake System: Bosch Supplementary Article/Supplementary Info: without holder Brake Caliper Type: Fist-type Caliper	
dCi 125 RWD dCi 130 dCi 130 RWD dCi 135 RWD dCi 145 RWD dCi 150 RWD dCi 165 RWD	92 11/11→09/16 96 09/16→ 96 09/16→ 100 06/14→09/16 107 11/11→02/14 110 02/14→09/16 120 06/14→09/16	Fitting Position: Front Axle Left	24.3481-1821.5 241355	Brake System: Brembo Supplementary Article/Supplementary Info: without holder Brake Caliper Type: Fist-type Caliper (2 pistons)	
		Fitting Position: Front Axle Right	24.3481-1822.5 241356	Brake System: Brembo Supplementary Article/Supplementary Info: without holder Brake Caliper Type: Fist-type Caliper (2 pistons)	
		Tyres: for single tyres; Fitting Position: Rear Axle Left	24.3484-1703.5 241303	Brake System: Bosch Supplementary Article/Supplementary Info: without holder Brake Caliper Type: Fist-type Caliper	
		Tyres: for single tyres; Fitting Position: Rear Axle Right	24.3484-1704.5 241304	Brake System: Bosch Supplementary Article/Supplementary Info: without holder Brake Caliper Type: Fist-type Caliper	
 Brake Disc					
dCi 100 dCi 110 dCi 125 dCi 135 dCi 145 dCi 150 dCi 165 dCi 170 dCi 180 →	74 11/11→09/16 81 06/14→ 92 11/11→09/16 100 06/14→ 107 11/11→ 110 02/14→ 120 06/14→09/16 125 09/16→ 132 01/20→	Fitting Position: Front Axle	24.0128-0252.1 428252	Outer diameter [mm]: 302 Brake Disc Thickness [mm] 28 Minimum thickness [mm] 24.5 Brake Disc Type: Vented Supplementary Article/Info 2: with bolts/screws	

	kW								
NISSAN - NV400 Van (X62, X62B) 11/11→									
 Brake Disc									
dCi 100	74 11/11→09/16	Fitting Position: Rear Axle		24.0112-0191.1 412191	Outer diameter [mm]: 305 Brake Disc Thickness [mm] 12 Minimum thickness [mm] 10 Brake Disc Type: Solid Supplementary Article/Info 2: with bolts/screws				
dCi 110	81 06/14→								
dCi 125	92 11/11→09/16								
dCi 135	100 06/14→								
dCi 145	107 11/11→								
dCi 150	110 02/14→								
dCi 165	120 06/14→09/16								
dCi 170	125 09/16→								
dCi 180	132 01/20→								
dCi 125 RWD	92 11/11→09/16	Fitting Position: Front Axle		24.0128-0252.1 428252	Outer diameter [mm]: 302 Brake Disc Thickness [mm] 28 Minimum thickness [mm] 24.5 Brake Disc Type: Vented Supplementary Article/Info 2: with bolts/screws				
dCi 130 RWD	96 09/16→								
dCi 135 RWD	100 06/14→09/16								
dCi 145 RWD	107 11/11→02/14								
dCi 150 RWD	110 02/14→09/16								
dCi 165 RWD	120 06/14→09/16								
		Tyres: for single tyres; Fitting Position: Rear Axle		24.0112-0190.1 412190	Outer diameter [mm]: 305 Brake Disc Thickness [mm] 12 Minimum thickness [mm] 10 Brake Disc Type: Solid Supplementary Article/Info 2: with bolts/screws				
		Tyres: for dual tyres; Fitting Position: Rear Axle		24.0118-0153.1 418153	Outer diameter [mm]: 302 Brake Disc Thickness [mm] 18 Minimum thickness [mm] 15 Brake Disc Type: Solid				
dCi 130	96 09/16→	Fitting Position: Front Axle		24.0128-0252.1 428252	Outer diameter [mm]: 302 Brake Disc Thickness [mm] 28 Minimum thickness [mm] 24.5 Brake Disc Type: Vented Supplementary Article/Info 2: with bolts/screws				
						Tyres: for single tyres; Fitting Position: Rear Axle		24.0112-0191.1 412191	Outer diameter [mm]: 305 Brake Disc Thickness [mm] 12 Minimum thickness [mm] 10 Brake Disc Type: Solid Supplementary Article/Info 2: with bolts/screws
						Tyres: for dual tyres; Fitting Position: Rear Axle		24.0118-0153.1 418153	Outer diameter [mm]: 302 Brake Disc Thickness [mm] 18 Minimum thickness [mm] 15 Brake Disc Type: Solid
NISSAN - PRIMASTAR (X82) 11/21→									
 Brake Caliper									
2.0 dCi 110	81 11/21→	Fitting Position: Rear Axle Left		24.3414-1707.5 240337	Brake System: Lucas / TRW Supplementary Article/Supplementary Info: without holder Brake Caliper Type: Fist-type Caliper				
2.0 dCi 130	96 11/21→								
2.0 dCi 150	110 11/21→								
2.0 dCi 170	125 11/21→								
		Fitting Position: Rear Axle Right		24.3414-1708.5 240338	Brake System: Lucas / TRW Supplementary Article/Supplementary Info: without holder Brake Caliper Type: Fist-type Caliper				
 Brake Pad Set, disc brake									
2.0 dCi 110	81 11/21→	Fitting Position: Rear Axle		13.0460-2840.2 602840	Brake System: Lucas / TRW 23980 16,5 Wear Warning Contact: prepared for wear indicator / excl. wear warning contact				
2.0 dCi 130	96 11/21→								
2.0 dCi 150	110 11/21→								
2.0 dCi 170	125 11/21→								
 Brake Disc									
2.0 dCi 110	81 11/21→	Fitting Position: Front Axle		24.0128-0287.1 428287	Outer diameter [mm]: 296 Brake Disc Thickness [mm] 28 Minimum thickness [mm] 23.4 Brake Disc Type: Vented Supplementary Article/Info 2: with bolts/screws				
2.0 dCi 130	96 11/21→								
2.0 dCi 150	110 11/21→								
2.0 dCi 170	125 11/21→								
 Brake Hose									
2.0 dCi 110	81 11/21→	Required quantity: 2; Fitting Position: Rear Axle		2 24.5229-0200.3 330572	Length [mm]: 200				
2.0 dCi 130	96 11/21→								
2.0 dCi 150	110 11/21→								
2.0 dCi 170	125 11/21→								

	kW				
NISSAN - PRIMASTAR Bus (X83) 03/01→					
 Brake Caliper					
2.0	86 - 03/01→ 88	Fitting Position: Rear Axle Left		24.3414-1707.5 240337	Brake System: Lucas / TRW Supplementary Article/Supplementary Info: without holder Brake Caliper Type: Fist-type Caliper
dCi 115	84 09/08→				
dCi 120	84 09/06→				
dCi 150	107 09/06→				
dCi 90	66 09/06→	Fitting Position: Rear Axle Right		24.3414-1708.5 240338	Brake System: Lucas / TRW Supplementary Article/Supplementary Info: without holder Brake Caliper Type: Fist-type Caliper
dCi 100	74 03/01→	→ Construction year to: 08/06; Fitting Position: Rear Axle Left		24.3414-1707.5 240337	Brake System: Lucas / TRW Supplementary Article/Supplementary Info: without holder Brake Caliper Type: Fist-type Caliper
dCi 80	60 03/01→				
		→ Construction year to: 08/06; Fitting Position: Rear Axle Right		24.3414-1708.5 240338	Brake System: Lucas / TRW Supplementary Article/Supplementary Info: without holder Brake Caliper Type: Fist-type Caliper
dCi 140	99 07/03→	Construction year from: 09/03 → → Construction year to: 08/06; Fitting Position: Rear Axle Left		24.3414-1707.5 240337	Brake System: Lucas / TRW Supplementary Article/Supplementary Info: without holder Brake Caliper Type: Fist-type Caliper
		Construction year from: 09/03 → → Construction year to: 08/06; Fitting Position: Rear Axle Right		24.3414-1708.5 240338	Brake System: Lucas / TRW Supplementary Article/Supplementary Info: without holder Brake Caliper Type: Fist-type Caliper
 Brake Pad Set, disc brake					
2.0	86 - 03/01→ 88	Fitting Position: Rear Axle		13.0460-2840.2 602840	Brake System: Lucas / TRW 23980 16,5 Wear Warning Contact: prepared for wear indicator / excl. wear warning contact
dCi 115	84 09/08→				
dCi 120	84 09/06→				
dCi 150	107 09/06→				
dCi 90	66 09/06→				
dCi 100	74 03/01→	→ Construction year to: 08/06; Fitting Position: Rear Axle		13.0460-2840.2 602840	Brake System: Lucas / TRW 23980 16,5 Wear Warning Contact: prepared for wear indicator / excl. wear warning contact
dCi 140	99 07/03→				
dCi 80	60 03/01→				
 Brake Hose					
2.0	86 - 03/01→ 88	Required quantity: 2; Fitting Position: Rear Axle		2 24.5229-0200.3 330572	Length [mm]: 200
dCi 115	84 09/08→				
dCi 120	84 09/06→				
dCi 150	107 09/06→				
dCi 90	66 09/06→				
dCi 100	74 03/01→	→ Construction year to: 08/06; Required quantity: 2; Fitting Position: Rear Axle		2 24.5229-0200.3 330572	Length [mm]: 200
dCi 140	99 07/03→				
dCi 80	60 03/01→				
 Wheel Speed Sensor					
2.0	86 04/06→	Fitting Position: Rear Axle		24.0710-2100.3 360649	Length [mm]: 956
2.0	88 03/01→08/06	Required quantity: 1; Fitting Position: Front Axle		1 24.0710-2097.3 360647	Length [mm]: 720
dCi 115	84 09/08→				
dCi 120	84 09/06→	Fitting Position: Rear Axle		24.0710-2100.3 360649	Length [mm]: 956
dCi 150	107 09/06→				
dCi 90	66 09/06→				
dCi 100	74 03/01→	→ Construction year to: 08/06; Required quantity: 1; Fitting Position: Front Axle		1 24.0710-2097.3 360647	Length [mm]: 720
dCi 140	99 07/03→				
dCi 80	60 03/01→	Fitting Position: Rear Axle		24.0710-2100.3 360649	Length [mm]: 956
NISSAN - PRIMASTAR Platform/Chassis (X83) 07/02→					
 Brake Caliper					
1.9 dCi 100	74 07/02→08/06	Fitting Position: Rear Axle Left		24.3414-1707.5 240337	Brake System: Lucas / TRW Supplementary Article/Supplementary Info: without holder Brake Caliper Type: Fist-type Caliper
1.9 dCi 80	60 07/02→08/06				
2.0	88 07/02→08/06				
→					

	kW				
NISSAN - PRIMASTAR Platform/Chassis (X83) 07/02→					
 Brake Caliper					
1.9 dCi 100 1.9 dCi 80 2.0	74 07/02→08/06 60 07/02→08/06 88 07/02→08/06	Fitting Position: Rear Axle Right		24.3414-1708.5 240338	Brake System: Lucas / TRW Supplementary Article/Supplementary Info: without holder Brake Caliper Type: Fist-type Caliper
2.5 dCi 140	99 07/02→08/06	Construction year from: 07/03 →; Fitting Position: Rear Axle Left		24.3414-1707.5 240337	Brake System: Lucas / TRW Supplementary Article/Supplementary Info: without holder Brake Caliper Type: Fist-type Caliper
		Construction year from: 07/03 →; Fitting Position: Rear Axle Right		24.3414-1708.5 240338	Brake System: Lucas / TRW Supplementary Article/Supplementary Info: without holder Brake Caliper Type: Fist-type Caliper
2.5 dCi 150	107 04/06→	Construction year from: 09/06 →; Fitting Position: Rear Axle Left		24.3414-1707.5 240337	Brake System: Lucas / TRW Supplementary Article/Supplementary Info: without holder Brake Caliper Type: Fist-type Caliper
		Construction year from: 09/06 →; Fitting Position: Rear Axle Right		24.3414-1708.5 240338	Brake System: Lucas / TRW Supplementary Article/Supplementary Info: without holder Brake Caliper Type: Fist-type Caliper
 Brake Pad Set, disc brake					
1.9 dCi 100 1.9 dCi 80 2.0 2.5 dCi 140	74 07/02→08/06 60 07/02→08/06 88 07/02→08/06 99 07/02→08/06	Fitting Position: Rear Axle		13.0460-2840.2 602840	Brake System: Lucas / TRW 23980 16,5 Wear Warning Contact: prepared for wear indicator / excl. wear warning contact
2.5 dCi 150	107 04/06→	Construction year from: 09/06 →; Fitting Position: Rear Axle		13.0460-2840.2 602840	Brake System: Lucas / TRW 23980 16,5 Wear Warning Contact: prepared for wear indicator / excl. wear warning contact
 Brake Hose					
1.9 dCi 100 1.9 dCi 80 2.5 dCi 140 2.0	74 07/02→08/06 60 07/02→08/06 99 07/02→08/06 88 07/02→08/06	Required quantity: 2; Fitting Position: Rear Axle		2 24.5229-0200.3 330572	Length [mm]: 200
2.5 dCi 150	107 04/06→	Construction year from: 09/06 →; Required quantity: 2; Fitting Position: Rear Axle		2 24.5229-0200.3 330572	Length [mm]: 200
 Wheel Speed Sensor					
1.9 dCi 100 1.9 dCi 80 2.5 dCi 140	74 07/02→08/06 60 07/02→08/06 99 07/02→08/06	Required quantity: 1; Fitting Position: Front Axle		1 24.0710-2097.3 360647	Length [mm]: 720
2.0	88 07/02→08/06	Fitting Position: Rear Axle		24.0710-2100.3 360649	Length [mm]: 956
		Required quantity: 2; Fitting Position: Front Axle		2 24.0710-2097.3 360647	Length [mm]: 720
2.5 dCi 150	107 04/06→	Required quantity: 2; Fitting Position: Rear Axle		2 24.0710-2100.3 360649	Length [mm]: 956
		Construction year from: 09/06 →; Required quantity: 1; Fitting Position: Front Axle		1 24.0710-2097.3 360647	Length [mm]: 720
		Fitting Position: Rear Axle		24.0710-2100.3 360649	Length [mm]: 956
NISSAN - PRIMASTAR Van (X83) 09/02→					
 Brake Caliper					
1.9 dCi 100 1.9 dCi 80 2.5 dCi 140	74 09/02→ 60 09/02→ 99 07/03→	→ Construction year to: 08/06; Fitting Position: Rear Axle Left		24.3414-1707.5 240337	Brake System: Lucas / TRW Supplementary Article/Supplementary Info: without holder Brake Caliper Type: Fist-type Caliper
		→ Construction year to: 08/06; Fitting Position: Rear Axle Right		24.3414-1708.5 240338	Brake System: Lucas / TRW Supplementary Article/Supplementary Info: without holder Brake Caliper Type: Fist-type Caliper
→					

	kW				
NISSAN - PRIMASTAR Van (X83) 09/02→					
 Brake Caliper					
2.0	86 - 02/03→ 88	Fitting Position: Rear Axle Left		24.3414-1707.5 240337	Brake System: Lucas / TRW Supplementary Article/Supplementary Info: without holder Brake Caliper Type: Fist-type Caliper
2.0 dCi 115	84 09/06→				
2.0 dCi 90	66 09/06→				
2.5 dCi 115	84 09/08→				
2.5 dCi 150	107 09/06→	Fitting Position: Rear Axle Right		24.3414-1708.5 240338	Brake System: Lucas / TRW Supplementary Article/Supplementary Info: without holder Brake Caliper Type: Fist-type Caliper
 Brake Pad Set, disc brake					
1.9 dCi 100	74 09/02→	→ Construction year to: 08/06; Fitting Position: Rear Axle		13.0460-2840.2 602840	Brake System: Lucas / TRW 23980 16,5 Wear Warning Contact: prepared for wear indicator / excl. wear warning contact
1.9 dCi 80	60 09/02→				
2.5 dCi 140	99 07/03→				
2.0	86 - 02/03→ 88	Fitting Position: Rear Axle		13.0460-2840.2 602840	Brake System: Lucas / TRW 23980 16,5 Wear Warning Contact: prepared for wear indicator / excl. wear warning contact
2.0 dCi 115	84 09/06→				
2.0 dCi 90	66 09/06→				
2.5 dCi 115	84 09/08→				
2.5 dCi 150	107 09/06→				
 Brake Hose					
1.9 dCi 100	74 09/02→	→ Construction year to: 08/06; Required quantity: 2; Fitting Position: Rear Axle	2	24.5229-0200.3 330572	Length [mm]: 200
1.9 dCi 80	60 09/02→				
2.5 dCi 140	99 07/03→				
2.0	86 - 02/03→ 88	Required quantity: 2; Fitting Position: Rear Axle	2	24.5229-0200.3 330572	Length [mm]: 200
2.0 dCi 115	84 09/06→				
2.0 dCi 90	66 09/06→				
2.5 dCi 115	84 09/08→				
2.5 dCi 150	107 09/06→				
 Wheel Speed Sensor					
1.9 dCi 100	74 09/02→	→ Construction year to: 08/06; Required quantity: 1; Fitting Position: Front Axle	1	24.0710-2097.3 360647	Length [mm]: 720
1.9 dCi 80	60 09/02→				
2.5 dCi 140	99 07/03→	Fitting Position: Rear Axle		24.0710-2100.3 360649	Length [mm]: 956
2.0	86 04/06→	Fitting Position: Rear Axle		24.0710-2100.3 360649	Length [mm]: 956
2.0	88 02/03→	Required quantity: 1; Fitting Position: Front Axle	1	24.0710-2097.3 360647	Length [mm]: 720
2.0 dCi 115	84 09/06→				
2.0 dCi 90	66 09/06→	Fitting Position: Rear Axle		24.0710-2100.3 360649	Length [mm]: 956
2.5 dCi 115	84 09/08→				
2.5 dCi 150	107 09/06→				
NISSAN - PRIMERA (P12) 01/02→					
Guide Sleeve Kit, brake caliper					
1.6	78 03/02→08/08	Fitting Position: Rear Axle		11.0101-5407.2 260011	Brake System: ATE
1.8	85 03/02→10/08				
1.8 LPG	85 03/02→				
1.9 dCi	88 04/03→10/07				
2.0	103 03/02→10/08				
2.2 dCi	102 04/03→04/06				
1.6	80 01/02→04/06	Construction year from: 03/02 →; Fitting Position: Rear Axle		11.0101-5407.2 260011	Brake System: ATE
1.9 dCi	85 08/02→10/07	Construction year from: 04/03 →; Fitting Position: Rear Axle		11.0101-5407.2 260011	Brake System: ATE
2.2 Di	93 03/02→05/07	→ Construction year to: 04/03; Fitting Position: Rear Axle		11.0101-5407.2 260011	Brake System: ATE
Guide Bolt, brake caliper					
1.6	78 03/02→08/08	Required quantity: 2	2	11.8171-0008.1 990049	Brake System: ATE
1.8	85 03/02→10/08				
1.8 LPG	85 03/02→				
1.9 dCi	88 04/03→10/07				
2.0	103 03/02→10/08				
2.2 dCi	102 04/03→04/06				
1.6	80 01/02→04/06	Construction year from: 03/02 →; Required quantity: 2	2	11.8171-0008.1 990049	Brake System: ATE
1.9 dCi	85 08/02→10/07	Construction year from: 04/03 →; Required quantity: 2	2	11.8171-0008.1 990049	Brake System: ATE
2.2 Di	93 03/02→05/07	→ Construction year to: 04/03; Required quantity: 2	2	11.8171-0008.1 990049	Brake System: ATE

	kW				
NISSAN - PRIMERA Estate (WP12) 01/02→					
Guide Sleeve Kit, brake caliper					
1.6 Visia	80	01/02→04/06	Construction year from: 03/02 →; Fitting Position: Rear Axle	11.0101-5407.2 260011	Brake System: ATE
1.8	85	03/02→05/07	Fitting Position: Rear Axle	11.0101-5407.2 260011	Brake System: ATE
2.2 Di	93	03/02→04/03			
1.9 dCi	85	08/02→10/07	Construction year from: 04/03 →; Fitting Position: Rear Axle	11.0101-5407.2 260011	Brake System: ATE
1.9 dCi	88	04/03→	→ Construction year to: 10/07; Fitting Position: Rear Axle	11.0101-5407.2 260011	Brake System: ATE
2.2 dCi	102	04/03→			
2.0	103	03/02→	→ Construction year to: 10/08; Fitting Position: Rear Axle	11.0101-5407.2 260011	Brake System: ATE
Guide Bolt, brake caliper					
1.6 Visia	80	01/02→04/06	Construction year from: 03/02 →; Required quantity: 2	2 11.8171-0008.1 990049	Brake System: ATE
1.8	85	03/02→05/07	Required quantity: 2	2 11.8171-0008.1 990049	Brake System: ATE
2.2 Di	93	03/02→04/03			
1.9 dCi	85	08/02→10/07	Construction year from: 04/03 →; Required quantity: 2	2 11.8171-0008.1 990049	Brake System: ATE
1.9 dCi	88	04/03→	→ Construction year to: 10/07; Required quantity: 2	2 11.8171-0008.1 990049	Brake System: ATE
2.2 dCi	102	04/03→			
2.0	103	03/02→	→ Construction year to: 10/08; Required quantity: 2	2 11.8171-0008.1 990049	Brake System: ATE
NISSAN - PRIMERA Hatchback (P12) 01/02→					
Guide Sleeve Kit, brake caliper					
1.6	78 - 80	07/02→08/08	Fitting Position: Rear Axle	11.0101-5407.2 260011	Brake System: ATE
1.8	85	07/02→10/08			
1.9 dCi	88	04/03→10/07			
2.0	103	07/02→10/08			
1.9 dCi	85	08/02→10/07	Construction year from: 04/03 →; Fitting Position: Rear Axle	11.0101-5407.2 260011	Brake System: ATE
2.2 dCi	102	04/03→	→ Construction year to: 10/07; Fitting Position: Rear Axle	11.0101-5407.2 260011	Brake System: ATE
2.2 Di	93	07/02→05/07	→ Construction year to: 04/03; Fitting Position: Rear Axle	11.0101-5407.2 260011	Brake System: ATE
Guide Bolt, brake caliper					
1.6	78 - 80	07/02→08/08	Required quantity: 2	2 11.8171-0008.1 990049	Brake System: ATE
1.8	85	07/02→10/08			
1.9 dCi	88	04/03→10/07			
2.0	103	07/02→10/08			
1.9 dCi	85	08/02→10/07	Construction year from: 04/03 →; Required quantity: 2	2 11.8171-0008.1 990049	Brake System: ATE
2.2 dCi	102	04/03→	→ Construction year to: 10/07; Required quantity: 2	2 11.8171-0008.1 990049	Brake System: ATE
2.2 Di	93	07/02→05/07	→ Construction year to: 04/03; Required quantity: 2	2 11.8171-0008.1 990049	Brake System: ATE
NISSAN - PRIMERA Traveller (WP11) 06/96→01/02					
Guide Sleeve Kit, brake caliper					
2.0 16V	85 - 96	06/96→12/01	Construction year from: 07/99 →; Fitting Position: Front Axle	11.0101-5407.2 260011	Brake System: ATE
2.0 16V	103	08/99→12/01	Fitting Position: Front Axle	11.0101-5407.2 260011	Brake System: ATE
Guide Bolt, brake caliper					
2.0 16V	85 - 96	06/96→12/01	Construction year from: 07/99 →; Required quantity: 2	2 11.8171-0008.1 990049	Brake System: ATE
2.0 16V	103	08/99→12/01	Required quantity: 2	2 11.8171-0008.1 990049	Brake System: ATE
NISSAN - QASHQAI II SUV (J11, J11_) 11/13→					
 Brake Disc					
1.2 DIG-T	85	11/13→	Fitting Position: Rear Axle	24.0113-0200.1 413200	Outer diameter [mm]: 290 Brake Disc Thickness [mm] 13 Minimum thickness [mm] 11 Brake Disc Type: Solid
1.3 DIG-T	103 - 118	08/18→			
1.5 dCi	81 - 85	11/13→			
1.6 dCi	96	11/13→			
1.6 dCi ALL MODE 4x4-i	96	11/13→			
1.6 DIG-T	120	10/14→			
1.7 dCi	110	01/19→			
2.0	103 - 106	06/14→			
2.0 ALL MODE 4x4-i	103 - 106	01/15→			

	kW				
OPEL - ASTRA F (T92) 09/91→09/98					
Guide Bolt, brake caliper					
1.4 1.4 i	55 09/91→09/93 44 09/91→09/98	Construction year from: 10/91 →; Required quantity: 2; Fitting Position: Front Axle	2	11.8171-0008.1 990049	Brake System: ATE
1.4	60 09/92→09/98	Construction year from: 08/95 →; Required quantity: 2; Fitting Position: Front Axle	2	11.8171-0008.1 990049	Brake System: ATE
		→ Construction year to: 07/95; Required quantity: 2; Fitting Position: Front Axle	2	11.8171-0008.1 990049	Brake System: ATE
1.4 i 16V 1.4 Si	66 02/96→09/98 60 03/92→09/98	Braking System: for vehicles with rein- forced brakes; Required quantity: 2	2	11.8171-0008.1 990049	Brake System: ATE
		Transmission Type: Manual Transmis- sion; Braking System: not for vehicles with reinforced brakes; Required quantity: 2; Fitting Position: Front Axle	2	11.8171-0008.1 990049	Brake System: ATE
		Transmission Type: Automatic Transmis- sion; Braking System: not for vehicles with reinforced brakes; Required quantity: 2; Fitting Position: Front Axle	2	11.8171-0008.1 990049	Brake System: ATE
1.6 1.6 i	55 09/95→09/98 52 - 03/92→09/98 55	Required quantity: 2	2	11.8171-0008.1 990049	Brake System: ATE
		Transmission Type: Manual Transmis- sion; Required quantity: 2; Fitting Position: Front Axle	2	11.8171-0008.1 990049	Brake System: ATE
		Transmission Type: Automatic Transmis- sion; Required quantity: 2; Fitting Position: Front Axle	2	11.8171-0008.1 990049	Brake System: ATE
1.6 i 16V 1.8 i	74 08/94→09/98 66 03/92→09/98	Required quantity: 2	2	11.8171-0008.1 990049	Brake System: ATE
		Required quantity: 2; Fitting Position: Front Axle	2	11.8171-0008.1 990049	Brake System: ATE
1.6 Si	74 05/92→12/94	Required quantity: 2; Fitting Position: Front Axle	2	11.8171-0008.1 990049	Brake System: ATE
1.7 D 1.7 TD 1.7 TDS	42 - 03/92→09/98 44 50 11/94→09/98 60 03/92→09/98	Braking System: for vehicles with rein- forced brakes; Required quantity: 2	2	11.8171-0008.1 990049	Brake System: ATE
		Braking System: not for vehicles with reinforced brakes; Required quantity: 2; Fitting Position: Front Axle	2	11.8171-0008.1 990049	Brake System: ATE
1.8 i 16V 2.0 i 2.0 i 16V	82 - 06/93→09/98 92 85 03/92→09/98 100 02/95→09/98	Required quantity: 2	2	11.8171-0008.1 990049	Brake System: ATE
OPEL - ASTRA F CLASSIC Estate (T92) 01/98→01/05					
Guide Sleeve Kit, brake caliper					
1.4 i 1.6 i 1.6 i 16V	44 01/98→01/05 55 01/98→01/05 74 01/98→01/05	Fitting Position: Front Axle		11.0101-5407.2 260011	Brake System: ATE
Guide Bolt, brake caliper					
1.4 i 1.6 i 1.6 i 16V	44 01/98→01/05 55 01/98→01/05 74 01/98→01/05	Required quantity: 2	2	11.8171-0008.1 990049	Brake System: ATE
OPEL - ASTRA F CLASSIC Hatchback (T92) 01/98→08/02					
Guide Sleeve Kit, brake caliper					
1.4 i 1.6 i 1.6 i 16V	44 01/98→08/02 55 01/98→08/02 74 01/98→08/02	Fitting Position: Front Axle		11.0101-5407.2 260011	Brake System: ATE
Guide Bolt, brake caliper					
1.4 i 1.6 i 1.6 i 16V	44 01/98→08/02 55 01/98→08/02 74 01/98→08/02	Required quantity: 2	2	11.8171-0008.1 990049	Brake System: ATE
OPEL - ASTRA F CLASSIC Saloon (T92) 01/98→08/02					
Guide Sleeve Kit, brake caliper					
1.4 i 1.6 i 1.6 i 16V	44 01/98→08/02 55 01/98→08/02 74 01/98→08/02	Fitting Position: Front Axle		11.0101-5407.2 260011	Brake System: ATE
Guide Bolt, brake caliper					
1.4 i 1.6 i 1.6 i 16V	44 01/98→08/02 55 01/98→08/02 74 01/98→08/02	Required quantity: 2	2	11.8171-0008.1 990049	Brake System: ATE

	kW				
OPEL - ASTRA F Convertible (T92) 03/93→03/01					
Guide Sleeve Kit, brake caliper					
1.4 i 16V 1.4 Si	66 01/96→03/01 60 05/93→03/01	→ Construction year to: 09/98; Transmission Type: Automatic Transmis- sion; Braking System: not for vehicles with reinforced brakes; Fitting Position: Front Axle		11.0101-5407.2 260011	Brake System: ATE
		Fitting Position: Front Axle		11.0101-5407.2 260011	Brake System: ATE
		→ Construction year to: 09/98; Braking System: for vehicles with rein- forced brakes; Fitting Position: Front Axle		11.0101-5407.2 260011	Brake System: ATE
		→ Construction year to: 09/98; Transmission Type: Manual Transmis- sion; Braking System: not for vehicles with reinforced brakes; Fitting Position: Front Axle		11.0101-5407.2 260011	Brake System: ATE
1.6 i 2.0 i	52 03/93→08/96 85 03/93→10/94	Fitting Position: Front Axle		11.0101-5407.2 260011	Brake System: ATE
1.6 i 1.8 i 16V	55 01/96→03/01 85 11/94→03/01	Fitting Position: Front Axle		11.0101-5407.2 260011	Brake System: ATE
		→ Construction year to: 09/98; Fitting Position: Front Axle		11.0101-5407.2 260011	Brake System: ATE
Guide Bolt, brake caliper					
1.4 i 16V 1.4 Si	66 01/96→03/01 60 05/93→03/01	→ Construction year to: 09/98; Braking System: for vehicles with rein- forced brakes; Required quantity: 2	2	11.8171-0008.1 990049	Brake System: ATE
		Required quantity: 2; Fitting Position: Front Axle	2	11.8171-0008.1 990049	Brake System: ATE
		→ Construction year to: 09/98; Transmission Type: Manual Transmis- sion; Braking System: not for vehicles with reinforced brakes; Required quantity: 2; Fitting Position: Front Axle	2	11.8171-0008.1 990049	Brake System: ATE
		→ Construction year to: 09/98; Transmission Type: Automatic Transmis- sion; Braking System: not for vehicles with reinforced brakes; Required quantity: 2; Fitting Position: Front Axle	2	11.8171-0008.1 990049	Brake System: ATE
1.6 i	52 03/93→08/96	Required quantity: 2; Fitting Position: Front Axle	2	11.8171-0008.1 990049	Brake System: ATE
1.6 i	55 01/96→03/01	→ Construction year to: 09/98; Required quantity: 2	2	11.8171-0008.1 990049	Brake System: ATE
		Required quantity: 2; Fitting Position: Front Axle	2	11.8171-0008.1 990049	Brake System: ATE
1.8 i 16V	85 11/94→03/01	→ Construction year to: 09/98; Required quantity: 2	2	11.8171-0008.1 990049	Brake System: ATE
		Required quantity: 2	2	11.8171-0008.1 990049	Brake System: ATE
2.0 i	85 03/93→10/94	Required quantity: 2	2	11.8171-0008.1 990049	Brake System: ATE
OPEL - ASTRA F Estate (T92) 09/91→01/98					
Guide Sleeve Kit, brake caliper					
1.4 1.4 i 1.6 i 1.8 i 2.0 i	55 09/91→09/93 44 09/91→01/98 55 09/91→01/98 66 09/91→01/98 85 09/91→07/94	Construction year from: 10/91 →; Fitting Position: Front Axle		11.0101-5407.2 260011	Brake System: ATE
1.4	60 09/92→01/98	→ Construction year to: 07/95; Fitting Position: Front Axle		11.0101-5407.2 260011	Brake System: ATE
		Construction year from: 08/95 →; Fitting Position: Front Axle		11.0101-5407.2 260011	Brake System: ATE
1.4 i 16V 1.4 Si	66 02/96→01/98 60 03/92→01/98	Transmission Type: Manual Transmis- sion; Braking System: not for vehicles with reinforced brakes; Fitting Position: Front Axle		11.0101-5407.2 260011	Brake System: ATE
		Transmission Type: Automatic Transmis- sion; Braking System: not for vehicles with reinforced brakes; Fitting Position: Front Axle		11.0101-5407.2 260011	Brake System: ATE
		Braking System: for vehicles with rein- forced brakes; Fitting Position: Front Axle		11.0101-5407.2 260011	Brake System: ATE
1.6 1.6 i 1.6 i 16V →	55 09/95→01/98 52 05/93→07/96 74 08/94→01/98	Fitting Position: Front Axle		11.0101-5407.2 260011	Brake System: ATE

	kW				
OPEL - ASTRA F Estate (T92) 09/91→01/98					
Guide Sleeve Kit, brake caliper					
1.6 Si	74	03/92→12/94	Fitting Position: Front Axle	2	11.0101-5407.2 260011 Brake System: ATE
1.7 D	42	12/91→01/98			
	44				
1.7 TD	50	11/94→01/98			
1.7 TDS	60	12/91→01/98			
1.8 i 16V	85	06/93→01/98			
	92				
2.0 i 16V	100	03/93→01/98			
	110				
Guide Bolt, brake caliper					
1.4	55	09/91→09/93	Construction year from: 10/91 →;	2	11.8171-0008.1 990049 Brake System: ATE
1.4 i	44	09/91→01/98	Required quantity: 2; Fitting Position: Front Axle		
1.4	60	09/92→01/98	Construction year from: 08/95 →;	2	11.8171-0008.1 990049 Brake System: ATE
			Required quantity: 2; Fitting Position: Front Axle		
			→ Construction year to: 07/95; Required quantity: 2; Fitting Position: Front Axle	2	11.8171-0008.1 990049 Brake System: ATE
1.4 i 16V	66	02/96→01/98	Braking System: for vehicles with rein-	2	11.8171-0008.1 990049 Brake System: ATE
1.4 Si	60	03/92→01/98	forced brakes; Required quantity: 2		
			Transmission Type: Manual Transmis-	2	11.8171-0008.1 990049 Brake System: ATE
			sion; Braking System: not for vehicles with		
			reinforced brakes; Required quantity: 2; Fitting Position: Front Axle		
			Transmission Type: Automatic Transmis-	2	11.8171-0008.1 990049 Brake System: ATE
			sion; Braking System: not for vehicles with		
			reinforced brakes; Required quantity: 2; Fitting Position: Front Axle		
1.6	55	09/95→01/98	Required quantity: 2	2	11.8171-0008.1 990049 Brake System: ATE
1.6 Si	74	03/92→12/94	Required quantity: 2; Fitting Position: Front Axle	2	11.8171-0008.1 990049 Brake System: ATE
1.6 i	52	05/93→07/96	Required quantity: 2; Fitting Position: Front Axle	2	11.8171-0008.1 990049 Brake System: ATE
1.6 i	55	09/91→01/98	Construction year from: 10/91 →;	2	11.8171-0008.1 990049 Brake System: ATE
1.8 i	66	09/91→01/98	Required quantity: 2		
			Construction year from: 10/91 →;	2	11.8171-0008.1 990049 Brake System: ATE
			Required quantity: 2; Fitting Position: Front Axle		
1.6 i 16V	74	08/94→01/98	Required quantity: 2	2	11.8171-0008.1 990049 Brake System: ATE
1.8 i 16V	85	06/93→01/98			
	92				
2.0 i 16V	100	03/93→01/98			
	110				
1.7 D	42	12/91→01/98	Braking System: for vehicles with rein-	2	11.8171-0008.1 990049 Brake System: ATE
	44		forced brakes; Required quantity: 2		
1.7 TD	50	11/94→01/98	Braking System: not for vehicles with	2	11.8171-0008.1 990049 Brake System: ATE
1.7 TDS	60	12/91→01/98	reinforced brakes; Required quantity: 2; Fitting Position: Front Axle		
2.0 i	85	09/91→07/94	Construction year from: 10/91 →;	2	11.8171-0008.1 990049 Brake System: ATE
			Required quantity: 2		
OPEL - ASTRA F Estate Van (T92) 10/91→01/99					
Guide Sleeve Kit, brake caliper					
1.4 i	44	10/91→01/99	→ Construction year to: 09/98;	2	11.0101-5407.2 260011 Brake System: ATE
1.7 D	44	07/92→01/99	Fitting Position: Front Axle		
1.7 TD	50	08/94→01/99			
1.6 i	52	10/91→02/98	Fitting Position: Front Axle	2	11.0101-5407.2 260011 Brake System: ATE
	55				
1.6 i 16V	74	08/94→03/98			
1.7 D	42	12/91→09/92			
1.7 TD	60	03/95→02/98			
Guide Bolt, brake caliper					
1.4 i	44	10/91→01/99	→ Construction year to: 09/98;	2	11.8171-0008.1 990049 Brake System: ATE
			Required quantity: 2; Fitting Position: Front Axle		
1.6 i	52	10/91→02/98	Required quantity: 2	2	11.8171-0008.1 990049 Brake System: ATE
	55		Required quantity: 2; Fitting Position: Front Axle	2	11.8171-0008.1 990049 Brake System: ATE
1.6 i 16V	74	08/94→03/98	Required quantity: 2	2	11.8171-0008.1 990049 Brake System: ATE
1.7 D	42	12/91→09/92	Braking System: for vehicles with rein-	2	11.8171-0008.1 990049 Brake System: ATE
1.7 TD	60	03/95→02/98	forced brakes; Required quantity: 2		
→					

	kW				
OPEL - ASTRA F Estate Van (T92) 10/91→01/99					
Guide Bolt, brake caliper					
1.7 D 1.7 TD	42 12/91→09/92 60 03/95→02/98	Braking System: not for vehicles with reinforced brakes; Required quantity: 2; Fitting Position: Front Axle	2	11.8171-0008.1 990049	Brake System: ATE
1.7 D 1.7 TD	44 07/92→01/99 50 08/94→01/99	→ Construction year to: 09/98; Braking System: for vehicles with reinforced brakes; Required quantity: 2	2	11.8171-0008.1 990049	Brake System: ATE
		→ Construction year to: 09/98; Braking System: not for vehicles with reinforced brakes; Required quantity: 2; Fitting Position: Front Axle	2	11.8171-0008.1 990049	Brake System: ATE
OPEL - ASTRA F Hatchback (T92) 09/91→02/98					
Guide Sleeve Kit, brake caliper					
1.4 1.8 i 2.0 GSI 16V 2.0 i	55 09/91→09/93 66 09/91→01/98 110 09/91→01/98 85 09/91→01/98	Construction year from: 10/91 →; Fitting Position: Front Axle		11.0101-5407.2 260011	Brake System: ATE
1.4	60 09/92→01/98	→ Construction year to: 07/95; Fitting Position: Front Axle		11.0101-5407.2 260011	Brake System: ATE
		Construction year from: 08/95 →; Fitting Position: Front Axle		11.0101-5407.2 260011	Brake System: ATE
1.4 i 1.6 i 16V 1.6 Si 1.7 D 1.7 TD 1.7 TDS 1.8 i 16V 2.0 i 16V	44 09/91→01/98 74 08/94→01/98 74 03/92→12/94 42 - 12/91→01/98 44 50 11/94→01/98 60 12/91→01/98 85 - 06/93→01/98 92 100 02/95→01/98	Fitting Position: Front Axle		11.0101-5407.2 260011	Brake System: ATE
1.4 i 16V 1.4 Si	66 09/96→02/98 60 03/92→01/98	Transmission Type: Manual Transmission; Braking System: not for vehicles with reinforced brakes; Fitting Position: Front Axle		11.0101-5407.2 260011	Brake System: ATE
		Transmission Type: Automatic Transmission; Braking System: not for vehicles with reinforced brakes; Fitting Position: Front Axle		11.0101-5407.2 260011	Brake System: ATE
		Braking System: for vehicles with reinforced brakes; Fitting Position: Front Axle		11.0101-5407.2 260011	Brake System: ATE
1.6 1.6 i	55 09/95→01/98 52 05/93→07/96	Fitting Position: Front Axle		11.0101-5407.2 260011	Brake System: ATE
		Transmission Type: Manual Transmission; Fitting Position: Front Axle		11.0101-5407.2 260011	Brake System: ATE
		Transmission Type: Automatic Transmission; Fitting Position: Front Axle		11.0101-5407.2 260011	Brake System: ATE
1.6 i	55 09/91→01/98	Construction year from: 10/91 →; Transmission Type: Automatic Transmission; Fitting Position: Front Axle		11.0101-5407.2 260011	Brake System: ATE
		Construction year from: 10/91 →; Transmission Type: Manual Transmission; Fitting Position: Front Axle		11.0101-5407.2 260011	Brake System: ATE
		Construction year from: 10/91 →; Fitting Position: Front Axle		11.0101-5407.2 260011	Brake System: ATE
Guide Bolt, brake caliper					
1.4	55 09/91→09/93	Construction year from: 10/91 →; Required quantity: 2; Fitting Position: Front Axle	2	11.8171-0008.1 990049	Brake System: ATE
1.4	60 09/92→01/98	Construction year from: 08/95 →; Required quantity: 2; Fitting Position: Front Axle	2	11.8171-0008.1 990049	Brake System: ATE
		→ Construction year to: 07/95; Required quantity: 2; Fitting Position: Front Axle	2	11.8171-0008.1 990049	Brake System: ATE
1.4 i 1.6 Si	44 09/91→01/98 74 03/92→12/94	Required quantity: 2; Fitting Position: Front Axle	2	11.8171-0008.1 990049	Brake System: ATE
1.4 i 16V 1.4 Si	66 09/96→02/98 60 03/92→01/98	Braking System: for vehicles with reinforced brakes; Required quantity: 2	2	11.8171-0008.1 990049	Brake System: ATE
		Transmission Type: Manual Transmission; Braking System: not for vehicles with reinforced brakes; Required quantity: 2; Fitting Position: Front Axle	2	11.8171-0008.1 990049	Brake System: ATE
		Transmission Type: Automatic Transmission;	2	11.8171-0008.1 990049	Brake System: ATE

→

	kW				
OPEL - ASTRA F Hatchback (T92) 09/91→02/98					
Guide Bolt, brake caliper					
1.4 i 16V 1.4 Si	66 09/96→02/98 60 03/92→01/98	Braking System: not for vehicles with reinforced brakes; Required quantity: 2; Fitting Position: Front Axle			
1.6 1.6 i	55 09/95→01/98 52 05/93→07/96	Required quantity: 2	2	11.8171-0008.1 990049	Brake System: ATE
		Transmission Type: Manual Transmission; Required quantity: 2; Fitting Position: Front Axle	2	11.8171-0008.1 990049	Brake System: ATE
		Transmission Type: Automatic Transmission; Required quantity: 2; Fitting Position: Front Axle	2	11.8171-0008.1 990049	Brake System: ATE
1.6 i	55 09/91→01/98	Construction year from: 10/91 →; Required quantity: 2	2	11.8171-0008.1 990049	Brake System: ATE
		Construction year from: 10/91 →; Transmission Type: Manual Transmission; Required quantity: 2; Fitting Position: Front Axle	2	11.8171-0008.1 990049	Brake System: ATE
		Construction year from: 10/91 →; Transmission Type: Automatic Transmission; Required quantity: 2; Fitting Position: Front Axle	2	11.8171-0008.1 990049	Brake System: ATE
1.6 i 16V	74 08/94→01/98	Required quantity: 2	2	11.8171-0008.1 990049	Brake System: ATE
		Required quantity: 2; Fitting Position: Front Axle	2	11.8171-0008.1 990049	Brake System: ATE
1.7 D 1.7 TD 1.7 TDS	42 - 12/91→01/98 44 50 11/94→01/98 60 12/91→01/98	Braking System: for vehicles with reinforced brakes; Required quantity: 2	2	11.8171-0008.1 990049	Brake System: ATE
		Braking System: not for vehicles with reinforced brakes; Required quantity: 2; Fitting Position: Front Axle	2	11.8171-0008.1 990049	Brake System: ATE
1.8 i	66 09/91→01/98	Construction year from: 10/91 →; Required quantity: 2	2	11.8171-0008.1 990049	Brake System: ATE
		Construction year from: 10/91 →; Required quantity: 2; Fitting Position: Front Axle	2	11.8171-0008.1 990049	Brake System: ATE
1.8 i 16V	85 - 06/93→01/98 92	Required quantity: 2	2	11.8171-0008.1 990049	Brake System: ATE
2.0 i 16V	100 02/95→01/98				
2.0 GSI 16V 2.0 i	110 09/91→01/98 85 09/91→01/98	Construction year from: 10/91 →; Required quantity: 2	2	11.8171-0008.1 990049	Brake System: ATE
OPEL - ASTRA G CLASSIC (T98) 03/04→07/09					
Brake Caliper Axle Kit					
1.4 16V 1.6 1.6 16V 1.7 CDTI	66 05/04→07/09 76 03/06→06/08 74 05/04→02/06 59 06/04→07/09	Fitting Position: Rear Axle		24.0530-0001.5 241269	Brake System: Lucas / TRW Supplementary Article/Supplementary Info: with holder
Guide Sleeve Kit, brake caliper					
1.4 16V 1.6 1.6 16V 1.7 CDTI	66 05/04→07/09 76 03/06→06/08 74 05/04→02/06 59 06/04→07/09	Fitting Position: Front Axle		11.0101-5407.2 260011	Brake System: ATE
Guide Bolt, brake caliper					
1.4 16V 1.6 1.6 16V 1.7 CDTI	66 05/04→07/09 76 03/06→06/08 74 05/04→02/06 59 06/04→07/09	Required quantity: 2; Fitting Position: Front Axle	2	11.8171-0008.1 990049	Brake System: ATE
OPEL - ASTRA G CLASSIC Caravan (F35) 03/04→07/09					
Brake Caliper Axle Kit					
1.4 1.4 16V 1.6 1.7 CDTI	66 10/07→07/09 66 07/04→09/07 74 - 06/04→07/09 76 59 05/04→07/09	Fitting Position: Rear Axle		24.0530-0001.5 241269	Brake System: Lucas / TRW Supplementary Article/Supplementary Info: with holder
Guide Sleeve Kit, brake caliper					
1.4 1.4 16V 1.6 1.7 CDTI	66 10/07→07/09 66 07/04→09/07 74 - 06/04→07/09 76 59 05/04→07/09	Fitting Position: Front Axle		11.0101-5407.2 260011	Brake System: ATE
Guide Bolt, brake caliper					
1.4 1.4 16V →	66 10/07→07/09 66 07/04→09/07	Required quantity: 2; Fitting Position: Front Axle	2	11.8171-0008.1 990049	Brake System: ATE

	kW				
OPEL - ASTRA G CLASSIC Caravan (F35) 03/04→07/09					
Guide Bolt, brake caliper					
1.6	74 - 06/04→07/09	Required quantity: 2;	2	11.8171-0008.1 990049	Brake System: ATE
	76	Fitting Position: Front Axle			
1.7 CDTI	59 05/04→07/09				
OPEL - ASTRA G CLASSIC Saloon (T98) 03/04→07/09					
Brake Caliper Axle Kit					
1.4 16V	66 05/04→07/09	Fitting Position: Rear Axle		24.0530-0001.5 241269	Brake System: Lucas / TRW
1.6 16V	74 03/04→01/08				Supplementary Article/Supplementary Info: with holder
Guide Sleeve Kit, brake caliper					
1.4 16V	66 05/04→07/09	Fitting Position: Front Axle		11.0101-5407.2 260011	Brake System: ATE
1.6 16V	74 03/04→01/08				
Guide Bolt, brake caliper					
1.4 16V	66 05/04→07/09	Required quantity: 2;	2	11.8171-0008.1 990049	Brake System: ATE
1.6 16V	74 03/04→01/08	Fitting Position: Front Axle			
OPEL - ASTRA G Convertible (T98) 03/01→10/05					
Guide Sleeve Kit, brake caliper					
1.6	76 01/03→10/05	Fitting Position: Front Axle		11.0101-5407.2 260011	Brake System: ATE
1.6 16V	74 03/01→10/05				
1.8 16V	92 03/01→10/05				
2.0 16V Turbo	147 11/02→10/05				
2.0 OPC	141 03/02→10/05				
2.2 16V	108 03/01→10/05				
2.2 DTI	92 09/02→10/05				
Guide Bolt, brake caliper					
1.6	76 01/03→10/05	Required quantity: 2;	2	11.8171-0008.1 990049	Brake System: ATE
1.6 16V	74 03/01→10/05	Fitting Position: Front Axle			
1.8 16V	92 03/01→10/05				
2.2 16V	108 03/01→10/05				
2.2 DTI	92 09/02→10/05				
2.0 16V Turbo	147 11/02→10/05	Required quantity: 2	2	11.8171-0008.1 990049	Brake System: ATE
2.0 OPC	141 03/02→10/05				
OPEL - ASTRA G Coupe (T98) 03/00→05/05					
Brake Caliper Axle Kit					
1.6 16V	74 - 03/00→05/05	Fitting Position: Rear Axle		24.0530-0001.5 241269	Brake System: Lucas / TRW
	76				Supplementary Article/Supplementary Info: with holder
Guide Sleeve Kit, brake caliper					
1.6 16V	74 - 03/00→05/05	Fitting Position: Front Axle		11.0101-5407.2 260011	Brake System: ATE
	76				
1.8 16V	85 - 03/00→05/05				
	92				
2.0 16V Turbo	140 - 09/00→05/05				
	147				
2.2 16V	108 09/00→05/05				
2.2 DTI	92 09/02→05/05				
Guide Bolt, brake caliper					
1.6 16V	74 - 03/00→05/05	Required quantity: 2;	2	11.8171-0008.1 990049	Brake System: ATE
	76	Fitting Position: Front Axle			
1.8 16V	85 - 03/00→05/05				
	92				
2.0 16V Turbo	140 - 09/00→05/05				
	141				
2.2 16V	108 09/00→05/05				
2.2 DTI	92 09/02→05/05				
2.0 16V Turbo	147 11/02→05/05	Required quantity: 2	2	11.8171-0008.1 990049	Brake System: ATE
OPEL - ASTRA G Estate (T98) 02/98→07/04					
Brake Caliper Axle Kit					
1.2 16V	48 - 02/98→07/04	Fitting Position: Rear Axle		24.0530-0001.5 241269	Brake System: Lucas / TRW
	55				Supplementary Article/Supplementary Info: with holder
1.4 16V	66 06/98→07/04				
1.4 LPG	66 03/98→07/04				
1.6	55 - 02/98→07/04				
	76				
1.6 16V	74 02/98→07/04				
1.6 LPG	74 - 03/98→07/04				
	76				
1.7 CDTI	59 04/03→05/04				
1.7 DTI 16V	55 02/00→07/04				
→					

	kW							
OPEL - ASTRA G Estate (T98) 02/98→07/04								
Brake Caliper Axle Kit								
1.7 TD	50	02/98→08/00	Fitting Position: Rear Axle	24.0530-0001.5 241269	Brake System: Lucas / TRW Supplementary Article/Supplementary Info: with holder			
1.8 16V	85	02/98→07/04	- ABS; Fitting Position: Rear Axle	24.0530-0001.5 241269	Brake System: Lucas / TRW Supplementary Article/Supplementary Info: with holder			
2.0 DI	60	02/98→07/04						
Guide Sleeve Kit, brake caliper								
1.2 16V	48	02/98→09/00	Construction year from: 04/98 →; → Vehicle Identification Number to: 18999999; Braking System: for vehicles with drum brakes on the rear axle; Fitting Position: Front Axle	11.0101-5407.2 260011	Brake System: ATE			
			Vehicle Identification Number from: 22000001 →; Fitting Position: Front Axle	11.0101-5407.2 260011	Brake System: ATE			
1.2 16V	55	09/00→07/04	Vehicle Identification Number from: 22000001 →; Fitting Position: Front Axle	11.0101-5407.2 260011	Brake System: ATE			
			→ Vehicle Identification Number to: 18999999; Braking System: for vehicles with drum brakes on the rear axle; Fitting Position: Front Axle	11.0101-5407.2 260011	Brake System: ATE			
1.4 16V	66	06/98→07/04	Fitting Position: Front Axle	11.0101-5407.2 260011	Brake System: ATE			
1.4 LPG	66	03/98→07/04						
1.6	62	09/00→07/04						
	76							
1.6 CNG	71	03/03→07/04						
1.6 LPG	74	03/98→07/04						
	76							
1.7 CDTI	59	04/03→05/04						
1.7 DTI 16V	55	02/00→07/04						
1.8 16V	92	09/00→07/04						
2.0 DTI 16V	74	08/99→07/04						
2.0 OPC	141	09/02→07/04						
	147							
2.2 16V	108	03/01→07/04						
2.2 DTI	86	09/02→07/04						
	92							
1.6	55	02/98→09/00				Construction year from: 04/98 →; Fitting Position: Front Axle	11.0101-5407.2 260011	Brake System: ATE
1.6 16V	74	02/98→07/04						
1.7 TD	50	02/98→08/00						
1.8 16V	85	02/98→09/00						
2.0 16V	100	02/98→07/04						
2.0 DI	60	02/98→07/04						
Guide Bolt, brake caliper								
1.2 16V	48	02/98→09/00	Construction year from: 04/98 →; → Vehicle Identification Number to: 18999999; Braking System: for vehicles with drum brakes on the rear axle; Required quantity: 2; Fitting Position: Front Axle	2 11.8171-0008.1 990049	Brake System: ATE			
			Vehicle Identification Number from: 22000001 →; Required quantity: 2; Fitting Position: Front Axle	2 11.8171-0008.1 990049	Brake System: ATE			
1.2 16V	55	09/00→07/04	→ Vehicle Identification Number to: 18999999; Braking System: for vehicles with drum brakes on the rear axle; Required quantity: 2; Fitting Position: Front Axle	2 11.8171-0008.1 990049	Brake System: ATE			
			Vehicle Identification Number from: 22000001 →; Required quantity: 2; Fitting Position: Front Axle	2 11.8171-0008.1 990049	Brake System: ATE			
1.4 16V	66	06/98→07/04	Required quantity: 2; Fitting Position: Front Axle	2 11.8171-0008.1 990049	Brake System: ATE			
1.4 LPG	66	03/98→07/04						
1.6	62	09/00→07/04						
	76							
1.6 CNG	71	03/03→07/04						
1.6 LPG	74	03/98→07/04						
	76							
1.7 CDTI	59	04/03→05/04						
1.7 DTI 16V	55	02/00→07/04						
1.8 16V	92	09/00→07/04						
2.0 DTI 16V	74	08/99→07/04						
2.2 16V	108	03/01→07/04						
2.2 DTI	86	09/02→07/04						
	92							
→								



	kW				
OPEL - ASTRA G Hatchback (T98) 02/98→12/09					
Guide Sleeve Kit, brake caliper					
1.2 16V	48	02/98→09/00	Construction year from: 04/98 →; → Vehicle Identification Number to: 18999999; Braking System: for vehicles with drum brakes on the rear axle; Fitting Position: Front Axle	11.0101-5407.2	260011 Brake System: ATE
			Vehicle Identification Number from: 22000001 →; Fitting Position: Front Axle	11.0101-5407.2	260011 Brake System: ATE
1.2 16V	55	09/00→01/05	Vehicle Identification Number from: 22000001 →; Fitting Position: Front Axle	11.0101-5407.2	260011 Brake System: ATE
			→ Vehicle Identification Number to: 18999999; Braking System: for vehicles with drum brakes on the rear axle; Fitting Position: Front Axle	11.0101-5407.2	260011 Brake System: ATE
1.4 1.6	66 62 - 76	09/07→12/09 09/00→01/05	Fitting Position: Front Axle	11.0101-5407.2	260011 Brake System: ATE
1.6 LPG	76	11/02→06/07			
1.7 CDTI	59	04/03→01/05			
1.7 DTI 16V	55	02/00→01/05			
1.8	81	02/03→01/04			
1.8 16V	92	09/00→01/05			
2.0 16V OPC	118	11/99→09/02			
2.0 DTI 16V	74	08/99→01/05			
2.0 OPC	141 - 147	09/02→01/05			
2.2 DTI	86 - 92	09/02→01/05			
1.4 16V 1.4 LPG 1.6 1.6 16V 1.6 LPG 1.7 TD 1.8 16V 2.0 16V 2.0 DI	66 66 55 74 74 50 85 100 60	02/98→01/05 02/98→01/05 02/98→09/00 02/98→01/05 03/98→01/05 02/98→08/00 02/98→09/00 02/98→01/05 02/98→01/05	Construction year from: 04/98 →; Fitting Position: Front Axle	11.0101-5407.2	260011 Brake System: ATE
2.2 16V	108	06/00→01/05	Construction year from: 09/00 →; Fitting Position: Front Axle	11.0101-5407.2	260011 Brake System: ATE
Guide Bolt, brake caliper					
1.2 16V	48	02/98→09/00	Construction year from: 04/98 →; → Vehicle Identification Number to: 18999999; Braking System: for vehicles with drum brakes on the rear axle; Required quantity: 2; Fitting Position: Front Axle	2 11.8171-0008.1	990049 Brake System: ATE
			Vehicle Identification Number from: 22000001 →; Required quantity: 2; Fitting Position: Front Axle	2 11.8171-0008.1	990049 Brake System: ATE
1.2 16V	55	09/00→01/05	→ Vehicle Identification Number to: 18999999; Braking System: for vehicles with drum brakes on the rear axle; Required quantity: 2; Fitting Position: Front Axle	2 11.8171-0008.1	990049 Brake System: ATE
			Vehicle Identification Number from: 22000001 →; Required quantity: 2; Fitting Position: Front Axle	2 11.8171-0008.1	990049 Brake System: ATE
1.4 1.6	66 62 - 76	09/07→12/09 09/00→01/05	Required quantity: 2; Fitting Position: Front Axle	2 11.8171-0008.1	990049 Brake System: ATE
1.6 LPG	76	11/02→06/07			
1.7 CDTI	59	04/03→01/05			
1.7 DTI 16V	55	02/00→01/05			
1.8	81	02/03→01/04			
1.8 16V	92	09/00→01/05			
2.0 DTI 16V	74	08/99→01/05			
2.2 DTI	86 - 92	09/02→01/05			
1.4 16V 1.4 LPG 1.6 1.6 16V 1.6 LPG 1.7 TD 1.8 16V 2.0 16V 2.0 DI	66 66 55 74 74 50 85 100 60	02/98→01/05 02/98→01/05 02/98→09/00 02/98→01/05 03/98→01/05 02/98→08/00 02/98→09/00 02/98→01/05 02/98→01/05	Construction year from: 04/98 →; Required quantity: 2; Fitting Position: Front Axle	2 11.8171-0008.1	990049 Brake System: ATE
→					



	kW				
OPEL - ASTRA G Hatchback (T98) 02/98→12/09					
Guide Bolt, brake caliper					
2.0 16V OPC 2.0 OPC	118 11/99→09/02 141 - 09/02→01/05 147	Required quantity: 2	2	11.8171-0008.1 990049	Brake System: ATE
2.2 16V	108 06/00→01/05	Construction year from: 09/00 →; Required quantity: 2; Fitting Position: Front Axle	2	11.8171-0008.1 990049	Brake System: ATE
OPEL - ASTRA G Saloon (T98) 03/98→12/09					
Brake Caliper Axle Kit					
1.2 16V 1.4 1.4 16V 1.4 LPG 1.6 1.6 16V 1.6 LPG 1.7 CDTI 1.7 DTI 16V 1.7 TD 1.8 16V 2.0 DI	48 - 09/98→01/05 55 66 09/07→12/09 66 09/98→01/05 66 03/98→01/05 55 - 09/98→12/09 76 74 09/98→01/05 55 - 10/98→01/05 74 59 04/03→12/09 55 02/00→01/05 50 09/98→08/00 85 - 09/98→01/05 92 60 09/98→01/05	Fitting Position: Rear Axle - ABS; Fitting Position: Rear Axle		24.0530-0001.5 241269	Brake System: Lucas / TRW Supplementary Article/Supplementary Info: with holder Brake System: Lucas / TRW Supplementary Article/Supplementary Info: with holder
Guide Sleeve Kit, brake caliper					
1.2 16V	48 - 09/98→01/05 55	Vehicle Identification Number from: 22000001 →; Fitting Position: Front Axle		11.0101-5407.2 260011	Brake System: ATE
		→ Vehicle Identification Number to: 18999999; Braking System: for vehicles with drum brakes on the rear axle; Fitting Position: Front Axle		11.0101-5407.2 260011	Brake System: ATE
1.4 1.4 16V 1.4 LPG 1.6 1.6 16V 1.6 LPG 1.7 CDTI 1.7 DTI 16V 1.7 TD 1.8 16V 2.0 16V 2.0 DI 2.0 DTI 16V 2.2 16V 2.2 DTI	66 09/07→12/09 66 09/98→01/05 66 03/98→01/05 55 - 09/98→12/09 76 74 09/98→01/05 55 - 10/98→01/05 74 59 04/03→12/09 55 02/00→01/05 50 09/98→08/00 85 - 09/98→01/05 92 100 09/98→01/05 60 09/98→01/05 74 08/99→01/05 108 03/01→01/05 86 - 09/02→01/05 92	Fitting Position: Front Axle		11.0101-5407.2 260011	Brake System: ATE
Guide Bolt, brake caliper					
1.2 16V	48 - 09/98→01/05 55	→ Vehicle Identification Number to: 18999999; Braking System: for vehicles with drum brakes on the rear axle; Required quantity: 2; Fitting Position: Front Axle	2	11.8171-0008.1 990049	Brake System: ATE
		Vehicle Identification Number from: 22000001 →; Required quantity: 2; Fitting Position: Front Axle	2	11.8171-0008.1 990049	Brake System: ATE
1.4 1.4 16V 1.4 LPG 1.6 1.6 16V 1.6 LPG 1.7 CDTI 1.7 DTI 16V 1.7 TD 1.8 16V 2.0 16V 2.0 DI 2.0 DTI 16V 2.2 16V →	66 09/07→12/09 66 09/98→01/05 66 03/98→01/05 55 - 09/98→12/09 76 74 09/98→01/05 55 - 10/98→01/05 74 59 04/03→12/09 55 02/00→01/05 50 09/98→08/00 85 - 09/98→01/05 92 100 09/98→01/05 60 09/98→01/05 74 08/99→01/05 108 03/01→01/05	Required quantity: 2; Fitting Position: Front Axle	2	11.8171-0008.1 990049	Brake System: ATE



	kW				
OPEL - ASTRA G Saloon (T98) 03/98→12/09					
Guide Bolt, brake caliper					
2.2 DTI	86 - 09/02→01/05 92	Required quantity: 2; Fitting Position: Front Axle	2	11.8171-0008.1 990049	Brake System: ATE
OPEL - ASTRA H (A04) 01/04→05/14					
Spring, brake caliper					
2.0 Turbo	177 03/05→10/10	Required quantity: 2	2	11.8116-0356.1 390586	Brake System: ATE
Guide Sleeve Kit, brake caliper					
1.2	59 08/05→10/10	Fitting Position: Front Axle		11.0101-5407.2 260011	Brake System: ATE
1.3 CDTI	66 08/05→10/10				
1.4	55 - 03/04→10/10 66				
1.4 LPG	66 08/09→10/10				
1.6	77 03/04→10/10				
1.6 Turbo	132 02/07→10/10				
1.7 CDTI	59 - 03/04→10/10 74				
1.8	92 - 01/04→10/10 103				
1.9 CDTI	74 - 09/04→10/10 110				
2.0 Turbo	125 - 03/04→10/10 177				
1.6	85 12/06→05/14	Construction year from: 01/07 → → Construction year to: 11/10; Fitting Position: Front Axle		11.0101-5407.2 260011	Brake System: ATE
1.7 CDTI	81 - 02/07→05/14 92	Construction year from: 04/07 → → Construction year to: 11/10; Fitting Position: Front Axle		11.0101-5407.2 260011	Brake System: ATE
1.9 CDTI	88 06/04→10/10	Construction year from: 09/04 →;		11.0101-5407.2 260011	Brake System: ATE
1.9 CDTI 16V	88 04/04→10/10	Fitting Position: Front Axle			
Guide Bolt, brake caliper					
1.2	59 08/05→10/10	Required quantity: 2	2	11.8171-0008.1 990049	Brake System: ATE
1.3 CDTI	66 08/05→10/10				
1.4	55 - 03/04→10/10 66				
1.4 LPG	66 08/09→10/10				
1.6	77 03/04→10/10				
1.6 Turbo	132 02/07→10/10				
1.7 CDTI	59 - 03/04→10/10 74				
1.8	92 - 01/04→10/10 103				
1.9 CDTI	74 - 09/04→10/10 110				
2.0 Turbo	125 - 03/04→10/10 177				
1.6	85 12/06→05/14	Construction year from: 01/07 → → Construction year to: 11/10; Required quantity: 2	2	11.8171-0008.1 990049	Brake System: ATE
1.7 CDTI	81 - 02/07→05/14 92	Construction year from: 04/07 → → Construction year to: 11/10; Required quantity: 2	2	11.8171-0008.1 990049	Brake System: ATE
1.9 CDTI	88 06/04→10/10	Construction year from: 09/04 →;	2	11.8171-0008.1 990049	Brake System: ATE
1.9 CDTI 16V	88 04/04→10/10	Required quantity: 2			
OPEL - ASTRA H CLASSIC Estate (A04) 12/06→					
Guide Sleeve Kit, brake caliper					
1.4	66 01/09→	Fitting Position: Front Axle		11.0101-5407.2 260011	Brake System: ATE
1.7 CDTi	81 01/09→				
1.7 CDTI	92 01/09→				
1.8	103 01/12→05/14				
1.6	85 12/06→05/14	Construction year from: 01/07 → → Construction year to: 11/10; Fitting Position: Front Axle		11.0101-5407.2 260011	Brake System: ATE
Guide Bolt, brake caliper					
1.4	66 01/09→	Required quantity: 2;	2	11.8171-0008.1 990049	Brake System: ATE
1.7 CDTi	81 01/09→	Fitting Position: Front Axle			
1.7 CDTI	92 01/09→				
1.8	103 01/12→05/14				
1.6	85 12/06→05/14	Construction year from: 01/07 → → Construction year to: 11/10; Required quantity: 2; Fitting Position: Front Axle	2	11.8171-0008.1 990049	Brake System: ATE



	kW				
OPEL - ASTRA H CLASSIC Hatchback (A04) 01/09→					
Guide Sleeve Kit, brake caliper					
1.3 CDTI	66 01/09→	→ Construction year to: 11/10;		11.0101-5407.2 260011	Brake System: ATE
1.6	85 01/09→	Fitting Position: Front Axle			
1.4	66 01/09→	Fitting Position: Front Axle		11.0101-5407.2 260011	Brake System: ATE
1.7 CDTI	81 - 01/09→				
	92				
1.8	103 02/13→				
Guide Bolt, brake caliper					
1.3 CDTI	66 01/09→	→ Construction year to: 11/10;	2	11.8171-0008.1 990049	Brake System: ATE
1.6	85 01/09→	Required quantity: 2			
1.4	66 01/09→	Required quantity: 2	2	11.8171-0008.1 990049	Brake System: ATE
1.7 CDTI	81 - 01/09→				
	92				
1.8	103 02/13→				
OPEL - ASTRA H CLASSIC Saloon (A04) 02/07→					
Guide Sleeve Kit, brake caliper					
1.6	85 01/09→05/14	Fitting Position: Front Axle		11.0101-5407.2 260011	Brake System: ATE
1.7 CDTI	81 01/09→				
1.7 CDTI	92 01/09→				
1.8	103 02/07→09/12				
Guide Bolt, brake caliper					
1.6	85 01/09→05/14	Required quantity: 2	2	11.8171-0008.1 990049	Brake System: ATE
1.7 CDTI	81 01/09→				
1.7 CDTI	92 01/09→				
1.8	103 02/07→09/12				
OPEL - ASTRA H Estate (A04) 08/04→05/14					
Guide Sleeve Kit, brake caliper					
1.3 CDTI	66 08/05→10/10	Fitting Position: Front Axle		11.0101-5407.2 260011	Brake System: ATE
1.4	55 - 08/04→10/10				
	66				
1.4 LPG	66 08/09→10/10				
1.6	77 08/04→10/10				
1.6 LPG	85 08/09→10/10				
1.6 Turbo	132 02/07→10/10				
1.7 CDTI	59 - 08/04→10/10				
	74				
1.8	103 08/05→05/14				
1.9 CDTI	74 - 09/04→10/10				
	110				
1.9 CDTI 16V	88 08/04→10/10				
2.0 Turbo	125 - 08/04→10/10				
	147				
1.6	85 12/06→05/14	Construction year from: 01/07 → → Construction year to: 11/10; Fitting Position: Front Axle		11.0101-5407.2 260011	Brake System: ATE
1.7 CDTI	81 - 02/07→05/14 92	Construction year from: 04/07 → → Construction year to: 11/10; Fitting Position: Front Axle		11.0101-5407.2 260011	Brake System: ATE
1.8	92 08/04→10/10	Construction year from: 09/04 → ; Fitting Position: Front Axle		11.0101-5407.2 260011	Brake System: ATE
Guide Bolt, brake caliper					
1.3 CDTI	66 08/05→10/10	Required quantity: 2;	2	11.8171-0008.1 990049	Brake System: ATE
1.4	55 - 08/04→10/10	Fitting Position: Front Axle			
	66				
1.4 LPG	66 08/09→10/10				
1.6	77 08/04→10/10				
1.6 LPG	85 08/09→10/10				
1.6 Turbo	132 02/07→10/10				
1.7 CDTI	59 - 08/04→10/10				
	74				
1.8	103 08/05→05/14				
1.9 CDTI	74 - 09/04→10/10				
	110				
1.9 CDTI 16V	88 08/04→10/10				
2.0 Turbo	125 - 08/04→10/10				
	147				
1.6	85 12/06→05/14	Construction year from: 01/07 → → Construction year to: 11/10; Required quantity: 2; Fitting Position: Front Axle	2	11.8171-0008.1 990049	Brake System: ATE
1.7 CDTI	81 - 02/07→05/14 92	Construction year from: 04/07 → → Construction year to: 11/10; Required quantity: 2; Fitting Position: Front Axle	2	11.8171-0008.1 990049	Brake System: ATE
→					

	kW				
OPEL - ASTRA H GTC (A04) 03/05→10/10					
Guide Bolt, brake caliper					
1.6	85 12/06→10/10	Construction year from: 01/07 →; Required quantity: 2	2	11.8171-0008.1 990049	Brake System: ATE
1.7 CDTi	81 - 02/07→10/10 92	Construction year from: 04/07 →; Required quantity: 2	2	11.8171-0008.1 990049	Brake System: ATE
OPEL - ASTRA H Saloon (A04) 02/07→05/14					
Guide Sleeve Kit, brake caliper					
1.3 CDTi	66 02/07→10/10	Fitting Position: Front Axle		11.0101-5407.2 260011	Brake System: ATE
1.4	66 02/07→06/10				
1.6	77 02/07→06/10				
1.7 CDTi	74 02/07→10/10				
1.8	103 02/07→09/12				
1.6	85 02/07→05/14	→ Construction year to: 11/10; Fitting Position: Front Axle		11.0101-5407.2 260011	Brake System: ATE
1.7 CDTi	81 02/07→05/14	Construction year from: 04/07 → → Construction year to: 11/10; Fitting Position: Front Axle		11.0101-5407.2 260011	Brake System: ATE
Guide Bolt, brake caliper					
1.3 CDTi	66 02/07→10/10	Required quantity: 2	2	11.8171-0008.1 990049	Brake System: ATE
1.4	66 02/07→06/10				
1.6	77 02/07→06/10				
1.7 CDTi	74 02/07→10/10				
1.8	103 02/07→09/12				
1.6	85 02/07→05/14	→ Construction year to: 11/10; Required quantity: 2	2	11.8171-0008.1 990049	Brake System: ATE
1.7 CDTi	81 02/07→05/14	Construction year from: 04/07 → → Construction year to: 11/10; Required quantity: 2	2	11.8171-0008.1 990049	Brake System: ATE
OPEL - ASTRA H TwinTop (A04) 09/05→10/10					
Guide Sleeve Kit, brake caliper					
1.4	66 10/05→10/10	Construction year from: 03/06 →;		11.0101-5407.2 260011	Brake System: ATE
1.6	77 09/05→10/10	Fitting Position: Front Axle			
1.8	92 - 09/05→10/10 103				
1.9 CDTi	110 09/05→10/10				
2.0 Turbo	125 - 09/05→10/10 147				
1.6	85 12/06→10/10	Fitting Position: Front Axle		11.0101-5407.2 260011	Brake System: ATE
1.6 Turbo	132 02/07→10/10				
Guide Bolt, brake caliper					
1.4	66 10/05→10/10	Construction year from: 03/06 →;	2	11.8171-0008.1 990049	Brake System: ATE
1.6	77 09/05→10/10	Required quantity: 2			
1.8	92 - 09/05→10/10 103				
1.9 CDTi	110 09/05→10/10				
2.0 Turbo	125 - 09/05→10/10 147				
1.6	85 12/06→10/10	Required quantity: 2	2	11.8171-0008.1 990049	Brake System: ATE
1.6 Turbo	132 02/07→10/10				
OPEL - ASTRA J (P10) 09/09→10/15					
	Brake Disc				
1.3 CDTi	70 12/09→10/15	Fitting Position: Front Axle		24.0326-0165.1 526165	Outer diameter [mm]: 276 Brake Disc Thickness [mm] 26 Minimum thickness [mm] 23 Brake Disc Type: Vented Supplementary Article/Info 2: with bolts/screws
1.4	64 - 12/09→10/15 74				
1.4 LPG	103 01/12→10/15				
1.4 Turbo	103 12/09→10/15				
1.6	85 12/09→10/15				
1.6 CDTi	81 - 11/13→10/15 100			24.0326-0166.1 526166	Outer diameter [mm]: 300 Brake Disc Thickness [mm] 26 Minimum thickness [mm] 23 Brake Disc Type: Vented Supplementary Article/Info 2: with bolts/screws
1.6 SIDI	125 12/12→10/15				
1.6 Turbo	132 12/09→10/15				
1.7 CDTi	81 - 09/09→10/15 96				
2.0 BiTurbo CDTi	143 09/12→10/15				
2.0 CDTi	96 - 09/09→10/15 121	Fitting Position: Rear Axle		24.0312-0188.1 512188	Outer diameter [mm]: 268 Brake Disc Thickness [mm] 12 Minimum thickness [mm] 10 Brake Disc Type: Solid Supplementary Article/Info 2: with bolts/screws
→					

		kW					
OPEL - ASTRA J (P10) 09/09→10/15							
 Brake Disc							
1.3 CDTi 1.4	70 12/09→10/15 64 - 12/09→10/15 74	Fitting Position: Rear Axle		24.0312-0189.1 512189	Outer diameter [mm]: 292 Brake Disc Thickness [mm] 12 Minimum thickness [mm] 10 Brake Disc Type: Solid Supplementary Article/Info 2: with bolts/screws		
1.4 LPG 1.4 Turbo 1.6 1.6 CDTi 1.6 SIDI 1.6 Turbo 1.7 CDTi 2.0 BiTurbo CDTi 2.0 CDTi	103 01/12→10/15 103 12/09→10/15 85 12/09→10/15 81 - 11/13→10/15 100 125 12/12→10/15 132 12/09→10/15 81 - 09/09→10/15 96 143 09/12→10/15 96 - 09/09→10/15 121						
1.4 Turbo	88 10/10→10/15	Construction year from: 11/10 →; Fitting Position: Front Axle		24.0326-0165.1 526165	Outer diameter [mm]: 276 Brake Disc Thickness [mm] 26 Minimum thickness [mm] 23 Brake Disc Type: Vented Supplementary Article/Info 2: with bolts/screws		
				24.0326-0166.1 526166	Outer diameter [mm]: 300 Brake Disc Thickness [mm] 26 Minimum thickness [mm] 23 Brake Disc Type: Vented Supplementary Article/Info 2: with bolts/screws		
		Construction year from: 11/10 →; Fitting Position: Rear Axle		24.0312-0188.1 512188	Outer diameter [mm]: 268 Brake Disc Thickness [mm] 12 Minimum thickness [mm] 10 Brake Disc Type: Solid Supplementary Article/Info 2: with bolts/screws		
				24.0312-0189.1 512189	Outer diameter [mm]: 292 Brake Disc Thickness [mm] 12 Minimum thickness [mm] 10 Brake Disc Type: Solid Supplementary Article/Info 2: with bolts/screws		
 Brake Hose							
1.3 CDTi 1.4	70 12/09→10/15 64 - 12/09→10/15 74	Number of Doors: 3; Fitting Position: Front Axle Left		24.5176-0673.3 331651	Length [mm]: 685		
1.4 LPG 1.4 Turbo 1.6 1.6 CDTi 1.6 SIDI 1.6 Turbo 1.6 Turbo 4x4 1.7 CDTi 2.0 CDTi	103 01/12→10/15 103 12/09→10/15 85 12/09→10/15 81 02/14→10/15 125 12/12→10/15 132 12/09→10/15 132 12/09→10/15 92 - 12/09→10/15 96 96 - 06/11→10/15 121						
1.4 Turbo	88 10/10→10/15	Construction year from: 11/10 →; Number of Doors: 3; Fitting Position: Front Axle Left		24.5176-0673.3 331651	Length [mm]: 685		
1.6 CDTi	100 11/13→10/15	Construction year from: 01/14 →; Number of Doors: 3; Fitting Position: Front Axle Left		24.5176-0673.3 331651	Length [mm]: 685		
1.7 CDTi 2.0 CDTi	81 09/09→10/15 118 09/09→10/15	Construction year from: 12/09 →; Number of Doors: 3; Fitting Position: Front Axle Left		24.5176-0673.3 331651	Length [mm]: 685		
2.0 BiTurbo CDTi	143 09/12→10/15	Construction year from: 12/12 →; Number of Doors: 3; Fitting Position: Front Axle Left		24.5176-0673.3 331651	Length [mm]: 685		
OPEL - ASTRA J Estate Van (P10) 09/09→10/15							
 Brake Caliper							
1.3 CDTi 1.6 CDTi 1.7 CDTi 2.0 CDTi	70 10/12→10/15 81 01/14→10/15 96 10/12→10/15 121 10/12→10/15	Vehicle Equipment: for vehicles with electric parking brake; Fitting Position: Rear Axle Left		24.3402-7003.5 241457	Brake System: ATE Supplementary Article/Supplementary Info: without holder Brake Caliper Type: Fist-type Caliper		
		Vehicle Equipment: for vehicles with electric parking brake; Fitting Position: Rear Axle Right		24.3402-7004.5 241458	Brake System: ATE Supplementary Article/Supplementary Info: without holder Brake Caliper Type: Fist-type Caliper		

	kW			
OPEL - ASTRA J GTC 10/11→				
 Brake Disc				
1.4	74 - 10/11→ 103	Fitting Position: Front Axle	24.0326-0165.1 526165	Outer diameter [mm]: 276 Brake Disc Thickness [mm] 26 Minimum thickness [mm] 23 Brake Disc Type: Vented Supplementary Article/Info 2: with bolts/screws
1.6	132 10/11→			
1.6 CDTI	81 - 07/14→ 100			
1.6 SIDI	125 - 12/12→ 147			
1.7 CDTI	81 - 10/11→10/15 96			
1.8 2.0 CDTI	103 10/11→10/15 121 10/11→10/15			
		Fitting Position: Rear Axle	24.0312-0188.1 512188	Outer diameter [mm]: 268 Brake Disc Thickness [mm] 12 Minimum thickness [mm] 10 Brake Disc Type: Solid Supplementary Article/Info 2: with bolts/screws
			24.0312-0189.1 512189	Outer diameter [mm]: 292 Brake Disc Thickness [mm] 12 Minimum thickness [mm] 10 Brake Disc Type: Solid Supplementary Article/Info 2: with bolts/screws
2.0 BiTurbo CDTI	143 10/12→10/15	Construction year from: 12/12 →; Fitting Position: Front Axle	24.0326-0165.1 526165	Outer diameter [mm]: 276 Brake Disc Thickness [mm] 26 Minimum thickness [mm] 23 Brake Disc Type: Vented Supplementary Article/Info 2: with bolts/screws
		Construction year from: 12/12 →; Fitting Position: Rear Axle	24.0312-0188.1 512188	Outer diameter [mm]: 268 Brake Disc Thickness [mm] 12 Minimum thickness [mm] 10 Brake Disc Type: Solid Supplementary Article/Info 2: with bolts/screws
			24.0312-0189.1 512189	Outer diameter [mm]: 292 Brake Disc Thickness [mm] 12 Minimum thickness [mm] 10 Brake Disc Type: Solid Supplementary Article/Info 2: with bolts/screws
 Brake Hose				
1.4	74 - 10/11→ 103	Number of Doors: 3; Fitting Position: Front Axle Left	24.5176-0673.3 331651	Length [mm]: 685
1.6	132 10/11→			
1.6 CDTI	81 - 07/14→ 100			
1.6 SIDI	125 - 12/12→ 147			
1.7 CDTI	81 - 10/11→10/15 96			
1.8 2.0 CDTI	103 10/11→10/15 96 - 10/11→10/15 121			
2.0 BiTurbo CDTI	143 10/12→10/15	Construction year from: 12/12 →; Number of Doors: 3; Fitting Position: Front Axle Left	24.5176-0673.3 331651	Length [mm]: 685
OPEL - ASTRA J Saloon 06/12→				
 Brake Disc				
1.3 CDTI	70 06/12→10/15	Fitting Position: Front Axle	24.0326-0165.1 526165	Outer diameter [mm]: 276 Brake Disc Thickness [mm] 26 Minimum thickness [mm] 23 Brake Disc Type: Vented Supplementary Article/Info 2: with bolts/screws
1.4	74 06/12→10/15			
1.4 LPG	103 07/14→			
1.4 Turbo	103 06/12→			
1.6	85 06/12→			
1.6 CDTi	81 - 01/14→ 100			
1.6 SIDI	125 06/12→10/15			
1.6 Turbo	132 06/12→			
1.7 CDTI	74 - 06/12→10/15 96			
→				

	kW				
OPEL - ASTRA J Saloon 06/12→					
 Brake Disc					
1.3 CDTI 1.4 1.4 LPG 1.4 Turbo 1.6 1.6 CDTi	70 06/12→10/15 74 06/12→10/15 103 07/14→ 103 06/12→ 85 06/12→ 81 - 01/14→ 100	Fitting Position: Front Axle	24.0326-0166.1 526166	Outer diameter [mm]: 300 Brake Disc Thickness [mm] 26 Minimum thickness [mm] 23 Brake Disc Type: Vented Supplementary Article/Info 2: with bolts/screws	
1.6 SIDI 1.6 Turbo 1.7 CDTI	125 06/12→10/15 132 06/12→ 74 - 06/12→10/15 96	Fitting Position: Rear Axle	24.0312-0188.1 512188 24.0312-0189.1 512189	Outer diameter [mm]: 268 Brake Disc Thickness [mm] 12 Minimum thickness [mm] 10 Brake Disc Type: Solid Supplementary Article/Info 2: with bolts/screws Outer diameter [mm]: 292 Brake Disc Thickness [mm] 12 Minimum thickness [mm] 10 Brake Disc Type: Solid Supplementary Article/Info 2: with bolts/screws	
 Brake Hose					
1.3 CDTI 1.4 1.4 LPG 1.4 Turbo 1.6 1.6 CDTi 1.6 SIDI 1.6 Turbo 1.7 CDTI	70 06/12→10/15 64 - 06/12→10/15 74 103 07/14→ 88 - 06/12→ 103 85 06/12→ 81 - 01/14→ 100 125 06/12→10/15 132 06/12→ 74 - 06/12→10/15 96	Number of Doors: 3; Fitting Position: Front Axle Left	24.5176-0673.3 331651	Length [mm]: 685	
OPEL - ASTRA J Sports Tourer (P10) 10/10→10/15					
 Brake Caliper					
1.3 CDTI 1.4 1.4 Turbo 1.6 1.6 Turbo 1.7 CDTI 2.0 CDTI	70 10/10→10/14 64 - 10/10→10/15 74 88 - 10/10→10/15 103 85 10/10→10/15 132 10/10→10/15 74 - 10/10→10/15 96 118 10/10→10/15	Construction year from: 11/10 →; Vehicle Equipment: for vehicles with electric parking brake; Fitting Position: Rear Axle Left	24.3402-7003.5 241457	Brake System: ATE Supplementary Article/Supplementary Info: without holder Brake Caliper Type: Fist-type Caliper	
		Construction year from: 11/10 →; Vehicle Equipment: for vehicles with electric parking brake; Fitting Position: Rear Axle Right	24.3402-7004.5 241458	Brake System: ATE Supplementary Article/Supplementary Info: without holder Brake Caliper Type: Fist-type Caliper	
1.4 LPG	103 12/11→10/15	Construction year from: 01/12 →; Vehicle Equipment: for vehicles with electric parking brake; Fitting Position: Rear Axle Left	24.3402-7003.5 241457	Brake System: ATE Supplementary Article/Supplementary Info: without holder Brake Caliper Type: Fist-type Caliper	
		Construction year from: 01/12 →; Vehicle Equipment: for vehicles with electric parking brake; Fitting Position: Rear Axle Right	24.3402-7004.5 241458	Brake System: ATE Supplementary Article/Supplementary Info: without holder Brake Caliper Type: Fist-type Caliper	
1.6 CDTi 1.6 SIDI 2.0 CDTI	81 02/14→10/15 125 12/12→10/15 96 - 08/11→10/15 121	Vehicle Equipment: for vehicles with electric parking brake; Fitting Position: Rear Axle Left	24.3402-7003.5 241457	Brake System: ATE Supplementary Article/Supplementary Info: without holder Brake Caliper Type: Fist-type Caliper	
		Vehicle Equipment: for vehicles with electric parking brake; Fitting Position: Rear Axle Right	24.3402-7004.5 241458	Brake System: ATE Supplementary Article/Supplementary Info: without holder Brake Caliper Type: Fist-type Caliper	
1.6 CDTi	100 11/13→10/15	Construction year from: 01/14 →; Vehicle Equipment: for vehicles with electric parking brake; Fitting Position: Rear Axle Left	24.3402-7003.5 241457	Brake System: ATE Supplementary Article/Supplementary Info: without holder Brake Caliper Type: Fist-type Caliper	
		Construction year from: 01/14 →; Vehicle Equipment: for vehicles with electric parking brake; Fitting Position: Rear Axle Right	24.3402-7004.5 241458	Brake System: ATE Supplementary Article/Supplementary Info: without holder Brake Caliper Type: Fist-type Caliper	
→					

	kW				
OPEL - ASTRA J Sports Tourer (P10) 10/10→10/15					
 Brake Caliper					
2.0 BiTurbo CDTI	143	09/12→10/15	Construction year from: 12/12 →; Vehicle Equipment: for vehicles with electric parking brake; Fitting Position: Rear Axle Left	24.3402-7003.5 241457	Brake System: ATE Supplementary Article/Supplementary Info: without holder Brake Caliper Type: Fist-type Caliper
			Construction year from: 12/12 →; Vehicle Equipment: for vehicles with electric parking brake; Fitting Position: Rear Axle Right	24.3402-7004.5 241458	Brake System: ATE Supplementary Article/Supplementary Info: without holder Brake Caliper Type: Fist-type Caliper
 Brake Disc					
1.3 CDTI	70	10/10→10/14	Construction year from: 11/10 →; Fitting Position: Front Axle	24.0326-0165.1 526165	Outer diameter [mm]: 276 Brake Disc Thickness [mm] 26 Minimum thickness [mm] 23 Brake Disc Type: Vented Supplementary Article/Info 2: with bolts/screws
1.4	74	10/10→10/15			
1.4 Turbo	88 - 103	10/10→10/15			
1.6	85	10/10→10/15			
1.6 Turbo	132	10/10→10/15			
1.7 CDTI	74 - 96	10/10→10/15			
2.0 CDTI	118	10/10→10/15			
				24.0312-0189.1 512189	Outer diameter [mm]: 292 Brake Disc Thickness [mm] 12 Minimum thickness [mm] 10 Brake Disc Type: Solid Supplementary Article/Info 2: with bolts/screws
1.4 LPG	103	12/11→10/15	Fitting Position: Front Axle	24.0326-0165.1 526165	Outer diameter [mm]: 276 Brake Disc Thickness [mm] 26 Minimum thickness [mm] 23 Brake Disc Type: Vented Supplementary Article/Info 2: with bolts/screws
1.6 CDTi	81 - 100	11/13→10/15			
1.6 SIDI	125	12/12→10/15			
2.0 BiTurbo CDTI	143	09/12→10/15			
2.0 CDTI	121	08/11→10/15			
				24.0312-0189.1 512189	Outer diameter [mm]: 292 Brake Disc Thickness [mm] 12 Minimum thickness [mm] 10 Brake Disc Type: Solid Supplementary Article/Info 2: with bolts/screws
OPEL - ASTRA K (B16) 06/15→					
Guide Sleeve Kit, brake caliper					
1.0 Turbo	66 - 77	06/15→	Fitting Position: Front Axle	11.0101-5407.2 260011	Brake System: ATE
1.2 Turbo	81 - 107	08/19→			
1.4	74	06/15→			
1.4 CNG	81	10/17→			
1.4 Turbo	92 - 110	06/15→			
1.5 CRDI	77 - 90	08/19→			
1.6 BiTurbo	110	08/18→			
1.6 CDTi	70 - 118	06/15→			
1.6 Turbo	147	11/15→			
→					



	kW				
OPEL - ASTRA K (B16) 06/15→					
Guide Bolt, brake caliper					
1.0 Turbo	66 - 06/15→ 77	Fitting Position: Front Axle		11.8171-0008.1 990049	Brake System: ATE
1.4	74 06/15→				
1.4 CNG	81 10/17→				
1.4 Turbo	92 - 06/15→ 110				
1.6 BiTurbo	110 08/18→				
1.6 CDTi	70 - 06/15→ 118				
1.6 Turbo	147 11/15→				
OPEL - ASTRA K Estate Van 11/15→					
Guide Sleeve Kit, brake caliper					
1.0	77 05/18→	Fitting Position: Front Axle		11.0101-5407.2 260011	Brake System: ATE
1.4	110 06/18→				
1.5 CRDI	77 08/19→				
Guide Bolt, brake caliper					
1.0	77 05/18→	Fitting Position: Front Axle		11.8171-0008.1 990049	Brake System: ATE
OPEL - ASTRA K Hatchback Van 06/15→					
Guide Sleeve Kit, brake caliper					
1.6 CDTi	100 04/18→	Fitting Position: Front Axle		11.0101-5407.2 260011	Brake System: ATE
Guide Bolt, brake caliper					
1.6 CDTi	100 04/18→	Fitting Position: Front Axle		11.8171-0008.1 990049	Brake System: ATE
OPEL - ASTRA K Sports Tourer (B16) 11/15→					
Guide Sleeve Kit, brake caliper					
1.0 Turbo	66 - 11/15→ 77	Fitting Position: Front Axle		11.0101-5407.2 260011	Brake System: ATE
1.2 Turbo	81 - 08/19→ 107				
1.4	74 11/15→				
1.4 CNG	81 10/17→				
1.4 Turbo	92 - 11/15→ 110				
1.5 CRDI	77 - 08/19→ 90				
1.6 BiTurbo	110 08/18→				
1.6 CDTi	70 - 11/15→ 118				
1.6 Turbo	147 11/15→				
Guide Bolt, brake caliper					
1.0 Turbo	66 - 11/15→ 77	Fitting Position: Front Axle		11.8171-0008.1 990049	Brake System: ATE
1.4	74 11/15→				
1.4 CNG	81 10/17→				
1.4 Turbo	92 - 11/15→ 110				
1.6 BiTurbo	110 08/18→				
1.6 CDTi	70 - 11/15→ 118				
1.6 Turbo	147 11/15→				
OPEL - CALIBRA A (C89) 08/89→07/97					
Guide Sleeve Kit, brake caliper					
2.0 i	85 08/89→12/96	Fitting Position: Front Axle		11.0101-5407.2 260011	Brake System: ATE
2.0 i 16V	100 - 06/90→07/97 110				
2.0 i 16V 4x4	100 - 06/90→07/97 110				
2.0 i 4x4	85 06/90→07/97				
2.0 i Turbo 4x4	150 08/91→07/97	Vehicle Identification Number from:		11.0101-5407.2 260011	Brake System: ATE
2.5 i V6	125 04/93→07/97	T1000001 →; Fitting Position: Front Axle			
		→ Vehicle Identification Number to: S9999999; Fitting Position: Front Axle		11.0101-5407.2 260011	Brake System: ATE
Guide Bolt, brake caliper					
2.0 i	85 08/89→12/96	Required quantity: 2		2 11.8171-0008.1 990049	Brake System: ATE
2.0 i 16V	100 - 06/90→07/97 110				
2.0 i 16V 4x4	100 - 06/90→07/97 110	Required quantity: 2; Fitting Position: Front Axle		2 11.8171-0008.1 990049	Brake System: ATE
2.0 i 4x4	85 06/90→07/97				
→					



	kW				
OPEL - COMBO Box Body/MPV (K9) 06/18→					
Guide Bolt, brake caliper					
1.6 D	55 - 06/18→ 73	Fitting Position: Front Axle		11.8171-0008.1 990049	Brake System: ATE
Combo-e	100 07/21→				
OPEL - COMBO E Tour / Life (K9) 06/18→					
Guide Sleeve Kit, brake caliper					
1.2	81 - 06/18→ 96	Fitting Position: Front Axle		11.0101-5407.2 260011	Brake System: ATE
1.5	56 - 06/18→ 96				
Combo-e	100 06/21→				
Guide Bolt, brake caliper					
1.2	81 - 06/18→ 96	Fitting Position: Front Axle		11.8171-0008.1 990049	Brake System: ATE
1.5	56 - 06/18→ 96				
Combo-e	100 06/21→				
OPEL - COMBO Tour 10/01→12/11					
Guide Sleeve Kit, brake caliper					
1.3 CDTI 16V	51 06/04→01/11	Vehicle Identification Number from:		11.0101-5407.2 260011	Brake System: ATE
1.6	62 - 10/01→09/06 64	43033899, 53000001 →; Payload: for increased payload; Fitting Position: Front Axle			
1.7 DI 16V	48 10/01→06/04				
1.7 DTI 16V	55 10/01→06/04				
1.3 CDTI 16V	55 10/05→12/11	Vehicle Identification Number from:		11.0101-5407.2 260011	Brake System: ATE
1.4	66 10/04→12/11	43033899, 53000001 →; → Construction year to: 10/11; Payload: for increased payload; Fitting Position: Front Axle			
1.6 CNG	69 06/06→12/11	→ Construction year to: 10/11;		11.0101-5407.2 260011	Brake System: ATE
1.7 CDTI 16V	74 07/04→12/11	Fitting Position: Front Axle			
1.6 CNG	71 04/05→01/11	Fitting Position: Front Axle		11.0101-5407.2 260011	Brake System: ATE
Guide Bolt, brake caliper					
1.3 CDTI 16V	51 06/04→01/11	Vehicle Identification Number from:	2	11.8171-0008.1 990049	Brake System: ATE
1.6	62 - 10/01→09/06 64	43033899, 53000001 →; Payload: for increased payload; Required quantity: 2			
1.7 DI 16V	48 10/01→06/04				
1.7 DTI 16V	55 10/01→06/04				
1.3 CDTI 16V	55 10/05→12/11	Vehicle Identification Number from:	2	11.8171-0008.1 990049	Brake System: ATE
1.4	66 10/04→12/11	43033899, 53000001 →; → Construction year to: 10/11; Payload: for increased payload; Required quantity: 2			
1.6 CNG	69 06/06→12/11	→ Construction year to: 10/11;	2	11.8171-0008.1 990049	Brake System: ATE
1.7 CDTI 16V	74 07/04→12/11	Required quantity: 2			
1.6 CNG	71 04/05→01/11	Required quantity: 2	2	11.8171-0008.1 990049	Brake System: ATE
OPEL - CORSA A Hatchback (S83) 09/82→03/93					
Guide Sleeve Kit, brake caliper					
1.0	33 09/82→03/93	Vehicle Identification Number from:		11.0101-5407.2 260011	Brake System: ATE
1.2 i	33 09/89→03/93	N4000001 →;			
1.2 N	38 01/90→03/93	→ Construction year to: 10/92;			
1.4 i	40 - 01/85→03/93 44	Fitting Position: Front Axle			
1.4 S	53 01/90→03/93				
1.4 Si	60 09/91→03/93				
1.5 D	37 09/87→03/93				
1.5 TD	49 03/88→03/93				
1.6 GSI	72 09/89→03/93				
1.6 GSI Cat	74 02/92→03/93				
1.2	33 - 09/82→08/90 44	Vehicle Identification Number from:		11.0101-5407.2 260011	Brake System: ATE
1.2 S	40 09/82→02/90	N4000001 →; Fitting Position: Front Axle			
1.6 GSI	55 - 05/88→09/92 74				
Guide Bolt, brake caliper					
1.0	33 09/82→03/93	Vehicle Identification Number from:	2	11.8171-0008.1 990049	Brake System: ATE
1.2 i	33 09/89→03/93	N4000001 →;			
1.2 N	38 01/90→03/93	→ Construction year to: 10/92;			
1.4 i	40 - 01/85→03/93 44	Required quantity: 2; Fitting Position: Front Axle			
1.4 S	53 01/90→03/93				
1.4 Si	60 09/91→03/93				
1.5 D	37 09/87→03/93				
→					



	kW				
OPEL - CORSA A Hatchback (S83) 09/82→03/93					
Guide Bolt, brake caliper					
1.5 TD 1.6 GSI 1.6 GSI Cat	49 03/88→03/93 72 09/89→03/93 74 02/92→03/93	Vehicle Identification Number from: N4000001 →; → Construction year to: 10/92; Required quantity: 2; Fitting Position: Front Axle	2	11.8171-0008.1 990049	Brake System: ATE
1.2 1.2 S 1.6 GSI	33 - 09/82→08/90 44 40 09/82→02/90 55 - 05/88→09/92 74	Vehicle Identification Number from: N4000001 →; Required quantity: 2; Fitting Position: Front Axle	2	11.8171-0008.1 990049	Brake System: ATE
OPEL - CORSA A Hatchback Van (S83) 02/86→09/94					
Guide Sleeve Kit, brake caliper					
1.0 1.2 1.5 D	33 02/86→04/89 33 - 02/86→07/90 44 37 06/87→04/89	Vehicle Identification Number from: N4000001 →; Fitting Position: Front Axle		11.0101-5407.2 260011	Brake System: ATE
Guide Bolt, brake caliper					
1.0 1.2 1.5 D	33 02/86→04/89 33 - 02/86→07/90 44 37 06/87→04/89	Vehicle Identification Number from: N4000001 →; Required quantity: 2; Fitting Position: Front Axle	2	11.8171-0008.1 990049	Brake System: ATE
OPEL - CORSA A TR (S83) 09/82→03/93					
Guide Sleeve Kit, brake caliper					
1.0 1.2 N 1.2 S	33 09/82→09/92 33 01/85→10/87 43 09/82→10/87	Vehicle Identification Number from: N4000001 →; Fitting Position: Front Axle		11.0101-5407.2 260011	Brake System: ATE
1.2 i 1.2 S 1.4 i 1.4 S 1.5 D 1.5 TD	33 09/89→03/93 40 09/82→03/93 44 10/89→03/93 53 09/89→03/93 37 10/87→11/92 49 10/87→03/93	Vehicle Identification Number from: N4000001 →; → Construction year to: 10/92; Fitting Position: Front Axle		11.0101-5407.2 260011	Brake System: ATE
Guide Bolt, brake caliper					
1.0 1.2 N 1.2 S	33 09/82→09/92 33 01/85→10/87 43 09/82→10/87	Vehicle Identification Number from: N4000001 →; Required quantity: 2; Fitting Position: Front Axle	2	11.8171-0008.1 990049	Brake System: ATE
1.2 i 1.2 S 1.4 i 1.4 S 1.5 D 1.5 TD	33 09/89→03/93 40 09/82→03/93 44 10/89→03/93 53 09/89→03/93 37 10/87→11/92 49 10/87→03/93	Vehicle Identification Number from: N4000001 →; → Construction year to: 10/92; Required quantity: 2; Fitting Position: Front Axle	2	11.8171-0008.1 990049	Brake System: ATE
OPEL - CORSA B (S93) 03/93→12/02					
Guide Sleeve Kit, brake caliper					
1.0 i 12V 1.4 i 16V 1.4 Si 1.5 D 1.5 TD 1.6 i 16V 1.7 D	40 11/96→09/00 66 09/94→09/00 60 03/93→09/00 37 03/93→09/00 49 03/93→09/00 74 - 09/94→09/00 78 44 02/96→09/00	Fitting Position: Front Axle		11.0101-5407.2 260011	Brake System: ATE
1.2 i	33 03/93→09/00	Transmission Type: Manual Transmission; Vehicle Equipment: for vehicles without sports package; Fitting Position: Front Axle		11.0101-5407.2 260011	Brake System: ATE
		Transmission Type: Automatic Transmission; Vehicle Equipment: for vehicles without sports package; Fitting Position: Front Axle		11.0101-5407.2 260011	Brake System: ATE
1.2 i 16V	48 03/98→09/00	Construction year from: 04/98 →; Vehicle Equipment: for vehicles without sports package; Fitting Position: Front Axle		11.0101-5407.2 260011	Brake System: ATE
		Construction year from: 04/98 →; Vehicle Equipment: for vehicles with sports package; Fitting Position: Front Axle		11.0101-5407.2 260011	Brake System: ATE
		Construction year from: 04/98 →; Transmission Type: Automatic Transmission; Vehicle Equipment: for vehicles without		11.0101-5407.2 260011	Brake System: ATE

→

	kW				
OPEL - CORSA B (S93) 03/93→12/02					
Guide Sleeve Kit, brake caliper					
1.2 i 16V	48	03/98→09/00	sports package; Fitting Position: Front Axle		
			Construction year from: 04/98 →; Transmission Type: Manual Transmis- sion; Vehicle Equipment: for vehicles without sports package; Fitting Position: Front Axle	11.0101-5407.2	260011 Brake System: ATE
1.4 i	40 - 44	03/93→09/00	Transmission Type: Manual Transmis- sion;	11.0101-5407.2	260011 Brake System: ATE
1.4 i 16V	63	08/97→09/00	Vehicle Equipment: for vehicles without sports package; Fitting Position: Front Axle		
			Transmission Type: Automatic Transmis- sion; Vehicle Equipment: for vehicles without sports package; Fitting Position: Front Axle	11.0101-5407.2	260011 Brake System: ATE
			Vehicle Equipment: for vehicles with sports package; Fitting Position: Front Axle	11.0101-5407.2	260011 Brake System: ATE
1.6 GSI 16V	80	03/93→09/00	Construction year from: 09/93 →; Fitting Position: Front Axle	11.0101-5407.2	260011 Brake System: ATE
Guide Bolt, brake caliper					
1.0 i 12V	40	11/96→09/00	Required quantity: 2;	2	11.8171-0008.1 990049 Brake System: ATE
1.4 i 16V	66	09/94→09/00	Fitting Position: Front Axle		
1.4 Si	60	03/93→09/00			
1.5 D	37	03/93→09/00			
1.5 TD	49	03/93→09/00			
1.6 i 16V	74 - 78	09/94→09/00			
1.7 D	44	02/96→09/00			
1.2 i	33	03/93→09/00	Transmission Type: Automatic Transmis- sion; Required quantity: 2; Vehicle Equipment: for vehicles without sports package; Fitting Position: Front Axle	2	11.8171-0008.1 990049 Brake System: ATE
			Transmission Type: Manual Transmis- sion; Required quantity: 2; Vehicle Equipment: for vehicles without sports package; Fitting Position: Front Axle	2	11.8171-0008.1 990049 Brake System: ATE
1.2 i 16V	48	03/98→09/00	Construction year from: 04/98 →; Required quantity: 2; Vehicle Equipment: for vehicles without sports package; Fitting Position: Front Axle	2	11.8171-0008.1 990049 Brake System: ATE
			Construction year from: 04/98 →; Required quantity: 2; Vehicle Equipment: for vehicles with sports package; Fitting Position: Front Axle	2	11.8171-0008.1 990049 Brake System: ATE
			Construction year from: 04/98 →; Transmission Type: Manual Transmis- sion; Required quantity: 2; Vehicle Equipment: for vehicles without sports package; Fitting Position: Front Axle	2	11.8171-0008.1 990049 Brake System: ATE
			Construction year from: 04/98 →; Transmission Type: Automatic Transmis- sion; Required quantity: 2; Vehicle Equipment: for vehicles without sports package; Fitting Position: Front Axle	2	11.8171-0008.1 990049 Brake System: ATE
1.4 i	40 - 44	03/93→09/00	Required quantity: 2; Vehicle Equipment: for vehicles with sports package; Fitting Position: Front Axle	2	11.8171-0008.1 990049 Brake System: ATE
1.4 i 16V	63	08/97→09/00	Transmission Type: Automatic Transmis- sion; Required quantity: 2; Vehicle Equipment: for vehicles without sports package; Fitting Position: Front Axle	2	11.8171-0008.1 990049 Brake System: ATE
			Transmission Type: Manual Transmis- sion; Required quantity: 2; Vehicle Equipment: for vehicles without sports package; Fitting Position: Front Axle	2	11.8171-0008.1 990049 Brake System: ATE
→					





	kW				
OPEL - CORSA E (X15) 09/14→					
Guide Sleeve Kit, brake caliper					
1.4	55 - 09/14→ 66	Construction year from: 11/14 →; for brake disc diameter [mm]: 308; Fitting Position: Front Axle		11.0101-5407.2 260011	Brake System: ATE
1.4 Turbo	74 09/14→06/19				
1.4 LPG	64 - 03/15→ 66	for brake disc diameter [mm]: 308; Fitting Position: Front Axle		11.0101-5407.2 260011	Brake System: ATE
1.4 Turbo	110 03/15→				
Guide Bolt, brake caliper					
1.0	66 - 09/14→ 85	Construction year from: 11/14 →; for brake disc diameter [mm]: 308; Required quantity: 2	2	11.8171-0008.1 990049	Brake System: ATE
1.2	51 09/14→				
1.3 CDTI	55 - 09/14→ 70				
1.4	55 - 09/14→ 66				
1.4 Turbo	74 09/14→06/19				
1.4 LPG	64 - 03/15→ 66	for brake disc diameter [mm]: 308; Required quantity: 2	2	11.8171-0008.1 990049	Brake System: ATE
1.4 Turbo	110 03/15→				
 Cable Pull, parking brake					
1.0	66 - 09/14→ 85	Required quantity: 1; Brake Type: Disc Brake; Fitting Position: Rear	1	24.3727-3503.2 583503	Length [mm]: 1,453 Length 2 [mm]: 1,468
1.2	51 09/14→				
1.3 CDTI	55 - 09/14→ 70				
1.4	55 - 09/14→ 66				
1.4 LPG	64 - 03/15→ 66				
1.4 Turbo	74 - 09/14→ 110				
1.6 Turbo	152 03/15→				
OPEL - CORSA E Hatchback Van (X15) 09/14→					
Spring, brake caliper					
1.2	51 01/15→	for brake disc diameter [mm]: 284; Required quantity: 2; Fitting Position: Front Axle	2	11.8116-0356.1 390586	Brake System: ATE
1.3 CDTI	55 01/15→				
1.3 CDTI	70 09/14→	Construction year from: 11/14 →; for brake disc diameter [mm]: 284; Required quantity: 2; Fitting Position: Front Axle	2	11.8116-0356.1 390586	Brake System: ATE
1.4	55 - 09/14→ 66				
Guide Sleeve Kit, brake caliper					
1.2	51 01/15→	for brake disc diameter [mm]: 308; Fitting Position: Front Axle		11.0101-5407.2 260011	Brake System: ATE
1.3 CDTI	55 01/15→				
1.3 CDTI	70 09/14→	Construction year from: 11/14 →; for brake disc diameter [mm]: 308; Fitting Position: Front Axle		11.0101-5407.2 260011	Brake System: ATE
1.4	55 - 09/14→ 66				
Guide Bolt, brake caliper					
1.2	51 01/15→	for brake disc diameter [mm]: 308; Required quantity: 2	2	11.8171-0008.1 990049	Brake System: ATE
1.3 CDTI	55 01/15→				
1.3 CDTI	70 09/14→	Construction year from: 11/14 →; for brake disc diameter [mm]: 308; Required quantity: 2	2	11.8171-0008.1 990049	Brake System: ATE
1.4	55 - 09/14→ 66				
 Cable Pull, parking brake					
1.2	51 01/15→	Required quantity: 1; Brake Type: Disc Brake; Fitting Position: Rear	1	24.3727-3503.2 583503	Length [mm]: 1,453 Length 2 [mm]: 1,468
1.3 CDTI	55 - 09/14→ 70				
1.4	55 - 09/14→ 66				
OPEL - GRANDLAND / GRANDLAND X (A18, P1UO) 06/17→					
Guide Sleeve Kit, brake caliper					
1.2	96 06/17→	for brake disc diameter [mm]: 304; → for RPO number (vehicle manufacturing date) up to: 16246; Fitting Position: Front Axle		11.0101-5407.2 260011	Brake System: ATE
1.5 Turbo D	75 - 04/18→ 96				
1.6 Turbo	110 - 09/18→ 133				
1.6 Turbo D	88 06/17→				
1.6 Turbo Hybrid	133 - 12/19→ 165				
1.6 Turbo Hybrid4	147 - 06/19→ 221				
2.0 D	130 11/17→				
→					





	kW			
OPEL - GRANDLAND / GRANDLAND X (A18, P1UO) 06/17→				
Guide Bolt, brake caliper				
1.2	96 06/17→			
1.5 Turbo D	75 - 04/18→ 96	for brake disc diameter [mm]: 304; → for RPO number (vehicle manufacturing date) up to: 16246; Fitting Position: Front Axle	11.8171-0008.1 990049	Brake System: ATE
1.6 Turbo	110 - 09/18→ 133			
1.6 Turbo D	88 06/17→			
1.6 Turbo Hybrid	133 - 12/19→ 165			
1.6 Turbo Hybrid4	147 - 06/19→ 221			
2.0 D	130 11/17→			
OPEL - GRANDLAND X Van 06/17→				
Guide Sleeve Kit, brake caliper				
1.2	96 04/18→			
1.5	96 04/18→	for brake disc diameter [mm]: 304; → for RPO number (vehicle manufacturing date) up to: 16246; Fitting Position: Front Axle	11.0101-5407.2 260011	Brake System: ATE
2.0 CDTI	130 11/17→			
Guide Bolt, brake caliper				
1.2	96 04/18→			
1.5	96 04/18→	for brake disc diameter [mm]: 304; → for RPO number (vehicle manufacturing date) up to: 16246; Fitting Position: Front Axle	11.8171-0008.1 990049	Brake System: ATE
2.0 CDTI	130 11/17→			
OPEL - INSIGNIA A (G09) 07/08→03/17				
 Brake Caliper				
1.4	103 04/11→03/17	Construction year from: 06/11 →; for brake disc diameter [mm]: 304; Fitting Position: Front Axle Left	24.3421-1723.5 241449	Supplementary Article/Supplementary Info: without holder Brake Caliper Type: Fist-type Caliper
1.4 LPG	103 07/12→03/17			
1.6	85 07/08→03/17	for brake disc diameter [mm]: 337; Fitting Position: Front Axle Left	24.3421-1723.5 241449	Supplementary Article/Supplementary Info: without holder Brake Caliper Type: Fist-type Caliper
1.6 CDTi	88 - 07/15→03/17 100			
1.6 SIDI	125 03/13→03/17			
1.8	103 07/08→03/17			
2.0 Biturbo CDTI	140 - 07/08→03/17 143			
2.0 Biturbo CDTI 4x4	140 - 05/09→03/17 143			
2.0 CDTI	81 - 07/08→03/17 125			
2.0 CDTI 4x4	118 - 06/10→03/17 125			
2.0 E85 Turbo	162 10/10→03/17			
2.0 Turbo	162 - 07/08→03/17 184			
2.0 Turbo 4x4	162 07/08→03/17			
2.8 V6 Turbo 4x4	191 07/08→03/17			
1.6 Turbo	132 07/08→03/17	Construction year from: 10/08 →; for brake disc diameter [mm]: 337; Fitting Position: Front Axle Left	24.3421-1723.5 241449	Supplementary Article/Supplementary Info: without holder Brake Caliper Type: Fist-type Caliper
2.0 CDTI	88 03/12→03/17	Construction year from: 03/13 →; for brake disc diameter [mm]: 337; Fitting Position: Front Axle Left	24.3421-1723.5 241449	Supplementary Article/Supplementary Info: without holder Brake Caliper Type: Fist-type Caliper
2.0 CDTI	103 06/13→03/17	Construction year from: 07/13 →; for brake disc diameter [mm]: 337; Fitting Position: Front Axle Left	24.3421-1723.5 241449	Supplementary Article/Supplementary Info: without holder Brake Caliper Type: Fist-type Caliper
2.0 Turbo 4x4	184 07/11→03/17	Construction year from: 09/11 →; for brake disc diameter [mm]: 337; Fitting Position: Front Axle Left	24.3421-1723.5 241449	Supplementary Article/Supplementary Info: without holder Brake Caliper Type: Fist-type Caliper
OPEL - INSIGNIA A Country Tourer (G09) 07/08→03/17				
 Brake Caliper				
1.6 CDTi	88 - 07/15→03/17 100	for brake disc diameter [mm]: 337; Fitting Position: Front Axle Left	24.3421-1723.5 241449	Supplementary Article/Supplementary Info: without holder Brake Caliper Type: Fist-type Caliper
1.6 SIDI	125 07/14→03/17			
2.0 CDTi	88 - 07/08→03/17 125			
2.0 CDTi 4x4	120 - 09/13→03/17 143			
2.0 Turbo 4x4	184 09/13→03/17			



	kW				
OPEL - INSIGNIA A Saloon (G09) 07/08→03/17					
 Brake Caliper					
1.4	103	04/11→03/17	Construction year from: 06/11 →; for brake disc diameter [mm]: 337; Fitting Position: Front Axle Left	24.3421-1723.5 241449	Supplementary Article/Supplementary Info: without holder Brake Caliper Type: Fist-type Caliper
1.4 LPG 1.6 1.6 CDTi 1.6 SIDI 1.8 2.0 Biturbo CDTI 2.0 Biturbo CDTI 4x4 2.0 CDTI 2.0 CDTI 4x4 2.0 Turbo 2.0 Turbo 4x4 2.0 Turbo E85 2.8 V6 Turbo 4x4	103 85 88 125 103 140 140 81 118 162 162 162 191	07/12→03/17 07/08→03/17 07/15→03/17 03/13→03/17 07/08→03/17 07/08→03/17 07/08→03/17 07/08→03/17 06/10→03/17 07/08→03/17 07/08→03/17 07/08→03/17 07/08→03/17	for brake disc diameter [mm]: 337; Fitting Position: Front Axle Left	24.3421-1723.5 241449	Supplementary Article/Supplementary Info: without holder Brake Caliper Type: Fist-type Caliper
1.6 Turbo	132	07/08→03/17	Construction year from: 10/08 →; for brake disc diameter [mm]: 337; Fitting Position: Front Axle Left	24.3421-1723.5 241449	Supplementary Article/Supplementary Info: without holder Brake Caliper Type: Fist-type Caliper
2.0 CDTI	88	03/12→03/17	Construction year from: 03/13 →; for brake disc diameter [mm]: 337; Fitting Position: Front Axle Left	24.3421-1723.5 241449	Supplementary Article/Supplementary Info: without holder Brake Caliper Type: Fist-type Caliper
2.0 CDTI	103	06/13→03/17	Construction year from: 07/13 →; for brake disc diameter [mm]: 337; Fitting Position: Front Axle Left	24.3421-1723.5 241449	Supplementary Article/Supplementary Info: without holder Brake Caliper Type: Fist-type Caliper
2.0 Turbo 4x4	184	07/11→03/17	Construction year from: 09/11 →; for brake disc diameter [mm]: 337; Fitting Position: Front Axle Left	24.3421-1723.5 241449	Supplementary Article/Supplementary Info: without holder Brake Caliper Type: Fist-type Caliper
OPEL - INSIGNIA A Sports Tourer (G09) 07/08→03/17					
 Brake Caliper					
1.4 1.4 LPG 1.6 1.6 CDTi 1.6 SIDI 1.6 Turbo 1.8 2.0 Biturbo CDTI 2.0 Biturbo CDTI 4x4 2.0 CDTI 2.0 CDTI 4x4 2.0 E85 Turbo 2.0 Turbo 2.0 Turbo 4x4 2.8 V6 Turbo 4x4	103 103 85 88 125 132 103 140 140 81 118 162 162 162 191	09/11→06/13 07/12→06/13 07/08→06/12 07/15→01/17 03/13→11/14 01/09→06/13 07/08→06/13 07/08→03/17 07/08→03/17 07/08→12/16 06/10→12/16 09/10→11/11 07/08→11/14 07/08→06/13 10/08→06/13	for brake disc diameter [mm]: 337; Fitting Position: Front Axle Left	24.3421-1723.5 241449	Supplementary Article/Supplementary Info: without holder Brake Caliper Type: Fist-type Caliper
2.0 CDTI	88	03/12→06/15	Construction year from: 03/13 →; for brake disc diameter [mm]: 337; Fitting Position: Front Axle Left	24.3421-1723.5 241449	Supplementary Article/Supplementary Info: without holder Brake Caliper Type: Fist-type Caliper
OPEL - KADETT E (T85) 09/84→12/93					
Guide Sleeve Kit, brake caliper					
1.8 1.8 i 2.0 i 2.0 i Cat →	84 66 85 85	09/87→08/90 09/84→05/92 09/87→05/92 03/87→05/92	for brake disc thickness [mm]: 24; Fitting Position: Front Axle	11.0101-5407.2 260011	Brake System: ATE

	kW				
OPEL - KADETT E (T85) 09/84→12/93					
Guide Bolt, brake caliper					
1.8	84	09/87→08/90	for brake disc thickness [mm]: 24;	2	11.8171-0008.1 990049 Brake System: ATE
1.8 i	66 - 09/84→05/92	85	Required quantity: 2		
2.0 i	85	09/87→05/92			
2.0 i Cat	85	03/87→05/92			
OPEL - KADETT E Convertible (T85) 10/86→02/93					
Guide Sleeve Kit, brake caliper					
2.0	110	09/90→05/92	→ Construction year to: 09/91;	11.0101-5407.2 260011	Brake System: ATE
2.0 GSi	115	09/90→05/92	for brake disc thickness [mm]: 24;		
2.0 i	85	10/86→02/93	Fitting Position: Front Axle		
2.0 i Cat	85	10/86→02/93			
Guide Bolt, brake caliper					
2.0	110	09/90→05/92	→ Construction year to: 09/91;	2	11.8171-0008.1 990049 Brake System: ATE
2.0 GSi	115	09/90→05/92	for brake disc thickness [mm]: 24;		
2.0 i	85	10/86→02/93	Required quantity: 2		
2.0 i Cat	85	10/86→02/93			
OPEL - KADETT E Estate (T85) 09/84→08/91					
Guide Sleeve Kit, brake caliper					
1.8 E	74	10/85→08/86	for brake disc thickness [mm]: 24;	11.0101-5407.2 260011	Brake System: ATE
1.8 i	66 - 09/84→08/91	85	Fitting Position: Front Axle		
2.0 i	85	09/87→08/91			
2.0 i Cat	85	09/87→08/91			
Guide Bolt, brake caliper					
1.8 E	74	10/85→08/86	for brake disc thickness [mm]: 24;	2	11.8171-0008.1 990049 Brake System: ATE
1.8 i	66 - 09/84→08/91	85	Required quantity: 2		
2.0 i	85	09/87→08/91			
2.0 i Cat	85	09/87→08/91			
OPEL - KADETT E Estate Van (T85) 08/84→09/93					
Guide Sleeve Kit, brake caliper					
1.8 i	66	08/84→09/92	→ Construction year to: 09/91;	11.0101-5407.2 260011	Brake System: ATE
			for brake disc thickness [mm]: 24;		
			Fitting Position: Front Axle		
Guide Bolt, brake caliper					
1.8 i	66	08/84→09/92	→ Construction year to: 09/91;	2	11.8171-0008.1 990049 Brake System: ATE
			for brake disc thickness [mm]: 24;		
			Required quantity: 2		
OPEL - KADETT E Hatchback (T85) 09/84→08/91					
Guide Sleeve Kit, brake caliper					
1.8 E	74	10/85→08/86	for brake disc thickness [mm]: 24;	11.0101-5407.2 260011	Brake System: ATE
1.8 GSi	85	09/84→08/86	Fitting Position: Front Axle		
1.8 i	66	06/85→08/91			
2.0 GSi 16V	110 - 12/87→08/91	115			
2.0 GSi 16V Cat	110	03/88→08/91			
2.0 GSi	85 - 09/86→08/91	95	Construction year from: 08/87 →;	11.0101-5407.2 260011	Brake System: ATE
2.0 GSi Cat	85	09/86→08/91	for brake disc thickness [mm]: 24;		
			Fitting Position: Front Axle		
Guide Bolt, brake caliper					
1.8 E	74	10/85→08/86	for brake disc thickness [mm]: 24;	2	11.8171-0008.1 990049 Brake System: ATE
1.8 GSi	85	09/84→08/86	Required quantity: 2		
1.8 i	66	06/85→08/91			
2.0 GSi 16V	110 - 12/87→08/91	115			
2.0 GSi 16V Cat	110	03/88→08/91			
2.0 GSi	85 - 09/86→08/91	95	Construction year from: 08/87 →;	2	11.8171-0008.1 990049 Brake System: ATE
2.0 GSi Cat	85	09/86→08/91	for brake disc thickness [mm]: 24;		
			Required quantity: 2		
OPEL - MERIVA A MPV (X03) 05/03→05/10					
Guide Sleeve Kit, brake caliper					
1.3 CDTI	51 - 09/03→05/10	55	Fitting Position: Front Axle	11.0101-5407.2 260011	Brake System: ATE
1.6	77	01/06→05/10			
1.6 16V	74	05/03→01/06			
1.7 CDTI	74 - 09/03→05/10	92			
1.7 DTI	55	09/03→05/10			
→					

	kW				
OPEL - MERIVA A MPV (X03) 05/03→05/10					
Guide Sleeve Kit, brake caliper					
1.8	92 05/03→05/10	Fitting Position: Front Axle		11.0101-5407.2 260011	Brake System: ATE
1.4 16V Twinport	66 07/04→05/10	Rim Hole Number: 5;		11.0101-5407.2 260011	Brake System: ATE
1.4 16V Twinport LPG	66 07/04→05/10	Fitting Position: Front Axle			
Guide Bolt, brake caliper					
1.3 CDTI	51 - 09/03→05/10	Required quantity: 2	2	11.8171-0008.1 990049	Brake System: ATE
	55				
1.6	77 01/06→05/10				
1.6 16V	74 05/03→01/06				
1.7 CDTI	74 - 09/03→05/10				
	92				
1.7 DTI	55 09/03→05/10				
1.8	92 05/03→05/10				
1.4 16V Twinport	66 07/04→05/10	Rim Hole Number: 5;	2	11.8171-0008.1 990049	Brake System: ATE
1.4 16V Twinport LPG	66 07/04→05/10	Required quantity: 2			
OPEL - MERIVA B MPV (S10) 06/10→03/17					
Guide Sleeve Kit, brake caliper					
1.3 CDTI	55 - 06/10→11/14	Fitting Position: Front Axle		11.0101-5407.2 260011	Brake System: ATE
	70				
1.4	74 - 06/10→03/17				
	103				
1.4 LPG	88 06/11→03/17				
1.6 CDTi	100 08/13→01/17				
1.6 CDTI	81 03/14→03/17				
1.7 CDTI	74 - 06/10→01/17				
	96				
1.6 CDTI	70 01/14→01/17	Construction year from: 03/14 →;	2	11.0101-5407.2 260011	Brake System: ATE
		Fitting Position: Front Axle			
Guide Bolt, brake caliper					
1.3 CDTI	55 - 06/10→11/14	Required quantity: 2	2	11.8171-0008.1 990049	Brake System: ATE
	70				
1.4	74 - 06/10→03/17				
	103				
1.4 LPG	88 06/11→03/17				
1.6 CDTi	100 08/13→01/17				
1.6 CDTI	81 03/14→03/17				
1.7 CDTI	74 - 06/10→01/17				
	96				
1.6 CDTI	70 01/14→01/17	Construction year from: 03/14 →;	2	11.8171-0008.1 990049	Brake System: ATE
		Required quantity: 2			
OPEL - MERIVA B VAN (S10) 06/10→03/17					
Guide Sleeve Kit, brake caliper					
1.3 CDTi	70 01/13→11/14	Fitting Position: Front Axle		11.0101-5407.2 260011	Brake System: ATE
1.4 ECOTEC	74 01/13→03/17				
1.6 CDTi	81 03/14→03/17				
1.7 CDTi	74 - 01/13→01/17				
	96				
1.6 CDTi	70 01/14→01/17	Construction year from: 03/14 →;		11.0101-5407.2 260011	Brake System: ATE
		Fitting Position: Front Axle			
Guide Bolt, brake caliper					
1.3 CDTi	70 01/13→11/14	Required quantity: 2	2	11.8171-0008.1 990049	Brake System: ATE
1.4 ECOTEC	74 01/13→03/17				
1.6 CDTi	81 03/14→03/17				
1.7 CDTi	74 - 01/13→01/17				
	96				
1.6 CDTi	70 01/14→01/17	Construction year from: 03/14 →;	2	11.8171-0008.1 990049	Brake System: ATE
		Required quantity: 2			
OPEL - MOKKA / MOKKA X (J13) 06/12→					
 Brake Pad Set, disc brake					
1.4	88 - 04/13→	Vehicle Identification Number from:		13.0460-5527.2 605527	Brake System: Mando
	103	JB000001 / J4000001 →;			Wear Warning Contact: with
1.4 4x4	103 - 06/12→	Fitting Position: Front Axle			acoustic wear warning
	112				Supplementary Article/Supple-
1.4 LPG	103 04/13→				mentary Info: with accessories
1.6	85 06/12→				
1.6 CDTI	81 - 01/15→				
	100				
1.6 CDTI 4x4	81 - 01/15→				
	100				
1.7 CDTI	96 06/12→				
1.7 CDTI 4x4	96 06/12→				
1.8	103 01/13→				
1.8 4x4	103 01/13→				
→					

	kW				
OPEL - MOKKA / MOKKA X (J13) 06/12→					
 Brake Disc					
1.4	88 - 04/13→ 103	Fitting Position: Rear Axle	24.0312-0188.1 512188	Outer diameter [mm]: 268 Brake Disc Thickness [mm] 12 Minimum thickness [mm] 10 Brake Disc Type: Solid Supplementary Article/Info 2: with bolts/screws	
1.4 4x4	103 - 06/12→ 112				
1.4 LPG	103 04/13→				
1.6	85 06/12→				
1.6 CDTI	81 - 01/15→ 100				
1.6 CDTI 4x4	100 01/15→				
1.7 CDTI	96 06/12→				
1.7 CDTI 4x4	96 06/12→				
OPEL - MOKKA X VAN (J13) 06/12→					
 Brake Pad Set, disc brake					
1.6 CDTI	100 03/18→	Vehicle Identification Number from: JB000001 / J4000001 →; Fitting Position: Front Axle	13.0460-5527.2 605527	Brake System: Mando Wear Warning Contact: with acoustic wear warning Supplementary Article/Supplementary Info: with accessories	
 Brake Disc					
1.6 CDTI	100 03/18→	Fitting Position: Rear Axle	24.0312-0188.1 512188	Outer diameter [mm]: 268 Brake Disc Thickness [mm] 12 Minimum thickness [mm] 10 Brake Disc Type: Solid Supplementary Article/Info 2: with bolts/screws	
OPEL - MONZA A (22_) 02/78→08/86					
Guide Sleeve Kit, brake caliper					
2.0 E	85 03/83→10/84	Vehicle Identification Number from: E1019586 →; Vehicle Equipment: for vehicles with air conditioning; Fitting Position: Front Axle	11.0101-5407.2 260011	Brake System: ATE	
2.2 E	85 11/84→08/86	Fitting Position: Front Axle	11.0101-5407.2 260011	Brake System: ATE	
2.5 E	100 - 05/81→08/86 103	Vehicle Identification Number from: E1019586 →; Fitting Position: Front Axle	11.0101-5407.2 260011	Brake System: ATE	
3.0 GSE	115 - 02/78→08/86 132				
Guide Bolt, brake caliper					
2.0 E	85 03/83→10/84	Vehicle Identification Number from: E1019586 →; Vehicle Equipment: for vehicles with air conditioning; Required quantity: 2	2 11.8171-0008.1 990049	Brake System: ATE	
2.2 E	85 11/84→08/86	Required quantity: 2	2 11.8171-0008.1 990049	Brake System: ATE	
2.5 E	100 - 05/81→08/86 103	Vehicle Identification Number from: E1019586 →; Required quantity: 2	2 11.8171-0008.1 990049	Brake System: ATE	
3.0 GSE	115 - 02/78→08/86 132				
OPEL - MOVANO B Bus (X62) 12/10→					
 Brake Caliper					
2.3 CDTI FWD	74 - 12/10→ 132	Fitting Position: Front Axle Left	24.3481-1821.5 241355	Brake System: Brembo Supplementary Article/Supplementary Info: without holder Brake Caliper Type: Fist-type Caliper (2 pistons)	
		Fitting Position: Front Axle Right	24.3481-1822.5 241356	Brake System: Brembo Supplementary Article/Supplementary Info: without holder Brake Caliper Type: Fist-type Caliper (2 pistons)	
		Tyres: for single tyres; Fitting Position: Rear Axle Left	24.3484-1703.5 241303	Brake System: Bosch Supplementary Article/Supplementary Info: without holder Brake Caliper Type: Fist-type Caliper	
		Tyres: for single tyres; Fitting Position: Rear Axle Right	24.3484-1704.5 241304	Brake System: Bosch Supplementary Article/Supplementary Info: without holder Brake Caliper Type: Fist-type Caliper	

	kW				
OPEL - MOVANO B Bus (X62) 12/10→					
 Brake Disc					
2.3 CDTI FWD	74 - 12/10→ 132	Fitting Position: Front Axle	24.0128-0252.1 428252	Outer diameter [mm]: 302 Brake Disc Thickness [mm] 28 Minimum thickness [mm] 24.5 Brake Disc Type: Vented Supplementary Article/Info 2: with bolts/screws	
		Fitting Position: Rear Axle	24.0112-0191.1 412191	Outer diameter [mm]: 305 Brake Disc Thickness [mm] 12 Minimum thickness [mm] 10 Brake Disc Type: Solid Supplementary Article/Info 2: with bolts/screws	
OPEL - MOVANO B Platform/Chassis (X62) 05/10→					
 Brake Caliper					
2.3 CDTI FWD	74 - 05/10→ 132	Fitting Position: Front Axle Left	24.3481-1821.5 241355	Brake System: Brembo Supplementary Article/Supplementary Info: without holder Brake Caliper Type: Fist-type Caliper (2 pistons)	
2.3 CDTI RWD	74 - 05/10→ 120	Fitting Position: Front Axle Right	24.3481-1822.5 241356	Brake System: Brembo Supplementary Article/Supplementary Info: without holder Brake Caliper Type: Fist-type Caliper (2 pistons)	
		Tyres: for single tyres; Fitting Position: Rear Axle Left	24.3484-1703.5 241303	Brake System: Bosch Supplementary Article/Supplementary Info: without holder Brake Caliper Type: Fist-type Caliper	
		Tyres: for single tyres; Fitting Position: Rear Axle Right	24.3484-1704.5 241304	Brake System: Bosch Supplementary Article/Supplementary Info: without holder Brake Caliper Type: Fist-type Caliper	
 Brake Disc					
2.3 CDTI FWD	74 - 05/10→ 132	Fitting Position: Front Axle	24.0128-0252.1 428252	Outer diameter [mm]: 302 Brake Disc Thickness [mm] 28 Minimum thickness [mm] 24.5 Brake Disc Type: Vented Supplementary Article/Info 2: with bolts/screws	
		Fitting Position: Rear Axle	24.0112-0191.1 412191	Outer diameter [mm]: 305 Brake Disc Thickness [mm] 12 Minimum thickness [mm] 10 Brake Disc Type: Solid Supplementary Article/Info 2: with bolts/screws	
2.3 CDTI RWD	74 - 05/10→ 120	Fitting Position: Front Axle	24.0128-0252.1 428252	Outer diameter [mm]: 302 Brake Disc Thickness [mm] 28 Minimum thickness [mm] 24.5 Brake Disc Type: Vented Supplementary Article/Info 2: with bolts/screws	
		Tyres: for single tyres; Fitting Position: Rear Axle	24.0112-0190.1 412190	Outer diameter [mm]: 305 Brake Disc Thickness [mm] 12 Minimum thickness [mm] 10 Brake Disc Type: Solid Supplementary Article/Info 2: with bolts/screws	
		Tyres: for dual tyres; Fitting Position: Rear Axle	24.0118-0153.1 418153	Outer diameter [mm]: 302 Brake Disc Thickness [mm] 18 Minimum thickness [mm] 15 Brake Disc Type: Solid	
OPEL - MOVANO B Van (X62) 05/10→					
 Brake Caliper					
2.3 CDTI FWD	74 - 05/10→ 132	Fitting Position: Front Axle Left	24.3481-1821.5 241355	Brake System: Brembo Supplementary Article/Supplementary Info: without holder Brake Caliper Type: Fist-type Caliper (2 pistons)	
2.3 CDTI RWD	74 - 05/10→ 120				
→					

	kW				
OPEL - MOVANO B Van (X62) 05/10→					
 Brake Caliper					
2.3 CDTI FWD	74 - 05/10→ 132		Fitting Position: Front Axle Right	24.3481-1822.5 241356	Brake System: Brembo Supplementary Article/Supplementary Info: without holder Brake Caliper Type: Fist-type Caliper (2 pistons)
2.3 CDTI RWD	74 - 05/10→ 120		Tyres: for single tyres; Fitting Position: Rear Axle Left	24.3484-1703.5 241303	Brake System: Bosch Supplementary Article/Supplementary Info: without holder Brake Caliper Type: Fist-type Caliper
			Tyres: for single tyres; Fitting Position: Rear Axle Right	24.3484-1704.5 241304	Brake System: Bosch Supplementary Article/Supplementary Info: without holder Brake Caliper Type: Fist-type Caliper
2.3 CDTI FWD	81 02/12→		Fitting Position: Front Axle Left	24.3481-1821.5 241355	Brake System: Brembo Supplementary Article/Supplementary Info: without holder Brake Caliper Type: Fist-type Caliper (2 pistons)
			Fitting Position: Front Axle Right	24.3481-1822.5 241356	Brake System: Brembo Supplementary Article/Supplementary Info: without holder Brake Caliper Type: Fist-type Caliper (2 pistons)
			Construction year from: 05/14 →; Tyres: for single tyres; Fitting Position: Rear Axle Left	24.3484-1703.5 241303	Brake System: Bosch Supplementary Article/Supplementary Info: without holder Brake Caliper Type: Fist-type Caliper
			Construction year from: 05/14 →; Tyres: for single tyres; Fitting Position: Rear Axle Right	24.3484-1704.5 241304	Brake System: Bosch Supplementary Article/Supplementary Info: without holder Brake Caliper Type: Fist-type Caliper
 Brake Disc					
2.3 CDTI FWD	74 - 05/10→ 132		Fitting Position: Front Axle	24.0128-0252.1 428252	Outer diameter [mm]: 302 Brake Disc Thickness [mm] 28 Minimum thickness [mm] 24.5 Brake Disc Type: Vented Supplementary Article/Info 2: with bolts/screws
			Fitting Position: Rear Axle	24.0112-0191.1 412191	Outer diameter [mm]: 305 Brake Disc Thickness [mm] 12 Minimum thickness [mm] 10 Brake Disc Type: Solid Supplementary Article/Info 2: with bolts/screws
2.3 CDTI FWD	81 02/12→		Construction year from: 05/14 →; Fitting Position: Front Axle	24.0128-0252.1 428252	Outer diameter [mm]: 302 Brake Disc Thickness [mm] 28 Minimum thickness [mm] 24.5 Brake Disc Type: Vented Supplementary Article/Info 2: with bolts/screws
			Construction year from: 05/14 →; Fitting Position: Rear Axle	24.0112-0191.1 412191	Outer diameter [mm]: 305 Brake Disc Thickness [mm] 12 Minimum thickness [mm] 10 Brake Disc Type: Solid Supplementary Article/Info 2: with bolts/screws
2.3 CDTI RWD	74 - 05/10→ 120		Fitting Position: Front Axle	24.0128-0252.1 428252	Outer diameter [mm]: 302 Brake Disc Thickness [mm] 28 Minimum thickness [mm] 24.5 Brake Disc Type: Vented Supplementary Article/Info 2: with bolts/screws
			Tyres: for single tyres; Fitting Position: Rear Axle	24.0112-0190.1 412190	Outer diameter [mm]: 305 Brake Disc Thickness [mm] 12 Minimum thickness [mm] 10 Brake Disc Type: Solid Supplementary Article/Info 2: with bolts/screws
			Tyres: for dual tyres; Fitting Position: Rear Axle	24.0118-0153.1 418153	Outer diameter [mm]: 302 Brake Disc Thickness [mm] 18 Minimum thickness [mm] 15 Brake Disc Type: Solid

	kW				
OPEL - OMEGA A (V87) 09/86→05/94					
Guide Sleeve Kit, brake caliper					
1.8	65 - 09/86→03/94	Vehicle Identification Number from: L1019855 →;		11.0101-5407.2 260011	Brake System: ATE
1.8 S	85	→ Construction year to: 08/93;			
2.3 D	66 09/86→03/94	Fitting Position: Front Axle			
2.3 TD Interc.	54 10/86→03/94				
1.8 N	74 08/88→03/94				
1.8 N	60 - 09/86→09/88	Vehicle Identification Number from: L1019855 →; Fitting Position: Front Axle		11.0101-5407.2 260011	Brake System: ATE
2.3 TD	63				
	66 10/86→08/88				
2.0	73 - 09/86→03/94	Vehicle Identification Number from: K1000099 →;		11.0101-5407.2 260011	Brake System: ATE
2.0 i	90	→ Construction year to: 08/93;			
	85 09/86→03/94	Fitting Position: Front Axle			
		→ Vehicle Identification Number to: K1000098; Fitting Position: Front Axle		11.0101-5407.2 260011	Brake System: ATE
2.4 i	92 09/88→03/94	Vehicle Identification Number from: K1000099 →;		11.0101-5407.2 260011	Brake System: ATE
		→ Construction year to: 08/93;			
		Fitting Position: Front Axle			
3.0)	115 - 03/87→09/90	→ Vehicle Identification Number to: M1000000; Fitting Position: Front Axle		11.0101-5407.2 260011	Brake System: ATE
3.0) Cat	130				
	130 03/88→03/94				
Guide Bolt, brake caliper					
1.8	65 - 09/86→03/94	Vehicle Identification Number from: L1019855 →;	2	11.8171-0008.1 990049	Brake System: ATE
1.8 S	85	→ Construction year to: 08/93;			
2.3 D	66 09/86→03/94	Required quantity: 2;			
2.3 TD Interc.	54 10/86→03/94	Fitting Position: Front Axle			
	74 08/88→03/94				
1.8 N	60 - 09/86→09/88	Vehicle Identification Number from: L1019855 →; Required quantity: 2;	2	11.8171-0008.1 990049	Brake System: ATE
2.3 TD	63	Fitting Position: Front Axle			
	66 10/86→08/88				
2.0	73 - 09/86→03/94	→ Vehicle Identification Number to: K1000098; Required quantity: 2	2	11.8171-0008.1 990049	Brake System: ATE
2.0 i	90				
	85 09/86→03/94	Vehicle Identification Number from: K1000099 →;	2	11.8171-0008.1 990049	Brake System: ATE
		→ Construction year to: 08/93;			
		Required quantity: 2;			
		Fitting Position: Front Axle			
2.4 i	92 09/88→03/94	Vehicle Identification Number from: K1000099 →;	2	11.8171-0008.1 990049	Brake System: ATE
		→ Construction year to: 08/93;			
		Required quantity: 2;			
		Fitting Position: Front Axle			
3.0)	115 - 03/87→09/90	→ Vehicle Identification Number to: M1000000; Required quantity: 2;	2	11.8171-0008.1 990049	Brake System: ATE
3.0) Cat	130	Fitting Position: Front Axle			
	130 03/88→03/94				
OPEL - OMEGA A Estate (V87) 09/86→05/94					
Guide Sleeve Kit, brake caliper					
1.8	65 - 09/86→03/94	Vehicle Identification Number from: L1019855 →;		11.0101-5407.2 260011	Brake System: ATE
1.8 S	85	→ Construction year to: 08/93;			
2.3 D	66 09/86→03/94	Fitting Position: Front Axle			
2.3 TD Interc.	54 09/86→03/94				
	74 09/88→03/94				
1.8 N	60 - 09/86→09/88	Vehicle Identification Number from: L1019855 →; Fitting Position: Front Axle		11.0101-5407.2 260011	Brake System: ATE
2.3 TD	63				
	66 09/86→08/88				
2.0	74 - 09/86→04/94	Vehicle Identification Number from: K1000099 →;		11.0101-5407.2 260011	Brake System: ATE
2.0 i	90	→ Construction year to: 08/93;			
	73 - 09/86→04/94	Fitting Position: Front Axle			
	85				
		→ Vehicle Identification Number to: K1000098; Fitting Position: Front Axle		11.0101-5407.2 260011	Brake System: ATE
2.4 i	92 09/88→03/94	Vehicle Identification Number from: K1000099 →;		11.0101-5407.2 260011	Brake System: ATE
		→ Construction year to: 08/93;			
		Fitting Position: Front Axle			
3.0	115 - 03/87→03/94	→ Vehicle Identification Number to: M1000000; Fitting Position: Front Axle		11.0101-5407.2 260011	Brake System: ATE
3.0 Cat	130				
	130 03/87→03/94				
Guide Bolt, brake caliper					
1.8	65 - 09/86→03/94	Vehicle Identification Number from: L1019855 →;	2	11.8171-0008.1 990049	Brake System: ATE
1.8 S	85	→ Construction year to: 08/93;			
2.3 D	66 09/86→03/94	Required quantity: 2;			
2.3 TD Interc.	54 09/86→03/94	Fitting Position: Front Axle			
	74 09/88→03/94				
→					

	kW				
OPEL - OMEGA A Estate (V87) 09/86→05/94					
Guide Bolt, brake caliper					
1.8 N	60 - 09/86→09/88 63	Vehicle Identification Number from: L1019855 →; Required quantity: 2; Fitting Position: Front Axle	2	11.8171-0008.1 990049	Brake System: ATE
2.3 TD	66 09/86→08/88				
2.0	74 - 09/86→04/94 90	→ Vehicle Identification Number to: K1000098; Required quantity: 2	2	11.8171-0008.1 990049	Brake System: ATE
2.0 i	73 - 09/86→04/94 85	Vehicle Identification Number from: K1000099 →; → Construction year to: 08/93; Required quantity: 2; Fitting Position: Front Axle	2	11.8171-0008.1 990049	Brake System: ATE
2.4 i	92 09/88→03/94	Vehicle Identification Number from: K1000099 →; → Construction year to: 08/93; Required quantity: 2; Fitting Position: Front Axle	2	11.8171-0008.1 990049	Brake System: ATE
3.0	115 - 03/87→03/94 130	→ Vehicle Identification Number to: M1000000; Required quantity: 2; Fitting Position: Front Axle	2	11.8171-0008.1 990049	Brake System: ATE
3.0 Cat	130 03/87→03/94				
OPEL - OMEGA B (V94) 03/94→12/05					
Guide Sleeve Kit, brake caliper					
2.0	85 03/94→12/00	→ Vehicle Identification Number to: V1999999;		11.0101-5407.2 260011	Brake System: ATE
2.0 16V	100 03/94→09/99	Special Purpose Vehicle: not for special-purpose vehicles / not for police vehicles; Fitting Position: Front Axle			
Guide Bolt, brake caliper					
2.0	85 03/94→12/00	→ Vehicle Identification Number to: V1999999;	2	11.8171-0008.1 990049	Brake System: ATE
2.0 16V	100 03/94→09/99	Special Purpose Vehicle: not for special-purpose vehicles / not for police vehicles; Required quantity: 2; Fitting Position: Front Axle			
OPEL - OMEGA B Estate (V94) 03/94→07/03					
Guide Sleeve Kit, brake caliper					
2.0	85 03/94→09/99	→ Vehicle Identification Number to: V1999999;		11.0101-5407.2 260011	Brake System: ATE
2.0 16V	100 03/94→09/99	Special Purpose Vehicle: not for special-purpose vehicles / not for police vehicles; Fitting Position: Front Axle			
Guide Bolt, brake caliper					
2.0	85 03/94→09/99	→ Vehicle Identification Number to: V1999999;	2	11.8171-0008.1 990049	Brake System: ATE
2.0 16V	100 03/94→09/99	Special Purpose Vehicle: not for special-purpose vehicles / not for police vehicles; Required quantity: 2; Fitting Position: Front Axle			
OPEL - SENATOR A (29_) 02/78→08/87					
Guide Sleeve Kit, brake caliper					
2.0 E	85 03/83→10/84	Vehicle Identification Number from: E1019586 →; Vehicle Equipment: for vehicles with air conditioning; Fitting Position: Front Axle		11.0101-5407.2 260011	Brake System: ATE
2.2 E	85 11/84→08/87	Fitting Position: Front Axle		11.0101-5407.2 260011	Brake System: ATE
2.2 TD	63 11/84→08/87				
2.5	85 05/78→12/80	Vehicle Identification Number from: E1019586 →; Fitting Position: Front Axle		11.0101-5407.2 260011	Brake System: ATE
2.5 E	100 - 01/83→08/87 103				
3.0	110 - 04/78→08/87 115				
3.0 E	132 02/78→12/86				
Guide Bolt, brake caliper					
2.0 E	85 03/83→10/84	Vehicle Identification Number from: E1019586 →; Vehicle Equipment: for vehicles with air conditioning; Required quantity: 2	2	11.8171-0008.1 990049	Brake System: ATE
2.2 E	85 11/84→08/87	Required quantity: 2	2	11.8171-0008.1 990049	Brake System: ATE
2.2 TD	63 11/84→08/87				
2.5	85 05/78→12/80	Vehicle Identification Number from: E1019586 →; Required quantity: 2	2	11.8171-0008.1 990049	Brake System: ATE
2.5 E	100 - 01/83→08/87 103				
3.0	110 - 04/78→08/87 115				
3.0 E	132 02/78→12/86				

	kW				
OPEL - SENATOR B (V88) 09/87→09/93					
Guide Sleeve Kit, brake caliper					
2.5 i	103	09/90→09/93	→ Vehicle Identification Number to:	11.0101-5407.2	260011 Brake System: ATE
2.6 i	110	09/90→09/93	L1999999; Fitting Position: Front Axle		
3.0	115	09/87→09/93			
	130				
3.0 i Cat	130	01/88→09/93			
Guide Bolt, brake caliper					
2.5 i	103	09/90→09/93	→ Vehicle Identification Number to:	2 11.8171-0008.1	990049 Brake System: ATE
2.6 i	110	09/90→09/93	L1999999; Required quantity: 2;		
3.0	115	09/87→09/93	Fitting Position: Front Axle		
	130				
3.0 i Cat	130	01/88→09/93			
OPEL - SIGNUM Hatchback (Z03) 05/03→12/08					
Spring, brake caliper					
1.8	90	05/03→07/05	Suspension: for vehicles without sports suspension; Required quantity: 2;	2 11.8116-0356.1	390586 Brake System: ATE
1.9 CDTI	88	04/04→02/08	Brake Caliper Type: Cast iron brake caliper; Fitting Position: Front Axle		
	110				
2.2 DTI	92	05/03→04/04			
			Vehicle Identification Number from: 51066207 →;	2 11.8116-0356.1	390586 Brake System: ATE
			Suspension: for vehicles with sports suspension; Required quantity: 2; Fitting Position: Front Axle		
1.8	103	09/05→12/08	→ Construction year to: 05/08; Required quantity: 2; Fitting Position: Front Axle	2 11.8116-0356.1	390586 Brake System: ATE
1.9 CDTI	74	08/05→02/08	Required quantity: 2; Fitting Position: Front Axle	2 11.8116-0356.1	390586 Brake System: ATE
2.0 DTI	74	05/03→04/04	Suspension: for vehicles without sports suspension; Required quantity: 2; Brake Caliper Type: Cast iron brake caliper; Fitting Position: Front Axle	2 11.8116-0356.1	390586 Brake System: ATE
2.0 Turbo	129	05/03→12/08	Vehicle Identification Number from: 51066207 →;	2 11.8116-0356.1	390586 Brake System: ATE
			→ Construction year to: 05/08; Required quantity: 2; Fitting Position: Front Axle		
2.2 direct	114	05/03→09/08	Vehicle Identification Number from: 51066207 →;	2 11.8116-0356.1	390586 Brake System: ATE
			→ Construction year to: 05/08; Suspension: for vehicles with sports suspension; Required quantity: 2; Fitting Position: Front Axle		
			→ Construction year to: 05/08; Suspension: for vehicles without sports suspension; Required quantity: 2; Brake Caliper Type: Cast iron brake caliper; Fitting Position: Front Axle	2 11.8116-0356.1	390586 Brake System: ATE
Guide Sleeve Kit, brake caliper					
1.8	90	05/03→07/05	Suspension: for vehicles without sports suspension; Fitting Position: Front Axle	11.0101-5407.2	260011 Brake System: ATE
1.9 CDTI	88	04/04→02/08			
	110				
2.2 DTI	92	05/03→04/04	→ Vehicle Identification Number to: 51066206;	11.0101-5407.2	260011 Brake System: ATE
			Suspension: for vehicles with sports suspension; Fitting Position: Front Axle		
			Vehicle Identification Number from: 51066207 →;	11.0101-5407.2	260011 Brake System: ATE
			Suspension: for vehicles with sports suspension; Fitting Position: Front Axle		
			→ Vehicle Identification Number to: 41085480; Fitting Position: Rear Axle	11.0101-5407.2	260011 Brake System: ATE
			Vehicle Identification Number from: 41085481 →; Fitting Position: Rear Axle	11.0101-5407.2	260011 Brake System: ATE
1.8	103	09/05→12/08	→ Construction year to: 05/08; Fitting Position: Front Axle	11.0101-5407.2	260011 Brake System: ATE
2.8 V6 Turbo	169	09/05→12/08			
3.0 V6 CDTI	135	09/05→12/08	→ Construction year to: 05/08; Fitting Position: Rear Axle	11.0101-5407.2	260011 Brake System: ATE
1.9 CDTI	74	08/05→02/08	Fitting Position: Front Axle	11.0101-5407.2	260011 Brake System: ATE
			Fitting Position: Rear Axle	11.0101-5407.2	260011 Brake System: ATE
2.0 DTI	74	05/03→04/04	Suspension: for vehicles without sports suspension; Fitting Position: Front Axle	11.0101-5407.2	260011 Brake System: ATE
			Vehicle Identification Number from: 41085481 →; Fitting Position: Rear Axle	11.0101-5407.2	260011 Brake System: ATE
			→ Vehicle Identification Number to: 41085480; Fitting Position: Rear Axle	11.0101-5407.2	260011 Brake System: ATE
→					

OPEL - SIGNUM Hatchback (Z03) 05/03→12/08					
Guide Sleeve Kit, brake caliper					
2.0 Turbo	129 05/03→12/08	Vehicle Identification Number from: 51066207 →;		11.0101-5407.2 260011	Brake System: ATE
		→ Construction year to: 05/08;			
		Fitting Position: Front Axle			
		→ Vehicle Identification Number to: 51066206; Fitting Position: Front Axle			
2.2 direct	114 05/03→09/08	Vehicle Identification Number from: 41085481 →;		11.0101-5407.2 260011	Brake System: ATE
		→ Construction year to: 05/08;			
		Fitting Position: Rear Axle			
		→ Vehicle Identification Number to: 41085480; Fitting Position: Rear Axle			
2.2 direct	114 05/03→09/08	→ Construction year to: 05/08;		11.0101-5407.2 260011	Brake System: ATE
		Suspension: for vehicles without sports suspension; Fitting Position: Front Axle			
		→ Vehicle Identification Number to: 51066206;			
		Suspension: for vehicles with sports suspension; Fitting Position: Front Axle			
2.8 V6 Turbo	184 01/06→12/08	Vehicle Identification Number from: 51066207 →;		11.0101-5407.2 260011	Brake System: ATE
		→ Construction year to: 05/08;			
		Suspension: for vehicles with sports suspension; Fitting Position: Front Axle			
		→ Vehicle Identification Number to: 41085480; Fitting Position: Rear Axle			
2.8 V6 Turbo	184 01/06→12/08	Vehicle Identification Number from: 41085481 →;		11.0101-5407.2 260011	Brake System: ATE
		→ Construction year to: 05/08;			
		Fitting Position: Rear Axle			
		→ Vehicle Identification Number to: 41085480; Fitting Position: Rear Axle			
3.0 V6 CDTI 3.2 V6	130 05/03→07/05 155 05/03→07/05	Construction year from: 03/06 → →		11.0101-5407.2 260011	Brake System: ATE
		Construction year to: 05/08;			
		Fitting Position: Front Axle			
		→ Vehicle Identification Number to: 31068239 → → Vehicle Identification Number to: 51999999;			
3.0 V6 CDTI 3.2 V6	130 05/03→07/05 155 05/03→07/05	Fitting Position: Front Axle		11.0101-5407.2 260011	Brake System: ATE
		→ Vehicle Identification Number to: 31068238; Fitting Position: Front Axle			
		→ Vehicle Identification Number to: 41085480; Fitting Position: Rear Axle			
		Vehicle Identification Number from: 41085481 →; Fitting Position: Rear Axle			
Guide Bolt, brake caliper					
1.8 1.9 CDTI 2.2 DTI	90 05/03→07/05 88 - 04/04→02/08 110 92 05/03→04/04	Vehicle Identification Number from: 41085481 →; Required quantity: 2	2	11.8171-0008.1 990049	Brake System: ATE
		→ Vehicle Identification Number to: 51066206;	2		
		Suspension: for vehicles with sports suspension; Required quantity: 2	2		
		→ Vehicle Identification Number to: 41085480; Required quantity: 2	2		
1.8 2.8 V6 Turbo 3.0 V6 CDTI	103 09/05→12/08 169 09/05→12/08 135 09/05→12/08	Vehicle Identification Number from: 51066207 →;	2	11.8171-0008.1 990049	Brake System: ATE
		Suspension: for vehicles with sports suspension; Required quantity: 2	2		
		Suspension: for vehicles without sports suspension; Required quantity: 2	2		
		→ Construction year to: 05/08;	2		
1.9 CDTI 2.0 DTI	74 08/05→02/08 74 05/03→04/04	Required quantity: 2	2	11.8171-0008.1 990049	Brake System: ATE
		Vehicle Identification Number from: 41085481 →; Required quantity: 2	2		
		→ Vehicle Identification Number to: 41085480; Required quantity: 2	2		
		Suspension: for vehicles without sports suspension; Required quantity: 2	2		
2.0 Turbo	129 05/03→12/08	Vehicle Identification Number from: 41085481 →;	2	11.8171-0008.1 990049	Brake System: ATE
		→ Construction year to: 05/08;	2		
		Required quantity: 2	2		
		Vehicle Identification Number from: 51066207 →;	2		

→

OPEL - SIGNUM Hatchback (Z03) 05/03→12/08							
Guide Bolt, brake caliper							
2.0 Turbo	129	05/03→12/08	→ Construction year to: 05/08; Required quantity: 2				
			→ Vehicle Identification Number to: 41085480; Required quantity: 2	2	11.8171-0008.1	990049	Brake System: ATE
			→ Vehicle Identification Number to: 51066206; Required quantity: 2	2	11.8171-0008.1	990049	Brake System: ATE
2.2 direct	114	05/03→09/08	Vehicle Identification Number from: 41085481 →; → Construction year to: 05/08; Required quantity: 2	2	11.8171-0008.1	990049	Brake System: ATE
			→ Vehicle Identification Number to: 51066206; Suspension: for vehicles with sports suspension; Required quantity: 2	2	11.8171-0008.1	990049	Brake System: ATE
			→ Construction year to: 05/08; Suspension: for vehicles without sports suspension; Required quantity: 2	2	11.8171-0008.1	990049	Brake System: ATE
			Vehicle Identification Number from: 51066207 →; → Construction year to: 05/08; Suspension: for vehicles with sports suspension; Required quantity: 2	2	11.8171-0008.1	990049	Brake System: ATE
			→ Vehicle Identification Number to: 41085480; Required quantity: 2	2	11.8171-0008.1	990049	Brake System: ATE
2.8 V6 Turbo	184	01/06→12/08	Construction year from: 03/06 → → Construction year to: 05/08; Required quantity: 2	2	11.8171-0008.1	990049	Brake System: ATE
3.0 V6 CDTI	130	05/03→07/05	→ Vehicle Identification Number to: 31068238; Required quantity: 2	2	11.8171-0008.1	990049	Brake System: ATE
3.2 V6	155	05/03→07/05	Vehicle Identification Number from: 41085481 →; Required quantity: 2	2	11.8171-0008.1	990049	Brake System: ATE
			Vehicle Identification Number from: 31068239 → → Vehicle Identification Number to: 51999999; Required quantity: 2	2	11.8171-0008.1	990049	Brake System: ATE
			→ Vehicle Identification Number to: 41085480; Required quantity: 2	2	11.8171-0008.1	990049	Brake System: ATE
OPEL - TIGRA (S93) 07/94→12/00							
Guide Sleeve Kit, brake caliper							
1.4 16V	63 -	07/94→12/00	Fitting Position: Front Axle		11.0101-5407.2	260011	Brake System: ATE
	66						
1.6 16V	74 -	07/94→08/98					
	78						
Guide Bolt, brake caliper							
1.4 16V	63 -	07/94→12/00	Required quantity: 2;	2	11.8171-0008.1	990049	Brake System: ATE
	66		Fitting Position: Front Axle				
1.6 16V	74 -	07/94→08/98					
	78						
OPEL - VECTRA A (J89) 08/88→12/95							
Guide Sleeve Kit, brake caliper							
1.4 S	55	09/88→06/92	Vehicle Identification Number from: N1038530 →; Fitting Position: Front Axle		11.0101-5407.2	260011	Brake System: ATE
1.6	51 -	09/88→07/93	Vehicle Identification Number from: N5000001 →; Fitting Position: Front Axle		11.0101-5407.2	260011	Brake System: ATE
	60						
1.6 i	52 -	09/88→11/95	Vehicle Identification Number from: N5000001 →; → Construction year to: 08/95; Fitting Position: Front Axle		11.0101-5407.2	260011	Brake System: ATE
	55		Vehicle Identification Number from: N1038530 →; → Construction year to: 08/95; Fitting Position: Front Axle		11.0101-5407.2	260011	Brake System: ATE
1.7 D	42	10/88→09/92	Vehicle Identification Number from: S1000001 →; Fitting Position: Front Axle		11.0101-5407.2	260011	Brake System: ATE
1.8 S	65 -	09/88→10/90	Vehicle Identification Number from: S5000001 →; Fitting Position: Front Axle		11.0101-5407.2	260011	Brake System: ATE
	66		Vehicle Identification Number from: N1038530 → → Vehicle Identification Number to: R1999999; Fitting Position: Front Axle		11.0101-5407.2	260011	Brake System: ATE
			Vehicle Identification Number from: N5000001 → → Vehicle Identification Number to: R5999999; Fitting Position: Front Axle		11.0101-5407.2	260011	Brake System: ATE
→							

	kW				
OPEL - VECTRA A (J89) 08/88→12/95					
Guide Sleeve Kit, brake caliper					
1.7 D 1.8 i Cat	44 07/92→11/95 66 03/90→11/95	Vehicle Identification Number from: S1000001 →; → Construction year to: 08/95; Fitting Position: Front Axle		11.0101-5407.2 260011	Brake System: ATE
		Vehicle Identification Number from: S5000001 →; → Construction year to: 08/95; Fitting Position: Front Axle		11.0101-5407.2 260011	Brake System: ATE
		Vehicle Identification Number from: N1038530 → → Vehicle Identification Number to: R1999999; Fitting Position: Front Axle		11.0101-5407.2 260011	Brake System: ATE
		Vehicle Identification Number from: N5000001 → → Vehicle Identification Number to: R5999999; Fitting Position: Front Axle		11.0101-5407.2 260011	Brake System: ATE
1.7 TD	60 03/90→11/95	Vehicle Identification Number from: S1000001 →; → Construction year to: 08/95; Fitting Position: Front Axle		11.0101-5407.2 260011	Brake System: ATE
		Vehicle Identification Number from: N1038530 → → Vehicle Identification Number to: R1999999; Fitting Position: Front Axle		11.0101-5407.2 260011	Brake System: ATE
		Vehicle Identification Number from: N5000001 → → Vehicle Identification Number to: R5999999; Fitting Position: Front Axle		11.0101-5407.2 260011	Brake System: ATE
1.8 S 4x4 2.0 2.0 i 2.0 i 16V 2.0 i 4x4 2000/GT 16V 2000 16V 4x4	65 01/89→07/89 74 09/88→09/89 85 - 09/88→09/92 95 100 08/92→08/95 85 - 01/89→07/92 95 110 01/89→06/94 110 01/89→10/90	Fitting Position: Front Axle		11.0101-5407.2 260011	Brake System: ATE
2.0 i 16V 4x4 2.0 i Cat 2.0 i Cat 4x4 2.0 i Turbo 4x4 2.5 V6 2000/GT 16V Cat 2000/GT 16V Cat 4x4	100 06/94→11/95 85 09/88→11/95 85 01/89→11/95 150 06/94→11/95 125 02/93→11/95 110 02/90→11/95 110 02/90→11/95	→ Construction year to: 08/95; Fitting Position: Front Axle		11.0101-5407.2 260011	Brake System: ATE
Guide Bolt, brake caliper					
1.4 S 1.6	55 09/88→06/92 51 - 09/88→07/93 60	Vehicle Identification Number from: N1038530 →; Required quantity: 2; Fitting Position: Front Axle	2	11.8171-0008.1 990049	Brake System: ATE
		Vehicle Identification Number from: N5000001 →; Required quantity: 2; Fitting Position: Front Axle	2	11.8171-0008.1 990049	Brake System: ATE
1.6 i	52 - 09/88→11/95 55	Vehicle Identification Number from: N1038530 →; → Construction year to: 08/95; Required quantity: 2; Fitting Position: Front Axle	2	11.8171-0008.1 990049	Brake System: ATE
		Vehicle Identification Number from: N5000001 →; → Construction year to: 08/95; Required quantity: 2; Fitting Position: Front Axle	2	11.8171-0008.1 990049	Brake System: ATE
1.7 D 1.8 S	42 10/88→09/92 65 - 09/88→10/90 66	Vehicle Identification Number from: S5000001 →; Required quantity: 2	2	11.8171-0008.1 990049	Brake System: ATE
		Vehicle Identification Number from: S1000001 →; Required quantity: 2	2	11.8171-0008.1 990049	Brake System: ATE
		Vehicle Identification Number from: N1038530 → → Vehicle Identification Number to: R1999999; Required quantity: 2; Fitting Position: Front Axle	2	11.8171-0008.1 990049	Brake System: ATE
		Vehicle Identification Number from: N5000001 → → Vehicle Identification Number to: R5999999; Required quantity: 2; Fitting Position: Front Axle	2	11.8171-0008.1 990049	Brake System: ATE
1.7 D 1.8 i Cat	44 07/92→11/95 66 03/90→11/95	Vehicle Identification Number from: S1000001 →; → Construction year to: 08/95; Required quantity: 2	2	11.8171-0008.1 990049	Brake System: ATE
→					

	kW				
OPEL - VECTRA A (J89) 08/88→12/95					
Guide Bolt, brake caliper					
1.7 D 1.8 i Cat	44 07/92→11/95 66 03/90→11/95	Vehicle Identification Number from: S5000001 →; → Construction year to: 08/95; Required quantity: 2	2	11.8171-0008.1 990049	Brake System: ATE
		Vehicle Identification Number from: N1038530 → → Vehicle Identification Number to: R1999999; Required quantity: 2; Fitting Position: Front Axle	2	11.8171-0008.1 990049	Brake System: ATE
		Vehicle Identification Number from: N5000001 → → Vehicle Identification Number to: R5999999; Required quantity: 2; Fitting Position: Front Axle	2	11.8171-0008.1 990049	Brake System: ATE
1.7 TD	60 03/90→11/95	Vehicle Identification Number from: S1000001 →; → Construction year to: 08/95; Required quantity: 2	2	11.8171-0008.1 990049	Brake System: ATE
		Vehicle Identification Number from: N1038530 → → Vehicle Identification Number to: R1999999; Required quantity: 2; Fitting Position: Front Axle	2	11.8171-0008.1 990049	Brake System: ATE
		Vehicle Identification Number from: N5000001 → → Vehicle Identification Number to: R5999999; Required quantity: 2; Fitting Position: Front Axle	2	11.8171-0008.1 990049	Brake System: ATE
1.8 S 4x4 2.0 i 4x4	65 01/89→07/89 85 - 01/89→07/92 95	Required quantity: 2; Fitting Position: Front Axle	2	11.8171-0008.1 990049	Brake System: ATE
2.0 2.0 i 2.0 i 16V 2000/GT 16V 2.0 i 16V 4x4	74 09/88→09/89 85 - 09/88→09/92 95 100 08/92→08/95 110 01/89→06/94 100 06/94→11/95	Required quantity: 2	2	11.8171-0008.1 990049	Brake System: ATE
		→ Construction year to: 08/95; Required quantity: 2	2	11.8171-0008.1 990049	Brake System: ATE
		→ Construction year to: 08/95; Required quantity: 2; Fitting Position: Front Axle	2	11.8171-0008.1 990049	Brake System: ATE
2.0 i Cat 2000/GT 16V Cat	85 09/88→11/95 110 02/90→11/95	→ Construction year to: 08/95; Required quantity: 2	2	11.8171-0008.1 990049	Brake System: ATE
2.0 i Cat 4x4 2.0 i Turbo 4x4 2.5 V6 2000/GT 16V Cat 4x4	85 01/89→11/95 150 06/94→11/95 125 02/93→11/95 110 02/90→11/95	→ Construction year to: 08/95; Required quantity: 2; Fitting Position: Front Axle	2	11.8171-0008.1 990049	Brake System: ATE
2000 16V 4x4	110 01/89→10/90	Required quantity: 2	2	11.8171-0008.1 990049	Brake System: ATE
		Required quantity: 2; Fitting Position: Front Axle	2	11.8171-0008.1 990049	Brake System: ATE
OPEL - VECTRA A Hatchback (J89) 04/88→12/95					
Guide Sleeve Kit, brake caliper					
1.4 S 1.6 1.6 S	55 04/88→06/92 51 08/92→07/93 60 09/88→05/93	Vehicle Identification Number from: N1038530 →; Fitting Position: Front Axle		11.0101-5407.2 260011	Brake System: ATE
		Vehicle Identification Number from: N5000001 →; Fitting Position: Front Axle		11.0101-5407.2 260011	Brake System: ATE
1.6 i 1.6 i Cat	52 - 09/93→11/95 55 55 09/88→11/95	Vehicle Identification Number from: N1038530 →; → Construction year to: 08/95; Fitting Position: Front Axle		11.0101-5407.2 260011	Brake System: ATE
		Vehicle Identification Number from: N5000001 →; → Construction year to: 08/95; Fitting Position: Front Axle		11.0101-5407.2 260011	Brake System: ATE
1.7 D 1.8 i 1.8 S	42 09/88→09/92 66 09/88→10/90 65 09/88→07/89	Vehicle Identification Number from: S1000001 →; Fitting Position: Front Axle		11.0101-5407.2 260011	Brake System: ATE
		Vehicle Identification Number from: S5000001 →; Fitting Position: Front Axle		11.0101-5407.2 260011	Brake System: ATE
		Vehicle Identification Number from: N5000001 → → Vehicle Identification Number to: R5999999; Fitting Position: Front Axle		11.0101-5407.2 260011	Brake System: ATE
		Vehicle Identification Number from: N1038530 → → Vehicle Identification Number to: R1999999; Fitting Position: Front Axle		11.0101-5407.2 260011	Brake System: ATE
→					

	kW				
OPEL - VECTRA A Hatchback (J89) 04/88→12/95					
Guide Sleeve Kit, brake caliper					
1.7 D 1.8 i Cat	44 07/92→11/95 66 03/90→11/95	Vehicle Identification Number from: S5000001 →; → Construction year to: 08/95; Fitting Position: Front Axle		11.0101-5407.2 260011	Brake System: ATE
		Vehicle Identification Number from: S1000001 →; → Construction year to: 08/95; Fitting Position: Front Axle		11.0101-5407.2 260011	Brake System: ATE
		Vehicle Identification Number from: N5000001 → → Vehicle Identification Number to: R5999999; Fitting Position: Front Axle		11.0101-5407.2 260011	Brake System: ATE
		Vehicle Identification Number from: N1038530 → → Vehicle Identification Number to: R1999999; Fitting Position: Front Axle		11.0101-5407.2 260011	Brake System: ATE
1.7 TD	60 03/90→11/95	Vehicle Identification Number from: S1000001 →; → Construction year to: 08/95; Fitting Position: Front Axle		11.0101-5407.2 260011	Brake System: ATE
		Vehicle Identification Number from: N5000001 → → Vehicle Identification Number to: R5999999; Fitting Position: Front Axle		11.0101-5407.2 260011	Brake System: ATE
		Vehicle Identification Number from: N1038530 → → Vehicle Identification Number to: R1999999; Fitting Position: Front Axle		11.0101-5407.2 260011	Brake System: ATE
2.0	74 04/88→09/89	Construction year from: 09/88 →; Fitting Position: Front Axle		11.0101-5407.2 260011	Brake System: ATE
2.0 i 2.0 i 16V	85 09/88→10/90 100 - 02/89→08/95 110	Fitting Position: Front Axle		11.0101-5407.2 260011	Brake System: ATE
2.0 i 16V Cat 2.0 i Cat 2.0 i GT 2.5 V6	110 02/90→11/95 85 09/88→11/95 95 09/88→11/95 125 02/93→11/95	→ Construction year to: 08/95; Fitting Position: Front Axle		11.0101-5407.2 260011	Brake System: ATE
Guide Bolt, brake caliper					
1.4 S 1.6 1.6 S	55 04/88→06/92 51 08/92→07/93 60 09/88→05/93	Vehicle Identification Number from: N5000001 →; Required quantity: 2; Fitting Position: Front Axle	2	11.8171-0008.1 990049	Brake System: ATE
		Vehicle Identification Number from: N1038530 →; Required quantity: 2; Fitting Position: Front Axle	2	11.8171-0008.1 990049	Brake System: ATE
1.6 i 1.6 i Cat	52 - 09/93→11/95 55 55 09/88→11/95	Vehicle Identification Number from: N1038530 →; → Construction year to: 08/95; Required quantity: 2; Fitting Position: Front Axle	2	11.8171-0008.1 990049	Brake System: ATE
		Vehicle Identification Number from: N5000001 →; → Construction year to: 08/95; Required quantity: 2; Fitting Position: Front Axle	2	11.8171-0008.1 990049	Brake System: ATE
1.7 D 1.8 i 1.8 S	42 09/88→09/92 66 09/88→10/90 65 09/88→07/89	Vehicle Identification Number from: S1000001 →; Required quantity: 2	2	11.8171-0008.1 990049	Brake System: ATE
		Vehicle Identification Number from: S5000001 →; Required quantity: 2	2	11.8171-0008.1 990049	Brake System: ATE
		Vehicle Identification Number from: N1038530 → → Vehicle Identification Number to: R1999999; Required quantity: 2; Fitting Position: Front Axle	2	11.8171-0008.1 990049	Brake System: ATE
		Vehicle Identification Number from: N5000001 → → Vehicle Identification Number to: R5999999; Required quantity: 2; Fitting Position: Front Axle	2	11.8171-0008.1 990049	Brake System: ATE
1.7 D 1.8 i Cat	44 07/92→11/95 66 03/90→11/95	Vehicle Identification Number from: S1000001 →; → Construction year to: 08/95; Required quantity: 2	2	11.8171-0008.1 990049	Brake System: ATE
		Vehicle Identification Number from: S5000001 →; → Construction year to: 08/95; Required quantity: 2	2	11.8171-0008.1 990049	Brake System: ATE
		Vehicle Identification Number from: N1038530 → → Vehicle Identification	2	11.8171-0008.1 990049	Brake System: ATE
→					

	kW				
OPEL - VECTRA A Hatchback (J89) 04/88→12/95					
Guide Bolt, brake caliper					
1.7 D 1.8 i Cat	44 07/92→11/95 66 03/90→11/95	Number to: R1999999; Required quantity: 2; Fitting Position: Front Axle			
		Vehicle Identification Number from: N5000001 → → Vehicle Identification Number to: R5999999; Required quantity: 2; Fitting Position: Front Axle	2	11.8171-0008.1 990049	Brake System: ATE
1.7 TD	60 03/90→11/95	Vehicle Identification Number from: S1000001 →; → Construction year to: 08/95; Required quantity: 2	2	11.8171-0008.1 990049	Brake System: ATE
		Vehicle Identification Number from: N1038530 → → Vehicle Identification Number to: R1999999; Required quantity: 2; Fitting Position: Front Axle	2	11.8171-0008.1 990049	Brake System: ATE
		Vehicle Identification Number from: N5000001 → → Vehicle Identification Number to: R5999999; Required quantity: 2; Fitting Position: Front Axle	2	11.8171-0008.1 990049	Brake System: ATE
2.0	74 04/88→09/89	Construction year from: 09/88 →; Required quantity: 2	2	11.8171-0008.1 990049	Brake System: ATE
2.0 i 2.0 i 16V	85 09/88→10/90 100 - 02/89→08/95 110	Required quantity: 2	2	11.8171-0008.1 990049	Brake System: ATE
2.0 i 16V Cat 2.0 i Cat 2.0 i GT	110 02/90→11/95 85 09/88→11/95 95 09/88→11/95	→ Construction year to: 08/95; Required quantity: 2	2	11.8171-0008.1 990049	Brake System: ATE
2.5 V6	125 02/93→11/95	→ Construction year to: 08/95; Required quantity: 2; Fitting Position: Front Axle	2	11.8171-0008.1 990049	Brake System: ATE
OPEL - VECTRA B (J96) 09/95→07/04					
Guide Sleeve Kit, brake caliper					
1.6 GL 1.6 i 1.6 i 16V 1.8 i 16V	60 09/95→08/96 55 10/95→04/02 74 10/95→04/02 85 - 10/95→04/02 92	Vehicle Identification Number from: X1000001 →; Fitting Position: Front Axle		11.0101-5407.2 260011	Brake System: ATE
		→ Vehicle Identification Number to: W7999999; Fitting Position: Front Axle		11.0101-5407.2 260011	Brake System: ATE
2.0 DI 16V 2.0 DTI 16V	60 11/96→04/02 74 06/97→04/02				
1.7 TD	60 10/95→12/98	→ Construction year to: 11/96; Fitting Position: Front Axle		11.0101-5407.2 260011	Brake System: ATE
2.0 i 2.0 i 16V 2.2 DTI 16V	82 10/95→04/02 100 09/95→06/00 88 - 09/00→04/02 92	Fitting Position: Front Axle		11.0101-5407.2 260011	Brake System: ATE
2.2 i 16V	102 - 07/00→07/02 108				
2.5 i V6 2.6 i V6 i 500 2.5	125 10/95→09/00 125 09/00→04/02 143 05/98→09/00				
Guide Bolt, brake caliper					
1.6 GL 1.6 i 1.6 i 16V 1.8 i 16V	60 09/95→08/96 55 10/95→04/02 74 10/95→04/02 85 - 10/95→04/02 92	→ Vehicle Identification Number to: W7999999; Required quantity: 2	2	11.8171-0008.1 990049	Brake System: ATE
		Vehicle Identification Number from: X1000001 →; Required quantity: 2; Fitting Position: Front Axle	2	11.8171-0008.1 990049	Brake System: ATE
2.0 DI 16V 2.0 DTI 16V	60 11/96→04/02 74 06/97→04/02				
1.7 TD	60 10/95→12/98	→ Construction year to: 11/96; Required quantity: 2	2	11.8171-0008.1 990049	Brake System: ATE
2.0 i 2.0 i 16V 2.2 DTI 16V	82 10/95→04/02 100 09/95→06/00 88 - 09/00→04/02 92	Required quantity: 2; Fitting Position: Front Axle	2	11.8171-0008.1 990049	Brake System: ATE
2.2 i 16V	102 - 07/00→07/02 108				
2.5 i V6 2.6 i V6 i 500 2.5	125 10/95→09/00 125 09/00→04/02 143 05/98→09/00				
OPEL - VECTRA B Estate (J96) 11/96→07/03					
Guide Sleeve Kit, brake caliper					
1.6 i 1.8 i 16V →	55 11/96→06/00 85 11/96→09/00	Vehicle Identification Number from: X1000001 →; Fitting Position: Front Axle		11.0101-5407.2 260011	Brake System: ATE

	kW				
OPEL - VECTRA B Estate (J96) 11/96→07/03					
Guide Sleeve Kit, brake caliper					
2.0 DI 16V	60	11/96→06/00	→ Vehicle Identification Number to: W7999999; Fitting Position: Front Axle	11.0101-5407.2 260011	Brake System: ATE
1.6 i 16V	74	11/96→07/02	Vehicle Identification Number from: X1000001 →; → Construction year to: 04/02; Fitting Position: Front Axle	11.0101-5407.2 260011	Brake System: ATE
1.8 i 16V	92	09/00→07/03			
2.0 DTI 16V	74	06/97→07/03			
			→ Vehicle Identification Number to: W7999999; Fitting Position: Front Axle	11.0101-5407.2 260011	Brake System: ATE
1.7 TD	60	11/96→12/97	→ Construction year to: 11/96; Fitting Position: Front Axle	11.0101-5407.2 260011	Brake System: ATE
2.0 i	82	11/96→02/02	Fitting Position: Front Axle	11.0101-5407.2 260011	Brake System: ATE
2.0 i 16V	85 - 100	11/96→07/03			
2.2 DTI 16V	88	09/00→04/02			
2.5 i V6	125	11/96→09/00			
i 500 2.5	143	05/98→09/00			
2.2 DTI 16V	92	09/00→07/03			
2.2 i 16V	102 - 108	07/00→07/03	→ Construction year to: 04/02; Fitting Position: Front Axle	11.0101-5407.2 260011	Brake System: ATE
2.6 i V6	125	09/00→07/03			
Guide Bolt, brake caliper					
1.6 i	55	11/96→06/00	→ Vehicle Identification Number to: W7999999; Required quantity: 2	2 11.8171-0008.1 990049	Brake System: ATE
1.8 i 16V	85	11/96→09/00	Vehicle Identification Number from: X1000001 →; Required quantity: 2; Fitting Position: Front Axle	2 11.8171-0008.1 990049	Brake System: ATE
2.0 DI 16V	60	11/96→06/00			
1.6 i 16V	74	11/96→07/02	→ Vehicle Identification Number to: W7999999; Required quantity: 2	2 11.8171-0008.1 990049	Brake System: ATE
1.8 i 16V	92	09/00→07/03	Vehicle Identification Number from: X1000001 →; → Construction year to: 04/02; Required quantity: 2; Fitting Position: Front Axle	2 11.8171-0008.1 990049	Brake System: ATE
2.0 DTI 16V	74	06/97→07/03			
1.7 TD	60	11/96→12/97	→ Construction year to: 11/96; Required quantity: 2	2 11.8171-0008.1 990049	Brake System: ATE
2.0 i	82	11/96→02/02	Required quantity: 2; Fitting Position: Front Axle	2 11.8171-0008.1 990049	Brake System: ATE
2.0 i 16V	85 - 100	11/96→07/03			
2.2 DTI 16V	88	09/00→04/02			
2.5 i V6	125	11/96→09/00			
i 500 2.5	143	05/98→09/00			
2.2 DTI 16V	92	09/00→07/03			
2.2 i 16V	102 - 108	07/00→07/03	→ Construction year to: 04/02; Required quantity: 2; Fitting Position: Front Axle	2 11.8171-0008.1 990049	Brake System: ATE
2.6 i V6	125	09/00→07/03			
OPEL - VECTRA B Hatchback (J96) 09/95→07/03					
Guide Sleeve Kit, brake caliper					
1.6 i	55	10/95→07/03	Vehicle Identification Number from: X1000001 →; → Construction year to: 04/02; Fitting Position: Front Axle	11.0101-5407.2 260011	Brake System: ATE
1.6 i 16V	74	10/95→07/02			
1.8 i 16V	92	09/00→07/03			
2.0 DTI 16V	74	06/97→07/03			
			→ Vehicle Identification Number to: W7999999; Fitting Position: Front Axle	11.0101-5407.2 260011	Brake System: ATE
1.7 TD	60	10/95→12/98	→ Construction year to: 11/96; Fitting Position: Front Axle	11.0101-5407.2 260011	Brake System: ATE
1.8 FlexFuel	85	01/99→09/00	Vehicle Identification Number from: X1000001 →; Fitting Position: Front Axle	11.0101-5407.2 260011	Brake System: ATE
1.8 i 16V	85	10/95→09/00			
2.0 DI 16V	60	11/96→06/00			
			→ Vehicle Identification Number to: W7999999; Fitting Position: Front Axle	11.0101-5407.2 260011	Brake System: ATE
2.0 i	82	10/95→02/02	Fitting Position: Front Axle	11.0101-5407.2 260011	Brake System: ATE
2.0 i 16V	85 - 100	09/95→07/03			
2.2 DTI 16V	88	09/00→04/02			
2.5	144	10/99→06/00			
2.5 i V6	125	10/95→09/00			
2.2 DTI 16V	92	09/00→07/03			
2.2 i 16V	102 - 108	07/00→07/03	→ Construction year to: 04/02; Fitting Position: Front Axle	11.0101-5407.2 260011	Brake System: ATE
2.6 i V6	125	09/00→07/03			
Guide Bolt, brake caliper					
1.6 i	55	10/95→07/03	→ Vehicle Identification Number to: W7999999; Required quantity: 2	2 11.8171-0008.1 990049	Brake System: ATE
1.6 i 16V	74	10/95→07/02	Vehicle Identification Number from: X1000001 →; → Construction year to: 04/02;	2 11.8171-0008.1 990049	Brake System: ATE
1.8 i 16V	92	09/00→07/03			
2.0 DTI 16V	74	06/97→07/03			
			→ Vehicle Identification Number to: W7999999; Fitting Position: Front Axle		
→					

	kW				
OPEL - VECTRA B Hatchback (J96) 09/95→07/03					
Guide Bolt, brake caliper					
1.6 i	55	10/95→07/03	Required quantity: 2;		
1.6 i 16V	74	10/95→07/02	Fitting Position: Front Axle		
1.8 i 16V	92	09/00→07/03			
2.0 DTI 16V	74	06/97→07/03			
1.7 TD	60	10/95→12/98	→ Construction year to: 11/96; Required quantity: 2	2	11.8171-0008.1 990049 Brake System: ATE
1.8 FlexFuel	85	01/99→09/00	→ Vehicle Identification Number to: W7999999; Required quantity: 2	2	11.8171-0008.1 990049 Brake System: ATE
1.8 i 16V	85	10/95→09/00			
2.0 DI 16V	60	11/96→06/00	Vehicle Identification Number from: X1000001 →; Required quantity: 2; Fitting Position: Front Axle	2	11.8171-0008.1 990049 Brake System: ATE
2.0 i	82	10/95→02/02	Required quantity: 2;	2	11.8171-0008.1 990049 Brake System: ATE
2.0 i 16V	85 -	09/95→07/03	Fitting Position: Front Axle		
	100				
2.2 DTI 16V	88	09/00→04/02			
2.5	144	10/99→06/00			
2.5 i V6	125	10/95→09/00			
2.2 DTI 16V	92	09/00→07/03	→ Construction year to: 04/02;	2	11.8171-0008.1 990049 Brake System: ATE
2.2 i 16V	102 -	07/00→07/03	Required quantity: 2;		
	108		Fitting Position: Front Axle		
2.6 i V6	125	09/00→07/03			
OPEL - VECTRA C (Z02) 04/02→01/09					
Spring, brake caliper					
1.6	77	08/05→08/08	Required quantity: 2;	2	11.8116-0356.1 390586 Brake System: ATE
1.6 16V	74	04/02→10/05	Brake Caliper Type: Cast iron brake caliper; Fitting Position: Front Axle		
1.9 CDTI	110	04/04→08/08			
2.0 DTI 16V	74	04/02→08/06			
1.8	81	04/02→07/08	Suspension: for vehicles without sports suspension; Required quantity: 2;	2	11.8116-0356.1 390586 Brake System: ATE
1.8 16V	90	04/02→09/08	Brake Caliper Type: Cast iron brake caliper; Fitting Position: Front Axle		
2.2 DGi	114	10/03→08/08			
2.2 DTI 16V	86 -	04/02→12/04			
	92				
1.8	103	08/05→08/08	Suspension: for vehicles with sports suspension; Required quantity: 2; Brake Caliper Type: Cast iron brake caliper; Fitting Position: Front Axle	2	11.8116-0356.1 390586 Brake System: ATE
			Suspension: for vehicles with sports suspension; Special Purpose Vehicle: for police vehi- cles; Required quantity: 2; Fitting Position: Front Axle	2	11.8116-0356.1 390586 Brake System: ATE
1.9 CDTI	74	10/05→08/08	Vehicle Identification Number from: 61000001 →; Required quantity: 2; Fitting Position: Front Axle	2	11.8116-0356.1 390586 Brake System: ATE
1.9 CDTI	88	04/04→01/09	→ Construction year to: 10/08; Required quantity: 2; Brake Caliper Type: Cast iron brake caliper; Fitting Position: Front Axle	2	11.8116-0356.1 390586 Brake System: ATE
2.2 16V	108	04/02→12/08	Suspension: for vehicles without sports suspension; → Construction year to: 10/08; Required quantity: 2; Brake Caliper Type: Cast iron brake caliper; Fitting Position: Front Axle	2	11.8116-0356.1 390586 Brake System: ATE
Guide Sleeve Kit, brake caliper					
1.6	77	08/05→08/08	Fitting Position: Front Axle		11.0101-5407.2 260011 Brake System: ATE
			Brake Disc Type: Solid; Fitting Position: Rear Axle		11.0101-5407.2 260011 Brake System: ATE
			Brake Disc Type: Internally Vented; Fitting Position: Rear Axle		11.0101-5407.2 260011 Brake System: ATE
1.6 16V	74	04/02→10/05	Fitting Position: Front Axle		11.0101-5407.2 260011 Brake System: ATE
1.8	81	04/02→07/08	Brake Disc Type: Vented; Fitting Position: Rear Axle		11.0101-5407.2 260011 Brake System: ATE
1.8 16V	90	04/02→09/08			
1.9 CDTI	110	04/04→08/08	Brake Disc Type: Solid; Fitting Position: Rear Axle		11.0101-5407.2 260011 Brake System: ATE
2.0 16V Turbo	129	03/03→08/08			
2.0 DTI 16V	74	04/02→08/06			
2.2 DGi	114	10/03→08/08			
2.2 DTI 16V	86 -	04/02→12/04			
	92				
1.8	103	08/05→08/08	Suspension: for vehicles with sports suspension; Fitting Position: Front Axle		11.0101-5407.2 260011 Brake System: ATE
			Suspension: for vehicles with sports suspension; Special Purpose Vehicle: for police vehi- cles; Fitting Position: Front Axle		11.0101-5407.2 260011 Brake System: ATE
			Brake Disc Type: Solid; Fitting Position: Rear Axle		11.0101-5407.2 260011 Brake System: ATE

	kW				
OPEL - VECTRA C (Z02) 04/02→01/09					
Guide Sleeve Kit, brake caliper					
1.8	103	08/05→08/08	Brake Disc Type: Internally Vented; Fitting Position: Rear Axle	11.0101-5407.2 260011	Brake System: ATE
1.9 CDTI	74	10/05→08/08	Vehicle Identification Number from: 61000001 →; Fitting Position: Front Axle	11.0101-5407.2 260011	Brake System: ATE
3.0 CDTi	135	08/05→08/08	Brake Disc Type: Solid; Fitting Position: Rear Axle	11.0101-5407.2 260011	Brake System: ATE
			Brake Disc Type: Internally Vented; Fitting Position: Rear Axle	11.0101-5407.2 260011	Brake System: ATE
1.9 CDTI	88	04/04→01/09	→ Construction year to: 10/08; Fitting Position: Front Axle	11.0101-5407.2 260011	Brake System: ATE
2.2 16V	108	04/02→12/08	Brake Disc Type: Solid; → Construction year to: 10/08; Fitting Position: Rear Axle	11.0101-5407.2 260011	Brake System: ATE
			Brake Disc Type: Vented; → Construction year to: 10/08; Fitting Position: Rear Axle	11.0101-5407.2 260011	Brake System: ATE
2.8 V6 Turbo	169 - 184	08/05→08/08	Vehicle Identification Number from: 61000001 →; Trim Level: + OPC / +VXR; Fitting Position: Front Axle	11.0101-5407.2 260011	Brake System: ATE
			Vehicle Identification Number from: 61000001 →; Trim Level: - OPC / -VXR; Fitting Position: Front Axle	11.0101-5407.2 260011	Brake System: ATE
			Brake Disc Type: Solid; Fitting Position: Rear Axle	11.0101-5407.2 260011	Brake System: ATE
			Brake Disc Type: Internally Vented; Fitting Position: Rear Axle	11.0101-5407.2 260011	Brake System: ATE
2.8 V6 Turbo	188	08/05→09/06	Vehicle Identification Number from: 61000001 →; Fitting Position: Front Axle	11.0101-5407.2 260011	Brake System: ATE
2.8 V6 Turbo OPC	206	09/06→08/08	Fitting Position: Rear Axle	11.0101-5407.2 260011	Brake System: ATE
3.0 CDTI	130	02/03→07/05	→ Vehicle Identification Number to: 31070293; Fitting Position: Front Axle	11.0101-5407.2 260011	Brake System: ATE
3.2 V6	155	08/02→07/06	Vehicle Identification Number from: 31070294 →; Fitting Position: Front Axle	11.0101-5407.2 260011	Brake System: ATE
			Brake Disc Type: Vented; Fitting Position: Rear Axle	11.0101-5407.2 260011	Brake System: ATE
			Brake Disc Type: Solid; Fitting Position: Rear Axle	11.0101-5407.2 260011	Brake System: ATE
Guide Bolt, brake caliper					
1.6	77	08/05→08/08	Required quantity: 2	2 11.8171-0008.1 990049	Brake System: ATE
			Brake Disc Type: Solid; Required quantity: 2	2 11.8171-0008.1 990049	Brake System: ATE
			Brake Disc Type: Internally Vented; Required quantity: 2	2 11.8171-0008.1 990049	Brake System: ATE
1.6 16V	74	04/02→10/05	Required quantity: 2	2 11.8171-0008.1 990049	Brake System: ATE
1.8	81	04/02→07/08	Required quantity: 2	2 11.8171-0008.1 990049	Brake System: ATE
1.8 16V	90	04/02→09/08	Brake Disc Type: Solid; Required quantity: 2	2 11.8171-0008.1 990049	Brake System: ATE
1.9 CDTI	110	04/04→08/08	Required quantity: 2	2 11.8171-0008.1 990049	Brake System: ATE
2.0 16V Turbo	129	03/03→08/08	Brake Disc Type: Vented; Required quantity: 2	2 11.8171-0008.1 990049	Brake System: ATE
2.0 DTI 16V	74	04/02→08/06	Required quantity: 2	2 11.8171-0008.1 990049	Brake System: ATE
2.2 DGi	114	10/03→08/08	Required quantity: 2	2 11.8171-0008.1 990049	Brake System: ATE
2.2 DTI 16V	86 - 92	04/02→12/04	Required quantity: 2	2 11.8171-0008.1 990049	Brake System: ATE
1.8	103	08/05→08/08	Brake Disc Type: Solid; Required quantity: 2	2 11.8171-0008.1 990049	Brake System: ATE
			Brake Disc Type: Internally Vented; Required quantity: 2	2 11.8171-0008.1 990049	Brake System: ATE
			Suspension: for vehicles with sports suspension; Special Purpose Vehicle: for police vehi- cles; Required quantity: 2	2 11.8171-0008.1 990049	Brake System: ATE
			Suspension: for vehicles with sports suspension; Required quantity: 2	2 11.8171-0008.1 990049	Brake System: ATE
1.9 CDTI	74	10/05→08/08	Brake Disc Type: Solid; Required quantity: 2	2 11.8171-0008.1 990049	Brake System: ATE
3.0 CDTi	135	08/05→08/08	Brake Disc Type: Internally Vented; Required quantity: 2	2 11.8171-0008.1 990049	Brake System: ATE
			Vehicle Identification Number from: 61000001 →; Required quantity: 2	2 11.8171-0008.1 990049	Brake System: ATE
1.9 CDTI	88	04/04→01/09	→ Construction year to: 10/08; Required quantity: 2	2 11.8171-0008.1 990049	Brake System: ATE
2.2 16V	108	04/02→12/08	Brake Disc Type: Solid; → Construction year to: 10/08; Required quantity: 2	2 11.8171-0008.1 990049	Brake System: ATE
→					

	kW				
OPEL - VECTRA C (Z02) 04/02→01/09					
Guide Bolt, brake caliper					
1.9 CDTI 2.2 16V	88 04/04→01/09 108 04/02→12/08	Brake Disc Type: Vented; → Construction year to: 10/08; Required quantity: 2	2	11.8171-0008.1 990049	Brake System: ATE
2.8 V6 Turbo	169 - 08/05→08/08 184	Brake Disc Type: Solid; Required quantity: 2	2	11.8171-0008.1 990049	Brake System: ATE
		Brake Disc Type: Internally Vented; Required quantity: 2	2	11.8171-0008.1 990049	Brake System: ATE
		Vehicle Identification Number from: 61000001 →; Trim Level: + OPC / +VXR; Required quantity: 2	2	11.8171-0008.1 990049	Brake System: ATE
		Vehicle Identification Number from: 61000001 →; Trim Level: - OPC / -VXR; Required quantity: 2	2	11.8171-0008.1 990049	Brake System: ATE
2.8 V6 Turbo 2.8 V6 Turbo OPC	188 08/05→09/06 206 09/06→08/08	Required quantity: 2	2	11.8171-0008.1 990049	Brake System: ATE
		Vehicle Identification Number from: 61000001 →; Required quantity: 2	2	11.8171-0008.1 990049	Brake System: ATE
3.0 CDTI 3.2 V6	130 02/03→07/05 155 08/02→07/06	Brake Disc Type: Solid; Required quantity: 2	2	11.8171-0008.1 990049	Brake System: ATE
		Brake Disc Type: Vented; Required quantity: 2	2	11.8171-0008.1 990049	Brake System: ATE
		→ Vehicle Identification Number to: 31070293; Required quantity: 2	2	11.8171-0008.1 990049	Brake System: ATE
		Vehicle Identification Number from: 31070294 →; Required quantity: 2	2	11.8171-0008.1 990049	Brake System: ATE
OPEL - VECTRA C Estate (Z02) 10/03→01/09					
Spring, brake caliper					
1.6	77 12/05→08/08	Construction year from: 06/06 →; Required quantity: 2; Brake Caliper Type: Cast iron brake caliper; Fitting Position: Front Axle	2	11.8116-0356.1 390586	Brake System: ATE
1.6 16V 1.9 CDTI 2.0 DTI	74 06/04→09/05 110 04/04→08/08 74 10/03→08/05	Required quantity: 2; Brake Caliper Type: Cast iron brake caliper; Fitting Position: Front Axle	2	11.8116-0356.1 390586	Brake System: ATE
1.8 2.2 direct 2.2 DTI	90 10/03→09/06 114 10/03→08/08 92 10/03→12/05	Suspension: for vehicles without sports suspension; Required quantity: 2; Brake Caliper Type: Cast iron brake caliper; Fitting Position: Front Axle	2	11.8116-0356.1 390586	Brake System: ATE
		1.8	103 08/05→08/08	Suspension: for vehicles with sports suspension; Special Purpose Vehicle: for police vehi- cles; Required quantity: 2	2
1.9 CDTI	74 06/05→08/08	Suspension: for vehicles with sports suspension; Special Purpose Vehicle: for police vehi- cles; Required quantity: 2	2	11.8116-0356.1 390586	Brake System: ATE
		Vehicle Identification Number from: 61000001 →; Suspension: for vehicles without sports suspension; Special Purpose Vehicle: not for police vehicles; Required quantity: 2; Brake Caliper Type: Cast iron brake caliper; Fitting Position: Front Axle	2	11.8116-0356.1 390586	Brake System: ATE
1.9 CDTI	88 04/04→01/09	→ Construction year to: 10/08; Suspension: for vehicles with sports suspension; Special Purpose Vehicle: for police vehi- cles; Required quantity: 2	2	11.8116-0356.1 390586	Brake System: ATE
		→ Construction year to: 10/08; Suspension: for vehicles without sports suspension; Special Purpose Vehicle: not for police vehicles; Required quantity: 2; Brake Caliper Type: Cast iron brake caliper; Fitting Position: Front Axle	2	11.8116-0356.1 390586	Brake System: ATE
Guide Sleeve Kit, brake caliper					
1.6	77 12/05→08/08	Construction year from: 06/06 →; Fitting Position: Front Axle		11.0101-5407.2 260011	Brake System: ATE
		Construction year from: 06/06 →; → Vehicle Identification Number to:		11.0101-5407.2 260011	Brake System: ATE
→					





	kW				
OPEL - VECTRA C Estate (Z02) 10/03→01/09					
Guide Sleeve Kit, brake caliper					
1.6	77 12/05→08/08	41085480; Brake Disc Type: Internally Vented; Fitting Position: Rear Axle			
		Vehicle Identification Number from: 41085481 →; Fitting Position: Rear Axle	11.0101-5407.2 260011	Brake System: ATE	
		Construction year from: 06/06 →; → Vehicle Identification Number to: 41085480; Brake Disc Type: Solid; Fitting Position: Rear Axle	11.0101-5407.2 260011	Brake System: ATE	
1.6 16V	74 06/04→09/05	Fitting Position: Front Axle	11.0101-5407.2 260011	Brake System: ATE	
1.8	90 10/03→09/06	Vehicle Identification Number from: 41085481 →; Fitting Position: Rear Axle	11.0101-5407.2 260011	Brake System: ATE	
1.9 CDTI	110 04/04→08/08	Brake Disc Type: Vented; → Vehicle Identification Number to: 41085480; Fitting Position: Rear Axle	11.0101-5407.2 260011	Brake System: ATE	
2.0 DTI	74 10/03→08/05	Brake Disc Type: Solid; → Vehicle Identification Number to: 41085480; Fitting Position: Rear Axle	11.0101-5407.2 260011	Brake System: ATE	
2.0 Turbo	129 10/03→08/08				
2.2 direct	114 10/03→08/08				
2.2 DTI	92 10/03→12/05				
1.8	103 08/05→08/08	Suspension: for vehicles with sports suspension; Special Purpose Vehicle: for police vehi- cles; Fitting Position: Front Axle	11.0101-5407.2 260011	Brake System: ATE	
		Suspension: for vehicles with sports suspension; Special Purpose Vehicle: not for police vehicles; Fitting Position: Front Axle	11.0101-5407.2 260011	Brake System: ATE	
		Vehicle Identification Number from: 41085481 →; Fitting Position: Rear Axle	11.0101-5407.2 260011	Brake System: ATE	
		Brake Disc Type: Solid; → Vehicle Identification Number to: 41085480; Fitting Position: Rear Axle	11.0101-5407.2 260011	Brake System: ATE	
		→ Vehicle Identification Number to: 41085480; Brake Disc Type: Internally Vented; Fitting Position: Rear Axle	11.0101-5407.2 260011	Brake System: ATE	
1.9 CDTI	74 06/05→08/08	Suspension: for vehicles with sports suspension; Special Purpose Vehicle: for police vehi- cles; Fitting Position: Front Axle	11.0101-5407.2 260011	Brake System: ATE	
		Vehicle Identification Number from: 61000001 →; Suspension: for vehicles without sports suspension; Special Purpose Vehicle: not for police vehicles; Fitting Position: Front Axle	11.0101-5407.2 260011	Brake System: ATE	
		Vehicle Identification Number from: 41085481 →; Fitting Position: Rear Axle	11.0101-5407.2 260011	Brake System: ATE	
		→ Vehicle Identification Number to: 41085480; Brake Disc Type: Internally Vented; Fitting Position: Rear Axle	11.0101-5407.2 260011	Brake System: ATE	
		Brake Disc Type: Solid; → Vehicle Identification Number to: 41085480; Fitting Position: Rear Axle	11.0101-5407.2 260011	Brake System: ATE	
1.9 CDTI	88 04/04→01/09	→ Construction year to: 10/08; Suspension: for vehicles without sports suspension; Special Purpose Vehicle: not for police vehicles; Fitting Position: Front Axle	11.0101-5407.2 260011	Brake System: ATE	
		→ Construction year to: 10/08; Suspension: for vehicles with sports suspension; Special Purpose Vehicle: for police vehi- cles; Fitting Position: Front Axle	11.0101-5407.2 260011	Brake System: ATE	
		Vehicle Identification Number from: 41085481 →; → Construction year to: 10/08; Fitting Position: Rear Axle	11.0101-5407.2 260011	Brake System: ATE	
		Brake Disc Type: Vented; → Vehicle Identification Number to: 41085480; Fitting Position: Rear Axle	11.0101-5407.2 260011	Brake System: ATE	
		Brake Disc Type: Solid; → Vehicle Identification Number to: 41085480; Fitting Position: Rear Axle	11.0101-5407.2 260011	Brake System: ATE	
2.8 V6 Turbo	169 08/05→10/08	Vehicle Identification Number from: 61000001 →; Fitting Position: Front Axle	11.0101-5407.2 260011	Brake System: ATE	
		Vehicle Identification Number from: 41085481 →; Fitting Position: Rear Axle	11.0101-5407.2 260011	Brake System: ATE	
→					





	kW				
OPEL - VECTRA C Estate (Z02) 10/03→01/09					
Guide Sleeve Kit, brake caliper					
2.8 V6 Turbo	184 08/05→08/08	Fitting Position: Front Axle		11.0101-5407.2 260011	Brake System: ATE
		Vehicle Identification Number from: 41085481 →; Fitting Position: Rear Axle		11.0101-5407.2 260011	Brake System: ATE
2.8 V6 Turbo	188 08/05→09/08	Vehicle Identification Number from: 61000001 →; Fitting Position: Front Axle		11.0101-5407.2 260011	Brake System: ATE
		Fitting Position: Rear Axle		11.0101-5407.2 260011	Brake System: ATE
2.8 V6 Turbo	206 07/06→08/08	Fitting Position: Front Axle		11.0101-5407.2 260011	Brake System: ATE
		Fitting Position: Rear Axle		11.0101-5407.2 260011	Brake System: ATE
3.0 V6 CDTI 3.2 V6	130 10/03→07/05	Vehicle Identification Number from: 31070294 →; Fitting Position: Front Axle		11.0101-5407.2 260011	Brake System: ATE
	155 10/03→07/05	→ Vehicle Identification Number to: 31070293; Fitting Position: Front Axle		11.0101-5407.2 260011	Brake System: ATE
		Vehicle Identification Number from: 41085481 →; Fitting Position: Rear Axle		11.0101-5407.2 260011	Brake System: ATE
		Brake Disc Type: Solid; → Vehicle Identification Number to: 41085480; Fitting Position: Rear Axle		11.0101-5407.2 260011	Brake System: ATE
		Brake Disc Type: Vented; → Vehicle Identification Number to: 41085480; Fitting Position: Rear Axle		11.0101-5407.2 260011	Brake System: ATE
3.0 V6 CDTI	135 08/05→08/08	Fitting Position: Front Axle		11.0101-5407.2 260011	Brake System: ATE
		Vehicle Identification Number from: 41085481 →; Fitting Position: Rear Axle		11.0101-5407.2 260011	Brake System: ATE
		Brake Disc Type: Solid; → Vehicle Identification Number to: 41085480; Fitting Position: Rear Axle		11.0101-5407.2 260011	Brake System: ATE
		→ Vehicle Identification Number to: 41085480; Brake Disc Type: Internally Vented; Fitting Position: Rear Axle		11.0101-5407.2 260011	Brake System: ATE
Guide Bolt, brake caliper					
1.6	77 12/05→08/08	Vehicle Identification Number from: 41085481 →; Required quantity: 2	2	11.8171-0008.1 990049	Brake System: ATE
		Construction year from: 06/06 →; Required quantity: 2	2	11.8171-0008.1 990049	Brake System: ATE
		Construction year from: 06/06 →; → Vehicle Identification Number to: 41085480; Brake Disc Type: Solid; Required quantity: 2	2	11.8171-0008.1 990049	Brake System: ATE
		Construction year from: 06/06 →; → Vehicle Identification Number to: 41085480; Brake Disc Type: Internally Vented; Required quantity: 2	2	11.8171-0008.1 990049	Brake System: ATE
1.6 16V 1.8 1.9 CDTI 2.0 DTI 2.0 Turbo 2.2 direct 2.2 DTI	74 06/04→09/05	Vehicle Identification Number from: 41085481 →; Required quantity: 2	2	11.8171-0008.1 990049	Brake System: ATE
	90 10/03→09/06	Vehicle Identification Number from: 41085481 →; Required quantity: 2	2	11.8171-0008.1 990049	Brake System: ATE
	110 04/04→08/08	Required quantity: 2	2	11.8171-0008.1 990049	Brake System: ATE
	74 10/03→08/05	Required quantity: 2	2	11.8171-0008.1 990049	Brake System: ATE
	129 10/03→08/08	Brake Disc Type: Vented; → Vehicle Identification Number to: 41085480; Required quantity: 2	2	11.8171-0008.1 990049	Brake System: ATE
	114 10/03→08/08	Required quantity: 2	2	11.8171-0008.1 990049	Brake System: ATE
	92 10/03→12/05	Brake Disc Type: Solid; → Vehicle Identification Number to: 41085480; Required quantity: 2	2	11.8171-0008.1 990049	Brake System: ATE
1.8	103 08/05→08/08	Brake Disc Type: Solid; → Vehicle Identification Number to: 41085480; Required quantity: 2	2	11.8171-0008.1 990049	Brake System: ATE
		Vehicle Identification Number from: 41085481 →; Required quantity: 2	2	11.8171-0008.1 990049	Brake System: ATE
		→ Vehicle Identification Number to: 41085480; Brake Disc Type: Internally Vented; Required quantity: 2	2	11.8171-0008.1 990049	Brake System: ATE
		Suspension: for vehicles with sports suspension; Special Purpose Vehicle: for police vehicles; Required quantity: 2	2	11.8171-0008.1 990049	Brake System: ATE
		Suspension: for vehicles with sports suspension; Special Purpose Vehicle: not for police vehicles; Required quantity: 2	2	11.8171-0008.1 990049	Brake System: ATE
1.9 CDTI	74 06/05→08/08	Vehicle Identification Number from: 61000001 →; Suspension: for vehicles without sports suspension;	2	11.8171-0008.1 990049	Brake System: ATE
→					







	kW				
OPEL - VECTRA C Estate (Z02) 10/03→01/09					
Guide Bolt, brake caliper					
1.9 CDTI	74 06/05→08/08	Special Purpose Vehicle: not for police vehicles; Required quantity: 2			
		Vehicle Identification Number from: 41085481 →; Required quantity: 2	2	11.8171-0008.1 990049	Brake System: ATE
		Brake Disc Type: Solid; → Vehicle Identification Number to: 41085480; Required quantity: 2	2	11.8171-0008.1 990049	Brake System: ATE
		Suspension: for vehicles with sports suspension; Special Purpose Vehicle: for police vehicles; Required quantity: 2	2	11.8171-0008.1 990049	Brake System: ATE
		→ Vehicle Identification Number to: 41085480; Brake Disc Type: Internally Vented; Required quantity: 2	2	11.8171-0008.1 990049	Brake System: ATE
1.9 CDTI	88 04/04→01/09	Brake Disc Type: Solid; → Vehicle Identification Number to: 41085480; Required quantity: 2	2	11.8171-0008.1 990049	Brake System: ATE
		Vehicle Identification Number from: 41085481 →; → Construction year to: 10/08; Required quantity: 2	2	11.8171-0008.1 990049	Brake System: ATE
		Brake Disc Type: Vented; → Vehicle Identification Number to: 41085480; Required quantity: 2	2	11.8171-0008.1 990049	Brake System: ATE
		→ Construction year to: 10/08; Suspension: for vehicles without sports suspension; Special Purpose Vehicle: not for police vehicles; Required quantity: 2	2	11.8171-0008.1 990049	Brake System: ATE
		→ Construction year to: 10/08; Suspension: for vehicles with sports suspension; Special Purpose Vehicle: for police vehicles; Required quantity: 2	2	11.8171-0008.1 990049	Brake System: ATE
2.8 V6 Turbo	169 08/05→10/08	Vehicle Identification Number from: 41085481 →; Required quantity: 2	2	11.8171-0008.1 990049	Brake System: ATE
		Vehicle Identification Number from: 61000001 →; Required quantity: 2	2	11.8171-0008.1 990049	Brake System: ATE
2.8 V6 Turbo	184 08/05→08/08	Required quantity: 2	2	11.8171-0008.1 990049	Brake System: ATE
		Vehicle Identification Number from: 41085481 →; Required quantity: 2	2	11.8171-0008.1 990049	Brake System: ATE
2.8 V6 Turbo	188 08/05→09/08	Required quantity: 2	2	11.8171-0008.1 990049	Brake System: ATE
		Vehicle Identification Number from: 61000001 →; Required quantity: 2	2	11.8171-0008.1 990049	Brake System: ATE
2.8 V6 Turbo	206 07/06→08/08	Required quantity: 2	2	11.8171-0008.1 990049	Brake System: ATE
3.0 V6 CDTI 3.2 V6	130 10/03→07/05 155 10/03→07/05	Vehicle Identification Number from: 31070294 →; Required quantity: 2	2	11.8171-0008.1 990049	Brake System: ATE
		Vehicle Identification Number from: 41085481 →; Required quantity: 2	2	11.8171-0008.1 990049	Brake System: ATE
		Brake Disc Type: Vented; → Vehicle Identification Number to: 41085480; Required quantity: 2	2	11.8171-0008.1 990049	Brake System: ATE
		→ Vehicle Identification Number to: 31070293; Required quantity: 2	2	11.8171-0008.1 990049	Brake System: ATE
		Brake Disc Type: Solid; → Vehicle Identification Number to: 41085480; Required quantity: 2	2	11.8171-0008.1 990049	Brake System: ATE
3.0 V6 CDTI	135 08/05→08/08	Vehicle Identification Number from: 41085481 →; Required quantity: 2	2	11.8171-0008.1 990049	Brake System: ATE
		Required quantity: 2	2	11.8171-0008.1 990049	Brake System: ATE
		→ Vehicle Identification Number to: 41085480; Brake Disc Type: Internally Vented; Required quantity: 2	2	11.8171-0008.1 990049	Brake System: ATE
		Brake Disc Type: Solid; → Vehicle Identification Number to: 41085480; Required quantity: 2	2	11.8171-0008.1 990049	Brake System: ATE
OPEL - VECTRA C GTS (Z02) 08/02→01/09					
Spring, brake caliper					
1.6	74 - 08/05→08/08 77	Required quantity: 2;	2	11.8116-0356.1 390586	Brake System: ATE
1.9 CDTI	110 04/04→08/08	Brake Caliper Type: Cast iron brake caliper; Fitting Position: Front Axle			
2.0 DTI 16V	74 08/02→08/05				
→					





	kW				
OPEL - VECTRA C GTS (Z02) 08/02→01/09					
Spring, brake caliper					
1.8	103	08/05→08/08	Suspension: for vehicles with sports suspension; Required quantity: 2; Brake Caliper Type: Cast iron brake caliper; Fitting Position: Front Axle	2	11.8116-0356.1 390586 Brake System: ATE
			Suspension: for vehicles with sports suspension; Special Purpose Vehicle: for police vehicles; Required quantity: 2; Fitting Position: Front Axle	2	11.8116-0356.1 390586 Brake System: ATE
1.8 16V 2.2 16V 2.2 DGi 2.2 DTI 16V	81 - 08/02→09/08 90 108 08/02→08/08 114 10/03→08/08 86 - 08/02→06/08 92		Suspension: for vehicles without sports suspension; Required quantity: 2; Brake Caliper Type: Cast iron brake caliper; Fitting Position: Front Axle	2	11.8116-0356.1 390586 Brake System: ATE
1.9 CDTI	74	06/05→08/08	Vehicle Identification Number from: 61000001 →; Required quantity: 2; Fitting Position: Front Axle	2	11.8116-0356.1 390586 Brake System: ATE
1.9 CDTI	88	04/04→01/09	→ Construction year to: 10/08; Required quantity: 2; Brake Caliper Type: Cast iron brake caliper; Fitting Position: Front Axle	2	11.8116-0356.1 390586 Brake System: ATE
Guide Sleeve Kit, brake caliper					
1.6	74 - 08/05→08/08 77		Fitting Position: Front Axle		11.0101-5407.2 260011 Brake System: ATE
			Brake Disc Type: Solid; Fitting Position: Rear Axle		11.0101-5407.2 260011 Brake System: ATE
			Brake Disc Type: Internally Vented; Fitting Position: Rear Axle		11.0101-5407.2 260011 Brake System: ATE
1.8	103	08/05→08/08	Suspension: for vehicles with sports suspension; Fitting Position: Front Axle		11.0101-5407.2 260011 Brake System: ATE
			Suspension: for vehicles with sports suspension; Special Purpose Vehicle: for police vehicles; Fitting Position: Front Axle		11.0101-5407.2 260011 Brake System: ATE
			Brake Disc Type: Solid; Fitting Position: Rear Axle		11.0101-5407.2 260011 Brake System: ATE
			Brake Disc Type: Internally Vented; Fitting Position: Rear Axle		11.0101-5407.2 260011 Brake System: ATE
1.8 16V 1.9 CDTI 2.0 16V Turbo 2.0 DTI 16V 2.2 16V 2.2 DGi 2.2 DTI 16V	81 - 08/02→09/08 90 110 04/04→08/08 129 03/03→08/08 74 08/02→08/05 108 08/02→08/08 114 10/03→08/08 86 - 08/02→06/08 92		Fitting Position: Front Axle		11.0101-5407.2 260011 Brake System: ATE
			Brake Disc Type: Solid; Fitting Position: Rear Axle		11.0101-5407.2 260011 Brake System: ATE
			Brake Disc Type: Vented; Fitting Position: Rear Axle		11.0101-5407.2 260011 Brake System: ATE
1.9 CDTI 3.0 CDTi	74 06/05→08/08 135 08/05→08/08		Vehicle Identification Number from: 61000001 →; Fitting Position: Front Axle		11.0101-5407.2 260011 Brake System: ATE
			Brake Disc Type: Solid; Fitting Position: Rear Axle		11.0101-5407.2 260011 Brake System: ATE
			Brake Disc Type: Internally Vented; Fitting Position: Rear Axle		11.0101-5407.2 260011 Brake System: ATE
1.9 CDTI	88	04/04→01/09	→ Construction year to: 10/08; Fitting Position: Front Axle		11.0101-5407.2 260011 Brake System: ATE
			Brake Disc Type: Solid; → Construction year to: 10/08; Fitting Position: Rear Axle		11.0101-5407.2 260011 Brake System: ATE
			Brake Disc Type: Vented; → Construction year to: 10/08; Fitting Position: Rear Axle		11.0101-5407.2 260011 Brake System: ATE
2.8 V6 Turbo	169 - 08/05→08/08 184		Vehicle Identification Number from: 61000001 →; Trim Level: - OPC / -VXR; Fitting Position: Front Axle		11.0101-5407.2 260011 Brake System: ATE
			Vehicle Identification Number from: 61000001 →; Trim Level: + OPC / +VXR; Fitting Position: Front Axle		11.0101-5407.2 260011 Brake System: ATE
			Brake Disc Type: Solid; Fitting Position: Rear Axle		11.0101-5407.2 260011 Brake System: ATE
			Brake Disc Type: Internally Vented; Fitting Position: Rear Axle		11.0101-5407.2 260011 Brake System: ATE
2.8 V6 Turbo	188 - 08/05→09/08 206		Vehicle Identification Number from: 61000001 →; Fitting Position: Front Axle		11.0101-5407.2 260011 Brake System: ATE
			Fitting Position: Rear Axle		11.0101-5407.2 260011 Brake System: ATE
3.0 CDTI 3.2 V6 →	130 06/03→07/05 155 08/02→07/06		→ Vehicle Identification Number to: 31070293; Fitting Position: Front Axle		11.0101-5407.2 260011 Brake System: ATE



	kW				
OPEL - VECTRA C GTS (Z02) 08/02→01/09					
Guide Sleeve Kit, brake caliper					
3.0 CDTI 3.2 V6	130 06/03→07/05 155 08/02→07/06	Vehicle Identification Number from: 31070294 →; Fitting Position: Front Axle		11.0101-5407.2 260011	Brake System: ATE
		Brake Disc Type: Solid; Fitting Position: Rear Axle		11.0101-5407.2 260011	Brake System: ATE
		Brake Disc Type: Vented; Fitting Position: Rear Axle		11.0101-5407.2 260011	Brake System: ATE
Guide Bolt, brake caliper					
1.6	74 - 08/05→08/08 77	Required quantity: 2	2	11.8171-0008.1 990049	Brake System: ATE
		Brake Disc Type: Solid; Required quantity: 2	2	11.8171-0008.1 990049	Brake System: ATE
		Brake Disc Type: Internally Vented; Required quantity: 2	2	11.8171-0008.1 990049	Brake System: ATE
1.8	103 08/05→08/08	Brake Disc Type: Solid; Required quantity: 2	2	11.8171-0008.1 990049	Brake System: ATE
		Brake Disc Type: Internally Vented; Required quantity: 2	2	11.8171-0008.1 990049	Brake System: ATE
		Suspension: for vehicles with sports suspension; Special Purpose Vehicle: for police vehi- cles; Required quantity: 2	2	11.8171-0008.1 990049	Brake System: ATE
		Suspension: for vehicles with sports suspension; Required quantity: 2	2	11.8171-0008.1 990049	Brake System: ATE
1.8 16V	81 - 08/02→09/08 90	Required quantity: 2	2	11.8171-0008.1 990049	Brake System: ATE
1.9 CDTI	110 04/04→08/08	Brake Disc Type: Solid; Required quantity: 2	2	11.8171-0008.1 990049	Brake System: ATE
2.0 16V Turbo	129 03/03→08/08	Brake Disc Type: Vented; Required quantity: 2	2	11.8171-0008.1 990049	Brake System: ATE
2.0 DTI 16V	74 08/02→08/05				
2.2 16V	108 08/02→08/08				
2.2 DGi	114 10/03→08/08				
2.2 DTI 16V	86 - 08/02→06/08 92				
1.9 CDTI	74 06/05→08/08	Brake Disc Type: Solid; Required quantity: 2	2	11.8171-0008.1 990049	Brake System: ATE
3.0 CDTI	135 08/05→08/08	Brake Disc Type: Internally Vented; Required quantity: 2	2	11.8171-0008.1 990049	Brake System: ATE
		Vehicle Identification Number from: 61000001 →; Required quantity: 2	2	11.8171-0008.1 990049	Brake System: ATE
1.9 CDTI	88 04/04→01/09	→ Construction year to: 10/08; Required quantity: 2	2	11.8171-0008.1 990049	Brake System: ATE
		Brake Disc Type: Solid; → Construction year to: 10/08; Required quantity: 2	2	11.8171-0008.1 990049	Brake System: ATE
		Brake Disc Type: Vented; → Construction year to: 10/08; Required quantity: 2	2	11.8171-0008.1 990049	Brake System: ATE
2.8 V6 Turbo	169 - 08/05→08/08 184	Brake Disc Type: Solid; Required quantity: 2	2	11.8171-0008.1 990049	Brake System: ATE
		Brake Disc Type: Internally Vented; Required quantity: 2	2	11.8171-0008.1 990049	Brake System: ATE
		Vehicle Identification Number from: 61000001 →; Trim Level: - OPC / -VXR; Required quantity: 2	2	11.8171-0008.1 990049	Brake System: ATE
		Vehicle Identification Number from: 61000001 →; Trim Level: + OPC / +VXR; Required quantity: 2	2	11.8171-0008.1 990049	Brake System: ATE
2.8 V6 Turbo	188 - 08/05→09/08 206	Required quantity: 2	2	11.8171-0008.1 990049	Brake System: ATE
		Vehicle Identification Number from: 61000001 →; Required quantity: 2	2	11.8171-0008.1 990049	Brake System: ATE
3.0 CDTI	130 06/03→07/05	Brake Disc Type: Solid; Required quantity: 2	2	11.8171-0008.1 990049	Brake System: ATE
3.2 V6	155 08/02→07/06	Brake Disc Type: Vented; Required quantity: 2	2	11.8171-0008.1 990049	Brake System: ATE
		→ Vehicle Identification Number to: 31070293; Required quantity: 2	2	11.8171-0008.1 990049	Brake System: ATE
		Vehicle Identification Number from: 31070294 →; Required quantity: 2	2	11.8171-0008.1 990049	Brake System: ATE
OPEL - VIVARO A Bus (X83) 08/01→07/14					
 Brake Caliper					
1.9 DI	60 08/01→07/06	Vehicle Identification Number from: 2V607599 →;		24.3414-1707.5 240337	Brake System: Lucas / TRW
2.0 16V	88 08/01→07/06	Fitting Position: Rear Axle Left			Supplementary Article/Supple- mentary Info: without holder
2.5 CDTI	84 08/06→03/10				Brake Caliper Type: Fist-type
2.5 DTI	99 04/03→03/10				Caliper
→					

	kW				
OPEL - VIVARO A Bus (X83) 08/01→07/14					
 Brake Caliper					
1.9 DI 2.0 16V 2.5 CDTI 2.5 DTI	60 08/01→07/06 88 08/01→07/06 84 08/06→03/10 99 04/03→03/10	Vehicle Identification Number from: 2V607599 →; Fitting Position: Rear Axle Right		24.3414-1708.5 240338	Brake System: Lucas / TRW Supplementary Article/Supplementary Info: without holder Brake Caliper Type: Fist-type Caliper
1.9 DTI 2.0 CDTI 2.0 ECOTEC 2.5 CDTI	74 08/01→07/14 66 - 08/06→07/14 84 86 08/06→07/14 107 08/06→07/14	Vehicle Identification Number from: 2V607599 →; → Construction year to: 06/14; Fitting Position: Rear Axle Left		24.3414-1707.5 240337	Brake System: Lucas / TRW Supplementary Article/Supplementary Info: without holder Brake Caliper Type: Fist-type Caliper
		Vehicle Identification Number from: 2V607599 →; → Construction year to: 06/14; Fitting Position: Rear Axle Right		24.3414-1708.5 240338	Brake System: Lucas / TRW Supplementary Article/Supplementary Info: without holder Brake Caliper Type: Fist-type Caliper
 Brake Pad Set, disc brake					
1.9 DI 2.0 16V 2.5 CDTI 2.5 DTI	60 08/01→07/06 88 08/01→07/06 84 08/06→03/10 99 04/03→03/10	Fitting Position: Rear Axle		13.0460-2840.2 602840	Brake System: Lucas / TRW 23980 16,5 Wear Warning Contact: prepared for wear indicator / excl. wear warning contact
1.9 DTI 2.0 CDTI 2.0 ECOTEC 2.5 CDTI	74 08/01→07/14 66 - 08/06→07/14 84 86 08/06→07/14 107 08/06→07/14	→ Construction year to: 06/14; Fitting Position: Rear Axle		13.0460-2840.2 602840	Brake System: Lucas / TRW 23980 16,5 Wear Warning Contact: prepared for wear indicator / excl. wear warning contact
 Brake Hose					
1.9 DI 2.0 16V 2.5 CDTI 2.5 DTI	60 08/01→07/06 88 08/01→07/06 84 08/06→03/10 99 04/03→03/10	Required quantity: 2; Fitting Position: Rear Axle		2 24.5229-0200.3 330572	Length [mm]: 200
1.9 DTI 2.0 CDTI 2.0 ECOTEC 2.5 CDTI	74 08/01→07/14 66 - 08/06→07/14 84 86 08/06→07/14 107 08/06→07/14	→ Construction year to: 06/14; Required quantity: 2; Fitting Position: Rear Axle		2 24.5229-0200.3 330572	Length [mm]: 200
 Wheel Speed Sensor					
1.9 DI 1.9 DTI 2.0 16V 2.0 CDTI	60 08/01→07/06 74 08/01→07/14 88 08/01→07/06 66 - 08/06→07/14	Vehicle Identification Number from: 2V603869 → → Vehicle Identification Number to: 7V631679 / 7Y999999; Required quantity: 2; Fitting Position: Front Axle		2 24.0710-2097.3 360647	Length [mm]: 720
2.0 ECOTEC 2.5 CDTI 2.5 DTI	86 08/06→07/14 84 - 08/06→07/14 107 99 04/03→03/10	Vehicle Identification Number from: 9V620474 / 9Y708999 →; Required quantity: 2; Fitting Position: Rear Axle		2 24.0710-2100.3 360649	Length [mm]: 956
OPEL - VIVARO A Platform/Chassis (X83) 02/01→07/14					
 Brake Caliper					
1.9 Di 2.0 CDTI	60 08/01→07/14 66 - 01/06→07/14 84	Vehicle Identification Number from: 2V607599 →; → Construction year to: 06/14; Fitting Position: Rear Axle Left		24.3414-1707.5 240337	Brake System: Lucas / TRW Supplementary Article/Supplementary Info: without holder Brake Caliper Type: Fist-type Caliper
2.0 ECOTEC 2.5 CDTI	86 08/06→07/14 107 08/06→07/14	Vehicle Identification Number from: 2V607599 →; → Construction year to: 06/14; Fitting Position: Rear Axle Right		24.3414-1708.5 240338	Brake System: Lucas / TRW Supplementary Article/Supplementary Info: without holder Brake Caliper Type: Fist-type Caliper
1.9 DTI 2.0 16V 2.5 CDTI 2.5 DTI	74 02/01→12/10 88 01/02→07/06 84 08/06→03/10 99 04/03→03/10	Vehicle Identification Number from: 2V607599 →; Fitting Position: Rear Axle Left		24.3414-1707.5 240337	Brake System: Lucas / TRW Supplementary Article/Supplementary Info: without holder Brake Caliper Type: Fist-type Caliper
		Vehicle Identification Number from: 2V607599 →; Fitting Position: Rear Axle Right		24.3414-1708.5 240338	Brake System: Lucas / TRW Supplementary Article/Supplementary Info: without holder Brake Caliper Type: Fist-type Caliper
→					





	kW				
OPEL - VIVARO A Platform/Chassis (X83) 02/01→07/14					
 Brake Pad Set, disc brake					
1.9 Di 2.0 CDTI	60 08/01→07/14 66 01/06→07/14	Construction year from: 08/06 → → Construction year to: 06/14; Fitting Position: Rear Axle		13.0460-2840.2 602840	Brake System: Lucas / TRW 23980 16,5 Wear Warning Contact: prepared for wear indicator / excl. wear warning contact
1.9 DTI 2.0 16V 2.5 CDTI	74 02/01→12/10 88 01/02→07/06 84 08/06→03/10	Fitting Position: Rear Axle		13.0460-2840.2 602840	Brake System: Lucas / TRW 23980 16,5 Wear Warning Contact: prepared for wear indicator / excl. wear warning contact
2.0 CDTI 2.0 ECOTEC 2.5 CDTI	84 08/06→07/14 86 08/06→07/14 107 08/06→07/14	→ Construction year to: 06/14; Fitting Position: Rear Axle		13.0460-2840.2 602840	Brake System: Lucas / TRW 23980 16,5 Wear Warning Contact: prepared for wear indicator / excl. wear warning contact
2.5 DTi	99 04/03→03/10	Construction year from: 08/06 →; Fitting Position: Rear Axle		13.0460-2840.2 602840	Brake System: Lucas / TRW 23980 16,5 Wear Warning Contact: prepared for wear indicator / excl. wear warning contact
 Brake Hose					
1.9 Di 2.0 CDTI	60 08/01→07/14 66 01/06→07/14	Construction year from: 08/06 → → Construction year to: 06/14; Required quantity: 2; Fitting Position: Rear Axle	2	24.5229-0200.3 330572	Length [mm]: 200
1.9 DTI 2.0 16V 2.5 CDTI	74 02/01→12/10 88 01/02→07/06 84 08/06→03/10	Required quantity: 2; Fitting Position: Rear Axle	2	24.5229-0200.3 330572	Length [mm]: 200
2.0 CDTI 2.0 ECOTEC 2.5 CDTI	84 08/06→07/14 86 08/06→07/14 107 08/06→07/14	→ Construction year to: 06/14; Required quantity: 2; Fitting Position: Rear Axle	2	24.5229-0200.3 330572	Length [mm]: 200
2.5 DTi	99 04/03→03/10	Construction year from: 08/06 →; Required quantity: 2; Fitting Position: Rear Axle	2	24.5229-0200.3 330572	Length [mm]: 200
 Wheel Speed Sensor					
1.9 Di 1.9 DTI 2.0 16V 2.0 CDTI	60 08/01→07/14 74 02/01→12/10 88 01/02→07/06 66 - 01/06→07/14 84	Vehicle Identification Number from: 2V603869 → → Vehicle Identification Number to: 7V631679 / 7Y999999; Required quantity: 2; Fitting Position: Front Axle	2	24.0710-2097.3 360647	Length [mm]: 720
2.0 ECOTEC 2.5 CDTI	86 08/06→07/14 84 - 08/06→07/14 107	Vehicle Identification Number from: 9V620474 / 9Y708999 →; Required quantity: 2; Fitting Position: Rear Axle	2	24.0710-2100.3 360649	Length [mm]: 956
2.5 DTi	99 04/03→03/10	Vehicle Identification Number from: 2V603969 → → Vehicle Identification Number to: 7V631679 / 7Y999999; Required quantity: 2; Fitting Position: Front Axle	2	24.0710-2097.3 360647	Length [mm]: 720
		Vehicle Identification Number from: 9V620474 / 9Y708999 →; Required quantity: 2; Fitting Position: Rear Axle	2	24.0710-2100.3 360649	Length [mm]: 956
OPEL - VIVARO A Van (X83) 08/01→07/14					
 Brake Caliper					
1.9 DI 2.0 16V 2.5 CDTI 2.5 DTI	60 08/01→07/06 88 08/01→07/06 84 08/06→03/10 99 04/03→03/10	Vehicle Identification Number from: 2V607599 →; Fitting Position: Rear Axle Left		24.3414-1707.5 240337	Brake System: Lucas / TRW Supplementary Article/Supple- mentary Info: without holder Brake Caliper Type: Fist-type Caliper
		Vehicle Identification Number from: 2V607599 →; Fitting Position: Rear Axle Right		24.3414-1708.5 240338	Brake System: Lucas / TRW Supplementary Article/Supple- mentary Info: without holder Brake Caliper Type: Fist-type Caliper
1.9 DTI 2.0 CDTI 2.0 ECOTEC 2.5 CDTI	74 08/01→07/14 66 - 08/06→07/14 84 86 08/06→07/14 107 08/06→07/14	Vehicle Identification Number from: 2V607599 →; → Construction year to: 06/14; Fitting Position: Rear Axle Left		24.3414-1707.5 240337	Brake System: Lucas / TRW Supplementary Article/Supple- mentary Info: without holder Brake Caliper Type: Fist-type Caliper
→					

	kW				
OPEL - VIVARO A Van (X83) 08/01→07/14					
 Brake Caliper					
1.9 DTI	74	08/01→07/14	Vehicle Identification Number from: 2V607599 →; → Construction year to: 06/14; Fitting Position: Rear Axle Right	24.3414-1708.5 240338	Brake System: Lucas / TRW Supplementary Article/Supplementary Info: without holder Brake Caliper Type: Fist-type Caliper
2.0 CDTI	66 - 84	08/06→07/14			
2.0 ECOTEC	86	08/06→07/14			
2.5 CDTI	107	08/06→07/14			
 Brake Pad Set, disc brake					
1.9 DI	60	08/01→07/06	Fitting Position: Rear Axle	13.0460-2840.2 602840	Brake System: Lucas / TRW 23980 16,5 Wear Warning Contact: prepared for wear indicator / excl. wear warning contact
2.0 16V	88	08/01→07/06			
2.5 CDTI	84	08/06→03/10			
2.5 DTI	99	04/03→03/10			
1.9 DTI	74	08/01→07/14	→ Construction year to: 06/14; Fitting Position: Rear Axle	13.0460-2840.2 602840	Brake System: Lucas / TRW 23980 16,5 Wear Warning Contact: prepared for wear indicator / excl. wear warning contact
2.0 CDTI	66 - 84	08/06→07/14			
2.0 ECOTEC	86	08/06→07/14			
2.5 CDTI	107	08/06→07/14			
 Brake Hose					
1.9 DI	60	08/01→07/06	Required quantity: 2; Fitting Position: Rear Axle	2 24.5229-0200.3 330572	Length [mm]: 200
2.0 16V	88	08/01→07/06			
2.5 CDTI	84	08/06→03/10			
2.5 DTI	99	04/03→03/10			
1.9 DTI	74	08/01→07/14	→ Construction year to: 06/14; Required quantity: 2; Fitting Position: Rear Axle	2 24.5229-0200.3 330572	Length [mm]: 200
2.0 CDTI	66 - 84	08/06→07/14			
2.0 ECOTEC	86	08/06→07/14			
2.5 CDTI	107	08/06→07/14			
 Wheel Speed Sensor					
1.9 DI	60	08/01→07/06	Vehicle Identification Number from: 2V603869 → → Vehicle Identification Number to: 7V631679 / 7Y999999; Required quantity: 2; Fitting Position: Front Axle	2 24.0710-2097.3 360647	Length [mm]: 720
1.9 DTI	74	08/01→07/14			
2.0 16V	88	08/01→07/06			
2.0 CDTI	66 - 84	08/06→07/14			
2.0 ECOTEC	86	08/06→07/14	Vehicle Identification Number from: 9V620474 / 9Y708999 →; Required quantity: 2; Fitting Position: Rear Axle	2 24.0710-2100.3 360649	Length [mm]: 956
2.5 CDTI	84 - 107	08/06→07/14			
2.5 DTI	99	04/03→03/10			
OPEL - VIVARO B Bus (X82) 06/14→12/19					
 Brake Caliper					
1.6 CDTI	66 - 103	06/14→12/19	Construction year from: 07/14 →; Fitting Position: Rear Axle Left	24.3414-1707.5 240337	Brake System: Lucas / TRW Supplementary Article/Supplementary Info: without holder Brake Caliper Type: Fist-type Caliper
			Construction year from: 07/14 →; Fitting Position: Rear Axle Right		
1.6 CDTI	70 - 107	04/15→12/19	Fitting Position: Rear Axle Left	24.3414-1707.5 240337	Brake System: Lucas / TRW Supplementary Article/Supplementary Info: without holder Brake Caliper Type: Fist-type Caliper
			Fitting Position: Rear Axle Right		
 Brake Pad Set, disc brake					
1.6 CDTI	66 - 103	06/14→12/19	Construction year from: 07/14 →; Fitting Position: Rear Axle	13.0460-2840.2 602840	Brake System: Lucas / TRW 23980 16,5 Wear Warning Contact: prepared for wear indicator / excl. wear warning contact
1.6 CDTI	70 - 107	04/15→12/19	Fitting Position: Rear Axle	13.0460-2840.2 602840	Brake System: Lucas / TRW 23980 16,5 Wear Warning Contact: prepared for wear indicator / excl. wear warning contact
→					



	kW				
OPEL - VIVARO B Bus (X82) 06/14→12/19					
 Brake Disc					
1.6 CDTI	66 - 06/14→12/19 103	Construction year from: 07/14 →; Fitting Position: Front Axle	24.0128-0287.1 428287	Outer diameter [mm]: 296 Brake Disc Thickness [mm] 28 Minimum thickness [mm] 23.4 Brake Disc Type: Vented Supplementary Article/Info 2: with bolts/screws	
1.6 CDTI	70 - 04/15→12/19 107	Fitting Position: Front Axle	24.0128-0287.1 428287	Outer diameter [mm]: 296 Brake Disc Thickness [mm] 28 Minimum thickness [mm] 23.4 Brake Disc Type: Vented Supplementary Article/Info 2: with bolts/screws	
OPEL - VIVARO B Platform/Chassis (X82) 06/14→12/19					
 Brake Caliper					
1.6 CDTI	85 06/14→12/16	Construction year from: 07/14 →; Fitting Position: Rear Axle Left	24.3414-1707.5 240337	Brake System: Lucas / TRW Supplementary Article/Supplementary Info: without holder Brake Caliper Type: Fist-type Caliper	
		Construction year from: 07/14 →; Fitting Position: Rear Axle Right	24.3414-1708.5 240338	Brake System: Lucas / TRW Supplementary Article/Supplementary Info: without holder Brake Caliper Type: Fist-type Caliper	
1.6 CDTI	88 - 08/15→12/19 107	Fitting Position: Rear Axle Left	24.3414-1707.5 240337	Brake System: Lucas / TRW Supplementary Article/Supplementary Info: without holder Brake Caliper Type: Fist-type Caliper	
		Fitting Position: Rear Axle Right	24.3414-1708.5 240338	Brake System: Lucas / TRW Supplementary Article/Supplementary Info: without holder Brake Caliper Type: Fist-type Caliper	
 Brake Pad Set, disc brake					
1.6 CDTI	85 06/14→12/16	Construction year from: 07/14 →; Fitting Position: Rear Axle	13.0460-2840.2 602840	Brake System: Lucas / TRW 23980 16,5 Wear Warning Contact: prepared for wear indicator / excl. wear warning contact	
1.6 CDTI	88 - 08/15→12/19 107	Fitting Position: Rear Axle	13.0460-2840.2 602840	Brake System: Lucas / TRW 23980 16,5 Wear Warning Contact: prepared for wear indicator / excl. wear warning contact	
 Brake Disc					
1.6 CDTI	85 06/14→12/16	Construction year from: 07/14 →; Fitting Position: Front Axle	24.0128-0287.1 428287	Outer diameter [mm]: 296 Brake Disc Thickness [mm] 28 Minimum thickness [mm] 23.4 Brake Disc Type: Vented Supplementary Article/Info 2: with bolts/screws	
1.6 CDTI	88 - 08/15→12/19 107	Fitting Position: Front Axle	24.0128-0287.1 428287	Outer diameter [mm]: 296 Brake Disc Thickness [mm] 28 Minimum thickness [mm] 23.4 Brake Disc Type: Vented Supplementary Article/Info 2: with bolts/screws	
OPEL - VIVARO B Van (X82) 06/14→12/19					
 Brake Caliper					
1.6 CDTI	66 - 06/14→12/19 103	Construction year from: 07/14 →; Fitting Position: Rear Axle Left	24.3414-1707.5 240337	Brake System: Lucas / TRW Supplementary Article/Supplementary Info: without holder Brake Caliper Type: Fist-type Caliper	
		Construction year from: 07/14 →; Fitting Position: Rear Axle Right	24.3414-1708.5 240338	Brake System: Lucas / TRW Supplementary Article/Supplementary Info: without holder Brake Caliper Type: Fist-type Caliper	
→					



	kW				
OPEL - VIVARO B Van (X82) 06/14→12/19					
 Brake Caliper					
1.6 CDTI	70 - 03/16→12/19 107	Fitting Position: Rear Axle Left		24.3414-1707.5 240337	Brake System: Lucas / TRW Supplementary Article/Supplementary Info: without holder Brake Caliper Type: Fist-type Caliper
		Fitting Position: Rear Axle Right		24.3414-1708.5 240338	Brake System: Lucas / TRW Supplementary Article/Supplementary Info: without holder Brake Caliper Type: Fist-type Caliper
 Brake Pad Set, disc brake					
1.6 CDTI	66 - 06/14→12/19 103	Construction year from: 07/14 →; Fitting Position: Rear Axle		13.0460-2840.2 602840	Brake System: Lucas / TRW 23980 16,5 Wear Warning Contact: prepared for wear indicator / excl. wear warning contact
1.6 CDTI	70 - 03/16→12/19 107	Fitting Position: Rear Axle		13.0460-2840.2 602840	Brake System: Lucas / TRW 23980 16,5 Wear Warning Contact: prepared for wear indicator / excl. wear warning contact
 Brake Disc					
1.6 CDTI	66 - 06/14→12/19 103	Construction year from: 07/14 →; Fitting Position: Front Axle		24.0128-0287.1 428287	Outer diameter [mm]: 296 Brake Disc Thickness [mm] 28 Minimum thickness [mm] 23.4 Brake Disc Type: Vented Supplementary Article/Info 2: with bolts/screws
1.6 CDTI	70 - 03/16→12/19 107	Fitting Position: Front Axle		24.0128-0287.1 428287	Outer diameter [mm]: 296 Brake Disc Thickness [mm] 28 Minimum thickness [mm] 23.4 Brake Disc Type: Vented Supplementary Article/Info 2: with bolts/screws
OPEL - ZAFIRA / ZAFIRA FAMILY B (A05) 07/05→05/19					
Spring, brake caliper					
2.0	177 01/06→12/10	Required quantity: 2; Fitting Position: Front Axle		2 11.8116-0356.1 390586	Brake System: ATE
Guide Sleeve Kit, brake caliper					
1.6	77 - 07/05→04/15 85	Fitting Position: Front Axle		11.0101-5407.2 260011	Brake System: ATE
1.6 CNG	69 07/05→04/15				
1.6 CNG Turbo	110 04/10→04/15				
1.6 FlexFuel	85 08/08→12/12				
1.9 CDTI	74 - 07/05→04/15 110				
2.0	147 - 07/05→12/10 177				
2.2	110 07/05→12/12				
1.7 CDTI	81 - 03/07→04/15 92	for brake disc diameter [mm]: 308; Fitting Position: Front Axle		11.0101-5407.2 260011	Brake System: ATE
1.8	88 - 07/05→04/15 103	for brake disc diameter [mm]: 280; Fitting Position: Front Axle		11.0101-5407.2 260011	Brake System: ATE
1.8 LPG	103 07/09→04/15				
Guide Bolt, brake caliper					
1.6	77 - 07/05→04/15 85	Required quantity: 2		2 11.8171-0008.1 990049	Brake System: ATE
1.6 CNG	69 07/05→04/15				
1.6 CNG Turbo	110 04/10→04/15				
1.6 FlexFuel	85 08/08→12/12				
1.9 CDTI	74 - 07/05→04/15 110				
2.0	147 - 07/05→12/10 177				
2.2	110 07/05→12/12				
1.7 CDTI	81 - 03/07→04/15 92	for brake disc diameter [mm]: 308; Required quantity: 2		2 11.8171-0008.1 990049	Brake System: ATE
1.8	88 - 07/05→04/15 103	for brake disc diameter [mm]: 280; Required quantity: 2		2 11.8171-0008.1 990049	Brake System: ATE
1.8 LPG	103 07/09→04/15				



	kW				
OPEL - ZAFIRA A MPV (T98) 04/99→06/05					
Guide Sleeve Kit, brake caliper					
1.6	76	10/03→06/05	Fitting Position: Front Axle	11.0101-5407.2 260011	Brake System: ATE
1.6 16V	74	04/99→06/05			
1.6 CNG	71	09/01→06/05			
1.6 LPG	74 - 76	04/99→06/05			
1.8 16V	85 - 92	04/99→06/05			
2.0 DTI 16V	74	09/00→06/05			
2.0 OPC	141 - 147	09/01→06/05			
2.2 16V	108	09/00→06/05			
2.2 DTI 16V	86 - 92	01/02→06/05			
2.0 DI 16V	60	07/99→06/05	Construction year from: 10/99 →; Fitting Position: Front Axle	11.0101-5407.2 260011	Brake System: ATE
Guide Bolt, brake caliper					
1.6	76	10/03→06/05	Required quantity: 2;	2 11.8171-0008.1 990049	Brake System: ATE
1.6 16V	74	04/99→06/05	Fitting Position: Front Axle		
1.6 CNG	71	09/01→06/05			
1.6 LPG	74 - 76	04/99→06/05			
1.8 16V	85 - 92	04/99→06/05			
2.0 DTI 16V	74	09/00→06/05			
2.0 OPC	141 - 147	09/01→06/05			
2.2 16V	108	09/00→06/05			
2.2 DTI 16V	86 - 92	01/02→06/05			
2.0 DI 16V	60	07/99→06/05	Construction year from: 10/99 →; Required quantity: 2; Fitting Position: Front Axle	2 11.8171-0008.1 990049	Brake System: ATE
OPEL - ZAFIRA B Box Body/MPV (A05) 07/05→04/15					
Guide Sleeve Kit, brake caliper					
1.6 CNG Turbo VAN	110	02/09→04/15	Fitting Position: Front Axle	11.0101-5407.2 260011	Brake System: ATE
1.6 CNG VAN	69	07/05→04/15	for brake disc diameter [mm]: 308;	11.0101-5407.2 260011	Brake System: ATE
1.7 CDTI VAN	81 - 92	01/08→04/15	Fitting Position: Front Axle		
1.8 VAN	103	07/05→04/15	for brake disc diameter [mm]: 280;	11.0101-5407.2 260011	Brake System: ATE
1.9 CDTI VAN	88 - 110	07/05→04/15	Fitting Position: Front Axle		
2.0 VAN	147	07/05→12/10			
2.2 DGi VAN	110	07/05→12/11			
Guide Bolt, brake caliper					
1.6 CNG Turbo VAN	110	02/09→04/15	Required quantity: 2	2 11.8171-0008.1 990049	Brake System: ATE
1.6 CNG VAN	69	07/05→04/15	for brake disc diameter [mm]: 308;	2 11.8171-0008.1 990049	Brake System: ATE
1.7 CDTI VAN	81 - 92	01/08→04/15	Required quantity: 2		
1.8 VAN	103	07/05→04/15	for brake disc diameter [mm]: 280;	2 11.8171-0008.1 990049	Brake System: ATE
1.9 CDTI VAN	88 - 110	07/05→04/15	Required quantity: 2		
2.0 VAN	147	07/05→12/10			
2.2 DGi VAN	110	07/05→12/11			
OPEL - ZAFIRA TOURER C (P12) 10/11→					
 Brake Caliper					
1.4	88 - 103	10/11→	Construction year from: 11/11 →; for brake disc diameter [mm]: 292;	24.3402-7003.5 241457	Brake System: ATE Supplementary Article/Supplementary Info: without holder
1.4 LPG	103	10/11→	Vehicle Equipment: for vehicles with electric parking brake;		Brake Caliper Type: Fist-type Caliper
1.6 CNG	110	10/11→	Fitting Position: Rear Axle Left		
1.8	85 - 103	10/11→			
2.0 CDTi	81	10/11→	Construction year from: 11/11 →; for brake disc diameter [mm]: 292;	24.3402-7004.5 241458	Brake System: ATE Supplementary Article/Supplementary Info: without holder
			Vehicle Equipment: for vehicles with electric parking brake;		Brake Caliper Type: Fist-type Caliper
			Fitting Position: Rear Axle Right		
1.6	100 - 125	12/12→	for brake disc diameter [mm]: 292;	24.3402-7003.5 241457	Brake System: ATE Supplementary Article/Supplementary Info: without holder
1.6 CDTI	88 - 99	07/14→	Vehicle Equipment: for vehicles with electric parking brake;		Brake Caliper Type: Fist-type Caliper
1.6 SIDI	147	07/13→	Fitting Position: Rear Axle Left		
2.0 BiTurbo CDTI	143	01/13→			
2.0 CDTi	96 - 125	10/11→			
→					

	kW				
OPEL - ZAFIRA TOURER C (P12) 10/11→					
 Brake Caliper					
1.6	100 - 12/12→ 125		for brake disc diameter [mm]: 292; Vehicle Equipment: for vehicles with electric parking brake; Fitting Position: Rear Axle Right	24.3402-7004.5 241458	Brake System: ATE Supplementary Article/Supple- mentary Info: without holder Brake Caliper Type: Fist-type Caliper
1.6 CDTI	88 - 07/14→ 99				
1.6 SIDI	147 07/13→				
2.0 BiTurbo CDTI	143 01/13→				
2.0 CDTi	96 - 10/11→ 125				
1.6 CDTI	100 02/13→		Construction year from: 03/13 →; for brake disc diameter [mm]: 292; Vehicle Equipment: for vehicles with electric parking brake; Fitting Position: Rear Axle Left	24.3402-7003.5 241457	Brake System: ATE Supplementary Article/Supple- mentary Info: without holder Brake Caliper Type: Fist-type Caliper
			Construction year from: 03/13 →; for brake disc diameter [mm]: 292; Vehicle Equipment: for vehicles with electric parking brake; Fitting Position: Rear Axle Right	24.3402-7004.5 241458	Brake System: ATE Supplementary Article/Supple- mentary Info: without holder Brake Caliper Type: Fist-type Caliper
 Brake Disc					
1.4	88 - 10/11→ 103		Construction year from: 11/11 →; Fitting Position: Front Axle	24.0326-0166.1 526166	Outer diameter [mm]: 300 Brake Disc Thickness [mm] 26 Minimum thickness [mm] 23 Brake Disc Type: Vented Supplementary Article/Info 2: with bolts/screws
1.4 LPG	103 10/11→				
1.6 CNG	110 10/11→				
1.8	85 - 10/11→ 103				
2.0 CDTI	81 10/11→		Construction year from: 11/11 →; Fitting Position: Rear Axle	24.0312-0189.1 512189	Outer diameter [mm]: 292 Brake Disc Thickness [mm] 12 Minimum thickness [mm] 10 Brake Disc Type: Solid Supplementary Article/Info 2: with bolts/screws
1.6	100 - 12/12→ 125		Fitting Position: Front Axle	24.0326-0166.1 526166	Outer diameter [mm]: 300 Brake Disc Thickness [mm] 26 Minimum thickness [mm] 23 Brake Disc Type: Vented Supplementary Article/Info 2: with bolts/screws
1.6 CDTI	88 - 07/14→ 99				
1.6 SIDI	147 07/13→				
2.0 BiTurbo CDTI	143 01/13→				
2.0 CDTI	96 - 10/11→ 125		Fitting Position: Rear Axle	24.0312-0189.1 512189	Outer diameter [mm]: 292 Brake Disc Thickness [mm] 12 Minimum thickness [mm] 10 Brake Disc Type: Solid Supplementary Article/Info 2: with bolts/screws
1.6 CDTI	100 02/13→		Construction year from: 03/13 →; Fitting Position: Front Axle	24.0326-0166.1 526166	Outer diameter [mm]: 300 Brake Disc Thickness [mm] 26 Minimum thickness [mm] 23 Brake Disc Type: Vented Supplementary Article/Info 2: with bolts/screws
			Construction year from: 03/13 →; Fitting Position: Rear Axle	24.0312-0189.1 512189	Outer diameter [mm]: 292 Brake Disc Thickness [mm] 12 Minimum thickness [mm] 10 Brake Disc Type: Solid Supplementary Article/Info 2: with bolts/screws
OPEL - ZAFIRA TOURER C VAN (P12) 10/11→					
 Brake Caliper					
2.0 CDTI	81 - 01/12→ 121		for brake disc diameter [mm]: 292; Vehicle Equipment: for vehicles with electric parking brake; Fitting Position: Rear Axle Left	24.3402-7003.5 241457	Brake System: ATE Supplementary Article/Supple- mentary Info: without holder Brake Caliper Type: Fist-type Caliper
			for brake disc diameter [mm]: 292; Vehicle Equipment: for vehicles with electric parking brake; Fitting Position: Rear Axle Right	24.3402-7004.5 241458	Brake System: ATE Supplementary Article/Supple- mentary Info: without holder Brake Caliper Type: Fist-type Caliper
 Brake Disc					
2.0 CDTi	81 - 01/12→ 121		Fitting Position: Front Axle	24.0326-0166.1 526166	Outer diameter [mm]: 300 Brake Disc Thickness [mm] 26 Minimum thickness [mm] 23 Brake Disc Type: Vented Supplementary Article/Info 2: with bolts/screws

	kW				
OPEL - ZAFIRA TOURER C VAN (P12) 10/11→					
 Brake Disc					
2.0 CDTi	81 - 01/12→ 121	Fitting Position: Rear Axle		24.0312-0189.1 512189	Outer diameter [mm]: 292 Brake Disc Thickness [mm] 12 Minimum thickness [mm] 10 Brake Disc Type: Solid Supplementary Article/Info 2: with bolts/screws
PEUGEOT - 106 I (1A, 1C) 08/91→04/96					
Guide Sleeve Kit, brake caliper					
1.3	72 10/93→04/96	Vehicle Identification Number from: S		11.0101-5407.2 260011	Brake System: ATE
1.6	76 11/94→04/96	51132347 →; Fitting Position: Front Axle			
1.4	51 - 08/91→04/96	Vehicle Identification Number from: S		11.0101-5407.2 260011	Brake System: ATE
1.4 D	55	51132347 →; + ABS;			
1.5 D	37 09/92→04/96	Fitting Position: Front Axle			
	40 - 06/94→04/96				
	43				
1.6	65 06/93→04/96				
Guide Bolt, brake caliper					
1.3	72 10/93→04/96	Vehicle Identification Number from: S	2	11.8171-0008.1 990049	Brake System: ATE
1.6	76 11/94→04/96	51132347 →; Required quantity: 2			
1.4	51 - 08/91→04/96	Vehicle Identification Number from: S	2	11.8171-0008.1 990049	Brake System: ATE
1.4 D	55	51132347 →; + ABS;			
1.5 D	37 09/92→04/96	Required quantity: 2			
	40 - 06/94→04/96				
	43				
1.6	65 06/93→04/96				
PEUGEOT - 106 II (1A_, 1C_) 04/96→05/05					
Guide Sleeve Kit, brake caliper					
1.6 i	74 05/96→01/01	Fitting Position: Front Axle		11.0101-5407.2 260011	Brake System: ATE
1.6 S16	88 04/98→09/01				
1.6 S16	87 05/96→07/04	→ Construction year to: 03/04; Fitting Position: Front Axle		11.0101-5407.2 260011	Brake System: ATE
Guide Bolt, brake caliper					
1.6 i	74 05/96→01/01	Required quantity: 2	2	11.8171-0008.1 990049	Brake System: ATE
1.6 S16	88 04/98→09/01				
1.6 S16	87 05/96→07/04	→ Construction year to: 03/04; Required quantity: 2	2	11.8171-0008.1 990049	Brake System: ATE
PEUGEOT - 106 Van I Hatchback Van (1S_) 08/91→03/96					
Guide Sleeve Kit, brake caliper					
1.4 D	37 08/91→03/96	Vehicle Identification Number from: S		11.0101-5407.2 260011	Brake System: ATE
		51132347 →; + ABS;			
		Fitting Position: Front Axle			
Guide Bolt, brake caliper					
1.4 D	37 08/91→03/96	Vehicle Identification Number from: S	2	11.8171-0008.1 990049	Brake System: ATE
		51132347 →; + ABS;			
		Required quantity: 2			
PEUGEOT - 205 I Convertible (741B, 20D) 03/86→11/95					
Guide Sleeve Kit, brake caliper					
1.9 CTi	92 08/90→07/92	Construction year from: 09/90 →; Fitting Position: Front Axle		11.0101-5407.2 260011	Brake System: ATE
Guide Bolt, brake caliper					
1.9 CTi	92 08/90→07/92	Construction year from: 09/90 →; Required quantity: 2	2	11.8171-0008.1 990049	Brake System: ATE
PEUGEOT - 205 II (20A/C) 01/87→12/00					
Guide Sleeve Kit, brake caliper					
1.8 TD	57 01/90→09/98	Construction year from: 06/93 →; Fitting Position: Front Axle		11.0101-5407.2 260011	Brake System: ATE
1.8 XDT	58 08/90→05/97	Fitting Position: Front Axle		11.0101-5407.2 260011	Brake System: ATE
1.9 GTI	88 - 10/87→09/98	Construction year from: 09/90 →;		11.0101-5407.2 260011	Brake System: ATE
	94	Fitting Position: Front Axle			
Guide Bolt, brake caliper					
1.8 TD	57 01/90→09/98	Construction year from: 06/93 →; Required quantity: 2	2	11.8171-0008.1 990049	Brake System: ATE
1.8 XDT	58 08/90→05/97	Required quantity: 2	2	11.8171-0008.1 990049	Brake System: ATE
1.9 GTI	88 - 10/87→09/98	Construction year from: 09/90 →;	2	11.8171-0008.1 990049	Brake System: ATE
	94	Required quantity: 2			

	kW				
PEUGEOT - 206 CC (2D) 09/00→12/08					
 Brake Hose					
1.6 1.6 16V 2.0 S16	81 09/01→12/08 80 09/00→12/07 100 09/00→12/07	→ for RPO number (vehicle manufacturing date) up to: 09155; Fitting Position: Rear Axle Right	2	24.5229-0200.3 330572	Length [mm]: 200
		for RPO number (vehicle manufacturing date) from: 09156 →; → Construction year to: 01/07; Required quantity: 2; Fitting Position: Rear Axle	2	24.5229-0200.3 330572	Length [mm]: 200
1.6 HDi 110	80 04/05→02/07	→ Construction year to: 01/07; Required quantity: 2; Fitting Position: Rear Axle	2	24.5229-0200.3 330572	Length [mm]: 200
PEUGEOT - 206 Hatchback (2A/C) 08/98→12/12					
 Brake Hose					
1.0 1.1 i 1.4 HDi 1.6 1.6 16V 1.6 Flex 1.9 D	52 06/01→12/05 44 09/98→02/07 51 09/02→02/07 81 05/05→07/08 79 06/01→04/09 83 05/05→07/08 51 09/98→11/01	+ ABS; Required quantity: 2; Fitting Position: Rear Axle	2	24.5229-0200.3 330572	Length [mm]: 200
		→ for RPO number (vehicle manufacturing date) up to: 09155; - ABS; Fitting Position: Rear Axle Right	2	24.5229-0200.3 330572	Length [mm]: 200
		for RPO number (vehicle manufacturing date) from: 09156 →; - ABS; Required quantity: 2; Fitting Position: Rear Axle	2	24.5229-0200.3 330572	Length [mm]: 200
1.1	40 08/98→07/00	Construction year from: 09/98 →; + ABS; Required quantity: 2; Fitting Position: Rear Axle	2	24.5229-0200.3 330572	Length [mm]: 200
		Construction year from: 09/98 →; → for RPO number (vehicle manufacturing date) up to: 09155; - ABS; Fitting Position: Rear Axle Right	2	24.5229-0200.3 330572	Length [mm]: 200
		for RPO number (vehicle manufacturing date) from: 09156 →; - ABS; Required quantity: 2; Fitting Position: Rear Axle	2	24.5229-0200.3 330572	Length [mm]: 200
1.4 16V 1.6 HDi 110 2.0 RC	65 10/03→02/08 80 05/04→02/07 130 07/03→12/07	Required quantity: 2; Fitting Position: Rear Axle	2	24.5229-0200.3 330572	Length [mm]: 200
1.4 CNG 1.4 LPG 1.4 Flex	55 05/06→09/07 55 05/06→09/07 60 01/06→11/09	- ABS; Required quantity: 2; Fitting Position: Rear Axle	2	24.5229-0200.3 330572	Length [mm]: 200
		→ Construction year to: 02/09; + ABS; Required quantity: 2; Fitting Position: Rear Axle	2	24.5229-0200.3 330572	Length [mm]: 200
		→ for RPO number (vehicle manufacturing date) up to: 09155; - ABS; Fitting Position: Rear Axle Right	2	24.5229-0200.3 330572	Length [mm]: 200
		for RPO number (vehicle manufacturing date) from: 09156 →; - ABS; Required quantity: 2; Fitting Position: Rear Axle	2	24.5229-0200.3 330572	Length [mm]: 200
1.4 HDi eco 70 1.4 i 1.6 16V 1.6 BiFuel 2.0 HDi 90	50 09/01→04/09 55 09/98→12/12 80 07/00→04/09 80 07/00→04/09 66 12/99→09/09	for RPO number (vehicle manufacturing date) from: 09156 →; → Construction year to: 02/09; - ABS; Required quantity: 2; Fitting Position: Rear Axle	2	24.5229-0200.3 330572	Length [mm]: 200
		→ Construction year to: 02/09; + ABS; Required quantity: 2; Fitting Position: Rear Axle	2	24.5229-0200.3 330572	Length [mm]: 200
		→ for RPO number (vehicle manufacturing date) up to: 09155; - ABS; Fitting Position: Rear Axle Right	2	24.5229-0200.3 330572	Length [mm]: 200
1.6 8V	66 05/99→10/03	→ Construction year to: 12/00; Fitting Position: Rear Axle Right	2	24.5229-0200.3 330572	Length [mm]: 200
1.6 i 2.0 S16	65 09/98→12/00 99 04/99→10/00	Fitting Position: Rear Axle Right	2	24.5229-0200.3 330572	Length [mm]: 200
2.0 S16	100 06/99→12/07	Construction year from: 10/00 →; + ABS; Required quantity: 2; Fitting Position: Rear Axle	2	24.5229-0200.3 330572	Length [mm]: 200
		Construction year from: 10/00 →; → for RPO number (vehicle manufacturing date) up to: 09155; - ABS; Fitting Position: Rear Axle Right	2	24.5229-0200.3 330572	Length [mm]: 200
		for RPO number (vehicle manufacturing date) from: 09156 →; - ABS; Required quantity: 2; Fitting Position: Rear Axle	2	24.5229-0200.3 330572	Length [mm]: 200

	kW				
PEUGEOT - 206 Saloon 03/07→					
 Brake Hose					
1.4	55 03/07→	→ Construction year to: 02/09; - ABS; Required quantity: 2; Fitting Position: Rear Axle	2	24.5229-0200.3 330572	Length [mm]: 200
1.4 HDi eco 70	50 09/08→	→ Construction year to: 02/09; Fitting Position: Rear Axle Right		24.5229-0200.3 330572	Length [mm]: 200
1.6 16V	80 03/07→	for RPO number (vehicle manufacturing date) from: 09156 →; → Construction year to: 02/09; - ABS; Required quantity: 2; Fitting Position: Rear Axle	2	24.5229-0200.3 330572	Length [mm]: 200
		→ Construction year to: 02/09; + ABS; Required quantity: 2; Fitting Position: Rear Axle	2	24.5229-0200.3 330572	Length [mm]: 200
		→ for RPO number (vehicle manufacturing date) up to: 09155; - ABS; Fitting Position: Rear Axle Right		24.5229-0200.3 330572	Length [mm]: 200
PEUGEOT - 206 SW (2E/K) 07/02→					
 Brake Hose					
1.1	44 07/02→02/07	→ for RPO number (vehicle manufacturing date) up to: 09155;		24.5229-0200.3 330572	Length [mm]: 200
1.4	55 07/02→02/07				
1.4 Flex	59 01/06→07/08	Fitting Position: Rear Axle Right			
1.4 HDi	50 07/02→02/07	for RPO number (vehicle manufacturing date) from: 09156 →; Required quantity: 2; Fitting Position: Rear Axle	2	24.5229-0200.3 330572	Length [mm]: 200
1.4 LPG	55 07/02→02/07				
1.6 Flex	81 - 05/05→07/08				
	83				
1.6 LPG	80 07/02→02/07				
2.0 16V	100 07/02→02/07				
2.0 HDi	66 07/02→02/07				
1.4 16V	65 10/03→	→ Construction year to: 05/07; Required quantity: 2;	2	24.5229-0200.3 330572	Length [mm]: 200
1.6 HDi 110	80 05/04→	Fitting Position: Rear Axle			
1.6	81 05/05→07/08	→ for RPO number (vehicle manufacturing date) up to: 09155;		24.5229-0200.3 330572	Length [mm]: 200
1.6 16V	80 07/02→	Fitting Position: Rear Axle Right			
		for RPO number (vehicle manufacturing date) from: 09156 →; → Construction year to: 05/07; Required quantity: 2; Fitting Position: Rear Axle	2	24.5229-0200.3 330572	Length [mm]: 200
PEUGEOT - 206 Van 04/99→03/09					
 Brake Hose					
1.1	44 09/02→02/07	+ ABS; Required quantity: 2;	2	24.5229-0200.3 330572	Length [mm]: 200
1.9 D	51 04/99→05/07	Fitting Position: Rear Axle			
		→ for RPO number (vehicle manufacturing date) up to: 09155; - ABS; Fitting Position: Rear Axle Right		24.5229-0200.3 330572	Length [mm]: 200
		for RPO number (vehicle manufacturing date) from: 09156 →; - ABS; Required quantity: 2; Fitting Position: Rear Axle	2	24.5229-0200.3 330572	Length [mm]: 200
1.4 HDi	50 09/01→03/09	for RPO number (vehicle manufacturing date) from: 09156 →; → Construction year to: 02/09; - ABS; Required quantity: 2; Fitting Position: Rear Axle	2	24.5229-0200.3 330572	Length [mm]: 200
		→ Construction year to: 02/09; + ABS; Required quantity: 2; Fitting Position: Rear Axle	2	24.5229-0200.3 330572	Length [mm]: 200
		→ for RPO number (vehicle manufacturing date) up to: 09155; - ABS; Fitting Position: Rear Axle Right		24.5229-0200.3 330572	Length [mm]: 200
PEUGEOT - 206+ (2L_, 2M_) 01/09→08/13					
 Brake Hose					
1.1	44 01/09→06/13	→ Construction year to: 05/13;	2	24.5229-0200.3 330572	Length [mm]: 200
1.1 LPG	44 04/09→06/13	Required quantity: 2;			
1.4 HDi eco 70	50 01/09→06/13	Fitting Position: Rear Axle			
1.4 i	54 - 01/09→08/13				
	55				
PEUGEOT - 207 (WA_, WC_) 02/06→12/15					
Guide Bolt, brake caliper					
1.6 16V RC	128 02/07→12/12	→ Construction year to: 06/12; Required quantity: 2	2	11.8171-0008.1 990049	Brake System: ATE
→					

	kW				
PEUGEOT - 207 (WA_, WC_) 02/06→12/15					
 Brake Hose					
1.9 D	51 10/08→12/12	Required quantity: 2;	2	24.5229-0200.3 330572	Length [mm]: 200
2.0 HDi	66 10/08→12/12	Fitting Position: Rear Axle			
PEUGEOT - 207 Saloon 12/07→12/14					
 Brake Hose					
1.9 XSD	51 12/07→12/12	Required quantity: 2;	2	24.5229-0200.3 330572	Length [mm]: 200
2.0 HDi	66 12/07→12/12	Fitting Position: Rear Axle			
PEUGEOT - 207 SW (WK_) 02/07→12/13					
Guide Bolt, brake caliper					
1.6 16V RC	128 02/07→12/12	Construction year from: 11/07 →;	2	11.8171-0008.1 990049	Brake System: ATE
		Required quantity: 2			
 Brake Hose					
2.0 HDi	66 10/08→12/12	Required quantity: 2;	2	24.5229-0200.3 330572	Length [mm]: 200
		Fitting Position: Rear Axle			
PEUGEOT - 208 I (CA_, CC_) 03/12→					
Spring, brake caliper					
1.0	50 03/12→	for brake disc diameter [mm]: 302;	2	11.8116-0356.1 390586	Brake System: ATE
1.2 GPL	60 06/15→	Required quantity: 2;			
1.2 THP 110	81 01/13→	Fitting Position: Front Axle			
1.2 VTI 82	60 03/12→				
1.4 GPL	70 10/13→				
1.4 HDi	50 03/12→				
1.4 VTi	70 03/12→				
1.6	85 - 03/12→				
	115				
1.6 BlueHDi 100	73 01/15→				
1.6 BlueHDi 120	88 11/13→				
1.6 e-HDi	82 07/15→				
1.6 HDi	68 - 03/12→				
	85				
1.6 HDi / BlueHDi 75	55 01/13→				
1.6 THP 165	121 03/15→				
1.6 GTi	147 08/12→	Construction year from: 03/13 →;	2	11.8116-0356.1 390586	Brake System: ATE
		for brake disc diameter [mm]: 302;			
		Required quantity: 2;			
		Fitting Position: Front Axle			
1.6 GTi	153 10/14→	for RPO number (vehicle manufacturing date) from: 14084 →;	2	11.8116-0356.1 390586	Brake System: ATE
		for brake disc diameter [mm]: 302;			
		Required quantity: 2;			
		Fitting Position: Front Axle			
Guide Bolt, brake caliper					
1.0	50 03/12→	for brake disc diameter [mm]: 302;	2	11.8171-0008.1 990049	Brake System: ATE
1.2 GPL	60 06/15→	Required quantity: 2;			
1.2 THP 110	81 01/13→	Fitting Position: Front Axle			
1.2 VTI 82	60 03/12→				
1.4 GPL	70 10/13→				
1.4 HDi	50 03/12→				
1.4 VTi	70 03/12→				
1.6	85 - 03/12→				
	115				
1.6 BlueHDi 100	73 01/15→				
1.6 BlueHDi 120	88 11/13→				
1.6 e-HDi	82 07/15→				
1.6 HDi	68 - 03/12→				
	85				
1.6 HDi / BlueHDi 75	55 01/13→				
1.6 THP 165	121 03/15→				
1.6 GTi	147 08/12→	Construction year from: 03/13 →;	2	11.8171-0008.1 990049	Brake System: ATE
		for brake disc diameter [mm]: 302;			
		Required quantity: 2;			
		Fitting Position: Front Axle			
1.6 GTi	153 10/14→	for RPO number (vehicle manufacturing date) from: 14084 →;	2	11.8171-0008.1 990049	Brake System: ATE
		for brake disc diameter [mm]: 302;			
		Required quantity: 2;			
		Fitting Position: Front Axle			
PEUGEOT - 208 II (UB_, UP_, UW_, UJ_) 06/19→					
Spring, brake caliper					
1.2 PureTech 100	74 06/19→	for brake disc diameter [mm]: 302;	2	11.8116-0356.1 390586	Brake System: ATE
1.2 PureTech 130	96 06/19→	→ for DAM number up to: 1624676;			
1.2 PureTech 75	55 06/19→				
→					

	kW				
PEUGEOT - 208 II (UB_, UP_, UW_, UJ_) 06/19→					
Spring, brake caliper					
1.2 VTi 82	60 06/19→		Required quantity: 2;		
1.5 BlueHDI 100	75 06/19→		Fitting Position: Front Axle		
1.5 BlueHDI 130	96 09/19→				
1.6 HDi 90	68 10/19→				
1.6 VTi 115	85 11/19→				
e-208	100 06/19→				
PEUGEOT - 208 Hatchback Van (CR_) 10/12→					
Spring, brake caliper					
1.2 VTi 82 / PureTech 82	60 06/15→		for brake disc diameter [mm]: 302;	2	11.8116-0356.1 390586 Brake System: ATE
1.4 HDi 68	50 10/12→		Required quantity: 2;		
1.6 Blue HDi 100	73 06/15→		Fitting Position: Front Axle		
1.6 BlueHDI 75	55 04/15→				
1.6 HDi 92	68 03/14→				
Guide Bolt, brake caliper					
1.2 VTi 82 / PureTech 82	60 06/15→		for brake disc diameter [mm]: 302;	2	11.8171-0008.1 990049 Brake System: ATE
1.4 HDi 68	50 10/12→		Required quantity: 2;		
1.6 Blue HDi 100	73 06/15→		Fitting Position: Front Axle		
1.6 BlueHDI 75	55 04/15→				
1.6 HDi 92	68 03/14→				
PEUGEOT - 306 (7B, N3, N5) 04/93→10/03					
Guide Sleeve Kit, brake caliper					
1.1	44 06/94→05/01		→ Construction year to: 04/97; + ABS; Fitting Position: Front Axle		11.0101-5407.2 260011 Brake System: ATE
1.4 SL	55 06/94→05/01		Construction year from: 10/94 →; → for RPO number (vehicle manufacturing date) up to: 08575; + ABS; Fitting Position: Front Axle		11.0101-5407.2 260011 Brake System: ATE
1.6	66 07/00→05/01		→ for RPO number (vehicle manufacturing date) up to: 08575;		11.0101-5407.2 260011 Brake System: ATE
1.8	74 06/94→05/01		Fitting Position: Front Axle		
1.8 ST	74 06/94→05/01				
1.9 D	51 09/98→05/01		for RPO number (vehicle manufacturing date) from: 08576 →; - ABS; Fitting Position: Front Axle		11.0101-5407.2 260011 Brake System: ATE
1.6	72 10/00→05/01		- ABS; Fitting Position: Front Axle		11.0101-5407.2 260011 Brake System: ATE
1.6 SR	65 06/94→10/00		Construction year from: 10/94 →; → for RPO number (vehicle manufacturing date) up to: 08575; Fitting Position: Front Axle		11.0101-5407.2 260011 Brake System: ATE
			for RPO number (vehicle manufacturing date) from: 08576 →; - ABS; Fitting Position: Front Axle		11.0101-5407.2 260011 Brake System: ATE
1.9 D	68 02/94→12/97		Fitting Position: Front Axle		11.0101-5407.2 260011 Brake System: ATE
			Construction year from: 10/94 →; Fitting Position: Front Axle		11.0101-5407.2 260011 Brake System: ATE
1.9 SLD	47 - 06/94→05/01		Construction year from: 10/94 →; Fitting Position: Front Axle		11.0101-5407.2 260011 Brake System: ATE
1.9 SRDT	50				
1.9 SRDT	66 06/94→05/01				
1.9 STD	51 02/94→10/95		for RPO number (vehicle manufacturing date) from: 08576 →; - ABS; Fitting Position: Front Axle		11.0101-5407.2 260011 Brake System: ATE
Guide Bolt, brake caliper					
1.1	44 06/94→05/01		→ Construction year to: 04/97; + ABS; Required quantity: 2	2	11.8171-0008.1 990049 Brake System: ATE
1.4 SL	55 06/94→05/01		Construction year from: 10/94 →; → for RPO number (vehicle manufacturing date) up to: 08575; + ABS; Required quantity: 2	2	11.8171-0008.1 990049 Brake System: ATE
1.6	66 07/00→05/01		→ for RPO number (vehicle manufacturing date) up to: 08575;		11.8171-0008.1 990049 Brake System: ATE
1.8	74 06/94→05/01		Required quantity: 2		
1.8 ST	74 06/94→05/01				
1.9 D	51 09/98→05/01		for RPO number (vehicle manufacturing date) from: 08576 →; - ABS; Required quantity: 2	2	11.8171-0008.1 990049 Brake System: ATE
1.6	72 10/00→05/01		- ABS; Required quantity: 2	2	11.8171-0008.1 990049 Brake System: ATE
1.6 SR	65 06/94→10/00		Construction year from: 10/94 →; → for RPO number (vehicle manufacturing date) up to: 08575; Required quantity: 2	2	11.8171-0008.1 990049 Brake System: ATE
			for RPO number (vehicle manufacturing date) from: 08576 →; - ABS; Required quantity: 2	2	11.8171-0008.1 990049 Brake System: ATE
1.9 D	68 02/94→12/97		Construction year from: 10/94 →; Required quantity: 2	2	11.8171-0008.1 990049 Brake System: ATE
→					

	kW				
PEUGEOT - 306 (7B, N3, N5) 04/93→10/03					
Guide Bolt, brake caliper					
1.9 D	68 02/94→12/97	Required quantity: 2	2	11.8171-0008.1 990049	Brake System: ATE
1.9 SLD	47 - 06/94→05/01	Construction year from: 10/94 →;	2	11.8171-0008.1 990049	Brake System: ATE
1.9 SRDT	66 06/94→05/01	Required quantity: 2			
1.9 STD	51 02/94→10/95	for RPO number (vehicle manufacturing date) from: 08576 →; - ABS; Required quantity: 2	2	11.8171-0008.1 990049	Brake System: ATE
PEUGEOT - 306 Break (7E, N3, N5) 06/94→12/02					
Guide Sleeve Kit, brake caliper					
1.4	55 03/97→04/02	→ Construction year to: 03/02; - ABS; Fitting Position: Front Axle	2	11.0101-5407.2 260011	Brake System: ATE
1.6	72 10/00→04/02				
1.9 D	50 - 03/97→04/02				
	55				
1.6	65 03/97→10/00	- ABS; Fitting Position: Front Axle	2	11.0101-5407.2 260011	Brake System: ATE
1.8 D	44 05/97→06/00				
1.9 D	51 05/97→05/99				
Guide Bolt, brake caliper					
1.4	55 03/97→04/02	→ Construction year to: 03/02; - ABS; Required quantity: 2	2	11.8171-0008.1 990049	Brake System: ATE
1.6	72 10/00→04/02				
1.9 D	50 - 03/97→04/02				
	55				
1.6	65 03/97→10/00	- ABS; Required quantity: 2	2	11.8171-0008.1 990049	Brake System: ATE
1.8 D	44 05/97→06/00				
1.9 D	51 05/97→05/99				
PEUGEOT - 306 Convertible (7D, N3, N5) 01/94→04/02					
Guide Sleeve Kit, brake caliper					
1.6	65 04/96→10/00	→ for RPO number (vehicle manufacturing date) up to: 08575; Fitting Position: Front Axle		11.0101-5407.2 260011	Brake System: ATE
		Construction year from: 05/00 →; - ABS; Fitting Position: Front Axle		11.0101-5407.2 260011	Brake System: ATE
1.8	74 03/94→04/02	→ for RPO number (vehicle manufacturing date) up to: 08575; Fitting Position: Front Axle		11.0101-5407.2 260011	Brake System: ATE
		Construction year from: 05/00 → → Construction year to: 10/00; - ABS; Fitting Position: Front Axle		11.0101-5407.2 260011	Brake System: ATE
1.8	74 05/97→04/99	→ for RPO number (vehicle manufacturing date) up to: 08575; Fitting Position: Front Axle		11.0101-5407.2 260011	Brake System: ATE
Guide Bolt, brake caliper					
1.6	65 04/96→10/00	→ for RPO number (vehicle manufacturing date) up to: 08575; Required quantity: 2	2	11.8171-0008.1 990049	Brake System: ATE
		Construction year from: 05/00 →; - ABS; Required quantity: 2	2	11.8171-0008.1 990049	Brake System: ATE
1.8	74 03/94→04/02	→ for RPO number (vehicle manufacturing date) up to: 08575; Required quantity: 2	2	11.8171-0008.1 990049	Brake System: ATE
		Construction year from: 05/00 → → Construction year to: 10/00; - ABS; Required quantity: 2	2	11.8171-0008.1 990049	Brake System: ATE
1.8	74 05/97→04/99	→ for RPO number (vehicle manufacturing date) up to: 08575; Required quantity: 2	2	11.8171-0008.1 990049	Brake System: ATE
PEUGEOT - 306 Estate Van (N_, 7_) 07/93→08/02					
Guide Sleeve Kit, brake caliper					
1.4	55 03/96→07/01	→ for RPO number (vehicle manufacturing date) up to: 08575; + ABS; Fitting Position: Front Axle		11.0101-5407.2 260011	Brake System: ATE
1.8 D	44 05/97→06/00	- ABS; Fitting Position: Front Axle		11.0101-5407.2 260011	Brake System: ATE
1.9 D	50 05/97→05/99				
1.9 D	51 02/99→08/02	→ Construction year to: 03/02; - ABS; Fitting Position: Front Axle		11.0101-5407.2 260011	Brake System: ATE
1.9 D	68 02/94→04/99	Fitting Position: Front Axle		11.0101-5407.2 260011	Brake System: ATE
1.9 STD	51 02/94→05/99	Construction year from: 09/98 →; → for RPO number (vehicle manufacturing date) up to: 08575; Fitting Position: Front Axle		11.0101-5407.2 260011	Brake System: ATE
→					

	kW				
PEUGEOT - 306 Estate Van (N_, 7_) 07/93→08/02					
Guide Sleeve Kit, brake caliper					
1.9 STD	51	02/94→05/99	for RPO number (vehicle manufacturing date) from: 08576 →; - ABS; Fitting Position: Front Axle	2	11.0101-5407.2 260011 Brake System: ATE
Guide Bolt, brake caliper					
1.4	55	03/96→07/01	→ for RPO number (vehicle manufacturing date) up to: 08575; + ABS; Required quantity: 2	2	11.8171-0008.1 990049 Brake System: ATE
1.8 D	44	05/97→06/00	- ABS; Required quantity: 2	2	11.8171-0008.1 990049 Brake System: ATE
1.9 D	50	05/97→05/99			
1.9 D	51	02/99→08/02	→ Construction year to: 03/02; - ABS; Required quantity: 2	2	11.8171-0008.1 990049 Brake System: ATE
1.9 D	68	02/94→04/99	Required quantity: 2	2	11.8171-0008.1 990049 Brake System: ATE
1.9 STD	51	02/94→05/99	Construction year from: 09/98 →; → for RPO number (vehicle manufacturing date) up to: 08575; Required quantity: 2	2	11.8171-0008.1 990049 Brake System: ATE
			for RPO number (vehicle manufacturing date) from: 08576 →; - ABS; Required quantity: 2	2	11.8171-0008.1 990049 Brake System: ATE
PEUGEOT - 306 Hatchback (7A, 7C, N3, N5) 01/93→10/03					
Guide Sleeve Kit, brake caliper					
1.1	44	05/93→05/01	Construction year from: 03/94 → → Construction year to: 04/97; + ABS; Fitting Position: Front Axle		11.0101-5407.2 260011 Brake System: ATE
1.4	55	04/93→07/01	Fitting Position: Front Axle		11.0101-5407.2 260011 Brake System: ATE
			→ for RPO number (vehicle manufacturing date) up to: 08575; + ABS; Fitting Position: Front Axle		11.0101-5407.2 260011 Brake System: ATE
1.6	65 -	05/93→05/01	→ for RPO number (vehicle manufacturing date) up to: 08575; Fitting Position: Front Axle		11.0101-5407.2 260011 Brake System: ATE
1.8	66	05/93→05/01			
	74	05/93→05/01	for RPO number (vehicle manufacturing date) from: 08576 →; - ABS; Fitting Position: Front Axle		11.0101-5407.2 260011 Brake System: ATE
1.6	72	10/00→05/01	- ABS; Fitting Position: Front Axle		11.0101-5407.2 260011 Brake System: ATE
1.8 D	43 -	04/93→05/01	Fitting Position: Front Axle		11.0101-5407.2 260011 Brake System: ATE
1.9 Td	44	07/95→08/00			
1.9 D	47 -	05/93→05/01	Fitting Position: Front Axle		11.0101-5407.2 260011 Brake System: ATE
	55		Construction year from: 09/98 →; + ABS; → Construction year to: 10/00; Fitting Position: Front Axle		11.0101-5407.2 260011 Brake System: ATE
1.9 D	51	04/93→05/99	Construction year from: 09/98 →; → for RPO number (vehicle manufacturing date) up to: 08575; Fitting Position: Front Axle		11.0101-5407.2 260011 Brake System: ATE
			for RPO number (vehicle manufacturing date) from: 08576 →; - ABS; Fitting Position: Front Axle		11.0101-5407.2 260011 Brake System: ATE
1.9 D	51	09/98→05/01	→ for RPO number (vehicle manufacturing date) up to: 08575; Fitting Position: Front Axle		11.0101-5407.2 260011 Brake System: ATE
			+ ABS; → Construction year to: 10/00; Fitting Position: Front Axle		11.0101-5407.2 260011 Brake System: ATE
			for RPO number (vehicle manufacturing date) from: 08576 →; - ABS; Fitting Position: Front Axle		11.0101-5407.2 260011 Brake System: ATE
1.9 D	52	01/99→08/03	→ for RPO number (vehicle manufacturing date) up to: 08575; Fitting Position: Front Axle		11.0101-5407.2 260011 Brake System: ATE
			for RPO number (vehicle manufacturing date) from: 08576 →; → Construction year to: 05/01; - ABS; Fitting Position: Front Axle		11.0101-5407.2 260011 Brake System: ATE
1.9 D	68	01/93→12/97	Construction year from: 10/93 →; Fitting Position: Front Axle		11.0101-5407.2 260011 Brake System: ATE
			Construction year from: 10/94 →; Fitting Position: Front Axle		11.0101-5407.2 260011 Brake System: ATE
1.9 DT	66	05/93→05/01	Construction year from: 10/93 →; Fitting Position: Front Axle		11.0101-5407.2 260011 Brake System: ATE
→					

	kW				
PEUGEOT - 306 Hatchback (7A, 7C, N3, N5) 01/93→10/03					
Guide Bolt, brake caliper					
1.1	44	05/93→05/01	Construction year from: 03/94 → → Construction year to: 04/97; + ABS; Required quantity: 2	2	11.8171-0008.1 990049 Brake System: ATE
1.4	55	04/93→07/01	→ for RPO number (vehicle manufacturing date) up to: 08575; + ABS; Required quantity: 2	2	11.8171-0008.1 990049 Brake System: ATE
1.6	65 -	05/93→05/01	→ for RPO number (vehicle manufacturing date) up to: 08575;	2	11.8171-0008.1 990049 Brake System: ATE
1.8	66 74	05/93→05/01	Required quantity: 2 for RPO number (vehicle manufacturing date) from: 08576 →; - ABS; Required quantity: 2	2	11.8171-0008.1 990049 Brake System: ATE
1.6	72	10/00→05/01	- ABS; Required quantity: 2	2	11.8171-0008.1 990049 Brake System: ATE
1.8 D	43 -	04/93→05/01	Required quantity: 2	2	11.8171-0008.1 990049 Brake System: ATE
1.9 Td	52	07/95→08/00			
1.9 D	47 -	05/93→05/01	Required quantity: 2	2	11.8171-0008.1 990049 Brake System: ATE
	55		Construction year from: 09/98 →; + ABS; → Construction year to: 10/00; Required quantity: 2	2	11.8171-0008.1 990049 Brake System: ATE
1.9 D	51	04/93→05/99	Construction year from: 09/98 →; → for RPO number (vehicle manufacturing date) up to: 08575; Required quantity: 2	2	11.8171-0008.1 990049 Brake System: ATE
			for RPO number (vehicle manufacturing date) from: 08576 →; - ABS; Required quantity: 2	2	11.8171-0008.1 990049 Brake System: ATE
1.9 D	51	09/98→05/01	→ for RPO number (vehicle manufacturing date) up to: 08575; Required quantity: 2	2	11.8171-0008.1 990049 Brake System: ATE
			+ ABS; → Construction year to: 10/00; Required quantity: 2	2	11.8171-0008.1 990049 Brake System: ATE
			for RPO number (vehicle manufacturing date) from: 08576 →; - ABS; Required quantity: 2	2	11.8171-0008.1 990049 Brake System: ATE
1.9 D	52	01/99→08/03	→ for RPO number (vehicle manufacturing date) up to: 08575; Required quantity: 2	2	11.8171-0008.1 990049 Brake System: ATE
			for RPO number (vehicle manufacturing date) from: 08576 →; → Construction year to: 05/01; - ABS; Required quantity: 2	2	11.8171-0008.1 990049 Brake System: ATE
1.9 D	68	01/93→12/97	Construction year from: 10/93 →; Required quantity: 2	2	11.8171-0008.1 990049 Brake System: ATE
			Construction year from: 10/94 →; Required quantity: 2	2	11.8171-0008.1 990049 Brake System: ATE
1.9 DT	66	05/93→05/01	Construction year from: 10/93 →; Required quantity: 2	2	11.8171-0008.1 990049 Brake System: ATE
PEUGEOT - 306 Hatchback Van 04/93→08/01					
Guide Sleeve Kit, brake caliper					
1.1	44	07/93→12/94	Construction year from: 03/94 →; + ABS; Fitting Position: Front Axle		11.0101-5407.2 260011 Brake System: ATE
1.4	55	03/96→07/01	→ for RPO number (vehicle manufacturing date) up to: 08575; + ABS; Fitting Position: Front Axle		11.0101-5407.2 260011 Brake System: ATE
1.8 D	44	04/93→05/99	Fitting Position: Front Axle		11.0101-5407.2 260011 Brake System: ATE
1.9 D	50	05/97→05/99			
1.9 D	51	02/99→08/01	→ for RPO number (vehicle manufacturing date) up to: 08575; Fitting Position: Front Axle		11.0101-5407.2 260011 Brake System: ATE
			for RPO number (vehicle manufacturing date) from: 08576 →; → Construction year to: 05/01; - ABS; Fitting Position: Front Axle		11.0101-5407.2 260011 Brake System: ATE
1.9 STD	51	02/94→10/95	Construction year from: 06/94 →; Fitting Position: Front Axle		11.0101-5407.2 260011 Brake System: ATE
Guide Bolt, brake caliper					
1.1	44	07/93→12/94	Construction year from: 03/94 →; + ABS; Required quantity: 2	2	11.8171-0008.1 990049 Brake System: ATE
1.4	55	03/96→07/01	→ for RPO number (vehicle manufacturing date) up to: 08575; + ABS; Required quantity: 2	2	11.8171-0008.1 990049 Brake System: ATE
1.8 D	44	04/93→05/99	Required quantity: 2	2	11.8171-0008.1 990049 Brake System: ATE
→					

	kW				
PEUGEOT - 306 Hatchback Van 04/93→08/01					
Guide Bolt, brake caliper					
1.9 D	50 05/97→05/99	Required quantity: 2	2	11.8171-0008.1 990049	Brake System: ATE
1.9 D	51 02/99→08/01	→ for RPO number (vehicle manufacturing date) up to: 08575; Required quantity: 2	2	11.8171-0008.1 990049	Brake System: ATE
		for RPO number (vehicle manufacturing date) from: 08576 →; → Construction year to: 05/01; - ABS; Required quantity: 2	2	11.8171-0008.1 990049	Brake System: ATE
1.9 STD	51 02/94→10/95	Construction year from: 06/94 →; Required quantity: 2	2	11.8171-0008.1 990049	Brake System: ATE
PEUGEOT - 307 (3A/C) 08/00→12/12					
Guide Bolt, brake caliper					
2.0 16V 2.0 HDi 135	130 06/05→11/07 100 10/03→11/07	for RPO number (vehicle manufacturing date) from: 10488 →; → Construction year to: 07/07; Required quantity: 2	2	11.8171-0008.1 990049	Brake System: ATE
		→ for RPO number (vehicle manufacturing date) up to: 10487; Required quantity: 2	2	11.8171-0008.1 990049	Brake System: ATE
PEUGEOT - 307 Break (3E) 03/02→12/09					
Guide Bolt, brake caliper					
2.0 16V 2.0 HDi 135	130 06/05→04/08 100 02/04→04/08	for RPO number (vehicle manufacturing date) from: 10488 →; Required quantity: 2	2	11.8171-0008.1 990049	Brake System: ATE
		→ for RPO number (vehicle manufacturing date) up to: 10487; Required quantity: 2	2	11.8171-0008.1 990049	Brake System: ATE
PEUGEOT - 307 CC (3B) 03/03→06/09					
Guide Bolt, brake caliper					
2.0 16V 2.0 HDi 135	130 10/03→04/09 100 06/05→04/09	for RPO number (vehicle manufacturing date) from: 10488 →; → Construction year to: 02/09; Required quantity: 2	2	11.8171-0008.1 990049	Brake System: ATE
		→ for RPO number (vehicle manufacturing date) up to: 10487; Required quantity: 2	2	11.8171-0008.1 990049	Brake System: ATE
PEUGEOT - 307 SW (3H) 03/02→12/09					
Guide Bolt, brake caliper					
2.0 HDi 135	100 02/04→04/08	for RPO number (vehicle manufacturing date) from: 10488 →; Required quantity: 2	2	11.8171-0008.1 990049	Brake System: ATE
		→ for RPO number (vehicle manufacturing date) up to: 10487; Required quantity: 2	2	11.8171-0008.1 990049	Brake System: ATE
PEUGEOT - 307 SW Estate Van (3E_, 3H_) 04/02→12/09					
Guide Bolt, brake caliper					
2.0 HDi	100 04/04→11/07	for RPO number (vehicle manufacturing date) from: 10488 →; Required quantity: 2	2	11.8171-0008.1 990049	Brake System: ATE
		→ for RPO number (vehicle manufacturing date) up to: 10487; Required quantity: 2	2	11.8171-0008.1 990049	Brake System: ATE
PEUGEOT - 308 I (4A_, 4C_) 09/07→12/16					
Spring, brake caliper					
1.6 16V	128 03/08→10/14	for RPO number (vehicle manufacturing date) from: 11578 →; → Construction year to: 07/13; Required quantity: 2	2	11.8116-0356.1 390586	Brake System: ATE
1.6 THP 16V 2.0 HDi	115 10/09→10/14 120 04/12→10/14	→ Construction year to: 07/13; Required quantity: 2	2	11.8116-0356.1 390586	Brake System: ATE
2.0 HDi	100 09/07→10/14	for RPO number (vehicle manufacturing date) from: 11578 → → for RPO number (vehicle manufacturing date) up to: 11678; Required quantity: 2	2	11.8116-0356.1 390586	Brake System: ATE
Guide Sleeve Kit, brake caliper					
1.6 GTI	147 07/10→10/14	→ Construction year to: 07/13; Fitting Position: Front Axle		11.0101-5407.2 260011	Brake System: ATE
→					

	kW				
PEUGEOT - 308 I (4A_, 4C_) 09/07→12/16					
Guide Bolt, brake caliper					
1.6 16V 2.0 HDi	128 03/08→10/14 100 09/07→10/14	→ for RPO number (vehicle manufacturing date) up to: 11577; Required quantity: 2	2	11.8171-0008.1 990049	Brake System: ATE
1.6 GTi	147 07/10→10/14	→ Construction year to: 07/13; Required quantity: 2	2	11.8171-0008.1 990049	Brake System: ATE
PEUGEOT - 308 II (LB_, LP_, LW_, LH_, L3_) 09/13→06/21					
Guide Sleeve Kit, brake caliper					
1.2 THP 110 1.2 THP 130 1.2 VTi 72 1.6 BlueHDi 120 1.6 GT 205 1.6 GTi	81 11/13→06/21 96 11/13→06/21 60 09/13→06/21 88 11/13→06/21 151 06/14→06/21 184 - 06/15→06/21 200	for brake disc diameter [mm]: 304; Fitting Position: Front Axle		11.0101-5407.2 260011	Brake System: ATE
1.6 HDi 1.6 HDi / BlueHDi 115 1.6 HDi 100 1.6 THP 1.6 THP 125 1.6 THP 150 1.6 THP 163 1.6 VTi 115 2.0 BlueHDi 150 2.0 GT BlueHDi 180	68 09/13→06/21 85 09/13→06/21 73 04/14→06/21 115 09/13→06/21 92 09/13→06/21 110 03/14→06/21 120 06/14→06/21 85 05/15→06/21 110 11/13→06/21 133 06/14→06/21	for brake disc diameter [mm]: 249; Vehicle Equipment: for vehicles without electric parking brake; Fitting Position: Rear Axle		11.0101-5407.2 260011	Brake System: ATE
1.5 BlueHDi 100 1.5 BlueHDi 130 1.6 GTi PureTech 263 1.6 PureTech 225 1.6 THP 2.0 GT BlueHDi 180	75 05/18→06/21 96 06/17→06/21 193 07/18→06/21 165 01/18→06/21 112 09/13→06/21 130 - 06/17→06/21 132	for brake disc diameter [mm]: 304; Fitting Position: Front Axle		11.0101-5407.2 260011	Brake System: ATE
		for brake disc diameter [mm]: 249 / 268; Vehicle Equipment: for vehicles without electric parking brake; Fitting Position: Rear Axle		11.0101-5407.2 260011	Brake System: ATE
Guide Bolt, brake caliper					
1.2 THP 110 1.2 THP 130 1.2 VTi 72 1.6 BlueHDi 120 1.6 GT 205 1.6 GTi	81 11/13→06/21 96 11/13→06/21 60 09/13→06/21 88 11/13→06/21 151 06/14→06/21 184 - 06/15→06/21 200	for brake disc diameter [mm]: 304; Required quantity: 2; Fitting Position: Front Axle	2	11.8171-0008.1 990049	Brake System: ATE
1.6 HDi 1.6 HDi / BlueHDi 115 1.6 HDi 100 1.6 THP 1.6 THP 125 1.6 THP 150 1.6 THP 163 1.6 VTi 115 2.0 BlueHDi 150 2.0 GT BlueHDi 180	68 09/13→06/21 85 09/13→06/21 73 04/14→06/21 115 09/13→06/21 92 09/13→06/21 110 03/14→06/21 120 06/14→06/21 85 05/15→06/21 110 11/13→06/21 133 06/14→06/21	for brake disc diameter [mm]: 268; Vehicle Equipment: for vehicles without electric parking brake; Required quantity: 2; Fitting Position: Rear Axle	2	11.8171-0008.1 990049	Brake System: ATE
		for brake disc diameter [mm]: 249; Required quantity: 2; Fitting Position: Rear Axle	2	11.8171-0008.1 990049	Brake System: ATE
1.5 BlueHDi 100 1.5 BlueHDi 130 1.6 GTi PureTech 263 1.6 PureTech 225 1.6 THP 2.0 GT BlueHDi 180	75 05/18→06/21 96 06/17→06/21 193 07/18→06/21 165 01/18→06/21 112 09/13→06/21 130 - 06/17→06/21 132	for brake disc diameter [mm]: 304; Required quantity: 2; Fitting Position: Front Axle	2	11.8171-0008.1 990049	Brake System: ATE
		for brake disc diameter [mm]: 249 / 268; Vehicle Equipment: for vehicles without electric parking brake; Required quantity: 2; Fitting Position: Rear Axle	2	11.8171-0008.1 990049	Brake System: ATE
PEUGEOT - 308 CC (4B_) 02/09→12/15					
Spring, brake caliper					
1.6 16V 2.0 CVVT 2.0 HDi	103 - 06/09→12/14 110 103 07/09→12/14 100 - 04/09→12/14 120	Required quantity: 2	2	11.8116-0356.1 390586	Brake System: ATE
1.6 16V	115 06/09→12/14	Construction year from: 09/09 →; Required quantity: 2	2	11.8116-0356.1 390586	Brake System: ATE
Guide Sleeve Kit, brake caliper					
1.6 THP	147 10/10→12/14	Fitting Position: Front Axle		11.0101-5407.2 260011	Brake System: ATE
Guide Bolt, brake caliper					
1.6 16V 1.6 THP 2.0 CVVT →	103 - 06/09→12/14 110 147 10/10→12/14 103 07/09→12/14	Required quantity: 2	2	11.8171-0008.1 990049	Brake System: ATE

PEUGEOT - 308 CC (4B_) 02/09→12/15						
Guide Bolt, brake caliper						
2.0 HDi	100 - 04/09→12/14 120	Required quantity: 2	2	11.8171-0008.1	990049	Brake System: ATE
1.6 16V	115 06/09→12/14	Construction year from: 09/09 →; Required quantity: 2	2	11.8171-0008.1	990049	Brake System: ATE
PEUGEOT - 308 Hatchback Van (LB_) 03/15→						
Guide Sleeve Kit, brake caliper						
1.5 BlueHDi 130	96 06/17→06/21	for brake disc diameter [mm]: 304; Fitting Position: Front Axle		11.0101-5407.2	260011	Brake System: ATE
		for brake disc diameter [mm]: 249 / 268; Vehicle Equipment: for vehicles without electric parking brake; Fitting Position: Rear Axle		11.0101-5407.2	260011	Brake System: ATE
1.6 BlueHDi 120	88 03/15→06/21	for brake disc diameter [mm]: 304; Fitting Position: Front Axle		11.0101-5407.2	260011	Brake System: ATE
1.6 e-HDi 115	85 03/15→06/21	for brake disc diameter [mm]: 249; Vehicle Equipment: for vehicles without electric parking brake; Fitting Position: Rear Axle		11.0101-5407.2	260011	Brake System: ATE
Guide Bolt, brake caliper						
1.5 BlueHDi 130	96 06/17→06/21	for brake disc diameter [mm]: 304; Required quantity: 2; Fitting Position: Front Axle	2	11.8171-0008.1	990049	Brake System: ATE
		for brake disc diameter [mm]: 249 / 268; Vehicle Equipment: for vehicles without electric parking brake; Required quantity: 2; Fitting Position: Rear Axle	2	11.8171-0008.1	990049	Brake System: ATE
1.6 BlueHDi 120	88 03/15→06/21	for brake disc diameter [mm]: 304; Required quantity: 2; Fitting Position: Front Axle	2	11.8171-0008.1	990049	Brake System: ATE
1.6 e-HDi 115	85 03/15→06/21	for brake disc diameter [mm]: 268; Vehicle Equipment: for vehicles without electric parking brake; Required quantity: 2; Fitting Position: Rear Axle	2	11.8171-0008.1	990049	Brake System: ATE
		for brake disc diameter [mm]: 249; Required quantity: 2; Fitting Position: Rear Axle	2	11.8171-0008.1	990049	Brake System: ATE
PEUGEOT - 308 SW I (4E_, 4H_) 09/07→10/14						
Spring, brake caliper						
1.6 16V	103 - 09/07→10/14 128	for RPO number (vehicle manufacturing date) from: 11578 →; → Construction year to: 04/14; Required quantity: 2	2	11.8116-0356.1	390586	Brake System: ATE
1.6 THP 16V	115 10/09→10/14	→ Construction year to: 04/14;	2	11.8116-0356.1	390586	Brake System: ATE
2.0 HDi	110 - 06/09→10/14 120	Required quantity: 2				
2.0 Bioflex	103 01/08→12/11	for RPO number (vehicle manufacturing date) from: 11578 → → for RPO number (vehicle manufacturing date) up to: 11678; Required quantity: 2	2	11.8116-0356.1	390586	Brake System: ATE
2.0 HDi	100 09/07→12/12	for RPO number (vehicle manufacturing date) from: 11578 →; Required quantity: 2	2	11.8116-0356.1	390586	Brake System: ATE
2.0 HDi	103 09/07→10/14	Construction year from: 12/08 → → Construction year to: 04/14; Required quantity: 2	2	11.8116-0356.1	390586	Brake System: ATE
Guide Bolt, brake caliper						
1.6 16V	103 - 09/07→10/14 128	Construction year from: 05/08 →; → for RPO number (vehicle manufac- turing date) up to: 11577; Required quantity: 2	2	11.8171-0008.1	990049	Brake System: ATE
		for RPO number (vehicle manufacturing date) from: 11578 →; → Construction year to: 04/14; Required quantity: 2	2	11.8171-0008.1	990049	Brake System: ATE
1.6 THP 16V	115 10/09→10/14	→ Construction year to: 04/14;	2	11.8171-0008.1	990049	Brake System: ATE
2.0 HDi	110 - 06/09→10/14 120	Required quantity: 2				
2.0 Bioflex	103 01/08→12/11	Construction year from: 05/08 →; → for RPO number (vehicle manufac- turing date) up to: 11577; Required quantity: 2	2	11.8171-0008.1	990049	Brake System: ATE
→						

	kW				
PEUGEOT - 308 SW I (4E_, 4H_) 09/07→10/14					
Guide Bolt, brake caliper					
2.0 Bioflex	103	01/08→12/11	for RPO number (vehicle manufacturing date) from: 11578 → → for RPO number (vehicle manufacturing date) up to: 11678; Required quantity: 2	2	11.8171-0008.1 990049 Brake System: ATE
2.0 HDi	100	09/07→12/12	for RPO number (vehicle manufacturing date) from: 11578 →;	2	11.8171-0008.1 990049 Brake System: ATE
			Construction year from: 05/08 →; → for RPO number (vehicle manufacturing date) up to: 11577; Required quantity: 2	2	11.8171-0008.1 990049 Brake System: ATE
2.0 HDi	103	09/07→10/14	Construction year from: 12/08 → → Construction year to: 04/14; Required quantity: 2	2	11.8171-0008.1 990049 Brake System: ATE
PEUGEOT - 308 SW I Estate Van (4E_) 01/08→12/12					
Spring, brake caliper					
2.0 HDi	100	01/08→12/11	for RPO number (vehicle manufacturing date) from: 11578 →;	2	11.8116-0356.1 390586 Brake System: ATE
			Required quantity: 2		
Guide Bolt, brake caliper					
2.0 HDi	100	01/08→12/11	for RPO number (vehicle manufacturing date) from: 11578 →;	2	11.8171-0008.1 990049 Brake System: ATE
			Required quantity: 2		
			→ for RPO number (vehicle manufacturing date) up to: 11577; Required quantity: 2	2	11.8171-0008.1 990049 Brake System: ATE
PEUGEOT - 308 SW II (LC_, LJ_, LR_, LX_, L4_) 03/14→06/21					
Guide Sleeve Kit, brake caliper					
1.2 THP 110	81	03/14→06/21	for brake disc diameter [mm]: 304; Fitting Position: Front Axle		11.0101-5407.2 260011 Brake System: ATE
			Construction year from: 08/14 →;		11.0101-5407.2 260011 Brake System: ATE
			for brake disc diameter [mm]: 268; Vehicle Equipment: for vehicles without electric parking brake; Fitting Position: Rear Axle		
			Construction year from: 08/14 →;		11.0101-5407.2 260011 Brake System: ATE
			for brake disc diameter [mm]: 249; Fitting Position: Rear Axle		
1.2 THP 130	96	03/14→06/21	for brake disc diameter [mm]: 304; Fitting Position: Front Axle		11.0101-5407.2 260011 Brake System: ATE
1.6 BlueHDi 100	73	04/14→06/21			
1.6 BlueHDi 120	88	03/14→06/21	for brake disc diameter [mm]: 268; Vehicle Equipment: for vehicles without electric parking brake; Fitting Position: Rear Axle		11.0101-5407.2 260011 Brake System: ATE
1.6 GT 205	151	02/15→06/21			
1.6 HDi / BlueHDi 115	85	03/14→06/21			
1.6 HDi 92	68	03/14→06/21			
1.6 THP 125	92	03/14→06/21			
1.6 THP 150	110	03/14→06/21	for brake disc diameter [mm]: 249; Fitting Position: Rear Axle		11.0101-5407.2 260011 Brake System: ATE
1.6 THP 155	115	03/14→06/21			
1.6 VTi	85	03/14→06/21			
2.0 BlueHDi 150	110	03/14→06/21			
2.0 GT BlueHDi 180	132	06/17→06/21			
2.0 GT HDi 180 / BlueHDi 180	133	06/14→06/21			
1.5 BlueHDi 100	75	04/18→06/21	for brake disc diameter [mm]: 304; Fitting Position: Front Axle		11.0101-5407.2 260011 Brake System: ATE
1.5 BlueHDi 130	96	06/17→06/21			
1.6 PureTech 225	165	01/18→06/21	for brake disc diameter [mm]: 249 / 268; Vehicle Equipment: for vehicles without electric parking brake; Fitting Position: Rear Axle		11.0101-5407.2 260011 Brake System: ATE
2.0 GT BlueHDi 180	130	06/17→06/21			
Guide Bolt, brake caliper					
1.2 THP 110	81	03/14→06/21	Construction year from: 08/14 →;	2	11.8171-0008.1 990049 Brake System: ATE
			for brake disc diameter [mm]: 304; Required quantity: 2; Fitting Position: Front Axle		
			Construction year from: 08/14 →;	2	11.8171-0008.1 990049 Brake System: ATE
			for brake disc diameter [mm]: 249; Required quantity: 2; Fitting Position: Rear Axle		
			Construction year from: 08/14 →;	2	11.8171-0008.1 990049 Brake System: ATE
			for brake disc diameter [mm]: 268; Vehicle Equipment: for vehicles without electric parking brake; Required quantity: 2; Fitting Position: Rear Axle		
→					



	kW				
PEUGEOT - 308 SW II (LC_, LJ_, LR_, LX_, L4_) 03/14→06/21					
Guide Bolt, brake caliper					
1.2 THP 130	96 03/14→06/21	for brake disc diameter [mm]: 304;	2	11.8171-0008.1 990049	Brake System: ATE
1.6 BlueHDi 100	73 04/14→06/21	Required quantity: 2;			
1.6 BlueHDi 120	88 03/14→06/21	Fitting Position: Front Axle			
1.6 GT 205	151 02/15→06/21	for brake disc diameter [mm]: 268;	2	11.8171-0008.1 990049	Brake System: ATE
1.6 HDi / BlueHDi 115	85 03/14→06/21	Vehicle Equipment: for vehicles without			
1.6 HDi 92	68 03/14→06/21	electric parking brake;			
1.6 THP 125	92 03/14→06/21	Required quantity: 2;			
1.6 THP 150	110 03/14→06/21	Fitting Position: Rear Axle			
1.6 THP 155	115 03/14→06/21	for brake disc diameter [mm]: 249;	2	11.8171-0008.1 990049	Brake System: ATE
1.6 VTi	85 03/14→06/21	Required quantity: 2;			
2.0 BlueHDi 150	110 03/14→06/21	Fitting Position: Rear Axle			
2.0 GT BlueHDi 180	132 06/17→06/21				
1.5 BlueHDi 100	75 04/18→06/21	for brake disc diameter [mm]: 304;	2	11.8171-0008.1 990049	Brake System: ATE
1.5 BlueHDi 130	96 06/17→06/21	Required quantity: 2;			
1.6 PureTech 225	165 01/18→06/21	Fitting Position: Front Axle			
2.0 GT BlueHDi 180	130 06/17→06/21	for brake disc diameter [mm]: 249 / 268;	2	11.8171-0008.1 990049	Brake System: ATE
		Vehicle Equipment: for vehicles without			
		electric parking brake;			
		Required quantity: 2;			
		Fitting Position: Rear Axle			
2.0 GT HDi 180 /	133 06/14→06/21	for brake disc diameter [mm]: 268;	2	11.8171-0008.1 990049	Brake System: ATE
BlueHDi 180		Vehicle Equipment: for vehicles without			
		electric parking brake;			
		Required quantity: 2;			
		Fitting Position: Front Axle			
		for brake disc diameter [mm]: 304;	2	11.8171-0008.1 990049	Brake System: ATE
		Required quantity: 2;			
		Fitting Position: Front Axle			
		for brake disc diameter [mm]: 249;	2	11.8171-0008.1 990049	Brake System: ATE
		Required quantity: 2;			
		Fitting Position: Rear Axle			
PEUGEOT - 308 SW II Estate Van (LC_) 04/14→					
Guide Sleeve Kit, brake caliper					
1.5 BlueHDi 130	96 06/17→06/21	for brake disc diameter [mm]: 304;		11.0101-5407.2 260011	Brake System: ATE
		Fitting Position: Front Axle			
		for brake disc diameter [mm]: 249 / 268;		11.0101-5407.2 260011	Brake System: ATE
		Vehicle Equipment: for vehicles without			
		electric parking brake;			
		Fitting Position: Rear Axle			
1.6 BlueHDi	73 04/14→06/21	for brake disc diameter [mm]: 304;		11.0101-5407.2 260011	Brake System: ATE
		Fitting Position: Front Axle			
		for brake disc diameter [mm]: 268;		11.0101-5407.2 260011	Brake System: ATE
		Vehicle Equipment: for vehicles without			
		electric parking brake;			
		Fitting Position: Rear Axle			
		for brake disc diameter [mm]: 249;		11.0101-5407.2 260011	Brake System: ATE
		Fitting Position: Rear Axle			
Guide Bolt, brake caliper					
1.5 BlueHDi 130	96 06/17→06/21	for brake disc diameter [mm]: 304;	2	11.8171-0008.1 990049	Brake System: ATE
		Required quantity: 2;			
		Fitting Position: Front Axle			
		for brake disc diameter [mm]: 249 / 268;	2	11.8171-0008.1 990049	Brake System: ATE
		Vehicle Equipment: for vehicles without			
		electric parking brake;			
		Required quantity: 2;			
		Fitting Position: Rear Axle			
1.6 BlueHDi	73 04/14→06/21	for brake disc diameter [mm]: 304;	2	11.8171-0008.1 990049	Brake System: ATE
		Required quantity: 2;			
		Fitting Position: Front Axle			
		for brake disc diameter [mm]: 268;	2	11.8171-0008.1 990049	Brake System: ATE
		Vehicle Equipment: for vehicles without			
		electric parking brake;			
		Required quantity: 2;			
		Fitting Position: Rear Axle			
		for brake disc diameter [mm]: 249;	2	11.8171-0008.1 990049	Brake System: ATE
		Required quantity: 2;			
		Fitting Position: Rear Axle			
PEUGEOT - 407 (6D_) 02/04→12/11					
Spring, brake caliper					
2.0 HDi	103 - 06/09→12/10	Required quantity: 2	2	11.8116-0356.1 390586	Brake System: ATE
	120				
2.0 HDi	93 11/04→10/07	for RPO number (vehicle manufacturing	2	11.8116-0356.1 390586	Brake System: ATE
2.0 HDi 135	100 05/04→10/10	date) from: 11683 →;			
		Required quantity: 2			
→					

	kW				
PEUGEOT - 407 (6D_) 02/04→12/11					
Guide Sleeve Kit, brake caliper					
2.0 HDi	103 - 06/09→12/10 120	Fitting Position: Front Axle		11.0101-5407.2 260011	Brake System: ATE
2.0 HDi 2.0 HDi 135	93 11/04→10/07 100 05/04→10/10	for RPO number (vehicle manufacturing date) from: 11683 →; Fitting Position: Front Axle		11.0101-5407.2 260011	Brake System: ATE
3.0	155 03/04→12/10	for RPO number (vehicle manufacturing date) from: 12411 →; Fitting Position: Front Axle		11.0101-5407.2 260011	Brake System: ATE
PEUGEOT - 407 Coupe (6C_) 10/05→					
Spring, brake caliper					
2.0 HDi	120 06/09→	→ Construction year to: 12/11; Required quantity: 2	2	11.8116-0356.1 390586	Brake System: ATE
Guide Sleeve Kit, brake caliper					
2.0 HDi 3.0 HDi	120 06/09→ 177 06/09→	→ Construction year to: 12/11; Fitting Position: Front Axle		11.0101-5407.2 260011	Brake System: ATE
3.0 V6	155 10/05→	for RPO number (vehicle manufacturing date) from: 12411 →; → Construction year to: 12/11; Fitting Position: Front Axle		11.0101-5407.2 260011	Brake System: ATE
PEUGEOT - 407 SW (6E_) 05/04→12/11					
Spring, brake caliper					
2.0 HDi 2.0 HDi 135	93 11/04→10/07 100 07/04→12/10	for RPO number (vehicle manufacturing date) from: 11683 →; Required quantity: 2	2	11.8116-0356.1 390586	Brake System: ATE
2.0 HDi	103 - 08/08→12/10 120	Required quantity: 2	2	11.8116-0356.1 390586	Brake System: ATE
Guide Sleeve Kit, brake caliper					
2.0 HDi 2.0 HDi 135	93 11/04→10/07 100 07/04→12/10	for RPO number (vehicle manufacturing date) from: 11683 →; Fitting Position: Front Axle		11.0101-5407.2 260011	Brake System: ATE
2.0 HDi	103 - 08/08→12/10 120	Fitting Position: Front Axle		11.0101-5407.2 260011	Brake System: ATE
3.0	155 05/04→12/10	for RPO number (vehicle manufacturing date) from: 12411 →; Fitting Position: Front Axle		11.0101-5407.2 260011	Brake System: ATE
PEUGEOT - 407 SW Estate Van (6E_) 08/04→12/10					
Spring, brake caliper					
2.0 HDi	103 - 06/09→12/10 120	Required quantity: 2	2	11.8116-0356.1 390586	Brake System: ATE
Guide Sleeve Kit, brake caliper					
2.0 HDi	103 - 06/09→12/10 120	Fitting Position: Front Axle		11.0101-5407.2 260011	Brake System: ATE
PEUGEOT - 508 I (8D_) 11/10→12/18					
Spring, brake caliper					
1.6 BlueHDi 120 1.6 HDi	88 03/14→12/18 82 - 11/10→12/18 85	for brake disc diameter [mm]: 304; for brake disc thickness [mm]: 28; Required quantity: 2; Fitting Position: Front Axle	2	11.8116-0356.1 390586	Brake System: ATE
1.6 THP 1.6 VTi	110 - 11/10→12/18 121 85 - 11/10→12/18 88	for brake disc diameter [mm]: 283; for brake disc thickness [mm]: 26; Required quantity: 2; Fitting Position: Front Axle	2	11.8116-0356.1 390586	Brake System: ATE
2.0 BlueHDi 150 2.0 BlueHDi 180 2.0 HDi	110 04/14→12/18 133 04/14→12/18 100 - 11/10→12/18 120				
2.0 HDi Hybrid4 AWC 2.2 HDi	120 11/10→12/18 150 11/10→12/18				
2.0 HDi Hybrid4 AWC	147 11/10→12/18	Construction year from: 06/12 →; for brake disc thickness [mm]: 28; for brake disc diameter [mm]: 304; Required quantity: 2; Fitting Position: Front Axle	2	11.8116-0356.1 390586	Brake System: ATE
		Construction year from: 06/12 →; for brake disc thickness [mm]: 26; for brake disc diameter [mm]: 283; Required quantity: 2; Fitting Position: Front Axle	2	11.8116-0356.1 390586	Brake System: ATE
→					

	kW				
PEUGEOT - 508 I (8D_) 11/10→12/18					
Guide Sleeve Kit, brake caliper					
1.6 BlueHDi 120	88	03/14→12/18	for brake disc diameter [mm]: 340; for brake disc thickness [mm]: 30; Fitting Position: Front Axle	11.0101-5407.2	260011 Brake System: ATE
1.6 HDi	82 - 85	11/10→12/18			
1.6 THP	110 - 121	11/10→12/18			
1.6 VTi	85 - 88	11/10→12/18			
2.0 BlueHDi 150	110	04/14→12/18			
2.0 BlueHDi 180	133	04/14→12/18			
2.0 HDi	100 - 120	11/10→12/18			
2.0 HDi Hybrid4 AWC	120	11/10→12/18			
2.2 HDi	150	11/10→12/18			
2.0 HDi Hybrid4 AWC	147	11/10→12/18	Construction year from: 06/12 →; for brake disc diameter [mm]: 340; for brake disc thickness [mm]: 30; Fitting Position: Front Axle	11.0101-5407.2	260011 Brake System: ATE
Guide Bolt, brake caliper					
1.6 BlueHDi 120	88	03/14→12/18	for brake disc diameter [mm]: 340; for brake disc thickness [mm]: 30; Required quantity: 2	2	11.8171-0008.1 990049 Brake System: ATE
1.6 HDi	82 - 85	11/10→12/18			
1.6 THP	110 - 121	11/10→12/18			
1.6 VTi	85 - 88	11/10→12/18			
2.0 BlueHDi 150	110	04/14→12/18			
2.0 BlueHDi 180	133	04/14→12/18			
2.0 HDi	100 - 120	11/10→12/18			
2.0 HDi Hybrid4 AWC	120	11/10→12/18			
2.2 HDi	150	11/10→12/18			
2.0 HDi Hybrid4 AWC	147	11/10→12/18	Construction year from: 06/12 →; for brake disc diameter [mm]: 340; for brake disc thickness [mm]: 30; Required quantity: 2	2	11.8171-0008.1 990049 Brake System: ATE
PEUGEOT - 508 II (FB_, FH_, F3_) 09/18→					
Guide Sleeve Kit, brake caliper					
1.5 BlueHDi 130	96	10/18→	for brake disc diameter [mm]: 304; → for RPO number (vehicle manufacturing date) up to: 16246; Fitting Position: Front Axle	11.0101-5407.2	260011 Brake System: ATE
1.6 PureTech 180	133	10/18→			
1.6 PureTech 225	165	10/18→			
1.6 THP 150	110	09/18→			
1.6 THP 165	121	09/18→			
2.0 BlueHDi 160	120	10/18→			
2.0 BlueHDi 180	130	10/18→			
Hybrid 225	133 - 165	08/19→			
PureTech 130	96	06/20→			
Guide Bolt, brake caliper					
1.5 BlueHDi 130	96	10/18→	for brake disc diameter [mm]: 304; → for RPO number (vehicle manufacturing date) up to: 16246; Fitting Position: Front Axle	11.8171-0008.1	990049 Brake System: ATE
1.6 PureTech 180	133	10/18→			
1.6 PureTech 225	165	10/18→			
1.6 THP 150	110	09/18→			
1.6 THP 165	121	09/18→			
2.0 BlueHDi 160	120	10/18→			
2.0 BlueHDi 180	130	10/18→			
Hybrid 225	133 - 165	08/19→			
PureTech 130	96	06/20→			
PEUGEOT - 508 SW I (8E_) 11/10→12/18					
Spring, brake caliper					
1.6	121	02/12→12/18	for brake disc diameter [mm]: 304; for brake disc thickness [mm]: 28; Required quantity: 2; Fitting Position: Front Axle	2	11.8116-0356.1 390586 Brake System: ATE
1.6 BlueHDi 120	88	03/14→12/18			
1.6 HDi	82 - 85	11/10→12/18			
1.6 THP	110 - 115	11/10→12/18	for brake disc diameter [mm]: 283; for brake disc thickness [mm]: 26; Required quantity: 2; Fitting Position: Front Axle	2	11.8116-0356.1 390586 Brake System: ATE
1.6 VTi	85 - 88	11/10→12/18			
2.0 BlueHDi 150	110	04/14→12/18			
2.0 BlueHDi 180	133	04/14→12/18			
2.0 HDi	100 - 120	11/10→12/18			
2.0 HDi 180 RXH	133	10/14→12/18			
2.0 HDi RXH Hybrid4	120	11/10→12/18			
2.2 HDi	150	11/10→12/18			
→					

	kW						
PEUGEOT - 508 SW I (8E_) 11/10→12/18							
Guide Sleeve Kit, brake caliper							
1.6	121	02/12→12/18	for brake disc diameter [mm]: 340;	2	11.0101-5407.2 260011 Brake System: ATE		
1.6 BlueHDi 120	88	03/14→12/18	for brake disc thickness [mm]: 30;				
1.6 HDi	82 - 85	11/10→12/18	Fitting Position: Front Axle				
1.6 THP	110 - 115	11/10→12/18					
1.6 VTi	85 - 88	11/10→12/18					
2.0 BlueHDi 150	110	04/14→12/18					
2.0 BlueHDi 180	133	04/14→12/18					
2.0 HDi	100 - 120	11/10→12/18					
2.0 HDi 180 RXH	133	10/14→12/18					
2.0 HDi RXH Hybrid4	120	11/10→12/18					
2.2 HDi	150	11/10→12/18					
Guide Bolt, brake caliper							
1.6	121	02/12→12/18	for brake disc diameter [mm]: 340;			2	11.8171-0008.1 990049 Brake System: ATE
1.6 BlueHDi 120	88	03/14→12/18	for brake disc thickness [mm]: 30;				
1.6 HDi	82 - 85	11/10→12/18	Required quantity: 2				
1.6 THP	110 - 115	11/10→12/18					
1.6 VTi	85 - 88	11/10→12/18					
2.0 BlueHDi 150	110	04/14→12/18					
2.0 BlueHDi 180	133	04/14→12/18					
2.0 HDi	100 - 120	11/10→12/18					
2.0 HDi 180 RXH	133	10/14→12/18					
2.0 HDi RXH Hybrid4	120	11/10→12/18					
2.2 HDi	150	11/10→12/18					
PEUGEOT - 508 SW II (FC_, FJ_, F4_) 09/18→							
Guide Sleeve Kit, brake caliper							
1.5 BlueHDi 130	96	09/18→	for brake disc diameter [mm]: 304;	2	11.0101-5407.2 260011 Brake System: ATE		
1.6 PureTech 180	133	09/18→	→ for RPO number (vehicle manufacturing date) up to: 16246;				
1.6 PureTech 225	165	09/18→	Fitting Position: Front Axle				
1.6 THP 165	121	09/18→					
2.0 BlueHDi 160	120	09/18→					
2.0 BlueHDi 180	130	09/18→					
Hybrid 224	133 - 165	08/19→					
PureTech 130	96	06/20→					
Guide Bolt, brake caliper							
1.5 BlueHDi 130	96	09/18→	for brake disc diameter [mm]: 304;			2	11.8171-0008.1 990049 Brake System: ATE
1.6 PureTech 180	133	09/18→	→ for RPO number (vehicle manufacturing date) up to: 16246;				
1.6 PureTech 225	165	09/18→	Fitting Position: Front Axle				
1.6 THP 165	121	09/18→					
2.0 BlueHDi 160	120	09/18→					
2.0 BlueHDi 180	130	09/18→					
Hybrid 224	133 - 165	08/19→					
PureTech 130	96	06/20→					
PEUGEOT - 508 SW Estate Van (8E_) 11/11→							
Spring, brake caliper							
1.6 HDi	84	03/13→12/18	for brake disc diameter [mm]: 304;	2	11.8116-0356.1 390586 Brake System: ATE		
2.0 HDi	103 - 120	03/13→12/18	for brake disc thickness [mm]: 28;				
2.2 HDi	150	11/11→	Required quantity: 2;				
			Fitting Position: Front Axle	2	11.8116-0356.1 390586 Brake System: ATE		
			for brake disc diameter [mm]: 283;				
			for brake disc thickness [mm]: 26;				
			Required quantity: 2;				
			Fitting Position: Front Axle				
Guide Sleeve Kit, brake caliper							
1.6 HDi	84	03/13→12/18	for brake disc diameter [mm]: 340;	2	11.0101-5407.2 260011 Brake System: ATE		
2.0 HDi	103 - 120	03/13→12/18	for brake disc thickness [mm]: 30;				
2.2 HDi	150	11/11→	Fitting Position: Front Axle				
Guide Bolt, brake caliper							
1.6 HDi	84	03/13→12/18	for brake disc diameter [mm]: 340;	2	11.8171-0008.1 990049 Brake System: ATE		
2.0 HDi	103 - 120	03/13→12/18	for brake disc thickness [mm]: 30;				
2.2 HDi	150	11/11→	Required quantity: 2				





	kW				
PEUGEOT - 605 (6B) 06/89→09/99					
Guide Sleeve Kit, brake caliper					
3.0	147	08/89→06/94	Vehicle Identification Number from: S	11.0101-5407.2	260011 Brake System: ATE
3.0 SV 24	147	08/89→09/99	90807684 →; Fitting Position: Front Axle		
3.0 V6	140	04/97→09/99	Fitting Position: Front Axle	11.0101-5407.2	260011 Brake System: ATE
Guide Bolt, brake caliper					
3.0	147	08/89→06/94	Vehicle Identification Number from: S	2	11.8171-0008.1 990049 Brake System: ATE
3.0 SV 24	147	08/89→09/99	90807684 →; Required quantity: 2; Fitting Position: Front Axle		
3.0 V6	140	04/97→09/99	Required quantity: 2; Fitting Position: Front Axle	2	11.8171-0008.1 990049 Brake System: ATE
PEUGEOT - 806 (221) 06/94→08/02					
Guide Sleeve Kit, brake caliper					
1.8	73	07/95→08/02	Construction year from: 10/96 → → Construction year to: 06/02; + ABS; Fitting Position: Rear Axle	11.0101-5407.2	260011 Brake System: ATE
1.9 TD	66 -	07/95→08/02	+ ABS; → Construction year to: 06/02;	11.0101-5407.2	260011 Brake System: ATE
2.0 HDI	68	80 08/99→08/02	Fitting Position: Rear Axle		
2.0 HDI 16V	80	08/99→08/02			
2.0	89	06/94→08/02	Construction year from: 08/94 →; + ABS; → Construction year to: 06/02; Fitting Position: Rear Axle	11.0101-5407.2	260011 Brake System: ATE
2.0 16V	97	05/98→09/00	Construction year from: 10/98 →; Fitting Position: Rear Axle	11.0101-5407.2	260011 Brake System: ATE
2.0 16V	100	09/00→08/02	→ Construction year to: 06/02; Fitting Position: Rear Axle	11.0101-5407.2	260011 Brake System: ATE
2.0 Turbo	108	06/94→08/02	Construction year from: 08/94 → → Construction year to: 06/02; Fitting Position: Rear Axle	11.0101-5407.2	260011 Brake System: ATE
2.1 td 12V	80	06/96→08/99	Fitting Position: Rear Axle	11.0101-5407.2	260011 Brake System: ATE
PEUGEOT - 2008 II (UD_, US_, UY_, UK_) 08/19→					
Spring, brake caliper					
1.2 PureTech 100	74	11/19→	for brake disc diameter [mm]: 302; → for RPO number (vehicle manufac- turing date) up to: 16246; Fitting Position: Front Axle	11.8116-0356.1	390586 Brake System: ATE
1.2 PureTech 130	96	08/19→			
1.2 THP / PureTech 155	114	11/19→			
1.5 BlueHDI 100	75	08/19→			
1.5 BlueHDI 110	81	01/21→			
1.5 BlueHDI 130	96	08/19→			
e-2008	100	09/19→			
PEUGEOT - 3008 MPV (0U_) 05/09→12/17					
Spring, brake caliper					
1.6 THP	110 -	06/09→08/16	Required quantity: 2; Fitting Position: Front Axle	2	11.8116-0356.1 390586 Brake System: ATE
1.6 Turbo	120	06/09→08/16			
2.0 HDi	121	05/14→08/16			
2.0 HDi 150 / BlueHdi	100 -	06/09→08/16			
150	120				
2.0 HDi Hybrid4	110	06/09→08/16	Required quantity: 2	2	11.8116-0356.1 390586 Brake System: ATE
	120 -	02/11→08/16			
	147				
Guide Bolt, brake caliper					
1.6 THP	110 -	06/09→08/16	Required quantity: 2	2	11.8171-0008.1 990049 Brake System: ATE
1.6 Turbo	120	06/09→08/16			
2.0 HDi	121	05/14→08/16			
2.0 HDi 150 / BlueHdi	100 -	06/09→08/16			
150	120				
2.0 HDi Hybrid4	110	06/09→08/16			
	120 -	02/11→08/16			
	147				
PEUGEOT - 3008 SUV (MC_, MR_, MJ_, M4_) 05/16→					
Guide Sleeve Kit, brake caliper					
1.2 THP/ PureTech 130	96	05/16→	for brake disc diameter [mm]: 304; → for RPO number (vehicle manufac- turing date) up to: 16246; Fitting Position: Front Axle	11.0101-5407.2	260011 Brake System: ATE
1.5 BlueHDI 130	96	02/18→			
1.6 BlueHDI 100	73	11/16→			
1.6 BlueHDI 115	85	11/16→12/19			
1.6 BlueHDI 120	88	05/16→			
1.6 PureTech 180	133	07/18→			
1.6 THP 150	110	11/17→			
1.6 THP 165	121	05/16→			
2.0 BlueHDI 136	100	11/16→			
2.0 BlueHDI 150	110	05/16→09/20			
→					





	kW				
PEUGEOT - 3008 SUV (MC_, MR_, MJ_, M4_) 05/16→					
Guide Sleeve Kit, brake caliper					
2.0 BlueHDi 180	130 - 05/16→ 133		for brake disc diameter [mm]: 304; → for RPO number (vehicle manufacturing date) up to: 16246; Fitting Position: Front Axle	11.0101-5407.2 260011	Brake System: ATE
Hybrid	133 - 10/19→ 165				
Hybrid4	147 - 10/19→ 220				
Guide Bolt, brake caliper					
1.2 THP/ PureTech 130	96 05/16→		for brake disc diameter [mm]: 304; → for RPO number (vehicle manufacturing date) up to: 16246; Fitting Position: Front Axle	11.8171-0008.1 990049	Brake System: ATE
1.5 BlueHDi 130	96 02/18→				
1.6 BlueHDi 100	73 11/16→				
1.6 BlueHDi 115	85 11/16→12/19				
1.6 BlueHDi 120	88 05/16→				
1.6 PureTech 180	133 07/18→				
1.6 THP 150	110 11/17→				
1.6 THP 165	121 05/16→				
2.0 BlueHDi 136	100 11/16→				
2.0 BlueHDi 150	110 05/16→09/20				
2.0 BlueHDi 180	130 - 05/16→ 133				
Hybrid	133 - 10/19→ 165				
Hybrid4	147 - 10/19→ 220				
PEUGEOT - 3008 Van (0U_) 05/09→12/17					
Spring, brake caliper					
HDi	120 06/09→08/16	Required quantity: 2;		2 11.8116-0356.1 390586	Brake System: ATE
HDi 150	110 06/09→08/16	Fitting Position: Front Axle			
Guide Bolt, brake caliper					
HDi	120 06/09→08/16	Required quantity: 2		2 11.8171-0008.1 990049	Brake System: ATE
HDi 150	110 06/09→08/16				
PEUGEOT - 3008 Van (MR_, MC_, MJ_) 05/16→					
Guide Sleeve Kit, brake caliper					
BlueHDi 130	96 02/18→		for brake disc diameter [mm]: 304; → for RPO number (vehicle manufacturing date) up to: 16246; Fitting Position: Front Axle	11.0101-5407.2 260011	Brake System: ATE
BlueHDi 180	130 01/18→				
PureTech 130	96 05/16→				
Guide Bolt, brake caliper					
BlueHDi 130	96 02/18→		for brake disc diameter [mm]: 304; → for RPO number (vehicle manufacturing date) up to: 16246; Fitting Position: Front Axle	11.8171-0008.1 990049	Brake System: ATE
BlueHDi 180	130 01/18→				
PureTech 130	96 05/16→				
PEUGEOT - 4008 05/12→					
 Brake Caliper					
1.6	86 05/12→	Fitting Position: Front Axle Left		24.3571-1815.5 241485	Supplementary Article/Supplementary Info: without holder Brake Caliper Type: Fist-type Caliper
1.6 HDi	84 05/12→				
1.6 HDi AWC	84 05/12→				
1.8 HDi	110 05/12→				
1.8 HDi AWC	110 05/12→	Fitting Position: Front Axle Right		24.3571-1816.5 241486	Supplementary Article/Supplementary Info: without holder Brake Caliper Type: Fist-type Caliper
2.0	110 05/13→				
2.0 AWC	110 05/12→				
 Brake Pad Set, disc brake					
1.6	86 05/12→	for RPO number (vehicle manufacturing date) from: 13115 →;		13.0470-5654.2 LD5654	Brake System: Mando Wear Warning Contact: with acoustic wear warning Ceramic
1.6 HDi	84 05/12→	Fitting Position: Rear Axle			
1.6 HDi AWC	84 05/12→				
1.8 HDi	110 05/12→				
1.8 HDi AWC	110 05/12→				
2.0	110 05/13→				
2.0 AWC	110 05/12→				
PEUGEOT - 5008 (0U_, 0E_) 06/09→03/17					
Spring, brake caliper					
1.2	96 01/15→03/17	Required quantity: 2;		2 11.8116-0356.1 390586	Brake System: ATE
1.6 16V	88 - 09/09→03/17 115	Fitting Position: Front Axle			
1.6 BlueHDi 115	85 11/14→03/17				
1.6 BlueHDi 120	88 05/14→03/17				
1.6 HDi	80 - 09/09→03/17 84				
1.6 THP 150	110 02/12→03/17				
→					





	kW							
PEUGEOT - 5008 (OU_, OE_) 06/09→03/17								
Spring, brake caliper								
1.6 THP 163	120	02/12→03/17	Required quantity: 2; Fitting Position: Front Axle	2	11.8116-0356.1 390586 Brake System: ATE			
1.6 THP 165	121	02/12→03/17						
2.0 HDi	120	09/09→03/17						
2.0 HDi 136 / BlueHDi 136	100	02/12→03/17						
2.0 HDi 150 / BlueHDi 150	110	06/09→03/17	Construction year from: 09/09 →; Required quantity: 2; Fitting Position: Front Axle	2	11.8116-0356.1 390586 Brake System: ATE			
Guide Bolt, brake caliper								
1.2	96	01/15→03/17	Required quantity: 2; Fitting Position: Front Axle	2	11.8171-0008.1 990049 Brake System: ATE			
1.6 16V	88	09/09→03/17						
1.6 BlueHDi 115	85	11/14→03/17						
1.6 BlueHDi 120	88	05/14→03/17						
1.6 HDi	80	09/09→03/17						
1.6 THP 150	110	02/12→03/17						
1.6 THP 163	120	02/12→03/17						
1.6 THP 165	121	02/12→03/17						
2.0 HDi	120	09/09→03/17						
2.0 HDi 136 / BlueHDi 136	100	02/12→03/17						
2.0 HDi 150 / BlueHDi 150	110	06/09→03/17						
PEUGEOT - 5008 I Van (OU_) 06/09→03/17								
Spring, brake caliper								
HDi / e-HDi	84	03/13→03/17				Required quantity: 2; Fitting Position: Front Axle	2	11.8116-0356.1 390586 Brake System: ATE
HDi	82	08/10→03/17						
HDi 136	100	02/12→03/17						
HDi 150	110	06/09→03/17						
HDi 165	120	06/09→03/17						
Guide Bolt, brake caliper								
HDi / e-HDi	84	03/13→03/17	Required quantity: 2; Fitting Position: Front Axle	2	11.8171-0008.1 990049 Brake System: ATE			
HDi	82	08/10→03/17						
HDi 136	100	02/12→03/17						
HDi 150	110	06/09→03/17						
HDi 165	120	06/09→03/17						
PEUGEOT - 5008 II (MC_, MJ_, MR_, M4_) 12/16→								
Guide Sleeve Kit, brake caliper								
1.2	96	12/16→	→ for RPO number (vehicle manufacturing date) up to: 16354; Fitting Position: Front Axle	11.0101-5407.2 260011	Brake System: ATE			
1.5 BlueHDi 130	96	02/18→						
1.6	110	07/18→						
1.6 BlueHDi 100	73	12/16→						
1.6 BlueHDi 115	85	12/16→11/19						
1.6 BlueHDi 120	88	12/16→						
1.6 PureTech 180	133	07/18→						
1.6 THP 165	121	12/16→						
2.0 BlueHDi 136	100	12/16→						
2.0 BlueHDi 150	110	12/16→						
2.0 BlueHDi 180	130 - 12/16→	133						
Guide Bolt, brake caliper								
1.2	96	12/16→				→ for RPO number (vehicle manufacturing date) up to: 16354; Fitting Position: Front Axle	11.8171-0008.1 990049	Brake System: ATE
1.5 BlueHDi 130	96	02/18→						
1.6	110	07/18→						
1.6 BlueHDi 100	73	12/16→						
1.6 BlueHDi 115	85	12/16→11/19						
1.6 BlueHDi 120	88	12/16→						
1.6 PureTech 180	133	07/18→						
1.6 THP 165	121	12/16→						
2.0 BlueHDi 136	100	12/16→						
2.0 BlueHDi 150	110	12/16→						
2.0 BlueHDi 180	130 - 12/16→	133						
PEUGEOT - 5008 II Van (MC_, MJ_) 12/16→								
Guide Sleeve Kit, brake caliper								
BlueHDi 130	96	06/18→	→ for RPO number (vehicle manufacturing date) up to: 16354; Fitting Position: Front Axle	11.0101-5407.2 260011	Brake System: ATE			
BlueHDi 180	130	01/18→						
Guide Bolt, brake caliper								
BlueHDi 130	96	06/18→	→ for RPO number (vehicle manufacturing date) up to: 16354; Fitting Position: Front Axle	11.8171-0008.1 990049	Brake System: ATE			
BlueHDi 180	130	01/18→						



	kW				
PEUGEOT - PARTNER Box Body/MPV 04/08→					
Spring, brake caliper					
1.2 THP	81 02/16→	Fitting Position: Front Axle		11.8116-0356.1 390586	Brake System: ATE
1.6 HDi	82 08/10→				
1.6	66 - 04/08→ 88	Required quantity: 2; Fitting Position: Front Axle	2	11.8116-0356.1 390586	Brake System: ATE
1.6 BlueHDi 100	73 04/15→				
1.6 BlueHDi 120	88 04/15→				
1.6 HDi	55 - 04/08→ 84				
1.6 HDi 16V	66 - 04/08→ 68				
1.6 HDi 16V 4x4	66 04/12→				
1.6 HDi 90	68 04/10→				
Électrique	49 06/13→				
1.6 HDi / BlueHDi 75	55 07/11→	Construction year from: 01/15 →; Required quantity: 2; Fitting Position: Front Axle	2	11.8116-0356.1 390586	Brake System: ATE
Guide Bolt, brake caliper					
1.2 THP	81 02/16→	Fitting Position: Front Axle		11.8171-0008.1 990049	Brake System: ATE
1.6 HDi	82 08/10→				
1.6	66 - 04/08→ 88	Required quantity: 2; Fitting Position: Front Axle	2	11.8171-0008.1 990049	Brake System: ATE
1.6 BlueHDi 100	73 04/15→				
1.6 BlueHDi 120	88 04/15→				
1.6 HDi	55 - 04/08→ 84				
1.6 HDi 16V	66 - 04/08→ 68				
1.6 HDi 16V 4x4	66 04/12→				
1.6 HDi 90	68 04/10→				
Électrique	49 06/13→				
1.6 HDi / BlueHDi 75	55 07/11→	Construction year from: 01/15 →; Required quantity: 2; Fitting Position: Front Axle	2	11.8171-0008.1 990049	Brake System: ATE
PEUGEOT - PARTNER Box Body/MPV (K9) 09/18→					
Guide Sleeve Kit, brake caliper					
1.2 PureTech 110	81 07/19→	Fitting Position: Front Axle		11.0101-5407.2 260011	Brake System: ATE
1.2 PureTech 130	96 07/19→				
1.5 BlueHDi 100	75 07/19→				
1.5 BlueHDi 130	96 09/18→				
1.5 BlueHDi 130 4x4	96 09/18→				
1.5 BlueHDi 75	55 07/19→				
1.6 BlueHDi 100	73 09/18→				
1.6 BlueHDi 75	55 09/18→				
e-Partner	100 07/21→				
Guide Bolt, brake caliper					
1.2 PureTech 110	81 07/19→	Required quantity: 2;	2	11.8171-0008.1 990049	Brake System: ATE
1.2 PureTech 130	96 07/19→	Fitting Position: Front Axle			
1.5 BlueHDi 100	75 07/19→				
1.5 BlueHDi 130	96 09/18→				
1.5 BlueHDi 130 4x4	96 09/18→				
1.5 BlueHDi 75	55 07/19→				
1.6 BlueHDi 100	73 09/18→				
1.6 BlueHDi 75	55 09/18→				
e-Partner	100 07/21→				
PEUGEOT - PARTNER Platform/Chassis 01/09→					
Spring, brake caliper					
1.6 BlueHDi 100	73 04/15→	Required quantity: 2;	2	11.8116-0356.1 390586	Brake System: ATE
1.6 HDi	55 - 01/09→ 66	Fitting Position: Front Axle			
1.6 HDi 16V	66 01/09→				
Guide Bolt, brake caliper					
1.6 BlueHDi 100	73 04/15→	Required quantity: 2;	2	11.8171-0008.1 990049	Brake System: ATE
1.6 HDi	55 - 01/09→ 66	Fitting Position: Front Axle			
1.6 HDi 16V	66 01/09→				
PEUGEOT - PARTNER TEEPEE 04/08→					
Spring, brake caliper					
1.2 THP	81 02/16→	Required quantity: 2;	2	11.8116-0356.1 390586	Brake System: ATE
1.6 BlueHDi 100	73 12/14→	Fitting Position: Front Axle			
1.6 BlueHDi 100 4x4	73 04/15→				
1.6 BlueHDi 120	88 12/14→				
1.6 HDi	66 - 04/08→ 84				
→					



	kW				
PEUGEOT - PARTNER TEPEE 04/08→					
Spring, brake caliper					
1.6 HDi / BlueHDi 75	55 06/08→12/18	Required quantity: 2;	2	11.8116-0356.1 390586	Brake System: ATE
1.6 HDi 16V	66 04/08→	Fitting Position: Front Axle			
1.6 HDi 75	55 06/08→				
1.6 HDi 90	68 04/10→				
1.6 VTi	66 - 04/08→				
	88				
1.6 VTi	81 09/08→	Construction year from: 04/10 →;	2	11.8116-0356.1 390586	Brake System: ATE
		Required quantity: 2;			
		Fitting Position: Front Axle			
Électrique	49 06/13→	Fitting Position: Front Axle		11.8116-0356.1 390586	Brake System: ATE
Guide Bolt, brake caliper					
1.2 THP	81 02/16→	Required quantity: 2;	2	11.8171-0008.1 990049	Brake System: ATE
1.6 BlueHDi 100	73 12/14→	Fitting Position: Front Axle			
1.6 BlueHDi 100 4x4	73 04/15→				
1.6 BlueHDi 120	88 12/14→				
1.6 HDi	66 - 04/08→				
	84				
1.6 HDi / BlueHDi 75	55 06/08→12/18				
1.6 HDi 16V	66 04/08→				
1.6 HDi 90	68 04/10→				
1.6 VTi	66 - 04/08→				
	88				
1.6 HDi 75	55 06/08→	Fitting Position: Front Axle		11.8171-0008.1 990049	Brake System: ATE
Électrique	49 06/13→				
1.6 VTi	81 09/08→	Construction year from: 04/10 →;	2	11.8171-0008.1 990049	Brake System: ATE
		Required quantity: 2;			
		Fitting Position: Front Axle			
PEUGEOT - RCZ 03/10→12/15					
Spring, brake caliper					
1.6 16V	115 03/10→12/15	Required quantity: 2	2	11.8116-0356.1 390586	Brake System: ATE
1.6 THP 150	110 03/11→12/15				
2.0 HDi	120 03/10→12/15	Rim Size [in]: 18; Required quantity: 2	2	11.8116-0356.1 390586	Brake System: ATE
Guide Sleeve Kit, brake caliper					
1.6 16V	147 - 06/10→12/15	Fitting Position: Front Axle		11.0101-5407.2 260011	Brake System: ATE
	150				
2.0 HDi	120 03/10→12/15	Rim Size [in]: 19;		11.0101-5407.2 260011	Brake System: ATE
		Fitting Position: Front Axle			
Guide Bolt, brake caliper					
1.6 16V	115 - 03/10→12/15	Required quantity: 2	2	11.8171-0008.1 990049	Brake System: ATE
	150				
1.6 THP 150	110 03/11→12/15				
2.0 HDi	120 03/10→12/15	Rim Size [in]: 18; Required quantity: 2	2	11.8171-0008.1 990049	Brake System: ATE
		Rim Size [in]: 19; Required quantity: 2	2	11.8171-0008.1 990049	Brake System: ATE
PEUGEOT - RIFTER 09/18→					
Guide Sleeve Kit, brake caliper					
1.2 PureTech 110	81 09/18→	Fitting Position: Front Axle		11.0101-5407.2 260011	Brake System: ATE
1.2 PureTech 130	96 07/19→				
1.5 BlueHDi 100	75 09/18→				
1.5 BlueHDi 130	96 09/18→				
1.5 BlueHDi 75	55 09/18→				
1.6 BlueHDi 100	73 09/18→				
1.6 HDi 75 / BlueHDi 75	55 09/18→				
1.6 HDi 92	68 09/18→				
e-Rifter	100 07/21→				
Guide Bolt, brake caliper					
1.2 PureTech 110	81 09/18→	Required quantity: 2;	2	11.8171-0008.1 990049	Brake System: ATE
1.2 PureTech 130	96 07/19→	Fitting Position: Front Axle			
1.5 BlueHDi 100	75 09/18→				
1.5 BlueHDi 130	96 09/18→				
1.5 BlueHDi 75	55 09/18→				
1.6 BlueHDi 100	73 09/18→				
1.6 HDi 75 / BlueHDi 75	55 09/18→				
1.6 HDi 92	68 09/18→				
e-Rifter	100 07/21→				
POLESTAR - POLESTAR 1 (P) 03/18→					
Guide Sleeve Kit, brake caliper					
PHEV AWD	227 - 03/18→	Fitting Position: Rear Axle		11.0101-5407.2 260011	Brake System: ATE
	448				
→					

	kW				
RENAULT - ARKANA I (LCM_, LDN_) 08/19→					
Guide Bolt, brake caliper					
1.3 TCe 140	103 09/20→	Fitting Position: Front Axle		11.8171-0008.1 990049	Brake System: ATE
1.3 TCe 160	116 03/21→				
 Brake Pad Set, disc brake					
1.3 TCe 140	103 09/20→	Equipment Code: ENPH01;		13.0460-2756.2 602756	Brake System: Lucas / TRW
1.3 TCe 160	116 03/21→	Fitting Position: Rear Axle			24820 16,1
1.6 E-TECH 145	69 - 09/20→				Wear Warning Contact: not prepared for wear indicator / excl. wear warning contact
	105				Supplementary Article/Supplementary Info: with accessories
 Wheel Speed Sensor					
1.3 TCe 150	110 08/19→	Fitting Position: Rear Axle Right		24.0710-2099.3 360648	Length [mm]: 592
1.6	84 08/19→				
RENAULT - CAPTUR I (J5_, H5_) 06/13→					
Spring, brake caliper					
1.2 T	83 - 06/13→	Required quantity: 2;		2 11.8116-0356.1 390586	Brake System: ATE
	85	Fitting Position: Front Axle			
1.2 TCe	97 02/18→				
1.2 TCe 120	87 - 06/13→				
	88				
1.3 TCe 130	96 03/18→				
1.3 TCe 150	110 03/18→				
1.5 dCi	63 06/13→				
1.5 dCi 110	81 01/15→				
1.5 dCi 90	66 06/13→				
1.6	84 02/18→				
 Brake Disc					
0.9 TCe 90	66 06/13→	Fitting Position: Front Axle		24.0122-0270.1 422270	Outer diameter [mm]: 258 Brake Disc Thickness [mm] 22 Minimum thickness [mm] 19.8 Brake Disc Type: Vented Supplementary Article/Info 2: with bolts/screws
RENAULT - CAPTUR II (HF_) 01/20→					
Spring, brake caliper					
1.0 TCe 90 ECO-G	67 01/21→	Required quantity: 2;		2 11.8116-0356.1 390586	Brake System: ATE
Blue dCi 115	85 01/20→	Fitting Position: Front Axle			
Blue dCi 95	70 01/20→				
LPG	74 01/20→				
TCe 100	74 01/20→				
TCe 130	96 01/20→				
TCe 140	103 01/20→				
TCe 155	113 01/20→				
TCe 160	116 09/20→				
TCe 90	67 09/20→				
Guide Bolt, brake caliper					
1.0 TCe 90 ECO-G	67 01/21→	Fitting Position: Front Axle		11.8171-0008.1 990049	Brake System: ATE
Blue dCi 115	85 01/20→				
Blue dCi 95	70 01/20→				
LPG	74 01/20→				
TCe 100	74 01/20→				
TCe 130	96 01/20→				
TCe 140	103 01/20→				
TCe 155	113 01/20→				
TCe 160	116 09/20→				
TCe 90	67 09/20→				
 Brake Disc					
E-TECH 145	69 01/22→	Fitting Position: Rear Axle		24.0113-0200.1 413200	Outer diameter [mm]: 290 Brake Disc Thickness [mm] 13 Minimum thickness [mm] 11 Brake Disc Type: Solid
E-TECH 160	68 - 05/20→				
	116				
RENAULT - CLIO IV (BH_) 11/12→					
Guide Bolt, brake caliper					
0.9 TCe 75	56 05/18→	Rim Size [in]: 15 / 16;		11.8171-0008.1 990049	Brake System: ATE
0.9 TCe 90	66 11/12→	Fitting Position: Front Axle			
0.9 TCe 90 LPG	66 06/16→				
1.2 16V	54 - 11/12→				
	55				
1.2 LPG	53 01/14→				
→					

	kW				
RENAULT - CLIO IV (BH_) 11/12→					
Guide Bolt, brake caliper					
1.2 LPG 16V 1.5 dCi 75	54 11/12→06/15 55 11/12→	Rim Size [in]: 15 / 16; Fitting Position: Front Axle	11.8171-0008.1 990049	Brake System: ATE	
1.5 dCi 1.5 dCi 90	62 - 11/12→ 63 66 11/12→	Transmission Type: Manual Transmission; Rim Size [in]: 15 / 16; Fitting Position: Front Axle	11.8171-0008.1 990049	Brake System: ATE	
1.6 RS 1.6 RS Trophy	147 03/13→ 162 03/15→	Fitting Position: Front Axle	11.8171-0008.1 990049	Brake System: ATE	
 Brake Disc					
0.9 TCe 75 0.9 TCe 90 0.9 TCe 90 LPG 1.2 16V 1.2 LPG 1.2 LPG 16V 1.2 TCe 120 1.5 dCi 1.5 dCi 110 1.5 dCi 75 1.5 dCi 90	56 05/18→ 66 11/12→ 66 06/16→ 54 - 11/12→ 55 53 01/14→ 54 11/12→06/15 87 - 03/13→ 88 62 - 11/12→ 63 81 06/16→ 55 11/12→ 66 11/12→	Fitting Position: Front Axle	24.0122-0270.1 422270	Outer diameter [mm]: 258 Brake Disc Thickness [mm] 22 Minimum thickness [mm] 19.8 Brake Disc Type: Vented Supplementary Article/Info 2: with bolts/screws	
RENAULT - CLIO IV Estate Van (KH_) 01/13→					
 Brake Disc					
0.9 TCe 90 1.5 dCi 75 1.5 dCi 90	66 01/14→ 55 01/14→ 66 01/14→	Fitting Position: Front Axle	24.0122-0270.1 422270	Outer diameter [mm]: 258 Brake Disc Thickness [mm] 22 Minimum thickness [mm] 19.8 Brake Disc Type: Vented Supplementary Article/Info 2: with bolts/screws	
RENAULT - CLIO IV Grandtour (KH_) 11/12→					
 Brake Disc					
0.9 TCe 75 0.9 TCe 90 1.2 16V 1.2 TCe 120 1.5 dCi 110 1.5 dCi 75 1.5 dCi 90	56 08/18→ 66 01/13→ 54 01/13→ 87 - 03/13→ 88 81 06/16→ 55 01/13→ 66 11/12→	Fitting Position: Front Axle	24.0122-0270.1 422270	Outer diameter [mm]: 258 Brake Disc Thickness [mm] 22 Minimum thickness [mm] 19.8 Brake Disc Type: Vented Supplementary Article/Info 2: with bolts/screws	
RENAULT - CLIO IV Hatchback Van (BH_) 01/14→					
Guide Bolt, brake caliper					
0.9 TCe 90 0.9 TCe 90 LPG 1.2 16V 1.2 16V LPG 1.5 dCi 75 1.5 dCi 90	66 01/14→ 66 08/15→ 54 - 01/14→ 55 53 01/14→ 55 01/14→ 66 01/14→	Rim Size [in]: 15 / 16; Fitting Position: Front Axle	11.8171-0008.1 990049	Brake System: ATE	
1.5 dCi 90	66 01/14→	Transmission Type: Manual Transmission; Rim Size [in]: 15 / 16; Fitting Position: Front Axle	11.8171-0008.1 990049	Brake System: ATE	
 Brake Disc					
0.9 TCe 90 0.9 TCe 90 LPG 1.2 16V 1.2 16V LPG 1.5 dCi 75 1.5 dCi 90	66 01/14→ 66 08/15→ 54 - 01/14→ 55 53 01/14→ 55 01/14→ 66 01/14→	Fitting Position: Front Axle	24.0122-0270.1 422270	Outer diameter [mm]: 258 Brake Disc Thickness [mm] 22 Minimum thickness [mm] 19.8 Brake Disc Type: Vented Supplementary Article/Info 2: with bolts/screws	
RENAULT - CLIO V (B7_) 06/19→					
Spring, brake caliper					
1.0 LPG 1.0 TCe 100 1.5 Blue dCi 100 1.5 Blue dCi 115 1.5 Blue dCi 85 TCe 90	74 06/19→ 74 06/19→ 74 11/21→ 85 06/19→ 63 06/19→ 67 08/20→	for brake disc diameter [mm]: 280; Required quantity: 2; Fitting Position: Front Axle	2 11.8116-0356.1 390586	Brake System: ATE	
1.3 TCe 130 1.3 TCe 140 1.6 E-TECH 140 →	96 06/19→ 103 09/20→ 67 03/20→	Required quantity: 2; Fitting Position: Front Axle	2 11.8116-0356.1 390586	Brake System: ATE	



	kW							
RENAULT - CLIO V (B7_) 06/19→								
Spring, brake caliper								
1.6 E-TECH 145	69 - 01/22→ 105	Required quantity: 2; Fitting Position: Front Axle	2	11.8116-0356.1 390586	Brake System: ATE			
Guide Bolt, brake caliper								
1.0 LPG	74 06/19→	for brake disc diameter [mm]: 280; Fitting Position: Front Axle		11.8171-0008.1 990049	Brake System: ATE			
1.0 TCe 100	74 06/19→							
1.5 Blue dCi 100	74 11/21→							
1.5 Blue dCi 115	85 06/19→							
1.5 Blue dCi 85	63 06/19→							
TCe 90	67 08/20→							
1.3 TCe 130	96 06/19→	Fitting Position: Front Axle		11.8171-0008.1 990049	Brake System: ATE			
1.3 TCe 140	103 09/20→							
1.6 E-TECH 140	67 03/20→							
1.6 E-TECH 145	69 - 01/22→ 105							
 Brake Pad Set, disc brake								
1.0 LPG	74 06/19→	Fitting Position: Rear Axle		13.0460-2756.2 602756	Brake System: Lucas / TRW 24820 16,1 Wear Warning Contact: not prepared for wear indicator / excl. wear warning contact Supplementary Article/Supple- mentary Info: with accessories			
1.0 SCe 65	48 - 11/19→ 49							
1.0 SCe 75	53 06/19→							
1.0 TCe 100	74 06/19→							
1.3 TCe 130	96 06/19→							
1.3 TCe 140	103 09/20→							
1.5 Blue dCi 100	74 11/21→							
1.5 Blue dCi 115	85 06/19→							
1.5 Blue dCi 85	63 06/19→							
1.6 E-TECH 140	67 03/20→							
1.6 E-TECH 145	69 - 01/22→ 105							
TCe 90	67 08/20→							
RENAULT - DOKKER 12/13→								
Spring, brake caliper								
1.5 dCi	66 12/13→		+ ESP; Required quantity: 2; Fitting Position: Front Axle			2	11.8116-0356.1 390586	Brake System: ATE
1.6	62 12/13→							
 Brake Disc								
1.5 dCi	66 12/13→	- ESP; Payload: not for increased payload; Fitting Position: Front Axle		24.0122-0270.1 422270	Outer diameter [mm]: 258 Brake Disc Thickness [mm] 22 Minimum thickness [mm] 19.8 Brake Disc Type: Vented Supplementary Article/Info 2: with bolts/screws			
1.6	62 12/13→							
RENAULT - DUSTER (HM_) 10/17→								
Spring, brake caliper								
1.3 TCe 150 4x4	110 11/21→	Required quantity: 2; Fitting Position: Front Axle	2	11.8116-0356.1 390586	Brake System: ATE			
1.5 dCi 110	80 07/19→							
1.5 dCi 110 4x4	80 07/19→							
1.6 SCe 115 4x4	84 07/19→							
2.0 4x4	105 11/21→							
1.6 SCe 115	84 07/19→	for brake disc diameter [mm]: 280; Required quantity: 2; Fitting Position: Front Axle	2	11.8116-0356.1 390586	Brake System: ATE			
 Wheel Speed Sensor								
1.5 dCi 110	80 07/19→	Fitting Position: Rear Axle Right		24.0710-2099.3 360648	Length [mm]: 592			
1.6 SCe 115	84 07/19→							
RENAULT - DUSTER (HS_) 01/11→								
Spring, brake caliper								
1.5 dCi	63 02/12→	+ ABS; Required quantity: 2; Fitting Position: Front Axle	2	11.8116-0356.1 390586	Brake System: ATE			
1.5 dCi 4x4	80 09/13→01/18							
2.0	98 - 10/11→ 105							
1.5 dCi 4x4	66 06/11→	Required quantity: 2; Fitting Position: Front Axle	2	11.8116-0356.1 390586	Brake System: ATE			
2.0 4x4	99 - 10/11→ 105							
1.6 16V	75 - 02/12→ 84							
1.6 16V 4x4	75 - 06/11→ 84	+ ESP; Required quantity: 2; Fitting Position: Front Axle	2	11.8116-0356.1 390586	Brake System: ATE			
 Wheel Speed Sensor								
1.5 dCi	63 02/12→	Fitting Position: Rear Axle Right		24.0710-2099.3 360648	Length [mm]: 592			



	kW				
RENAULT - DUSTER (HS_) 01/11→					
 Wheel Speed Sensor					
1.6 16V	75 - 02/12→ 84	Fitting Position: Rear Axle Right		24.0710-2099.3 360648	Length [mm]: 592
2.0	98 02/12→				
2.0	105 10/11→	Construction year from: 02/12 →; Fitting Position: Rear Axle Right		24.0710-2099.3 360648	Length [mm]: 592
RENAULT - ESPACE IV (JK0/1_) 11/02→					
Guide Sleeve Kit, brake caliper					
1.9 dCi	85 - 11/02→ 88	Fitting Position: Front Axle		11.0101-5407.2 260011	Brake System: ATE
2.0	98 - 11/02→ 125				
2.0 dCi	96 - 01/06→ 127				
2.0 Turbo	120 11/02→				
2.2 dCi	102 - 11/02→ 110				
3.0 dCi	120 - 11/02→ 133				
3.5 V6	177 11/02→				
Guide Bolt, brake caliper					
1.9 dCi	85 - 11/02→ 88	Required quantity: 2	2	11.8171-0008.1 990049	Brake System: ATE
2.0	98 - 11/02→ 125				
2.0 dCi	96 - 01/06→ 127				
2.0 Turbo	120 11/02→				
2.2 dCi	102 - 11/02→ 110				
3.0 dCi	120 - 11/02→ 133				
3.5 V6	177 11/02→				
RENAULT - EXPRESS Box Body/MPV 05/21→					
Spring, brake caliper					
1.3 TCe 100	75 05/21→	Required quantity: 2;	2	11.8116-0356.1 390586	Brake System: ATE
1.5 Blue dCi 75	55 05/21→	Fitting Position: Front Axle			
1.5 Blue dCi 95	70 05/21→				
RENAULT - FLUENCE (L3_) 02/10→					
Spring, brake caliper					
1.5 dCi	63 - 02/10→ 81	Required quantity: 2; Fitting Position: Front Axle	2	11.8116-0356.1 390586	Brake System: ATE
1.6	86 01/13→				
1.6 16V	78 - 02/10→ 82				
1.6 dCi	96 07/14→				
1.6 Flex	85 01/12→11/14				
1.6 LPG 16V	81 01/12→				
2.0	105 05/14→				
2.0 16V	101 - 02/10→ 103				
Z.E.	70 02/12→				
 Brake Pad Set, disc brake					
1.5 dCi	63 - 02/10→ 81	Vehicle Equipment: for vehicles with electric parking brake; Fitting Position: Rear Axle		13.0460-2756.2 602756	Brake System: Lucas / TRW 24820 16,1 Wear Warning Contact: not prepared for wear indicator / excl. wear warning contact Supplementary Article/Supple- mentary Info: with accessories
1.6 16V	78 - 02/10→ 82				
1.6 dCi	96 07/14→				
1.6 Flex	85 01/12→11/14				
1.6 LPG 16V	81 01/12→				
2.0	105 05/14→				
2.0 16V	101 - 02/10→ 103				
Z.E.	70 02/12→				
RENAULT - GRAND SCÉNIC II (JM0/1_) 04/04→06/09					
Guide Sleeve Kit, brake caliper					
1.5 dCi	76 06/06→11/08	Fitting Position: Front Axle		11.0101-5407.2 260011	Brake System: ATE
1.6	77 - 06/06→11/08 82				
1.6 Flex	82 06/06→06/09				
1.5 dCi	74 04/04→11/08	→ Construction year to: 10/05;		11.0101-5407.2 260011	Brake System: ATE
1.6	83 04/04→08/06	Fitting Position: Front Axle			
→					

	kW				
RENAULT - GRAND SCÉNIC II (JM0/1_) 04/04→06/09					
Guide Sleeve Kit, brake caliper					
1.9 dCi	81 - 04/04→01/09 96	Construction year from: 11/05 →; Fitting Position: Front Axle		11.0101-5407.2 260011	Brake System: ATE
2.0 dCi	110 09/05→11/08				
1.5 dCi	78 05/05→01/09	Construction year from: 06/06 →; Fitting Position: Front Axle		11.0101-5407.2 260011	Brake System: ATE
2.0	99 04/04→06/09	Construction year from: 11/05 → → Construction year to: 03/09; Fitting Position: Front Axle		11.0101-5407.2 260011	Brake System: ATE
		→ Construction year to: 10/05; Fitting Position: Front Axle		11.0101-5407.2 260011	Brake System: ATE
2.0	120 04/04→06/09	Construction year from: 11/05 → → Construction year to: 03/09; Fitting Position: Front Axle		11.0101-5407.2 260011	Brake System: ATE
Guide Bolt, brake caliper					
1.5 dCi	76 06/06→11/08	Required quantity: 2	2	11.8171-0008.1 990049	Brake System: ATE
1.6	77 - 06/06→11/08 82				
1.6 Flex	82 06/06→06/09				
1.5 dCi	74 04/04→11/08	→ Construction year to: 09/05; Required quantity: 2	2	11.8171-0008.1 990049	Brake System: ATE
1.6	83 04/04→08/06				
1.9 dCi	81 - 04/04→01/09 96	Construction year from: 10/05 →; Required quantity: 2	2	11.8171-0008.1 990049	Brake System: ATE
2.0 dCi	110 09/05→11/08				
1.5 dCi	78 05/05→01/09	Construction year from: 06/06 →; Required quantity: 2	2	11.8171-0008.1 990049	Brake System: ATE
2.0	99 04/04→06/09	Construction year from: 10/05 → → Construction year to: 03/09; Required quantity: 2	2	11.8171-0008.1 990049	Brake System: ATE
		→ Construction year to: 09/05; Required quantity: 2	2	11.8171-0008.1 990049	Brake System: ATE
2.0	120 04/04→06/09	Construction year from: 10/05 → → Construction year to: 03/09; Required quantity: 2	2	11.8171-0008.1 990049	Brake System: ATE
RENAULT - GRAND SCÉNIC III (JZ0/1_) 02/09→					
Spring, brake caliper					
1.5 dCi	63 04/09→	Required quantity: 2; Fitting Position: Front Axle	2	11.8116-0356.1 390586	Brake System: ATE
RENAULT - KADJAR (HA_, HL_) 06/15→					
 Brake Disc					
1.2 TCe 130	96 06/15→	Fitting Position: Rear Axle		24.0113-0200.1 413200	Outer diameter [mm]: 290 Brake Disc Thickness [mm] 13 Minimum thickness [mm] 11 Brake Disc Type: Solid
1.3 TCe 140	103 08/18→				
1.3 TCe 160	116 - 08/18→ 117				
1.5 BLUE dCi 115	85 08/18→				
1.5 dCi 110	81 06/15→				
1.6 dCi 130	96 06/15→				
1.6 dCi 130 4x4	96 06/15→				
1.6 TCe 165	120 11/16→				
1.7 Blue dCi 150	110 08/18→				
1.7 Blue dCi 150 4WD	110 08/18→				
RENAULT - KANGOO / GRAND KANGOO II (KW0/1_) 02/08→					
 Brake Disc					
1.2 TCe 115	84 07/13→	Rim Size [in]: 14; Fitting Position: Front Axle		24.0122-0270.1 422270	Outer diameter [mm]: 258 Brake Disc Thickness [mm] 22 Minimum thickness [mm] 19.8 Brake Disc Type: Vented Supplementary Article/Info 2: with bolts/screws
1.5 dCi	78 02/08→				
1.5 dCi 105	76 02/08→				
1.5 dCi 110	80 - 09/10→ 81				
1.5 dCi 115	85 03/19→				
1.5 dCi 70	50 02/08→				
1.5 dCi 75	55 11/12→				
1.5 dCi 80	59 03/19→				
1.5 dCi 85	63 02/08→				
1.5 dCi 90	66 - 06/08→ 67				
1.5 dCi 95	70 03/19→				
1.6	64 02/08→				
1.6 16V	78 02/08→				
1.6 16V FLEX	78 02/08→				
1.6 16V LPG	78 12/08→				



	kW				
RENAULT - LAGUNA II (BG0/1_) 03/01→12/07					
Guide Sleeve Kit, brake caliper					
2.0 16V	98	08/02→12/06	Fitting Position: Front Axle	11.0101-5407.2 260011	Brake System: ATE
2.0 16V Turbo	120	01/03→03/05			
2.0 dCi	110	08/05→08/06			
2.2 dCi	85	04/04→10/05			
2.9 V6 24V	155	03/01→08/07			
1.6 16V	82	02/05→08/07	→ Construction year to: 06/07; Fitting Position: Front Axle	11.0101-5407.2 260011	Brake System: ATE
1.8 16V	85 - 88	03/01→12/07			
1.9 dCi	79 - 96	03/01→12/07			
2.0 16V	99 - 150	08/02→12/07			
2.0 16V IDE	103	04/01→09/07			
2.0 dCi	127	01/06→08/07			
2.2 dCi	102	05/05→08/07			
3.0 V6 24V	152	03/01→08/07			
2.2 dCi	110	10/01→08/06	Construction year from: 12/01 → → Construction year to: 04/05; Fitting Position: Front Axle	11.0101-5407.2 260011	Brake System: ATE
			→ Construction year to: 11/01; Fitting Position: Front Axle	11.0101-5407.2 260011	Brake System: ATE
			Construction year from: 05/05 →; Fitting Position: Front Axle	11.0101-5407.2 260011	Brake System: ATE
Guide Bolt, brake caliper					
1.6	76	03/01→05/05	Required quantity: 2; Fitting Position: Front Axle	2 11.8171-0008.1 990049	Brake System: ATE
1.6 16V	79	03/01→05/05			
1.6 LPG	79	03/01→05/05			
1.8 16V	86 - 89	03/01→05/05			
1.9 dCi	68 - 74	10/01→05/05			
1.9 dCi	77	06/01→05/05			
2.0 16V	98	08/02→12/06			
2.0 16V Turbo	120	01/03→03/05			
2.0 dCi	110	08/05→08/06			
2.2 dCi	85	04/04→10/05			
2.9 V6 24V	155	03/01→08/07			
1.6 16V	82	02/05→08/07	→ Construction year to: 06/07; Required quantity: 2; Fitting Position: Front Axle	2 11.8171-0008.1 990049	Brake System: ATE
1.8 16V	85 - 88	03/01→12/07			
1.9 dCi	79 - 96	03/01→12/07			
2.0 16V	99 - 150	08/02→12/07			
2.0 16V IDE	103	04/01→09/07			
2.0 dCi	127	01/06→08/07			
2.2 dCi	102	05/05→08/07			
3.0 V6 24V	152	03/01→08/07			
2.2 dCi	110	10/01→08/06	Construction year from: 12/01 → → Construction year to: 04/05; Required quantity: 2; Fitting Position: Front Axle	2 11.8171-0008.1 990049	Brake System: ATE
			Construction year from: 05/05 →; Required quantity: 2; Fitting Position: Front Axle	2 11.8171-0008.1 990049	Brake System: ATE
			→ Construction year to: 11/01; Required quantity: 2; Fitting Position: Front Axle	2 11.8171-0008.1 990049	Brake System: ATE
RENAULT - LAGUNA II Grandtour (KG0/1_) 03/01→12/07					
Guide Sleeve Kit, brake caliper					
1.6	76	03/01→10/05	Fitting Position: Front Axle	11.0101-5407.2 260011	Brake System: ATE
1.8 16V	85 - 89	03/01→05/05			
1.9 dCi	68 - 74	10/01→05/05			
1.9 dCi	77	06/01→05/05			
2.0 16V Turbo	120	01/03→08/05			
2.2 dCi	85	04/04→10/05			
2.9 V6 24V	155	10/03→12/07			
3.0 V6 24V	152	03/01→12/07			
1.6 16V	79 - 82	03/01→12/07	→ Construction year to: 06/07; Fitting Position: Front Axle	11.0101-5407.2 260011	Brake System: ATE
1.6 Bifuel	79	06/05→12/07			
1.9 dCi	79 - 96	03/01→12/07			
2.0 16V	98 - 150	08/02→12/07			
2.0 16V IDE	103	04/01→09/07			
2.0 dCi	127	01/06→12/07			
→					



	kW				
RENAULT - LAGUNA II Grandtour (KG0/1_) 03/01→12/07					
Guide Sleeve Kit, brake caliper					
2.2 dCi	102	05/05→12/07	→ Construction year to: 06/07; Fitting Position: Front Axle	11.0101-5407.2 260011	Brake System: ATE
1.9 dCi	66	08/03→09/07	Construction year from: 03/04 → → Construction year to: 06/07; Fitting Position: Front Axle	11.0101-5407.2 260011	Brake System: ATE
2.0 dCi	110	08/05→08/06	Fitting Position: Front Axle	11.0101-5407.2 260011	Brake System: ATE
			Rim Size [in]: 16; Fitting Position: Front Axle	11.0101-5407.2 260011	Brake System: ATE
2.2 dCi	110	10/01→08/06	Construction year from: 12/01 → → Construction year to: 04/05; Fitting Position: Front Axle	11.0101-5407.2 260011	Brake System: ATE
			→ Construction year to: 11/01; Fitting Position: Front Axle	11.0101-5407.2 260011	Brake System: ATE
			Construction year from: 05/05 → ; Fitting Position: Front Axle	11.0101-5407.2 260011	Brake System: ATE
Guide Bolt, brake caliper					
1.6	76	03/01→10/05	Required quantity: 2	2	11.8171-0008.1 990049 Brake System: ATE
1.8 16V	85 - 89	03/01→05/05			
1.9 dCi	68 - 74	10/01→05/05			
1.9 dCi	77	06/01→05/05			
2.0 16V Turbo	120	01/03→08/05			
2.2 dCi	85	04/04→10/05			
2.9 V6 24V	155	10/03→12/07			
3.0 V6 24V	152	03/01→12/07			
1.6 16V	79 - 82	03/01→12/07			
1.6 Bifuel	79	06/05→12/07			
1.9 dCi	79 - 96	03/01→12/07			
2.0 16V	98 - 150	08/02→12/07			
2.0 16V IDE	103	04/01→09/07			
2.0 dCi	127	01/06→12/07			
2.2 dCi	102	05/05→12/07			
1.9 dCi	66	08/03→09/07	Construction year from: 03/04 → → Construction year to: 06/07; Required quantity: 2	2	11.8171-0008.1 990049 Brake System: ATE
2.0 dCi	110	08/05→08/06	Rim Size [in]: 16; Required quantity: 2	2	11.8171-0008.1 990049 Brake System: ATE
			Required quantity: 2	2	11.8171-0008.1 990049 Brake System: ATE
2.2 dCi	110	10/01→08/06	Construction year from: 12/01 → → Construction year to: 04/05; Required quantity: 2	2	11.8171-0008.1 990049 Brake System: ATE
			→ Construction year to: 11/01; Required quantity: 2	2	11.8171-0008.1 990049 Brake System: ATE
			Construction year from: 05/05 → ; Required quantity: 2	2	11.8171-0008.1 990049 Brake System: ATE
RENAULT - LATITUDE (L70_) 07/10→					
Guide Bolt, brake caliper					
1.5 dCi	81	07/10→	Construction year from: 02/11 → → Construction year to: 06/13; Fitting Position: Rear Axle	11.8171-0008.1 990049	Brake System: ATE
1.6 RS	132	04/14→	Fitting Position: Front Axle	11.8171-0008.1 990049	Brake System: ATE
			Fitting Position: Rear Axle	11.8171-0008.1 990049	Brake System: ATE
2.0 16V	102 - 105	01/11→	→ Construction year to: 06/13; Fitting Position: Rear Axle	11.8171-0008.1 990049	Brake System: ATE
2.0 16V eco2 Flexfuel	103	02/11→			
2.0 dCi 150	110	02/11→			
2.0 dCi 175	127	05/11→			
2.5 V6	130	05/11→			
3.0 dCi 240	177	02/11→			
2.0 dCi 130	96	12/13→	Fitting Position: Rear Axle	11.8171-0008.1 990049	Brake System: ATE
RENAULT - LODGY (JS_) 07/13→					
Spring, brake caliper					
1.5 dCi	62	01/15→	+ ESP; Required quantity: 2; Fitting Position: Front Axle	2	11.8116-0356.1 390586 Brake System: ATE
1.6	59	07/13→			
→					

	kW				
RENAULT - LODGY (JS_) 07/13→					
 Brake Disc					
1.5 dCi 1.6	62 01/15→ 59 07/13→	- ESP; Fitting Position: Front Axle		24.0122-0270.1 422270	Outer diameter [mm]: 258 Brake Disc Thickness [mm] 22 Minimum thickness [mm] 19.8 Brake Disc Type: Vented Supplementary Article/Info 2: with bolts/screws
RENAULT - LOGAN/STEPWAY II (L8_) 09/12→					
Guide Bolt, brake caliper					
1.2 1.2 16V LPG 1.5 dCi 1.6	55 11/13→ 53 11/13→ 62 - 12/13→ 66 59 - 11/13→ 83	Fitting Position: Front Axle		11.8171-0008.1 990049	Brake System: ATE
RENAULT - LOGAN II Estate (K8_) 11/13→					
Guide Bolt, brake caliper					
1.6	78 12/13→	Fitting Position: Front Axle		11.8171-0008.1 990049	Brake System: ATE
 Brake Disc					
TCe 90	66 02/17→12/20	Fitting Position: Front Axle		24.0122-0270.1 422270	Outer diameter [mm]: 258 Brake Disc Thickness [mm] 22 Minimum thickness [mm] 19.8 Brake Disc Type: Vented Supplementary Article/Info 2: with bolts/screws
RENAULT - MASTER III Bus (JV) 02/11→					
 Brake Caliper					
2.3 dCi 100 FWD 2.3 dCi 110 FWD 2.3 dCi 125 FWD 2.3 dCi 135 FWD 2.3 dCi 145 FWD 2.3 dCi 165 FWD 2.3 dCi 170 FWD 2.3 dCi 180 FWD	74 02/11→ 81 09/14→ 92 02/11→ 100 07/14→ 107 02/11→ 120 07/14→ 125 07/15→ 132 01/20→	Fitting Position: Front Axle Left		24.3481-1821.5 241355	Brake System: Brembo Supplementary Article/Supplementary Info: without holder Brake Caliper Type: Fist-type Caliper (2 pistons)
		Fitting Position: Front Axle Right		24.3481-1822.5 241356	Brake System: Brembo Supplementary Article/Supplementary Info: without holder Brake Caliper Type: Fist-type Caliper (2 pistons)
		Tyres: for single tyres; Fitting Position: Rear Axle Left		24.3484-1703.5 241303	Brake System: Bosch Supplementary Article/Supplementary Info: without holder Brake Caliper Type: Fist-type Caliper
		Tyres: for single tyres; Fitting Position: Rear Axle Right		24.3484-1704.5 241304	Brake System: Bosch Supplementary Article/Supplementary Info: without holder Brake Caliper Type: Fist-type Caliper
2.3 dCi 150 FWD	110 10/12→	Fitting Position: Front Axle Left		24.3481-1821.5 241355	Brake System: Brembo Supplementary Article/Supplementary Info: without holder Brake Caliper Type: Fist-type Caliper (2 pistons)
		Fitting Position: Front Axle Right		24.3481-1822.5 241356	Brake System: Brembo Supplementary Article/Supplementary Info: without holder Brake Caliper Type: Fist-type Caliper (2 pistons)
		Construction year from: 01/13 →; Tyres: for single tyres; Fitting Position: Rear Axle Left		24.3484-1703.5 241303	Brake System: Bosch Supplementary Article/Supplementary Info: without holder Brake Caliper Type: Fist-type Caliper
		Construction year from: 01/13 →; Tyres: for single tyres; Fitting Position: Rear Axle Right		24.3484-1704.5 241304	Brake System: Bosch Supplementary Article/Supplementary Info: without holder Brake Caliper Type: Fist-type Caliper
→					

	kW				
RENAULT - MASTER III Bus (JV) 02/11→					
 Brake Disc					
2.3 dCi 100 FWD	74 02/11→		Fitting Position: Front Axle	24.0128-0252.1 428252	Outer diameter [mm]: 302 Brake Disc Thickness [mm] 28 Minimum thickness [mm] 24.5 Brake Disc Type: Vented Supplementary Article/Info 2: with bolts/screws
2.3 dCi 110 FWD	81 09/14→				
2.3 dCi 125 FWD	92 02/11→				
2.3 dCi 135 FWD	100 07/14→				
2.3 dCi 145 FWD	107 02/11→				
2.3 dCi 165 FWD	120 07/14→				
2.3 dCi 170 FWD	125 07/15→				
2.3 dCi 180 FWD	132 01/20→		Fitting Position: Rear Axle	24.0112-0191.1 412191	Outer diameter [mm]: 305 Brake Disc Thickness [mm] 12 Minimum thickness [mm] 10 Brake Disc Type: Solid Supplementary Article/Info 2: with bolts/screws
2.3 dCi 150 FWD	110 10/12→		Construction year from: 01/13 →; Fitting Position: Front Axle	24.0128-0252.1 428252	Outer diameter [mm]: 302 Brake Disc Thickness [mm] 28 Minimum thickness [mm] 24.5 Brake Disc Type: Vented Supplementary Article/Info 2: with bolts/screws
			Construction year from: 01/13 →; Fitting Position: Rear Axle	24.0112-0191.1 412191	Outer diameter [mm]: 305 Brake Disc Thickness [mm] 12 Minimum thickness [mm] 10 Brake Disc Type: Solid Supplementary Article/Info 2: with bolts/screws
RENAULT - MASTER III Platform/Chassis (EV, HV, UV) 02/10→					
 Brake Caliper					
2.3 dCi 100 FWD	74 02/10→		Fitting Position: Front Axle Left	24.3481-1821.5 241355	Brake System: Brembo Supplementary Article/Supplementary Info: without holder Brake Caliper Type: Fist-type Caliper (2 pistons)
2.3 dCi 100 RWD	74 02/10→				
2.3 dCi 110 FWD	81 09/14→				
2.3 dCi 125 FWD	92 02/10→				
2.3 dCi 125 RWD	92 02/10→				
2.3 dCi 130 FWD	96 03/12→		Fitting Position: Front Axle Right	24.3481-1822.5 241356	Brake System: Brembo Supplementary Article/Supplementary Info: without holder Brake Caliper Type: Fist-type Caliper (2 pistons)
2.3 dCi 135 FWD	100 07/14→				
2.3 dCi 135 RWD	100 07/14→				
2.3 dCi 145 FWD	107 02/10→				
2.3 dCi 145 RWD	107 02/10→				
2.3 dCi 150 FWD	110 03/13→				
2.3 dCi 150 RWD	110 03/13→		Tyres: for single tyres; Fitting Position: Rear Axle Left	24.3484-1703.5 241303	Brake System: Bosch Supplementary Article/Supplementary Info: without holder Brake Caliper Type: Fist-type Caliper
2.3 dCi 165 FWD	120 07/14→				
2.3 dCi 165 RWD	120 07/14→				
2.3 dCi 170 FWD	125 06/16→		Tyres: for single tyres; Fitting Position: Rear Axle Right	24.3484-1704.5 241304	Brake System: Bosch Supplementary Article/Supplementary Info: without holder Brake Caliper Type: Fist-type Caliper
2.3 dCi 130 RWD	96 07/16→		Fitting Position: Front Axle Left	24.3481-1821.5 241355	Brake System: Brembo Supplementary Article/Supplementary Info: without holder Brake Caliper Type: Fist-type Caliper (2 pistons)
			Fitting Position: Front Axle Right	24.3481-1822.5 241356	Brake System: Brembo Supplementary Article/Supplementary Info: without holder Brake Caliper Type: Fist-type Caliper (2 pistons)
			Construction year from: 07/16 →; Tyres: for single tyres; Fitting Position: Rear Axle Left	24.3484-1703.5 241303	Brake System: Bosch Supplementary Article/Supplementary Info: without holder Brake Caliper Type: Fist-type Caliper
			Construction year from: 07/16 →; Tyres: for single tyres; Fitting Position: Rear Axle Right	24.3484-1704.5 241304	Brake System: Bosch Supplementary Article/Supplementary Info: without holder Brake Caliper Type: Fist-type Caliper
2.3 dCi 180 FWD	132 07/19→		Fitting Position: Front Axle Left	24.3481-1821.5 241355	Brake System: Brembo Supplementary Article/Supplementary Info: without holder Brake Caliper Type: Fist-type Caliper (2 pistons)
Z.E.	57 03/18→				
			Fitting Position: Front Axle Right	24.3481-1822.5 241356	Brake System: Brembo Supplementary Article/Supplementary Info: without holder Brake Caliper Type: Fist-type Caliper (2 pistons)

→



	kW				
RENAULT - MASTER III Platform/Chassis (EV, HV, UV) 02/10→					
 Brake Caliper					
2.3 dCi 180 FWD Z.E.	132 07/19→ 57 03/18→		Fitting Position: Rear Axle Left	24.3484-1703.5 241303	Brake System: Bosch Supplementary Article/Supplementary Info: without holder Brake Caliper Type: Fist-type Caliper
			Fitting Position: Rear Axle Right	24.3484-1704.5 241304	Brake System: Bosch Supplementary Article/Supplementary Info: without holder Brake Caliper Type: Fist-type Caliper
 Brake Disc					
2.3 dCi 100 FWD 2.3 dCi 110 FWD 2.3 dCi 125 FWD 2.3 dCi 130 FWD 2.3 dCi 135 FWD 2.3 dCi 145 FWD 2.3 dCi 150 FWD 2.3 dCi 165 FWD 2.3 dCi 170 FWD 2.3 dCi 180 FWD Z.E.	74 02/10→ 81 09/14→ 92 02/10→ 96 03/12→ 100 07/14→ 107 02/10→ 110 03/13→ 120 07/14→ 125 06/16→ 132 07/19→ 57 03/18→		Fitting Position: Front Axle	24.0128-0252.1 428252	Outer diameter [mm]: 302 Brake Disc Thickness [mm] 28 Minimum thickness [mm] 24.5 Brake Disc Type: Vented Supplementary Article/Info 2: with bolts/screws
			Fitting Position: Rear Axle	24.0112-0191.1 412191	Outer diameter [mm]: 305 Brake Disc Thickness [mm] 12 Minimum thickness [mm] 10 Brake Disc Type: Solid Supplementary Article/Info 2: with bolts/screws
2.3 dCi 100 RWD 2.3 dCi 125 RWD 2.3 dCi 130 RWD 2.3 dCi 135 RWD 2.3 dCi 145 RWD 2.3 dCi 150 RWD 2.3 dCi 165 RWD	74 02/10→ 92 02/10→ 96 07/16→ 100 07/14→ 107 02/10→ 110 03/13→ 120 07/14→		Fitting Position: Front Axle	24.0128-0252.1 428252	Outer diameter [mm]: 302 Brake Disc Thickness [mm] 28 Minimum thickness [mm] 24.5 Brake Disc Type: Vented Supplementary Article/Info 2: with bolts/screws
			Tyres: for single tyres; Fitting Position: Rear Axle	24.0112-0190.1 412190	Outer diameter [mm]: 305 Brake Disc Thickness [mm] 12 Minimum thickness [mm] 10 Brake Disc Type: Solid Supplementary Article/Info 2: with bolts/screws
			Tyres: for dual tyres; Fitting Position: Rear Axle	24.0118-0153.1 418153	Outer diameter [mm]: 302 Brake Disc Thickness [mm] 18 Minimum thickness [mm] 15 Brake Disc Type: Solid
RENAULT - MASTER III Van (FV) 02/10→					
 Brake Caliper					
2.3 dCi 100 FWD 2.3 dCi 100 RWD 2.3 dCi 110 FWD 2.3 dCi 125 FWD 2.3 dCi 125 RWD 2.3 dCi 130 FWD 2.3 dCi 130 RWD 2.3 dCi 135 FWD 2.3 dCi 135 RWD 2.3 dCi 145 FWD 2.3 dCi 145 RWD 2.3 dCi 150 FWD 2.3 dCi 150 RWD 2.3 dCi 165 FWD 2.3 dCi 165 RWD 2.3 dCi 170 FWD	74 02/10→ 74 02/10→ 81 09/14→ 92 02/10→ 92 02/10→ 96 06/16→ 96 03/12→ 100 07/14→ 100 07/14→ 107 02/10→ 107 02/10→ 110 03/13→ 110 03/13→ 120 07/14→ 120 07/14→ 125 07/15→		Fitting Position: Front Axle Left	24.3481-1821.5 241355	Brake System: Brembo Supplementary Article/Supplementary Info: without holder Brake Caliper Type: Fist-type Caliper (2 pistons)
			Fitting Position: Front Axle Right	24.3481-1822.5 241356	Brake System: Brembo Supplementary Article/Supplementary Info: without holder Brake Caliper Type: Fist-type Caliper (2 pistons)
			Tyres: for single tyres; Fitting Position: Rear Axle Left	24.3484-1703.5 241303	Brake System: Bosch Supplementary Article/Supplementary Info: without holder Brake Caliper Type: Fist-type Caliper
			Tyres: for single tyres; Fitting Position: Rear Axle Right	24.3484-1704.5 241304	Brake System: Bosch Supplementary Article/Supplementary Info: without holder Brake Caliper Type: Fist-type Caliper
2.3 dCi 180 FWD Z.E.	132 07/19→ 57 03/18→		Fitting Position: Front Axle Left	24.3481-1821.5 241355	Brake System: Brembo Supplementary Article/Supplementary Info: without holder Brake Caliper Type: Fist-type Caliper (2 pistons)
			Fitting Position: Front Axle Right	24.3481-1822.5 241356	Brake System: Brembo Supplementary Article/Supplementary Info: without holder Brake Caliper Type: Fist-type Caliper (2 pistons)
→					



	kW				
RENAULT - MASTER III Van (FV) 02/10→					
 Brake Caliper					
2.3 dCi 180 FWD Z.E.	132 07/19→ 57 03/18→		Fitting Position: Rear Axle Left	24.3484-1703.5 241303	Brake System: Bosch Supplementary Article/Supplementary Info: without holder Brake Caliper Type: Fist-type Caliper
			Fitting Position: Rear Axle Right	24.3484-1704.5 241304	Brake System: Bosch Supplementary Article/Supplementary Info: without holder Brake Caliper Type: Fist-type Caliper
 Brake Disc					
2.3 dCi 100 FWD 2.3 dCi 110 FWD 2.3 dCi 125 FWD 2.3 dCi 130 FWD 2.3 dCi 135 FWD 2.3 dCi 145 FWD 2.3 dCi 150 FWD 2.3 dCi 165 FWD 2.3 dCi 170 FWD 2.3 dCi 180 FWD Z.E.	74 02/10→ 81 09/14→ 92 02/10→ 96 06/16→ 100 07/14→ 107 02/10→ 110 03/13→ 120 07/14→ 125 07/15→ 132 07/19→ 57 03/18→		Fitting Position: Front Axle	24.0128-0252.1 428252	Outer diameter [mm]: 302 Brake Disc Thickness [mm] 28 Minimum thickness [mm] 24.5 Brake Disc Type: Vented Supplementary Article/Info 2: with bolts/screws
			Fitting Position: Rear Axle	24.0112-0191.1 412191	Outer diameter [mm]: 305 Brake Disc Thickness [mm] 12 Minimum thickness [mm] 10 Brake Disc Type: Solid Supplementary Article/Info 2: with bolts/screws
2.3 dCi 100 RWD 2.3 dCi 125 RWD 2.3 dCi 130 RWD 2.3 dCi 135 RWD 2.3 dCi 145 RWD 2.3 dCi 150 RWD 2.3 dCi 165 RWD	74 02/10→ 92 02/10→ 96 03/12→ 100 07/14→ 107 02/10→ 110 03/13→ 120 07/14→		Fitting Position: Front Axle	24.0128-0252.1 428252	Outer diameter [mm]: 302 Brake Disc Thickness [mm] 28 Minimum thickness [mm] 24.5 Brake Disc Type: Vented Supplementary Article/Info 2: with bolts/screws
			Tyres: for single tyres; Fitting Position: Rear Axle	24.0112-0190.1 412190	Outer diameter [mm]: 305 Brake Disc Thickness [mm] 12 Minimum thickness [mm] 10 Brake Disc Type: Solid Supplementary Article/Info 2: with bolts/screws
			Tyres: for dual tyres; Fitting Position: Rear Axle	24.0118-0153.1 418153	Outer diameter [mm]: 302 Brake Disc Thickness [mm] 18 Minimum thickness [mm] 15 Brake Disc Type: Solid
RENAULT - MEGANE II (BM0/1_, CM0/1_) 07/01→10/12					
Guide Sleeve Kit, brake caliper					
1.4 16V	60 - 11/02→02/08 72		Construction year from: 11/05 →; Fitting Position: Front Axle	11.0101-5407.2 260011	Brake System: ATE
1.5 dCi	63 - 10/03→02/08 74		Fitting Position: Rear Axle	11.0101-5407.2 260011	Brake System: ATE
1.6 16V 1.9 dCi 2.0 16V 2.0 16V Turbo	83 11/02→02/08 88 11/02→02/08 99 11/02→02/08 120 05/04→02/08				
1.5 dCi	60 09/02→02/08		Construction year from: 11/05 →; Fitting Position: Front Axle	11.0101-5407.2 260011	Brake System: ATE
			Construction year from: 11/02 →; Fitting Position: Rear Axle	11.0101-5407.2 260011	Brake System: ATE
1.5 dCi 1.9 dCi	76 01/07→03/09 96 05/05→12/09		→ Construction year to: 11/08; Fitting Position: Front Axle	11.0101-5407.2 260011	Brake System: ATE
			→ Construction year to: 11/08; Fitting Position: Rear Axle	11.0101-5407.2 260011	Brake System: ATE
1.5 dCi 1.6	78 05/05→06/08 77 - 06/05→01/11 79		Fitting Position: Front Axle	11.0101-5407.2 260011	Brake System: ATE
			Fitting Position: Rear Axle	11.0101-5407.2 260011	Brake System: ATE
1.6 16V 1.6 Flex-Fuel 2.0 dCi	82 01/06→06/08 77 01/07→02/08 110 09/05→02/08				
1.6 Bifuel	77 06/05→02/08		Construction year from: 01/07 →; Fitting Position: Front Axle	11.0101-5407.2 260011	Brake System: ATE
			Construction year from: 01/07 →; Fitting Position: Rear Axle	11.0101-5407.2 260011	Brake System: ATE
1.9 dCi	68 - 11/02→02/08 85		Construction year from: 01/06 →; Fitting Position: Front Axle	11.0101-5407.2 260011	Brake System: ATE
			Construction year from: 01/06 →; Fitting Position: Rear Axle	11.0101-5407.2 260011	Brake System: ATE
2.0	169 08/06→02/08		Fitting Position: Rear Axle	11.0101-5407.2 260011	Brake System: ATE
2.0 Renault Sport	165 05/04→10/09		→ Construction year to: 11/08; Fitting Position: Rear Axle	11.0101-5407.2 260011	Brake System: ATE
→					





	kW				
RENAULT - MEGANE II (BM0/1_, CM0/1_) 07/01→10/12					
Guide Bolt, brake caliper					
1.4 16V	60 - 11/02→02/08		Construction year from: 10/05 →;	2	11.8171-0008.1 990049 Brake System: ATE
	72		Required quantity: 2		
1.5 dCi	63 05/05→02/08		Required quantity: 2	2	11.8171-0008.1 990049 Brake System: ATE
1.6 16V	83 11/02→02/08				
1.9 dCi	88 11/02→02/08				
2.0 16V	99 11/02→02/08				
2.0 16V Turbo	120 05/04→02/08				
1.5 dCi	74 10/03→02/08		Construction year from: 10/05 →;	2	11.8171-0008.1 990049 Brake System: ATE
			Required quantity: 2;		
			Fitting Position: Front Axle		
			Required quantity: 2;	2	11.8171-0008.1 990049 Brake System: ATE
			Fitting Position: Rear Axle		
1.5 dCi	60 09/02→02/08		Construction year from: 10/05 →;	2	11.8171-0008.1 990049 Brake System: ATE
			Required quantity: 2		
			Construction year from: 11/02 →;	2	11.8171-0008.1 990049 Brake System: ATE
			Required quantity: 2		
1.5 dCi	76 01/07→03/09		→ Construction year to: 11/08;	2	11.8171-0008.1 990049 Brake System: ATE
1.9 dCi	96 05/05→12/09		Required quantity: 2		
2.0 Renault Sport	165 05/04→10/09				
1.5 dCi	78 05/05→06/08		Required quantity: 2	2	11.8171-0008.1 990049 Brake System: ATE
1.6	77 - 06/05→01/11				
	79				
1.6 16V	82 01/06→06/08				
1.6 Flex-Fuel	77 01/07→02/08				
2.0	169 08/06→02/08				
2.0 dCi	110 09/05→02/08				
1.6 Bifuel	77 06/05→02/08		Construction year from: 01/07 →;	2	11.8171-0008.1 990049 Brake System: ATE
			Required quantity: 2		
1.9 dCi	68 - 11/02→02/08		Construction year from: 01/06 →;	2	11.8171-0008.1 990049 Brake System: ATE
	85		Required quantity: 2		
RENAULT - MEGANE II Coupé-Cabriolet (EM0/1_) 09/03→03/10					
Guide Sleeve Kit, brake caliper					
1.5 dCi	76 01/07→06/09		Fitting Position: Front Axle		11.0101-5407.2 260011 Brake System: ATE
2.0 dCi	110 09/05→03/09				
1.5 dCi	78 03/06→01/09		→ Construction year to: 06/08;		11.0101-5407.2 260011 Brake System: ATE
			Fitting Position: Front Axle		
1.6	77 - 09/03→03/09		Construction year from: 11/05 →;		11.0101-5407.2 260011 Brake System: ATE
	83		Fitting Position: Front Axle		
1.9 dCi	81 - 09/03→03/09				
	96				
2.0	102 09/03→02/07				
2.0 16V Turbo	120 05/04→03/09				
1.6 16V	82 01/06→06/08		Construction year from: 01/07 →;		11.0101-5407.2 260011 Brake System: ATE
			Fitting Position: Front Axle		
1.9 dCi	85 09/03→03/09		Construction year from: 01/06 →;		11.0101-5407.2 260011 Brake System: ATE
			Fitting Position: Front Axle		
2.0	99 09/03→12/09		Construction year from: 11/05 → →		11.0101-5407.2 260011 Brake System: ATE
			Construction year to: 03/07;		
			Fitting Position: Front Axle		
Guide Bolt, brake caliper					
1.5 dCi	76 01/07→06/09		Required quantity: 2	2	11.8171-0008.1 990049 Brake System: ATE
2.0 dCi	110 09/05→03/09				
1.5 dCi	78 03/06→01/09		→ Construction year to: 06/08;	2	11.8171-0008.1 990049 Brake System: ATE
			Required quantity: 2		
1.6	77 - 09/03→03/09		Construction year from: 10/05 →;	2	11.8171-0008.1 990049 Brake System: ATE
	83		Required quantity: 2		
1.9 dCi	81 - 09/03→03/09				
	96				
2.0	102 09/03→02/07				
2.0 16V Turbo	120 05/04→03/09				
1.6 16V	82 01/06→06/08		Construction year from: 01/07 →;	2	11.8171-0008.1 990049 Brake System: ATE
			Required quantity: 2		
1.9 dCi	85 09/03→03/09		Construction year from: 01/06 →;	2	11.8171-0008.1 990049 Brake System: ATE
			Required quantity: 2		
2.0	99 09/03→12/09		Construction year from: 10/05 → →	2	11.8171-0008.1 990049 Brake System: ATE
			Construction year to: 03/07;		
			Required quantity: 2		
RENAULT - MEGANE II Estate (KM0/1_) 08/03→08/12					
Guide Sleeve Kit, brake caliper					
1.4	72 08/03→07/09		Construction year from: 11/05 → →		11.0101-5407.2 260011 Brake System: ATE
1.6	83 08/03→07/09		Construction year to: 12/08;		
1.9 dCi	81 - 08/03→07/09		Fitting Position: Front Axle		
	88				
2.0	99 08/03→07/09				
→					



	kW				
RENAULT - MEGANE II Estate (KM0/1_) 08/03→08/12					
Guide Sleeve Kit, brake caliper					
1.5 dCi	60 - 08/03→07/09	78	Construction year from: 11/05 →;	11.0101-5407.2 260011	Brake System: ATE
1.6 16V	75 - 05/05→07/09	77	Fitting Position: Front Axle		
1.9 dCi	66 - 03/04→02/07	68			
1.5 dCi	76 01/07→07/09		→ Construction year to: 12/08;	11.0101-5407.2 260011	Brake System: ATE
1.6 16V Hi-Flex	77 02/08→07/09		Fitting Position: Front Axle		
2.0 dCi	110 09/05→07/09				
1.6 16V	81 05/06→10/11		→ Construction year to: 07/09;	11.0101-5407.2 260011	Brake System: ATE
			Fitting Position: Front Axle		
1.6 16V	82 01/06→08/09		Construction year from: 01/07 → →	11.0101-5407.2 260011	Brake System: ATE
			Construction year to: 12/08;		
			Fitting Position: Front Axle		
1.6 LPG 16V	82 01/06→08/09		Fitting Position: Front Axle	11.0101-5407.2 260011	Brake System: ATE
2.0	102 12/06→01/11				
1.9 dCi	96 05/05→07/09		Construction year from: 11/05 → →	11.0101-5407.2 260011	Brake System: ATE
			Construction year to: 02/07;		
			Fitting Position: Front Axle		
Guide Bolt, brake caliper					
1.4	72 08/03→07/09		Construction year from: 10/05 → →	2 11.8171-0008.1 990049	Brake System: ATE
1.6	83 08/03→07/09		Construction year to: 12/08;		
1.9 dCi	81 - 08/03→07/09		Required quantity: 2		
	88				
2.0	99 08/03→07/09				
1.5 dCi	60 - 08/03→07/09		Construction year from: 10/05 →;	2 11.8171-0008.1 990049	Brake System: ATE
	78		Required quantity: 2		
1.6 16V	75 - 05/05→07/09				
	77				
1.9 dCi	66 - 03/04→02/07				
	68				
1.5 dCi	76 01/07→07/09		→ Construction year to: 12/08;	2 11.8171-0008.1 990049	Brake System: ATE
1.6 16V Hi-Flex	77 02/08→07/09		Required quantity: 2		
2.0 dCi	110 09/05→07/09				
1.6 16V	81 05/06→10/11		→ Construction year to: 07/09;	2 11.8171-0008.1 990049	Brake System: ATE
			Required quantity: 2		
1.6 16V	82 01/06→08/09		Construction year from: 01/07 → →	2 11.8171-0008.1 990049	Brake System: ATE
			Construction year to: 12/08;		
			Required quantity: 2		
1.6 LPG 16V	82 01/06→08/09		Required quantity: 2	2 11.8171-0008.1 990049	Brake System: ATE
2.0	102 12/06→01/11				
1.9 dCi	96 05/05→07/09		Construction year from: 10/05 → →	2 11.8171-0008.1 990049	Brake System: ATE
			Construction year to: 02/07;		
			Required quantity: 2		
RENAULT - MEGANE II Estate Van (KM_) 08/03→07/09					
Guide Sleeve Kit, brake caliper					
1.5 dCi	60 - 08/03→07/09		Construction year from: 11/05 →;	11.0101-5407.2 260011	Brake System: ATE
	78		Fitting Position: Front Axle		
1.6	82 10/03→01/08				
1.9 dCi	96 02/06→10/06		Fitting Position: Front Axle	11.0101-5407.2 260011	Brake System: ATE
Guide Bolt, brake caliper					
1.5 dCi	60 - 08/03→07/09		Construction year from: 10/05 →;	2 11.8171-0008.1 990049	Brake System: ATE
	78		Required quantity: 2		
1.6	82 10/03→01/08				
1.9 dCi	96 02/06→10/06		Required quantity: 2	2 11.8171-0008.1 990049	Brake System: ATE
RENAULT - MEGANE II Hatchback Van (KM0/2_) 08/03→07/09					
Guide Sleeve Kit, brake caliper					
1.5 dCi	60 - 08/03→02/08		Construction year from: 11/05 →;	11.0101-5407.2 260011	Brake System: ATE
	74		Fitting Position: Front Axle		
			Fitting Position: Rear Axle	11.0101-5407.2 260011	Brake System: ATE
1.5 dCi	76 - 05/05→03/09		Fitting Position: Front Axle	11.0101-5407.2 260011	Brake System: ATE
	78		Fitting Position: Rear Axle	11.0101-5407.2 260011	Brake System: ATE
Guide Bolt, brake caliper					
1.5 dCi	60 - 08/03→02/08		Construction year from: 10/05 →;	2 11.8171-0008.1 990049	Brake System: ATE
	63		Required quantity: 2		
			Required quantity: 2	2 11.8171-0008.1 990049	Brake System: ATE
1.5 dCi	74 08/03→02/08		Construction year from: 10/05 →;	2 11.8171-0008.1 990049	Brake System: ATE
			Required quantity: 2;		
			Fitting Position: Front Axle		
			Required quantity: 2;		
			Fitting Position: Rear Axle	2 11.8171-0008.1 990049	Brake System: ATE
→					

RENAULT - MEGANE II Hatchback Van (KM0/2_) 08/03→07/09							
Guide Bolt, brake caliper							
1.5 dCi	76 - 05/05→03/09 78	Required quantity: 2	2	11.8171-0008.1	990049	Brake System: ATE	
RENAULT - MEGANE II Saloon (LM0/1_) 08/03→							
Guide Sleeve Kit, brake caliper							
1.4	60 09/03→	→ Construction year to: 08/06; Fitting Position: Rear Axle		11.0101-5407.2	260011	Brake System: ATE	
1.4	72 09/03→	→ Construction year to: 12/08; Fitting Position: Rear Axle		11.0101-5407.2	260011	Brake System: ATE	
1.5 dCi	74 02/04→12/10	Construction year from: 11/05 → → Construction year to: 03/06; Fitting Position: Front Axle		11.0101-5407.2	260011	Brake System: ATE	
		→ Construction year to: 03/06; Fitting Position: Rear Axle		11.0101-5407.2	260011	Brake System: ATE	
1.5 dCi	60 08/03→12/10	Construction year from: 11/05 → → Construction year to: 12/08; Fitting Position: Front Axle		11.0101-5407.2	260011	Brake System: ATE	
		Construction year from: 09/03 → → Construction year to: 12/08; Fitting Position: Rear Axle		11.0101-5407.2	260011	Brake System: ATE	
1.5 dCi 1.6 16V	76 10/03→12/10 82 01/06→	Construction year from: 01/07 → → Construction year to: 12/08; Fitting Position: Front Axle		11.0101-5407.2	260011	Brake System: ATE	
		Construction year from: 01/07 → → Construction year to: 12/08; Fitting Position: Rear Axle		11.0101-5407.2	260011	Brake System: ATE	
1.5 dCi 1.6 1.9 dCi 2.0	63 - 05/05→12/10 78 77 - 09/03→ 83 68 - 09/03→ 96 99 09/03→	Construction year from: 11/05 → → Construction year to: 12/08; Fitting Position: Front Axle		11.0101-5407.2	260011	Brake System: ATE	
		→ Construction year to: 12/08; Fitting Position: Rear Axle		11.0101-5407.2	260011	Brake System: ATE	
1.6	81 09/03→11/08	Construction year from: 11/05 → →; Fitting Position: Front Axle		11.0101-5407.2	260011	Brake System: ATE	
1.6 Hi-Flex 2.0 dCi	85 03/06→ 110 09/05→	→ Construction year to: 12/08; Fitting Position: Front Axle		11.0101-5407.2	260011	Brake System: ATE	
		→ Construction year to: 12/08; Fitting Position: Rear Axle		11.0101-5407.2	260011	Brake System: ATE	
1.9 dCi	66 09/03→12/05	Construction year from: 11/05 → →; Fitting Position: Front Axle		11.0101-5407.2	260011	Brake System: ATE	
		Fitting Position: Rear Axle		11.0101-5407.2	260011	Brake System: ATE	
2.0	101 04/06→11/10	Fitting Position: Front Axle		11.0101-5407.2	260011	Brake System: ATE	
Guide Bolt, brake caliper							
1.4	60 09/03→	→ Construction year to: 08/06; Required quantity: 2; Fitting Position: Rear Axle	2	11.8171-0008.1	990049	Brake System: ATE	
1.4	72 09/03→	→ Construction year to: 12/08; Required quantity: 2; Fitting Position: Rear Axle	2	11.8171-0008.1	990049	Brake System: ATE	
1.5 dCi	74 02/04→12/10	Construction year from: 10/05 → → Construction year to: 03/06; Required quantity: 2	2	11.8171-0008.1	990049	Brake System: ATE	
		→ Construction year to: 03/06; Required quantity: 2; Fitting Position: Rear Axle	2	11.8171-0008.1	990049	Brake System: ATE	
1.5 dCi	60 08/03→12/10	Construction year from: 10/05 → → Construction year to: 12/08; Required quantity: 2	2	11.8171-0008.1	990049	Brake System: ATE	
		Construction year from: 09/03 → → Construction year to: 12/08; Required quantity: 2; Fitting Position: Rear Axle	2	11.8171-0008.1	990049	Brake System: ATE	
1.5 dCi 1.6 16V	76 10/03→12/10 82 01/06→	Construction year from: 01/07 → → Construction year to: 12/08; Required quantity: 2	2	11.8171-0008.1	990049	Brake System: ATE	
		Construction year from: 01/07 → → Construction year to: 12/08; Required quantity: 2; Fitting Position: Rear Axle	2	11.8171-0008.1	990049	Brake System: ATE	
1.5 dCi 1.6 1.9 dCi →	63 - 05/05→12/10 78 77 - 09/03→ 83 68 - 09/03→ 96	Construction year from: 10/05 → → Construction year to: 12/08; Required quantity: 2	2	11.8171-0008.1	990049	Brake System: ATE	



	kW				
RENAULT - MEGANE II Saloon (LM0/1_) 08/03→					
Guide Bolt, brake caliper					
2.0	99 09/03→		→ Construction year to: 12/08; Required quantity: 2; Fitting Position: Rear Axle	2	11.8171-0008.1 990049 Brake System: ATE
1.6	81 09/03→11/08		Construction year from: 10/05 →; Required quantity: 2	2	11.8171-0008.1 990049 Brake System: ATE
1.6 Hi-Flex 2.0 dCi	85 03/06→ 110 09/05→		→ Construction year to: 12/08; Required quantity: 2	2	11.8171-0008.1 990049 Brake System: ATE
			→ Construction year to: 12/08; Required quantity: 2; Fitting Position: Rear Axle	2	11.8171-0008.1 990049 Brake System: ATE
1.9 dCi	66 09/03→12/05		Construction year from: 10/05 →; Required quantity: 2	2	11.8171-0008.1 990049 Brake System: ATE
			Required quantity: 2; Fitting Position: Rear Axle	2	11.8171-0008.1 990049 Brake System: ATE
2.0	101 04/06→11/10		Required quantity: 2	2	11.8171-0008.1 990049 Brake System: ATE
RENAULT - MEGANE III Combi Van (KZ0/1) 01/09→08/15					
Spring, brake caliper					
1.5 dCi	63 - 01/09→08/15 81		Required quantity: 2; Fitting Position: Front Axle	2	11.8116-0356.1 390586 Brake System: ATE
 Brake Pad Set, disc brake					
1.5 dCi	63 - 01/09→08/15 81		Vehicle Equipment: for vehicles with electric parking brake; Fitting Position: Rear Axle	13.0460-2756.2 602756	Brake System: Lucas / TRW 24820 16,1 Wear Warning Contact: not prepared for wear indicator / excl. wear warning contact Supplementary Article/Supple- mentary Info: with accessories
RENAULT - MEGANE III Coupe (DZ0/1_) 11/08→					
Spring, brake caliper					
1.2 TCe	85 - 03/12→08/15 97		Required quantity: 2; Fitting Position: Front Axle	2	11.8116-0356.1 390586 Brake System: ATE
1.4 TCe	96 04/09→				
1.5 dCi	63 - 11/08→ 81				
1.6 16V	74 - 11/08→ 81				
1.6 16V Bifuel	81 11/08→				
1.6 dCi	96 04/11→08/15				
1.9 dCi	96 11/08→08/15				
2.0 CVT	103 05/09→				
 Brake Pad Set, disc brake					
1.2 TCe	85 03/12→08/15		Vehicle Equipment: for vehicles with electric parking brake; Fitting Position: Rear Axle	13.0460-2756.2 602756	Brake System: Lucas / TRW 24820 16,1 Wear Warning Contact: not prepared for wear indicator / excl. wear warning contact Supplementary Article/Supple- mentary Info: with accessories
1.4 TCe	96 04/09→				
1.5 dCi	63 - 11/08→ 81				
1.6 16V	74 - 11/08→ 81				
1.6 16V Bifuel	81 11/08→				
1.6 dCi	96 04/11→08/15				
1.9 dCi	96 11/08→08/15				
2.0 CVT	103 05/09→				
2.0 dCi	110 - 04/09→ 118				
2.0 TCe	132 - 11/08→ 140				
2.0 TCe 220	162 11/13→				
RENAULT - MEGANE III Grandtour (KZ0/1) 11/08→					
Spring, brake caliper					
1.2 TCe	85 - 03/12→ 97		Required quantity: 2; Fitting Position: Front Axle	2	11.8116-0356.1 390586 Brake System: ATE
1.4 TCe	96 05/09→				
1.5 dCi	63 - 02/09→ 81				
1.6 16V	74 - 05/09→ 81				
1.6 BiFuel	81 11/08→				
1.6 dCi	96 04/11→				
1.9 dCi	96 05/09→				
2.0 CVT	103 05/09→				
→					





	kW				
RENAULT - MEGANE III Grandtour (KZ0/1) 11/08→					
 Brake Pad Set, disc brake					
1.2 TCe	85 - 03/12→ 97	Vehicle Equipment: for vehicles with electric parking brake; Fitting Position: Rear Axle		13.0460-2756.2 602756	Brake System: Lucas / TRW 24820 16,1 Wear Warning Contact: not prepared for wear indicator / excl. wear warning contact Supplementary Article/Supplementary Info: with accessories
1.4 TCe	96 05/09→				
1.5 dCi	63 - 02/09→ 81				
1.6 16V	74 - 05/09→ 81				
1.6 BiFuel	81 11/08→				
1.6 dCi	96 04/11→				
1.9 dCi	96 05/09→				
2.0 CVT	103 05/09→				
2.0 dCi	110 - 04/09→ 120				
2.0 TCe	140 - 09/12→ 162				
2.0 TCe	132 11/08→	Construction year from: 05/09 →; Vehicle Equipment: for vehicles with electric parking brake; Fitting Position: Rear Axle		13.0460-2756.2 602756	Brake System: Lucas / TRW 24820 16,1 Wear Warning Contact: not prepared for wear indicator / excl. wear warning contact Supplementary Article/Supplementary Info: with accessories
RENAULT - MEGANE III Hatchback (BZ0/1_, B3_) 11/08→					
Spring, brake caliper					
1.2 TCe	85 - 03/12→ 97	Required quantity: 2; Fitting Position: Front Axle	2	11.8116-0356.1 390586	Brake System: ATE
1.4 TCe	96 04/09→				
1.5 dCi	63 - 11/08→ 81				
1.6	86 01/14→				
1.6 16V	74 - 11/08→ 85				
1.6 16V BiFuel	81 05/09→08/15				
1.6 16V Hi-Flex	81 11/08→08/15				
1.6 dCi	96 04/11→08/15				
1.9 dCi	96 11/08→				
2.0	105 01/11→				
2.0 CVT	103 02/09→				
 Brake Pad Set, disc brake					
1.2 TCe	85 - 03/12→ 97	Vehicle Equipment: for vehicles with electric parking brake; Fitting Position: Rear Axle		13.0460-2756.2 602756	Brake System: Lucas / TRW 24820 16,1 Wear Warning Contact: not prepared for wear indicator / excl. wear warning contact Supplementary Article/Supplementary Info: with accessories
1.4 TCe	96 04/09→				
1.5 dCi	63 - 11/08→ 81				
1.6	86 01/14→				
1.6 16V	74 - 11/08→ 85				
1.6 16V BiFuel	81 05/09→08/15				
1.6 16V Hi-Flex	81 11/08→08/15				
1.6 dCi	96 04/11→08/15				
1.9 dCi	96 11/08→				
2.0	105 01/11→				
2.0 CVT	103 02/09→				
2.0 dCi	110 - 04/09→ 118				
2.0 TCe	132 - 11/08→ 140				
2.0 TCe 220	162 11/13→				
RENAULT - MEGANE III Hatchback Van (BZ_) 11/08→08/15					
Spring, brake caliper					
1.5 dCi	66 - 11/08→08/15 81	Required quantity: 2; Fitting Position: Front Axle	2	11.8116-0356.1 390586	Brake System: ATE
 Brake Pad Set, disc brake					
1.5 dCi	66 - 11/08→08/15 81	Vehicle Equipment: for vehicles with electric parking brake; Fitting Position: Rear Axle		13.0460-2756.2 602756	Brake System: Lucas / TRW 24820 16,1 Wear Warning Contact: not prepared for wear indicator / excl. wear warning contact Supplementary Article/Supplementary Info: with accessories





		kW					
RENAULT - MEGANE IV Grandtour (K9A/M/N_) 04/16→							
 Brake Pad Set, disc brake							
1.0 TCe 115	84	07/21→	Vehicle Equipment: for vehicles with electric parking brake; Fitting Position: Rear Axle	13.0460-2756.2 602756	Brake System: Lucas / TRW 24820 16,1 Wear Warning Contact: not prepared for wear indicator / excl. wear warning contact Supplementary Article/Supplementary Info: with accessories		
1.2 TCe 100	74	04/16→					
1.2 TCe 130	97	04/16→					
1.3 TCe 100	75	08/18→					
1.3 TCe 115	85	01/18→					
1.3 TCe 120	89	09/20→					
1.3 TCe 140	103	01/18→					
1.3 TCe 160	116 -	01/18→					
	120						
1.5 Blue dCi 115	85	08/18→					
1.5 Blue dCi 95	70	08/18→					
1.5 dCi 110	81	04/16→					
1.5 dCi 90	66	04/16→					
1.6 16V	84	04/16→					
1.6 dCi 130	96	04/16→					
1.6 TCe 165	121	07/17→					
1.8 Blue dCi 150	110	02/19→					
1.6 dCi 165	120	04/16→	Vehicle Equipment: for vehicles with electric parking brake; Equipment Code: EA1/EA2 / EA3/E3B; Fitting Position: Rear Axle	13.0460-2756.2 602756	Brake System: Lucas / TRW 24820 16,1 Wear Warning Contact: not prepared for wear indicator / excl. wear warning contact Supplementary Article/Supplementary Info: with accessories		
 Brake Disc							
E-TECH 160	67 -	05/20→	Fitting Position: Rear Axle	24.0113-0200.1 413200	Outer diameter [mm]: 290 Brake Disc Thickness [mm] 13 Minimum thickness [mm] 11 Brake Disc Type: Solid		
		116					
RENAULT - MEGANE IV Hatchback (B9A/M/N_) 11/15→							
 Brake Pad Set, disc brake							
1.0 TCe 115	84	10/20→	Vehicle Equipment: for vehicles with electric parking brake; Fitting Position: Rear Axle	13.0460-2756.2 602756	Brake System: Lucas / TRW 24820 16,1 Wear Warning Contact: not prepared for wear indicator / excl. wear warning contact Supplementary Article/Supplementary Info: with accessories		
1.2 TCe 100	74	11/15→					
1.2 TCe 130	97	11/15→					
1.3 TCe 100	75	08/18→					
1.3 TCe 115	85	01/18→					
1.3 TCe 120	89	09/20→					
1.3 TCe 140	103	01/18→					
1.3 TCe 160	116 -	01/18→					
	120						
1.5 Blue dCi 115	85	08/18→					
1.5 Blue dCi 95	70	08/18→					
1.5 dCi 110	81	11/15→					
1.5 dCi 90	66	11/15→					
1.6 16V	84	11/15→					
1.6 dCi 130	96	11/15→					
1.6 TCe 165	121	07/17→					
1.8 Blue dCi 150	110	02/19→					
1.6 dCi 165	120	11/15→	Vehicle Equipment: for vehicles with electric parking brake; Equipment Code: EA1/EA2 / EA3/E3B; Fitting Position: Rear Axle	13.0460-2756.2 602756	Brake System: Lucas / TRW 24820 16,1 Wear Warning Contact: not prepared for wear indicator / excl. wear warning contact Supplementary Article/Supplementary Info: with accessories		
 Brake Disc							
1.6 E-TECH 160	69 -	07/21→	Fitting Position: Rear Axle	24.0113-0200.1 413200	Outer diameter [mm]: 290 Brake Disc Thickness [mm] 13 Minimum thickness [mm] 11 Brake Disc Type: Solid		
		118					
RENAULT - MEGANE IV Saloon 10/16→							
 Brake Pad Set, disc brake							
1.2 Tce 130	97	10/16→	Vehicle Equipment: for vehicles with electric parking brake; Fitting Position: Rear Axle	13.0460-2756.2 602756	Brake System: Lucas / TRW 24820 16,1 Wear Warning Contact: not prepared for wear indicator / excl. wear warning contact Supplementary Article/Supplementary Info: with accessories		
1.3 TCe 115	85	01/18→					
1.3 TCe 140	103	01/18→					
1.5 Blue dCi 115	85	02/19→					
1.5 Blue dCi 95	70	02/19→					
1.5 dCi 110	81	10/16→					
1.5 dCi 90	66	10/16→					
1.6 dCi 130	96	10/16→					
1.6 S Ce	84	10/16→					





	kW				
RENAULT - MEGANE CC (EZ0/1_) 06/10→					
Spring, brake caliper					
1.2 TCe	85 09/12→08/15	Required quantity: 2;	2	11.8116-0356.1 390586	Brake System: ATE
1.4 TCe	96 06/10→	Fitting Position: Front Axle			
1.5 dCi	78 - 06/10→				
	81				
1.6 16V	81 06/10→				
1.6 16V Hi-Flex	81 06/10→				
1.6 dCi	96 04/11→				
1.9 dCi	96 06/10→				
2.0 CVT	103 06/10→				
1.2 TCe	97 01/13→	Construction year from: 04/13 →;	2	11.8116-0356.1 390586	Brake System: ATE
		Required quantity: 2;			
		Fitting Position: Front Axle			
 Brake Pad Set, disc brake					
1.2 TCe	85 09/12→08/15	Vehicle Equipment: for vehicles with	13.0460-2756.2 602756	Brake System: Lucas / TRW	
1.4 TCe	96 06/10→	electric parking brake;		24820 16,1	
1.5 dCi	78 - 06/10→	Fitting Position: Rear Axle		Wear Warning Contact: not	
	81			prepared for wear indicator / excl.	
1.6 16V	81 06/10→			wear warning contact	
1.6 16V Hi-Flex	81 06/10→			Supplementary Article/Supple-	
1.6 dCi	96 04/11→			mentary Info: with accessories	
1.9 dCi	96 06/10→				
2.0 CVT	103 06/10→				
2.0 dCi	118 06/10→				
2.0 TCe	132 06/10→				
1.2 TCe	97 01/13→	Construction year from: 04/13 →;	13.0460-2756.2 602756	Brake System: Lucas / TRW	
		Vehicle Equipment: for vehicles with		24820 16,1	
		electric parking brake;		Wear Warning Contact: not	
		Fitting Position: Rear Axle		prepared for wear indicator / excl.	
				wear warning contact	
				Supplementary Article/Supple-	
				mentary Info: with accessories	
RENAULT - MEGANE E-TECH SUV 11/21→					
Guide Bolt, brake caliper					
EV40	96 11/21→	Fitting Position: Front Axle	11.8171-0008.1 990049	Brake System: ATE	
EV60	160 11/21→				
RENAULT - SANDERO/STEPWAY II (B8_) 11/13→					
Guide Bolt, brake caliper					
TCe 90	66 09/15→	Fitting Position: Front Axle	11.8171-0008.1 990049	Brake System: ATE	
 Brake Disc					
1.5 dCi	66 01/17→	+ ABS; Fitting Position: Front Axle	24.0122-0270.1 422270	Outer diameter [mm]: 258	
				Brake Disc Thickness [mm] 22	
				Minimum thickness [mm] 19.8	
				Brake Disc Type: Vented	
				Supplementary Article/Info 2: with	
				bolts/screws	
RENAULT - SCÉNIC II (JM0/1_) 06/03→07/10					
Guide Sleeve Kit, brake caliper					
1.4	72 06/03→11/08	Construction year from: 11/05 →;	11.0101-5407.2 260011	Brake System: ATE	
1.5 dCi	60 - 06/03→11/08	Fitting Position: Front Axle			
	78				
1.6	83 06/03→10/06				
1.6 BiFuel	83 08/03→05/06				
1.6 Hi-Flex	81 03/05→07/10				
1.9 dCi	72 - 06/03→11/08				
	96				
2.0 16V Turbo	120 05/04→11/08				
1.5 dCi	76 01/07→11/08	Fitting Position: Front Axle	11.0101-5407.2 260011	Brake System: ATE	
1.6	77 06/06→11/08				
1.9 D	85 06/06→11/08				
1.9 dCi 130	97 10/05→12/09				
2.0 dCi	110 09/05→11/08				
1.6 16V	82 10/05→11/08	Construction year from: 01/07 →;	11.0101-5407.2 260011	Brake System: ATE	
		Fitting Position: Front Axle			
2.0	99 06/03→06/09	Construction year from: 11/05 → →	11.0101-5407.2 260011	Brake System: ATE	
		Construction year to: 03/09;			
		Fitting Position: Front Axle			
2.0	101 02/08→04/09	→ Construction year to: 03/09;	11.0101-5407.2 260011	Brake System: ATE	
		Fitting Position: Front Axle			
Guide Bolt, brake caliper					
1.4	72 06/03→11/08	Construction year from: 10/05 →;	2	11.8171-0008.1 990049	Brake System: ATE
		Required quantity: 2			
→					







	kW				
RENAULT - SCÉNIC II (JM0/1_) 06/03→07/10					
Guide Bolt, brake caliper					
1.5 dCi 1.6 1.6 BiFuel 1.6 Hi-Flex 1.9 dCi 2.0 16V Turbo	60 - 06/03→11/08 78 83 06/03→10/06 83 08/03→05/06 81 03/05→07/10 72 - 06/03→11/08 96 120 05/04→11/08	Construction year from: 10/05 →; Required quantity: 2	2	11.8171-0008.1 990049	Brake System: ATE
1.5 dCi 1.6 1.9 D 1.9 dCi 130 2.0 dCi	76 01/07→11/08 77 06/06→11/08 85 06/06→11/08 97 10/05→12/09 110 09/05→11/08	Required quantity: 2	2	11.8171-0008.1 990049	Brake System: ATE
1.6 16V	82 10/05→11/08	Construction year from: 01/07 →; Required quantity: 2	2	11.8171-0008.1 990049	Brake System: ATE
2.0	99 06/03→06/09	Construction year from: 10/05 → → Construction year to: 03/09; Required quantity: 2	2	11.8171-0008.1 990049	Brake System: ATE
2.0	101 02/08→04/09	→ Construction year to: 03/09; Required quantity: 2	2	11.8171-0008.1 990049	Brake System: ATE
RENAULT - SCÉNIC III (JZ0/1_) 12/08→					
Spring, brake caliper					
1.5 dCi 1.6 16V 1.6 16V Bifuel	63 - 04/09→ 81 81 02/09→ 79 04/12→12/13	Rim Size [in]: 15; Required quantity: 2; Fitting Position: Front Axle	2	11.8116-0356.1 390586	Brake System: ATE
1.5 dCi	78 02/09→	Construction year from: 04/09 →; Rim Size [in]: 15; Required quantity: 2; Fitting Position: Front Axle	2	11.8116-0356.1 390586	Brake System: ATE
1.6 16V Bifuel 1.6 E85	81 02/09→ 81 02/09→	Construction year from: 06/09 →; Rim Size [in]: 15; Required quantity: 2; Fitting Position: Front Axle	2	11.8116-0356.1 390586	Brake System: ATE
 Brake Pad Set, disc brake					
1.2 TCe 1.4 16V 1.5 dCi 1.6 16V 1.6 16V Bifuel 1.6 dCi 1.9 dCi 2.0 16V 2.0 dCi	85 - 04/12→ 96 96 02/09→ 63 - 04/09→ 81 81 02/09→ 79 04/12→12/13 96 04/11→ 96 02/09→ 101 12/08→ 118 04/09→	Vehicle Equipment: for vehicles with electric parking brake; Fitting Position: Rear Axle		13.0460-2756.2 602756	Brake System: Lucas / TRW 24820 16,1 Wear Warning Contact: not prepared for wear indicator / excl. wear warning contact Supplementary Article/Supple- mentary Info: with accessories
1.2 TCe	97 01/13→	Construction year from: 03/13 →; Vehicle Equipment: for vehicles with electric parking brake; Fitting Position: Rear Axle		13.0460-2756.2 602756	Brake System: Lucas / TRW 24820 16,1 Wear Warning Contact: not prepared for wear indicator / excl. wear warning contact Supplementary Article/Supple- mentary Info: with accessories
1.5 dCi 2.0 16V 2.0 dCi	78 02/09→ 103 02/09→ 110 02/09→	Construction year from: 04/09 →; Vehicle Equipment: for vehicles with electric parking brake; Fitting Position: Rear Axle		13.0460-2756.2 602756	Brake System: Lucas / TRW 24820 16,1 Wear Warning Contact: not prepared for wear indicator / excl. wear warning contact Supplementary Article/Supple- mentary Info: with accessories
1.6 16V Bifuel 1.6 E85	81 02/09→ 81 02/09→	Construction year from: 06/09 →; Vehicle Equipment: for vehicles with electric parking brake; Fitting Position: Rear Axle		13.0460-2756.2 602756	Brake System: Lucas / TRW 24820 16,1 Wear Warning Contact: not prepared for wear indicator / excl. wear warning contact Supplementary Article/Supple- mentary Info: with accessories
RENAULT - SCÉNIC III VAN (JZ0/1_) 12/08→					
Spring, brake caliper					
1.5 dCi 1.6 VVT →	70 - 04/09→ 81 81 01/13→	Rim Size [in]: 15; Required quantity: 2; Fitting Position: Front Axle	2	11.8116-0356.1 390586	Brake System: ATE







RENAULT - SCÉNIC III VAN (JZ0/1_) 12/08→						
 Brake Pad Set, disc brake						
1.4 TCe 1.5 dCi 1.6 dCi 1.6 VVT 1.9 dCi	96 01/13→ 70 - 04/09→ 81 96 01/13→ 81 01/13→ 96 01/13→	Vehicle Equipment: for vehicles with electric parking brake; Fitting Position: Rear Axle		13.0460-2756.2 602756	Brake System: Lucas / TRW 24820 16,1 Wear Warning Contact: not prepared for wear indicator / excl. wear warning contact Supplementary Article/Supplementary Info: with accessories	
RENAULT - TALIAN 08/21→						
Spring, brake caliper						
1.0 TCe 100 ECO LPG 1.0 TCe 90	74 08/21→ 66 08/21→	Country-spec. model: Turkey; Required quantity: 2; Fitting Position: Front Axle	2	11.8116-0356.1 390586	Brake System: ATE	
Guide Bolt, brake caliper						
1.0 TCe 100 ECO LPG 1.0 TCe 90	74 08/21→ 66 08/21→	Country-spec. model: Turkey; Fitting Position: Front Axle		11.8171-0008.1 990049	Brake System: ATE	
RENAULT - THALIA III (L8_) 12/13→						
Guide Bolt, brake caliper						
1.0 SCe 1.5 dCi	54 01/17→ 70 11/19→	Fitting Position: Front Axle		11.8171-0008.1 990049	Brake System: ATE	
RENAULT - TRAFIC II Bus (JL) 03/01→						
 Brake Caliper						
1.9 dCi 1.9 dCi 100 1.9 dCi 80	59 04/01→07/03 74 03/01→10/06 60 03/01→10/06	Construction year from: 11/01 →; Fitting Position: Rear Axle Left		24.3414-1707.5 240337	Brake System: Lucas / TRW Supplementary Article/Supplementary Info: without holder Brake Caliper Type: Fist-type Caliper	
		Construction year from: 11/01 →; Fitting Position: Rear Axle Right		24.3414-1708.5 240338	Brake System: Lucas / TRW Supplementary Article/Supplementary Info: without holder Brake Caliper Type: Fist-type Caliper	
1.9 dCi 2.5 dCi 135	75 01/12→12/18 99 05/03→10/06	Fitting Position: Rear Axle Left		24.3414-1707.5 240337	Brake System: Lucas / TRW Supplementary Article/Supplementary Info: without holder Brake Caliper Type: Fist-type Caliper	
		Fitting Position: Rear Axle Right		24.3414-1708.5 240338	Brake System: Lucas / TRW Supplementary Article/Supplementary Info: without holder Brake Caliper Type: Fist-type Caliper	
2.0	88 03/01→	Construction year from: 11/01 → → Construction year to: 08/14; Fitting Position: Rear Axle Left		24.3414-1707.5 240337	Brake System: Lucas / TRW Supplementary Article/Supplementary Info: without holder Brake Caliper Type: Fist-type Caliper	
		Construction year from: 11/01 → → Construction year to: 08/14; Fitting Position: Rear Axle Right		24.3414-1708.5 240338	Brake System: Lucas / TRW Supplementary Article/Supplementary Info: without holder Brake Caliper Type: Fist-type Caliper	
2.0 16V 2.5 dCi 115	86 08/06→ 84 02/08→	→ Construction year to: 08/14; Fitting Position: Rear Axle Left		24.3414-1707.5 240337	Brake System: Lucas / TRW Supplementary Article/Supplementary Info: without holder Brake Caliper Type: Fist-type Caliper	
		→ Construction year to: 08/14; Fitting Position: Rear Axle Right		24.3414-1708.5 240338	Brake System: Lucas / TRW Supplementary Article/Supplementary Info: without holder Brake Caliper Type: Fist-type Caliper	
2.0 dCi 115 2.0 dCi 90 2.5 dCi 145	84 08/06→ 66 08/06→ 107 08/06→	Construction year from: 10/06 → → Construction year to: 08/14; Fitting Position: Rear Axle Left		24.3414-1707.5 240337	Brake System: Lucas / TRW Supplementary Article/Supplementary Info: without holder Brake Caliper Type: Fist-type Caliper	
		Construction year from: 10/06 → → Construction year to: 08/14; Fitting Position: Rear Axle Right		24.3414-1708.5 240338	Brake System: Lucas / TRW Supplementary Article/Supplementary Info: without holder Brake Caliper Type: Fist-type Caliper	
→						



	kW				
RENAULT - TRAFIC II Bus (JL) 03/01→					
 Brake Pad Set, disc brake					
1.9 dCi 1.9 dCi 100 1.9 dCi 80 2.5 dCi 135	59 - 04/01→12/18 75 74 03/01→10/06 60 03/01→10/06 99 05/03→10/06	Fitting Position: Rear Axle		13.0460-2840.2 602840	Brake System: Lucas / TRW 23980 16,5 Wear Warning Contact: prepared for wear indicator / excl. wear warning contact
2.0 2.0 16V 2.5 dCi 115	88 03/01→ 86 08/06→ 84 02/08→	→ Construction year to: 08/14; Fitting Position: Rear Axle		13.0460-2840.2 602840	Brake System: Lucas / TRW 23980 16,5 Wear Warning Contact: prepared for wear indicator / excl. wear warning contact
2.0 dCi 115 2.0 dCi 90 2.5 dCi 145	84 08/06→ 66 08/06→ 107 08/06→	Construction year from: 10/06 → → Construction year to: 08/14; Fitting Position: Rear Axle		13.0460-2840.2 602840	Brake System: Lucas / TRW 23980 16,5 Wear Warning Contact: prepared for wear indicator / excl. wear warning contact
 Brake Hose					
1.9 dCi 1.9 dCi 100 1.9 dCi 80 2.5 dCi 135	59 - 04/01→12/18 75 74 03/01→10/06 60 03/01→10/06 99 05/03→10/06	Required quantity: 2; Fitting Position: Centre		2 24.5229-0200.3 330572	Length [mm]: 200
2.0 2.0 16V 2.5 dCi 115	88 03/01→ 86 08/06→ 84 02/08→	→ Construction year to: 08/14; Required quantity: 2; Fitting Position: Centre		2 24.5229-0200.3 330572	Length [mm]: 200
2.0 dCi 115 2.0 dCi 90 2.5 dCi 145	84 08/06→ 66 08/06→ 107 08/06→	Construction year from: 10/06 → → Construction year to: 08/14; Required quantity: 2; Fitting Position: Centre		2 24.5229-0200.3 330572	Length [mm]: 200
 Wheel Speed Sensor					
1.9 dCi 1.9 dCi 100 1.9 dCi 80 2.0 2.0 16V 2.0 dCi 115 2.0 dCi 90 2.5 dCi 115 2.5 dCi 135 2.5 dCi 145	59 - 04/01→12/18 75 74 03/01→10/06 60 03/01→10/06 88 03/01→ 86 08/06→ 84 08/06→ 66 08/06→ 84 02/08→ 99 05/03→10/06 107 08/06→	Required quantity: 2; Manufacturer Restriction: BOSCH; Fitting Position: Front Axle		2 24.0710-2097.3 360647	Length [mm]: 720
		Required quantity: 2; Manufacturer Restriction: BOSCH; Fitting Position: Rear Axle		2 24.0710-2100.3 360649	Length [mm]: 956
RENAULT - TRAFIC II Platform/Chassis (EL) 03/01→					
 Brake Caliper					
1.9 dCi 1.9 dCi 100 1.9 dCi 80 2.0	59 09/01→07/03 74 03/01→10/06 60 03/01→10/06 88 03/01→10/06	Construction year from: 11/01 → ; Fitting Position: Rear Axle Left		24.3414-1707.5 240337	Brake System: Lucas / TRW Supplementary Article/Supplementary Info: without holder Brake Caliper Type: Fist-type Caliper
		Construction year from: 11/01 → ; Fitting Position: Rear Axle Right		24.3414-1708.5 240338	Brake System: Lucas / TRW Supplementary Article/Supplementary Info: without holder Brake Caliper Type: Fist-type Caliper
2.0 16V 2.5 dCi	86 08/06→ 84 08/07→	→ Construction year to: 08/14; Fitting Position: Rear Axle Left		24.3414-1707.5 240337	Brake System: Lucas / TRW Supplementary Article/Supplementary Info: without holder Brake Caliper Type: Fist-type Caliper
		→ Construction year to: 08/14; Fitting Position: Rear Axle Right		24.3414-1708.5 240338	Brake System: Lucas / TRW Supplementary Article/Supplementary Info: without holder Brake Caliper Type: Fist-type Caliper
2.0 dCi 115 2.0 dCi 90 2.5 dCi 145	84 08/06→ 66 08/06→ 107 08/06→	Construction year from: 10/06 → → Construction year to: 08/14; Fitting Position: Rear Axle Left		24.3414-1707.5 240337	Brake System: Lucas / TRW Supplementary Article/Supplementary Info: without holder Brake Caliper Type: Fist-type Caliper
		Construction year from: 10/06 → → Construction year to: 08/14; Fitting Position: Rear Axle Right		24.3414-1708.5 240338	Brake System: Lucas / TRW Supplementary Article/Supplementary Info: without holder Brake Caliper Type: Fist-type Caliper
→					





	kW				
RENAULT - TRAFIC II Platform/Chassis (EL) 03/01→					
 Brake Caliper					
2.5 dCi 135	99	03/01→10/06	Construction year from: 05/03 →; Fitting Position: Rear Axle Left	24.3414-1707.5 240337	Brake System: Lucas / TRW Supplementary Article/Supplementary Info: without holder Brake Caliper Type: Fist-type Caliper
			Construction year from: 05/03 →; Fitting Position: Rear Axle Right	24.3414-1708.5 240338	Brake System: Lucas / TRW Supplementary Article/Supplementary Info: without holder Brake Caliper Type: Fist-type Caliper
 Brake Pad Set, disc brake					
1.9 dCi 1.9 dCi 100 1.9 dCi 80 2.0	59 74 60 88	09/01→07/03 03/01→10/06 03/01→10/06 03/01→10/06	Fitting Position: Rear Axle	13.0460-2840.2 602840	Brake System: Lucas / TRW 23980 16,5 Wear Warning Contact: prepared for wear indicator / excl. wear warning contact
2.0 16V 2.5 dCi	86 84	08/06→ 08/07→	→ Construction year to: 08/14; Fitting Position: Rear Axle	13.0460-2840.2 602840	Brake System: Lucas / TRW 23980 16,5 Wear Warning Contact: prepared for wear indicator / excl. wear warning contact
2.0 dCi 115 2.0 dCi 90 2.5 dCi 145	84 66 107	08/06→ 08/06→ 08/06→	Construction year from: 10/06 → → Construction year to: 08/14; Fitting Position: Rear Axle	13.0460-2840.2 602840	Brake System: Lucas / TRW 23980 16,5 Wear Warning Contact: prepared for wear indicator / excl. wear warning contact
2.5 dCi 135	99	03/01→10/06	Construction year from: 05/03 →; Fitting Position: Rear Axle	13.0460-2840.2 602840	Brake System: Lucas / TRW 23980 16,5 Wear Warning Contact: prepared for wear indicator / excl. wear warning contact
 Brake Hose					
1.9 dCi 1.9 dCi 100 1.9 dCi 80 2.0	59 74 60 88	09/01→07/03 03/01→10/06 03/01→10/06 03/01→10/06	Required quantity: 2; Fitting Position: Centre	2 24.5229-0200.3 330572	Length [mm]: 200
2.0 16V 2.5 dCi	86 84	08/06→ 08/07→	→ Construction year to: 08/14; Required quantity: 2; Fitting Position: Centre	2 24.5229-0200.3 330572	Length [mm]: 200
2.0 dCi 115 2.0 dCi 90 2.5 dCi 145	84 66 107	08/06→ 08/06→ 08/06→	Construction year from: 10/06 → → Construction year to: 08/14; Required quantity: 2; Fitting Position: Centre	2 24.5229-0200.3 330572	Length [mm]: 200
2.5 dCi 135	99	03/01→10/06	Construction year from: 05/03 →; Required quantity: 2; Fitting Position: Centre	2 24.5229-0200.3 330572	Length [mm]: 200
 Wheel Speed Sensor					
1.9 dCi 1.9 dCi 100 1.9 dCi 80 2.0	59 74 60 88	09/01→07/03 03/01→10/06 03/01→10/06 03/01→10/06	Required quantity: 2; Manufacturer Restriction: BOSCH; Fitting Position: Front Axle	2 24.0710-2097.3 360647	Length [mm]: 720
2.0 16V 2.0 dCi 115 2.0 dCi 90 2.5 dCi 2.5 dCi 135 2.5 dCi 145	86 84 66 84 99 107	08/06→ 08/06→ 08/06→ 08/07→ 03/01→10/06 08/06→	Required quantity: 2; Manufacturer Restriction: BOSCH; Fitting Position: Rear Axle	2 24.0710-2100.3 360649	Length [mm]: 956
RENAULT - TRAFIC II Van (FL) 03/01→					
 Brake Caliper					
1.9 dCi 1.9 dCi 100 1.9 dCi 80	59 74 60	04/01→07/03 03/01→10/06 03/01→10/06	Construction year from: 11/01 →; Fitting Position: Rear Axle Left	24.3414-1707.5 240337	Brake System: Lucas / TRW Supplementary Article/Supplementary Info: without holder Brake Caliper Type: Fist-type Caliper
			Construction year from: 11/01 →; Fitting Position: Rear Axle Right	24.3414-1708.5 240338	Brake System: Lucas / TRW Supplementary Article/Supplementary Info: without holder Brake Caliper Type: Fist-type Caliper
→					

	kW				
RENAULT - TRAFIC II Van (FL) 03/01→					
 Brake Caliper					
1.9 dCi 2.0	75 03/01→ 88 03/01→	Construction year from: 11/01 → → Construction year to: 08/14; Fitting Position: Rear Axle Left		24.3414-1707.5 240337	Brake System: Lucas / TRW Supplementary Article/Supplementary Info: without holder Brake Caliper Type: Fist-type Caliper
		Construction year from: 11/01 → → Construction year to: 08/14; Fitting Position: Rear Axle Right		24.3414-1708.5 240338	Brake System: Lucas / TRW Supplementary Article/Supplementary Info: without holder Brake Caliper Type: Fist-type Caliper
2.0 16V 2.5 dCi	86 08/06→ 84 08/07→	→ Construction year to: 08/14; Fitting Position: Rear Axle Left		24.3414-1707.5 240337	Brake System: Lucas / TRW Supplementary Article/Supplementary Info: without holder Brake Caliper Type: Fist-type Caliper
		→ Construction year to: 08/14; Fitting Position: Rear Axle Right		24.3414-1708.5 240338	Brake System: Lucas / TRW Supplementary Article/Supplementary Info: without holder Brake Caliper Type: Fist-type Caliper
2.0 dCi 115 2.0 dCi 90 2.5 dCi 145	84 08/06→ 66 08/06→ 107 08/06→	Construction year from: 10/06 → → Construction year to: 08/14; Fitting Position: Rear Axle Left		24.3414-1707.5 240337	Brake System: Lucas / TRW Supplementary Article/Supplementary Info: without holder Brake Caliper Type: Fist-type Caliper
		Construction year from: 10/06 → → Construction year to: 08/14; Fitting Position: Rear Axle Right		24.3414-1708.5 240338	Brake System: Lucas / TRW Supplementary Article/Supplementary Info: without holder Brake Caliper Type: Fist-type Caliper
2.5 dCi 135	99 05/03→10/06	Fitting Position: Rear Axle Left		24.3414-1707.5 240337	Brake System: Lucas / TRW Supplementary Article/Supplementary Info: without holder Brake Caliper Type: Fist-type Caliper
		Fitting Position: Rear Axle Right		24.3414-1708.5 240338	Brake System: Lucas / TRW Supplementary Article/Supplementary Info: without holder Brake Caliper Type: Fist-type Caliper
 Brake Pad Set, disc brake					
1.9 dCi 1.9 dCi 100 1.9 dCi 80 2.5 dCi 135	59 04/01→07/03 74 03/01→10/06 60 03/01→10/06 99 05/03→10/06	Fitting Position: Rear Axle		13.0460-2840.2 602840	Brake System: Lucas / TRW 23980 16,5 Wear Warning Contact: prepared for wear indicator / excl. wear warning contact
1.9 dCi 2.0 2.0 16V 2.5 dCi	75 03/01→ 88 03/01→ 86 08/06→ 84 08/07→	→ Construction year to: 08/14; Fitting Position: Rear Axle		13.0460-2840.2 602840	Brake System: Lucas / TRW 23980 16,5 Wear Warning Contact: prepared for wear indicator / excl. wear warning contact
2.0 dCi 115 2.0 dCi 90 2.5 dCi 145	84 08/06→ 66 08/06→ 107 08/06→	Construction year from: 10/06 → → Construction year to: 08/14; Fitting Position: Rear Axle		13.0460-2840.2 602840	Brake System: Lucas / TRW 23980 16,5 Wear Warning Contact: prepared for wear indicator / excl. wear warning contact
 Brake Hose					
1.9 dCi 1.9 dCi 100 1.9 dCi 80 2.5 dCi 135	59 04/01→07/03 74 03/01→10/06 60 03/01→10/06 99 05/03→10/06	Required quantity: 2; Fitting Position: Centre		2 24.5229-0200.3 330572	Length [mm]: 200
1.9 dCi 2.0 2.0 16V 2.5 dCi	75 03/01→ 88 03/01→ 86 08/06→ 84 08/07→	→ Construction year to: 08/14; Required quantity: 2; Fitting Position: Centre		2 24.5229-0200.3 330572	Length [mm]: 200
2.0 dCi 115 2.0 dCi 90 2.5 dCi 145	84 08/06→ 66 08/06→ 107 08/06→	Construction year from: 10/06 → → Construction year to: 08/14; Required quantity: 2; Fitting Position: Centre		2 24.5229-0200.3 330572	Length [mm]: 200
 Wheel Speed Sensor					
1.9 dCi 1.9 dCi 100 1.9 dCi 80 →	59 - 03/01→ 75 74 03/01→10/06 60 03/01→10/06	Required quantity: 2; Manufacturer Restriction: BOSCH; Fitting Position: Front Axle		2 24.0710-2097.3 360647	Length [mm]: 720

	kW								
RENAULT - TRAFIC II Van (FL) 03/01→									
 Wheel Speed Sensor									
2.0	88 03/01→	Required quantity: 2; Manufacturer Restriction: BOSCH; Fitting Position: Rear Axle	2	24.0710-2100.3 360649	Length [mm]: 956				
2.0 16V	86 08/06→								
2.0 dCi 115	84 08/06→								
2.0 dCi 90	66 08/06→								
2.5 dCi	84 08/07→								
2.5 dCi 135	99 05/03→10/06								
2.5 dCi 145	107 08/06→								
RENAULT - TRAFIC III Bus (JG_) 05/14→									
 Brake Caliper									
1.6 dCi 115	85 05/14→	Fitting Position: Rear Axle Left		24.3414-1707.5 240337	Brake System: Lucas / TRW Supplementary Article/Supplementary Info: without holder Brake Caliper Type: Fist-type Caliper				
1.6 dCi 120	88 - 05/14→ 89								
1.6 dCi 125	92 07/15→								
1.6 dCi 140	103 05/14→								
1.6 dCi 145	107 07/15→								
1.6 dCi 90	66 05/14→	Fitting Position: Rear Axle Right		24.3414-1708.5 240338	Brake System: Lucas / TRW Supplementary Article/Supplementary Info: without holder Brake Caliper Type: Fist-type Caliper				
1.6 dCi 95	70 07/15→								
2.0 dCi 110	81 05/21→								
2.0 dCi 120	88 06/19→								
2.0 dCi 145	107 06/19→								
2.0 dCi 150	110 05/21→								
2.0 dCi 170	125 06/19→								
 Brake Pad Set, disc brake									
1.6 dCi 115	85 05/14→	Fitting Position: Rear Axle		13.0460-2840.2 602840	Brake System: Lucas / TRW 23980 16,5 Wear Warning Contact: prepared for wear indicator / excl. wear warning contact				
1.6 dCi 120	88 - 05/14→ 89								
1.6 dCi 125	92 07/15→								
1.6 dCi 140	103 05/14→								
1.6 dCi 145	107 07/15→								
1.6 dCi 90	66 05/14→								
1.6 dCi 95	70 07/15→								
2.0 dCi 110	81 05/21→								
2.0 dCi 120	88 06/19→								
2.0 dCi 145	107 06/19→								
2.0 dCi 150	110 05/21→								
2.0 dCi 170	125 06/19→								
 Brake Disc									
1.6 dCi 115	85 05/14→					Fitting Position: Front Axle		24.0128-0287.1 428287	Outer diameter [mm]: 296 Brake Disc Thickness [mm] 28 Minimum thickness [mm] 23.4 Brake Disc Type: Vented Supplementary Article/Info 2: with bolts/screws
1.6 dCi 120	88 - 05/14→ 89								
1.6 dCi 125	92 07/15→								
1.6 dCi 140	103 05/14→								
1.6 dCi 145	107 07/15→								
1.6 dCi 90	66 05/14→								
1.6 dCi 95	70 07/15→								
2.0 dCi 110	81 05/21→								
2.0 dCi 120	88 06/19→								
2.0 dCi 145	107 06/19→								
2.0 dCi 150	110 05/21→								
2.0 dCi 170	125 06/19→								
 Brake Hose									
1.6 dCi 115	85 05/14→	Required quantity: 2; Fitting Position: Rear Axle	2	24.5229-0200.3 330572	Length [mm]: 200				
1.6 dCi 120	88 05/14→								
1.6 dCi 125	92 07/15→								
1.6 dCi 140	103 05/14→								
1.6 dCi 145	107 07/15→								
1.6 dCi 90	66 05/14→								
1.6 dCi 95	70 07/15→								
1.6 dCi 120	89 01/19→	Required quantity: 2; Fitting Position: Rear Axle / inner	2	24.5229-0200.3 330572	Length [mm]: 200				
2.0 dCi 110	81 05/21→								
2.0 dCi 120	88 06/19→								
2.0 dCi 145	107 06/19→								
2.0 dCi 150	110 05/21→								
2.0 dCi 170	125 06/19→								
RENAULT - TRAFIC III Platform/Chassis (EG_) 05/14→									
 Brake Caliper									
1.6 dCi 120	88 06/14→	Fitting Position: Rear Axle Left		24.3414-1707.5 240337	Brake System: Lucas / TRW Supplementary Article/Supplementary Info: without holder Brake Caliper Type: Fist-type Caliper				
1.6 dCi 125	92 07/15→								
1.6 dCi 140	103 06/14→								
1.6 dCi 145	107 07/15→								
2.0 dCi 145	107 06/19→								
2.0 dCi 170	125 06/19→								
→									

	kW						
RENAULT - TRAFIC III Platform/Chassis (EG_) 05/14→							
 Brake Caliper							
1.6 dCi 120	88 06/14→		Fitting Position: Rear Axle Right	24.3414-1708.5 240338	Brake System: Lucas / TRW Supplementary Article/Supplementary Info: without holder Brake Caliper Type: Fist-type Caliper		
1.6 dCi 125	92 07/15→						
1.6 dCi 140	103 06/14→						
1.6 dCi 145	107 07/15→						
2.0 dCi 145	107 06/19→						
2.0 dCi 170	125 06/19→						
 Brake Pad Set, disc brake							
1.6 dCi 120	88 06/14→		Fitting Position: Rear Axle	13.0460-2840.2 602840	Brake System: Lucas / TRW 23980 16,5 Wear Warning Contact: prepared for wear indicator / excl. wear warning contact		
1.6 dCi 125	92 07/15→						
1.6 dCi 140	103 06/14→						
1.6 dCi 145	107 07/15→						
2.0 dCi 145	107 06/19→						
2.0 dCi 170	125 06/19→						
 Brake Disc							
1.6 dCi 120	88 06/14→		Fitting Position: Front Axle	24.0128-0287.1 428287	Outer diameter [mm]: 296 Brake Disc Thickness [mm] 28 Minimum thickness [mm] 23.4 Brake Disc Type: Vented Supplementary Article/Info 2: with bolts/screws		
1.6 dCi 125	92 07/15→						
1.6 dCi 140	103 06/14→						
1.6 dCi 145	107 07/15→						
2.0 dCi 145	107 06/19→						
2.0 dCi 170	125 06/19→						
 Brake Hose							
1.6 dCi 120	88 06/14→		Required quantity: 2;	2 24.5229-0200.3 330572	Length [mm]: 200		
1.6 dCi 125	92 07/15→		Fitting Position: Rear Axle				
1.6 dCi 140	103 06/14→						
1.6 dCi 145	107 07/15→						
2.0 dCi 145	107 06/19→		Required quantity: 2;	2 24.5229-0200.3 330572	Length [mm]: 200		
2.0 dCi 170	125 06/19→		Fitting Position: Rear Axle / inner				
RENAULT - TRAFIC III Van (FG_) 05/14→							
 Brake Caliper							
1.6 dCi 115	85 05/14→		Fitting Position: Rear Axle Left	24.3414-1707.5 240337	Brake System: Lucas / TRW Supplementary Article/Supplementary Info: without holder Brake Caliper Type: Fist-type Caliper		
1.6 dCi 120	88 - 05/14→ 89						
1.6 dCi 125	92 07/15→						
1.6 dCi 140	103 05/14→						
1.6 dCi 145	107 07/15→						
1.6 dCi 145	107 07/15→		Fitting Position: Rear Axle Right				
1.6 dCi 90	66 05/14→			24.3414-1708.5 240338	Brake System: Lucas / TRW Supplementary Article/Supplementary Info: without holder Brake Caliper Type: Fist-type Caliper		
1.6 dCi 95	70 07/15→						
2.0 dCi 110	81 08/21→						
2.0 dCi 120	88 06/19→						
2.0 dCi 130	96 08/21→						
2.0 dCi 145	107 06/19→						
2.0 dCi 150	110 08/21→						
2.0 dCi 170	125 06/19→						
 Brake Pad Set, disc brake							
1.6 dCi 115	85 05/14→		Fitting Position: Rear Axle			13.0460-2840.2 602840	Brake System: Lucas / TRW 23980 16,5 Wear Warning Contact: prepared for wear indicator / excl. wear warning contact
1.6 dCi 120	88 - 05/14→ 89						
1.6 dCi 125	92 07/15→						
1.6 dCi 140	103 05/14→						
1.6 dCi 145	107 07/15→						
1.6 dCi 90	66 05/14→						
1.6 dCi 95	70 07/15→						
2.0 dCi 110	81 08/21→						
2.0 dCi 120	88 06/19→						
2.0 dCi 130	96 08/21→						
2.0 dCi 145	107 06/19→						
2.0 dCi 150	110 08/21→						
2.0 dCi 170	125 06/19→						
 Brake Disc							
1.6 dCi 115	85 05/14→		Fitting Position: Front Axle	24.0128-0287.1 428287	Outer diameter [mm]: 296 Brake Disc Thickness [mm] 28 Minimum thickness [mm] 23.4 Brake Disc Type: Vented Supplementary Article/Info 2: with bolts/screws		
1.6 dCi 120	88 - 05/14→ 89						
1.6 dCi 125	92 07/15→						
1.6 dCi 140	103 05/14→						
1.6 dCi 145	107 07/15→						
1.6 dCi 90	66 05/14→						
1.6 dCi 95	70 07/15→						
2.0 dCi 110	81 08/21→						
2.0 dCi 120	88 06/19→						
2.0 dCi 130	96 08/21→						
2.0 dCi 145	107 06/19→						
2.0 dCi 150	110 08/21→						
2.0 dCi 170	125 06/19→						

	kW				
RENAULT - TRAFIC III Van (FG_) 05/14→					
 Brake Hose					
1.6 dCi 115	85 05/14→	Required quantity: 2; Fitting Position: Rear Axle	2	24.5229-0200.3 330572	Length [mm]: 200
1.6 dCi 120	88 05/14→				
1.6 dCi 125	92 07/15→				
1.6 dCi 140	103 05/14→				
1.6 dCi 145	107 07/15→				
1.6 dCi 90	66 05/14→				
1.6 dCi 95	70 07/15→				
1.6 dCi 120	89 07/15→	Required quantity: 2; Fitting Position: Rear Axle / inner	2	24.5229-0200.3 330572	Length [mm]: 200
2.0 dCi 110	81 08/21→				
2.0 dCi 120	88 06/19→				
2.0 dCi 130	96 08/21→				
2.0 dCi 145	107 06/19→				
2.0 dCi 150	110 08/21→				
2.0 dCi 170	125 06/19→				
RENAULT - VEL SATIS (BJO_) 06/02→					
Guide Sleeve Kit, brake caliper					
2.0 16 V Turbo	125 04/04→	→ Construction year to: 12/09; Fitting Position: Front Axle	11.0101-5407.2 260011	260011	Brake System: ATE
2.0 dCi	110 - 08/05→				
	127	→ Construction year to: 12/09; Fitting Position: Rear Axle	11.0101-5407.2 260011	260011	Brake System: ATE
2.0 Turbo	108 04/05→				
2.2 dCi	83 - 04/04→				
	102				
3.5	170 10/04→				
3.5 V6	177 06/02→				
2.0 16V Turbo	120 06/02→08/09	Fitting Position: Front Axle	11.0101-5407.2 260011	260011	Brake System: ATE
2.2 dCi	110 06/02→08/09	Fitting Position: Rear Axle	11.0101-5407.2 260011	260011	Brake System: ATE
3.0 dCi	130 - 06/02→08/09				
	133				
Guide Bolt, brake caliper					
2.0 16 V Turbo	125 04/04→	→ Construction year to: 12/09; Required quantity: 2	2	11.8171-0008.1 990049	Brake System: ATE
2.0 dCi	110 - 08/05→				
	127				
2.0 Turbo	108 04/05→				
2.2 dCi	83 - 04/04→				
	102				
3.5	170 10/04→				
3.5 V6	177 06/02→				
2.0 16V Turbo	120 06/02→08/09	Required quantity: 2	2	11.8171-0008.1 990049	Brake System: ATE
2.2 dCi	110 06/02→08/09				
3.0 dCi	130 - 06/02→08/09				
	133				
RENAULT - ZOE (BFM_) 06/12→					
Spring, brake caliper					
ZOE	65 - 06/12→	Construction year from: 09/19 →; Required quantity: 2; Fitting Position: Front Axle	2	11.8116-0356.1 390586	Brake System: ATE
	80				
ZOE R75	57 12/17→				
ZOE	100 09/19→	Required quantity: 2; Fitting Position: Front Axle	2	11.8116-0356.1 390586	Brake System: ATE
Guide Bolt, brake caliper					
ZOE	65 - 06/12→	Construction year from: 09/19 →; Fitting Position: Front Axle	11.8171-0008.1 990049	990049	Brake System: ATE
	80				
ZOE R75	57 12/17→				
ZOE	100 09/19→	Fitting Position: Front Axle	11.8171-0008.1 990049	990049	Brake System: ATE
 Brake Pad Set, disc brake					
ZOE	65 - 06/12→	Fitting Position: Rear Axle	13.0460-2756.2 602756	602756	Brake System: Lucas / TRW 24820 16,1 Wear Warning Contact: not prepared for wear indicator / excl. wear warning contact Supplementary Article/Supplementary Info: with accessories
	100				
ZOE R75	57 12/17→				
 Brake Disc					
ZOE	65 - 06/12→	→ Construction year to: 08/19; Fitting Position: Front Axle	24.0122-0270.1 422270	422270	Outer diameter [mm]: 258 Brake Disc Thickness [mm] 22 Minimum thickness [mm] 19.8 Brake Disc Type: Vented Supplementary Article/Info 2: with bolts/screws
	80				
ZOE R75	57 12/17→				

	kW				
RENAULT - ZOE Hatchback Van (BFM_) 04/19→					
Spring, brake caliper					
Electric	65 - 04/19→ 80	Construction year from: 09/19 →; Required quantity: 2; Fitting Position: Front Axle	2	11.8116-0356.1 390586	Brake System: ATE
Electric	100 10/19→	Required quantity: 2; Fitting Position: Front Axle	2	11.8116-0356.1 390586	Brake System: ATE
Guide Bolt, brake caliper					
Electric	65 - 04/19→ 80	Construction year from: 09/19 →; Fitting Position: Front Axle		11.8171-0008.1 990049	Brake System: ATE
Electric	100 10/19→	Fitting Position: Front Axle		11.8171-0008.1 990049	Brake System: ATE
 Brake Pad Set, disc brake					
Electric	65 - 04/19→ 100	Fitting Position: Rear Axle		13.0460-2756.2 602756	Brake System: Lucas / TRW 24820 16,1 Wear Warning Contact: not prepared for wear indicator / excl. wear warning contact Supplementary Article/Supple- mentary Info: with accessories
 Brake Disc					
Electric	65 - 04/19→ 80	→ Construction year to: 08/19; Fitting Position: Front Axle		24.0122-0270.1 422270	Outer diameter [mm]: 258 Brake Disc Thickness [mm] 22 Minimum thickness [mm] 19.8 Brake Disc Type: Vented Supplementary Article/Info 2: with bolts/screws
RENAULT TRUCKS - MASCOTT Platform/Chassis 01/99→12/13					
 Brake Pad Set, disc brake					
110 120.65 130 140 150.35 160.65	78 01/99→06/04 85 05/04→12/10 92 01/99→06/04 103 01/01→06/04 107 10/01→06/04 115 05/04→12/10	Fitting Position: Rear Axle		13.0460-4966.2 604966	Brake System: Brembo 29121 20,3 Wear Warning Contact: prepared for wear indicator / excl. wear warning contact
120.35 120.55 160.35 160.55	85 05/04→12/10 85 05/04→12/10 115 05/04→12/10 115 05/04→12/10	Fitting Position: Front Axle		13.0460-4966.2 604966	Brake System: Brembo 29121 20,3 Wear Warning Contact: prepared for wear indicator / excl. wear warning contact
		Fitting Position: Rear Axle		13.0460-4966.2 604966	Brake System: Brembo 29121 20,3 Wear Warning Contact: prepared for wear indicator / excl. wear warning contact
90	63 01/99→12/01	→ Construction year to: 06/01; Fitting Position: Rear Axle		13.0460-4966.2 604966	Brake System: Brembo 29121 20,3 Wear Warning Contact: prepared for wear indicator / excl. wear warning contact
RENAULT TRUCKS - MASCOTT Van 01/99→12/10					
 Brake Pad Set, disc brake					
110.35 110.50 110.55 130.35 130.55 140.35 140.55 150.35 150.55 150.65	78 01/99→06/04 78 01/99→06/04 78 01/99→06/04 92 01/99→06/04 92 01/99→06/04 103 01/01→06/04 103 01/01→06/04 107 10/01→06/04 107 10/01→06/04 107 10/01→06/04	Fitting Position: Rear Axle		13.0460-4966.2 604966	Brake System: Brembo 29121 20,3 Wear Warning Contact: prepared for wear indicator / excl. wear warning contact
120.35 120.55 160.35 160.55	85 05/04→10/10 85 05/04→10/10 115 05/04→10/10 115 05/04→10/10	Fitting Position: Front Axle		13.0460-4966.2 604966	Brake System: Brembo 29121 20,3 Wear Warning Contact: prepared for wear indicator / excl. wear warning contact
		Fitting Position: Rear Axle		13.0460-4966.2 604966	Brake System: Brembo 29121 20,3 Wear Warning Contact: prepared for wear indicator / excl. wear warning contact
→					

	kW				
SAAB - 9-3 (YS3D) 02/98→08/03					
Guide Bolt, brake caliper					
2.0 i	96 02/98→09/02	→ Vehicle Identification Number to: X2020000; Required quantity: 2	2	11.8171-0008.1 990049	Brake System: ATE
2.0 SE Turbo	147 02/98→09/02	Vehicle Identification Number from: X2020001 →; Required quantity: 2	2	11.8171-0008.1 990049	Brake System: ATE
2.0 Turbo	113 - 02/98→09/02				
2.2 TiD	136 85 02/98→11/00				
2.3 i	110 02/98→09/02				
2.0 Turbo	110 03/99→09/02	Required quantity: 2	2	11.8171-0008.1 990049	Brake System: ATE
		Vehicle Identification Number from: X2020001 →; Required quantity: 2	2	11.8171-0008.1 990049	Brake System: ATE
		Vehicle Identification Number from: X7020001 →; Required quantity: 2	2	11.8171-0008.1 990049	Brake System: ATE
2.0 Turbo	151 10/99→09/02	Required quantity: 2	2	11.8171-0008.1 990049	Brake System: ATE
2.2 TiD	92 11/00→09/02				
2.3	169 09/99→01/02				
2.3 Turbo	165 10/98→09/02				
SAAB - 9-3 (YS3F, E79, D79, D75) 09/02→02/15					
Spring, brake caliper					
1	110 09/02→02/15	Vehicle Identification Number from: 51046734 →;	2	11.8116-0356.1 390586	Brake System: ATE
8t	110 09/02→02/15	→ Construction year to: 12/05;			
1.9 TiD	88 - 09/04→02/15	Required quantity: 2;			
	110	Fitting Position: Front Axle			
2.0 t	129 09/02→02/15	→ Construction year to: 06/12;	2	11.8116-0356.1 390586	Brake System: ATE
2.0 t BioPower	154 09/02→02/15	Rim Size [in]: 15; Required quantity: 2;			
2.2 TiD	92 09/02→02/15	Brake Caliper Type: Cast iron brake caliper; Fitting Position: Front Axle			
1	110 01/07→02/15	→ Construction year to: 06/12;	2	11.8116-0356.1 390586	Brake System: ATE
8t BioPower	110 01/07→02/15	Rim Size [in]: 15; Required quantity: 2;			
1.9 TTiD	96 - 12/07→02/15	Brake Caliper Type: Cast iron brake caliper; Fitting Position: Front Axle			
	132				
2.0 t	120 - 01/07→02/15				
	177				
2.0 t BioPower	147 05/09→02/15				
2.0 t Bio Power	162 01/11→02/15				
2.0 Turbo Performance	185 04/04→02/15				
1	129 05/09→02/15	→ Construction year to: 06/12;	2	11.8116-0356.1 390586	Brake System: ATE
8t BioPower	129 05/09→02/15	Rim Size [in]: 15; Required quantity: 2;			
		Fitting Position: Front Axle			
1.8 i	90 01/04→02/15	Vehicle Identification Number from: 51046734 →;	2	11.8116-0356.1 390586	Brake System: ATE
		→ Construction year to: 12/05;			
		Required quantity: 2;			
		Fitting Position: Front Axle			
		Construction year from: 03/04 → →	2	11.8116-0356.1 390586	Brake System: ATE
		Construction year to: 06/12;			
		Rim Size [in]: 15; Required quantity: 2;			
		Brake Caliper Type: Cast iron brake caliper; Fitting Position: Front Axle			
2.0 t	154 09/02→02/15	Vehicle Identification Number from: 51046734 →;	2	11.8116-0356.1 390586	Brake System: ATE
		→ Construction year to: 12/05;			
		Required quantity: 2;			
		Fitting Position: Front Axle			
2.8 Turbo V6	184 03/05→02/15	→ Construction year to: 12/05;	2	11.8116-0356.1 390586	Brake System: ATE
		Required quantity: 2;			
		Fitting Position: Front Axle			
Guide Sleeve Kit, brake caliper					
1	110 09/02→02/15	Vehicle Identification Number from: 51046734 →;		11.0101-5407.2 260011	Brake System: ATE
8t	110 09/02→02/15	→ Construction year to: 12/05;			
2.2 TiD	92 09/02→02/15	Fitting Position: Front Axle			
		→ Construction year to: 06/12;		11.0101-5407.2 260011	Brake System: ATE
		Rim Size [in]: 15;			
		Fitting Position: Front Axle			
		→ Construction year to: 06/12;		11.0101-5407.2 260011	Brake System: ATE
		Fitting Position: Front Axle			
		Construction year from: 01/06 → →		11.0101-5407.2 260011	Brake System: ATE
		Construction year to: 06/12;			
		Fitting Position: Front Axle			
		→ Vehicle Identification Number to: 51049406; Fitting Position: Rear Axle		11.0101-5407.2 260011	Brake System: ATE
		Vehicle Identification Number from: 51049407 →;		11.0101-5407.2 260011	Brake System: ATE
		→ Construction year to: 06/12;			
		Fitting Position: Rear Axle			
→					

	kW				
SAAB - 9-3 (YS3F, E79, D79, D75) 09/02→02/15					
Guide Sleeve Kit, brake caliper					
1 8t 2.2 TiD	110 09/02→02/15 110 09/02→02/15 92 09/02→02/15	→ Construction year to: 06/12; Fitting Position: Rear Axle		11.0101-5407.2 260011	Brake System: ATE
1 8t BioPower 2.0 t 2.0 t Bio Power	110 01/07→02/15 110 01/07→02/15 120 - 01/07→02/15 162 162 01/11→02/15	→ Construction year to: 06/12; Rim Size [in]: 15; Fitting Position: Front Axle		11.0101-5407.2 260011	Brake System: ATE
		→ Construction year to: 06/12; Fitting Position: Front Axle		11.0101-5407.2 260011	Brake System: ATE
		→ Vehicle Identification Number to: 51049406; Fitting Position: Rear Axle		11.0101-5407.2 260011	Brake System: ATE
		Vehicle Identification Number from: 51049407 →; → Construction year to: 06/12; Fitting Position: Rear Axle		11.0101-5407.2 260011	Brake System: ATE
		→ Construction year to: 06/12; Fitting Position: Rear Axle		11.0101-5407.2 260011	Brake System: ATE
1 8t BioPower	129 05/09→02/15 129 05/09→02/15	→ Construction year to: 06/12; Rim Size [in]: 15; Fitting Position: Front Axle		11.0101-5407.2 260011	Brake System: ATE
		→ Construction year to: 06/12; Fitting Position: Front Axle		11.0101-5407.2 260011	Brake System: ATE
1.8 i	90 01/04→02/15	Construction year from: 03/04 → → Construction year to: 06/12; Rim Size [in]: 15; Fitting Position: Front Axle		11.0101-5407.2 260011	Brake System: ATE
		Vehicle Identification Number from: 51046734 →; → Construction year to: 12/05; Fitting Position: Front Axle		11.0101-5407.2 260011	Brake System: ATE
		Construction year from: 01/06 → → Construction year to: 06/12; Fitting Position: Front Axle		11.0101-5407.2 260011	Brake System: ATE
		Construction year from: 03/04 → → Construction year to: 06/12; Fitting Position: Front Axle		11.0101-5407.2 260011	Brake System: ATE
		Construction year from: 03/04 → → Construction year to: 06/12; Fitting Position: Rear Axle		11.0101-5407.2 260011	Brake System: ATE
1.9 TiD	88 - 09/04→02/15 110	→ Construction year to: 06/12; Rim Size [in]: 15; Fitting Position: Front Axle		11.0101-5407.2 260011	Brake System: ATE
		Vehicle Identification Number from: 51046734 →; → Construction year to: 12/05; Fitting Position: Front Axle		11.0101-5407.2 260011	Brake System: ATE
		Construction year from: 01/06 → → Construction year to: 06/12; Fitting Position: Front Axle		11.0101-5407.2 260011	Brake System: ATE
		→ Construction year to: 06/12; Fitting Position: Front Axle		11.0101-5407.2 260011	Brake System: ATE
		→ Construction year to: 06/12; Fitting Position: Rear Axle		11.0101-5407.2 260011	Brake System: ATE
1.9 TTiD	96 - 12/07→02/15 132	→ Construction year to: 06/12; Rim Size [in]: 15; Fitting Position: Front Axle		11.0101-5407.2 260011	Brake System: ATE
		→ Construction year to: 06/12; Fitting Position: Front Axle		11.0101-5407.2 260011	Brake System: ATE
		→ Construction year to: 06/12; Fitting Position: Rear Axle		11.0101-5407.2 260011	Brake System: ATE
2.0 t 2.0 t BioPower	129 09/02→02/15 154 09/02→02/15	Vehicle Identification Number from: 51046734 →; → Construction year to: 12/05; Fitting Position: Front Axle		11.0101-5407.2 260011	Brake System: ATE
		→ Construction year to: 06/12; Fitting Position: Front Axle		11.0101-5407.2 260011	Brake System: ATE
		→ Construction year to: 06/12; Rim Size [in]: 15; Fitting Position: Front Axle		11.0101-5407.2 260011	Brake System: ATE
		Construction year from: 01/06 → → Construction year to: 06/12; Fitting Position: Front Axle		11.0101-5407.2 260011	Brake System: ATE
		→ Vehicle Identification Number to: 51049406; Fitting Position: Rear Axle		11.0101-5407.2 260011	Brake System: ATE
		Construction year from: 09/03 →; → Vehicle Identification Number to: 51049406; Fitting Position: Rear Axle		11.0101-5407.2 260011	Brake System: ATE
		Vehicle Identification Number from: 51049407 →;		11.0101-5407.2 260011	Brake System: ATE

→

	kW				
SAAB - 9-3 (YS3F, E79, D79, D75) 09/02→02/15					
Guide Sleeve Kit, brake caliper					
2.0 t	129	09/02→02/15	→ Construction year to: 06/12;		
2.0 t BioPower	154	09/02→02/15	Fitting Position: Rear Axle		
			→ Construction year to: 06/12;	11.0101-5407.2	260011 Brake System: ATE
			Fitting Position: Rear Axle		
2.0 t	154	09/02→02/15	→ Vehicle Identification Number to: 41039807; Fitting Position: Front Axle	11.0101-5407.2	260011 Brake System: ATE
			Vehicle Identification Number from: 51046734 →;	11.0101-5407.2	260011 Brake System: ATE
			→ Construction year to: 12/05;		
			Fitting Position: Front Axle		
			Construction year from: 01/06 → → Construction year to: 06/12;	11.0101-5407.2	260011 Brake System: ATE
			Fitting Position: Front Axle		
			Vehicle Identification Number from: 41039808 → → Vehicle Identification Number to: 51046733;	11.0101-5407.2	260011 Brake System: ATE
			Fitting Position: Front Axle		
			Vehicle Identification Number from: 41022028 → → Vehicle Identification Number to: 51046733;	11.0101-5407.2	260011 Brake System: ATE
			Fitting Position: Front Axle		
			→ Vehicle Identification Number to: 51049406; Fitting Position: Rear Axle	11.0101-5407.2	260011 Brake System: ATE
			Vehicle Identification Number from: 51049407 →;	11.0101-5407.2	260011 Brake System: ATE
			→ Construction year to: 06/12;		
			Fitting Position: Rear Axle		
			→ Construction year to: 06/12;	11.0101-5407.2	260011 Brake System: ATE
			Fitting Position: Rear Axle		
2.0 t	177	05/09→02/15	→ Vehicle Identification Number to: 51046733; Fitting Position: Front Axle	11.0101-5407.2	260011 Brake System: ATE
2.0 t BioPower	147	05/09→02/15			
2.0 Turbo Performance	185	04/04→02/15	→ Construction year to: 06/12;	11.0101-5407.2	260011 Brake System: ATE
			Fitting Position: Front Axle		
			→ Construction year to: 06/12;	11.0101-5407.2	260011 Brake System: ATE
			Rim Size [in]: 15;		
			Fitting Position: Front Axle		
			→ Vehicle Identification Number to: 51049406; Fitting Position: Rear Axle	11.0101-5407.2	260011 Brake System: ATE
			Vehicle Identification Number from: 51049407 →;	11.0101-5407.2	260011 Brake System: ATE
			→ Construction year to: 06/12;		
			Fitting Position: Rear Axle		
			→ Construction year to: 06/12;	11.0101-5407.2	260011 Brake System: ATE
			Fitting Position: Rear Axle		
2.0 T16	143	06/06→02/15	Fitting Position: Rear Axle	11.0101-5407.2	260011 Brake System: ATE
2.0 t BioPower	129 - 145	01/07→02/15	→ Construction year to: 06/12;	11.0101-5407.2	260011 Brake System: ATE
			Fitting Position: Front Axle		
2.0 t Bio Power	120	01/07→02/15	→ Vehicle Identification Number to: 51049406; Fitting Position: Rear Axle	11.0101-5407.2	260011 Brake System: ATE
			Vehicle Identification Number from: 51049407 →;	11.0101-5407.2	260011 Brake System: ATE
			→ Construction year to: 06/12;		
			Fitting Position: Rear Axle		
			→ Construction year to: 06/12;	11.0101-5407.2	260011 Brake System: ATE
			Fitting Position: Rear Axle		
2.0 t BioPower XWD	120 - 162	01/08→02/15	→ Construction year to: 06/12;	11.0101-5407.2	260011 Brake System: ATE
			Fitting Position: Front Axle		
2.0 t XWD	120 - 177	01/07→02/15	Vehicle Identification Number from: 51049407 →;	11.0101-5407.2	260011 Brake System: ATE
			→ Construction year to: 06/12;		
			Fitting Position: Rear Axle		
			→ Vehicle Identification Number to: 51049406; Fitting Position: Rear Axle	11.0101-5407.2	260011 Brake System: ATE
2.0 Turbo XWD	154	01/08→02/15	→ Vehicle Identification Number to: 41039807; Fitting Position: Front Axle	11.0101-5407.2	260011 Brake System: ATE
			Vehicle Identification Number from: 41022028 → → Vehicle Identification Number to: 51046733;	11.0101-5407.2	260011 Brake System: ATE
			Fitting Position: Front Axle		
			→ Construction year to: 06/12;	11.0101-5407.2	260011 Brake System: ATE
			Fitting Position: Front Axle		
			Vehicle Identification Number from: 41039808 → → Vehicle Identification Number to: 51046733;	11.0101-5407.2	260011 Brake System: ATE
			Fitting Position: Front Axle		
			→ Vehicle Identification Number to: 51049406; Fitting Position: Rear Axle	11.0101-5407.2	260011 Brake System: ATE

→

	kW				
SAAB - 9-3 (YS3F, E79, D79, D75) 09/02→02/15					
Guide Sleeve Kit, brake caliper					
2.0 Turbo XWD	154	01/08→02/15	Vehicle Identification Number from: 51049407 →;	11.0101-5407.2	260011 Brake System: ATE
			→ Construction year to: 06/12; Fitting Position: Rear Axle		
			→ Construction year to: 06/12; Fitting Position: Rear Axle	11.0101-5407.2	260011 Brake System: ATE
2.8 Turbo V6	169 - 188	03/05→02/15	Construction year from: 04/08 → →	11.0101-5407.2	260011 Brake System: ATE
			Construction year to: 06/12; Fitting Position: Front Axle		
			Construction year from: 04/08 → →	11.0101-5407.2	260011 Brake System: ATE
			Construction year to: 06/12; Fitting Position: Rear Axle	11.0101-5407.2	260011 Brake System: ATE
2.8 Turbo V6	184	03/05→02/15	Construction year from: 01/06 → →	11.0101-5407.2	260011 Brake System: ATE
			Construction year to: 06/12; Fitting Position: Front Axle		
			→ Construction year to: 12/05; Fitting Position: Front Axle		
			→ Construction year to: 06/12; Fitting Position: Front Axle		
			→ Construction year to: 06/12; Fitting Position: Rear Axle	11.0101-5407.2	260011 Brake System: ATE
2.8 Turbo V6	203 - 206	04/08→02/15	→ Construction year to: 06/12; Fitting Position: Front Axle	11.0101-5407.2	260011 Brake System: ATE
			→ Construction year to: 06/12; Fitting Position: Rear Axle		
2.8 Turbo V6 XWD	206	05/08→12/11	Fitting Position: Front Axle	11.0101-5407.2	260011 Brake System: ATE
			Fitting Position: Rear Axle		
Guide Bolt, brake caliper					
1 8t 2.2 TiD	110	09/02→02/15	→ Construction year to: 06/12; Required quantity: 2	2	11.8171-0008.1 990049 Brake System: ATE
			→ Construction year to: 06/12; Rim Size [in]: 15; Required quantity: 2		
			Construction year from: 01/06 → →		
			Construction year to: 06/12; Required quantity: 2		
			→ Vehicle Identification Number to: 51049406; Required quantity: 2		
			Vehicle Identification Number from: 51049407 →;		
			→ Construction year to: 06/12; Required quantity: 2	2	11.8171-0008.1 990049 Brake System: ATE
			Vehicle Identification Number from: 51046734 →;	2	11.8171-0008.1 990049 Brake System: ATE
			→ Construction year to: 12/05; Required quantity: 2	2	11.8171-0008.1 990049 Brake System: ATE
1 8t BioPower 2.0 t 2.0 t Bio Power	110 - 162	01/07→02/15	→ Construction year to: 06/12; Required quantity: 2	2	11.8171-0008.1 990049 Brake System: ATE
			→ Construction year to: 06/12; Rim Size [in]: 15; Required quantity: 2		
			→ Vehicle Identification Number to: 51049406; Required quantity: 2		
			Vehicle Identification Number from: 51049407 →;		
			→ Construction year to: 06/12; Required quantity: 2	2	11.8171-0008.1 990049 Brake System: ATE
1 8t BioPower 1.9 TTiD	129 - 132	05/09→02/15	→ Construction year to: 06/12; Rim Size [in]: 15; Required quantity: 2	2	11.8171-0008.1 990049 Brake System: ATE
			→ Construction year to: 06/12; Required quantity: 2		
			→ Construction year to: 06/12; Required quantity: 2		
1.8 i	90	01/04→02/15	Construction year from: 01/06 → →	2	11.8171-0008.1 990049 Brake System: ATE
			Construction year to: 06/12; Required quantity: 2		
			Construction year from: 03/04 → →		
			Construction year to: 06/12; Rim Size [in]: 15; Required quantity: 2		
			Vehicle Identification Number from: 51046734 →;	2	11.8171-0008.1 990049 Brake System: ATE
			→ Construction year to: 12/05; Required quantity: 2	2	11.8171-0008.1 990049 Brake System: ATE
			Construction year from: 03/04 → →	2	11.8171-0008.1 990049 Brake System: ATE
			Construction year to: 06/12; Required quantity: 2	2	11.8171-0008.1 990049 Brake System: ATE
1.9 TiD →	88 - 110	09/04→02/15	→ Construction year to: 06/12; Rim Size [in]: 15; Required quantity: 2	2	11.8171-0008.1 990049 Brake System: ATE

	kW				
SAAB - 9-3 (YS3F, E79, D79, D75) 09/02→02/15					
Guide Bolt, brake caliper					
1.9 TiD	88 - 09/04→02/15 110	Construction year from: 01/06 → → Construction year to: 06/12; Required quantity: 2	2	11.8171-0008.1	990049 Brake System: ATE
		Vehicle Identification Number from: 51046734 →; → Construction year to: 12/05; Required quantity: 2	2	11.8171-0008.1	990049 Brake System: ATE
		→ Construction year to: 06/12; Required quantity: 2	2	11.8171-0008.1	990049 Brake System: ATE
2.0 t 2.0 t BioPower	129 09/02→02/15 154 09/02→02/15	→ Construction year to: 06/12; Required quantity: 2	2	11.8171-0008.1	990049 Brake System: ATE
		→ Construction year to: 06/12; Rim Size [in]: 15; Required quantity: 2	2	11.8171-0008.1	990049 Brake System: ATE
		Construction year from: 01/06 → → Construction year to: 06/12; Required quantity: 2	2	11.8171-0008.1	990049 Brake System: ATE
		Construction year from: 09/03 →; → Vehicle Identification Number to: 51049406; Required quantity: 2	2	11.8171-0008.1	990049 Brake System: ATE
		→ Vehicle Identification Number to: 51049406; Required quantity: 2	2	11.8171-0008.1	990049 Brake System: ATE
		Vehicle Identification Number from: 51046734 →; → Construction year to: 12/05; Required quantity: 2	2	11.8171-0008.1	990049 Brake System: ATE
		Vehicle Identification Number from: 51049407 →; → Construction year to: 06/12; Required quantity: 2	2	11.8171-0008.1	990049 Brake System: ATE
2.0 t	154 09/02→02/15	Vehicle Identification Number from: 51046734 →; → Construction year to: 12/05; Required quantity: 2	2	11.8171-0008.1	990049 Brake System: ATE
		Vehicle Identification Number from: 51049407 →; → Construction year to: 06/12; Required quantity: 2	2	11.8171-0008.1	990049 Brake System: ATE
		Construction year from: 01/06 → → Construction year to: 06/12; Required quantity: 2	2	11.8171-0008.1	990049 Brake System: ATE
		→ Construction year to: 06/12; Required quantity: 2	2	11.8171-0008.1	990049 Brake System: ATE
		Vehicle Identification Number from: 41022028 → → Vehicle Identification Number to: 51046733; Required quantity: 2	2	11.8171-0008.1	990049 Brake System: ATE
		Vehicle Identification Number from: 41039808 → → Vehicle Identification Number to: 51046733; Required quantity: 2	2	11.8171-0008.1	990049 Brake System: ATE
		→ Vehicle Identification Number to: 41039807; Required quantity: 2	2	11.8171-0008.1	990049 Brake System: ATE
2.0 t 2.0 t BioPower 2.0 Turbo Performance	177 05/09→02/15 147 05/09→02/15 185 04/04→02/15	→ Construction year to: 06/12; Required quantity: 2	2	11.8171-0008.1	990049 Brake System: ATE
		→ Construction year to: 06/12; Rim Size [in]: 15; Required quantity: 2	2	11.8171-0008.1	990049 Brake System: ATE
		Vehicle Identification Number from: 51049407 →; → Construction year to: 06/12; Required quantity: 2	2	11.8171-0008.1	990049 Brake System: ATE
		→ Vehicle Identification Number to: 51046733; Required quantity: 2	2	11.8171-0008.1	990049 Brake System: ATE
		→ Vehicle Identification Number to: 51049406; Required quantity: 2	2	11.8171-0008.1	990049 Brake System: ATE
		→ Vehicle Identification Number to: 51049406; Required quantity: 2	2	11.8171-0008.1	990049 Brake System: ATE
2.0 T16	143 06/06→02/15	→ Vehicle Identification Number to: 51049406; Required quantity: 2	2	11.8171-0008.1	990049 Brake System: ATE
2.0 t BioPower	129 - 01/07→02/15 145	→ Construction year to: 06/12; Required quantity: 2	2	11.8171-0008.1	990049 Brake System: ATE
2.0 t Bio Power	120 01/07→02/15	Vehicle Identification Number from: 51049407 →; → Construction year to: 06/12; Required quantity: 2	2	11.8171-0008.1	990049 Brake System: ATE
2.0 t BioPower XWD	120 - 01/08→02/15 162				
2.0 t XWD	120 - 01/07→02/15 177	→ Vehicle Identification Number to: 51049406; Required quantity: 2	2	11.8171-0008.1	990049 Brake System: ATE
2.0 Turbo XWD	154 01/08→02/15	→ Vehicle Identification Number to: 41039807; Required quantity: 2	2	11.8171-0008.1	990049 Brake System: ATE

→

SAAB - 9-3 (YS3F, E79, D79, D75) 09/02→02/15						
Guide Bolt, brake caliper						
2.0 Turbo XWD	154	01/08→02/15	Vehicle Identification Number from: 51049407 →;	2	11.8171-0008.1 990049	Brake System: ATE
			→ Construction year to: 06/12;	2	11.8171-0008.1 990049	Brake System: ATE
			Required quantity: 2			
			→ Construction year to: 06/12;	2	11.8171-0008.1 990049	Brake System: ATE
			Required quantity: 2			
			Vehicle Identification Number from: 41022028 → → Vehicle Identification Number to: 51046733;	2	11.8171-0008.1 990049	Brake System: ATE
			Required quantity: 2			
			Vehicle Identification Number from: 41039808 → → Vehicle Identification Number to: 51046733;	2	11.8171-0008.1 990049	Brake System: ATE
			Required quantity: 2			
			→ Vehicle Identification Number to: 51049406; Required quantity: 2	2	11.8171-0008.1 990049	Brake System: ATE
2.8 Turbo V6	169 - 188	03/05→02/15	Construction year from: 04/08 → → Construction year to: 06/12;	2	11.8171-0008.1 990049	Brake System: ATE
			Required quantity: 2			
2.8 Turbo V6	184	03/05→02/15	Construction year from: 01/06 → → Construction year to: 06/12;	2	11.8171-0008.1 990049	Brake System: ATE
			Required quantity: 2			
			→ Construction year to: 06/12;	2	11.8171-0008.1 990049	Brake System: ATE
			Required quantity: 2			
			→ Construction year to: 12/05;	2	11.8171-0008.1 990049	Brake System: ATE
			Required quantity: 2			
2.8 Turbo V6	203 - 206	04/08→02/15	→ Construction year to: 06/12;	2	11.8171-0008.1 990049	Brake System: ATE
			Required quantity: 2			
2.8 Turbo V6 XWD	206	05/08→12/11	Required quantity: 2	2	11.8171-0008.1 990049	Brake System: ATE
SAAB - 9-3 Cabriolet (YS3D) 02/98→08/03						
Guide Sleeve Kit, brake caliper						
2.0 i	96	02/98→08/03	→ Vehicle Identification Number to: X7020000; Fitting Position: Front Axle		11.0101-5407.2 260011	Brake System: ATE
2.0 SE Turbo	147	02/98→08/03				
2.0 Turbo	113 - 136	02/98→08/03	→ Construction year to: 07/03;		11.0101-5407.2 260011	Brake System: ATE
			Vehicle Identification Number from: X7020001 →; Fitting Position: Front Axle			
2.3 i	110	02/98→08/03			11.0101-5407.2 260011	Brake System: ATE
			→ Construction year to: 07/03;			
			Vehicle Identification Number from: X2020001 →; Fitting Position: Front Axle		11.0101-5407.2 260011	Brake System: ATE
			→ Construction year to: 12/98;		11.0101-5407.2 260011	Brake System: ATE
			Fitting Position: Front Axle			
			Construction year from: 01/99 → → Construction year to: 07/03;		11.0101-5407.2 260011	Brake System: ATE
			Fitting Position: Front Axle			
			→ Vehicle Identification Number to: X2020000; Fitting Position: Front Axle		11.0101-5407.2 260011	Brake System: ATE
2.0 Turbo	110 - 151	10/99→08/03				
			→ Construction year to: 07/03;		11.0101-5407.2 260011	Brake System: ATE
			Fitting Position: Front Axle			
2.3 Turbo	165	10/99→08/03				
2.3	169	09/99→01/02	Construction year from: 10/99 →;		11.0101-5407.2 260011	Brake System: ATE
			Fitting Position: Front Axle			
Guide Bolt, brake caliper						
2.0 i	96	02/98→08/03	→ Construction year to: 07/03;	2	11.8171-0008.1 990049	Brake System: ATE
2.0 SE Turbo	147	02/98→08/03	Vehicle Identification Number from: X7020001 →; Required quantity: 2			
2.0 Turbo	113 - 136	02/98→08/03				
			→ Construction year to: 12/98;	2	11.8171-0008.1 990049	Brake System: ATE
			Required quantity: 2			
2.3 i	110	02/98→08/03				
			Construction year from: 01/99 → → Construction year to: 07/03;	2	11.8171-0008.1 990049	Brake System: ATE
			Required quantity: 2			
			→ Vehicle Identification Number to: X2020000; Required quantity: 2	2	11.8171-0008.1 990049	Brake System: ATE
			→ Vehicle Identification Number to: X7020000; Required quantity: 2	2	11.8171-0008.1 990049	Brake System: ATE
			→ Construction year to: 07/03;	2	11.8171-0008.1 990049	Brake System: ATE
			Vehicle Identification Number from: X2020001 →; Required quantity: 2			
2.0 Turbo	110 - 151	10/99→08/03				
			→ Construction year to: 07/03;	2	11.8171-0008.1 990049	Brake System: ATE
			Required quantity: 2			
2.3 Turbo	165	10/99→08/03				
2.3	169	09/99→01/02	Construction year from: 10/99 →;	2	11.8171-0008.1 990049	Brake System: ATE
			Required quantity: 2			

	kW				
SAAB - 9-3 Convertible (YS3F) 08/03→02/15					
Spring, brake caliper					
1 8t 8t BioPower 2.0 t 2.0 t BioPower 2.0 Turbo Performance	110 08/03→02/15 110 08/03→02/15 110 01/07→02/15 120 - 08/03→02/15 162 120 - 01/11→02/15 162 185 04/04→02/15	Vehicle Identification Number from: 51046734 →; → Construction year to: 06/12; Required quantity: 2; Fitting Position: Front Axle	2	11.8116-0356.1 390586	Brake System: ATE
		→ Construction year to: 06/12; Rim Size [in]: 15; Required quantity: 2; Brake Caliper Type: Cast iron brake caliper; Fitting Position: Front Axle	2	11.8116-0356.1 390586	Brake System: ATE
1.8 i	90 01/04→02/15	→ Construction year to: 06/12; Rim Size [in]: 15; Required quantity: 2; Fitting Position: Front Axle	2	11.8116-0356.1 390586	Brake System: ATE
		Vehicle Identification Number from: 51046734 →; → Construction year to: 06/12; Required quantity: 2; Fitting Position: Front Axle	2	11.8116-0356.1 390586	Brake System: ATE
1.9 TiD	88 09/04→02/15	→ Construction year to: 06/12; Rim Size [in]: 15; Required quantity: 2; Fitting Position: Front Axle	2	11.8116-0356.1 390586	Brake System: ATE
		→ Construction year to: 06/12; Required quantity: 2; Fitting Position: Front Axle	2	11.8116-0356.1 390586	Brake System: ATE
1.9 TiD 1.9 TTiD	110 01/06→02/15 96 - 12/07→02/15 132	→ Construction year to: 06/12; Required quantity: 2; Fitting Position: Front Axle	2	11.8116-0356.1 390586	Brake System: ATE
		→ Construction year to: 06/12; Rim Size [in]: 15; Required quantity: 2; Brake Caliper Type: Cast iron brake caliper; Fitting Position: Front Axle	2	11.8116-0356.1 390586	Brake System: ATE
2.0	130 - 09/04→09/07 143	Vehicle Identification Number from: 51046734 →; Required quantity: 2; Fitting Position: Front Axle	2	11.8116-0356.1 390586	Brake System: ATE
		Rim Size [in]: 15; Required quantity: 2; Brake Caliper Type: Cast iron brake caliper; Fitting Position: Front Axle	2	11.8116-0356.1 390586	Brake System: ATE
2.0 t	129 08/03→02/15	→ Construction year to: 06/12; Rim Size [in]: 15; Required quantity: 2; Fitting Position: Front Axle	2	11.8116-0356.1 390586	Brake System: ATE
		Vehicle Identification Number from: 51046734 →; → Construction year to: 06/12; Required quantity: 2; Fitting Position: Front Axle	2	11.8116-0356.1 390586	Brake System: ATE
		→ Construction year to: 06/12; Rim Size [in]: 15; Required quantity: 2; Brake Caliper Type: Cast iron brake caliper; Fitting Position: Front Axle	2	11.8116-0356.1 390586	Brake System: ATE
2.0 t BioPower	129 01/07→02/15	Vehicle Identification Number from: 51046734 →; → Construction year to: 06/12; Required quantity: 2; Fitting Position: Front Axle	2	11.8116-0356.1 390586	Brake System: ATE
		→ Construction year to: 06/12; Rim Size [in]: 15; Required quantity: 2; Brake Caliper Type: Cast iron brake caliper; Fitting Position: Front Axle	2	11.8116-0356.1 390586	Brake System: ATE
		Construction year from: 07/07 → → Construction year to: 06/12; Rim Size [in]: 15; Required quantity: 2; Brake Caliper Type: Cast iron brake caliper; Fitting Position: Front Axle	2	11.8116-0356.1 390586	Brake System: ATE
2.0 t BioPower 2.0 T BioPower	147 06/07→02/15 145 06/07→02/15	Vehicle Identification Number from: 51046734 →; → Construction year to: 06/12; Required quantity: 2; Fitting Position: Front Axle	2	11.8116-0356.1 390586	Brake System: ATE
		Construction year from: 07/07 → → Construction year to: 06/12; Rim Size [in]: 15; Required quantity: 2; Brake Caliper Type: Cast iron brake caliper; Fitting Position: Front Axle	2	11.8116-0356.1 390586	Brake System: ATE
Guide Sleeve Kit, brake caliper					
1 8t 8t BioPower 1.8 i 2.0 t BioPower	110 08/03→02/15 110 08/03→02/15 110 01/07→02/15 90 01/04→02/15 120 - 01/11→02/15 162	→ Vehicle Identification Number to: 51046733; Fitting Position: Front Axle		11.0101-5407.2 260011	Brake System: ATE
		Vehicle Identification Number from: 51046734 →;		11.0101-5407.2 260011	Brake System: ATE
→					

	kW				
SAAB - 9-3 Convertible (YS3F) 08/03→02/15					
Guide Sleeve Kit, brake caliper					
1	110	08/03→02/15	→ Construction year to: 06/12;		
8t	110	08/03→02/15	Fitting Position: Front Axle		
8t BioPower	110	01/07→02/15	→ Construction year to: 06/12;	11.0101-5407.2	260011 Brake System: ATE
1.8 i	90	01/04→02/15	Rim Size [in]: 15;		
2.0 t BioPower	120	01/11→02/15	Fitting Position: Front Axle		
	162		→ Construction year to: 06/12;	11.0101-5407.2	260011 Brake System: ATE
			Fitting Position: Front Axle		
			→ Construction year to: 06/12;	11.0101-5407.2	260011 Brake System: ATE
			Fitting Position: Rear Axle		
1.9 TiD	88	09/04→02/15	→ Construction year to: 06/12;	11.0101-5407.2	260011 Brake System: ATE
	110		Rim Size [in]: 15;		
1.9 TTiD	96	12/07→02/15	Fitting Position: Front Axle		
	132		→ Construction year to: 06/12;	11.0101-5407.2	260011 Brake System: ATE
			Fitting Position: Front Axle		
			→ Construction year to: 06/12;	11.0101-5407.2	260011 Brake System: ATE
			Fitting Position: Rear Axle		
2.0	130	09/04→09/07	Fitting Position: Front Axle	11.0101-5407.2	260011 Brake System: ATE
	143		Vehicle Identification Number from:	11.0101-5407.2	260011 Brake System: ATE
			51046734 →; Fitting Position: Front Axle		
			Rim Size [in]: 15;	11.0101-5407.2	260011 Brake System: ATE
			Fitting Position: Front Axle		
			→ Vehicle Identification Number to:	11.0101-5407.2	260011 Brake System: ATE
			51046733; Fitting Position: Front Axle		
			Fitting Position: Rear Axle	11.0101-5407.2	260011 Brake System: ATE
2.0 t	120	01/11→02/15	→ Vehicle Identification Number to:	11.0101-5407.2	260011 Brake System: ATE
	162		51046733; Fitting Position: Front Axle		
			Vehicle Identification Number from:	11.0101-5407.2	260011 Brake System: ATE
			51046734 →;		
			→ Construction year to: 06/12;	11.0101-5407.2	260011 Brake System: ATE
			Fitting Position: Front Axle		
			→ Construction year to: 06/12;	11.0101-5407.2	260011 Brake System: ATE
			Fitting Position: Front Axle		
			→ Construction year to: 06/12;	11.0101-5407.2	260011 Brake System: ATE
			Rim Size [in]: 15;		
			Fitting Position: Front Axle		
2.0 t	129	08/03→02/15	→ Vehicle Identification Number to:	11.0101-5407.2	260011 Brake System: ATE
			51046733; Fitting Position: Front Axle		
			Vehicle Identification Number from:	11.0101-5407.2	260011 Brake System: ATE
			51046734 →;		
			→ Construction year to: 06/12;	11.0101-5407.2	260011 Brake System: ATE
			Fitting Position: Front Axle		
			→ Construction year to: 06/12;	11.0101-5407.2	260011 Brake System: ATE
			Rim Size [in]: 15;		
			Fitting Position: Front Axle		
			Vehicle Identification Number from:	11.0101-5407.2	260011 Brake System: ATE
			51049407 →;		
			→ Construction year to: 06/12;	11.0101-5407.2	260011 Brake System: ATE
			Fitting Position: Rear Axle		
			→ Vehicle Identification Number to:	11.0101-5407.2	260011 Brake System: ATE
			51049406; Fitting Position: Rear Axle		
			→ Construction year to: 06/12;	11.0101-5407.2	260011 Brake System: ATE
			Fitting Position: Rear Axle		
2.0 t	154	08/03→02/15	→ Vehicle Identification Number to:	11.0101-5407.2	260011 Brake System: ATE
			51046733; Fitting Position: Front Axle		
			Vehicle Identification Number from:	11.0101-5407.2	260011 Brake System: ATE
			51046734 →;		
			→ Construction year to: 06/12;	11.0101-5407.2	260011 Brake System: ATE
			Fitting Position: Front Axle		
			→ Construction year to: 06/12;	11.0101-5407.2	260011 Brake System: ATE
			Rim Size [in]: 15;		
			Fitting Position: Front Axle		
			→ Construction year to: 06/12;	11.0101-5407.2	260011 Brake System: ATE
			Fitting Position: Front Axle		
			→ Vehicle Identification Number to:	11.0101-5407.2	260011 Brake System: ATE
			41022027; Fitting Position: Front Axle		
			Vehicle Identification Number from:	11.0101-5407.2	260011 Brake System: ATE
			41022028 → → Vehicle Identification		
			Number to: 51046733;		
			Fitting Position: Front Axle		
			→ Vehicle Identification Number to:	11.0101-5407.2	260011 Brake System: ATE
			51049406; Fitting Position: Rear Axle		
			Vehicle Identification Number from:	11.0101-5407.2	260011 Brake System: ATE
			51049407 →;		
			→ Construction year to: 06/12;		
			Fitting Position: Rear Axle		

	kW				
SAAB - 9-3 Convertible (YS3F) 08/03→02/15					
Guide Sleeve Kit, brake caliper					
2.0 t BioPower	129 01/07→02/15	→ Vehicle Identification Number to: 51046733; Fitting Position: Front Axle		11.0101-5407.2 260011	Brake System: ATE
		Construction year from: 07/07 → → Construction year to: 06/12; Rim Size [in]: 15; Fitting Position: Front Axle		11.0101-5407.2 260011	Brake System: ATE
		Vehicle Identification Number from: 51046734 →; → Construction year to: 06/12; Fitting Position: Front Axle		11.0101-5407.2 260011	Brake System: ATE
		→ Construction year from: 07/07 → →; → Vehicle Identification Number to: 51046733; Fitting Position: Front Axle		11.0101-5407.2 260011	Brake System: ATE
		→ Construction year to: 06/12; Rim Size [in]: 15; Fitting Position: Front Axle		11.0101-5407.2 260011	Brake System: ATE
		→ Construction year to: 06/12; Fitting Position: Front Axle		11.0101-5407.2 260011	Brake System: ATE
		Construction year from: 07/07 → → Construction year to: 06/12; Fitting Position: Front Axle		11.0101-5407.2 260011	Brake System: ATE
		→ Construction year to: 06/12; Fitting Position: Rear Axle		11.0101-5407.2 260011	Brake System: ATE
		Construction year from: 07/07 → → Construction year to: 06/12; Fitting Position: Rear Axle		11.0101-5407.2 260011	Brake System: ATE
		2.0 t BioPower 2.0 T BioPower	147 06/07→02/15 145 06/07→02/15	Construction year from: 07/07 → →; → Vehicle Identification Number to: 51046733; Fitting Position: Front Axle	
Vehicle Identification Number from: 51046734 →; → Construction year to: 06/12; Fitting Position: Front Axle				11.0101-5407.2 260011	Brake System: ATE
Construction year from: 07/07 → → Construction year to: 06/12; Rim Size [in]: 15; Fitting Position: Front Axle				11.0101-5407.2 260011	Brake System: ATE
Construction year from: 07/07 → → Construction year to: 06/12; Fitting Position: Front Axle				11.0101-5407.2 260011	Brake System: ATE
Construction year from: 07/07 → → Construction year to: 06/12; Fitting Position: Rear Axle				11.0101-5407.2 260011	Brake System: ATE
2.0 Turbo Performance	185 04/04→02/15	→ Vehicle Identification Number to: 51046733; Fitting Position: Front Axle		11.0101-5407.2 260011	Brake System: ATE
		Vehicle Identification Number from: 51046734 →; → Construction year to: 06/12; Fitting Position: Front Axle		11.0101-5407.2 260011	Brake System: ATE
		→ Construction year to: 06/12; Fitting Position: Front Axle		11.0101-5407.2 260011	Brake System: ATE
		→ Construction year to: 06/12; Rim Size [in]: 15; Fitting Position: Front Axle		11.0101-5407.2 260011	Brake System: ATE
		Vehicle Identification Number from: 51049407 →; → Construction year to: 06/12; Fitting Position: Rear Axle		11.0101-5407.2 260011	Brake System: ATE
		→ Vehicle Identification Number to: 51049406; Fitting Position: Rear Axle		11.0101-5407.2 260011	Brake System: ATE
2.8 Turbo V6	169 02/06→02/15	Construction year from: 06/08 → → Construction year to: 06/12; Fitting Position: Front Axle		11.0101-5407.2 260011	Brake System: ATE
		Construction year from: 06/08 → → Construction year to: 06/12; Fitting Position: Rear Axle		11.0101-5407.2 260011	Brake System: ATE
2.8 Turbo V6	184 - 02/06→02/15 206	→ Construction year to: 06/12; Fitting Position: Front Axle		11.0101-5407.2 260011	Brake System: ATE
		→ Construction year to: 06/12; Fitting Position: Rear Axle		11.0101-5407.2 260011	Brake System: ATE
Guide Bolt, brake caliper					
1	110 08/03→02/15	→ Construction year to: 06/12;	2	11.8171-0008.1 990049	Brake System: ATE
8t	110 08/03→02/15	Required quantity: 2			
8t BioPower	110 01/07→02/15	→ Construction year to: 06/12;	2	11.8171-0008.1 990049	Brake System: ATE
1.8 i	90 01/04→02/15	Rim Size [in]: 15; Required quantity: 2			
2.0 t	120 - 01/11→02/15 162	→ Vehicle Identification Number to: 51046733; Required quantity: 2	2	11.8171-0008.1 990049	Brake System: ATE
→					

	kW				
SAAB - 9-3 Convertible (YS3F) 08/03→02/15					
Guide Bolt, brake caliper					
2.0 t BioPower	120 - 01/11→02/15 162	Vehicle Identification Number from: 51046734 →; → Construction year to: 06/12; Required quantity: 2	2	11.8171-0008.1 990049	Brake System: ATE
1.9 TiD	88 - 09/04→02/15 110	→ Construction year to: 06/12; Rim Size [in]: 15; Required quantity: 2	2	11.8171-0008.1 990049	Brake System: ATE
1.9 TTiD	96 - 12/07→02/15 132	→ Construction year to: 06/12; Required quantity: 2	2	11.8171-0008.1 990049	Brake System: ATE
2.0	130 - 09/04→09/07 143	Required quantity: 2	2	11.8171-0008.1 990049	Brake System: ATE
		Rim Size [in]: 15; Required quantity: 2	2	11.8171-0008.1 990049	Brake System: ATE
		→ Vehicle Identification Number to: 51046733; Required quantity: 2	2	11.8171-0008.1 990049	Brake System: ATE
		Vehicle Identification Number from: 51046734 →; Required quantity: 2	2	11.8171-0008.1 990049	Brake System: ATE
2.0 t 2.0 Turbo Performance	129 08/03→02/15 185 04/04→02/15	Vehicle Identification Number from: 51049407 →; → Construction year to: 06/12; Required quantity: 2	2	11.8171-0008.1 990049	Brake System: ATE
		→ Construction year to: 06/12; Required quantity: 2	2	11.8171-0008.1 990049	Brake System: ATE
		→ Construction year to: 06/12; Rim Size [in]: 15; Required quantity: 2	2	11.8171-0008.1 990049	Brake System: ATE
		→ Vehicle Identification Number to: 51046733; Required quantity: 2	2	11.8171-0008.1 990049	Brake System: ATE
		→ Vehicle Identification Number to: 51049406; Required quantity: 2	2	11.8171-0008.1 990049	Brake System: ATE
		Vehicle Identification Number from: 51046734 →; → Construction year to: 06/12; Required quantity: 2	2	11.8171-0008.1 990049	Brake System: ATE
2.0 t	154 08/03→02/15	Vehicle Identification Number from: 51046734 →; → Construction year to: 06/12; Required quantity: 2	2	11.8171-0008.1 990049	Brake System: ATE
		Vehicle Identification Number from: 51049407 →; → Construction year to: 06/12; Required quantity: 2	2	11.8171-0008.1 990049	Brake System: ATE
		→ Construction year to: 06/12; Rim Size [in]: 15; Required quantity: 2	2	11.8171-0008.1 990049	Brake System: ATE
		→ Construction year to: 06/12; Required quantity: 2	2	11.8171-0008.1 990049	Brake System: ATE
		→ Vehicle Identification Number to: 51049406; Required quantity: 2	2	11.8171-0008.1 990049	Brake System: ATE
		Vehicle Identification Number from: 41022028 → → Vehicle Identification Number to: 51046733; Required quantity: 2	2	11.8171-0008.1 990049	Brake System: ATE
		→ Vehicle Identification Number to: 41022027; Required quantity: 2	2	11.8171-0008.1 990049	Brake System: ATE
		→ Vehicle Identification Number to: 51046733; Required quantity: 2	2	11.8171-0008.1 990049	Brake System: ATE
2.0 t BioPower	129 01/07→02/15	→ Construction year to: 06/12; Rim Size [in]: 15; Required quantity: 2	2	11.8171-0008.1 990049	Brake System: ATE
		Construction year from: 07/07 → → Construction year to: 06/12; Required quantity: 2	2	11.8171-0008.1 990049	Brake System: ATE
		Construction year from: 07/07 → → Construction year to: 06/12; Rim Size [in]: 15; Required quantity: 2	2	11.8171-0008.1 990049	Brake System: ATE
		→ Construction year to: 06/12; Required quantity: 2	2	11.8171-0008.1 990049	Brake System: ATE
		→ Vehicle Identification Number to: 51046733; Required quantity: 2	2	11.8171-0008.1 990049	Brake System: ATE
		Construction year from: 07/07 →; → Vehicle Identification Number to: 51046733; Required quantity: 2	2	11.8171-0008.1 990049	Brake System: ATE
		Vehicle Identification Number from: 51046734 →; → Construction year to: 06/12; Required quantity: 2	2	11.8171-0008.1 990049	Brake System: ATE
2.0 t BioPower 2.0 T BioPower	147 06/07→02/15 145 06/07→02/15	Construction year from: 07/07 → → Construction year to: 06/12; Required quantity: 2	2	11.8171-0008.1 990049	Brake System: ATE
		Construction year from: 07/07 → → Construction year to: 06/12; Rim Size [in]: 15; Required quantity: 2	2	11.8171-0008.1 990049	Brake System: ATE
→					

	kW				
SAAB - 9-3 Convertible (YS3F) 08/03→02/15					
Guide Bolt, brake caliper					
2.0 t BioPower	147	06/07→02/15	Vehicle Identification Number from: 51046734 →;	2	11.8171-0008.1 990049 Brake System: ATE
2.0 T BioPower	145	06/07→02/15	→ Construction year to: 06/12; Required quantity: 2		
			Construction year from: 07/07 →;	2	11.8171-0008.1 990049 Brake System: ATE
			→ Vehicle Identification Number to: 51046733; Required quantity: 2		
2.8 Turbo V6	169	02/06→02/15	Construction year from: 06/08 → →	2	11.8171-0008.1 990049 Brake System: ATE
			Construction year to: 06/12; Required quantity: 2		
2.8 Turbo V6	184 - 206	02/06→02/15	→ Construction year to: 06/12; Required quantity: 2	2	11.8171-0008.1 990049 Brake System: ATE
SAAB - 9-3 Estate (E50) 03/05→02/15					
Spring, brake caliper					
1.8 i	90	03/05→02/15	→ Construction year to: 06/12;	2	11.8116-0356.1 390586 Brake System: ATE
1.8 t	110	03/05→02/15	Rim Size [in]: 15; Required quantity: 2;		
1.8t 2.0	110	03/05→02/15	Fitting Position: Front Axle		
1.9 TiD	88 - 110	03/05→02/15			
1.9 TTiD	96 - 132	12/07→02/15			
2.0 t	110 - 129	03/05→02/15			
2.0 T16	143	04/06→02/15			
2.0 t BioPower	110 - 162	01/07→02/15			
2.0 t Bio Power	147	02/09→02/15			
2.0 t BioPower XWD	120 - 162	01/07→02/15			
2.0 t Bio Power XWD	154	06/08→02/15			
2.0 t XWD	120 - 162	01/07→02/15			
2.0 t	154	03/05→02/15	→ Construction year to: 12/05;	2	11.8116-0356.1 390586 Brake System: ATE
2.8 Turbo V6	169 - 184	03/05→02/15	Required quantity: 2; Fitting Position: Front Axle		
Guide Sleeve Kit, brake caliper					
1.8 i	90	03/05→02/15	→ Construction year to: 06/12;		11.0101-5407.2 260011 Brake System: ATE
1.8 t	110	03/05→02/15	Rim Size [in]: 15;		
1.8t 2.0	110	03/05→02/15	Fitting Position: Front Axle		
1.9 TiD	88 - 110	03/05→02/15	→ Construction year to: 06/12;		11.0101-5407.2 260011 Brake System: ATE
			Fitting Position: Front Axle		
1.9 TTiD	96 - 132	12/07→02/15	→ Construction year to: 06/12;		11.0101-5407.2 260011 Brake System: ATE
			Fitting Position: Rear Axle		
2.0 t	110 - 129	03/05→02/15			
2.0 T16	143	04/06→02/15			
2.0 t BioPower	110 - 145	01/07→02/15			
2.0 t Bio Power	147	02/09→02/15			
2.0 t BioPower XWD	120 - 162	01/07→02/15			
2.0 t Bio Power XWD	154	06/08→02/15			
2.0 t XWD	120 - 162	01/07→02/15			
2.0 t	147 - 177	02/09→02/15	→ Construction year to: 06/12;		11.0101-5407.2 260011 Brake System: ATE
			Fitting Position: Front Axle		
2.0 t XWD	177	05/09→02/15	Vehicle Identification Number from: 93171501 →;		11.0101-5407.2 260011 Brake System: ATE
2.8 Turbo V6	188 - 206	12/07→02/15	→ Construction year to: 06/12;		
			Fitting Position: Rear Axle		
			→ Vehicle Identification Number to: 93171500; Fitting Position: Rear Axle		11.0101-5407.2 260011 Brake System: ATE
2.0 t	154	03/05→02/15	→ Construction year to: 12/05;		11.0101-5407.2 260011 Brake System: ATE
2.8 Turbo V6	169 - 184	03/05→02/15	Fitting Position: Front Axle		
			Construction year from: 01/06 → →		11.0101-5407.2 260011 Brake System: ATE
			Construction year to: 06/12; Fitting Position: Front Axle		
			→ Vehicle Identification Number to: 93171500; Fitting Position: Rear Axle		11.0101-5407.2 260011 Brake System: ATE
			Vehicle Identification Number from: 93171501 →;		11.0101-5407.2 260011 Brake System: ATE
			→ Construction year to: 06/12; Fitting Position: Rear Axle		
2.0 t BioPower	162	01/11→02/15	→ Construction year to: 06/12;		11.0101-5407.2 260011 Brake System: ATE
			Rim Size [in]: 15; Fitting Position: Front Axle		
→					

	kW					
SAAB - 9-3 Estate (E50) 03/05→02/15						
Guide Sleeve Kit, brake caliper						
2.0 t BioPower	162	01/11→02/15	→ Construction year to: 06/12; Fitting Position: Rear Axle	2	11.0101-5407.2 260011 Brake System: ATE	
2.0 t XWD	154	06/08→02/15	Construction year from: 07/08 → → Construction year to: 06/12; Fitting Position: Front Axle	2	11.0101-5407.2 260011 Brake System: ATE	
			Vehicle Identification Number from: 93171501 →; → Construction year to: 06/12; Fitting Position: Rear Axle	2	11.0101-5407.2 260011 Brake System: ATE	
			Construction year from: 07/08 →; → Vehicle Identification Number to: 93171500; Fitting Position: Rear Axle	2	11.0101-5407.2 260011 Brake System: ATE	
2.8 Turbo V6 XWD	206	05/08→12/11	Fitting Position: Front Axle	2	11.0101-5407.2 260011 Brake System: ATE	
			Vehicle Identification Number from: 93171501 →; Fitting Position: Rear Axle	2	11.0101-5407.2 260011 Brake System: ATE	
			→ Vehicle Identification Number to: 93171500; Fitting Position: Rear Axle	2	11.0101-5407.2 260011 Brake System: ATE	
Guide Bolt, brake caliper						
1.8 i	90	03/05→02/15	→ Construction year to: 06/12;	2	11.8171-0008.1 990049 Brake System: ATE	
1.8 t	110	03/05→02/15	Required quantity: 2			
1.8t 2.0	110	03/05→02/15	→ Construction year to: 06/12;	2	11.8171-0008.1 990049 Brake System: ATE	
1.9 TiD	88 -	03/05→02/15	Rim Size [in]: 15; Required quantity: 2;			
			110	Fitting Position: Front Axle		
2.0 t	110 -	03/05→02/15	→ Construction year to: 06/12;	2	11.8171-0008.1 990049 Brake System: ATE	
			129	Required quantity: 2;		
2.0 T16	143	04/06→02/15	Fitting Position: Rear Axle			
2.0 t BioPower	110 -	01/07→02/15	→ Construction year to: 06/12;	2	11.8171-0008.1 990049 Brake System: ATE	
			145	Required quantity: 2;		
2.0 t Bio Power	147	02/09→02/15				
2.0 t BioPower XWD	120 -	01/07→02/15	Fitting Position: Rear Axle			
			162			
2.0 t Bio Power XWD	154	06/08→02/15				
2.0 t XWD	120 -	01/07→02/15				
			162			
1.9 TTiD	96 -	12/07→02/15	→ Construction year to: 06/12;	2	11.8171-0008.1 990049 Brake System: ATE	
			132	Required quantity: 2		
			→ Construction year to: 06/12;	2	11.8171-0008.1 990049 Brake System: ATE	
			Rim Size [in]: 15; Required quantity: 2;			
			Fitting Position: Front Axle			
			→ Construction year to: 06/12;	2	11.8171-0008.1 990049 Brake System: ATE	
			Required quantity: 2;			
			Fitting Position: Front Axle			
			→ Construction year to: 06/12;	2	11.8171-0008.1 990049 Brake System: ATE	
			Required quantity: 2;			
			Fitting Position: Rear Axle			
2.0 t	147 -	02/09→02/15	→ Construction year to: 06/12;	2	11.8171-0008.1 990049 Brake System: ATE	
			177	Required quantity: 2;		
2.0 t XWD	177	05/09→02/15	Fitting Position: Front Axle			
2.8 Turbo V6	188 -	12/07→02/15	Vehicle Identification Number from: 93171501 →;	2	11.8171-0008.1 990049 Brake System: ATE	
			206	→ Construction year to: 06/12;		
			Required quantity: 2;			
			Fitting Position: Rear Axle			
			→ Vehicle Identification Number to: 93171500; Required quantity: 2;	2	11.8171-0008.1 990049 Brake System: ATE	
			Fitting Position: Rear Axle			
2.0 t	154	03/05→02/15	→ Construction year to: 12/05;	2	11.8171-0008.1 990049 Brake System: ATE	
2.8 Turbo V6	169 -	03/05→02/15	Required quantity: 2;			
			184	Fitting Position: Front Axle		
			Construction year from: 01/06 → → Construction year to: 06/12;	2	11.8171-0008.1 990049 Brake System: ATE	
			Required quantity: 2;			
			Fitting Position: Front Axle			
			→ Vehicle Identification Number to: 93171500; Required quantity: 2;	2	11.8171-0008.1 990049 Brake System: ATE	
			Fitting Position: Rear Axle			
			Vehicle Identification Number from: 93171501 →;	2	11.8171-0008.1 990049 Brake System: ATE	
			→ Construction year to: 06/12;			
			Required quantity: 2;			
			Fitting Position: Rear Axle			
2.0 t BioPower	162	01/11→02/15	→ Construction year to: 06/12;	2	11.8171-0008.1 990049 Brake System: ATE	
			Rim Size [in]: 15; Required quantity: 2;			
			Fitting Position: Front Axle			
			→ Construction year to: 06/12;	2	11.8171-0008.1 990049 Brake System: ATE	
			Required quantity: 2;			
			Fitting Position: Rear Axle			
→						

SAAB - 9-3 Estate (E50) 03/05→02/15						
Guide Bolt, brake caliper						
2.0 t XWD	154	06/08→02/15	Construction year from: 07/08 → → Construction year to: 06/12; Required quantity: 2; Fitting Position: Front Axle	2	11.8171-0008.1 990049	Brake System: ATE
			Vehicle Identification Number from: 93171501 →; → Construction year to: 06/12; Required quantity: 2; Fitting Position: Rear Axle	2	11.8171-0008.1 990049	Brake System: ATE
			Construction year from: 07/08 →; → Vehicle Identification Number to: 93171500; Required quantity: 2; Fitting Position: Rear Axle	2	11.8171-0008.1 990049	Brake System: ATE
2.8 Turbo V6 XWD	206	05/08→12/11	Required quantity: 2; Fitting Position: Front Axle	2	11.8171-0008.1 990049	Brake System: ATE
			Vehicle Identification Number from: 93171501 →; Required quantity: 2; Fitting Position: Rear Axle	2	11.8171-0008.1 990049	Brake System: ATE
			→ Vehicle Identification Number to: 93171500; Required quantity: 2; Fitting Position: Rear Axle	2	11.8171-0008.1 990049	Brake System: ATE
SAAB - 9-3X (YS3) 02/09→02/15						
Spring, brake caliper						
1.9 TTiD AWD	132	02/09→12/12	Construction year from: 03/09 → →	2	11.8116-0356.1 390586	Brake System: ATE
2.0 t BioPower XWD	154	02/09→12/12	Construction year to: 06/12; Required quantity: 2;			
2.0 t XWD	154	02/09→02/15	Fitting Position: Front Axle			
			Construction year from: 03/09 → → Construction year to: 06/12; Rim Size [in]: 15; Required quantity: 2; Brake Caliper Type: Cast iron brake caliper; Fitting Position: Front Axle	2	11.8116-0356.1 390586	Brake System: ATE
2.0 T16 XWD	162	01/11→02/15	→ Construction year to: 06/12;	2	11.8116-0356.1 390586	Brake System: ATE
2.0 t BioPower XWD	162	01/11→12/12	Rim Size [in]: 15; Required quantity: 2; Fitting Position: Front Axle			
			→ Construction year to: 06/12; Required quantity: 2; Fitting Position: Front Axle	2	11.8116-0356.1 390586	Brake System: ATE
Guide Sleeve Kit, brake caliper						
1.9 TTiD AWD	132	02/09→12/12	Construction year from: 03/09 → →		11.0101-5407.2 260011	Brake System: ATE
2.0 t BioPower XWD	154	02/09→12/12	Construction year to: 06/12; Rim Size [in]: 15;			
2.0 t XWD	154	02/09→02/15	Fitting Position: Front Axle			
			Construction year from: 03/09 → → Construction year to: 06/12; Fitting Position: Front Axle		11.0101-5407.2 260011	Brake System: ATE
			Construction year from: 03/09 → → Construction year to: 06/12; Fitting Position: Rear Axle		11.0101-5407.2 260011	Brake System: ATE
2.0 T16 XWD	162	01/11→02/15	→ Construction year to: 06/12;		11.0101-5407.2 260011	Brake System: ATE
2.0 t BioPower XWD	162	01/11→12/12	Rim Size [in]: 15; Fitting Position: Front Axle			
			→ Construction year to: 06/12; Fitting Position: Front Axle		11.0101-5407.2 260011	Brake System: ATE
			→ Construction year to: 06/12; Fitting Position: Rear Axle		11.0101-5407.2 260011	Brake System: ATE
Guide Bolt, brake caliper						
1.9 TTiD AWD	132	02/09→12/12	Construction year from: 03/09 → →	2	11.8171-0008.1 990049	Brake System: ATE
2.0 t BioPower XWD	154	02/09→12/12	Construction year to: 06/12;			
2.0 t XWD	154	02/09→02/15	Rim Size [in]: 15; Required quantity: 2			
			Construction year from: 03/09 → → Construction year to: 06/12; Required quantity: 2	2	11.8171-0008.1 990049	Brake System: ATE
2.0 T16 XWD	162	01/11→02/15	→ Construction year to: 06/12;	2	11.8171-0008.1 990049	Brake System: ATE
2.0 t BioPower XWD	162	01/11→12/12	Rim Size [in]: 15; Required quantity: 2			
			→ Construction year to: 06/12; Required quantity: 2	2	11.8171-0008.1 990049	Brake System: ATE
SAAB - 9-5 (YS3E) 09/97→12/09						
Guide Sleeve Kit, brake caliper						
1.9 TiD	110	01/06→12/09	Fitting Position: Front Axle		11.0101-5407.2 260011	Brake System: ATE
2.2 TiD	88	03/02→12/09				
2.3 Turbo	169 -	10/99→12/09	Fitting Position: Rear Axle		11.0101-5407.2 260011	Brake System: ATE
	191					
→						

	kW				
SAAB - 9-5 (YS3E) 09/97→12/09					
Guide Sleeve Kit, brake caliper					
2.0 t	110 09/97→12/09	→ Vehicle Identification Number to: X3020000; Fitting Position: Front Axle		11.0101-5407.2 260011	Brake System: ATE
2.3 t	125 09/97→12/03	→ Construction year to: 12/01; Vehicle Identification Number from: X3020001 →; Fitting Position: Front Axle		11.0101-5407.2 260011	Brake System: ATE
		Construction year from: 01/02 →; Fitting Position: Front Axle		11.0101-5407.2 260011	Brake System: ATE
		→ Construction year to: 12/98; Fitting Position: Front Axle		11.0101-5407.2 260011	Brake System: ATE
		Construction year from: 01/99 → → Construction year to: 12/01; Fitting Position: Front Axle		11.0101-5407.2 260011	Brake System: ATE
		Vehicle Identification Number from: X3025752 →; Fitting Position: Rear Axle		11.0101-5407.2 260011	Brake System: ATE
2.0 t	136 07/00→12/09	Fitting Position: Front Axle		11.0101-5407.2 260011	Brake System: ATE
		→ Construction year to: 12/01; Fitting Position: Front Axle		11.0101-5407.2 260011	Brake System: ATE
		→ Construction year to: 12/01; Vehicle Identification Number from: X3020001 →; Fitting Position: Front Axle		11.0101-5407.2 260011	Brake System: ATE
		Vehicle Identification Number from: X3025752 →; Fitting Position: Rear Axle		11.0101-5407.2 260011	Brake System: ATE
2.0 t Biopower	132 09/05→12/09	Construction year from: 06/06 →; Fitting Position: Front Axle		11.0101-5407.2 260011	Brake System: ATE
		Vehicle Identification Number from: X3025752 →; Fitting Position: Rear Axle		11.0101-5407.2 260011	Brake System: ATE
2.0 t BioPower	110 01/05→12/09	Fitting Position: Front Axle		11.0101-5407.2 260011	Brake System: ATE
2.3 t BioPower	136 - 11/06→12/09	Vehicle Identification Number from: X3025752 →; Fitting Position: Rear Axle		11.0101-5407.2 260011	Brake System: ATE
2.3 Turbo	152 04/08→12/09				
2.0 Turbo SE	141 10/98→07/00	→ Vehicle Identification Number to: X3020000; Fitting Position: Front Axle		11.0101-5407.2 260011	Brake System: ATE
		Vehicle Identification Number from: X3020001 →; Fitting Position: Front Axle		11.0101-5407.2 260011	Brake System: ATE
		Construction year from: 01/00 →; Fitting Position: Front Axle		11.0101-5407.2 260011	Brake System: ATE
		Construction year from: 01/99 →; Fitting Position: Front Axle		11.0101-5407.2 260011	Brake System: ATE
		→ Construction year to: 12/98; Fitting Position: Front Axle		11.0101-5407.2 260011	Brake System: ATE
		Vehicle Identification Number from: X3025752 →; Fitting Position: Rear Axle		11.0101-5407.2 260011	Brake System: ATE
2.3 t	136 01/01→12/09	→ Construction year to: 12/01; Vehicle Identification Number from: X3020001 →; Fitting Position: Front Axle		11.0101-5407.2 260011	Brake System: ATE
		Construction year from: 01/02 →; Fitting Position: Front Axle		11.0101-5407.2 260011	Brake System: ATE
		→ Construction year to: 12/01; Fitting Position: Front Axle		11.0101-5407.2 260011	Brake System: ATE
		Fitting Position: Rear Axle		11.0101-5407.2 260011	Brake System: ATE
2.3 Turbo	162 07/03→12/09	Fitting Position: Front Axle		11.0101-5407.2 260011	Brake System: ATE
		Vehicle Identification Number from: 43510123 →; Fitting Position: Front Axle		11.0101-5407.2 260011	Brake System: ATE
		Fitting Position: Rear Axle		11.0101-5407.2 260011	Brake System: ATE
2.3 Turbo	184 09/01→12/09	Construction year from: 01/02 →; Fitting Position: Front Axle		11.0101-5407.2 260011	Brake System: ATE
		→ Construction year to: 12/01; Fitting Position: Front Axle		11.0101-5407.2 260011	Brake System: ATE
		→ Construction year to: 12/01; Fitting Position: Rear Axle		11.0101-5407.2 260011	Brake System: ATE
		Construction year from: 01/02 →; → Vehicle Identification Number to: 53500056; Fitting Position: Rear Axle		11.0101-5407.2 260011	Brake System: ATE
		Vehicle Identification Number from: 53500057 →; Fitting Position: Rear Axle		11.0101-5407.2 260011	Brake System: ATE
		Construction year from: 01/02 →; Fitting Position: Rear Axle		11.0101-5407.2 260011	Brake System: ATE
2.3 Turbo	224 06/03→08/05	Fitting Position: Front Axle		11.0101-5407.2 260011	Brake System: ATE
		→ Construction year to: 03/04; Fitting Position: Rear Axle		11.0101-5407.2 260011	Brake System: ATE
3.0 TiD	130 07/01→08/05	→ Construction year to: 12/01; Fitting Position: Front Axle		11.0101-5407.2 260011	Brake System: ATE
		Construction year from: 01/02 →; Fitting Position: Front Axle		11.0101-5407.2 260011	Brake System: ATE
→					

	kW				
SAAB - 9-5 (YS3E) 09/97→12/09					
Guide Bolt, brake caliper					
2.3 Turbo	184 09/01→12/09	Construction year from: 01/02 →; → Vehicle Identification Number to: 53500056; Required quantity: 2	2	11.8171-0008.1 990049	Brake System: ATE
		Vehicle Identification Number from: 53500057 →; Required quantity: 2	2	11.8171-0008.1 990049	Brake System: ATE
2.3 Turbo	224 06/03→08/05	→ Construction year to: 03/04; Required quantity: 2	2	11.8171-0008.1 990049	Brake System: ATE
		Required quantity: 2	2	11.8171-0008.1 990049	Brake System: ATE
3.0 TiD	130 07/01→08/05	→ Construction year to: 12/01; Required quantity: 2	2	11.8171-0008.1 990049	Brake System: ATE
		Construction year from: 01/02 →; Required quantity: 2	2	11.8171-0008.1 990049	Brake System: ATE
3.0 V6t	147 01/98→08/05	→ Construction year to: 12/01; Required quantity: 2	2	11.8171-0008.1 990049	Brake System: ATE
		Construction year from: 01/02 →; Required quantity: 2	2	11.8171-0008.1 990049	Brake System: ATE
		→ Construction year to: 12/01; Vehicle Identification Number from: X3025752 →; Required quantity: 2	2	11.8171-0008.1 990049	Brake System: ATE
SAAB - 9-5 (YS3G) 01/10→01/12					
 Brake Caliper					
1.6 Turbo	132 05/10→01/12	Brake Size: 17" plus; Fitting Position: Front Axle Left / Front Axle		24.3421-1723.5 241449	Supplementary Article/Supple- mentary Info: without holder Brake Caliper Type: Fist-type Caliper
2.0 t BioPower	162 05/10→01/12				
2.0 t BioPower XWD	162 05/10→01/12				
2.0 TiD	118 05/10→01/12				
2.0 TTiD	140 05/10→01/12				
2.0 TTiD XWD	140 05/10→01/12				
2.0 Turbo	162 05/10→01/12				
2.0 Turbo XWD	162 05/10→01/12				
2.8 Turbo V6 XWD	221 05/10→01/12				
SAAB - 9-5 Estate (YS3E) 10/98→12/09					
Guide Sleeve Kit, brake caliper					
1.9 TiD	110 - 01/06→12/09	Fitting Position: Front Axle		11.0101-5407.2 260011	Brake System: ATE
	129				
2.2 TiD	88 03/02→12/09	Fitting Position: Rear Axle		11.0101-5407.2 260011	Brake System: ATE
2.3 Turbo	169 - 10/99→12/09				
	224				
2.0 t	110 10/98→12/09	→ Vehicle Identification Number to: X3020000; Fitting Position: Front Axle		11.0101-5407.2 260011	Brake System: ATE
2.3 t	125 10/98→12/09	→ Construction year to: 12/01; Vehicle Identification Number from: X3020001 →; Fitting Position: Front Axle		11.0101-5407.2 260011	Brake System: ATE
		Construction year from: 01/02 →; Fitting Position: Front Axle		11.0101-5407.2 260011	Brake System: ATE
		→ Construction year to: 12/98; Fitting Position: Front Axle		11.0101-5407.2 260011	Brake System: ATE
		Construction year from: 01/99 → → Construction year to: 12/01; Fitting Position: Front Axle		11.0101-5407.2 260011	Brake System: ATE
		Vehicle Identification Number from: X3025752 →; Fitting Position: Rear Axle		11.0101-5407.2 260011	Brake System: ATE
2.0 t	136 07/00→07/01	Fitting Position: Front Axle		11.0101-5407.2 260011	Brake System: ATE
		→ Vehicle Identification Number to: X3020000; Fitting Position: Front Axle		11.0101-5407.2 260011	Brake System: ATE
		Vehicle Identification Number from: X3020001 →; Fitting Position: Front Axle		11.0101-5407.2 260011	Brake System: ATE
		Fitting Position: Rear Axle		11.0101-5407.2 260011	Brake System: ATE
2.0 t	141 10/98→07/00	Vehicle Identification Number from: X3020001 →; Fitting Position: Front Axle		11.0101-5407.2 260011	Brake System: ATE
		→ Vehicle Identification Number to: X3020000; Fitting Position: Front Axle		11.0101-5407.2 260011	Brake System: ATE
		Construction year from: 01/99 →; Fitting Position: Front Axle		11.0101-5407.2 260011	Brake System: ATE
		→ Construction year to: 12/98; Fitting Position: Front Axle		11.0101-5407.2 260011	Brake System: ATE
		Vehicle Identification Number from: X3025752 →; Fitting Position: Rear Axle		11.0101-5407.2 260011	Brake System: ATE
2.0 t Biopower	132 09/05→12/09	Construction year from: 06/06 →; Fitting Position: Front Axle		11.0101-5407.2 260011	Brake System: ATE
		Vehicle Identification Number from: X3025752 →; Fitting Position: Rear Axle		11.0101-5407.2 260011	Brake System: ATE
2.0 t BioPower	110 01/06→12/09	Fitting Position: Front Axle		11.0101-5407.2 260011	Brake System: ATE
→					

	kW				
SAAB - 9-5 Estate (YS3E) 10/98→12/09					
Guide Sleeve Kit, brake caliper					
2.3 t BioPower	136 - 11/06→12/09 152	Vehicle Identification Number from: X3025752 →; Fitting Position: Rear Axle		11.0101-5407.2 260011	Brake System: ATE
2.3 t	136 01/01→12/09	→ Construction year to: 12/01; Fitting Position: Front Axle		11.0101-5407.2 260011	Brake System: ATE
		Construction year from: 01/02 →; Fitting Position: Front Axle		11.0101-5407.2 260011	Brake System: ATE
		Fitting Position: Rear Axle		11.0101-5407.2 260011	Brake System: ATE
2.3 t BioPower	154 11/06→12/09	Construction year from: 01/07 →; Fitting Position: Front Axle		11.0101-5407.2 260011	Brake System: ATE
		Vehicle Identification Number from: X3025752 →; Fitting Position: Rear Axle		11.0101-5407.2 260011	Brake System: ATE
2.3 Turbo	162 07/03→12/09	Fitting Position: Front Axle		11.0101-5407.2 260011	Brake System: ATE
		Vehicle Identification Number from: 43510123 →; Fitting Position: Front Axle		11.0101-5407.2 260011	Brake System: ATE
2.3 Turbo	184 09/01→12/09	Construction year from: 01/02 →; Fitting Position: Front Axle		11.0101-5407.2 260011	Brake System: ATE
		→ Construction year to: 12/01; Fitting Position: Front Axle		11.0101-5407.2 260011	Brake System: ATE
		→ Construction year to: 12/01; Fitting Position: Rear Axle		11.0101-5407.2 260011	Brake System: ATE
		Construction year from: 01/02 →; → Vehicle Identification Number to: 53500056; Fitting Position: Rear Axle		11.0101-5407.2 260011	Brake System: ATE
		Vehicle Identification Number from: 53500057 →; Fitting Position: Rear Axle		11.0101-5407.2 260011	Brake System: ATE
		Construction year from: 01/02 →; Fitting Position: Rear Axle		11.0101-5407.2 260011	Brake System: ATE
3.0 TiD	130 07/01→08/05	→ Construction year to: 12/01; Fitting Position: Front Axle		11.0101-5407.2 260011	Brake System: ATE
		Construction year from: 01/02 →; Fitting Position: Front Axle		11.0101-5407.2 260011	Brake System: ATE
		→ Construction year to: 12/01; Fitting Position: Rear Axle		11.0101-5407.2 260011	Brake System: ATE
		Construction year from: 01/02 →; Fitting Position: Rear Axle		11.0101-5407.2 260011	Brake System: ATE
3.0 V6t	147 10/98→08/05	→ Construction year to: 12/01; Fitting Position: Front Axle		11.0101-5407.2 260011	Brake System: ATE
		Construction year from: 01/02 →; Fitting Position: Front Axle		11.0101-5407.2 260011	Brake System: ATE
		→ Construction year to: 12/01; Vehicle Identification Number from: X3025752 →; Fitting Position: Rear Axle		11.0101-5407.2 260011	Brake System: ATE
		Construction year from: 01/02 →; Fitting Position: Rear Axle		11.0101-5407.2 260011	Brake System: ATE
Guide Bolt, brake caliper					
1.9 TiD	110 - 01/06→12/09 129	Required quantity: 2	2	11.8171-0008.1 990049	Brake System: ATE
2.2 TiD	88 03/02→12/09				
2.3 Turbo	169 - 10/99→12/09 224				
2.0 t 2.3 t	110 10/98→12/09 125 10/98→12/09	Construction year from: 01/02 →; Required quantity: 2	2	11.8171-0008.1 990049	Brake System: ATE
		→ Construction year to: 12/98; Required quantity: 2	2	11.8171-0008.1 990049	Brake System: ATE
		Construction year from: 01/99 → → Construction year to: 12/01; Required quantity: 2	2	11.8171-0008.1 990049	Brake System: ATE
		→ Vehicle Identification Number to: X3020000; Required quantity: 2	2	11.8171-0008.1 990049	Brake System: ATE
		→ Construction year to: 12/01; Vehicle Identification Number from: X3020001 →; Required quantity: 2	2	11.8171-0008.1 990049	Brake System: ATE
		Vehicle Identification Number from: X3025752 →; Required quantity: 2	2	11.8171-0008.1 990049	Brake System: ATE
2.0 t	136 07/00→07/01	Required quantity: 2	2	11.8171-0008.1 990049	Brake System: ATE
		Vehicle Identification Number from: X3020001 →; Required quantity: 2	2	11.8171-0008.1 990049	Brake System: ATE
		→ Vehicle Identification Number to: X3020000; Required quantity: 2	2	11.8171-0008.1 990049	Brake System: ATE
2.0 t	141 10/98→07/00	Construction year from: 01/99 →; Required quantity: 2	2	11.8171-0008.1 990049	Brake System: ATE
		→ Construction year to: 12/98; Required quantity: 2	2	11.8171-0008.1 990049	Brake System: ATE
→					

SAAB - 9-5 Estate (YS3E) 10/98→12/09						
Guide Bolt, brake caliper						
2.0 t	141	10/98→07/00	Vehicle Identification Number from: X3020001 →; Required quantity: 2	2	11.8171-0008.1 990049	Brake System: ATE
			→ Vehicle Identification Number to: X3020000; Required quantity: 2	2	11.8171-0008.1 990049	Brake System: ATE
			Vehicle Identification Number from: X3025752 →; Required quantity: 2	2	11.8171-0008.1 990049	Brake System: ATE
2.0 t Biopower	132	09/05→12/09	Construction year from: 06/06 →; Required quantity: 2	2	11.8171-0008.1 990049	Brake System: ATE
			Vehicle Identification Number from: X3025752 →; Required quantity: 2	2	11.8171-0008.1 990049	Brake System: ATE
2.0 t BioPower	110	01/06→12/09	Required quantity: 2	2	11.8171-0008.1 990049	Brake System: ATE
2.3 t BioPower	136 - 152	11/06→12/09	Vehicle Identification Number from: X3025752 →; Required quantity: 2	2	11.8171-0008.1 990049	Brake System: ATE
2.3 t	136	01/01→12/09	→ Construction year to: 12/01; Required quantity: 2	2	11.8171-0008.1 990049	Brake System: ATE
			Construction year from: 01/02 →; Required quantity: 2	2	11.8171-0008.1 990049	Brake System: ATE
			Required quantity: 2	2	11.8171-0008.1 990049	Brake System: ATE
2.3 t BioPower	154	11/06→12/09	Construction year from: 01/07 →; Required quantity: 2	2	11.8171-0008.1 990049	Brake System: ATE
			Vehicle Identification Number from: X3025752 →; Required quantity: 2	2	11.8171-0008.1 990049	Brake System: ATE
2.3 Turbo	162	07/03→12/09	Required quantity: 2	2	11.8171-0008.1 990049	Brake System: ATE
			Vehicle Identification Number from: 43510123 →; Required quantity: 2	2	11.8171-0008.1 990049	Brake System: ATE
2.3 Turbo	184	09/01→12/09	Construction year from: 01/02 →; Required quantity: 2	2	11.8171-0008.1 990049	Brake System: ATE
			→ Construction year to: 12/01; Required quantity: 2	2	11.8171-0008.1 990049	Brake System: ATE
			Construction year from: 01/02 →; → Vehicle Identification Number to: 53500056; Required quantity: 2	2	11.8171-0008.1 990049	Brake System: ATE
			Vehicle Identification Number from: 53500057 →; Required quantity: 2	2	11.8171-0008.1 990049	Brake System: ATE
3.0 TiD	130	07/01→08/05	→ Construction year to: 12/01; Required quantity: 2	2	11.8171-0008.1 990049	Brake System: ATE
			Construction year from: 01/02 →; Required quantity: 2	2	11.8171-0008.1 990049	Brake System: ATE
3.0 V6t	147	10/98→08/05	→ Construction year to: 12/01; Required quantity: 2	2	11.8171-0008.1 990049	Brake System: ATE
			Construction year from: 01/02 →; Required quantity: 2	2	11.8171-0008.1 990049	Brake System: ATE
			→ Construction year to: 12/01; Vehicle Identification Number from: X3025752 →; Required quantity: 2	2	11.8171-0008.1 990049	Brake System: ATE
SAAB - 900 I (AC4, AM4) 01/79→12/93						
Guide Sleeve Kit, brake caliper						
2.0 -16	93	01/89→12/93	→ Construction year to: 08/93;		11.0101-5407.2 260011	Brake System: ATE
2.0 S Turbo-16	104 - 107	07/91→12/93	Fitting Position: Rear Axle			
2.0 Turbo-16 S Cat	129	01/89→12/93				
2.0 c	74	07/82→12/88	Construction year from: 09/87 →;		11.0101-5407.2 260011	Brake System: ATE
2.0 i	81 - 85	11/80→08/90	Fitting Position: Rear Axle			
2.0 Turbo	103 - 110	01/86→12/91				
2.0 Turbo-16 S	129	01/84→12/88				
2.0 Turbo-16	118	11/85→12/93	Construction year from: 09/87 → → Construction year to: 08/93; Fitting Position: Rear Axle		11.0101-5407.2 260011	Brake System: ATE
2.1 -16	100	08/90→12/93	Construction year from: 09/90 → → Construction year to: 12/91; Fitting Position: Rear Axle		11.0101-5407.2 260011	Brake System: ATE
Guide Bolt, brake caliper						
2.0 -16	93	01/89→12/93	→ Construction year to: 08/93;	2	11.8171-0008.1 990049	Brake System: ATE
2.0 S Turbo-16	104 - 107	07/91→12/93	Required quantity: 2; Fitting Position: Rear Axle			
2.0 Turbo-16 S Cat	129	01/89→12/93				
2.0 c	74	07/82→12/88	Construction year from: 09/87 →;	2	11.8171-0008.1 990049	Brake System: ATE
2.0 i	81 - 85	11/80→08/90	Required quantity: 2; Fitting Position: Rear Axle			
2.0 Turbo	103 - 110	01/86→12/91				
2.0 Turbo-16 S	129	01/84→12/88				
→						

	kW				
SAAB - 900 I (AC4, AM4) 01/79→12/93					
Guide Bolt, brake caliper					
2.0 Turbo-16	118	11/85→12/93	Construction year from: 09/87 → → Construction year to: 08/93; Required quantity: 2; Fitting Position: Rear Axle	2	11.8171-0008.1 990049 Brake System: ATE
2.1 -16	100	08/90→12/93	Construction year from: 09/90 → → Construction year to: 12/91; Required quantity: 2; Fitting Position: Rear Axle	2	11.8171-0008.1 990049 Brake System: ATE
SAAB - 900 I Combi Coupe 06/78→06/94					
Guide Sleeve Kit, brake caliper					
2.0 -16	93	01/89→08/92	Fitting Position: Rear Axle		11.0101-5407.2 260011 Brake System: ATE
2.0 S Turbo-16	104	09/91→07/93			
2.0 -16	107	05/91→10/93	→ Construction year to: 08/93;		11.0101-5407.2 260011 Brake System: ATE
2.0 Turbo-16	132	01/93→06/94	Fitting Position: Rear Axle		
2.0 Turbo-16 S Cat	125	01/89→12/93			
2.0 c	74	09/79→12/88	Construction year from: 09/87 → ;		11.0101-5407.2 260011 Brake System: ATE
2.0 i	81 - 85	11/80→08/90	Fitting Position: Rear Axle		
2.0 Turbo	103 - 110	01/86→12/91			
2.0 Turbo-16 S	129	02/84→12/88			
2.0 Turbo-16	118	11/85→06/94	Construction year from: 09/87 → → Construction year to: 08/93; Fitting Position: Rear Axle		11.0101-5407.2 260011 Brake System: ATE
2.1 -16	100	09/90→07/93	→ Construction year to: 12/91; Fitting Position: Rear Axle		11.0101-5407.2 260011 Brake System: ATE
Guide Bolt, brake caliper					
2.0 -16	93	01/89→08/92	Required quantity: 2;	2	11.8171-0008.1 990049 Brake System: ATE
2.0 S Turbo-16	104	09/91→07/93	Fitting Position: Rear Axle		
2.0 -16	107	05/91→10/93	→ Construction year to: 08/93;	2	11.8171-0008.1 990049 Brake System: ATE
2.0 Turbo-16	132	01/93→06/94	Required quantity: 2;		
2.0 Turbo-16 S Cat	125	01/89→12/93	Fitting Position: Rear Axle		
2.0 c	74	09/79→12/88	Construction year from: 09/87 → ;	2	11.8171-0008.1 990049 Brake System: ATE
2.0 i	81 - 85	11/80→08/90	Required quantity: 2; Fitting Position: Rear Axle		
2.0 Turbo	103 - 110	01/86→12/91			
2.0 Turbo-16 S	129	02/84→12/88			
2.0 Turbo-16	118	11/85→06/94	Construction year from: 09/87 → → Construction year to: 08/93; Required quantity: 2; Fitting Position: Rear Axle		11.8171-0008.1 990049 Brake System: ATE
2.1 -16	100	09/90→07/93	→ Construction year to: 12/91; Required quantity: 2; Fitting Position: Rear Axle	2	11.8171-0008.1 990049 Brake System: ATE
SAAB - 900 I Convertible 10/85→12/94					
Guide Sleeve Kit, brake caliper					
2.0	107	05/91→10/93	→ Construction year to: 08/93;		11.0101-5407.2 260011 Brake System: ATE
2.0 -16	93	01/90→06/94	Fitting Position: Rear Axle		
2.0 S Turbo-16	104	09/91→06/94			
2.0 16v	98	04/90→12/90	Fitting Position: Rear Axle		11.0101-5407.2 260011 Brake System: ATE
2.0 Turbo-16	118	11/86→06/94	Construction year from: 09/87 → →		11.0101-5407.2 260011 Brake System: ATE
2.0 Turbo-16 S	129	11/86→06/94	Construction year to: 08/93; Fitting Position: Rear Axle		
2.1 -16	100	08/90→06/94	Construction year from: 09/90 → → Construction year to: 12/91; Fitting Position: Rear Axle		11.0101-5407.2 260011 Brake System: ATE
Guide Bolt, brake caliper					
2.0	107	05/91→10/93	→ Construction year to: 08/93;	2	11.8171-0008.1 990049 Brake System: ATE
2.0 -16	93	01/90→06/94	Required quantity: 2;		
2.0 S Turbo-16	104	09/91→06/94	Fitting Position: Rear Axle		
2.0 16v	98	04/90→12/90	Required quantity: 2; Fitting Position: Rear Axle	2	11.8171-0008.1 990049 Brake System: ATE
2.0 Turbo-16	118	11/86→06/94	Construction year from: 09/87 → →	2	11.8171-0008.1 990049 Brake System: ATE
2.0 Turbo-16 S	129	11/86→06/94	Construction year to: 08/93; Required quantity: 2; Fitting Position: Rear Axle		
2.1 -16	100	08/90→06/94	Construction year from: 09/90 → → Construction year to: 12/91; Required quantity: 2; Fitting Position: Rear Axle	2	11.8171-0008.1 990049 Brake System: ATE





	kW				
SAAB - 900 II 07/93→04/99					
Guide Sleeve Kit, brake caliper					
2.0 -16 Turbo 2.3 -16 2.5 -24 V6	136 07/93→02/98 110 07/93→02/98 125 07/93→02/98	Construction year from: 09/93 → → Construction year to: 08/96; Fitting Position: Front Axle		11.0101-5407.2 260011	Brake System: ATE
		Construction year from: 09/96 → ; Fitting Position: Front Axle		11.0101-5407.2 260011	Brake System: ATE
2.0 i	96 08/94→02/98	→ Construction year to: 08/96; Fitting Position: Front Axle		11.0101-5407.2 260011	Brake System: ATE
		Construction year from: 09/96 → ; Fitting Position: Front Axle		11.0101-5407.2 260011	Brake System: ATE
2.0 i	98 07/93→07/94	Construction year from: 09/93 → ; Fitting Position: Front Axle		11.0101-5407.2 260011	Brake System: ATE
Guide Bolt, brake caliper					
2.0 -16 Turbo 2.3 -16 2.5 -24 V6	136 07/93→02/98 110 07/93→02/98 125 07/93→02/98	Construction year from: 09/93 → → Construction year to: 08/96; Required quantity: 2	2	11.8171-0008.1 990049	Brake System: ATE
		Construction year from: 09/96 → ; Required quantity: 2	2	11.8171-0008.1 990049	Brake System: ATE
2.0 i	96 08/94→02/98	→ Construction year to: 08/96; Required quantity: 2	2	11.8171-0008.1 990049	Brake System: ATE
		Construction year from: 09/96 → ; Required quantity: 2	2	11.8171-0008.1 990049	Brake System: ATE
2.0 i	98 07/93→07/94	Construction year from: 09/93 → ; Required quantity: 2	2	11.8171-0008.1 990049	Brake System: ATE
SAAB - 900 II Convertible 09/93→04/99					
Guide Sleeve Kit, brake caliper					
2.0 -16 Turbo 2.0 i 2.3 -16 2.5 -24 V6	136 12/93→02/98 96 12/93→02/98 110 12/93→02/98 125 12/93→02/98	→ Construction year to: 08/96; Fitting Position: Front Axle		11.0101-5407.2 260011	Brake System: ATE
		Construction year from: 09/96 → ; Fitting Position: Front Axle		11.0101-5407.2 260011	Brake System: ATE
Guide Bolt, brake caliper					
2.0 -16 Turbo 2.0 i 2.3 -16 2.5 -24 V6	136 12/93→02/98 96 12/93→02/98 110 12/93→02/98 125 12/93→02/98	→ Construction year to: 08/96; Required quantity: 2	2	11.8171-0008.1 990049	Brake System: ATE
		Construction year from: 09/96 → ; Required quantity: 2	2	11.8171-0008.1 990049	Brake System: ATE
SAAB - 900 II Coupe 12/93→04/99					
Guide Sleeve Kit, brake caliper					
2.0 -16 Turbo 2.0 i 2.3 -16 2.5 -24 V6	136 12/93→02/98 96 08/94→02/98 110 12/93→02/98 125 12/93→02/98	→ Construction year to: 08/96; Fitting Position: Front Axle		11.0101-5407.2 260011	Brake System: ATE
		Construction year from: 09/96 → ; Fitting Position: Front Axle		11.0101-5407.2 260011	Brake System: ATE
2.0 i	98 12/93→07/94	Fitting Position: Front Axle		11.0101-5407.2 260011	Brake System: ATE
Guide Bolt, brake caliper					
2.0 -16 Turbo 2.0 i 2.3 -16 2.5 -24 V6	136 12/93→02/98 96 08/94→02/98 110 12/93→02/98 125 12/93→02/98	→ Construction year to: 08/96; Required quantity: 2	2	11.8171-0008.1 990049	Brake System: ATE
		Construction year from: 09/96 → ; Required quantity: 2	2	11.8171-0008.1 990049	Brake System: ATE
2.0 i	98 12/93→07/94	Required quantity: 2	2	11.8171-0008.1 990049	Brake System: ATE
SAAB - 9000 04/85→12/98					
Guide Sleeve Kit, brake caliper					
2.0 -16	94 01/89→01/93	Construction year from: 09/89 → ; Fitting Position: Front Axle		11.0101-5407.2 260011	Brake System: ATE
		Fitting Position: Rear Axle		11.0101-5407.2 260011	Brake System: ATE
2.0 -16 CD	96 - 09/93→12/98 110	→ Construction year to: 05/98; Fitting Position: Front Axle		11.0101-5407.2 260011	Brake System: ATE
2.3 -16 CDE 2.3 -16 CDE Eco-Power	108 09/93→12/98 125 09/93→12/98	→ Construction year to: 05/98; Fitting Position: Rear Axle		11.0101-5407.2 260011	Brake System: ATE
2.0 -16 Turbo	118 05/88→08/93	Fitting Position: Front Axle		11.0101-5407.2 260011	Brake System: ATE
2.0 -16 Turbo CD 2.3 -16 Turbo	120 09/88→08/93 143 09/90→12/98	Fitting Position: Rear Axle		11.0101-5407.2 260011	Brake System: ATE
2.0 -16 Turbo	127 03/90→09/93	Construction year from: 09/93 → ; Fitting Position: Front Axle		11.0101-5407.2 260011	Brake System: ATE
		Construction year from: 09/93 → ; Fitting Position: Rear Axle		11.0101-5407.2 260011	Brake System: ATE
2.0 -16 Turbo	129 04/85→12/91	Construction year from: 09/87 → ; Fitting Position: Front Axle		11.0101-5407.2 260011	Brake System: ATE
		Fitting Position: Rear Axle		11.0101-5407.2 260011	Brake System: ATE
→					

	kW				
SAAB - 9000 04/85→12/98					
Guide Sleeve Kit, brake caliper					
2.0 -16 Turbo CD	108 - 09/89→12/98 136		Construction year from: 09/93 → → Construction year to: 05/98; Fitting Position: Front Axle	2	11.0101-5407.2 260011 Brake System: ATE
			→ Construction year to: 08/93; Fitting Position: Front Axle		
			Construction year from: 09/93 → → Construction year to: 05/98; Fitting Position: Rear Axle		
			→ Construction year to: 08/93; Fitting Position: Rear Axle		
2.3 -16 CD	107 08/89→12/98		Construction year from: 09/89 → → Construction year to: 08/93; Fitting Position: Front Axle	2	11.0101-5407.2 260011 Brake System: ATE
			Construction year from: 09/89 → → Construction year to: 08/93; Fitting Position: Rear Axle		
2.3 -16 CD Turbo	147 07/90→12/98		Construction year from: 09/93 → → Construction year to: 05/98; Fitting Position: Front Axle	2	11.0101-5407.2 260011 Brake System: ATE
			Construction year from: 09/93 → → Construction year to: 05/98; Fitting Position: Rear Axle		
3.0 -24 V6 CD/CDE	155 07/94→12/98		Construction year from: 09/94 → → Construction year to: 05/98; Fitting Position: Front Axle	2	11.0101-5407.2 260011 Brake System: ATE
			Construction year from: 09/94 → → Construction year to: 05/98; Fitting Position: Rear Axle		
Guide Bolt, brake caliper					
2.0 -16	94 01/89→01/93		Construction year from: 09/89 → ; Required quantity: 2; Fitting Position: Front Axle	2	11.8171-0008.1 990049 Brake System: ATE
			Required quantity: 2; Fitting Position: Rear Axle		
2.0 -16 CD	96 - 09/93→12/98 110		→ Construction year to: 05/98; Required quantity: 2; Fitting Position: Front Axle	2	11.8171-0008.1 990049 Brake System: ATE
2.3 -16 CDE	108 09/93→12/98		→ Construction year to: 05/98; Required quantity: 2; Fitting Position: Rear Axle	2	11.8171-0008.1 990049 Brake System: ATE
2.3 -16 CDE Eco-Power	125 09/93→12/98				
2.0 -16 Turbo	118 05/88→08/93		Required quantity: 2; Fitting Position: Front Axle	2	11.8171-0008.1 990049 Brake System: ATE
2.0 -16 Turbo CD	120 09/88→08/93		Required quantity: 2; Fitting Position: Rear Axle	2	11.8171-0008.1 990049 Brake System: ATE
2.3 -16 Turbo	143 09/90→12/98				
2.0 -16 Turbo	127 03/90→09/93		Construction year from: 09/93 → ; Required quantity: 2; Fitting Position: Front Axle	2	11.8171-0008.1 990049 Brake System: ATE
			Construction year from: 09/93 → ; Required quantity: 2; Fitting Position: Rear Axle		
2.0 -16 Turbo	129 04/85→12/91		Construction year from: 09/87 → ; Required quantity: 2; Fitting Position: Front Axle	2	11.8171-0008.1 990049 Brake System: ATE
			Required quantity: 2; Fitting Position: Rear Axle		
2.0 -16 Turbo CD	108 - 09/89→12/98 136		Construction year from: 09/93 → → Construction year to: 05/98; Required quantity: 2; Fitting Position: Front Axle	2	11.8171-0008.1 990049 Brake System: ATE
			→ Construction year to: 08/93; Required quantity: 2; Fitting Position: Front Axle		
			Construction year from: 09/93 → → Construction year to: 05/98; Required quantity: 2; Fitting Position: Rear Axle		
			→ Construction year to: 08/93; Required quantity: 2; Fitting Position: Rear Axle		
2.3 -16 CD	107 08/89→12/98		Construction year from: 09/89 → → Construction year to: 08/93; Required quantity: 2; Fitting Position: Front Axle	2	11.8171-0008.1 990049 Brake System: ATE
			Construction year from: 09/89 → → Construction year to: 08/93; Required quantity: 2; Fitting Position: Rear Axle		



→



SAAB - 9000 04/85→12/98							
Guide Bolt, brake caliper							
2.3 -16 CD Turbo	147 07/90→12/98	Construction year from: 09/93 → → Construction year to: 05/98; Required quantity: 2; Fitting Position: Front Axle	2	11.8171-0008.1	990049	Brake System: ATE	
		Construction year from: 09/93 → → Construction year to: 05/98; Required quantity: 2; Fitting Position: Rear Axle	2	11.8171-0008.1	990049	Brake System: ATE	
3.0 -24 V6 CD/CDE	155 07/94→12/98	Construction year from: 09/94 → → Construction year to: 05/98; Required quantity: 2; Fitting Position: Front Axle	2	11.8171-0008.1	990049	Brake System: ATE	
		Construction year from: 09/94 → → Construction year to: 05/98; Required quantity: 2; Fitting Position: Rear Axle	2	11.8171-0008.1	990049	Brake System: ATE	
SAAB - 9000 Hatchback 09/84→12/98							
Guide Sleeve Kit, brake caliper							
2.0 -16	92 - 12/85→12/88 94	Fitting Position: Rear Axle		11.0101-5407.2	260011	Brake System: ATE	
2.0 -16 CS	94 01/89→12/98	Construction year from: 09/89 → → Construction year to: 08/93; Fitting Position: Front Axle		11.0101-5407.2	260011	Brake System: ATE	
		→ Construction year to: 08/93; Fitting Position: Rear Axle		11.0101-5407.2	260011	Brake System: ATE	
2.0 -16 CS	96 09/93→12/98	→ Construction year to: 05/98;		11.0101-5407.2	260011	Brake System: ATE	
2.0 -16 ND Turbo	110 09/93→12/98	Fitting Position: Front Axle		11.0101-5407.2	260011	Brake System: ATE	
2.3 -16 CSE	108 09/93→12/98	→ Construction year to: 05/98;		11.0101-5407.2	260011	Brake System: ATE	
2.3 -16 CSE Eco Power	125 09/93→12/98	Fitting Position: Rear Axle		11.0101-5407.2	260011	Brake System: ATE	
2.3 -16 Turbo CSE	147 09/93→12/98			11.0101-5407.2	260011	Brake System: ATE	
2.0 -16 Turbo	118 - 09/84→08/93 129	Construction year from: 09/87 → →; Fitting Position: Front Axle		11.0101-5407.2	260011	Brake System: ATE	
		Fitting Position: Rear Axle		11.0101-5407.2	260011	Brake System: ATE	
2.0 -16 Turbo	120 - 05/88→08/93 127	Fitting Position: Front Axle		11.0101-5407.2	260011	Brake System: ATE	
		Fitting Position: Rear Axle		11.0101-5407.2	260011	Brake System: ATE	
2.0 -16 Turbo CS	136 09/88→12/98	Construction year from: 09/93 → → Construction year to: 05/98; Fitting Position: Front Axle		11.0101-5407.2	260011	Brake System: ATE	
		→ Construction year to: 08/93; Fitting Position: Front Axle		11.0101-5407.2	260011	Brake System: ATE	
		Construction year from: 09/93 → → Construction year to: 05/98; Fitting Position: Rear Axle		11.0101-5407.2	260011	Brake System: ATE	
		→ Construction year to: 08/93; Fitting Position: Rear Axle		11.0101-5407.2	260011	Brake System: ATE	
2.3 -16 Aero CS	162 - 02/93→12/98 165	Construction year from: 09/93 → → Construction year to: 05/98;		11.0101-5407.2	260011	Brake System: ATE	
2.3 -16 Turbo	143 09/90→12/98	Fitting Position: Front Axle		11.0101-5407.2	260011	Brake System: ATE	
		Construction year from: 09/93 → → Construction year to: 05/98; Fitting Position: Rear Axle		11.0101-5407.2	260011	Brake System: ATE	
2.3 -16 CS	107 09/89→12/98	→ Construction year to: 08/93; Fitting Position: Front Axle		11.0101-5407.2	260011	Brake System: ATE	
		→ Construction year to: 08/93; Fitting Position: Rear Axle		11.0101-5407.2	260011	Brake System: ATE	
3.0 -24 V6 CS/CSE	155 07/94→12/98	Construction year from: 09/94 → → Construction year to: 05/98; Fitting Position: Front Axle		11.0101-5407.2	260011	Brake System: ATE	
		Construction year from: 09/94 → → Construction year to: 05/98; Fitting Position: Rear Axle		11.0101-5407.2	260011	Brake System: ATE	
Guide Bolt, brake caliper							
2.0 -16	92 - 12/85→12/88 94	Required quantity: 2; Fitting Position: Rear Axle	2	11.8171-0008.1	990049	Brake System: ATE	
2.0 -16 CS	94 01/89→12/98	Construction year from: 09/89 → → Construction year to: 08/93; Required quantity: 2; Fitting Position: Front Axle	2	11.8171-0008.1	990049	Brake System: ATE	
		→ Construction year to: 08/93; Required quantity: 2; Fitting Position: Rear Axle	2	11.8171-0008.1	990049	Brake System: ATE	
2.0 -16 CS	96 09/93→12/98	→ Construction year to: 05/98;	2	11.8171-0008.1	990049	Brake System: ATE	
2.0 -16 ND Turbo	110 09/93→12/98	Required quantity: 2;		11.8171-0008.1	990049	Brake System: ATE	
2.3 -16 CSE	108 09/93→12/98	Fitting Position: Front Axle		11.8171-0008.1	990049	Brake System: ATE	
2.3 -16 CSE Eco Power	125 09/93→12/98			11.8171-0008.1	990049	Brake System: ATE	
→				11.8171-0008.1	990049	Brake System: ATE	



	kW				
SAAB - 9000 Hatchback 09/84→12/98					
Guide Bolt, brake caliper					
2.3 -16 Turbo CSE	147	09/93→12/98	→ Construction year to: 05/98; Required quantity: 2; Fitting Position: Rear Axle	2	11.8171-0008.1 990049 Brake System: ATE
2.0 -16 Turbo	118 -	09/84→08/93 129	Construction year from: 09/87 → ; Required quantity: 2; Fitting Position: Front Axle	2	11.8171-0008.1 990049 Brake System: ATE
			Required quantity: 2; Fitting Position: Rear Axle	2	11.8171-0008.1 990049 Brake System: ATE
2.0 -16 Turbo	120 -	05/88→08/93 127	Required quantity: 2; Fitting Position: Front Axle	2	11.8171-0008.1 990049 Brake System: ATE
			Required quantity: 2; Fitting Position: Rear Axle	2	11.8171-0008.1 990049 Brake System: ATE
2.0 -16 Turbo CS	136	09/88→12/98	Construction year from: 09/93 → → Construction year to: 05/98; Required quantity: 2; Fitting Position: Front Axle	2	11.8171-0008.1 990049 Brake System: ATE
			→ Construction year to: 08/93; Required quantity: 2; Fitting Position: Front Axle	2	11.8171-0008.1 990049 Brake System: ATE
			Construction year from: 09/93 → → Construction year to: 05/98; Required quantity: 2; Fitting Position: Rear Axle	2	11.8171-0008.1 990049 Brake System: ATE
			→ Construction year to: 08/93; Required quantity: 2; Fitting Position: Rear Axle	2	11.8171-0008.1 990049 Brake System: ATE
2.3 -16 Aero CS	162 -	02/93→12/98 165	Construction year from: 09/93 → → Construction year to: 05/98; Required quantity: 2; Fitting Position: Front Axle	2	11.8171-0008.1 990049 Brake System: ATE
2.3 -16 Turbo	143	09/90→12/98	Construction year from: 09/93 → → Construction year to: 05/98; Required quantity: 2; Fitting Position: Rear Axle	2	11.8171-0008.1 990049 Brake System: ATE
2.3 -16 CS	107	09/89→12/98	→ Construction year to: 08/93; Required quantity: 2; Fitting Position: Front Axle	2	11.8171-0008.1 990049 Brake System: ATE
			→ Construction year to: 08/93; Required quantity: 2; Fitting Position: Rear Axle	2	11.8171-0008.1 990049 Brake System: ATE
3.0 -24 V6 CS/CSE	155	07/94→12/98	Construction year from: 09/94 → → Construction year to: 05/98; Required quantity: 2; Fitting Position: Front Axle	2	11.8171-0008.1 990049 Brake System: ATE
			Construction year from: 09/94 → → Construction year to: 05/98; Required quantity: 2; Fitting Position: Rear Axle	2	11.8171-0008.1 990049 Brake System: ATE
SEAT - ALHAMBRA (7V8, 7V9) 04/96→03/10					
Guide Bolt, brake caliper					
1.8 T 20V	110	10/97→03/10	Construction year from: 05/98 → ; → Vehicle Identification Number to: 7M-1-530756; Required quantity: 2	2	11.8171-0008.1 990049 Brake System: ATE
1.9 TDI	66 -	04/96→03/10 85	→ Vehicle Identification Number to: 7M-1-530756; Required quantity: 2	2	11.8171-0008.1 990049 Brake System: ATE
2.0 i	85	04/96→03/10			
1.9 TDI	81	08/96→06/00	Construction year from: 10/97 → ; → Vehicle Identification Number to: 7M-1-530756; Required quantity: 2	2	11.8171-0008.1 990049 Brake System: ATE
SEAT - ALHAMBRA (710, 711) 06/10→					
Guide Bolt, brake caliper					
1.4 TSI	110	06/10→04/15	for PR number: 1LJ; Required quantity: 2	2	11.8171-0008.1 990049 Brake System: ATE
1.8 TSI	118	11/12→04/15			
2.0 TDI	85 -	06/10→ 130			
2.0 TDI 4Drive	103	05/11→04/15			
2.0 TFSI	147	11/10→05/12			
Brake Disc					
1.4 TSI	110	06/10→04/15	for PR number: 1LJ; Fitting Position: Front Axle	24.0125-0158.1 425158	Outer diameter [mm]: 312 Brake Disc Thickness [mm] 25 Minimum thickness [mm] 22 Brake Disc Type: Vented Supplementary Article/Info 2: with bolts/screws
2.0 TDI	85 -	06/10→ 130			
2.0 TDI 4Drive	103	05/11→04/15			
2.0 TFSI	147	11/10→05/12			
→					

	kW				
SEAT - ALHAMBRA (710, 711) 06/10→					
 Brake Disc					
1.4 TSI 2.0 TDI 2.0 TDI 4Drive 2.0 TFSI	110 06/10→04/15 85 - 06/10→ 130 103 05/11→04/15 147 11/10→05/12	for PR number: 1LJ; Fitting Position: Front Axle	24.0325-0158.1 525158	Outer diameter [mm]: 312 Brake Disc Thickness [mm] 25 Minimum thickness [mm] 22 Brake Disc Type: Vented Supplementary Article/Info 2: with bolts/screws	
1.4 TSI 2.0 TDI 2.0 TDi 4Drive 2.0 TDI 4Drive 2.0 TSI	110 05/15→ 110 - 05/15→ 135 130 11/18→ 110 - 05/15→ 135 162 05/15→	Vehicle Equipment: for vehicles with electric parking brake; Fitting Position: Rear Axle	24.0112-0210.1 412210	Outer diameter [mm]: 300 Brake Disc Thickness [mm] 12 Minimum thickness [mm] 10 Brake Disc Type: Solid Supplementary Article/Info 2: with bolts/screws	
1.8 TSI	118 11/12→04/15	for PR number: 1LJ; Fitting Position: Front Axle	24.0125-0158.1 425158	Outer diameter [mm]: 312 Brake Disc Thickness [mm] 25 Minimum thickness [mm] 22 Brake Disc Type: Vented Supplementary Article/Info 2: with bolts/screws	
 Wheel Speed Sensor					
2.0 TDi 4Drive 2.0 TDI 4Drive	130 11/18→ 103 - 05/11→ 135	for PR number: 7X0 / 7X2 / 7X5 / 7Y8 / 7Y9; Fitting Position: Rear Axle Left	24.0711-5401.3 360330		
		for PR number: 7X0 / 7X2 / 7X5 / 7Y8 / 7Y9; Fitting Position: Rear Axle Right	24.0711-5402.3 360331		
SEAT - ALHAMBRA VAN (711) 06/10→					
 Brake Disc					
TDI TDI 4Drive Tsi	110 - 05/15→ 135 110 05/15→ 110 05/15→	Vehicle Equipment: for vehicles with electric parking brake; Fitting Position: Rear Axle	24.0112-0210.1 412210	Outer diameter [mm]: 300 Brake Disc Thickness [mm] 12 Minimum thickness [mm] 10 Brake Disc Type: Solid Supplementary Article/Info 2: with bolts/screws	
 Wheel Speed Sensor					
TDI 4Drive	110 05/15→	for PR number: 7X0 / 7X2 / 7X5 / 7Y8 / 7Y9; Fitting Position: Rear Axle Left	24.0711-5401.3 360330		
		for PR number: 7X0 / 7X2 / 7X5 / 7Y8 / 7Y9; Fitting Position: Rear Axle Right	24.0711-5402.3 360331		
SEAT - ALTEA (5P1) 03/04→					
Guide Bolt, brake caliper					
1.2 TSI 1.4 16V 1.4 TSI 1.6 1.6 LPG 1.6 Multifuel 1.6 TDI 1.8 TFSI 1.9 TDI 2.0 FSI 2.0 TDI 2.0 TDI 16V 2.0 TDI 16V 4WD 2.0 TFSI	77 04/10→ 63 05/06→ 92 11/07→ 75 03/04→ 75 09/09→ 75 11/10→05/11 66 - 10/09→ 77 118 01/07→ 66 - 04/04→ 77 110 05/04→03/09 100 - 03/04→ 125 103 03/04→ 103 10/10→ 147 04/06→05/09	for PR number: 1ZE; Required quantity: 2 for PR number: 1ZA / 1LJ; Required quantity: 2	2 2	11.8171-0008.1 990049 11.8171-0008.1 990049	Brake System: ATE Brake System: ATE
 Brake Disc					
1.2 TSI 1.4 16V 1.4 TSI 1.6 1.6 LPG 1.6 TDI 1.8 TFSI 1.9 TDI 2.0 FSI 2.0 TDI 2.0 TDI 16V 2.0 TFSI	77 04/10→ 63 05/06→ 92 11/07→ 75 03/04→ 75 09/09→ 66 - 10/09→ 77 118 01/07→ 66 - 04/04→ 77 110 05/04→03/09 100 - 03/04→ 125 103 03/04→ 147 04/06→05/09	for PR number: 1ZE; Fitting Position: Front Axle for PR number: 1LJ / 1ZA; Fitting Position: Front Axle	24.0125-0145.1 425145 24.0125-0158.1 425158	Outer diameter [mm]: 288 Brake Disc Thickness [mm] 25 Minimum thickness [mm] 22 Brake Disc Type: Vented Supplementary Article/Info 2: with bolts/screws Outer diameter [mm]: 312 Brake Disc Thickness [mm] 25 Minimum thickness [mm] 22 Brake Disc Type: Vented Supplementary Article/Info 2: with bolts/screws	



	kW				
SEAT - ALTEA (5P1) 03/04→					
 Brake Disc					
1.2 TSI 1.4 16V 1.4 TSI 1.6 1.6 LPG 1.6 TDI	77 04/10→ 63 05/06→ 92 11/07→ 75 03/04→ 75 09/09→ 66 - 10/09→		for PR number: 1LJ / 1ZA; Fitting Position: Front Axle	24.0325-0158.1 525158	Outer diameter [mm]: 312 Brake Disc Thickness [mm] 25 Minimum thickness [mm] 22 Brake Disc Type: Vented Supplementary Article/Info 2: with bolts/screws
1.8 TFSI 1.9 TDI 2.0 FSI 2.0 TDI 2.0 TDI 16V 2.0 TFSI	77 118 01/07→ 66 - 04/04→ 77 110 05/04→03/09 100 - 03/04→ 125 103 03/04→ 147 04/06→05/09		for PR number: 1KS; Fitting Position: Rear Axle	24.0110-0356.1 410356	Outer diameter [mm]: 272 Brake Disc Thickness [mm] 9.7 Minimum thickness [mm] 8 Brake Disc Type: Solid Supplementary Article/Info 2: with bolts/screws
1.6 Multifuel 2.0 TDI 16V 4WD	75 11/10→05/11 103 10/10→		for PR number: 1ZE; Fitting Position: Front Axle	24.0125-0145.1 425145	Outer diameter [mm]: 288 Brake Disc Thickness [mm] 25 Minimum thickness [mm] 22 Brake Disc Type: Vented Supplementary Article/Info 2: with bolts/screws
			for PR number: 1LJ / 1ZA; Fitting Position: Front Axle	24.0125-0158.1 425158	Outer diameter [mm]: 312 Brake Disc Thickness [mm] 25 Minimum thickness [mm] 22 Brake Disc Type: Vented Supplementary Article/Info 2: with bolts/screws
			for PR number: 1KS; Fitting Position: Rear Axle	24.0110-0356.1 410356	Outer diameter [mm]: 272 Brake Disc Thickness [mm] 9.7 Minimum thickness [mm] 8 Brake Disc Type: Solid Supplementary Article/Info 2: with bolts/screws
				24.0310-0356.1 510356	Outer diameter [mm]: 272 Brake Disc Thickness [mm] 9.7 Minimum thickness [mm] 8 Brake Disc Type: Solid Supplementary Article/Info 2: with bolts/screws
SEAT - ALTEA XL (5P5, 5P8) 10/06→					
Guide Bolt, brake caliper					
1.2 TSI 1.4 TSI 1.6 1.6 LPG 1.6 Multifuel 1.6 TDI	77 04/10→ 92 11/07→ 75 10/06→ 75 09/09→ 75 10/06→11/10 66 - 10/09→		for PR number: 1ZE; Required quantity: 2	2 11.8171-0008.1 990049	Brake System: ATE
1.8 TFSI 1.9 TDI 1.9 TDI 4x4 2.0 FSI 2.0 TDI 2.0 TDI 16V 2.0 TDI 16V 4x4 2.0 TDI 4x4	77 118 01/07→ 66 - 10/06→12/10 77 77 06/09→12/10 110 10/06→03/09 100 - 10/06→ 125 103 10/06→ 103 10/10→ 103 - 06/07→ 125		for PR number: 1ZA / 1LJ; Required quantity: 2	2 11.8171-0008.1 990049	Brake System: ATE
2.0 TDI 16V 2.0 TFSI 2.0 TFSI 4x4	103 10/06→ 147 10/06→05/09 147 06/07→05/09				
1.4 16V	63 10/06→		Construction year from: 05/08 →; for PR number: 1ZE; Required quantity: 2	2 11.8171-0008.1 990049	Brake System: ATE
			Construction year from: 05/08 →; for PR number: 1ZA / 1LJ; Required quantity: 2	2 11.8171-0008.1 990049	Brake System: ATE
2.0 TFSI 2.0 TFSI 4x4	155 05/09→ 155 05/09→		for PR number: 1ZA / 1ZE / 1LJ; Required quantity: 2; Fitting Position: Front Axle	2 11.8171-0008.1 990049	Brake System: ATE
→					

	kW				
SEAT - ALTEA XL (5P5, 5P8) 10/06→					
 Brake Disc					
1.2 TSI 1.4 TSI 1.6 1.6 LPG 1.6 Multifuel 1.6 TDI	77 04/10→ 92 11/07→ 75 10/06→ 75 09/09→ 75 10/06→11/10 66 - 10/09→ 77	for PR number: 1ZE; Fitting Position: Front Axle		24.0125-0145.1 425145	Outer diameter [mm]: 288 Brake Disc Thickness [mm] 25 Minimum thickness [mm] 22 Brake Disc Type: Vented Supplementary Article/Info 2: with bolts/screws
1.8 TFSI 1.9 TDI 1.9 TDI 4x4 2.0 FSI 2.0 TDI	118 01/07→ 66 - 10/06→12/10 77 77 06/09→12/10 110 10/06→03/09 100 - 10/06→ 125	for PR number: 1LJ / 1ZA; Fitting Position: Front Axle		24.0125-0158.1 425158	Outer diameter [mm]: 312 Brake Disc Thickness [mm] 25 Minimum thickness [mm] 22 Brake Disc Type: Vented Supplementary Article/Info 2: with bolts/screws
2.0 TDI 16V 2.0 TDI 16V 4x4 2.0 TDI 4x4 2.0 TFSI 2.0 TFSI 4x4	103 10/06→ 103 10/10→ 103 - 06/07→ 125 147 - 10/06→ 155 147 - 06/07→ 155			24.0325-0158.1 525158	Outer diameter [mm]: 312 Brake Disc Thickness [mm] 25 Minimum thickness [mm] 22 Brake Disc Type: Vented Supplementary Article/Info 2: with bolts/screws
		for PR number: 1KS; Fitting Position: Rear Axle		24.0110-0356.1 410356	Outer diameter [mm]: 272 Brake Disc Thickness [mm] 9.7 Minimum thickness [mm] 8 Brake Disc Type: Solid Supplementary Article/Info 2: with bolts/screws
				24.0310-0356.1 510356	Outer diameter [mm]: 272 Brake Disc Thickness [mm] 9.7 Minimum thickness [mm] 8 Brake Disc Type: Solid Supplementary Article/Info 2: with bolts/screws
1.4 16V	63 10/06→	Construction year from: 05/08 →; for PR number: 1ZE; Fitting Position: Front Axle		24.0125-0145.1 425145	Outer diameter [mm]: 288 Brake Disc Thickness [mm] 25 Minimum thickness [mm] 22 Brake Disc Type: Vented Supplementary Article/Info 2: with bolts/screws
		Construction year from: 05/08 →; for PR number: 1LJ / 1ZA; Fitting Position: Front Axle		24.0125-0158.1 425158	Outer diameter [mm]: 312 Brake Disc Thickness [mm] 25 Minimum thickness [mm] 22 Brake Disc Type: Vented Supplementary Article/Info 2: with bolts/screws
		Construction year from: 05/08 →; for PR number: 1KS; Fitting Position: Rear Axle		24.0110-0356.1 410356	Outer diameter [mm]: 272 Brake Disc Thickness [mm] 9.7 Minimum thickness [mm] 8 Brake Disc Type: Solid Supplementary Article/Info 2: with bolts/screws
				24.0310-0356.1 510356	Outer diameter [mm]: 272 Brake Disc Thickness [mm] 9.7 Minimum thickness [mm] 8 Brake Disc Type: Solid Supplementary Article/Info 2: with bolts/screws
SEAT - ARONA (KJ7, KJP) 07/17→					
 Wheel Speed Sensor					
1.0 TGI 1.0 TSI	66 11/18→ 70 - 07/17→ 85	→ Construction year to: 11/19; Fitting Position: Front Axle Left		24.0711-5273.3 360303	
1.5 TSI 1.6 SRE 1.6 TDI	110 07/17→ 81 07/17→ 70 - 07/17→ 85	→ Construction year to: 11/19; Fitting Position: Front Axle Right		24.0711-5274.3 360304	
SEAT - ATECA (KH7, KHP) 04/16→					
 Brake Caliper					
1.0 TSI 1.4 TSI 1.4 TSI 4Drive 1.5 TSI	81 - 05/16→ 85 110 06/16→ 110 06/16→ 110 07/18→	for PR number: 1ZA; Fitting Position: Front Axle Left		24.3571-1801.5 241387	Supplementary Article/Supplementary Info: without holder Brake Caliper Type: Fist-type Caliper



		kW					
SEAT - ATECA (KH7, KHP) 04/16→							
 Brake Caliper							
1.5 TSI 4Drive	110 07/18→	for PR number: 1ZA; Fitting Position: Front Axle Right	24.3571-1802.5	241388	Supplementary Article/Supplementary Info: without holder Brake Caliper Type: Fist-type Caliper		
1.6 TDI	85 04/16→07/18						
2.0 TDI	81 - 04/16→						
	110						
2.0 TDI 4Drive	110 - 04/16→						
	140						
2.0 TSI 4Drive	140 05/17→						
 Brake Disc							
1.0 TSI	81 - 05/16→	for PR number: 1ZE / 1ZJ; Fitting Position: Front Axle	24.0125-0145.1	425145	Outer diameter [mm]: 288 Brake Disc Thickness [mm] 25 Minimum thickness [mm] 22 Brake Disc Type: Vented Supplementary Article/Info 2: with bolts/screws		
	85						
1.4 TSI	110 06/16→	for PR number: 1ZA; Fitting Position: Front Axle	24.0125-0158.1	425158	Outer diameter [mm]: 312 Brake Disc Thickness [mm] 25 Minimum thickness [mm] 22 Brake Disc Type: Vented Supplementary Article/Info 2: with bolts/screws		
1.5 TSI	110 07/18→						
1.6 TDI	85 04/16→07/18						
2.0 TDI	81 - 04/16→						
	110						
		for PR number: 1KE / 2EJ; Fitting Position: Rear Axle	24.0110-0356.1	410356	Outer diameter [mm]: 272 Brake Disc Thickness [mm] 9.7 Minimum thickness [mm] 8 Brake Disc Type: Solid Supplementary Article/Info 2: with bolts/screws		
		for PR number: 1KE / 2EJ; Fitting Position: Rear Axle	24.0310-0356.1	510356	Outer diameter [mm]: 272 Brake Disc Thickness [mm] 9.7 Minimum thickness [mm] 8 Brake Disc Type: Solid Supplementary Article/Info 2: with bolts/screws		
1.4 TSI 4Drive	110 06/16→	for PR number: 1ZE / 1ZJ; Fitting Position: Front Axle	24.0125-0145.1	425145	Outer diameter [mm]: 288 Brake Disc Thickness [mm] 25 Minimum thickness [mm] 22 Brake Disc Type: Vented Supplementary Article/Info 2: with bolts/screws		
1.5 TSI 4Drive	110 07/18→						
2.0 TDI 4Drive	140 06/16→	for PR number: 1ZA; Fitting Position: Front Axle	24.0125-0158.1	425158	Outer diameter [mm]: 312 Brake Disc Thickness [mm] 25 Minimum thickness [mm] 22 Brake Disc Type: Vented Supplementary Article/Info 2: with bolts/screws		
2.0 TSI 4Drive	140 05/17→						
		for PR number: 1KE / 2EJ; Fitting Position: Rear Axle	24.0110-0356.1	410356	Outer diameter [mm]: 272 Brake Disc Thickness [mm] 9.7 Minimum thickness [mm] 8 Brake Disc Type: Solid Supplementary Article/Info 2: with bolts/screws		
		for PR number: 1KE / 2EJ; Fitting Position: Rear Axle	24.0310-0356.1	510356	Outer diameter [mm]: 272 Brake Disc Thickness [mm] 9.7 Minimum thickness [mm] 8 Brake Disc Type: Solid Supplementary Article/Info 2: with bolts/screws		
2.0 TDI 4Drive	110 04/16→	for PR number: 1ZE / 1ZJ; Fitting Position: Front Axle	24.0125-0145.1	425145	Outer diameter [mm]: 288 Brake Disc Thickness [mm] 25 Minimum thickness [mm] 22 Brake Disc Type: Vented Supplementary Article/Info 2: with bolts/screws		
		for PR number: 1ZA; Fitting Position: Front Axle	24.0125-0158.1	425158	Outer diameter [mm]: 312 Brake Disc Thickness [mm] 25 Minimum thickness [mm] 22 Brake Disc Type: Vented Supplementary Article/Info 2: with bolts/screws		

		kW					
SEAT - ATECA (KH7, KHP) 04/16→							
 Brake Disc							
2.0 TDI 4Drive	110 04/16→	Construction year from: 06/16 →; for PR number: 1ZA; Fitting Position: Front Axle		24.0325-0158.1 525158	Outer diameter [mm]: 312 Brake Disc Thickness [mm] 25 Minimum thickness [mm] 22 Brake Disc Type: Vented Supplementary Article/Info 2: with bolts/screws		
		for PR number: 1KE / 2EJ; Fitting Position: Rear Axle		24.0110-0356.1 410356	Outer diameter [mm]: 272 Brake Disc Thickness [mm] 9.7 Minimum thickness [mm] 8 Brake Disc Type: Solid Supplementary Article/Info 2: with bolts/screws		
				24.0310-0356.1 510356	Outer diameter [mm]: 272 Brake Disc Thickness [mm] 9.7 Minimum thickness [mm] 8 Brake Disc Type: Solid Supplementary Article/Info 2: with bolts/screws		
 Wheel Speed Sensor							
1.0 TSI	81 - 05/16→	Fitting Position: Front Axle Left		24.0711-5273.3 360303			
	85	Fitting Position: Front Axle Right		24.0711-5274.3 360304			
1.4 TSI	110 06/16→						
1.5 TSI	110 07/18→	Required quantity: 2;		2	24.0711-6337.3 360390		
1.6 TDI	85 04/16→07/18	Fitting Position: Rear Axle					
2.0 TDI	81 - 04/16→						
	110						
1.4 TSI 4Drive	110 06/16→	Fitting Position: Front Axle Left		24.0711-5273.3 360303			
1.5 TSI 4Drive	110 07/18→	Fitting Position: Front Axle Right		24.0711-5274.3 360304			
2.0 TDI 4Drive	110 - 04/16→	Fitting Position: Rear Axle Left		24.0711-5401.3 360330			
	140						
2.0 TSI 4Drive	140 05/17→	Construction year from: 12/19 →; Fitting Position: Rear Axle Left		24.0711-5401.3 360330			
		Fitting Position: Rear Axle Right		24.0711-5402.3 360331			
		Construction year from: 12/19 →; Fitting Position: Rear Axle Right		24.0711-5402.3 360331			
Control Element, parking brake caliper							
1.0 TSI	81 - 05/16→	Fitting Position: Rear Axle Left		11.9282-1001.3 250159	Brake System: ATE		
	85	Fitting Position: Rear Axle Right		11.9282-1002.3 250160	Brake System: ATE		
1.4 TSI	110 06/16→						
1.4 TSI 4Drive	110 06/16→						
1.5 TSI	110 07/18→						
1.5 TSI 4Drive	110 07/18→						
1.6 TDI	85 04/16→07/18						
2.0 TDI	81 - 04/16→						
	110						
2.0 TDI 4Drive	110 - 04/16→						
	140						
2.0 TSI 4Drive	140 05/17→						
SEAT - CORDOBA (6L2) 09/02→11/09							
 Wheel Speed Sensor							
1.2	47 10/02→06/06	Fitting Position: Front Axle Left		24.0711-5273.3 360303			
1.4 TDI	55 10/02→12/05	Fitting Position: Front Axle Right		24.0711-5274.3 360304			
1.2 12V	51 05/06→11/09	→ Construction year to: 06/09;		24.0711-5273.3 360303			
1.4 16V	63 - 10/02→11/09	Fitting Position: Front Axle Left					
	74	→ Construction year to: 06/09;		24.0711-5274.3 360304			
1.4 TDI	51 - 05/05→11/09	Fitting Position: Front Axle Right					
	59						
1.6	74 04/03→11/09						
1.6 16V	77 11/06→11/09						
1.9 TDI	96 10/02→11/09						
1.4 16V	55 09/02→12/07	Construction year from: 10/02 →; Fitting Position: Front Axle Left		24.0711-5273.3 360303			
		Construction year from: 10/02 →; Fitting Position: Front Axle Right		24.0711-5274.3 360304			
1.9 SDI	47 09/02→11/09	Construction year from: 10/02 → →		24.0711-5273.3 360303			
1.9 TDI	74 09/02→11/09	Construction year to: 06/09;					
2.0	85 09/02→11/09	Fitting Position: Front Axle Left					
		Construction year from: 10/02 → → Construction year to: 06/09; Fitting Position: Front Axle Right		24.0711-5274.3 360304			

	kW				
SEAT - IBIZA III (6L1) 02/02→11/09					
Guide Bolt, brake caliper					
1.8 T Cupra R	132 01/04→02/08	Required quantity: 2	2	11.8171-0008.1 990049	Brake System: ATE
1.9 TDI Cupra R	118 03/04→02/08	for PR number: 1LT; Required quantity: 2	2	11.8171-0008.1 990049	Brake System: ATE
 Wheel Speed Sensor					
1.2	44 - 02/02→05/08 47	Fitting Position: Front Axle Left		24.0711-5273.3 360303	
1.2 12V	51 05/06→11/09	Fitting Position: Front Axle Right		24.0711-5274.3 360304	
1.4 16V	55 - 02/02→11/09 74				
1.4 TDI	51 - 05/02→11/09 59				
1.6	74 02/03→11/09				
1.6 16V	77 11/06→11/09				
1.8 T Cupra R	132 01/04→02/08				
1.8 T FR	110 12/03→05/08				
1.9 SDI	47 02/02→12/05				
1.9 TDI	74 - 02/02→11/09 96				
1.9 TDI Cupra R	118 03/04→02/08				
1.9 TDI Joya Racer	112 07/03→06/04				
2.0	85 04/02→11/09				
SEAT - IBIZA IV (6J5, 6P1) 03/08→12/17					
Guide Sleeve Kit, brake caliper					
1.0	55 05/15→06/17	for PR number: 1ZR / 1ZS / 1ZC;		11.0101-5407.2 260011	Brake System: ATE
1.0 TSI	70 - 05/15→06/17 81	Fitting Position: Front Axle			
1.2 TSI	66 - 05/15→06/17 81				
1.4 TDI	55 - 05/15→06/17 77				
1.6	81 07/15→06/17				
1.2	44 07/09→05/11	for PR number: 1ZR / 1ZS;		11.0101-5407.2 260011	Brake System: ATE
1.2 TDI	55 06/10→05/15	Fitting Position: Front Axle			
1.2 TSI	63 - 09/10→05/15 77				
1.4 TDI	59 07/08→06/10				
1.4 TSI	110 06/09→06/17				
1.6 LPG	60 05/11→05/15				
1.9 TDI	66 07/08→06/10				
2.0	85 10/08→05/15				
2.0 TDI	105 01/10→05/15				
1.2	51 03/08→05/15	Construction year from: 07/08 →;		11.0101-5407.2 260011	Brake System: ATE
1.2 LPG	51 03/08→05/11	for PR number: 1ZR / 1ZS;			
1.4	63 03/08→05/15	Fitting Position: Front Axle			
1.4 LPG	63 03/08→05/11				
1.6	77 05/08→03/12				
1.9 TDI	77 03/08→06/10				
1.4 TSI	103 10/13→05/15	Construction year from: 12/13 →;		11.0101-5407.2 260011	Brake System: ATE
		for PR number: 1ZR / 1ZS;			
		Fitting Position: Front Axle			
1.6 TDI	55 - 05/09→05/15 77	Construction year from: 06/09 →;		11.0101-5407.2 260011	Brake System: ATE
		for PR number: 1ZR / 1ZS;			
		Fitting Position: Front Axle			
Guide Bolt, brake caliper					
1.0	55 05/15→06/17	for PR number: 1ZR / 1ZS / 1ZC;	2	11.8171-0008.1 990049	Brake System: ATE
1.0 TSI	70 - 05/15→06/17 81	Required quantity: 2;			
		Fitting Position: Front Axle			
1.2 TSI	66 - 05/15→06/17 81				
1.4 TDI	55 - 05/15→06/17 77				
1.6	81 07/15→06/17				
1.2	44 07/09→05/11	for PR number: 1ZR / 1ZS;	2	11.8171-0008.1 990049	Brake System: ATE
1.2 TDI	55 06/10→05/15	Required quantity: 2;			
1.2 TSI	63 - 09/10→05/15 77	Fitting Position: Front Axle			
1.4 TDI	59 07/08→06/10				
1.4 TSI	110 06/09→06/17				
1.6 LPG	60 05/11→05/15				
1.9 TDI	66 07/08→06/10				
2.0	85 10/08→05/15				
2.0 TDI	105 01/10→05/15				
1.2	51 03/08→05/15	Construction year from: 07/08 →;	2	11.8171-0008.1 990049	Brake System: ATE
1.2 LPG	51 03/08→05/11	for PR number: 1ZR / 1ZS;			
1.4	63 03/08→05/15	Required quantity: 2;			
1.4 LPG	63 03/08→05/11	Fitting Position: Front Axle			
1.6	77 05/08→03/12				
1.9 TDI	77 03/08→06/10				
→					

	kW				
SEAT - IBIZA IV (6J5, 6P1) 03/08→12/17					
Guide Bolt, brake caliper					
1.4 TSI	103	10/13→05/15	Construction year from: 12/13 →; for PR number: 1ZR / 1ZS; Required quantity: 2; Fitting Position: Front Axle	2	11.8171-0008.1 990049 Brake System: ATE
1.6 TDI	55 - 77	05/09→05/15	Construction year from: 06/09 →; for PR number: 1ZR / 1ZS; Required quantity: 2; Fitting Position: Front Axle	2	11.8171-0008.1 990049 Brake System: ATE
 Wheel Speed Sensor					
1.0	55	05/15→06/17	Fitting Position: Front Axle Left		24.0711-5273.3 360303
1.0 TSI	70 - 81	05/15→06/17	Fitting Position: Front Axle Right		24.0711-5274.3 360304
1.2	44	07/09→05/11			
1.2 TDI	55	06/10→05/15			
1.2 TSI	63 - 81	09/10→06/17			
1.4 TDI	55 - 77	07/08→06/17			
1.4 TSI	110	06/09→06/17			
1.6	81	07/15→06/17			
1.6 LPG	60	05/11→05/15			
1.9 TDI	66	07/08→06/10			
2.0	85	10/08→05/15			
2.0 TDI	105	01/10→05/15			
1.2	51	03/08→05/15	Construction year from: 07/08 →; Fitting Position: Front Axle Left		24.0711-5273.3 360303
1.2 LPG	51	03/08→05/11			
1.4	63	03/08→05/15	Construction year from: 07/08 →; Fitting Position: Front Axle Right		24.0711-5274.3 360304
1.4 LPG	63	03/08→05/11			
1.6	77	05/08→03/12			
1.9 TDI	77	03/08→06/10			
1.4 TSI	103	10/13→05/15	Construction year from: 12/13 →; Fitting Position: Front Axle Left		24.0711-5273.3 360303
			Construction year from: 12/13 →; Fitting Position: Front Axle Right		24.0711-5274.3 360304
1.6 TDI	55 - 77	05/09→05/15	Construction year from: 06/09 →; Fitting Position: Front Axle Left		24.0711-5273.3 360303
			Construction year from: 06/09 →; Fitting Position: Front Axle Right		24.0711-5274.3 360304
SEAT - IBIZA IV Hatchback Van (6J1) 04/08→05/15					
Guide Sleeve Kit, brake caliper					
1.2	51	04/08→05/15	for PR number: 1ZR / 1ZS;		11.0101-5407.2 260011 Brake System: ATE
1.2 TDI	55	05/10→05/15	Fitting Position: Front Axle		
1.6 TDI	66	05/09→05/15	Construction year from: 06/09 →; for PR number: 1ZR / 1ZS; Fitting Position: Front Axle		11.0101-5407.2 260011 Brake System: ATE
Guide Bolt, brake caliper					
1.2	51	04/08→05/15	for PR number: 1ZR / 1ZS;	2	11.8171-0008.1 990049 Brake System: ATE
1.2 TDI	55	05/10→05/15	Required quantity: 2; Fitting Position: Front Axle		
1.6 TDI	66	05/09→05/15	Construction year from: 06/09 →; for PR number: 1ZR / 1ZS; Required quantity: 2; Fitting Position: Front Axle	2	11.8171-0008.1 990049 Brake System: ATE
 Wheel Speed Sensor					
1.2	51	04/08→05/15	Fitting Position: Front Axle Left		24.0711-5273.3 360303
1.2 TDI	55	05/10→05/15	Fitting Position: Front Axle Right		24.0711-5274.3 360304
1.6 TDI	66	05/09→05/15	Construction year from: 06/09 →; Fitting Position: Front Axle Left		24.0711-5273.3 360303
			Construction year from: 06/09 →; Fitting Position: Front Axle Right		24.0711-5274.3 360304
SEAT - IBIZA IV SC (6J1, 6P5) 06/08→12/18					
Guide Sleeve Kit, brake caliper					
1.0	55	05/15→12/16	for PR number: 1ZR / 1ZS / 1ZC;		11.0101-5407.2 260011 Brake System: ATE
1.0 TSI	70 - 81	05/15→12/16	Fitting Position: Front Axle		
1.2 TSI	66 - 81	05/15→12/16			
1.4 TDI	55 - 77	05/15→12/16			
1.6	81	07/15→12/16			
1.8 TSI Cupra	141	11/15→12/16			
→					

	kW			
SEAT - IBIZA IV SC (6J1, 6P5) 06/08→12/18				
Guide Sleeve Kit, brake caliper				
1.2	44 - 07/08→05/15 51	for PR number: 1ZR / 1ZS; Fitting Position: Front Axle		11.0101-5407.2 260011 Brake System: ATE
1.2 TDI	55 05/10→05/15			
1.2 TSI	63 - 09/10→05/15 77			
1.4	63 07/08→05/15			
1.4 LPG	63 07/08→05/11			
1.4 TDI	59 07/08→06/10			
1.4 TSI	110 01/09→12/16			
1.6	77 07/08→05/15			
1.6 LPG	60 05/11→05/15			
1.6 TDI	55 05/10→06/10			
1.9 TDI	66 - 06/08→06/10 77			
2.0	85 10/08→05/15			
2.0 TDI	105 01/10→05/15			
1.4 TSI	103 10/13→05/15	Construction year from: 12/13 →; for PR number: 1ZR / 1ZS; Fitting Position: Front Axle		11.0101-5407.2 260011 Brake System: ATE
1.6 TDI	66 - 05/09→05/15 77	Construction year from: 06/09 →; for PR number: 1ZR / 1ZS; Fitting Position: Front Axle		11.0101-5407.2 260011 Brake System: ATE
Guide Bolt, brake caliper				
1.0	55 05/15→12/16	for PR number: 1ZR / 1ZS / 1ZC; Required quantity: 2; Fitting Position: Front Axle	2	11.8171-0008.1 990049 Brake System: ATE
1.0 TSI	70 - 05/15→12/16 81			
1.2 TSI	66 - 05/15→12/16 81			
1.4 TDI	55 - 05/15→12/16 77			
1.6	81 07/15→12/16			
1.8 TSI Cupra	141 11/15→12/16			
1.2	44 - 07/08→05/15 51	for PR number: 1ZR / 1ZS; Required quantity: 2; Fitting Position: Front Axle	2	11.8171-0008.1 990049 Brake System: ATE
1.2 TDI	55 05/10→05/15			
1.2 TSI	63 - 09/10→05/15 77			
1.4	63 07/08→05/15			
1.4 LPG	63 07/08→05/11			
1.4 TDI	59 07/08→06/10			
1.4 TSI	110 01/09→12/16			
1.6	77 07/08→05/15			
1.6 LPG	60 05/11→05/15			
1.6 TDI	55 05/10→06/10			
1.9 TDI	66 - 06/08→06/10 77			
2.0	85 10/08→05/15			
2.0 TDI	105 01/10→05/15			
1.4 TSI	103 10/13→05/15	Construction year from: 12/13 →; for PR number: 1ZR / 1ZS; Required quantity: 2; Fitting Position: Front Axle	2	11.8171-0008.1 990049 Brake System: ATE
1.6 TDI	66 - 05/09→05/15 77	Construction year from: 06/09 →; for PR number: 1ZR / 1ZS; Required quantity: 2; Fitting Position: Front Axle	2	11.8171-0008.1 990049 Brake System: ATE
 Wheel Speed Sensor				
1.0	55 05/15→12/16	Fitting Position: Front Axle Left		24.0711-5273.3 360303
1.0 TSI	70 - 05/15→12/16 81	Fitting Position: Front Axle Right		24.0711-5274.3 360304
1.2	44 - 07/08→05/15 51			
1.2 TDI	55 05/10→05/15			
1.2 TSI	63 - 09/10→12/16 81			
1.4	63 07/08→05/15			
1.4 LPG	63 07/08→05/11			
1.4 TDI	55 - 07/08→12/16 77			
1.4 TSI	110 01/09→12/16			
1.4 TSI Cupra	132 06/09→05/15			
1.6	77 - 07/08→12/16 81			
1.6 LPG	60 05/11→05/15			
1.6 TDI	55 05/10→06/10			
1.8 TSI Cupra	141 11/15→12/16			
1.9 TDI	66 - 06/08→06/10 77			
2.0	85 10/08→05/15			
2.0 TDI	105 01/10→05/15			



	kW				
SEAT - IBIZA IV SC (6J1, 6P5) 06/08→12/18					
 Wheel Speed Sensor					
1.4 TSI	103	10/13→05/15	Construction year from: 12/13 →; Fitting Position: Front Axle Left		24.0711-5273.3 360303
			Construction year from: 12/13 →; Fitting Position: Front Axle Right		24.0711-5274.3 360304
1.6 TDI	66 - 77	05/09→05/15	Construction year from: 06/09 →; Fitting Position: Front Axle Left		24.0711-5273.3 360303
			Construction year from: 06/09 →; Fitting Position: Front Axle Right		24.0711-5274.3 360304
SEAT - IBIZA IV ST (6J8, 6P8) 03/10→07/16					
Guide Sleeve Kit, brake caliper					
1.0	55	05/15→07/16	for PR number: 1ZR / 1ZS / 1ZC;		11.0101-5407.2 260011 Brake System: ATE
1.0 TSI	70 - 81	05/15→07/16	Fitting Position: Front Axle		
1.2 TSI	66 - 81	05/15→07/16			
1.4 TDI	55 - 77	05/15→07/16			
1.2	44 - 51	05/10→05/15	for PR number: 1ZR / 1ZS;		11.0101-5407.2 260011 Brake System: ATE
1.2 TDI	55	04/10→05/15	Fitting Position: Front Axle		
1.2 TSI	63 - 77	09/10→05/15			
1.4	63	03/10→05/15			
1.4 TSI	110	02/12→07/16			
1.6	77	02/12→05/15			
1.6 TDI	66 - 77	03/10→05/15			
1.4 TSI	103	10/13→05/15	Construction year from: 12/13 →; for PR number: 1ZR / 1ZS; Fitting Position: Front Axle		11.0101-5407.2 260011 Brake System: ATE
Guide Bolt, brake caliper					
1.0	55	05/15→07/16	for PR number: 1ZR / 1ZS / 1ZC;	2	11.8171-0008.1 990049 Brake System: ATE
1.0 TSI	70 - 81	05/15→07/16	Required quantity: 2; Fitting Position: Front Axle		
1.2 TSI	66 - 81	05/15→07/16			
1.4 TDI	55 - 77	05/15→07/16			
1.2	44 - 51	05/10→05/15	for PR number: 1ZR / 1ZS;	2	11.8171-0008.1 990049 Brake System: ATE
1.2 TDI	55	04/10→05/15	Required quantity: 2; Fitting Position: Front Axle		
1.2 TSI	63 - 77	09/10→05/15			
1.4	63	03/10→05/15			
1.4 TSI	110	02/12→07/16			
1.6	77	02/12→05/15			
1.6 TDI	66 - 77	03/10→05/15			
1.4 TSI	103	10/13→05/15	Construction year from: 12/13 →; for PR number: 1ZR / 1ZS; Required quantity: 2; Fitting Position: Front Axle	2	11.8171-0008.1 990049 Brake System: ATE
 Wheel Speed Sensor					
1.0	55	05/15→07/16	Fitting Position: Front Axle Left		24.0711-5273.3 360303
1.0 TSI	70 - 81	05/15→07/16	Fitting Position: Front Axle Right		24.0711-5274.3 360304
1.2	44 - 51	05/10→05/15			
1.2 TDI	55	04/10→05/15			
1.2 TSI	63 - 81	09/10→07/16			
1.4	63	03/10→05/15			
1.4 TDI	55 - 77	05/15→07/16			
1.4 TSI	110	02/12→07/16			
1.6	77	02/12→05/15			
1.6 TDI	66 - 77	03/10→05/15			
1.4 TSI	103	10/13→05/15	Construction year from: 12/13 →; Fitting Position: Front Axle Left		24.0711-5273.3 360303
			Construction year from: 12/13 →; Fitting Position: Front Axle Right		24.0711-5274.3 360304

	kW				
SEAT - IBIZA V (KJ1, KJG) 01/17→					
 Wheel Speed Sensor					
1.0	48 - 01/17→ 55		→ Construction year to: 11/19; Fitting Position: Front Axle Left	24.0711-5273.3	360303
1.0 MPI	59 07/18→			24.0711-5274.3	360304
1.0 TGI	66 11/17→		→ Construction year to: 11/19; Fitting Position: Front Axle Right		
1.0 TSI	70 - 01/17→ 85				
1.5 TSI	110 07/17→				
1.6	81 05/17→				
1.6 TDI	59 - 09/17→ 85				
SEAT - LEON (1M1) 11/99→06/06					
Guide Bolt, brake caliper					
1.4 16V	55 11/99→06/06		→ Construction year to: 07/05; for PR number: 1LJ / 1ZQ; Required quantity: 2	2 11.8171-0008.1	990049 Brake System: ATE
1.6	74 11/99→06/06				
1.6 16 V	77 09/00→06/06				
1.8 20V	92 11/99→06/06		→ Construction year to: 07/05; for PR number: 1LQ / 1LS; Required quantity: 2	2 11.8171-0008.1	990049 Brake System: ATE
1.8 20V T	132 11/99→06/06				
1.8 20V T 4	132 11/99→06/06				
1.9 SDI	50 11/99→06/06		→ Construction year to: 07/05; for PR number: 1LE; Required quantity: 2; Fitting Position: Front Axle	2 11.8171-0008.1	990049 Brake System: ATE
1.9 TDI	66 - 11/99→06/06 96				
1.9 TDI Syncro	110 05/02→06/06				
1.8 T Cupra R	154 02/02→06/06		Construction year from: 05/02 → → Construction year to: 07/05; for PR number: 1LT; Required quantity: 2	2 11.8171-0008.1	990049 Brake System: ATE
1.8 T Cupra R	165 07/03→06/06		→ Construction year to: 07/05; for PR number: 1LT; Required quantity: 2	2 11.8171-0008.1	990049 Brake System: ATE
2.8 Cupra 4	150 02/01→06/06				
1.9 TDI	110 09/00→06/06		Construction year from: 02/01 → → Construction year to: 07/05; for PR number: 1LJ / 1ZQ; Required quantity: 2	2 11.8171-0008.1	990049 Brake System: ATE
			Construction year from: 02/01 → → Construction year to: 07/05; for PR number: 1LQ / 1LS; Required quantity: 2	2 11.8171-0008.1	990049 Brake System: ATE
			Construction year from: 02/01 → → Construction year to: 07/05; for PR number: 1LE; Required quantity: 2; Fitting Position: Front Axle	2 11.8171-0008.1	990049 Brake System: ATE
2.8	150 05/02→06/04		for PR number: 1LQ / 1LS; Required quantity: 2	2 11.8171-0008.1	990049 Brake System: ATE
			for PR number: 1LJ / 1ZQ; Required quantity: 2	2 11.8171-0008.1	990049 Brake System: ATE
			for PR number: 1LE; Required quantity: 2; Fitting Position: Front Axle	2 11.8171-0008.1	990049 Brake System: ATE
SEAT - LEON (1P1) 05/05→12/13					
Guide Bolt, brake caliper					
1.2 TSI	77 02/10→12/12		→ Construction year to: 10/12; for PR number: 1LJ; Required quantity: 2	2 11.8171-0008.1	990049 Brake System: ATE
1.6 LPG	75 12/09→12/12				
1.6 MultiFuel	75 07/05→08/13		→ Construction year to: 10/12; for PR number: 1ZE; Required quantity: 2	2 11.8171-0008.1	990049 Brake System: ATE
1.6 TDI	66 - 02/10→12/12 77		for PR number: 1LB; → Construction year to: 10/12; Required quantity: 2	2 11.8171-0008.1	990049 Brake System: ATE
1.4 16V	63 06/06→12/12		→ Construction year to: 10/12; for PR number: 1LJ; Required quantity: 2	2 11.8171-0008.1	990049 Brake System: ATE
1.4 TSI	92 11/07→12/12				
1.8 TSI	118 06/07→12/12		→ Construction year to: 10/12; for PR number: 1ZE; Required quantity: 2	2 11.8171-0008.1	990049 Brake System: ATE
2.0 Cupra R	195 09/09→12/12				
2.0 TDI	125 05/06→12/12				
2.0 TFSI	155 06/09→12/12		Construction year from: 10/09 → → Construction year to: 10/12; for PR number: 1LB; Required quantity: 2	2 11.8171-0008.1	990049 Brake System: ATE
			→ Construction year to: 09/09; for PR number: 1LU; Required quantity: 2	2 11.8171-0008.1	990049 Brake System: ATE
1.6	75 07/05→12/12		Construction year from: 08/05 → → Construction year to: 10/12; for PR number: 1LJ; Required quantity: 2	2 11.8171-0008.1	990049 Brake System: ATE
2.0 TDI 16V	103 07/05→12/12		Construction year from: 08/05 → → Construction year to: 10/12; for PR number: 1ZE; Required quantity: 2	2 11.8171-0008.1	990049 Brake System: ATE
→					

	kW				
SEAT - LEON (1P1) 05/05→12/13					
Guide Bolt, brake caliper					
1.6 2.0 TDI 16V	75 07/05→12/12 103 07/05→12/12	Construction year from: 08/05 → → Construction year to: 09/09; for PR number: 1LU; Required quantity: 2	2	11.8171-0008.1 990049	Brake System: ATE
		Construction year from: 10/09 → → Construction year to: 10/12; for PR number: 1LB; Required quantity: 2	2	11.8171-0008.1 990049	Brake System: ATE
1.9 TDI 2.0 TDI 2.0 TFSI	66 06/07→12/10 103 10/05→10/10 177 11/06→05/11	→ Construction year to: 09/09; for PR number: 1LU; Required quantity: 2	2	11.8171-0008.1 990049	Brake System: ATE
		Construction year from: 10/09 → ; for PR number: 1LB; Required quantity: 2	2	11.8171-0008.1 990049	Brake System: ATE
		for PR number: 1LJ; Required quantity: 2	2	11.8171-0008.1 990049	Brake System: ATE
		for PR number: 1ZE; Required quantity: 2	2	11.8171-0008.1 990049	Brake System: ATE
1.9 TDI 2.0 FSI 2.0 TDI	77 07/05→12/10 110 07/05→05/10 100 07/05→05/10	Construction year from: 08/05 → ; for PR number: 1LJ; Required quantity: 2	2	11.8171-0008.1 990049	Brake System: ATE
		Construction year from: 08/05 → ; for PR number: 1ZE; Required quantity: 2	2	11.8171-0008.1 990049	Brake System: ATE
		Construction year from: 08/05 → → Construction year to: 09/09; for PR number: 1LU; Required quantity: 2	2	11.8171-0008.1 990049	Brake System: ATE
		Construction year from: 10/09 → ; for PR number: 1LB; Required quantity: 2	2	11.8171-0008.1 990049	Brake System: ATE
2.0 TFSI	136 09/05→05/06	for PR number: 1LJ; Required quantity: 2	2	11.8171-0008.1 990049	Brake System: ATE
		for PR number: 1ZE; Required quantity: 2	2	11.8171-0008.1 990049	Brake System: ATE
		for PR number: 1LU; Required quantity: 2	2	11.8171-0008.1 990049	Brake System: ATE
2.0 TFSI	147 05/05→03/09	Construction year from: 08/05 → ; for PR number: 1LJ; Required quantity: 2	2	11.8171-0008.1 990049	Brake System: ATE
		Construction year from: 08/05 → ; for PR number: 1ZE; Required quantity: 2	2	11.8171-0008.1 990049	Brake System: ATE
		Construction year from: 08/05 → ; for PR number: 1LU; Required quantity: 2	2	11.8171-0008.1 990049	Brake System: ATE
 Brake Disc					
1.2 TSI 1.4 16V 1.4 TSI 1.6 LPG 1.6 MultiFuel 1.6 TDI	77 02/10→12/12 63 06/06→12/12 92 11/07→12/12 75 12/09→12/12 75 07/05→08/13 66 - 02/10→12/12 77	→ Construction year to: 10/12; for PR number: 1ZE; Fitting Position: Front Axle		24.0125-0145.1 425145	Outer diameter [mm]: 288 Brake Disc Thickness [mm] 25 Minimum thickness [mm] 22 Brake Disc Type: Vented Supplementary Article/Info 2: with bolts/screws
1.8 TSI 2.0 Cupra R 2.0 TDI 2.0 TFSI	118 06/07→12/12 195 09/09→12/12 125 05/06→12/12 155 06/09→12/12	→ Construction year to: 10/12; for PR number: 1LJ; Fitting Position: Front Axle		24.0125-0158.1 425158	Outer diameter [mm]: 312 Brake Disc Thickness [mm] 25 Minimum thickness [mm] 22 Brake Disc Type: Vented Supplementary Article/Info 2: with bolts/screws
				24.0325-0158.1 525158	Outer diameter [mm]: 312 Brake Disc Thickness [mm] 25 Minimum thickness [mm] 22 Brake Disc Type: Vented Supplementary Article/Info 2: with bolts/screws
		→ Construction year to: 10/12; for PR number: 1KS / 1KT; Fitting Position: Rear Axle		24.0110-0356.1 410356	Outer diameter [mm]: 272 Brake Disc Thickness [mm] 9.7 Minimum thickness [mm] 8 Brake Disc Type: Solid Supplementary Article/Info 2: with bolts/screws
				24.0310-0356.1 510356	Outer diameter [mm]: 272 Brake Disc Thickness [mm] 9.7 Minimum thickness [mm] 8 Brake Disc Type: Solid Supplementary Article/Info 2: with bolts/screws
1.6 2.0 TDI 16V	75 07/05→12/12 103 07/05→12/12	Construction year from: 08/05 → → Construction year to: 10/12; for PR number: 1ZE; Fitting Position: Front Axle		24.0125-0145.1 425145	Outer diameter [mm]: 288 Brake Disc Thickness [mm] 25 Minimum thickness [mm] 22 Brake Disc Type: Vented Supplementary Article/Info 2: with bolts/screws
→					



		kW					
SEAT - LEON (1P1) 05/05→12/13							
 Brake Disc							
1.6 2.0 TDI 16V	75 07/05→12/12 103 07/05→12/12	Construction year from: 08/05 → → Construction year to: 10/12; for PR number: 1LJ; Fitting Position: Front Axle		24.0125-0158.1 425158	Outer diameter [mm]: 312 Brake Disc Thickness [mm] 25 Minimum thickness [mm] 22 Brake Disc Type: Vented Supplementary Article/Info 2: with bolts/screws		
				24.0325-0158.1 525158	Outer diameter [mm]: 312 Brake Disc Thickness [mm] 25 Minimum thickness [mm] 22 Brake Disc Type: Vented Supplementary Article/Info 2: with bolts/screws		
		Construction year from: 08/05 → → Construction year to: 10/12; for PR number: 1KS / 1KT; Fitting Position: Rear Axle		24.0110-0356.1 410356	Outer diameter [mm]: 272 Brake Disc Thickness [mm] 9.7 Minimum thickness [mm] 8 Brake Disc Type: Solid Supplementary Article/Info 2: with bolts/screws		
				24.0310-0356.1 510356	Outer diameter [mm]: 272 Brake Disc Thickness [mm] 9.7 Minimum thickness [mm] 8 Brake Disc Type: Solid Supplementary Article/Info 2: with bolts/screws		
1.9 TDI 2.0 TDI 2.0 TFSI	66 06/07→12/10 103 10/05→10/10 136 - 09/05→05/11 177	for PR number: 1ZE; Fitting Position: Front Axle		24.0125-0145.1 425145	Outer diameter [mm]: 288 Brake Disc Thickness [mm] 25 Minimum thickness [mm] 22 Brake Disc Type: Vented Supplementary Article/Info 2: with bolts/screws		
				24.0125-0158.1 425158	Outer diameter [mm]: 312 Brake Disc Thickness [mm] 25 Minimum thickness [mm] 22 Brake Disc Type: Vented Supplementary Article/Info 2: with bolts/screws		
				24.0110-0356.1 410356	Outer diameter [mm]: 272 Brake Disc Thickness [mm] 9.7 Minimum thickness [mm] 8 Brake Disc Type: Solid Supplementary Article/Info 2: with bolts/screws		
		for PR number: 1LJ; Fitting Position: Front Axle		24.0125-0158.1 425158	Outer diameter [mm]: 312 Brake Disc Thickness [mm] 25 Minimum thickness [mm] 22 Brake Disc Type: Vented Supplementary Article/Info 2: with bolts/screws		
				24.0325-0158.1 525158	Outer diameter [mm]: 312 Brake Disc Thickness [mm] 25 Minimum thickness [mm] 22 Brake Disc Type: Vented Supplementary Article/Info 2: with bolts/screws		
				24.0110-0356.1 410356	Outer diameter [mm]: 272 Brake Disc Thickness [mm] 9.7 Minimum thickness [mm] 8 Brake Disc Type: Solid Supplementary Article/Info 2: with bolts/screws		
		for PR number: 1KS / 1KT; Fitting Position: Rear Axle		24.0110-0356.1 410356	Outer diameter [mm]: 272 Brake Disc Thickness [mm] 9.7 Minimum thickness [mm] 8 Brake Disc Type: Solid Supplementary Article/Info 2: with bolts/screws		
				24.0310-0356.1 510356	Outer diameter [mm]: 272 Brake Disc Thickness [mm] 9.7 Minimum thickness [mm] 8 Brake Disc Type: Solid Supplementary Article/Info 2: with bolts/screws		
				24.0125-0145.1 425145	Outer diameter [mm]: 288 Brake Disc Thickness [mm] 25 Minimum thickness [mm] 22 Brake Disc Type: Vented Supplementary Article/Info 2: with bolts/screws		
1.9 TDI 2.0 FSI 2.0 TDI 2.0 TFSI	77 07/05→12/10 110 07/05→05/10 100 07/05→05/10 147 05/05→03/09	Construction year from: 08/05 → →; for PR number: 1ZE; Fitting Position: Front Axle		24.0125-0145.1 425145	Outer diameter [mm]: 288 Brake Disc Thickness [mm] 25 Minimum thickness [mm] 22 Brake Disc Type: Vented Supplementary Article/Info 2: with bolts/screws		
				24.0125-0158.1 425158	Outer diameter [mm]: 312 Brake Disc Thickness [mm] 25 Minimum thickness [mm] 22 Brake Disc Type: Vented Supplementary Article/Info 2: with bolts/screws		
				24.0325-0158.1 525158	Outer diameter [mm]: 312 Brake Disc Thickness [mm] 25 Minimum thickness [mm] 22 Brake Disc Type: Vented Supplementary Article/Info 2: with bolts/screws		
		Construction year from: 08/05 → →; for PR number: 1KS / 1KT; Fitting Position: Rear Axle		24.0110-0356.1 410356	Outer diameter [mm]: 272 Brake Disc Thickness [mm] 9.7 Minimum thickness [mm] 8 Brake Disc Type: Solid Supplementary Article/Info 2: with bolts/screws		
				24.0125-0145.1 425145	Outer diameter [mm]: 288 Brake Disc Thickness [mm] 25 Minimum thickness [mm] 22 Brake Disc Type: Vented Supplementary Article/Info 2: with bolts/screws		





→



	kW				
SEAT - LEON (1P1) 05/05→12/13					
 Brake Disc					
1.9 TDI 2.0 FSI 2.0 TDI 2.0 TFSI	77 07/05→12/10 110 07/05→05/10 100 07/05→05/10 147 05/05→03/09	Construction year from: 08/05 →; for PR number: 1KS / 1KT; Fitting Position: Rear Axle		24.0310-0356.1 510356	Outer diameter [mm]: 272 Brake Disc Thickness [mm] 9.7 Minimum thickness [mm] 8 Brake Disc Type: Solid Supplementary Article/Info 2: with bolts/screws
SEAT - LEON (5F1) 09/12→05/21					
 Brake Caliper					
1.0 TSi 1.0 TSI 1.2 TSI 81 1.4 TSI 90 - 09/12→08/20 110 1.5 TGi 96 10/18→08/20 1.5 TSI 96 - 09/18→08/20 110 1.6 TDI 66 - 09/12→08/20 81 1.8 TSI 132 02/13→08/18 2.0 Cupra 195 - 10/13→08/20 221 2.0 Cupra R 228 11/17→08/18 2.0 TDI 81 - 09/12→08/20 135 2.0 TSI 140 09/18→08/20	63 09/18→08/20 85 05/15→08/20 63 - 12/12→08/20 81 90 - 09/12→08/20 110 96 10/18→08/20 96 - 09/18→08/20 110 66 - 09/12→08/20 81 132 02/13→08/18 195 - 10/13→08/20 221 228 11/17→08/18 81 - 09/12→08/20 135 140 09/18→08/20	for PR number: 1ZA; Fitting Position: Front Axle Left for PR number: 1ZA; Fitting Position: Front Axle Right		24.3571-1801.5 241387 24.3571-1802.5 241388	Supplementary Article/Supplementary Info: without holder Brake Caliper Type: Fist-type Caliper Supplementary Article/Supplementary Info: without holder Brake Caliper Type: Fist-type Caliper
1.4 TGI 81 02/13→08/18	81 02/13→08/18	Construction year from: 10/13 →; for PR number: 1ZA; Fitting Position: Front Axle Left		24.3571-1801.5 241387	Supplementary Article/Supplementary Info: without holder Brake Caliper Type: Fist-type Caliper
		Construction year from: 10/13 →; for PR number: 1ZA; Fitting Position: Front Axle Right		24.3571-1802.5 241388	Supplementary Article/Supplementary Info: without holder Brake Caliper Type: Fist-type Caliper
1.6 TDI 85 11/16→08/20	85 11/16→08/20	Construction year from: 01/17 →; for PR number: 1ZA; Fitting Position: Front Axle Left		24.3571-1801.5 241387	Supplementary Article/Supplementary Info: without holder Brake Caliper Type: Fist-type Caliper
		Construction year from: 01/17 →; for PR number: 1ZA; Fitting Position: Front Axle Right		24.3571-1802.5 241388	Supplementary Article/Supplementary Info: without holder Brake Caliper Type: Fist-type Caliper
 Brake Disc					
1.0 TSi 1.0 TSI 1.2 TSI 81 1.4 TSI 90 - 09/12→08/20 110 1.5 TGi 96 10/18→08/20 1.5 TSI 96 - 09/18→08/20 110 1.6 TDI 66 - 09/12→08/20 81 1.8 TSI 132 02/13→08/18 2.0 Cupra 195 - 10/13→08/20 221 2.0 Cupra R 228 11/17→08/18 2.0 TDI 110 - 09/12→08/20 135 2.0 TSI 140 09/18→08/20	63 09/18→08/20 85 05/15→08/20 63 - 12/12→08/20 81 90 - 09/12→08/20 110 96 10/18→08/20 96 - 09/18→08/20 110 66 - 09/12→08/20 81 132 02/13→08/18 195 - 10/13→08/20 221 228 11/17→08/18 110 - 09/12→08/20 135 140 09/18→08/20	for PR number: 1ZE; Fitting Position: Front Axle for PR number: 1ZA; Fitting Position: Front Axle for PR number: 1KS / 1KE; Fitting Position: Rear Axle		24.0125-0145.1 425145 24.0125-0158.1 425158 24.0325-0158.1 525158 24.0110-0356.1 410356 24.0310-0356.1 510356	Outer diameter [mm]: 288 Brake Disc Thickness [mm] 25 Minimum thickness [mm] 22 Brake Disc Type: Vented Supplementary Article/Info 2: with bolts/screws Outer diameter [mm]: 312 Brake Disc Thickness [mm] 25 Minimum thickness [mm] 22 Brake Disc Type: Vented Supplementary Article/Info 2: with bolts/screws Outer diameter [mm]: 312 Brake Disc Thickness [mm] 25 Minimum thickness [mm] 22 Brake Disc Type: Vented Supplementary Article/Info 2: with bolts/screws Outer diameter [mm]: 272 Brake Disc Thickness [mm] 9.7 Minimum thickness [mm] 8 Brake Disc Type: Solid Supplementary Article/Info 2: with bolts/screws Outer diameter [mm]: 272 Brake Disc Thickness [mm] 9.7 Minimum thickness [mm] 8 Brake Disc Type: Solid Supplementary Article/Info 2: with bolts/screws
→					



		kW					
SEAT - LEON (5F1) 09/12→05/21							
 Brake Disc							
1.4 TGI	81 02/13→08/18	Construction year from: 10/13 →; for PR number: 1ZE; Fitting Position: Front Axle		24.0125-0145.1 425145	Outer diameter [mm]: 288 Brake Disc Thickness [mm] 25 Minimum thickness [mm] 22 Brake Disc Type: Vented Supplementary Article/Info 2: with bolts/screws		
		Construction year from: 10/13 →; for PR number: 1ZA; Fitting Position: Front Axle		24.0125-0158.1 425158	Outer diameter [mm]: 312 Brake Disc Thickness [mm] 25 Minimum thickness [mm] 22 Brake Disc Type: Vented Supplementary Article/Info 2: with bolts/screws		
		Construction year from: 10/13 →; for PR number: 1KS / 1KE; Fitting Position: Rear Axle		24.0325-0158.1 525158	Outer diameter [mm]: 312 Brake Disc Thickness [mm] 25 Minimum thickness [mm] 22 Brake Disc Type: Vented Supplementary Article/Info 2: with bolts/screws		
1.6 TDI	85 11/16→08/20	Construction year from: 01/17 →; for PR number: 1ZE; Fitting Position: Front Axle		24.0110-0356.1 410356	Outer diameter [mm]: 272 Brake Disc Thickness [mm] 9.7 Minimum thickness [mm] 8 Brake Disc Type: Solid Supplementary Article/Info 2: with bolts/screws		
		Construction year from: 01/17 →; for PR number: 1ZA; Fitting Position: Front Axle		24.0310-0356.1 510356	Outer diameter [mm]: 272 Brake Disc Thickness [mm] 9.7 Minimum thickness [mm] 8 Brake Disc Type: Solid Supplementary Article/Info 2: with bolts/screws		
		for PR number: 1KS / 1KE; Fitting Position: Rear Axle		24.0125-0145.1 425145	Outer diameter [mm]: 288 Brake Disc Thickness [mm] 25 Minimum thickness [mm] 22 Brake Disc Type: Vented Supplementary Article/Info 2: with bolts/screws		
2.0 TDI	81 - 05/13→08/20 105	for PR number: 1ZE; Fitting Position: Front Axle		24.0125-0158.1 425158	Outer diameter [mm]: 312 Brake Disc Thickness [mm] 25 Minimum thickness [mm] 22 Brake Disc Type: Vented Supplementary Article/Info 2: with bolts/screws		
		for PR number: 1ZA; Fitting Position: Front Axle		24.0110-0356.1 410356	Outer diameter [mm]: 272 Brake Disc Thickness [mm] 9.7 Minimum thickness [mm] 8 Brake Disc Type: Solid Supplementary Article/Info 2: with bolts/screws		
		for PR number: 1KS / 1KE; Fitting Position: Rear Axle		24.0125-0145.1 425145	Outer diameter [mm]: 288 Brake Disc Thickness [mm] 25 Minimum thickness [mm] 22 Brake Disc Type: Vented Supplementary Article/Info 2: with bolts/screws		



→





	kW				
SEAT - LEON (5F1) 09/12→05/21					
 Brake Disc					
2.0 TDI	81 - 05/13→08/20 105	for PR number: 1KS / 1KE; Fitting Position: Rear Axle		24.0310-0356.1 510356	Outer diameter [mm]: 272 Brake Disc Thickness [mm] 9.7 Minimum thickness [mm] 8 Brake Disc Type: Solid Supplementary Article/Info 2: with bolts/screws
 Wheel Speed Sensor					
1.0 TSi	63 09/18→08/20	Fitting Position: Front Axle Left		24.0711-5273.3 360303	
1.0 TSi	85 05/15→08/20	Fitting Position: Front Axle Right		24.0711-5274.3 360304	
1.2 TSi	63 - 12/12→08/20 81	Required quantity: 2;		2 24.0711-6337.3 360390	
1.4 TSi	90 - 09/12→08/20 110	Vehicle Equipment: for vehicles with autom. distance control; Fitting Position: Rear Axle			
1.5 TGi	96 10/18→08/20				
1.5 TSi	96 - 09/18→08/20 110				
1.6 TDI	66 - 09/12→08/20 81				
1.8 TSi	132 02/13→08/18				
2.0 Cupra	195 - 10/13→08/20 221				
2.0 Cupra R	228 11/17→08/18				
2.0 TDI	81 - 09/12→08/20 135				
2.0 TSi	140 09/18→08/20				
1.4 TGI	81 02/13→08/18	Construction year from: 10/13 →; Fitting Position: Front Axle Left		24.0711-5273.3 360303	
		Construction year from: 10/13 →; Fitting Position: Front Axle Right		24.0711-5274.3 360304	
		Construction year from: 10/13 →; Required quantity: 2; Vehicle Equipment: for vehicles with autom. distance control; Fitting Position: Rear Axle	2	24.0711-6337.3 360390	
1.6 TDI	85 11/16→08/20	Construction year from: 01/17 →; Fitting Position: Front Axle Left		24.0711-5273.3 360303	
		Construction year from: 01/17 →; Fitting Position: Front Axle Right		24.0711-5274.3 360304	
		Construction year from: 01/17 →; Required quantity: 2; Vehicle Equipment: for vehicles with autom. distance control; Fitting Position: Rear Axle	2	24.0711-6337.3 360390	
Control Element, parking brake caliper					
1.0 TSi	63 09/18→08/20	for PR number: 1KE / 1KJ / 1KY; Fitting Position: Rear Axle Left		11.9282-1001.3 250159	Brake System: ATE
1.0 TSi	85 05/15→08/20				
1.2 TSi	63 - 12/12→08/20 81	for PR number: 1KE / 1KJ / 1KY; Fitting Position: Rear Axle Right		11.9282-1002.3 250160	Brake System: ATE
1.4 TSi	90 - 09/12→08/20 110				
1.5 TGi	96 10/18→08/20				
1.5 TSi	96 - 09/18→08/20 110				
1.6 TDI	66 - 09/12→08/20 81				
1.8 TSi	132 02/13→08/18				
2.0 Cupra	195 - 10/13→08/20 221				
2.0 Cupra R	228 11/17→08/18				
2.0 TDI	81 - 09/12→08/20 135				
2.0 TSi	140 09/18→08/20				
1.4 TGI	81 02/13→08/18	Construction year from: 10/13 →; for PR number: 1KE / 1KJ / 1KY; Fitting Position: Rear Axle Left		11.9282-1001.3 250159	Brake System: ATE
		Construction year from: 10/13 →; for PR number: 1KE / 1KJ / 1KY; Fitting Position: Rear Axle Right		11.9282-1002.3 250160	Brake System: ATE
1.6 TDI	85 11/16→08/20	Construction year from: 01/17 →; for PR number: 1KE / 1KJ / 1KY; Fitting Position: Rear Axle Left		11.9282-1001.3 250159	Brake System: ATE
		Construction year from: 01/17 →; for PR number: 1KE / 1KJ / 1KY; Fitting Position: Rear Axle Right		11.9282-1002.3 250160	Brake System: ATE



	kW				
SEAT - LEON (KL1) 11/19→					
 Brake Caliper					
1.0 TSI	66 - 03/20→ 81	for PR number: 1ZK; Fitting Position: Front Axle Left		24.3571-1801.5 241387	Supplementary Article/Supplementary Info: without holder Brake Caliper Type: Fist-type Caliper
1.0 TSI Mild Hybrid	81 08/20→				
1.4 TSI e-Hybrid	110 - 05/20→ 150				
1.5 eTSI	110 11/19→	for PR number: 1ZK; Fitting Position: Front Axle Right		24.3571-1802.5 241388	Supplementary Article/Supplementary Info: without holder Brake Caliper Type: Fist-type Caliper
1.5 TGI CNG	96 08/20→				
1.5 TSI	96 - 11/19→ 110				
2.0 TDI	85 - 11/19→ 110				
2.0 TFSI	140 03/21→				
 Brake Disc					
1.0 TSI	66 - 03/20→ 81	for PR number: 1ZE; Fitting Position: Front Axle		24.0125-0145.1 425145	Outer diameter [mm]: 288 Brake Disc Thickness [mm] 25 Minimum thickness [mm] 22 Brake Disc Type: Vented Supplementary Article/Info 2: with bolts/screws
1.0 TSI Mild Hybrid	81 08/20→				
1.4 TSI e-Hybrid	110 - 05/20→ 150				
1.5 eTSI	110 11/19→				
1.5 TGI CNG	96 08/20→				
1.5 TSI	96 - 11/19→ 110	for PR number: 1ZK; Fitting Position: Front Axle		24.0125-0158.1 425158	Outer diameter [mm]: 312 Brake Disc Thickness [mm] 25 Minimum thickness [mm] 22 Brake Disc Type: Vented Supplementary Article/Info 2: with bolts/screws
2.0 TDI	85 - 11/19→ 110				
2.0 TFSI	140 03/21→				
		for PR number: 1KE; Fitting Position: Rear Axle		24.0110-0356.1 410356	Outer diameter [mm]: 272 Brake Disc Thickness [mm] 9.7 Minimum thickness [mm] 8 Brake Disc Type: Solid Supplementary Article/Info 2: with bolts/screws
 Wheel Speed Sensor					
1.0 TSI	66 - 03/20→ 81	Fitting Position: Front Axle Left		24.0711-5273.3 360303	
1.0 TSI Mild Hybrid	81 08/20→	Fitting Position: Front Axle Right		24.0711-5274.3 360304	
1.4 TSI e-Hybrid	110 - 05/20→ 150	Required quantity: 2; Fitting Position: Rear Axle		2 24.0711-6337.3 360390	
1.5 eTSI	110 11/19→				
1.5 TGI CNG	96 08/20→				
1.5 TSI	96 - 11/19→ 110				
2.0 TDI	85 - 11/19→ 110				
2.0 TFSI	140 03/21→				
SEAT - LEON Hatchback Van (5F1) 09/12→08/20					
 Brake Caliper					
1.0 TSI	85 05/15→08/20	for PR number: 1ZA; Fitting Position: Front Axle Left		24.3571-1801.5 241387	Supplementary Article/Supplementary Info: without holder Brake Caliper Type: Fist-type Caliper
1.2 TSI	81 04/14→08/18				
1.4 TSI	90 - 09/12→08/20 110				
1.6 TDI	66 - 09/12→10/16 81	for PR number: 1ZA; Fitting Position: Front Axle Right		24.3571-1802.5 241388	Supplementary Article/Supplementary Info: without holder Brake Caliper Type: Fist-type Caliper
1.8 TFSI	132 02/13→08/18				
2.0 Cupra	213 - 09/15→08/18 221				
2.0 TDI	110 - 10/12→08/18 135				
1.2 TSI	63 01/13→08/18	Construction year from: 04/14 →; for PR number: 1ZA; Fitting Position: Front Axle Left		24.3571-1801.5 241387	Supplementary Article/Supplementary Info: without holder Brake Caliper Type: Fist-type Caliper
		Construction year from: 04/14 →; for PR number: 1ZA; Fitting Position: Front Axle Right		24.3571-1802.5 241388	Supplementary Article/Supplementary Info: without holder Brake Caliper Type: Fist-type Caliper
1.6 TDI	85 11/16→08/20	Construction year from: 01/17 →; for PR number: 1ZA; Fitting Position: Front Axle Left		24.3571-1801.5 241387	Supplementary Article/Supplementary Info: without holder Brake Caliper Type: Fist-type Caliper
		Construction year from: 01/17 →; for PR number: 1ZA; Fitting Position: Front Axle Right		24.3571-1802.5 241388	Supplementary Article/Supplementary Info: without holder Brake Caliper Type: Fist-type Caliper
→					



	kW				
SEAT - LEON Hatchback Van (5F1) 09/12→08/20					
 Brake Disc					
1.0 TSI	85	05/15→08/20	for PR number: 1ZE; Fitting Position: Front Axle	24.0125-0145.1 425145	Outer diameter [mm]: 288 Brake Disc Thickness [mm] 25 Minimum thickness [mm] 22 Brake Disc Type: Vented Supplementary Article/Info 2: with bolts/screws
1.2 TSI	63	01/13→08/18			
	81				
1.4 TSI	90	09/12→08/20	for PR number: 1ZA; Fitting Position: Front Axle	24.0125-0158.1 425158	Outer diameter [mm]: 312 Brake Disc Thickness [mm] 25 Minimum thickness [mm] 22 Brake Disc Type: Vented Supplementary Article/Info 2: with bolts/screws
1.6 TDI	66	09/12→10/16			
	81				
1.8 TFSI	132	02/13→08/18	for PR number: 1KS / 1KE; Fitting Position: Rear Axle	24.0110-0356.1 410356	Outer diameter [mm]: 272 Brake Disc Thickness [mm] 9.7 Minimum thickness [mm] 8 Brake Disc Type: Solid Supplementary Article/Info 2: with bolts/screws
2.0 Cupra	213	09/15→08/18			
	221				
2.0 TDI	110	10/12→08/18		24.0310-0356.1 510356	Outer diameter [mm]: 272 Brake Disc Thickness [mm] 9.7 Minimum thickness [mm] 8 Brake Disc Type: Solid Supplementary Article/Info 2: with bolts/screws
	135				
1.6 TDI	85	11/16→08/20	Construction year from: 01/17 →; for PR number: 1ZE; Fitting Position: Front Axle	24.0125-0145.1 425145	Outer diameter [mm]: 288 Brake Disc Thickness [mm] 25 Minimum thickness [mm] 22 Brake Disc Type: Vented Supplementary Article/Info 2: with bolts/screws
			Construction year from: 01/17 →; for PR number: 1ZA; Fitting Position: Front Axle	24.0125-0158.1 425158	Outer diameter [mm]: 312 Brake Disc Thickness [mm] 25 Minimum thickness [mm] 22 Brake Disc Type: Vented Supplementary Article/Info 2: with bolts/screws
			for PR number: 1KS / 1KE; Fitting Position: Rear Axle	24.0110-0356.1 410356	Outer diameter [mm]: 272 Brake Disc Thickness [mm] 9.7 Minimum thickness [mm] 8 Brake Disc Type: Solid Supplementary Article/Info 2: with bolts/screws
				24.0310-0356.1 510356	Outer diameter [mm]: 272 Brake Disc Thickness [mm] 9.7 Minimum thickness [mm] 8 Brake Disc Type: Solid Supplementary Article/Info 2: with bolts/screws
 Wheel Speed Sensor					
1.0 TSI	85	05/15→08/20	Fitting Position: Front Axle Left	24.0711-5273.3 360303	
1.2 TSI	63	01/13→08/18	Fitting Position: Front Axle Right	24.0711-5274.3 360304	
	81				
1.4 TSI	90	09/12→08/20	Required quantity: 2; Vehicle Equipment: for vehicles with autom. distance control; Fitting Position: Rear Axle	2	24.0711-6337.3 360390
1.6 TDI	66	09/12→10/16			
	81				
1.8 TFSI	132	02/13→08/18			
2.0 Cupra	213	09/15→08/18			
	221				
2.0 TDI	110	10/12→08/18			
	135				
1.6 TDI	85	11/16→08/20	Construction year from: 01/17 →; Fitting Position: Front Axle Left	24.0711-5273.3 360303	
			Construction year from: 01/17 →; Fitting Position: Front Axle Right	24.0711-5274.3 360304	
			Construction year from: 01/17 →; Required quantity: 2; Vehicle Equipment: for vehicles with autom. distance control; Fitting Position: Rear Axle	2	24.0711-6337.3 360390
Control Element, parking brake caliper					
1.0 TSI	85	05/15→08/20	for PR number: 1KE / 1KJ / 1KY; Fitting Position: Rear Axle Left	11.9282-1001.3 250159	Brake System: ATE
1.2 TSI	63	01/13→08/18			
	81				
1.4 TSI	90	09/12→08/20	for PR number: 1KE / 1KJ / 1KY; Fitting Position: Rear Axle Right	11.9282-1002.3 250160	Brake System: ATE
	110				
→					



	kW				
SEAT - LEON Hatchback Van (5F1) 09/12→08/20					
Control Element, parking brake caliper					
1.6 TDI	66 - 09/12→10/16 81	for PR number: 1KE / 1KJ / 1KY; Fitting Position: Rear Axle Left	11.9282-1001.3 250159	Brake System: ATE	
1.8 TFSI 2.0 Cupra	132 02/13→08/18 213 - 09/15→08/18 221	for PR number: 1KE / 1KJ / 1KY; Fitting Position: Rear Axle Right	11.9282-1002.3 250160	Brake System: ATE	
2.0 TDI	110 - 10/12→08/18 135				
1.6 TDI	85 11/16→08/20	Construction year from: 01/17 →; for PR number: 1KE / 1KJ / 1KY; Fitting Position: Rear Axle Left	11.9282-1001.3 250159	Brake System: ATE	
		Construction year from: 01/17 →; for PR number: 1KE / 1KJ / 1KY; Fitting Position: Rear Axle Right	11.9282-1002.3 250160	Brake System: ATE	
SEAT - LEON SC (5F5) 01/13→12/18					
 Brake Caliper					
1.0 TSI 1.2 TSI	85 05/15→08/18 63 - 01/13→08/18 81	for PR number: 1ZA; Fitting Position: Front Axle Left	24.3571-1801.5 241387	Supplementary Article/Supplementary Info: without holder Brake Caliper Type: Fist-type Caliper	
1.4 TSI	90 - 02/13→08/18 110				
1.6 TDI	66 - 02/13→08/18 81	for PR number: 1ZA; Fitting Position: Front Axle Right	24.3571-1802.5 241388	Supplementary Article/Supplementary Info: without holder Brake Caliper Type: Fist-type Caliper	
1.8 TSI 2.0 Cupra	132 02/13→08/18 195 - 10/13→08/18 221				
2.0 TDI	81 - 02/13→08/18 135				
1.6 TDI	85 11/16→08/18	Construction year from: 01/17 →; for PR number: 1ZA; Fitting Position: Front Axle Left	24.3571-1801.5 241387	Supplementary Article/Supplementary Info: without holder Brake Caliper Type: Fist-type Caliper	
		Construction year from: 01/17 →; for PR number: 1ZA; Fitting Position: Front Axle Right	24.3571-1802.5 241388	Supplementary Article/Supplementary Info: without holder Brake Caliper Type: Fist-type Caliper	
 Brake Disc					
1.0 TSI 1.2 TSI	85 05/15→08/18 63 - 01/13→08/18 81	for PR number: 1ZE; Fitting Position: Front Axle	24.0125-0145.1 425145	Outer diameter [mm]: 288 Brake Disc Thickness [mm] 25 Minimum thickness [mm] 22 Brake Disc Type: Vented Supplementary Article/Info 2: with bolts/screws	
1.4 TSI	90 - 02/13→08/18 110				
1.6 TDI	66 - 02/13→08/18 81	for PR number: 1ZA; Fitting Position: Front Axle	24.0125-0158.1 425158	Outer diameter [mm]: 312 Brake Disc Thickness [mm] 25 Minimum thickness [mm] 22 Brake Disc Type: Vented Supplementary Article/Info 2: with bolts/screws	
1.8 TSI 2.0 Cupra	132 02/13→08/18 195 - 10/13→08/18 221				
2.0 TDI	110 - 02/13→08/18 135		24.0325-0158.1 525158	Outer diameter [mm]: 312 Brake Disc Thickness [mm] 25 Minimum thickness [mm] 22 Brake Disc Type: Vented Supplementary Article/Info 2: with bolts/screws	
		for PR number: 1KS / 1KE; Fitting Position: Rear Axle	24.0110-0356.1 410356	Outer diameter [mm]: 272 Brake Disc Thickness [mm] 9.7 Minimum thickness [mm] 8 Brake Disc Type: Solid Supplementary Article/Info 2: with bolts/screws	
			24.0310-0356.1 510356	Outer diameter [mm]: 272 Brake Disc Thickness [mm] 9.7 Minimum thickness [mm] 8 Brake Disc Type: Solid Supplementary Article/Info 2: with bolts/screws	
1.6 TDI	85 11/16→08/18	Construction year from: 01/17 →; for PR number: 1ZE; Fitting Position: Front Axle	24.0125-0145.1 425145	Outer diameter [mm]: 288 Brake Disc Thickness [mm] 25 Minimum thickness [mm] 22 Brake Disc Type: Vented Supplementary Article/Info 2: with bolts/screws	
→					



	kW				
SEAT - LEON SC (5F5) 01/13→12/18					
 Brake Disc					
1.6 TDI	85 11/16→08/18	Construction year from: 01/17 →; for PR number: 1ZA; Fitting Position: Front Axle	24.0125-0158.1 425158	Outer diameter [mm]: 312 Brake Disc Thickness [mm] 25 Minimum thickness [mm] 22 Brake Disc Type: Vented Supplementary Article/Info 2: with bolts/screws	
			24.0325-0158.1 525158	Outer diameter [mm]: 312 Brake Disc Thickness [mm] 25 Minimum thickness [mm] 22 Brake Disc Type: Vented Supplementary Article/Info 2: with bolts/screws	
		Construction year from: 01/17 →; for PR number: 1KS / 1KE; Fitting Position: Rear Axle	24.0110-0356.1 410356	Outer diameter [mm]: 272 Brake Disc Thickness [mm] 9.7 Minimum thickness [mm] 8 Brake Disc Type: Solid Supplementary Article/Info 2: with bolts/screws	
			24.0310-0356.1 510356	Outer diameter [mm]: 272 Brake Disc Thickness [mm] 9.7 Minimum thickness [mm] 8 Brake Disc Type: Solid Supplementary Article/Info 2: with bolts/screws	
2.0 TDI	81 - 02/13→08/18 105	for PR number: 1ZE; Fitting Position: Front Axle	24.0125-0145.1 425145	Outer diameter [mm]: 288 Brake Disc Thickness [mm] 25 Minimum thickness [mm] 22 Brake Disc Type: Vented Supplementary Article/Info 2: with bolts/screws	
		for PR number: 1ZA; Fitting Position: Front Axle	24.0125-0158.1 425158	Outer diameter [mm]: 312 Brake Disc Thickness [mm] 25 Minimum thickness [mm] 22 Brake Disc Type: Vented Supplementary Article/Info 2: with bolts/screws	
		for PR number: 1KS / 1KE; Fitting Position: Rear Axle	24.0110-0356.1 410356	Outer diameter [mm]: 272 Brake Disc Thickness [mm] 9.7 Minimum thickness [mm] 8 Brake Disc Type: Solid Supplementary Article/Info 2: with bolts/screws	
			24.0310-0356.1 510356	Outer diameter [mm]: 272 Brake Disc Thickness [mm] 9.7 Minimum thickness [mm] 8 Brake Disc Type: Solid Supplementary Article/Info 2: with bolts/screws	
 Wheel Speed Sensor					
1.0 TSI	85 05/15→08/18	Fitting Position: Front Axle Left	24.0711-5273.3 360303		
1.2 TSI	63 - 01/13→08/18 81	Fitting Position: Front Axle Right	24.0711-5274.3 360304		
1.4 TSI	90 - 02/13→08/18 110	Required quantity: 2; Vehicle Equipment: for vehicles with	2 24.0711-6337.3 360390		
1.6 TDI	66 - 02/13→08/18 81	autom. distance control; Fitting Position: Rear Axle			
1.8 TSI	132 02/13→08/18				
2.0 Cupra	195 - 10/13→08/18 221				
2.0 TDI	81 - 02/13→08/18 135				
1.6 TDI	85 11/16→08/18	Construction year from: 01/17 →; Fitting Position: Front Axle Left	24.0711-5273.3 360303		
		Construction year from: 01/17 →; Fitting Position: Front Axle Right	24.0711-5274.3 360304		
		Construction year from: 01/17 →; Required quantity: 2; Vehicle Equipment: for vehicles with autom. distance control; Fitting Position: Rear Axle	2 24.0711-6337.3 360390		
Control Element, parking brake caliper					
1.0 TSI	85 05/15→08/18	for PR number: 1KE / 1KJ / 1KY;	11.9282-1001.3 250159	Brake System: ATE	
1.2 TSI	63 - 01/13→08/18 81	Fitting Position: Rear Axle Left			
1.4 TSI	90 - 02/13→08/18 110	for PR number: 1KE / 1KJ / 1KY; Fitting Position: Rear Axle Right	11.9282-1002.3 250160	Brake System: ATE	
→					





	kW				
SEAT - LEON SC (5F5) 01/13→12/18					
Control Element, parking brake caliper					
1.6 TDI	66 - 02/13→08/18 81	for PR number: 1KE / 1KJ / 1KY; Fitting Position: Rear Axle Left		11.9282-1001.3 250159	Brake System: ATE
1.8 TSI	132 02/13→08/18	for PR number: 1KE / 1KJ / 1KY; Fitting Position: Rear Axle Right		11.9282-1002.3 250160	Brake System: ATE
2.0 Cupra	195 - 10/13→08/18 221				
2.0 TDI	81 - 02/13→08/18 135				
1.6 TDI	85 11/16→08/18	Construction year from: 01/17 →; for PR number: 1KE / 1KJ / 1KY; Fitting Position: Rear Axle Left		11.9282-1001.3 250159	Brake System: ATE
		Construction year from: 01/17 →; for PR number: 1KE / 1KJ / 1KY; Fitting Position: Rear Axle Right		11.9282-1002.3 250160	Brake System: ATE
SEAT - LEON Sportstourer (KL8) 03/20→					
 Brake Caliper					
1.0 TSI	66 - 03/20→ 81	for PR number: 1ZK; Fitting Position: Front Axle Left		24.3571-1801.5 241387	Supplementary Article/Supplementary Info: without holder Brake Caliper Type: Fist-type Caliper
1.0 TSI Mild Hybrid	81 08/20→	for PR number: 1ZK; Fitting Position: Front Axle Right		24.3571-1802.5 241388	Supplementary Article/Supplementary Info: without holder Brake Caliper Type: Fist-type Caliper
1.4 TSI e-Hybrid	110 - 05/20→ 150				
1.5 eTSI	110 03/20→				
1.5 TGI	96 05/21→				
1.5 TSI	96 - 03/20→ 110				
2.0 TDI	85 - 04/20→ 110				
2.0 TDI 4Drive	110 11/20→				
2.0 TFSI	140 03/21→				
 Brake Disc					
1.0 TSI	66 - 03/20→ 81	for PR number: 1ZE; Fitting Position: Front Axle		24.0125-0145.1 425145	Outer diameter [mm]: 288 Brake Disc Thickness [mm] 25 Minimum thickness [mm] 22 Brake Disc Type: Vented Supplementary Article/Info 2: with bolts/screws
1.0 TSI Mild Hybrid	81 08/20→	for PR number: 1ZK; Fitting Position: Front Axle		24.0125-0158.1 425158	Outer diameter [mm]: 312 Brake Disc Thickness [mm] 25 Minimum thickness [mm] 22 Brake Disc Type: Vented Supplementary Article/Info 2: with bolts/screws
1.4 TSI e-Hybrid	110 - 05/20→ 150				
1.5 eTSI	110 03/20→				
1.5 TGI	96 05/21→				
1.5 TSI	96 - 03/20→ 110				
2.0 TDI	85 - 04/20→ 110				
2.0 TDI 4Drive	110 11/20→				
2.0 TFSI	140 03/21→	for PR number: 1KE; Fitting Position: Rear Axle		24.0110-0356.1 410356	Outer diameter [mm]: 272 Brake Disc Thickness [mm] 9.7 Minimum thickness [mm] 8 Brake Disc Type: Solid Supplementary Article/Info 2: with bolts/screws
 Wheel Speed Sensor					
1.0 TSI	66 - 03/20→ 81	Fitting Position: Front Axle Left		24.0711-5273.3 360303	
1.0 TSI Mild Hybrid	81 08/20→	Fitting Position: Front Axle Right		24.0711-5274.3 360304	
1.4 TSI e-Hybrid	110 - 05/20→ 150	Required quantity: 2; Fitting Position: Rear Axle	2	24.0711-6337.3 360390	
1.5 eTSI	110 03/20→				
1.5 TGI	96 05/21→				
1.5 TSI	96 - 03/20→ 110				
2.0 TDI	85 - 04/20→ 110				
2.0 TFSI	140 03/21→				
2.0 TDI 4Drive	110 11/20→	Fitting Position: Front Axle Left		24.0711-5273.3 360303	
		Fitting Position: Front Axle Right		24.0711-5274.3 360304	
		Fitting Position: Rear Axle Left		24.0711-5401.3 360330	
				24.0711-5402.3 360331	
		Fitting Position: Rear Axle Right		24.0711-5401.3 360330	
				24.0711-5402.3 360331	
SEAT - LEON ST (5F8) 09/12→08/20					
 Brake Caliper					
1.0 TSi	63 09/18→08/20	for PR number: 1ZA;		24.3571-1801.5 241387	Supplementary Article/Supplementary Info: without holder Brake Caliper Type: Fist-type Caliper
1.0 TSI	85 05/15→08/20	Fitting Position: Front Axle Left			
1.2 TSI	63 - 08/13→08/20 81				
1.4 TGI	81 10/13→08/18				



	kW							
SEAT - LEON ST (5F8) 09/12→08/20								
 Brake Caliper								
1.4 TSI	90 - 09/12→08/20	for PR number: 1ZA; Fitting Position: Front Axle Right	24.3571-1802.5 241388	Supplementary Article/Supplementary Info: without holder Brake Caliper Type: Fist-type Caliper				
	110							
1.5 TGI	96 10/18→08/20							
1.5 TSI	96 - 09/18→08/20							
	110							
1.6 TDI	66 - 09/13→08/20							
	81							
1.6 TDI 4Drive	77 - 04/14→08/20							
	85							
1.8 TSI	132 10/13→08/18							
1.8 TSI 4Drive	132 11/14→08/18							
2.0 Cupra	195 - 10/13→08/20							
	221							
2.0 Cupra 4Drive	221 11/16→08/20							
2.0 TDI	81 - 02/13→08/20							
	135							
2.0 TDI 4Drive	110 - 04/14→08/18							
	135							
2.0 TSI	140 07/18→08/20							
2.0 TSI 4Drive	140 09/18→08/20							
1.6 TDI	85 11/16→08/20	Construction year from: 01/17 →; for PR number: 1ZA; Fitting Position: Front Axle Left	24.3571-1801.5 241387	Supplementary Article/Supplementary Info: without holder Brake Caliper Type: Fist-type Caliper				
		Construction year from: 01/17 →; for PR number: 1ZA; Fitting Position: Front Axle Right	24.3571-1802.5 241388	Supplementary Article/Supplementary Info: without holder Brake Caliper Type: Fist-type Caliper				
 Brake Disc								
1.0 TSi	63 09/18→08/20	for PR number: 1ZE; Fitting Position: Front Axle	24.0125-0145.1 425145	Outer diameter [mm]: 288 Brake Disc Thickness [mm] 25 Minimum thickness [mm] 22 Brake Disc Type: Vented Supplementary Article/Info 2: with bolts/screws				
1.0 TSI	85 05/15→08/20							
1.2 TSI	63 - 08/13→08/20							
	81							
1.4 TGI	81 10/13→08/18							
1.4 TSI	90 - 09/12→08/20							
	110							
1.5 TGI	96 10/18→08/20							
1.5 TSI	96 - 09/18→08/20							
	110							
1.6 TDI	66 - 09/13→08/20							
	81							
1.6 TDI 4Drive	77 - 04/14→08/20							
	85							
1.8 TSI	132 10/13→08/18							
1.8 TSI 4Drive	132 11/14→08/18							
2.0 Cupra	195 - 10/13→08/20							
	221							
2.0 TDI	81 - 02/13→08/20							
	135							
2.0 TDI 4Drive	110 - 04/14→08/18	for PR number: 1KS / 1KE; Fitting Position: Rear Axle	24.0110-0356.1 410356	Outer diameter [mm]: 272 Brake Disc Thickness [mm] 9.7 Minimum thickness [mm] 8 Brake Disc Type: Solid Supplementary Article/Info 2: with bolts/screws				
2.0 TSI	140 07/18→08/20							
2.0 TSI 4Drive	140 09/18→08/20							
			24.0310-0356.1 510356	Outer diameter [mm]: 272 Brake Disc Thickness [mm] 9.7 Minimum thickness [mm] 8 Brake Disc Type: Solid Supplementary Article/Info 2: with bolts/screws				
1.6 TDI	85 11/16→08/20	Construction year from: 01/17 →; for PR number: 1ZE; Fitting Position: Front Axle	24.0125-0145.1 425145	Outer diameter [mm]: 288 Brake Disc Thickness [mm] 25 Minimum thickness [mm] 22 Brake Disc Type: Vented Supplementary Article/Info 2: with bolts/screws				
		Construction year from: 01/17 →; for PR number: 1ZA; Fitting Position: Front Axle				24.0125-0158.1 425158	Outer diameter [mm]: 312 Brake Disc Thickness [mm] 25 Minimum thickness [mm] 22 Brake Disc Type: Vented Supplementary Article/Info 2: with bolts/screws	

	kW				
SEAT - LEON ST (5F8) 09/12→08/20					
 Brake Disc					
1.6 TDI	85	11/16→08/20	Construction year from: 01/17 →; for PR number: 1KS / 1KE; Fitting Position: Rear Axle	24.0110-0356.1 410356	Outer diameter [mm]: 272 Brake Disc Thickness [mm] 9.7 Minimum thickness [mm] 8 Brake Disc Type: Solid Supplementary Article/Info 2: with bolts/screws
				24.0310-0356.1 510356	Outer diameter [mm]: 272 Brake Disc Thickness [mm] 9.7 Minimum thickness [mm] 8 Brake Disc Type: Solid Supplementary Article/Info 2: with bolts/screws
2.0 Cupra	213	10/15→08/20	for PR number: 1ZE; Fitting Position: Front Axle	24.0125-0145.1 425145	Outer diameter [mm]: 288 Brake Disc Thickness [mm] 25 Minimum thickness [mm] 22 Brake Disc Type: Vented Supplementary Article/Info 2: with bolts/screws
			for PR number: 1ZA; Fitting Position: Front Axle	24.0125-0158.1 425158	Outer diameter [mm]: 312 Brake Disc Thickness [mm] 25 Minimum thickness [mm] 22 Brake Disc Type: Vented Supplementary Article/Info 2: with bolts/screws
				24.0325-0158.1 525158	Outer diameter [mm]: 312 Brake Disc Thickness [mm] 25 Minimum thickness [mm] 22 Brake Disc Type: Vented Supplementary Article/Info 2: with bolts/screws
2.0 Cupra 4Drive	221	11/16→08/20	for PR number: 1ZA; Fitting Position: Front Axle	24.0325-0158.1 525158	Outer diameter [mm]: 312 Brake Disc Thickness [mm] 25 Minimum thickness [mm] 22 Brake Disc Type: Vented Supplementary Article/Info 2: with bolts/screws
2.0 TDI	105	10/13→08/18	for PR number: 1ZE; Fitting Position: Front Axle	24.0125-0145.1 425145	Outer diameter [mm]: 288 Brake Disc Thickness [mm] 25 Minimum thickness [mm] 22 Brake Disc Type: Vented Supplementary Article/Info 2: with bolts/screws
			for PR number: 1ZA; Fitting Position: Front Axle	24.0125-0158.1 425158	Outer diameter [mm]: 312 Brake Disc Thickness [mm] 25 Minimum thickness [mm] 22 Brake Disc Type: Vented Supplementary Article/Info 2: with bolts/screws
			for PR number: 1KS / 1KE; Fitting Position: Rear Axle	24.0110-0356.1 410356	Outer diameter [mm]: 272 Brake Disc Thickness [mm] 9.7 Minimum thickness [mm] 8 Brake Disc Type: Solid Supplementary Article/Info 2: with bolts/screws
				24.0310-0356.1 510356	Outer diameter [mm]: 272 Brake Disc Thickness [mm] 9.7 Minimum thickness [mm] 8 Brake Disc Type: Solid Supplementary Article/Info 2: with bolts/screws
 Wheel Speed Sensor					
1.0 TSi	63	09/18→08/20	Fitting Position: Front Axle Left	24.0711-5273.3 360303	
1.0 TSi	85	05/15→08/20	Fitting Position: Front Axle Right	24.0711-5274.3 360304	
1.2 TSi	63 -	08/13→08/20			
	81		Required quantity: 2; Vehicle Equipment: for vehicles with autom. distance control; Fitting Position: Rear Axle	2	24.0711-6337.3 360390
1.4 TGI	81	10/13→08/18			
1.4 TSi	90 -	09/12→08/20			
	110				
1.5 TGI	96	10/18→08/20			
1.5 TSi	96 -	09/18→08/20			
	110				
1.6 TDI	66 -	09/13→08/20			
	81				
1.8 TSi	132	10/13→08/18			
2.0 Cupra	195 -	10/13→08/20			
	221				
2.0 TDI	81 -	02/13→08/20			
	135				
→					





	kW				
SEAT - LEON ST (5F8) 09/12→08/20					
 Wheel Speed Sensor					
2.0 TSI	140 07/18→08/20	Fitting Position: Front Axle Left		24.0711-5273.3	360303
		Fitting Position: Front Axle Right		24.0711-5274.3	360304
		Required quantity: 2; Vehicle Equipment: for vehicles with autom. distance control; Fitting Position: Rear Axle	2	24.0711-6337.3	360390
1.6 TDI	85 11/16→08/20	Construction year from: 01/17 →; Fitting Position: Front Axle Left		24.0711-5273.3	360303
		Construction year from: 01/17 →; Fitting Position: Front Axle Right		24.0711-5274.3	360304
		Construction year from: 01/17 →; Required quantity: 2; Vehicle Equipment: for vehicles with autom. distance control; Fitting Position: Rear Axle	2	24.0711-6337.3	360390
1.6 TDI 4Drive	77 - 04/14→08/20	Fitting Position: Front Axle Left		24.0711-5273.3	360303
	85	Fitting Position: Front Axle Right		24.0711-5274.3	360304
1.8 TSI 4Drive	132 11/14→08/18	Vehicle Equipment: for vehicles with autom. distance control; Fitting Position: Rear Axle Left		24.0711-5401.3	360330
2.0 Cupra 4Drive	221 11/16→08/20				
2.0 TDI 4Drive	110 - 04/14→08/18				
	135				
2.0 TSI 4Drive	140 09/18→08/20	Vehicle Equipment: for vehicles with autom. distance control; Fitting Position: Rear Axle Right		24.0711-5402.3	360331
Control Element, parking brake caliper					
1.0 TSi	63 09/18→08/20	for PR number: 1KE / 1KJ / 1KY; Fitting Position: Rear Axle Left		11.9282-1001.3	250159 Brake System: ATE
1.0 TSI	85 05/15→08/20				
1.2 TSI	63 - 08/13→08/20	for PR number: 1KE / 1KJ / 1KY; Fitting Position: Rear Axle Right		11.9282-1002.3	250160 Brake System: ATE
	81				
1.4 TGI	81 10/13→08/18				
1.4 TSI	90 - 09/12→08/20				
	110				
1.5 TGI	96 10/18→08/20				
1.5 TSI	96 - 09/18→08/20				
	110				
1.6 TDI	66 - 09/13→08/20				
	81				
1.6 TDI 4Drive	77 - 04/14→08/20				
	85				
1.8 TSI	132 10/13→08/18				
1.8 TSI 4Drive	132 11/14→08/18				
2.0 Cupra	195 - 10/13→08/20				
	221				
2.0 Cupra 4Drive	221 11/16→08/20				
2.0 TDI	81 - 02/13→08/20				
	135				
2.0 TDI 4Drive	110 - 04/14→08/18				
	135				
2.0 TSI	140 07/18→08/20				
2.0 TSI 4Drive	140 09/18→08/20				
1.6 TDI	85 11/16→08/20	Construction year from: 01/17 →; for PR number: 1KE / 1KJ / 1KY; Fitting Position: Rear Axle Left		11.9282-1001.3	250159 Brake System: ATE
		Construction year from: 01/17 →; for PR number: 1KE / 1KJ / 1KY; Fitting Position: Rear Axle Right		11.9282-1002.3	250160 Brake System: ATE
SEAT - LEON ST Estate Van (5F8) 01/13→08/20					
 Brake Caliper					
1.0 TSI	85 05/15→08/20	for PR number: 1ZA; Fitting Position: Front Axle Left		24.3571-1801.5	241387 Supplementary Article/Supplementary Info: without holder Brake Caliper Type: Fist-type Caliper
1.2 TSI	63 - 01/13→08/18				
	81				
1.4 TSI	110 05/14→08/20				
1.6 TDI	81 09/13→08/20	for PR number: 1ZA; Fitting Position: Front Axle Right		24.3571-1802.5	241388 Supplementary Article/Supplementary Info: without holder Brake Caliper Type: Fist-type Caliper
1.8 TFSI	132 10/13→08/18				
2.0 Cupra	206 - 10/13→08/20				
	221				
2.0 Cupra 4Drive	221 11/16→08/18				
2.0 TDI	110 - 04/13→08/18				
	135				
2.0 TDI 4Drive	110 09/14→08/18				
1.6 TDI	85 11/16→08/20	Construction year from: 01/17 →; for PR number: 1ZA; Fitting Position: Front Axle Left		24.3571-1801.5	241387 Supplementary Article/Supplementary Info: without holder Brake Caliper Type: Fist-type Caliper
→					





	kW				
SEAT - LEON ST Estate Van (5F8) 01/13→08/20					
 Brake Caliper					
1.6 TDI	85	11/16→08/20	Construction year from: 01/17 →; for PR number: 1ZA; Fitting Position: Front Axle Right	24.3571-1802.5 241388	Supplementary Article/Supplementary Info: without holder Brake Caliper Type: Fist-type Caliper
2.0 TDI 4Drive	135	10/14→08/18	Construction year from: 11/14 →; for PR number: 1ZA; Fitting Position: Front Axle Left	24.3571-1801.5 241387	Supplementary Article/Supplementary Info: without holder Brake Caliper Type: Fist-type Caliper
			Construction year from: 11/14 →; for PR number: 1ZA; Fitting Position: Front Axle Right	24.3571-1802.5 241388	Supplementary Article/Supplementary Info: without holder Brake Caliper Type: Fist-type Caliper
 Brake Disc					
1.0 TSI	85	05/15→08/20	for PR number: 1ZE; Fitting Position: Front Axle	24.0125-0145.1 425145	Outer diameter [mm]: 288 Brake Disc Thickness [mm] 25 Minimum thickness [mm] 22 Brake Disc Type: Vented Supplementary Article/Info 2: with bolts/screws
1.2 TSI	63 - 81	01/13→08/18			
1.4 TSI	110	05/14→08/20	for PR number: 1ZA; Fitting Position: Front Axle	24.0125-0158.1 425158	Outer diameter [mm]: 312 Brake Disc Thickness [mm] 25 Minimum thickness [mm] 22 Brake Disc Type: Vented Supplementary Article/Info 2: with bolts/screws
1.6 TDI	81	09/13→08/20			
1.8 TFSI	132	10/13→08/18	for PR number: 1KS / 1KE; Fitting Position: Rear Axle	24.0110-0356.1 410356	Outer diameter [mm]: 272 Brake Disc Thickness [mm] 9.7 Minimum thickness [mm] 8 Brake Disc Type: Solid Supplementary Article/Info 2: with bolts/screws
2.0 Cupra	206 - 221	10/13→08/20			
2.0 Cupra 4Drive	221	11/16→08/18	for PR number: 1KS / 1KE; Fitting Position: Rear Axle	24.0310-0356.1 510356	Outer diameter [mm]: 272 Brake Disc Thickness [mm] 9.7 Minimum thickness [mm] 8 Brake Disc Type: Solid Supplementary Article/Info 2: with bolts/screws
2.0 TDI	110 - 135	04/13→08/18			
2.0 TDI 4Drive	110 - 135	09/14→08/18			
1.6 TDI	85	11/16→08/20	Construction year from: 01/17 →; for PR number: 1ZE; Fitting Position: Front Axle	24.0125-0145.1 425145	Outer diameter [mm]: 288 Brake Disc Thickness [mm] 25 Minimum thickness [mm] 22 Brake Disc Type: Vented Supplementary Article/Info 2: with bolts/screws
			Construction year from: 01/17 →; for PR number: 1ZA; Fitting Position: Front Axle	24.0125-0158.1 425158	Outer diameter [mm]: 312 Brake Disc Thickness [mm] 25 Minimum thickness [mm] 22 Brake Disc Type: Vented Supplementary Article/Info 2: with bolts/screws
			Construction year from: 01/17 →; for PR number: 1KS / 1KE; Fitting Position: Rear Axle	24.0110-0356.1 410356	Outer diameter [mm]: 272 Brake Disc Thickness [mm] 9.7 Minimum thickness [mm] 8 Brake Disc Type: Solid Supplementary Article/Info 2: with bolts/screws
				24.0310-0356.1 510356	Outer diameter [mm]: 272 Brake Disc Thickness [mm] 9.7 Minimum thickness [mm] 8 Brake Disc Type: Solid Supplementary Article/Info 2: with bolts/screws
 Wheel Speed Sensor					
1.0 TSI	85	05/15→08/20	Fitting Position: Front Axle Left	24.0711-5273.3 360303	
1.2 TSI	63 - 81	01/13→08/18	Fitting Position: Front Axle Right	24.0711-5274.3 360304	
1.4 TSI	110	05/14→08/20	Required quantity: 2; Vehicle Equipment: for vehicles with autom. distance control; Fitting Position: Rear Axle	2	24.0711-6337.3 360390
1.6 TDI	81	09/13→08/20			
1.8 TFSI	132	10/13→08/18			
2.0 Cupra	206 - 221	10/13→08/20			
2.0 TDI	110 - 135	04/13→08/18			
1.6 TDI	85	11/16→08/20	Construction year from: 01/17 →; Fitting Position: Front Axle Left	24.0711-5273.3 360303	
			Construction year from: 01/17 →; Fitting Position: Front Axle Right	24.0711-5274.3 360304	





	kW				
SEAT - LEON ST Estate Van (5F8) 01/13→08/20					
 Wheel Speed Sensor					
1.6 TDI	85	11/16→08/20	Construction year from: 01/17 →; Required quantity: 2; Vehicle Equipment: for vehicles with autom. distance control; Fitting Position: Rear Axle	2	24.0711-6337.3 360390
2.0 Cupra 4Drive	221	11/16→08/18	Fitting Position: Front Axle Left		24.0711-5273.3 360303
2.0 TDI 4Drive	110 - 135	09/14→08/18	Fitting Position: Front Axle Right		24.0711-5274.3 360304
			Vehicle Equipment: for vehicles with autom. distance control; Fitting Position: Rear Axle Left		24.0711-5401.3 360330
			Vehicle Equipment: for vehicles with autom. distance control; Fitting Position: Rear Axle Right		24.0711-5402.3 360331
Control Element, parking brake caliper					
1.0 TSI	85	05/15→08/20	for PR number: 1KE / 1KJ / 1KY; Fitting Position: Rear Axle Left		11.9282-1001.3 250159 Brake System: ATE
1.2 TSI	63 - 81	01/13→08/18	for PR number: 1KE / 1KJ / 1KY; Fitting Position: Rear Axle Right		11.9282-1002.3 250160 Brake System: ATE
1.4 TSI	110	05/14→08/20			
1.6 TDI	81	09/13→08/20			
1.8 TFSI	132	10/13→08/18			
2.0 Cupra	206 - 221	10/13→08/20			
2.0 Cupra 4Drive	221	11/16→08/18			
2.0 TDI	110 - 135	04/13→08/18			
2.0 TDI 4Drive	110 - 135	09/14→08/18			
1.6 TDI	85	11/16→08/20	Construction year from: 01/17 →; for PR number: 1KE / 1KJ / 1KY; Fitting Position: Rear Axle Left		11.9282-1001.3 250159 Brake System: ATE
			Construction year from: 01/17 →; for PR number: 1KE / 1KJ / 1KY; Fitting Position: Rear Axle Right		11.9282-1002.3 250160 Brake System: ATE
SEAT - Mii (KF1, KE1) 10/11→					
Guide Sleeve Kit, brake caliper					
electric	61	01/20→	Required quantity: 2; Fitting Position: Front Axle	2	11.0101-5407.2 260011 Brake System: ATE
Guide Bolt, brake caliper					
electric	61	01/20→	Required quantity: 2; Fitting Position: Front Axle	2	11.8171-0008.1 990049 Brake System: ATE
 Wheel Speed Sensor					
1.0	44 - 55	10/11→07/19	Construction year from: 05/12 →; Fitting Position: Front Axle Left		24.0711-5273.3 360303
			Construction year from: 05/12 →; Fitting Position: Front Axle Right		24.0711-5274.3 360304
1.0 EcoFuel	50	10/12→07/19	Fitting Position: Front Axle Left		24.0711-5273.3 360303
electric	61	01/20→	Fitting Position: Front Axle Right		24.0711-5274.3 360304
SEAT - TARRACO (KN2) 09/18→					
 Brake Caliper					
1.4 e-HYBRID	180	02/21→	for PR number: 1ZK; Fitting Position: Front Axle Left		24.3571-1801.5 241387 Supplementary Article/Supplementary Info: without holder Brake Caliper Type: Fist-type Caliper
1.4 TSI Plug in Hybrid	110	02/21→			
1.5 TSI ACT	110	09/18→			
2.0 TDI	110	09/18→			
2.0 TDI 4Drive	110 - 147	09/18→	for PR number: 1ZK; Fitting Position: Front Axle Right		24.3571-1802.5 241388 Supplementary Article/Supplementary Info: without holder Brake Caliper Type: Fist-type Caliper
2.0 TFSI 4Drive	180	01/21→			
2.0 TSI 4Drive	140	11/18→			
 Brake Disc					
1.4 e-HYBRID	180	02/21→	for PR number: 1ZK; Fitting Position: Front Axle		24.0125-0158.1 425158 Outer diameter [mm]: 312 Brake Disc Thickness [mm] 25 Minimum thickness [mm] 22 Brake Disc Type: Vented Supplementary Article/Info 2: with bolts/screws
1.4 TSI Plug in Hybrid	110	02/21→			
1.5 TSI ACT	110	09/18→			
2.0 TDI	110	09/18→			
2.0 TDI 4Drive	110 - 147	09/18→			
2.0 TFSI 4Drive	180	01/21→			
2.0 TSI 4Drive	140	11/18→			





	kw				
SEAT - TARRACO (KN2) 09/18→					
 Brake Disc					
1.4 e-HYBRID	180 02/21→		for PR number: 1KU / 2EM; Fitting Position: Rear Axle	24.0112-0210.1 412210	Outer diameter [mm]: 300 Brake Disc Thickness [mm] 12 Minimum thickness [mm] 10 Brake Disc Type: Solid Supplementary Article/Info 2: with bolts/screws
1.4 TSI Plug in Hybrid	110 02/21→				
1.5 TSI ACT	110 09/18→				
2.0 TDI	110 09/18→				
2.0 TDI 4Drive	110 - 09/18→				
	147				
2.0 TFSI 4Drive	180 01/21→				
2.0 TSI 4Drive	140 11/18→				
 Wheel Speed Sensor					
1.4 e-HYBRID	180 02/21→		Fitting Position: Front Axle Left	24.0711-5273.3 360303	
1.4 TSI Plug in Hybrid	110 02/21→		Fitting Position: Front Axle Right	24.0711-5274.3 360304	
			for PR number: 3KP; Fitting Position: Rear Axle Left	24.0711-5401.3 360330	
			for PR number: 3KP; Fitting Position: Rear Axle Right	24.0711-5402.3 360331	
1.5 TSI ACT	110 09/18→		Fitting Position: Front Axle Left	24.0711-5273.3 360303	
2.0 TDI	110 09/18→		Fitting Position: Front Axle Right	24.0711-5274.3 360304	
			for PR number: 3KP; Fitting Position: Rear Axle Left	24.0711-5401.3 360330	
			for PR number: 3KP; Fitting Position: Rear Axle Right	24.0711-5402.3 360331	
			for PR number: 5KC; Required quantity: 2; Fitting Position: Rear Axle	2 24.0711-6337.3 360390	
2.0 TDI 4Drive	110 - 09/18→		Fitting Position: Front Axle Left	24.0711-5273.3 360303	
	140		Fitting Position: Front Axle Right	24.0711-5274.3 360304	
2.0 TSI 4Drive	140 11/18→		Fitting Position: Rear Axle Left	24.0711-5401.3 360330	
			Construction year from: 12/19 →; Fitting Position: Rear Axle Left	24.0711-5401.3 360330	
			Fitting Position: Rear Axle Right	24.0711-5402.3 360331	
			Construction year from: 12/19 →; Fitting Position: Rear Axle Right	24.0711-5402.3 360331	
2.0 TDI 4Drive	147 07/20→		Fitting Position: Front Axle Left	24.0711-5273.3 360303	
			Fitting Position: Front Axle Right	24.0711-5274.3 360304	
			Fitting Position: Rear Axle Left	24.0711-5401.3 360330	
			Fitting Position: Rear Axle Right	24.0711-5402.3 360331	
2.0 TFSI 4Drive	180 01/21→		Fitting Position: Rear Axle Left	24.0711-5401.3 360330	
			Fitting Position: Rear Axle Right	24.0711-5402.3 360331	
Control Element, parking brake caliper					
1.4 e-HYBRID	180 02/21→		Fitting Position: Rear Axle Left	11.9282-1001.3 250159	Brake System: ATE
1.4 TSI Plug in Hybrid	110 02/21→		Fitting Position: Rear Axle Right	11.9282-1002.3 250160	Brake System: ATE
1.5 TSI ACT	110 09/18→				
2.0 TDI	110 09/18→				
2.0 TDI 4Drive	110 - 09/18→				
	147				
2.0 TFSI 4Drive	180 01/21→				
2.0 TSI 4Drive	140 11/18→				
SEAT - TOLEDO II (1M2) 10/98→05/06					
Guide Bolt, brake caliper					
1.4 16V	55 01/00→05/02		for PR number: 1LJ / 1ZQ; Required quantity: 2	2 11.8171-0008.1 990049	Brake System: ATE
1.6	74 10/98→07/04				
1.8 20V	92 10/98→07/04		for PR number: 1LN / 1LE / 1ZE / 1ZH; Required quantity: 2;	2 11.8171-0008.1 990049	Brake System: ATE
1.9 TDI	74 - 10/00→05/06		Fitting Position: Front Axle		
	110				
1.9 TDI 4Drive	110 10/00→10/05				
2.3 V5	110 10/98→11/00				
2.3 V5 20V	125 09/00→11/03				
1.6 16V	77 06/00→05/06		→ Construction year to: 09/04; for PR number: 1LJ / 1ZQ; Required quantity: 2	2 11.8171-0008.1 990049	Brake System: ATE
1.9 TDI	96 05/03→05/06		→ Construction year to: 09/04; for PR number: 1LN / 1LE / 1ZE / 1ZH; Required quantity: 2;	2 11.8171-0008.1 990049	Brake System: ATE
			Fitting Position: Front Axle		
1.8 20VT	132 09/00→07/04		Construction year from: 05/01 →; for PR number: 1LJ / 1ZQ; Required quantity: 2	2 11.8171-0008.1 990049	Brake System: ATE
			Construction year from: 05/01 →; for PR number: 1LN / 1LE / 1ZE / 1ZH; Required quantity: 2;	2 11.8171-0008.1 990049	Brake System: ATE
			Fitting Position: Front Axle		
→					



	kW				
SEAT - TOLEDO II (1M2) 10/98→05/06					
Guide Bolt, brake caliper					
1.9 TDI	66 03/99→07/04	Construction year from: 04/99 →; for PR number: 1ZQ; Required quantity: 2	2	11.8171-0008.1 990049	Brake System: ATE
		Construction year from: 04/99 →; for PR number: 1LN / 1LE / 1ZE / 1ZH; Required quantity: 2; Fitting Position: Front Axle	2	11.8171-0008.1 990049	Brake System: ATE
1.9 TDI	81 10/98→07/04	for PR number: 1ZQ; Required quantity: 2	2	11.8171-0008.1 990049	Brake System: ATE
		for PR number: 1LN / 1LE / 1ZE / 1ZH; Required quantity: 2; Fitting Position: Front Axle	2	11.8171-0008.1 990049	Brake System: ATE
SEAT - TOLEDO III (5P2) 04/04→05/09					
Guide Bolt, brake caliper					
1.4 16V 1.4 TSI 1.6 1.8 TFSI 1.9 TDI 2.0 FSI 2.0 TDI 2.0 TFSI	63 05/06→05/09 92 11/07→05/09 75 10/04→05/09 118 01/07→05/09 77 10/04→05/09 110 10/04→05/09 103 - 11/05→05/09 125 147 11/05→05/09	→ Construction year to: 03/09; for PR number: 1ZE; Required quantity: 2	2	11.8171-0008.1 990049	Brake System: ATE
2.0 TDI 2.0 TDI 16V	100 09/04→05/09 103 04/04→05/09	Construction year from: 10/04 → → Construction year to: 03/09; for PR number: 1ZE; Required quantity: 2	2	11.8171-0008.1 990049	Brake System: ATE
 Brake Disc					
1.4 16V 1.4 TSI 1.6 1.8 TFSI 1.9 TDI 2.0 FSI 2.0 TDI 2.0 TFSI	63 05/06→05/09 92 11/07→05/09 75 10/04→05/09 118 01/07→05/09 77 10/04→05/09 110 10/04→05/09 103 - 11/05→05/09 125 147 11/05→05/09	→ Construction year to: 03/09; for PR number: 1ZE; Fitting Position: Front Axle		24.0125-0145.1 425145	Outer diameter [mm]: 288 Brake Disc Thickness [mm] 25 Minimum thickness [mm] 22 Brake Disc Type: Vented Supplementary Article/Info 2: with bolts/screws
2.0 TDI 2.0 TDI 16V	100 09/04→05/09 103 04/04→05/09	Construction year from: 10/04 → → Construction year to: 03/09; for PR number: 1ZE; Fitting Position: Front Axle		24.0125-0145.1 425145	Outer diameter [mm]: 288 Brake Disc Thickness [mm] 25 Minimum thickness [mm] 22 Brake Disc Type: Vented Supplementary Article/Info 2: with bolts/screws
SEAT - TOLEDO IV (KG3) 07/12→04/19					
Guide Sleeve Kit, brake caliper					
1.0 TSI 1.2 TSI 1.4 TDI 1.4 TSI 1.6 TDI	70 - 05/17→04/19 81 66 - 05/15→05/17 81 66 05/15→04/19 92 05/15→04/19 85 05/15→04/19	for PR number: 1ZC; Fitting Position: Front Axle		11.0101-5407.2 260011	Brake System: ATE
1.2 1.2 TSI 1.4 TSI 1.6 1.6 TDI	55 07/12→06/15 63 - 07/12→06/15 77 90 07/12→06/15 77 - 07/13→04/19 81 66 - 07/12→06/15 77	for brake disc diameter [mm]: 288; Fitting Position: Front Axle		11.0101-5407.2 260011	Brake System: ATE
Guide Bolt, brake caliper					
1.0 TSI 1.2 TSI 1.4 TDI 1.4 TSI 1.6 TDI	70 - 05/17→04/19 81 66 - 05/15→05/17 81 66 05/15→04/19 92 05/15→04/19 85 05/15→04/19	for PR number: 1ZC; Required quantity: 2	2	11.8171-0008.1 990049	Brake System: ATE
1.2 1.2 TSI	55 07/12→06/15 63 - 07/12→06/15 77	for PR number: 1ZG; Required quantity: 2	2	11.8171-0008.1 990049	Brake System: ATE
1.4 TSI 1.6	90 07/12→06/15 77 - 07/13→04/19 81	for brake disc diameter [mm]: 288; Required quantity: 2	2	11.8171-0008.1 990049	Brake System: ATE
→					

	kW			
SKODA - FABIA I (6Y2) 08/99→03/08				
 Wheel Speed Sensor				
1.0 1.4	37 12/99→08/02 50 08/99→05/03	Construction year from: 02/00 →; Fitting Position: Front Axle Left		24.0711-5273.3 360303
		Construction year from: 02/00 →; Fitting Position: Front Axle Right		24.0711-5274.3 360304
1.2	40 07/01→04/07	Construction year from: 08/02 →; Fitting Position: Front Axle Left		24.0711-5273.3 360303
		Construction year from: 08/02 →; Fitting Position: Front Axle Right		24.0711-5274.3 360304
1.2 1.4 16V	47 01/03→03/08 55 - 12/99→03/08 74	→ Construction year to: 12/07; Fitting Position: Front Axle Left		24.0711-5273.3 360303
1.4 TDI	51 - 04/03→03/08 59	→ Construction year to: 12/07; Fitting Position: Front Axle Right		24.0711-5274.3 360304
1.9 SDI	47 12/99→03/08			
2.0	85 12/99→03/08			
1.4	44 - 08/00→10/06 59	Fitting Position: Front Axle Left		24.0711-5273.3 360303
		Fitting Position: Front Axle Right		24.0711-5274.3 360304
1.9 TDI	74 01/00→03/08	Construction year from: 02/00 → → Construction year to: 12/07; Fitting Position: Front Axle Left		24.0711-5273.3 360303
		Construction year from: 02/00 → → Construction year to: 12/07; Fitting Position: Front Axle Right		24.0711-5274.3 360304
1.9 TDI RS	96 06/03→03/08	Construction year from: 09/03 → → Construction year to: 12/07; Fitting Position: Front Axle Left		24.0711-5273.3 360303
		Construction year from: 09/03 → → Construction year to: 12/07; Fitting Position: Front Axle Right		24.0711-5274.3 360304
SKODA - FABIA I Combi (6Y5) 04/00→12/07				
 Wheel Speed Sensor				
1.2	40 07/01→12/07	Construction year from: 08/02 →; Fitting Position: Front Axle Left		24.0711-5273.3 360303
		Construction year from: 08/02 →; Fitting Position: Front Axle Right		24.0711-5274.3 360304
1.2 1.4	47 01/03→12/07 44 - 04/00→05/03 50	Fitting Position: Front Axle Left		24.0711-5273.3 360303
1.4 16V	55 - 04/00→12/07 74	Fitting Position: Front Axle Right		24.0711-5274.3 360304
1.4 TDI	51 - 04/03→12/07 59			
1.9 SDI	47 04/00→12/07			
1.9 TDI	74 04/00→12/07			
2.0	85 04/00→12/07			
SKODA - FABIA I Praktik (6Y5) 01/00→12/07				
 Wheel Speed Sensor				
1.2	40 07/01→12/07	Construction year from: 08/02 →; Fitting Position: Front Axle Left		24.0711-5273.3 360303
		Construction year from: 08/02 →; Fitting Position: Front Axle Right		24.0711-5274.3 360304
1.2 1.4	47 01/03→12/07 44 - 04/00→12/07 55	Fitting Position: Front Axle Left		24.0711-5273.3 360303
1.4 TDI	51 - 08/04→12/07 55	Fitting Position: Front Axle Right		24.0711-5274.3 360304
1.9 SDI	47 07/01→12/07			
1.9 TDI	74 01/00→12/07	Construction year from: 02/00 →; Fitting Position: Front Axle Left		24.0711-5273.3 360303
		Construction year from: 02/00 →; Fitting Position: Front Axle Right		24.0711-5274.3 360304
SKODA - FABIA I Saloon (6Y3) 10/99→12/07				
 Wheel Speed Sensor				
1.2	40 07/01→12/07	Construction year from: 08/02 →; Fitting Position: Front Axle Left		24.0711-5273.3 360303
		Construction year from: 08/02 →; Fitting Position: Front Axle Right		24.0711-5274.3 360304
1.2 1.4	47 01/03→12/07 44 - 04/00→05/03 50	Fitting Position: Front Axle Left		24.0711-5273.3 360303
1.4 16V	55 - 10/99→12/07 74	Fitting Position: Front Axle Right		24.0711-5274.3 360304
→				

	kW				
SKODA - FABIA I Saloon (6Y3) 10/99→12/07					
 Wheel Speed Sensor					
1.4 TDI	51 - 04/03→12/07 59		Fitting Position: Front Axle Left		24.0711-5273.3 360303
2.0	85 12/99→12/07		Fitting Position: Front Axle Right		24.0711-5274.3 360304
1.9 SDI	47 11/99→12/07		Construction year from: 12/99 →; Fitting Position: Front Axle Left		24.0711-5273.3 360303
			Construction year from: 12/99 →; Fitting Position: Front Axle Right		24.0711-5274.3 360304
1.9 TDI	74 01/00→12/07		Construction year from: 02/00 →; Fitting Position: Front Axle Left		24.0711-5273.3 360303
			Construction year from: 02/00 →; Fitting Position: Front Axle Right		24.0711-5274.3 360304
SKODA - FABIA II (542) 12/06→12/14					
 Wheel Speed Sensor					
1.2	44 - 12/06→12/14 51		Construction year from: 03/07 → → Construction year to: 06/14; Fitting Position: Front Axle Left		24.0711-5273.3 360303
1.4	63 01/07→12/14				
1.4 LPG	63 01/07→11/14		Construction year from: 03/07 → → Construction year to: 06/14; Fitting Position: Front Axle Right		24.0711-5274.3 360304
1.2 12V	44 11/11→12/14		→ Construction year to: 06/14;		24.0711-5273.3 360303
1.2 LPG	51 07/07→11/14		Fitting Position: Front Axle Left		
1.2 TDI	55 05/10→12/14		→ Construction year to: 06/14;		24.0711-5274.3 360304
1.2 TSI	63 - 03/10→12/14 77		Fitting Position: Front Axle Right		
1.4 TSI RS	132 05/10→12/14				
1.6	77 04/07→12/14				
1.6 TDI	55 - 03/10→12/14 77				
1.2 12V	55 10/10→12/14		Fitting Position: Front Axle Left		24.0711-5273.3 360303
1.2 LPG	44 03/09→11/11		Fitting Position: Front Axle Right		24.0711-5274.3 360304
1.9 TDI	77 04/07→03/10				
1.4 TDI	51 - 01/07→03/10 59		Construction year from: 03/07 →; Fitting Position: Front Axle Left		24.0711-5273.3 360303
			Construction year from: 03/07 →; Fitting Position: Front Axle Right		24.0711-5274.3 360304
SKODA - FABIA II Combi (545) 10/07→12/14					
 Wheel Speed Sensor					
1.2	44 - 10/07→12/14 51		→ Construction year to: 06/14; Fitting Position: Front Axle Left		24.0711-5273.3 360303
1.2 12V	44 11/11→12/14		→ Construction year to: 06/14;		24.0711-5274.3 360304
1.2 LPG	51 10/07→11/14		Fitting Position: Front Axle Right		
1.2 TDI	55 05/10→12/14				
1.2 TSI	63 - 03/10→12/14 77				
1.4	63 10/07→12/14				
1.4 LPG	63 10/07→11/14				
1.4 TSI RS	132 05/10→12/14				
1.6	77 10/07→12/14				
1.6 TDI	55 - 03/10→12/14 77				
1.2 LPG	44 03/09→11/11		Fitting Position: Front Axle Left		24.0711-5273.3 360303
1.4 TDI	51 - 10/07→03/10 59		Fitting Position: Front Axle Right		24.0711-5274.3 360304
1.9 TDI	77 10/07→03/10				
SKODA - FABIA III (NJ3) 08/14→					
Guide Bolt, brake caliper					
1.0	44 - 08/14→ 55		for PR number: 1ZC; Required quantity: 2	2	11.8171-0008.1 990049 Brake System: ATE
1.0 TSI	70 - 08/14→ 81		for PR number: 1ZG; Required quantity: 2;	2	11.8171-0008.1 990049 Brake System: ATE
1.2 TSI	66 - 08/14→ 81		Fitting Position: Front Axle		
1.4 TDI	66 - 08/14→ 77				
1.4 TSI R5	92 02/18→				
1.6	81 01/15→				
1.4 TDI	55 05/15→		for PR number: 1ZC; Required quantity: 2	2	11.8171-0008.1 990049 Brake System: ATE
 Wheel Speed Sensor					
1.0	44 - 08/14→ 55		Fitting Position: Front Axle Left		24.0711-5273.3 360303
1.0 TSI	70 - 08/14→ 81		Fitting Position: Front Axle Right		24.0711-5274.3 360304
→					

	kW				
SKODA - FABIA III (NJ3) 08/14→					
 Wheel Speed Sensor					
1.2 TSI	66 - 08/14→ 81		Fitting Position: Front Axle Left	24.0711-5273.3	360303
1.4 TDI	55 - 08/14→ 77		Fitting Position: Front Axle Right	24.0711-5274.3	360304
1.4 TSI R5	92 02/18→				
1.6	81 01/15→				
SKODA - FABIA III Estate (NJ5) 08/14→					
Guide Bolt, brake caliper					
1.0	44 - 10/14→ 55		for PR number: 1ZC; Required quantity: 2	2	11.8171-0008.1 990049 Brake System: ATE
1.0 TSI	70 - 08/14→ 81		for PR number: 1ZG; Required quantity: 2;	2	11.8171-0008.1 990049 Brake System: ATE
1.2 TSI	66 - 10/14→ 81		Fitting Position: Front Axle		
1.4 TDI	66 - 10/14→ 77				
1.6	81 01/15→				
1.4 TDI	55 05/15→		for PR number: 1ZC; Required quantity: 2	2	11.8171-0008.1 990049 Brake System: ATE
 Wheel Speed Sensor					
1.0	44 - 10/14→ 55		Fitting Position: Front Axle Left	24.0711-5273.3	360303
1.0 TSI	70 - 08/14→ 81		Fitting Position: Front Axle Right	24.0711-5274.3	360304
1.2 TSI	66 - 10/14→ 81				
1.4 TDI	55 - 10/14→ 77				
1.6	81 01/15→				
SKODA - KAMIQ (NW4) 07/19→					
 Wheel Speed Sensor					
1.0 TGI CNG	66 11/19→		→ Construction year to: 11/19;	24.0711-5273.3	360303
1.0 TSI	70 - 07/19→ 85		Fitting Position: Front Axle Left	24.0711-5274.3	360304
1.5 TSI	110 07/19→		→ Construction year to: 11/19;		
1.6 SRE	81 07/19→		Fitting Position: Front Axle Right		
1.6 TDI	70 - 07/19→ 85				
SKODA - KAROQ (NU7, ND7) 07/17→					
 Brake Caliper					
1.0 TSI	81 - 07/17→ 85		for PR number: 1ZA / 1ZK; Fitting Position: Front Axle Left	24.3571-1801.5	241387 Supplementary Article/Supplementary Info: without holder Brake Caliper Type: Fist-type Caliper
1.4 TSI	110 07/17→				
1.4 TSI 4x4	110 09/19→				
1.5 TSI	110 07/17→				
1.5 TSI 4x4	110 07/17→		for PR number: 1ZA / 1ZK; Fitting Position: Front Axle Right	24.3571-1802.5	241388 Supplementary Article/Supplementary Info: without holder Brake Caliper Type: Fist-type Caliper
1.6 SRE	81 07/17→				
1.6 TDI	85 07/17→				
2.0 TDI	85 - 07/17→ 110				
2.0 TDI 4x4	85 - 07/17→ 140				
2.0 TSI 4x4	140 04/19→				
 Brake Pad Set, disc brake					
1.0 TSI	81 - 07/17→ 85		for PR number: 1ZE / 1ZJ / 9U0; Fitting Position: Front Axle	13.0460-2609.2	602609 Brake System: Lucas / TRW 25683 20,4 Wear Warning Contact: prepared for wear indicator / excl. wear warning contact
1.4 TSI	110 07/17→				
1.4 TSI 4x4	110 09/19→				
1.5 TSI	110 07/17→				
1.5 TSI 4x4	110 07/17→				
1.6 SRE	81 07/17→				
1.6 TDI	85 07/17→				
2.0 TDI	85 - 07/17→ 110			13.0470-2609.2	LD2609 Brake System: Lucas / TRW Wear Warning Contact: prepared for wear indicator / excl. wear warning contact Ceramic
2.0 TDI 4x4	85 - 07/17→ 140				
2.0 TSI 4x4	140 04/19→				

	kW				
SKODA - KAROQ (NU7, ND7) 07/17→					
 Brake Disc					
1.0 TSI	81 - 07/17→		for PR number: 1ZE / 1ZJ; Fitting Position: Front Axle	24.0125-0145.1 425145	Outer diameter [mm]: 288 Brake Disc Thickness [mm] 25 Minimum thickness [mm] 22 Brake Disc Type: Vented Supplementary Article/Info 2: with bolts/screws
1.4 TSI	110 07/17→				
1.4 TSI 4x4	110 09/19→				
1.5 TSI	110 07/17→				
1.5 TSI 4x4	110 07/17→				
1.6 SRE	81 07/17→				
1.6 TDI	85 07/17→		for PR number: 1ZA / 1ZK; Fitting Position: Front Axle	24.0125-0158.1 425158	Outer diameter [mm]: 312 Brake Disc Thickness [mm] 25 Minimum thickness [mm] 22 Brake Disc Type: Vented Supplementary Article/Info 2: with bolts/screws
2.0 TDI	85 - 07/17→				
	110				
2.0 TDI 4x4	85 - 07/17→				
	140				
2.0 TSI 4x4	140 04/19→		for PR number: 1KE / 2EJ; Observe dimensions; Fitting Position: Rear Axle	24.0110-0356.1 410356	Outer diameter [mm]: 272 Brake Disc Thickness [mm] 9.7 Minimum thickness [mm] 8 Brake Disc Type: Solid Supplementary Article/Info 2: with bolts/screws
 Wheel Speed Sensor					
1.0 TSI	81 - 07/17→		Fitting Position: Front Axle Left	24.0711-5273.3 360303	
	85		Fitting Position: Front Axle Right	24.0711-5274.3 360304	
1.4 TSI	110 07/17→				
1.5 TSI	110 07/17→		Required quantity: 2; for PR number: 0N4; Fitting Position: Rear Axle	2 24.0711-6337.3 360390	
1.6 SRE	81 07/17→				
1.6 TDI	85 07/17→				
2.0 TDI	85 - 07/17→				
	110				
1.4 TSI 4x4	110 09/19→		Fitting Position: Front Axle Left	24.0711-5273.3 360303	
2.0 TDI 4x4	85 07/20→		Fitting Position: Front Axle Right	24.0711-5274.3 360304	
2.0 TSI 4x4	140 04/19→		Fitting Position: Rear Axle Left	24.0711-5401.3 360330	
			Fitting Position: Rear Axle Right	24.0711-5402.3 360331	
			Required quantity: 2; Fitting Position: Rear Axle	2 24.0711-6337.3 360390	
1.5 TSI 4x4	110 07/17→		Fitting Position: Front Axle Left	24.0711-5273.3 360303	
2.0 TDI 4x4	110 - 07/17→		Fitting Position: Front Axle Right	24.0711-5274.3 360304	
	140		Fitting Position: Rear Axle Left	24.0711-5401.3 360330	
			Fitting Position: Rear Axle Right	24.0711-5402.3 360331	
Control Element, parking brake caliper					
1.0 TSI	81 - 07/17→		for PR number: 1KE; Fitting Position: Rear Axle Left	11.9282-1001.3 250159	Brake System: ATE
	85				
1.4 TSI	110 07/17→		for PR number: 1KE; Fitting Position: Rear Axle Right	11.9282-1002.3 250160	Brake System: ATE
1.4 TSI 4x4	110 09/19→				
1.5 TSI	110 07/17→				
1.5 TSI 4x4	110 07/17→				
1.6 SRE	81 07/17→				
1.6 TDI	85 07/17→				
2.0 TDI	85 - 07/17→				
	110				
2.0 TDI 4x4	85 - 07/17→				
	140				
2.0 TSI 4x4	140 04/19→				
SKODA - KODIAQ (NS7, NV7, NS6) 10/16→					
 Brake Caliper					
1.4 TSI	92 - 10/16→		for PR number: 1ZA / 1ZK; Fitting Position: Front Axle Left	24.3571-1801.5 241387	Supplementary Article/Supplementary Info: without holder Brake Caliper Type: Fist-type Caliper
	110				
1.4 TSI 4x4	110 10/16→				
1.5 TSI	110 07/18→				
1.5 TSI 4x4	110 07/18→				
2.0 RS 4x4	180 06/21→		for PR number: 1ZA / 1ZK; Fitting Position: Front Axle Right	24.3571-1802.5 241388	Supplementary Article/Supplementary Info: without holder Brake Caliper Type: Fist-type Caliper
2.0 RS Bi-TDI 4x4	176 11/18→				
2.0 TDI	110 10/16→				
2.0 TDI 4x4	110 - 10/16→				
	147				
2.0 TSI 4x4	132 - 10/16→				
	140				
 Brake Disc					
1.4 TSI	92 - 10/16→		for PR number: 1ZA / 1ZK; Fitting Position: Front Axle	24.0125-0158.1 425158	Outer diameter [mm]: 312 Brake Disc Thickness [mm] 25 Minimum thickness [mm] 22 Brake Disc Type: Vented Supplementary Article/Info 2: with bolts/screws
	110				
1.4 TSI 4x4	110 10/16→				
1.5 TSI	110 07/18→				
1.5 TSI 4x4	110 07/18→				
2.0 RS 4x4	180 06/21→				

	kW				
SKODA - KODIAQ (NS7, NV7, NS6) 10/16→					
 Brake Disc					
2.0 RS Bi-TDI 4x4	176 11/18→		for PR number: 1ZA / 1ZK; Fitting Position: Front Axle	24.0325-0158.1 525158	Outer diameter [mm]: 312 Brake Disc Thickness [mm] 25 Minimum thickness [mm] 22 Brake Disc Type: Vented Supplementary Article/Info 2: with bolts/screws
2.0 TDI	110 10/16→				
2.0 TDI 4x4	110 - 10/16→				
	147				
2.0 TSI 4x4	132 - 10/16→				
	140				
			for PR number: 1KU / 2EM; Fitting Position: Rear Axle	24.0112-0210.1 412210	Outer diameter [mm]: 300 Brake Disc Thickness [mm] 12 Minimum thickness [mm] 10 Brake Disc Type: Solid Supplementary Article/Info 2: with bolts/screws
 Wheel Speed Sensor					
1.4 TSI	92 - 10/16→		Fitting Position: Front Axle Left	24.0711-5273.3 360303	
	110				
1.5 TSI	110 07/18→		Fitting Position: Front Axle Right	24.0711-5274.3 360304	
2.0 TDI	110 10/16→		Required quantity: 2; → Construction year to: 07/20; Fitting Position: Rear Axle	2 24.0711-6337.3 360390	
1.4 TSI 4x4	110 10/16→		Fitting Position: Front Axle Left	24.0711-5273.3 360303	
1.5 TSI 4x4	110 07/18→		Fitting Position: Front Axle Right	24.0711-5274.3 360304	
2.0 RS Bi-TDI 4x4	176 11/18→		→ Construction year to: 11/19; Fitting Position: Rear Axle Left	24.0711-5401.3 360330	
2.0 TDI 4x4	110 - 10/16→				
	140				
2.0 TSI 4x4	132 - 10/16→		Construction year from: 12/19 →; Fitting Position: Rear Axle Left	24.0711-5401.3 360330	
	140		Construction year from: 12/19 →; Fitting Position: Rear Axle Right	24.0711-5402.3 360331	
			→ Construction year to: 11/19; Fitting Position: Rear Axle Right	24.0711-5402.3 360331	
2.0 RS 4x4	180 06/21→		Fitting Position: Front Axle Left	24.0711-5273.3 360303	
2.0 TDI 4x4	147 06/20→		Fitting Position: Front Axle Right	24.0711-5274.3 360304	
			Fitting Position: Rear Axle Left	24.0711-5401.3 360330	
			Fitting Position: Rear Axle Right	24.0711-5402.3 360331	
Control Element, parking brake caliper					
1.4 TSI	92 - 10/16→		Fitting Position: Rear Axle Left	11.9282-1001.3 250159	Brake System: ATE
	110				
1.4 TSI 4x4	110 10/16→		Fitting Position: Rear Axle Right	11.9282-1002.3 250160	Brake System: ATE
1.5 TSI	110 07/18→				
1.5 TSI 4x4	110 07/18→				
2.0 RS 4x4	180 06/21→				
2.0 RS Bi-TDI 4x4	176 11/18→				
2.0 TDI	110 10/16→				
2.0 TDI 4x4	110 - 10/16→				
	147				
2.0 TSI 4x4	132 - 10/16→				
	140				
SKODA - OCTAVIA I (1U2) 09/96→12/10					
Guide Bolt, brake caliper					
1.4	44 04/99→03/01		for PR number: 1LN / 1LE / 1ZD / 1ZE / 1ZH; Required quantity: 2	2 11.8171-0008.1 990049	Brake System: ATE
1.6	74 02/97→12/07				
1.8 T 4x4	110 05/01→05/06				
1.9 SDI	50 06/97→12/03				
1.9 TDI	81 08/97→01/06				
2.0	85 04/99→05/07				
1.4 16V	55 09/00→12/10		→ Construction year to: 06/10; for PR number: 1LN / 1LE / 1ZD / 1ZE / 1ZH; Required quantity: 2	2 11.8171-0008.1 990049	Brake System: ATE
1.9 TDI	74 10/05→12/10				
1.6	55 09/96→09/04		Construction year from: 10/96 →; for PR number: 1LN / 1LE / 1ZD / 1ZE / 1ZH; Required quantity: 2	2 11.8171-0008.1 990049	Brake System: ATE
1.8	92 09/96→07/00				
1.9 TDI	66 09/96→03/10				
1.6	75 11/00→12/10		for PR number: 1LE; for PR number: 1ZD; for PR number: 1ZE; → Construction year to: 06/10; for PR number: 1ZH; Required quantity: 2	2 11.8171-0008.1 990049	Brake System: ATE
1.8 T	110 08/97→12/10		Construction year from: 03/98 → → Construction year to: 06/10; for PR number: 1LN / 1LE / 1ZD / 1ZE / 1ZH; Required quantity: 2	2 11.8171-0008.1 990049	Brake System: ATE
1.9 TDI	96 09/02→09/04		Construction year from: 01/03 →; for PR number: 1LN / 1LE / 1ZD / 1ZE / 1ZH; Required quantity: 2	2 11.8171-0008.1 990049	Brake System: ATE
→					



	kW				
SKODA - OCTAVIA I (1U2) 09/96→12/10					
Guide Bolt, brake caliper					
RS 1.8 T	132	05/01→01/06	for PR number: 1ZN; Required quantity: 2	2	11.8171-0008.1 990049 Brake System: ATE
SKODA - OCTAVIA I Combi (1U5) 07/98→12/10					
Guide Bolt, brake caliper					
1.4 16V 1.8 T 1.9 TDI 2.0 4x4	55 110 74 88	08/00→12/10 07/98→12/10 08/00→12/10 01/00→12/10	→ Construction year to: 06/10; for PR number: 1LN / 1LE / 1ZD / 1ZE / 1ZH; Required quantity: 2	2	11.8171-0008.1 990049 Brake System: ATE
1.6 1.8 20V 1.8 T 4x4 1.9 SDI 1.9 TDI 1.9 TDI 4x4 2.0	55 - 74 92 110 50 66 - 81 66 - 74 85	07/98→12/07 07/98→07/00 05/01→05/06 07/98→12/03 07/98→03/10 11/99→02/06 04/99→05/07	for PR number: 1LN / 1LE / 1ZD / 1ZE / 1ZH; Required quantity: 2	2	11.8171-0008.1 990049 Brake System: ATE
1.6	75	09/00→12/10	for PR number: 1LE; for PR number: 1ZD; for PR number: 1ZE; → Construction year to: 06/10; for PR number: 1ZH; Required quantity: 2	2	11.8171-0008.1 990049 Brake System: ATE
1.9 TDI	96	09/02→09/04	Construction year from: 01/03 →; for PR number: 1LN / 1LE / 1ZD / 1ZE / 1ZH; Required quantity: 2	2	11.8171-0008.1 990049 Brake System: ATE
2.0 4x4	85	08/00→09/04	Construction year from: 05/01 →; for PR number: 1LN / 1LE / 1ZD / 1ZE / 1ZH; Required quantity: 2	2	11.8171-0008.1 990049 Brake System: ATE
RS 1.8 T	132	08/02→01/06	for PR number: 1ZN; Required quantity: 2	2	11.8171-0008.1 990049 Brake System: ATE
SKODA - OCTAVIA I Estate Van (1U5) 08/00→03/10					
Guide Bolt, brake caliper					
1.9 D 1.9 TDI	50 66	08/00→12/03 08/00→03/10	for PR number: 1LN / 1LE / 1ZD / 1ZE / 1ZH; Required quantity: 2	2	11.8171-0008.1 990049 Brake System: ATE
SKODA - OCTAVIA II (1Z3) 02/04→06/13					
Guide Bolt, brake caliper					
1.2 TSI 1.4 1.4 TSI 1.6 1.6 TDI 1.8 TSI 2.0 TDI	77 59 90 75 77 112 - 118 81	02/10→06/13 06/04→04/13 11/08→06/13 06/04→06/13 06/09→04/13 06/07→06/13 03/10→06/13	→ Construction year to: 01/13; for PR number: 1ZE; Required quantity: 2	2	11.8171-0008.1 990049 Brake System: ATE
1.4 1.6 FSI 2.0 TDI	55 85 100	05/04→05/06 02/04→10/08 02/04→05/10	Construction year from: 06/04 →; for PR number: 1ZE; Required quantity: 2	2	11.8171-0008.1 990049 Brake System: ATE
1.6 LPG	75	08/09→11/12	Construction year from: 09/09 →; for PR number: 1ZE; Required quantity: 2	2	11.8171-0008.1 990049 Brake System: ATE
1.6 MultiFuel	75	01/08→06/13	Construction year from: 09/09 → → Construction year to: 01/13; for PR number: 1ZE; Required quantity: 2	2	11.8171-0008.1 990049 Brake System: ATE
1.9 TDI 2.0 FSI 2.0 TDI	77 110 103	06/04→12/10 11/04→10/08 11/05→05/10	for PR number: 1ZE; Required quantity: 2	2	11.8171-0008.1 990049 Brake System: ATE
2.0 TDI 16V	103	02/04→04/13	Construction year from: 06/04 → → Construction year to: 01/13; for PR number: 1ZE; Required quantity: 2	2	11.8171-0008.1 990049 Brake System: ATE
2.0 TDI RS	125	04/06→02/13	for PR number: 1LL / 1LP / 1ZB; Required quantity: 2	2	11.8171-0008.1 990049 Brake System: ATE
2.0 TFSI	147	10/05→02/13	→ Construction year to: 01/13; for PR number: 1LL / 1LP / 1ZB; Required quantity: 2	2	11.8171-0008.1 990049 Brake System: ATE
→					



	kW				
SKODA - OCTAVIA II (1Z3) 02/04→06/13					
 Brake Disc					
1.2 TSI 1.4 1.4 TSI 1.6 1.6 TDI 1.8 TSI	77 02/10→06/13 59 06/04→04/13 90 11/08→06/13 75 06/04→06/13 77 06/09→04/13 112 - 06/07→06/13 118	→ Construction year to: 01/13; for PR number: 1ZE; Fitting Position: Front Axle		24.0125-0145.1 425145	Outer diameter [mm]: 288 Brake Disc Thickness [mm] 25 Minimum thickness [mm] 22 Brake Disc Type: Vented Supplementary Article/Info 2: with bolts/screws
2.0 TDI	81 03/10→06/13	→ Construction year to: 01/13; for PR number: 1KS / 1KT; Fitting Position: Rear Axle		24.0110-0356.1 410356 24.0310-0356.1 510356	Outer diameter [mm]: 272 Brake Disc Thickness [mm] 9.7 Minimum thickness [mm] 8 Brake Disc Type: Solid Supplementary Article/Info 2: with bolts/screws Outer diameter [mm]: 272 Brake Disc Thickness [mm] 9.7 Minimum thickness [mm] 8 Brake Disc Type: Solid Supplementary Article/Info 2: with bolts/screws
1.4 1.6 FSI 2.0 TDI	55 05/04→05/06 85 02/04→10/08 100 02/04→05/10	Construction year from: 06/04 →; for PR number: 1ZE; Fitting Position: Front Axle		24.0125-0145.1 425145	Outer diameter [mm]: 288 Brake Disc Thickness [mm] 25 Minimum thickness [mm] 22 Brake Disc Type: Vented Supplementary Article/Info 2: with bolts/screws
		Construction year from: 06/04 →; for PR number: 1KS / 1KT; Fitting Position: Rear Axle		24.0110-0356.1 410356 24.0310-0356.1 510356	Outer diameter [mm]: 272 Brake Disc Thickness [mm] 9.7 Minimum thickness [mm] 8 Brake Disc Type: Solid Supplementary Article/Info 2: with bolts/screws Outer diameter [mm]: 272 Brake Disc Thickness [mm] 9.7 Minimum thickness [mm] 8 Brake Disc Type: Solid Supplementary Article/Info 2: with bolts/screws
1.6 LPG	75 08/09→11/12	Construction year from: 09/09 →; for PR number: 1ZE; Fitting Position: Front Axle		24.0125-0145.1 425145	Outer diameter [mm]: 288 Brake Disc Thickness [mm] 25 Minimum thickness [mm] 22 Brake Disc Type: Vented Supplementary Article/Info 2: with bolts/screws
		Construction year from: 09/09 →; for PR number: 1KS / 1KT; Fitting Position: Rear Axle		24.0110-0356.1 410356 24.0310-0356.1 510356	Outer diameter [mm]: 272 Brake Disc Thickness [mm] 9.7 Minimum thickness [mm] 8 Brake Disc Type: Solid Supplementary Article/Info 2: with bolts/screws Outer diameter [mm]: 272 Brake Disc Thickness [mm] 9.7 Minimum thickness [mm] 8 Brake Disc Type: Solid Supplementary Article/Info 2: with bolts/screws
1.6 MultiFuel	75 01/08→06/13	Construction year from: 09/09 →; for PR number: 1ZE; → Construction year to: 01/13; Fitting Position: Front Axle		24.0125-0145.1 425145	Outer diameter [mm]: 288 Brake Disc Thickness [mm] 25 Minimum thickness [mm] 22 Brake Disc Type: Vented Supplementary Article/Info 2: with bolts/screws
		Construction year from: 09/09 →; for PR number: 1KS / 1KT; → Construction year to: 01/13; Fitting Position: Rear Axle		24.0110-0356.1 410356 24.0310-0356.1 510356	Outer diameter [mm]: 272 Brake Disc Thickness [mm] 9.7 Minimum thickness [mm] 8 Brake Disc Type: Solid Supplementary Article/Info 2: with bolts/screws Outer diameter [mm]: 272 Brake Disc Thickness [mm] 9.7 Minimum thickness [mm] 8 Brake Disc Type: Solid Supplementary Article/Info 2: with bolts/screws
1.9 TDI 2.0 FSI 2.0 TDI	77 06/04→12/10 110 11/04→10/08 103 11/05→05/10	for PR number: 1ZE; Fitting Position: Front Axle		24.0125-0145.1 425145	Outer diameter [mm]: 288 Brake Disc Thickness [mm] 25 Minimum thickness [mm] 22 Brake Disc Type: Vented Supplementary Article/Info 2: with bolts/screws
→					



		kW					
SKODA - OCTAVIA II (1Z3) 02/04→06/13							
 Brake Disc							
1.9 TDI 2.0 FSI 2.0 TDI	77 06/04→12/10 110 11/04→10/08 103 11/05→05/10	for PR number: 1KS / 1KT; Fitting Position: Rear Axle		24.0110-0356.1 410356	Outer diameter [mm]: 272 Brake Disc Thickness [mm] 9.7 Minimum thickness [mm] 8 Brake Disc Type: Solid Supplementary Article/Info 2: with bolts/screws		
				24.0310-0356.1 510356	Outer diameter [mm]: 272 Brake Disc Thickness [mm] 9.7 Minimum thickness [mm] 8 Brake Disc Type: Solid Supplementary Article/Info 2: with bolts/screws		
2.0 TDI 16V	103 02/04→04/13	Construction year from: 06/04 → → Construction year to: 01/13; for PR number: 1ZE; Fitting Position: Front Axle		24.0125-0145.1 425145	Outer diameter [mm]: 288 Brake Disc Thickness [mm] 25 Minimum thickness [mm] 22 Brake Disc Type: Vented Supplementary Article/Info 2: with bolts/screws		
		Construction year from: 06/04 → → Construction year to: 01/13; for PR number: 1KS / 1KT; Fitting Position: Rear Axle		24.0110-0356.1 410356	Outer diameter [mm]: 272 Brake Disc Thickness [mm] 9.7 Minimum thickness [mm] 8 Brake Disc Type: Solid Supplementary Article/Info 2: with bolts/screws		
				24.0310-0356.1 510356	Outer diameter [mm]: 272 Brake Disc Thickness [mm] 9.7 Minimum thickness [mm] 8 Brake Disc Type: Solid Supplementary Article/Info 2: with bolts/screws		
2.0 TDI RS	125 04/06→02/13	for PR number: 1LL / 1LP / 1ZB; Fitting Position: Front Axle		24.0125-0158.1 425158	Outer diameter [mm]: 312 Brake Disc Thickness [mm] 25 Minimum thickness [mm] 22 Brake Disc Type: Vented Supplementary Article/Info 2: with bolts/screws		
				24.0325-0158.1 525158	Outer diameter [mm]: 312 Brake Disc Thickness [mm] 25 Minimum thickness [mm] 22 Brake Disc Type: Vented Supplementary Article/Info 2: with bolts/screws		
		for PR number: 1KS / 1KT; Fitting Position: Rear Axle		24.0110-0356.1 410356	Outer diameter [mm]: 272 Brake Disc Thickness [mm] 9.7 Minimum thickness [mm] 8 Brake Disc Type: Solid Supplementary Article/Info 2: with bolts/screws		
				24.0310-0356.1 510356	Outer diameter [mm]: 272 Brake Disc Thickness [mm] 9.7 Minimum thickness [mm] 8 Brake Disc Type: Solid Supplementary Article/Info 2: with bolts/screws		
2.0 TFSI	147 10/05→02/13	→ Construction year to: 01/13; for PR number: 1LL / 1LP / 1ZB; Fitting Position: Front Axle		24.0125-0158.1 425158	Outer diameter [mm]: 312 Brake Disc Thickness [mm] 25 Minimum thickness [mm] 22 Brake Disc Type: Vented Supplementary Article/Info 2: with bolts/screws		
				24.0325-0158.1 525158	Outer diameter [mm]: 312 Brake Disc Thickness [mm] 25 Minimum thickness [mm] 22 Brake Disc Type: Vented Supplementary Article/Info 2: with bolts/screws		
		→ Construction year to: 01/13; for PR number: 1KS / 1KT; Fitting Position: Rear Axle		24.0110-0356.1 410356	Outer diameter [mm]: 272 Brake Disc Thickness [mm] 9.7 Minimum thickness [mm] 8 Brake Disc Type: Solid Supplementary Article/Info 2: with bolts/screws		
				24.0310-0356.1 510356	Outer diameter [mm]: 272 Brake Disc Thickness [mm] 9.7 Minimum thickness [mm] 8 Brake Disc Type: Solid Supplementary Article/Info 2: with bolts/screws		

		kW					
SKODA - OCTAVIA II Combi (1Z5) 02/04→06/13							
 Brake Disc							
1.6 LPG	75	08/09→11/12	Construction year from: 09/09 →; for PR number: 1ZE; Fitting Position: Front Axle		24.0125-0145.1	425145	Outer diameter [mm]: 288 Brake Disc Thickness [mm] 25 Minimum thickness [mm] 22 Brake Disc Type: Vented Supplementary Article/Info 2: with bolts/screws
			Construction year from: 09/09 →; for PR number: 1KS / 1KT; Fitting Position: Rear Axle				24.0110-0356.1
1.6 MultiFuel	75	01/08→06/13	Construction year from: 09/09 →; for PR number: 1ZE; → Construction year to: 01/13; Fitting Position: Front Axle		24.0125-0145.1	425145	Outer diameter [mm]: 288 Brake Disc Thickness [mm] 25 Minimum thickness [mm] 22 Brake Disc Type: Vented Supplementary Article/Info 2: with bolts/screws
			Construction year from: 09/09 →; for PR number: 1KS / 1KT; → Construction year to: 01/13; Fitting Position: Rear Axle				24.0110-0356.1
1.9 TDI 1.9 TDI 4x4 2.0 FSI 2.0 FSI 4x4 2.0 TDI 2.0 TDI 4x4	77	09/04→12/10 11/04→12/10	for PR number: 1ZE; Fitting Position: Front Axle		24.0125-0145.1	425145	Outer diameter [mm]: 288 Brake Disc Thickness [mm] 25 Minimum thickness [mm] 22 Brake Disc Type: Vented Supplementary Article/Info 2: with bolts/screws
			for PR number: 1KS / 1KT; Fitting Position: Rear Axle				24.0110-0356.1
110 110 103 103	11/04→10/08 11/04→04/09 11/05→05/10 07/06→05/10				24.0125-0145.1	425145	Outer diameter [mm]: 288 Brake Disc Thickness [mm] 25 Minimum thickness [mm] 22 Brake Disc Type: Vented Supplementary Article/Info 2: with bolts/screws
							24.0110-0356.1
2.0 TDI 16V	103	02/04→05/13	Construction year from: 06/04 → → Construction year to: 01/13; for PR number: 1ZE; Fitting Position: Front Axle		24.0125-0145.1	425145	Outer diameter [mm]: 288 Brake Disc Thickness [mm] 25 Minimum thickness [mm] 22 Brake Disc Type: Vented Supplementary Article/Info 2: with bolts/screws
			Construction year from: 06/04 → → Construction year to: 01/13; for PR number: 1KS / 1KT; Fitting Position: Rear Axle				24.0110-0356.1
2.0 TDI RS	125	04/06→02/13	for PR number: 1LL / 1LP / 1ZB; Fitting Position: Front Axle		24.0125-0158.1	425158	Outer diameter [mm]: 312 Brake Disc Thickness [mm] 25 Minimum thickness [mm] 22 Brake Disc Type: Vented Supplementary Article/Info 2: with bolts/screws
							24.0110-0356.1



→

		kW					
SKODA - OCTAVIA II Combi (1Z5) 02/04→06/13							
 Brake Disc							
2.0 TDI RS	125 04/06→02/13	for PR number: 1LL / 1LP / 1ZB; Fitting Position: Front Axle		24.0325-0158.1 525158	Outer diameter [mm]: 312 Brake Disc Thickness [mm] 25 Minimum thickness [mm] 22 Brake Disc Type: Vented Supplementary Article/Info 2: with bolts/screws		
		for PR number: 1KS / 1KT; Fitting Position: Rear Axle			24.0110-0356.1 410356	Outer diameter [mm]: 272 Brake Disc Thickness [mm] 9.7 Minimum thickness [mm] 8 Brake Disc Type: Solid Supplementary Article/Info 2: with bolts/screws	
				24.0310-0356.1 510356	Outer diameter [mm]: 272 Brake Disc Thickness [mm] 9.7 Minimum thickness [mm] 8 Brake Disc Type: Solid Supplementary Article/Info 2: with bolts/screws		
2.0 TFSI	147 10/05→02/13	→ Construction year to: 01/13; for PR number: 1LL / 1LP / 1ZB; Fitting Position: Front Axle		24.0125-0158.1 425158	Outer diameter [mm]: 312 Brake Disc Thickness [mm] 25 Minimum thickness [mm] 22 Brake Disc Type: Vented Supplementary Article/Info 2: with bolts/screws		
		for PR number: 1KS / 1KT; → Construction year to: 01/13; Fitting Position: Rear Axle			24.0110-0356.1 410356	Outer diameter [mm]: 272 Brake Disc Thickness [mm] 9.7 Minimum thickness [mm] 8 Brake Disc Type: Solid Supplementary Article/Info 2: with bolts/screws	
				24.0310-0356.1 510356	Outer diameter [mm]: 272 Brake Disc Thickness [mm] 9.7 Minimum thickness [mm] 8 Brake Disc Type: Solid Supplementary Article/Info 2: with bolts/screws		
SKODA - OCTAVIA III (5E3, NL3, NR3) 11/12→03/21							
 Brake Caliper							
1.0 TSI	85 05/16→10/20	for PR number: 1ZK; Fitting Position: Front Axle Left		24.3571-1801.5 241387	Supplementary Article/Supplementary Info: without holder Brake Caliper Type: Fist-type Caliper		
1.2 TSI	81 05/15→02/17						
1.4 TSI	103 11/12→02/17						
1.4 TSI G-TEC	81 11/13→02/17						
1.5 TSI	110 02/17→10/20	for PR number: 1ZK; Fitting Position: Front Axle Right		24.3571-1802.5 241388	Supplementary Article/Supplementary Info: without holder Brake Caliper Type: Fist-type Caliper		
1.6	81 01/14→10/20						
1.6 TDI	81 - 05/13→10/20						
	85						
1.6 TDI 4x4	77 - 05/13→10/20						
	85						
1.8 TSI	132 11/12→10/20						
1.8 TSI 4x4	132 05/14→10/20						
2.0 TDI	105 11/12→02/17						
2.0 TDI 4x4	110 05/13→10/20						
2.0 TDI RS	135 05/13→10/20						
2.0 TSI	140 02/17→10/20						
2.0 TSI 4x4	140 02/19→10/20						
2.0 TSI RS	162 - 05/13→10/20						
	180						
1.2 TSI	63 - 11/12→02/17	Construction year from: 02/13 →; for PR number: 1ZK; Fitting Position: Front Axle Left		24.3571-1801.5 241387	Supplementary Article/Supplementary Info: without holder Brake Caliper Type: Fist-type Caliper		
1.6 TDI	66 - 11/12→10/20						
	77						
2.0 TDI	110 11/12→10/20	Construction year from: 02/13 →; for PR number: 1ZK; Fitting Position: Front Axle Right		24.3571-1802.5 241388	Supplementary Article/Supplementary Info: without holder Brake Caliper Type: Fist-type Caliper		
1.4 TSI	110 08/14→10/20	Construction year from: 05/15 →; for PR number: 1ZK; Fitting Position: Front Axle Left		24.3571-1801.5 241387	Supplementary Article/Supplementary Info: without holder Brake Caliper Type: Fist-type Caliper		
→							

		kW									
SKODA - OCTAVIA III (5E3, NL3, NR3) 11/12→03/21											
 Brake Caliper											
1.4 TSI	110	08/14→10/20	Construction year from: 05/15 →; for PR number: 1ZK; Fitting Position: Front Axle Right		24.3571-1802.5	241388	Supplementary Article/Supplementary Info: without holder Brake Caliper Type: Fist-type Caliper				
2.0 TDI / TDI RS 4x4	135	05/13→10/20	Construction year from: 09/14 →; for PR number: 1ZK; Fitting Position: Front Axle Left		24.3571-1801.5	241387	Supplementary Article/Supplementary Info: without holder Brake Caliper Type: Fist-type Caliper				
			Construction year from: 09/14 →; for PR number: 1ZK; Fitting Position: Front Axle Right		24.3571-1802.5	241388	Supplementary Article/Supplementary Info: without holder Brake Caliper Type: Fist-type Caliper				
 Brake Disc											
1.0 TSI	85	05/16→10/20	for PR number: 1ZJ; Fitting Position: Front Axle		24.0125-0145.1	425145	Outer diameter [mm]: 288 Brake Disc Thickness [mm] 25 Minimum thickness [mm] 22 Brake Disc Type: Vented Supplementary Article/Info 2: with bolts/screws				
1.2 TSI	81	05/15→02/17									
1.4 TSI	103	11/12→02/17									
1.4 TSI G-TEC	81	11/13→02/17									
1.5 TSI	110	02/17→10/20									
1.6 TDI	81 - 85	05/13→10/20									
1.6 TDI 4x4	77 - 85	05/13→10/20	for PR number: 1ZK / 1ZU; Fitting Position: Front Axle		24.0125-0158.1	425158	Outer diameter [mm]: 312 Brake Disc Thickness [mm] 25 Minimum thickness [mm] 22 Brake Disc Type: Vented Supplementary Article/Info 2: with bolts/screws				
1.8 TSI	132	11/12→10/20									
1.8 TSI 4x4	132	05/14→10/20									
2.0 TDI / TDI RS 4x4	135	05/13→10/20									
2.0 TDI 4x4	110	05/13→10/20									
2.0 TDI RS	135	05/13→10/20									
2.0 TSI	140	02/17→10/20									
2.0 TSI 4x4	140	02/19→10/20									
2.0 TSI RS	162 - 180	05/13→10/20									
								for PR number: 1KS / 1KT; Fitting Position: Rear Axle		24.0110-0356.1	410356
				24.0310-0356.1	510356	Outer diameter [mm]: 272 Brake Disc Thickness [mm] 9.7 Minimum thickness [mm] 8 Brake Disc Type: Solid Supplementary Article/Info 2: with bolts/screws					
1.2 TSI	63 - 77	11/12→02/17	Construction year from: 02/13 →; for PR number: 1ZJ; Fitting Position: Front Axle				24.0125-0145.1	425145	Outer diameter [mm]: 288 Brake Disc Thickness [mm] 25 Minimum thickness [mm] 22 Brake Disc Type: Vented Supplementary Article/Info 2: with bolts/screws		
1.6 TDI	66 - 77	11/12→10/20									
2.0 TDI	110	11/12→10/20									
				Construction year from: 02/13 →; for PR number: 1ZK / 1ZU; Fitting Position: Front Axle		24.0125-0158.1	425158	Outer diameter [mm]: 312 Brake Disc Thickness [mm] 25 Minimum thickness [mm] 22 Brake Disc Type: Vented Supplementary Article/Info 2: with bolts/screws			
									24.0325-0158.1	525158	Outer diameter [mm]: 312 Brake Disc Thickness [mm] 25 Minimum thickness [mm] 22 Brake Disc Type: Vented Supplementary Article/Info 2: with bolts/screws
				Construction year from: 02/13 →; for PR number: 1KS / 1KT; Fitting Position: Rear Axle		24.0110-0356.1	410356	Outer diameter [mm]: 272 Brake Disc Thickness [mm] 9.7 Minimum thickness [mm] 8 Brake Disc Type: Solid Supplementary Article/Info 2: with bolts/screws			
									24.0310-0356.1	510356	Outer diameter [mm]: 272 Brake Disc Thickness [mm] 9.7 Minimum thickness [mm] 8 Brake Disc Type: Solid Supplementary Article/Info 2: with bolts/screws
→											



		kW					
SKODA - OCTAVIA III (5E3, NL3, NR3) 11/12→03/21							
 Brake Disc							
1.4 TSI	110 08/14→10/20	Construction year from: 05/15 →; for PR number: 1ZJ; Fitting Position: Front Axle		24.0125-0145.1 425145	Outer diameter [mm]: 288 Brake Disc Thickness [mm] 25 Minimum thickness [mm] 22 Brake Disc Type: Vented Supplementary Article/Info 2: with bolts/screws		
		Construction year from: 05/15 →; for PR number: 1ZK / 1ZU; Fitting Position: Front Axle		24.0125-0158.1 425158	Outer diameter [mm]: 312 Brake Disc Thickness [mm] 25 Minimum thickness [mm] 22 Brake Disc Type: Vented Supplementary Article/Info 2: with bolts/screws		
		Construction year from: 05/15 →; for PR number: 1KS / 1KT; Fitting Position: Rear Axle		24.0325-0158.1 525158	Outer diameter [mm]: 312 Brake Disc Thickness [mm] 25 Minimum thickness [mm] 22 Brake Disc Type: Vented Supplementary Article/Info 2: with bolts/screws		
1.6 2.0 TDI	81 01/14→10/20 105 11/12→02/17	for PR number: 1ZJ; Fitting Position: Front Axle		24.0110-0356.1 410356	Outer diameter [mm]: 272 Brake Disc Thickness [mm] 9.7 Minimum thickness [mm] 8 Brake Disc Type: Solid Supplementary Article/Info 2: with bolts/screws		
		for PR number: 1ZK / 1ZU; Fitting Position: Front Axle		24.0310-0356.1 510356	Outer diameter [mm]: 272 Brake Disc Thickness [mm] 9.7 Minimum thickness [mm] 8 Brake Disc Type: Solid Supplementary Article/Info 2: with bolts/screws		
		for PR number: 1KS / 1KT; Fitting Position: Rear Axle		24.0125-0145.1 425145	Outer diameter [mm]: 288 Brake Disc Thickness [mm] 25 Minimum thickness [mm] 22 Brake Disc Type: Vented Supplementary Article/Info 2: with bolts/screws		
1.0 TSI 1.2 TSI 1.4 TSI 1.4 TSI G-TEC 1.6 1.6 TDI 1.8 TSI 2.0 TDI 2.0 TDI RS 2.0 TSI RS	85 05/16→10/20 81 05/15→02/17 103 11/12→02/17 81 11/13→02/17 81 01/14→10/20 81 05/13→02/17 132 11/12→10/20 105 11/12→02/17 135 05/13→10/20 162 - 05/13→10/20 169	Fitting Position: Front Axle Left		24.0125-0158.1 425158	Outer diameter [mm]: 312 Brake Disc Thickness [mm] 25 Minimum thickness [mm] 22 Brake Disc Type: Vented Supplementary Article/Info 2: with bolts/screws		
		Fitting Position: Front Axle Right		24.0110-0356.1 410356	Outer diameter [mm]: 272 Brake Disc Thickness [mm] 9.7 Minimum thickness [mm] 8 Brake Disc Type: Solid Supplementary Article/Info 2: with bolts/screws		
		Required quantity: 2; Vehicle Equipment: for vehicles with parking assistant system; Fitting Position: Rear Axle		24.0310-0356.1 510356	Outer diameter [mm]: 272 Brake Disc Thickness [mm] 9.7 Minimum thickness [mm] 8 Brake Disc Type: Solid Supplementary Article/Info 2: with bolts/screws		
1.2 TSI 1.6 TDI 2.0 TDI	63 - 11/12→02/17 77 66 11/12→10/20 110 11/12→10/20	Required quantity: 2; Comfort Equipment Variant (trim package): for cruise control system; Fitting Position: Rear Axle		2	24.0711-6337.3 360390		
		Construction year from: 02/17 →; Required quantity: 2; for PR number: 0N4; Fitting Position: Rear Axle		2	24.0711-6337.3 360390		
		Construction year from: 02/13 →; Fitting Position: Front Axle Left		24.0711-5273.3 360303			
1.6 TDI 2.0 TDI	66 11/12→10/20 110 11/12→10/20	Construction year from: 02/13 →; Fitting Position: Front Axle Right		24.0711-5274.3 360304			
		Construction year from: 02/13 →; Required quantity: 2; Comfort Equipment Variant (trim package): for cruise control system; Fitting Position: Rear Axle		2	24.0711-6337.3 360390		
 Wheel Speed Sensor							
→							

	kW				
SKODA - OCTAVIA III (5E3, NL3, NR3) 11/12→03/21					
 Wheel Speed Sensor					
1.2 TSI	63 - 11/12→02/17		package): for cruise control system; Fitting Position: Rear Axle		
1.6 TDI	77				
2.0 TDI	66 11/12→10/20		Construction year from: 02/13 →; Required quantity: 2; Vehicle Equipment: for vehicles with parking assistant system; Fitting Position: Rear Axle	2	24.0711-6337.3 360390
	110 11/12→10/20		Construction year from: 02/17 →; Required quantity: 2; for PR number: 0N4; Fitting Position: Rear Axle	2	24.0711-6337.3 360390
1.4 TSI	110 08/14→10/20		Construction year from: 05/15 →; Fitting Position: Front Axle Left		24.0711-5273.3 360303
			Construction year from: 05/15 →; Fitting Position: Front Axle Right		24.0711-5274.3 360304
			Construction year from: 05/15 →; Required quantity: 2; Comfort Equipment Variant (trim package): for cruise control system; Fitting Position: Rear Axle	2	24.0711-6337.3 360390
			Construction year from: 05/15 →; Required quantity: 2; Vehicle Equipment: for vehicles with parking assistant system; Fitting Position: Rear Axle	2	24.0711-6337.3 360390
			Construction year from: 02/17 →; Required quantity: 2; for PR number: 0N4; Fitting Position: Rear Axle	2	24.0711-6337.3 360390
1.5 TSI	110 02/17→10/20		Fitting Position: Front Axle Left		24.0711-5273.3 360303
1.6 TDI 4x4	85 02/17→10/20		Fitting Position: Front Axle Right		24.0711-5274.3 360304
			Required quantity: 2; Vehicle Equipment: for vehicles with parking assistant system; Fitting Position: Rear Axle	2	24.0711-6337.3 360390
			Required quantity: 2; Comfort Equipment Variant (trim package): for cruise control system; Fitting Position: Rear Axle	2	24.0711-6337.3 360390
			Required quantity: 2; for PR number: 0N4; Fitting Position: Rear Axle	2	24.0711-6337.3 360390
1.6 TDI	77 11/12→05/15		Construction year from: 02/13 →; Fitting Position: Front Axle Left		24.0711-5273.3 360303
			Construction year from: 02/13 →; Fitting Position: Front Axle Right		24.0711-5274.3 360304
			Construction year from: 02/13 →; Required quantity: 2; Comfort Equipment Variant (trim package): for cruise control system; Fitting Position: Rear Axle	2	24.0711-6337.3 360390
			Construction year from: 02/13 →; Required quantity: 2; Vehicle Equipment: for vehicles with parking assistant system; Fitting Position: Rear Axle	2	24.0711-6337.3 360390
			Required quantity: 2; for PR number: 0N4; Fitting Position: Rear Axle	2	24.0711-6337.3 360390
1.6 TDI	85 02/17→10/20		Fitting Position: Front Axle Left		24.0711-5273.3 360303
2.0 TSI	140 02/17→10/20		Fitting Position: Front Axle Right		24.0711-5274.3 360304
2.0 TSI RS	180 02/17→10/20		Required quantity: 2; for PR number: 0N4; Fitting Position: Rear Axle	2	24.0711-6337.3 360390
1.6 TDI 4x4	77 05/13→05/15		Fitting Position: Front Axle Left		24.0711-5273.3 360303
			Fitting Position: Front Axle Right		24.0711-5274.3 360304
			Fitting Position: Rear Axle Left		24.0711-5401.3 360330
			Fitting Position: Rear Axle Right		24.0711-5402.3 360331
			Required quantity: 2; Comfort Equipment Variant (trim package): for cruise control system; Fitting Position: Rear Axle	2	24.0711-6337.3 360390
			Required quantity: 2; Vehicle Equipment: for vehicles with parking assistant system; Fitting Position: Rear Axle	2	24.0711-6337.3 360390
→					

	kW				
SKODA - OCTAVIA III (5E3, NL3, NR3) 11/12→03/21					
 Wheel Speed Sensor					
1.6 TDI 4x4	81	05/15→02/17	Fitting Position: Front Axle Left	24.0711-5273.3	360303
1.8 TSI 4x4	132	05/14→10/20	Fitting Position: Front Axle Right	24.0711-5274.3	360304
2.0 TDI / TDI RS 4x4	135	05/13→10/20	Construction year from: 02/17 →; Fitting Position: Rear Axle Left	24.0711-5401.3	360330
2.0 TDI 4x4	110	05/13→10/20	Construction year from: 02/17 →; Fitting Position: Rear Axle Right	24.0711-5402.3	360331
			Required quantity: 2; Comfort Equipment Variant (trim package): for cruise control system; Fitting Position: Rear Axle	2	24.0711-6337.3 360390
			Required quantity: 2; Vehicle Equipment: for vehicles with parking assistant system; Fitting Position: Rear Axle	2	24.0711-6337.3 360390
2.0 TSI 4x4	140	02/19→10/20	Fitting Position: Front Axle Left	24.0711-5273.3	360303
			Fitting Position: Front Axle Right	24.0711-5274.3	360304
			Fitting Position: Rear Axle Left	24.0711-5401.3	360330
			Fitting Position: Rear Axle Right	24.0711-5402.3	360331
SKODA - OCTAVIA III Combi (5E5, 5E6) 11/12→10/20					
 Brake Caliper					
1.0 TSI	85	05/16→10/20	for PR number: 1ZK; Fitting Position: Front Axle Left	24.3571-1801.5	241387 Supplementary Article/Supplementary Info: without holder Brake Caliper Type: Fist-type Caliper
1.2 TSI	81	05/15→02/17			
1.4 TSI	103	11/12→02/17			
1.4 TSI G-TEC	81	11/12→02/17			
1.5 TSI	110	02/17→10/20			
1.5 TSI G-TEC	96	01/19→10/20	for PR number: 1ZK; Fitting Position: Front Axle Right	24.3571-1802.5	241388 Supplementary Article/Supplementary Info: without holder Brake Caliper Type: Fist-type Caliper
1.6	81	01/14→02/17			
1.6 TDI	81 -	05/13→10/20			
	85				
1.6 TDI 4x4	77 -	11/12→10/20			
	85				
1.8 TSI	132	11/12→10/20			
1.8 TSI 4x4	132	11/12→02/17			
2.0 TDI	105	11/12→02/17			
2.0 TDI / TDI RS 4x4	135	05/13→10/20			
2.0 TDI 4x4	110	11/12→10/20			
2.0 TDI RS	135	05/13→10/20			
2.0 TSI	140	02/17→10/20			
2.0 TSI 4x4	140	02/19→10/20			
2.0 TSI RS	169 -	05/15→10/20			
	180				
1.2 TSI	63 -	11/12→02/17	Construction year from: 02/13 →; for PR number: 1ZK; Fitting Position: Front Axle Left	24.3571-1801.5	241387 Supplementary Article/Supplementary Info: without holder Brake Caliper Type: Fist-type Caliper
	77				
1.6 TDI	66 -	11/12→10/20			
	77				
2.0 TDI	110	11/12→10/20	Construction year from: 02/13 →; for PR number: 1ZK; Fitting Position: Front Axle Right	24.3571-1802.5	241388 Supplementary Article/Supplementary Info: without holder Brake Caliper Type: Fist-type Caliper
1.4 TSI	110	08/14→10/20	Construction year from: 05/15 →; for PR number: 1ZK; Fitting Position: Front Axle Left	24.3571-1801.5	241387 Supplementary Article/Supplementary Info: without holder Brake Caliper Type: Fist-type Caliper
			Construction year from: 05/15 →; for PR number: 1ZK; Fitting Position: Front Axle Right	24.3571-1802.5	241388 Supplementary Article/Supplementary Info: without holder Brake Caliper Type: Fist-type Caliper
2.0 TSI RS	162	11/12→02/17	Construction year from: 05/13 →; for PR number: 1ZK; Fitting Position: Front Axle Left	24.3571-1801.5	241387 Supplementary Article/Supplementary Info: without holder Brake Caliper Type: Fist-type Caliper
			Construction year from: 05/13 →; for PR number: 1ZK; Fitting Position: Front Axle Right	24.3571-1802.5	241388 Supplementary Article/Supplementary Info: without holder Brake Caliper Type: Fist-type Caliper
 Brake Disc					
1.0 TSI	85	05/16→10/20	for PR number: 1ZJ; Fitting Position: Front Axle	24.0125-0145.1	425145 Outer diameter [mm]: 288 Brake Disc Thickness [mm] 25 Minimum thickness [mm] 22 Brake Disc Type: Vented Supplementary Article/Info 2: with bolts/screws
1.2 TSI	81	05/15→02/17			
1.4 TSI	103	11/12→02/17			
1.4 TSI G-TEC	81	11/12→02/17			
1.5 TSI	110	02/17→10/20			
1.5 TSI G-TEC	96	01/19→10/20			
1.6 TDI	81 -	05/13→10/20			
	85				
→					



	kW			
SKODA - OCTAVIA III Combi (5E5, 5E6) 11/12→10/20				
 Brake Disc				
1.6 TDI 4x4	77 - 11/12→10/20	for PR number: 1ZK / 1ZU; Fitting Position: Front Axle	24.0125-0158.1 425158	Outer diameter [mm]: 312 Brake Disc Thickness [mm] 25 Minimum thickness [mm] 22 Brake Disc Type: Vented Supplementary Article/Info 2: with bolts/screws
1.8 TSI	85			
1.8 TSI 4x4	132 11/12→10/20			
2.0 TDI / TDI RS 4x4	132 11/12→02/17			
2.0 TDI 4x4	135 05/13→10/20			
2.0 TDI RS	110 11/12→10/20			
2.0 TSI	135 05/13→10/20			
2.0 TSI 4x4	140 02/17→10/20			
2.0 TSI RS	140 02/19→10/20	24.0325-0158.1 525158	Outer diameter [mm]: 312 Brake Disc Thickness [mm] 25 Minimum thickness [mm] 22 Brake Disc Type: Vented Supplementary Article/Info 2: with bolts/screws	
	169 - 05/15→10/20			
	180	for PR number: 1KS / 1KT; Fitting Position: Rear Axle	24.0110-0356.1 410356	Outer diameter [mm]: 272 Brake Disc Thickness [mm] 9.7 Minimum thickness [mm] 8 Brake Disc Type: Solid Supplementary Article/Info 2: with bolts/screws
		24.0310-0356.1 510356	Outer diameter [mm]: 272 Brake Disc Thickness [mm] 9.7 Minimum thickness [mm] 8 Brake Disc Type: Solid Supplementary Article/Info 2: with bolts/screws	
1.2 TSI	63 - 11/12→02/17	Construction year from: 02/13 →; for PR number: 1ZJ; Fitting Position: Front Axle	24.0125-0145.1 425145	Outer diameter [mm]: 288 Brake Disc Thickness [mm] 25 Minimum thickness [mm] 22 Brake Disc Type: Vented Supplementary Article/Info 2: with bolts/screws
1.6 TDI	77			
2.0 TDI	66 - 11/12→10/20			
	77	Construction year from: 02/13 →; for PR number: 1ZK / 1ZU; Fitting Position: Front Axle	24.0125-0158.1 425158	Outer diameter [mm]: 312 Brake Disc Thickness [mm] 25 Minimum thickness [mm] 22 Brake Disc Type: Vented Supplementary Article/Info 2: with bolts/screws
	110 11/12→10/20			
		Construction year from: 02/13 →; for PR number: 1KS / 1KT; Fitting Position: Rear Axle	24.0110-0356.1 410356	Outer diameter [mm]: 272 Brake Disc Thickness [mm] 9.7 Minimum thickness [mm] 8 Brake Disc Type: Solid Supplementary Article/Info 2: with bolts/screws
		24.0310-0356.1 510356	Outer diameter [mm]: 272 Brake Disc Thickness [mm] 9.7 Minimum thickness [mm] 8 Brake Disc Type: Solid Supplementary Article/Info 2: with bolts/screws	
1.4 TSI	110 08/14→10/20	Construction year from: 05/15 →; for PR number: 1ZJ; Fitting Position: Front Axle	24.0125-0145.1 425145	Outer diameter [mm]: 288 Brake Disc Thickness [mm] 25 Minimum thickness [mm] 22 Brake Disc Type: Vented Supplementary Article/Info 2: with bolts/screws
		Construction year from: 05/15 →; for PR number: 1ZK / 1ZU; Fitting Position: Front Axle	24.0125-0158.1 425158	Outer diameter [mm]: 312 Brake Disc Thickness [mm] 25 Minimum thickness [mm] 22 Brake Disc Type: Vented Supplementary Article/Info 2: with bolts/screws
		24.0325-0158.1 525158	Outer diameter [mm]: 312 Brake Disc Thickness [mm] 25 Minimum thickness [mm] 22 Brake Disc Type: Vented Supplementary Article/Info 2: with bolts/screws	
		Construction year from: 05/15 →; for PR number: 1KS / 1KT; Fitting Position: Rear Axle	24.0110-0356.1 410356	Outer diameter [mm]: 272 Brake Disc Thickness [mm] 9.7 Minimum thickness [mm] 8 Brake Disc Type: Solid Supplementary Article/Info 2: with bolts/screws





→



		kW					
SKODA - OCTAVIA III Combi (5E5, 5E6) 11/12→10/20							
 Brake Disc							
1.4 TSI	110 08/14→10/20	Construction year from: 05/15 →; for PR number: 1KS / 1KT; Fitting Position: Rear Axle		24.0310-0356.1 510356	Outer diameter [mm]: 272 Brake Disc Thickness [mm] 9.7 Minimum thickness [mm] 8 Brake Disc Type: Solid Supplementary Article/Info 2: with bolts/screws		
1.6 2.0 TDI	81 01/14→02/17 105 11/12→02/17	for PR number: 1ZJ; Fitting Position: Front Axle		24.0125-0145.1 425145	Outer diameter [mm]: 288 Brake Disc Thickness [mm] 25 Minimum thickness [mm] 22 Brake Disc Type: Vented Supplementary Article/Info 2: with bolts/screws		
		for PR number: 1ZK / 1ZU; Fitting Position: Front Axle		24.0125-0158.1 425158	Outer diameter [mm]: 312 Brake Disc Thickness [mm] 25 Minimum thickness [mm] 22 Brake Disc Type: Vented Supplementary Article/Info 2: with bolts/screws		
		for PR number: 1KS / 1KT; Fitting Position: Rear Axle		24.0110-0356.1 410356	Outer diameter [mm]: 272 Brake Disc Thickness [mm] 9.7 Minimum thickness [mm] 8 Brake Disc Type: Solid Supplementary Article/Info 2: with bolts/screws	24.0310-0356.1 510356	Outer diameter [mm]: 272 Brake Disc Thickness [mm] 9.7 Minimum thickness [mm] 8 Brake Disc Type: Solid Supplementary Article/Info 2: with bolts/screws
2.0 TSI RS	162 11/12→02/17	Construction year from: 05/13 →; for PR number: 1ZJ; Fitting Position: Front Axle		24.0125-0145.1 425145	Outer diameter [mm]: 288 Brake Disc Thickness [mm] 25 Minimum thickness [mm] 22 Brake Disc Type: Vented Supplementary Article/Info 2: with bolts/screws		
		Construction year from: 05/13 →; for PR number: 1ZK / 1ZU; Fitting Position: Front Axle		24.0125-0158.1 425158	Outer diameter [mm]: 312 Brake Disc Thickness [mm] 25 Minimum thickness [mm] 22 Brake Disc Type: Vented Supplementary Article/Info 2: with bolts/screws	24.0325-0158.1 525158	Outer diameter [mm]: 312 Brake Disc Thickness [mm] 25 Minimum thickness [mm] 22 Brake Disc Type: Vented Supplementary Article/Info 2: with bolts/screws
		Construction year from: 05/13 →; for PR number: 1KS / 1KT; Fitting Position: Rear Axle		24.0110-0356.1 410356	Outer diameter [mm]: 272 Brake Disc Thickness [mm] 9.7 Minimum thickness [mm] 8 Brake Disc Type: Solid Supplementary Article/Info 2: with bolts/screws	24.0310-0356.1 510356	Outer diameter [mm]: 272 Brake Disc Thickness [mm] 9.7 Minimum thickness [mm] 8 Brake Disc Type: Solid Supplementary Article/Info 2: with bolts/screws
 Wheel Speed Sensor							
1.0 TSI	85 05/16→10/20	Fitting Position: Front Axle Left		24.0711-5273.3 360303			
1.2 TSI	81 05/15→02/17	Fitting Position: Front Axle Right		24.0711-5274.3 360304			
1.4 TSI	103 11/12→02/17						
1.4 TSI G-TEC	81 11/12→02/17	Required quantity: 2;		2 24.0711-6337.3 360390			
1.6	81 01/14→02/17	Vehicle Equipment: for vehicles with					
1.6 TDI	81 05/13→02/17	parking assistant system;					
1.8 TSI	132 11/12→10/20	Fitting Position: Rear Axle					
2.0 TDI	105 11/12→02/17	Required quantity: 2;		2 24.0711-6337.3 360390			
2.0 TDI RS	135 05/13→10/20	Comfort Equipment Variant (trim					
2.0 TSI RS	169 05/15→10/20	package): for cruise control system;					
		Fitting Position: Rear Axle					
		Construction year from: 02/17 →;		2 24.0711-6337.3 360390			
		Required quantity: 2;					
		for PR number: 0N4;					
		Fitting Position: Rear Axle					
1.2 TSI	63 - 11/12→02/17 77	Construction year from: 02/13 →; Fitting Position: Front Axle Left		24.0711-5273.3 360303			



	kW			
SKODA - OCTAVIA III Combi (5E5, 5E6) 11/12→10/20				
 Wheel Speed Sensor				
1.6 TDI 2.0 TDI	66 11/12→10/20 110 11/12→10/20	Construction year from: 02/13 →; Fitting Position: Front Axle Right		24.0711-5274.3 360304
		Construction year from: 02/13 →; Required quantity: 2; Comfort Equipment Variant (trim package): for cruise control system; Fitting Position: Rear Axle	2	24.0711-6337.3 360390
		Construction year from: 02/13 →; Required quantity: 2; Vehicle Equipment: for vehicles with parking assistant system; Fitting Position: Rear Axle	2	24.0711-6337.3 360390
		Construction year from: 02/17 →; Required quantity: 2; for PR number: 0N4; Fitting Position: Rear Axle	2	24.0711-6337.3 360390
1.4 TSI	110 08/14→10/20	Construction year from: 05/15 →; Fitting Position: Front Axle Left		24.0711-5273.3 360303
		Construction year from: 05/15 →; Fitting Position: Front Axle Right		24.0711-5274.3 360304
		Construction year from: 05/15 →; Required quantity: 2; Comfort Equipment Variant (trim package): for cruise control system; Fitting Position: Rear Axle	2	24.0711-6337.3 360390
		Construction year from: 05/15 →; Required quantity: 2; Vehicle Equipment: for vehicles with parking assistant system; Fitting Position: Rear Axle	2	24.0711-6337.3 360390
		Construction year from: 02/17 →; Required quantity: 2; for PR number: 0N4; Fitting Position: Rear Axle	2	24.0711-6337.3 360390
1.5 TSI	110 02/17→10/20	Fitting Position: Front Axle Left		24.0711-5273.3 360303
		Fitting Position: Front Axle Right		24.0711-5274.3 360304
		Required quantity: 2; Vehicle Equipment: for vehicles with parking assistant system; Fitting Position: Rear Axle	2	24.0711-6337.3 360390
		Required quantity: 2; Comfort Equipment Variant (trim package): for cruise control system; Fitting Position: Rear Axle	2	24.0711-6337.3 360390
		Required quantity: 2; for PR number: 0N4; Fitting Position: Rear Axle	2	24.0711-6337.3 360390
1.5 TSI G-TEC 1.6 TDI 1.6 TDI 4x4 2.0 TSI 2.0 TSI RS	96 01/19→10/20 85 02/17→10/20 85 02/17→10/20 140 02/17→10/20 180 02/17→10/20	Fitting Position: Front Axle Left		24.0711-5273.3 360303
		Fitting Position: Front Axle Right		24.0711-5274.3 360304
		Required quantity: 2; for PR number: 0N4; Fitting Position: Rear Axle	2	24.0711-6337.3 360390
1.6 TDI	77 11/12→05/15	Construction year from: 02/13 →; Fitting Position: Front Axle Left		24.0711-5273.3 360303
		Construction year from: 02/13 →; Fitting Position: Front Axle Right		24.0711-5274.3 360304
		Construction year from: 02/13 →; Required quantity: 2; Comfort Equipment Variant (trim package): for cruise control system; Fitting Position: Rear Axle	2	24.0711-6337.3 360390
		Construction year from: 02/13 →; Required quantity: 2; Vehicle Equipment: for vehicles with parking assistant system; Fitting Position: Rear Axle	2	24.0711-6337.3 360390
		Required quantity: 2; for PR number: 0N4; Fitting Position: Rear Axle	2	24.0711-6337.3 360390
1.6 TDI 4x4	77 11/12→05/15	Fitting Position: Front Axle Left		24.0711-5273.3 360303
		Fitting Position: Front Axle Right		24.0711-5274.3 360304
		Fitting Position: Rear Axle Left		24.0711-5401.3 360330
		Fitting Position: Rear Axle Right		24.0711-5402.3 360331
		Required quantity: 2; Comfort Equipment Variant (trim	2	24.0711-6337.3 360390



→

	kW				
SKODA - OCTAVIA III Combi (5E5, 5E6) 11/12→10/20					
 Wheel Speed Sensor					
1.6 TDI 4x4	77	11/12→05/15	package): for cruise control system; Fitting Position: Rear Axle		
			Required quantity: 2; Vehicle Equipment: for vehicles with parking assistant system; Fitting Position: Rear Axle	2	24.0711-6337.3 360390
1.6 TDI 4x4	81	05/15→02/17	Fitting Position: Front Axle Left		24.0711-5273.3 360303
1.8 TSI 4x4	132	11/12→02/17	Fitting Position: Front Axle Right		24.0711-5274.3 360304
2.0 TDI / TDI RS 4x4	135	05/13→10/20	Construction year from: 02/17 →; Fitting Position: Rear Axle Left		24.0711-5401.3 360330
2.0 TDI 4x4	110	11/12→10/20	Construction year from: 02/17 →; Fitting Position: Rear Axle Right		24.0711-5402.3 360331
			Required quantity: 2; Comfort Equipment Variant (trim package): for cruise control system; Fitting Position: Rear Axle	2	24.0711-6337.3 360390
			Required quantity: 2; Vehicle Equipment: for vehicles with parking assistant system; Fitting Position: Rear Axle	2	24.0711-6337.3 360390
2.0 TSI 4x4	140	02/19→10/20	Fitting Position: Front Axle Left		24.0711-5273.3 360303
			Fitting Position: Front Axle Right		24.0711-5274.3 360304
			Fitting Position: Rear Axle Left		24.0711-5401.3 360330
			Fitting Position: Rear Axle Right		24.0711-5402.3 360331
2.0 TSI RS	162	11/12→02/17	Construction year from: 05/13 →; Fitting Position: Front Axle Left		24.0711-5273.3 360303
			Construction year from: 05/13 →; Fitting Position: Front Axle Right		24.0711-5274.3 360304
			Construction year from: 05/13 →; Required quantity: 2; Comfort Equipment Variant (trim package): for cruise control system; Fitting Position: Rear Axle	2	24.0711-6337.3 360390
			Construction year from: 05/13 →; Required quantity: 2; Vehicle Equipment: for vehicles with parking assistant system; Fitting Position: Rear Axle	2	24.0711-6337.3 360390
			Construction year from: 02/17 →; Required quantity: 2; for PR number: 0N4; Fitting Position: Rear Axle	2	24.0711-6337.3 360390
SKODA - OCTAVIA IV (NX3, NN3) 01/20→					
 Brake Caliper					
1.0 TSI	81	06/20→	for PR number: 1ZK; Fitting Position: Front Axle Left		24.3571-1801.5 241387
1.0 TSI e-TEC	81	06/20→			Supplementary Article/Supplementary Info: without holder
1.4 TSI	110	01/21→			Brake Caliper Type: Fist-type Caliper
1.4 TSI IV	110 - 150	06/20→			
1.4 TSI RS IV	110 - 180	06/20→	for PR number: 1ZK; Fitting Position: Front Axle Right		24.3571-1802.5 241388
1.5 TSI	110	01/20→			Supplementary Article/Supplementary Info: without holder
1.5 TSI e-TEC	110	11/20→			Brake Caliper Type: Fist-type Caliper
1.5 TSI G-TEC	96	06/20→			
1.6 SRE	81	07/20→			
2.0 TDI	85 - 110	01/20→			
2.0 TDI 4x4	110	09/20→			
2.0 TDI RS	147	07/20→			
2.0 TDI RS 4x4	147	07/20→			
2.0 TSI 4x4	140	07/20→			
2.0 TSI RS	180	03/20→			
 Brake Disc					
1.0 TSI	81	06/20→	for PR number: 1ZE; Fitting Position: Front Axle		24.0125-0145.1 425145
1.0 TSI e-TEC	81	06/20→			Outer diameter [mm]: 288
1.4 TSI	110	01/21→			Brake Disc Thickness [mm] 25
1.4 TSI IV	110 - 150	06/20→			Minimum thickness [mm] 22
1.4 TSI RS IV	110 - 180	06/20→			Brake Disc Type: Vented
					Supplementary Article/Info 2: with bolts/screws
1.5 TSI	110	01/20→	for PR number: 1ZU; Fitting Position: Front Axle		24.0125-0158.1 425158
1.5 TSI e-TEC	110	11/20→			Outer diameter [mm]: 312
1.5 TSI G-TEC	96	06/20→			Brake Disc Thickness [mm] 25
1.6 SRE	81	07/20→			Minimum thickness [mm] 22
					Brake Disc Type: Vented
					Supplementary Article/Info 2: with bolts/screws

	kW				
SKODA - OCTAVIA IV (NX3, NN3) 01/20→					
 Brake Disc					
2.0 TDI	85 - 01/20→ 110		for PR number: 1KE / 2EC / 0N4; Fitting Position: Rear Axle	24.0110-0356.1 410356	Outer diameter [mm]: 272 Brake Disc Thickness [mm] 9.7 Minimum thickness [mm] 8 Brake Disc Type: Solid Supplementary Article/Info 2: with bolts/screws
2.0 TDI 4x4	110 09/20→				
2.0 TDI RS	147 07/20→				
2.0 TDI RS 4x4	147 07/20→				
2.0 TSI 4x4	140 07/20→				
2.0 TSI RS	180 03/20→				
 Wheel Speed Sensor					
1.0 TSI	81 06/20→		Fitting Position: Front Axle Left	24.0711-5273.3 360303	
1.0 TSI e-TEC	81 06/20→				
1.4 TSI	110 01/21→		Fitting Position: Front Axle Right	24.0711-5274.3 360304	
1.4 TSI iV	110 - 06/20→ 150				
1.4 TSI RS iV	110 - 06/20→ 180				
1.5 TSI	110 01/20→				
1.5 TSI e-TEC	110 11/20→				
1.5 TSI G-TEC	96 06/20→				
1.6 SRE	81 07/20→				
2.0 TDI	85 - 01/20→ 110				
2.0 TDI RS	147 07/20→				
2.0 TSI RS	180 03/20→				
2.0 TDI 4x4	110 09/20→		Fitting Position: Front Axle Left	24.0711-5273.3 360303	
2.0 TDI RS 4x4	147 07/20→		Fitting Position: Front Axle Right	24.0711-5274.3 360304	
2.0 TSI 4x4	140 07/20→		for PR number: 0N4; Fitting Position: Rear Axle Left	24.0711-5401.3 360330	
			for PR number: 0N4; Fitting Position: Rear Axle Right	24.0711-5402.3 360331	
SKODA - OCTAVIA IV Combi (NX5) 11/19→					
 Brake Caliper					
1.0 TSI	81 06/20→		for PR number: 1ZK; Fitting Position: Front Axle Left	24.3571-1801.5 241387	Supplementary Article/Supplementary Info: without holder Brake Caliper Type: Fist-type Caliper
1.0 TSI e-TEC	81 06/20→				
1.4 TSI	110 06/20→				
1.4 TSI iV	110 - 06/20→ 150				
1.4 TSI RS iV	110 - 06/20→ 180		for PR number: 1ZK; Fitting Position: Front Axle Right	24.3571-1802.5 241388	Supplementary Article/Supplementary Info: without holder Brake Caliper Type: Fist-type Caliper
1.5 TSI	110 11/19→				
1.5 TSI e-TEC	110 11/20→				
1.5 TSI G-TEC	96 06/20→				
1.6 SRE	81 06/20→				
2.0 TDI	85 - 11/19→ 110				
2.0 TDI 4x4	110 09/20→				
2.0 TDI RS	147 07/20→				
2.0 TDI RS 4x4	147 07/20→				
2.0 TSI 4x4	140 09/20→				
2.0 TSI RS	180 03/20→				
 Brake Disc					
1.0 TSI	81 06/20→		for PR number: 1ZE; Fitting Position: Front Axle	24.0125-0145.1 425145	Outer diameter [mm]: 288 Brake Disc Thickness [mm] 25 Minimum thickness [mm] 22 Brake Disc Type: Vented Supplementary Article/Info 2: with bolts/screws
1.0 TSI e-TEC	81 06/20→				
1.4 TSI	110 06/20→				
1.4 TSI iV	110 - 06/20→ 150				
1.4 TSI RS iV	110 - 06/20→ 180				
1.5 TSI	110 11/19→		for PR number: 1ZU; Fitting Position: Front Axle	24.0125-0158.1 425158	Outer diameter [mm]: 312 Brake Disc Thickness [mm] 25 Minimum thickness [mm] 22 Brake Disc Type: Vented Supplementary Article/Info 2: with bolts/screws
1.5 TSI e-TEC	110 11/20→				
1.5 TSI G-TEC	96 06/20→				
1.6 SRE	81 06/20→				
2.0 TDI	85 - 11/19→ 110				
2.0 TDI 4x4	110 09/20→		for PR number: 1KE / 2EC / 0N4; Fitting Position: Rear Axle	24.0110-0356.1 410356	Outer diameter [mm]: 272 Brake Disc Thickness [mm] 9.7 Minimum thickness [mm] 8 Brake Disc Type: Solid Supplementary Article/Info 2: with bolts/screws
2.0 TDI RS	147 07/20→				
2.0 TDI RS 4x4	147 07/20→				
2.0 TSI 4x4	140 09/20→				
2.0 TSI RS	180 03/20→				
 Wheel Speed Sensor					
1.0 TSI	81 06/20→		Fitting Position: Front Axle Left	24.0711-5273.3 360303	
1.0 TSI e-TEC	81 06/20→				
1.4 TSI	110 06/20→		Fitting Position: Front Axle Right	24.0711-5274.3 360304	
1.4 TSI iV	110 - 06/20→ 150				
→					

	kW				
SKODA - OCTAVIA IV Combi (NX5) 11/19→					
 Wheel Speed Sensor					
1.4 TSI RS iV	110 - 06/20→ 180		Fitting Position: Front Axle Left		24.0711-5273.3 360303
1.5 TSI	110 11/19→		Fitting Position: Front Axle Right		24.0711-5274.3 360304
1.5 TSI e-TEC	110 11/20→				
1.5 TSI G-TEC	96 06/20→				
1.6 SRE	81 06/20→				
2.0 TDI	85 - 11/19→ 110				
2.0 TDI RS	147 07/20→				
2.0 TSI RS	180 03/20→				
2.0 TDI 4x4	110 09/20→		Fitting Position: Front Axle Left		24.0711-5273.3 360303
2.0 TDI RS 4x4	147 07/20→		Fitting Position: Front Axle Right		24.0711-5274.3 360304
2.0 TSI 4x4	140 09/20→		for PR number: 0N4; Fitting Position: Rear Axle Left		24.0711-5401.3 360330
			for PR number: 0N4; Fitting Position: Rear Axle Right		24.0711-5402.3 360331
SKODA - RAPID (NA2) 09/11→					
Guide Sleeve Kit, brake caliper					
1.6 TDI	77 10/11→12/13		for PR number: 1ZG; Fitting Position: Front Axle		11.0101-5407.2 260011 Brake System: ATE
Guide Bolt, brake caliper					
1.6 TDI	77 10/11→12/13		for PR number: 1ZG; Required quantity: 2	2	11.8171-0008.1 990049 Brake System: ATE
			for PR number: 1ZC; Required quantity: 2	2	11.8171-0008.1 990049 Brake System: ATE
 Wheel Speed Sensor					
1.6 TDI	77 10/11→12/13		Fitting Position: Front Axle Left		24.0711-5273.3 360303
			Fitting Position: Front Axle Right		24.0711-5274.3 360304
SKODA - RAPID (NH3, NK3, NK6) 07/12→					
Guide Sleeve Kit, brake caliper					
1.2	55 07/12→06/15		Construction year from: 10/12 →; for PR number: 1ZG; Fitting Position: Front Axle		11.0101-5407.2 260011 Brake System: ATE
1.2 LPG	55 - 07/12→06/15 63				
1.2 TSI	63 - 07/12→05/15 77				
1.4 TSI	90 07/12→06/15				
1.6 TDI	77 07/12→12/19				
1.6	77 07/12→06/15		Construction year from: 07/13 →; for PR number: 1ZG; Fitting Position: Front Axle		11.0101-5407.2 260011 Brake System: ATE
1.6	81 05/15→12/19		for PR number: 1ZG;		11.0101-5407.2 260011 Brake System: ATE
1.6 SRE	66 06/15→12/19		Fitting Position: Front Axle		
1.6 TDI	66 08/13→05/15				
Guide Bolt, brake caliper					
1.0 TSI	70 - 06/17→12/19 81		for PR number: 1ZC; Required quantity: 2	2	11.8171-0008.1 990049 Brake System: ATE
1.2 TSI	66 - 05/15→12/19 81				
1.4 TDI	66 05/15→12/19				
1.4 TSI	92 05/15→12/19				
1.6 TDI	85 05/15→12/19				
1.2	55 07/12→06/15		Construction year from: 10/12 →; for PR number: 1ZG; Required quantity: 2	2	11.8171-0008.1 990049 Brake System: ATE
1.2 LPG	55 - 07/12→06/15 63				
1.2 TSI	63 - 07/12→05/15 77		Construction year from: 10/12 →; for PR number: 1ZC; Required quantity: 2	2	11.8171-0008.1 990049 Brake System: ATE
1.4 TSI	90 07/12→06/15				
1.6 TDI	77 07/12→12/19				
1.6	77 07/12→06/15		Construction year from: 07/13 →; for PR number: 1ZG; Required quantity: 2	2	11.8171-0008.1 990049 Brake System: ATE
			Construction year from: 07/13 →; for PR number: 1ZC; Required quantity: 2	2	11.8171-0008.1 990049 Brake System: ATE
1.6	81 05/15→12/19		for PR number: 1ZC; Required quantity: 2	2	11.8171-0008.1 990049 Brake System: ATE
1.6 SRE	66 06/15→12/19				
1.6 TDI	66 08/13→05/15		for PR number: 1ZG; Required quantity: 2	2	11.8171-0008.1 990049 Brake System: ATE
→					



	kW				
SKODA - RAPID (NH3, NK3, NK6) 07/12→					
 Wheel Speed Sensor					
1.0 TSI	70 - 06/17→12/19 81	Fitting Position: Front Axle Left		24.0711-5273.3	360303
1.2 TSI	66 - 05/15→12/19 81	Fitting Position: Front Axle Right		24.0711-5274.3	360304
1.4 TDI	66 05/15→12/19				
1.4 TSI	92 05/15→12/19				
1.6	81 05/15→12/19				
1.6 SRE	66 06/15→12/19				
1.6 TDI	66 - 08/13→12/19 85				
1.2	55 07/12→06/15	Construction year from: 10/12 →;		24.0711-5273.3	360303
1.2 LPG	55 - 07/12→06/15 63	Fitting Position: Front Axle Left			
1.2 TSI	63 - 07/12→05/15 77	Construction year from: 10/12 →;		24.0711-5274.3	360304
1.4 TSI	90 07/12→06/15	Fitting Position: Front Axle Right			
1.6 TDI	77 07/12→12/19				
1.6	77 07/12→06/15	Construction year from: 07/13 →;		24.0711-5273.3	360303
		Fitting Position: Front Axle Left			
		Construction year from: 07/13 →;		24.0711-5274.3	360304
		Fitting Position: Front Axle Right			
SKODA - RAPID Spaceback (NH1) 07/12→12/19					
Guide Sleeve Kit, brake caliper					
1.2	55 07/12→06/15	Construction year from: 10/12 →;		11.0101-5407.2	260011 Brake System: ATE
1.2 LPG	55 - 07/12→06/15 63	for PR number: 1ZG;			
1.2 TSI	63 - 07/12→05/15 77	Fitting Position: Front Axle			
1.4 TSI	90 07/12→06/15				
1.6 TDI	77 07/12→12/19				
1.6	77 07/12→06/15	Construction year from: 07/13 →;		11.0101-5407.2	260011 Brake System: ATE
		for PR number: 1ZG;			
		Fitting Position: Front Axle			
1.6 SRE	81 05/15→12/19	for PR number: 1ZG;		11.0101-5407.2	260011 Brake System: ATE
1.6 TDI	66 08/13→05/15	Fitting Position: Front Axle			
Guide Bolt, brake caliper					
1.0 TSI	70 - 06/17→12/19 81	for PR number: 1ZC;		2	11.8171-0008.1 990049 Brake System: ATE
1.2 TSI	66 - 05/15→12/19 81	Required quantity: 2			
1.4 TDI	66 05/15→12/19				
1.4 TSI	92 05/15→12/19				
1.6 TDI	85 05/15→12/19				
1.2	55 07/12→06/15	Construction year from: 10/12 →;		2	11.8171-0008.1 990049 Brake System: ATE
1.2 LPG	55 - 07/12→06/15 63	for PR number: 1ZG;			
1.2 TSI	63 - 07/12→05/15 77	Required quantity: 2			
1.4 TSI	90 07/12→06/15	Construction year from: 10/12 →;		2	11.8171-0008.1 990049 Brake System: ATE
1.6 TDI	77 07/12→12/19	for PR number: 1ZC;			
		Required quantity: 2			
1.6	77 07/12→06/15	Construction year from: 07/13 →;		2	11.8171-0008.1 990049 Brake System: ATE
		for PR number: 1ZG;			
		Required quantity: 2			
1.6 SRE	81 05/15→12/19	for PR number: 1ZC;		2	11.8171-0008.1 990049 Brake System: ATE
1.6 TDI	66 08/13→05/15	Required quantity: 2			
		for PR number: 1ZG;		2	11.8171-0008.1 990049 Brake System: ATE
		Required quantity: 2			
 Wheel Speed Sensor					
1.0 TSI	70 - 06/17→12/19 81	Fitting Position: Front Axle Left		24.0711-5273.3	360303
1.2 TSI	66 - 05/15→12/19 81	Fitting Position: Front Axle Right		24.0711-5274.3	360304
1.4 TDI	66 05/15→12/19				
1.4 TSI	92 05/15→12/19				
1.6 SRE	81 05/15→12/19				
1.6 TDI	66 - 08/13→12/19 85				
1.2	55 07/12→06/15	Construction year from: 10/12 →;		24.0711-5273.3	360303
1.2 LPG	55 - 07/12→06/15 63	Fitting Position: Front Axle Left			
1.2 TSI	63 - 07/12→05/15 77	Construction year from: 10/12 →;		24.0711-5274.3	360304
1.4 TSI	90 07/12→06/15	Fitting Position: Front Axle Right			
→					

	kW				
SKODA - RAPID Spaceback (NH1) 07/12→12/19					
 Wheel Speed Sensor					
1.6 TDI	77	07/12→12/19	Construction year from: 10/12 →; Fitting Position: Front Axle Left	24.0711-5273.3	360303
			Construction year from: 10/12 →; Fitting Position: Front Axle Right	24.0711-5274.3	360304
1.6	77	07/12→06/15	Construction year from: 07/13 →; Fitting Position: Front Axle Left	24.0711-5273.3	360303
			Construction year from: 07/13 →; Fitting Position: Front Axle Right	24.0711-5274.3	360304
SKODA - ROOMSTER (5J7) 03/06→05/15					
Guide Bolt, brake caliper					
1.2	47	05/06→01/07	Construction year from: 07/06 →; for PR number: 1LQ / 1LR / 1ZG; Required quantity: 2	2 11.8171-0008.1	990049 Brake System: ATE
			Construction year from: 07/06 →; for PR number: 1ZC; Required quantity: 2	2 11.8171-0008.1	990049 Brake System: ATE
1.2	51	01/07→05/15	→ Construction year to: 04/15; for PR number: 1LQ / 1LR / 1ZG; Required quantity: 2	2 11.8171-0008.1	990049 Brake System: ATE
1.2 LPG	51	03/09→05/15			
1.2 TDI	55	03/10→05/15			
1.2 TSI	63 - 77	03/10→05/15			
1.4	63	09/06→05/15			
1.4 LPG	63	03/10→05/15	→ Construction year to: 04/15; for PR number: 1ZC; Required quantity: 2	2 11.8171-0008.1	990049 Brake System: ATE
1.6	77	09/06→05/15			
1.6 TDI	66 - 77	03/10→05/15			
1.4 TDI	51 - 59	07/06→03/10	for PR number: 1LQ / 1LR / 1ZG; Required quantity: 2	2 11.8171-0008.1	990049 Brake System: ATE
1.6 LPG	77	06/06→07/10	for PR number: 1ZC;	2 11.8171-0008.1	990049 Brake System: ATE
1.9 TDI	77	09/06→03/10	Required quantity: 2		
 Wheel Speed Sensor					
1.2	47	05/06→01/07	Construction year from: 07/06 →; Fitting Position: Front Axle Left	24.0711-5273.3	360303
			Construction year from: 07/06 →; Fitting Position: Front Axle Right	24.0711-5274.3	360304
1.2	51	01/07→05/15	→ Construction year to: 04/15; Fitting Position: Front Axle Left	24.0711-5273.3	360303
1.2 LPG	51	03/09→05/15			
1.2 TDI	55	03/10→05/15			
1.2 TSI	63 - 77	03/10→05/15			
1.4	63	09/06→05/15			
1.4 LPG	63	03/10→05/15	→ Construction year to: 04/15; Fitting Position: Front Axle Right	24.0711-5274.3	360304
1.6	77	09/06→05/15			
1.6 TDI	66 - 77	03/10→05/15			
1.4 TDI	51 - 59	07/06→03/10	Fitting Position: Front Axle Left	24.0711-5273.3	360303
1.6 LPG	77	06/06→07/10	Fitting Position: Front Axle Right	24.0711-5274.3	360304
1.9 TDI	77	09/06→03/10			
SKODA - ROOMSTER Praktik (5J) 03/07→05/15					
Guide Bolt, brake caliper					
1.2	51	03/07→05/15	→ Construction year to: 04/15; for PR number: 1ZC; Required quantity: 2	2 11.8171-0008.1	990049 Brake System: ATE
1.2 TDI	55	03/10→05/15			
1.2 TSI	63	03/10→05/15			
1.4	63	03/07→05/15	→ Construction year to: 04/15; for PR number: 1LQ / 1LR / 1ZG; Required quantity: 2	2 11.8171-0008.1	990049 Brake System: ATE
1.6 TDI	66	03/10→05/15			
1.4 TDI	51 - 59	03/07→03/10	for PR number: 1ZC; Required quantity: 2	2 11.8171-0008.1	990049 Brake System: ATE
			for PR number: 1LQ / 1LR / 1ZG; Required quantity: 2	2 11.8171-0008.1	990049 Brake System: ATE
 Wheel Speed Sensor					
1.2	51	03/07→05/15	→ Construction year to: 04/15; Fitting Position: Front Axle Left	24.0711-5273.3	360303
1.2 TDI	55	03/10→05/15			
1.2 TSI	63	03/10→05/15	→ Construction year to: 04/15; Fitting Position: Front Axle Right	24.0711-5274.3	360304
1.4	63	03/07→05/15			
1.6 TDI	66	03/10→05/15			
1.4 TDI	51 - 59	03/07→03/10	Fitting Position: Front Axle Left	24.0711-5273.3	360303
			Fitting Position: Front Axle Right	24.0711-5274.3	360304

	kW				
SKODA - SUPERB II (3T4) 03/08→05/15					
Guide Bolt, brake caliper					
1.4 TSI 1.8 TSI 2.0 TDI	92 07/08→05/15 118 03/08→05/15 125 07/08→05/15	Construction year from: 08/08 → → Construction year to: 02/15; for PR number: 1ZE; Required quantity: 2	2	11.8171-0008.1 990049	Brake System: ATE
		Construction year from: 08/08 → → Construction year to: 02/15; for PR number: 1LJ / 1ZA; Required quantity: 2	2	11.8171-0008.1 990049	Brake System: ATE
		Construction year from: 08/08 → → Construction year to: 02/15; for PR number: 1LK; Required quantity: 2	2	11.8171-0008.1 990049	Brake System: ATE
1.6 TDI 1.8 TSI 1.8 TSI 4x4	77 09/10→05/15 112 03/09→05/15 112 - 11/08→05/15 118	→ Construction year to: 02/15; for PR number: 1ZE; Required quantity: 2	2	11.8171-0008.1 990049	Brake System: ATE
2.0 TDI 16V 2.0 TDI 16V 4x4	103 01/09→05/15 103 11/10→05/15	→ Construction year to: 02/15; for PR number: 1LJ / 1ZA; Required quantity: 2	2	11.8171-0008.1 990049	Brake System: ATE
2.0 TFSI 3.6 FSI 4x4	147 05/10→05/15 191 11/08→05/15	→ Construction year to: 02/15; for PR number: 1LK; Required quantity: 2	2	11.8171-0008.1 990049	Brake System: ATE
1.9 TDI 2.0 TDI	77 03/08→11/10 103 03/08→05/10	Construction year from: 08/08 → →; for PR number: 1ZE; Required quantity: 2	2	11.8171-0008.1 990049	Brake System: ATE
		Construction year from: 08/08 → →; for PR number: 1LJ / 1ZA; Required quantity: 2	2	11.8171-0008.1 990049	Brake System: ATE
		Construction year from: 08/08 → →; for PR number: 1LK; Required quantity: 2	2	11.8171-0008.1 990049	Brake System: ATE
2.0 TDI 4x4	125 09/08→05/15	Construction year from: 10/08 → → Construction year to: 02/15; for PR number: 1ZE; Required quantity: 2	2	11.8171-0008.1 990049	Brake System: ATE
		Construction year from: 10/08 → → Construction year to: 02/15; for PR number: 1LJ / 1ZA; Required quantity: 2	2	11.8171-0008.1 990049	Brake System: ATE
		Construction year from: 10/08 → → Construction year to: 02/15; for PR number: 1LK; Required quantity: 2	2	11.8171-0008.1 990049	Brake System: ATE
 Brake Disc					
1.4 TSI 1.8 TSI 2.0 TDI	92 07/08→05/15 118 03/08→05/15 125 07/08→05/15	Construction year from: 08/08 → → Construction year to: 02/15; for PR number: 1ZE; Fitting Position: Front Axle		24.0125-0145.1 425145	Outer diameter [mm]: 288 Brake Disc Thickness [mm] 25 Minimum thickness [mm] 22 Brake Disc Type: Vented Supplementary Article/Info 2: with bolts/screws
		Construction year from: 08/08 → → Construction year to: 02/15; for PR number: 1LJ / 1ZA; Fitting Position: Front Axle		24.0125-0158.1 425158	Outer diameter [mm]: 312 Brake Disc Thickness [mm] 25 Minimum thickness [mm] 22 Brake Disc Type: Vented Supplementary Article/Info 2: with bolts/screws
				24.0325-0158.1 525158	Outer diameter [mm]: 312 Brake Disc Thickness [mm] 25 Minimum thickness [mm] 22 Brake Disc Type: Vented Supplementary Article/Info 2: with bolts/screws
		Construction year from: 08/08 → → Construction year to: 02/15; for PR number: 1KS; Fitting Position: Rear Axle		24.0110-0356.1 410356	Outer diameter [mm]: 272 Brake Disc Thickness [mm] 9.7 Minimum thickness [mm] 8 Brake Disc Type: Solid Supplementary Article/Info 2: with bolts/screws
				24.0310-0356.1 510356	Outer diameter [mm]: 272 Brake Disc Thickness [mm] 9.7 Minimum thickness [mm] 8 Brake Disc Type: Solid Supplementary Article/Info 2: with bolts/screws
1.6 TDI 1.8 TSI 1.8 TSI 4x4	77 09/10→05/15 112 03/09→05/15 112 - 11/08→05/15 118	→ Construction year to: 02/15; for PR number: 1ZE; Fitting Position: Front Axle		24.0125-0145.1 425145	Outer diameter [mm]: 288 Brake Disc Thickness [mm] 25 Minimum thickness [mm] 22 Brake Disc Type: Vented Supplementary Article/Info 2: with bolts/screws
2.0 TDI 16V 2.0 TDI 16V 4x4	103 01/09→05/15 103 11/10→05/15				
2.0 TFSI 3.6 FSI 4x4 →	147 05/10→05/15 191 11/08→05/15				

		kW					
SKODA - SUPERB II (3T4) 03/08→05/15							
 Brake Disc							
1.6 TDI 1.8 TSI 1.8 TSI 4x4 2.0 TDI 16V 2.0 TDI 16V 4x4 2.0 TFSI 3.6 FSI 4x4	77 09/10→05/15 112 03/09→05/15 112 - 11/08→05/15 118 103 01/09→05/15 103 11/10→05/15 147 05/10→05/15 191 11/08→05/15	→ Construction year to: 02/15; for PR number: 1LJ / 1ZA; Fitting Position: Front Axle		24.0125-0158.1 425158	Outer diameter [mm]: 312 Brake Disc Thickness [mm] 25 Minimum thickness [mm] 22 Brake Disc Type: Vented Supplementary Article/Info 2: with bolts/screws	24.0325-0158.1 525158	Outer diameter [mm]: 312 Brake Disc Thickness [mm] 25 Minimum thickness [mm] 22 Brake Disc Type: Vented Supplementary Article/Info 2: with bolts/screws
		→ Construction year to: 02/15; for PR number: 1KS; Fitting Position: Rear Axle		24.0110-0356.1 410356	Outer diameter [mm]: 272 Brake Disc Thickness [mm] 9.7 Minimum thickness [mm] 8 Brake Disc Type: Solid Supplementary Article/Info 2: with bolts/screws	24.0310-0356.1 510356	Outer diameter [mm]: 272 Brake Disc Thickness [mm] 9.7 Minimum thickness [mm] 8 Brake Disc Type: Solid Supplementary Article/Info 2: with bolts/screws
1.9 TDI 2.0 TDI	77 03/08→11/10 103 03/08→05/10	Construction year from: 08/08 →; for PR number: 1ZE; Fitting Position: Front Axle		24.0125-0145.1 425145	Outer diameter [mm]: 288 Brake Disc Thickness [mm] 25 Minimum thickness [mm] 22 Brake Disc Type: Vented Supplementary Article/Info 2: with bolts/screws		
		Construction year from: 08/08 →; for PR number: 1LJ / 1ZA; Fitting Position: Front Axle		24.0125-0158.1 425158	Outer diameter [mm]: 312 Brake Disc Thickness [mm] 25 Minimum thickness [mm] 22 Brake Disc Type: Vented Supplementary Article/Info 2: with bolts/screws	24.0325-0158.1 525158	Outer diameter [mm]: 312 Brake Disc Thickness [mm] 25 Minimum thickness [mm] 22 Brake Disc Type: Vented Supplementary Article/Info 2: with bolts/screws
		Construction year from: 08/08 →; for PR number: 1KS; Fitting Position: Rear Axle		24.0110-0356.1 410356	Outer diameter [mm]: 272 Brake Disc Thickness [mm] 9.7 Minimum thickness [mm] 8 Brake Disc Type: Solid Supplementary Article/Info 2: with bolts/screws	24.0310-0356.1 510356	Outer diameter [mm]: 272 Brake Disc Thickness [mm] 9.7 Minimum thickness [mm] 8 Brake Disc Type: Solid Supplementary Article/Info 2: with bolts/screws
2.0 TDI 4x4	125 09/08→05/15	Construction year from: 10/08 → → Construction year to: 02/15; for PR number: 1ZE; Fitting Position: Front Axle		24.0125-0145.1 425145	Outer diameter [mm]: 288 Brake Disc Thickness [mm] 25 Minimum thickness [mm] 22 Brake Disc Type: Vented Supplementary Article/Info 2: with bolts/screws		
		Construction year from: 10/08 → → Construction year to: 02/15; for PR number: 1LJ / 1ZA; Fitting Position: Front Axle		24.0125-0158.1 425158	Outer diameter [mm]: 312 Brake Disc Thickness [mm] 25 Minimum thickness [mm] 22 Brake Disc Type: Vented Supplementary Article/Info 2: with bolts/screws	24.0325-0158.1 525158	Outer diameter [mm]: 312 Brake Disc Thickness [mm] 25 Minimum thickness [mm] 22 Brake Disc Type: Vented Supplementary Article/Info 2: with bolts/screws
		Construction year from: 10/08 → → Construction year to: 02/15; for PR number: 1KS; Fitting Position: Rear Axle		24.0110-0356.1 410356	Outer diameter [mm]: 272 Brake Disc Thickness [mm] 9.7 Minimum thickness [mm] 8 Brake Disc Type: Solid Supplementary Article/Info 2: with bolts/screws		

→

	kW				
SKODA - SUPERB II (3T4) 03/08→05/15					
 Brake Disc					
2.0 TDI 4x4	125	09/08→05/15	Construction year from: 10/08 → → Construction year to: 02/15; for PR number: 1KS; Fitting Position: Rear Axle	24.0310-0356.1 510356	Outer diameter [mm]: 272 Brake Disc Thickness [mm] 9.7 Minimum thickness [mm] 8 Brake Disc Type: Solid Supplementary Article/Info 2: with bolts/screws
SKODA - SUPERB II Estate (3T5) 10/09→05/15					
Guide Bolt, brake caliper					
1.4 TSI	92	10/09→05/15	Construction year from: 11/09 → →	2	11.8171-0008.1 990049 Brake System: ATE
1.8 TSI	112 -	10/09→05/15	Construction year to: 02/15; for PR number: 1LJ / 1ZA; Required quantity: 2		
1.8 TSI 4x4	112 -	10/09→05/15	Construction year from: 11/09 → →	2	11.8171-0008.1 990049 Brake System: ATE
2.0 TDI	125	10/09→05/15	Construction year to: 02/15; for PR number: 1LK; Required quantity: 2		
2.0 TDI 16V	103	10/09→05/15	Construction year from: 11/09 → →	2	11.8171-0008.1 990049 Brake System: ATE
2.0 TDI 4x4	125	10/09→05/15	Construction year to: 02/15; for PR number: 1ZE; Required quantity: 2		
3.6 V6 4x4	191	10/09→05/15	Construction year from: 11/09 → →	2	11.8171-0008.1 990049 Brake System: ATE
1.6 TDI	77	09/10→05/15	→ Construction year to: 02/15; for PR number: 1LJ / 1ZA; Required quantity: 2	2	11.8171-0008.1 990049 Brake System: ATE
2.0 TDI 16V 4x4	103	11/10→05/15	→ Construction year to: 02/15; for PR number: 1LK; Required quantity: 2	2	11.8171-0008.1 990049 Brake System: ATE
2.0 TFSI	147	05/10→05/15	→ Construction year to: 02/15; for PR number: 1ZE; Required quantity: 2	2	11.8171-0008.1 990049 Brake System: ATE
1.9 TDI	77	10/09→11/10	for PR number: 1ZE; Required quantity: 2	2	11.8171-0008.1 990049 Brake System: ATE
			for PR number: 1LJ / 1ZA; Required quantity: 2	2	11.8171-0008.1 990049 Brake System: ATE
			for PR number: 1LK; Required quantity: 2	2	11.8171-0008.1 990049 Brake System: ATE
2.0 TDI	103	10/09→03/10	Construction year from: 11/09 → →; for PR number: 1LK; Required quantity: 2	2	11.8171-0008.1 990049 Brake System: ATE
			Construction year from: 11/09 → →; for PR number: 1ZE; Required quantity: 2	2	11.8171-0008.1 990049 Brake System: ATE
			Construction year from: 11/09 → →; for PR number: 1LJ / 1ZA; Required quantity: 2	2	11.8171-0008.1 990049 Brake System: ATE
 Brake Disc					
1.4 TSI	92	10/09→05/15	Construction year from: 11/09 → →	24.0125-0145.1 425145	Outer diameter [mm]: 288 Brake Disc Thickness [mm] 25 Minimum thickness [mm] 22 Brake Disc Type: Vented Supplementary Article/Info 2: with bolts/screws
1.8 TSI	112 -	10/09→05/15	Construction year to: 02/15; for PR number: 1ZE;		
1.8 TSI 4x4	112 -	10/09→05/15	Fitting Position: Front Axle		
2.0 TDI	125	10/09→05/15	Construction year from: 11/09 → →	24.0125-0158.1 425158	Outer diameter [mm]: 312 Brake Disc Thickness [mm] 25 Minimum thickness [mm] 22 Brake Disc Type: Vented Supplementary Article/Info 2: with bolts/screws
2.0 TDI 16V	103	10/09→05/15	Construction year to: 02/15; for PR number: 1LJ / 1ZA; Fitting Position: Front Axle	24.0325-0158.1 525158	Outer diameter [mm]: 312 Brake Disc Thickness [mm] 25 Minimum thickness [mm] 22 Brake Disc Type: Vented Supplementary Article/Info 2: with bolts/screws
2.0 TDI 4x4	125	10/09→05/15	Construction year from: 11/09 → →	24.0110-0356.1 410356	Outer diameter [mm]: 272 Brake Disc Thickness [mm] 9.7 Minimum thickness [mm] 8 Brake Disc Type: Solid Supplementary Article/Info 2: with bolts/screws
3.6 V6 4x4	191	10/09→05/15	Construction year to: 02/15; for PR number: 1KS; Fitting Position: Rear Axle	24.0310-0356.1 510356	Outer diameter [mm]: 272 Brake Disc Thickness [mm] 9.7 Minimum thickness [mm] 8 Brake Disc Type: Solid Supplementary Article/Info 2: with bolts/screws
→					





kW



SKODA - SUPERB II Estate (3T5) 10/09→05/15



 Brake Disc

1.6 TDI 2.0 TDI 16V 4x4 2.0 TFSI	77 09/10→05/15	→ Construction year to: 02/15; for PR number: 1ZE; Fitting Position: Front Axle	24.0125-0145.1 425145	Outer diameter [mm]: 288 Brake Disc Thickness [mm] 25 Minimum thickness [mm] 22 Brake Disc Type: Vented Supplementary Article/Info 2: with bolts/screws
	103 11/10→05/15	→ Construction year to: 02/15; for PR number: 1LJ / 1ZA; Fitting Position: Front Axle	24.0125-0158.1 425158	Outer diameter [mm]: 312 Brake Disc Thickness [mm] 25 Minimum thickness [mm] 22 Brake Disc Type: Vented Supplementary Article/Info 2: with bolts/screws
	147 05/10→05/15	→ Construction year to: 02/15; for PR number: 1KS; Fitting Position: Rear Axle	24.0325-0158.1 525158	Outer diameter [mm]: 312 Brake Disc Thickness [mm] 25 Minimum thickness [mm] 22 Brake Disc Type: Vented Supplementary Article/Info 2: with bolts/screws
1.9 TDI	77 10/09→11/10	for PR number: 1ZE; Fitting Position: Front Axle	24.0110-0356.1 410356	Outer diameter [mm]: 272 Brake Disc Thickness [mm] 9.7 Minimum thickness [mm] 8 Brake Disc Type: Solid Supplementary Article/Info 2: with bolts/screws
		for PR number: 1LJ / 1ZA; Fitting Position: Front Axle	24.0310-0356.1 510356	Outer diameter [mm]: 272 Brake Disc Thickness [mm] 9.7 Minimum thickness [mm] 8 Brake Disc Type: Solid Supplementary Article/Info 2: with bolts/screws
		for PR number: 1KS; Fitting Position: Rear Axle	24.0125-0145.1 425145	Outer diameter [mm]: 288 Brake Disc Thickness [mm] 25 Minimum thickness [mm] 22 Brake Disc Type: Vented Supplementary Article/Info 2: with bolts/screws
2.0 TDI	103 10/09→03/10	Construction year from: 11/09 →; for PR number: 1ZE; Fitting Position: Front Axle	24.0125-0158.1 425158	Outer diameter [mm]: 312 Brake Disc Thickness [mm] 25 Minimum thickness [mm] 22 Brake Disc Type: Vented Supplementary Article/Info 2: with bolts/screws
		Construction year from: 11/09 →; for PR number: 1LJ / 1ZA; Fitting Position: Front Axle	24.0325-0158.1 525158	Outer diameter [mm]: 312 Brake Disc Thickness [mm] 25 Minimum thickness [mm] 22 Brake Disc Type: Vented Supplementary Article/Info 2: with bolts/screws
		Construction year from: 11/09 →; for PR number: 1ZE; Fitting Position: Front Axle	24.0125-0145.1 425145	Outer diameter [mm]: 288 Brake Disc Thickness [mm] 25 Minimum thickness [mm] 22 Brake Disc Type: Vented Supplementary Article/Info 2: with bolts/screws

→





	kW					
SKODA - SUPERB II Estate (3T5) 10/09→05/15						
 Brake Disc						
2.0 TDI	103	10/09→03/10	Construction year from: 11/09 →; for PR number: 1KS; Fitting Position: Rear Axle	24.0110-0356.1 410356	Outer diameter [mm]: 272 Brake Disc Thickness [mm] 9.7 Minimum thickness [mm] 8 Brake Disc Type: Solid Supplementary Article/Info 2: with bolts/screws	
				24.0310-0356.1 510356	Outer diameter [mm]: 272 Brake Disc Thickness [mm] 9.7 Minimum thickness [mm] 8 Brake Disc Type: Solid Supplementary Article/Info 2: with bolts/screws	
SKODA - SUPERB III (3V3) 03/15→						
 Brake Caliper						
1.4 TSI	92	03/15→	for PR number: 1ZA / 1ZK; Fitting Position: Front Axle Left	24.3571-1801.5 241387	Supplementary Article/Supplementary Info: without holder Brake Caliper Type: Fist-type Caliper	
1.4 TSI 4x4	110	03/15→				
1.4 TSI iV	115	08/19→				
	160		for PR number: 1ZA / 1ZK; Fitting Position: Front Axle Right	24.3571-1802.5 241388	Supplementary Article/Supplementary Info: without holder Brake Caliper Type: Fist-type Caliper	
1.5 TSI	110	02/17→				
1.6 TDI	88	03/15→				
1.8 TSI	132	03/15→				
2.0 TDI	90	03/15→				
	147					
2.0 TDI 4x4	110	03/15→				
	147					
2.0 TSI	140	03/15→				
	162					
2.0 TSI 4x4	200	03/15→				
	206					
 Brake Disc						
1.4 TSI	92	03/15→	for PR number: 1ZA / 1ZK; Fitting Position: Front Axle	24.0125-0158.1 425158	Outer diameter [mm]: 312 Brake Disc Thickness [mm] 25 Minimum thickness [mm] 22 Brake Disc Type: Vented Supplementary Article/Info 2: with bolts/screws	
1.4 TSI 4x4	110	03/15→				
1.4 TSI iV	115	08/19→				
	160					
1.5 TSI	110	02/17→	for PR number: 1KU / 2EM; Vehicle Equipment: for vehicles with electric parking brake; Fitting Position: Rear Axle	24.0112-0210.1 412210	Outer diameter [mm]: 300 Brake Disc Thickness [mm] 12 Minimum thickness [mm] 10 Brake Disc Type: Solid Supplementary Article/Info 2: with bolts/screws	
1.6 TDI	88	03/15→				
1.8 TSI	132	03/15→				
2.0 TDI	90	03/15→				
	147					
2.0 TDI 4x4	110	03/15→				
	147					
2.0 TSI	140	03/15→				
	162					
2.0 TSI 4x4	200	03/15→				
	206					
 Wheel Speed Sensor						
1.4 TSI	92	03/15→	Fitting Position: Front Axle Left	24.0711-5273.3 360303		
	110		Fitting Position: Front Axle Right	24.0711-5274.3 360304		
1.4 TSI iV	115	08/19→	Required quantity: 2; Comfort Equipment Variant (trim package): for cruise control system; Fitting Position: Rear Axle	2	24.0711-6337.3 360390	
	160					
1.5 TSI	110	02/17→	Required quantity: 2; Vehicle Equipment: for vehicles with parking assistant system; Fitting Position: Rear Axle	2	24.0711-6337.3 360390	
1.6 TDI	88	03/15→				
1.8 TSI	132	03/15→				
2.0 TDI	90	03/15→				
	147					
2.0 TSI	140	03/15→				
	162					
1.4 TSI 4x4	110	03/15→	Fitting Position: Front Axle Left	24.0711-5273.3 360303		
2.0 TDI 4x4	110	03/15→	Fitting Position: Front Axle Right	24.0711-5274.3 360304		
	147		Vehicle Equipment: for vehicles with parking assistant system; Fitting Position: Rear Axle Left	24.0711-5401.3 360330		
2.0 TSI 4x4	200	03/15→				
	206					
						Comfort Equipment Variant (trim package): for cruise control system; Fitting Position: Rear Axle Left
						Comfort Equipment Variant (trim package): for cruise control system; Fitting Position: Rear Axle Right
			Vehicle Equipment: for vehicles with parking assistant system; Fitting Position: Rear Axle Right	24.0711-5402.3 360331		

	kW				
SKODA - SUPERB III (3V3) 03/15→					
Control Element, parking brake caliper					
1.4 TSI	92 - 03/15→ 110		for PR number: 1KU / 1KZ / 2EM / 2ER; Fitting Position: Rear Axle Left	11.9282-1001.3 250159	Brake System: ATE
1.4 TSI 4x4	110 03/15→				
1.4 TSI IV	115 - 08/19→ 160		for PR number: 1KU / 1KZ / 2EM / 2ER; Fitting Position: Rear Axle Right	11.9282-1002.3 250160	Brake System: ATE
1.5 TSI	110 02/17→				
1.6 TDI	88 03/15→				
1.8 TSI	132 03/15→				
2.0 TDI	90 - 03/15→ 147				
2.0 TDI 4x4	110 - 03/15→ 147				
2.0 TSI	140 - 03/15→ 162				
2.0 TSI 4x4	200 - 03/15→ 206				
SKODA - SUPERB III Estate (3V5) 03/15→					
 Brake Caliper					
1.4 TSI	92 - 03/15→ 110		for PR number: 1ZA / 1ZK; Fitting Position: Front Axle Left	24.3571-1801.5 241387	Supplementary Article/Supplementary Info: without holder Brake Caliper Type: Fist-type Caliper
1.4 TSI 4x4	110 03/15→				
1.4 TSI IV	115 - 08/19→ 160				
1.5 TSi	110 02/17→		for PR number: 1ZA / 1ZK; Fitting Position: Front Axle Right	24.3571-1802.5 241388	Supplementary Article/Supplementary Info: without holder Brake Caliper Type: Fist-type Caliper
1.6 TDI	88 03/15→				
1.8 TSI	132 03/15→				
2.0 TDI	90 - 03/15→ 147				
2.0 TDI 4x4	110 - 03/15→ 147				
2.0 TSI	140 - 03/15→ 162				
2.0 TSI 4x4	200 - 03/15→ 206				
 Brake Disc					
1.4 TSI	92 - 03/15→ 110		for PR number: 1ZA / 1ZK; Fitting Position: Front Axle	24.0125-0158.1 425158	Outer diameter [mm]: 312 Brake Disc Thickness [mm] 25 Minimum thickness [mm] 22 Brake Disc Type: Vented Supplementary Article/Info 2: with bolts/screws
1.4 TSI 4x4	110 03/15→				
1.4 TSI IV	115 - 08/19→ 160				
1.5 TSi	110 02/17→				
1.6 TDI	88 03/15→				
1.8 TSI	132 03/15→				
2.0 TDI	90 - 03/15→ 147		for PR number: 1KU / 2EM; Vehicle Equipment: for vehicles with electric parking brake; Fitting Position: Rear Axle	24.0112-0210.1 412210	Outer diameter [mm]: 300 Brake Disc Thickness [mm] 12 Minimum thickness [mm] 10 Brake Disc Type: Solid Supplementary Article/Info 2: with bolts/screws
2.0 TDI 4x4	110 - 03/15→ 147				
2.0 TSI	140 - 03/15→ 162				
2.0 TSI 4x4	200 - 03/15→ 206				
 Wheel Speed Sensor					
1.4 TSI	92 - 03/15→ 110		Fitting Position: Front Axle Left	24.0711-5273.3 360303	
1.4 TSI IV	115 - 08/19→ 160		Fitting Position: Front Axle Right	24.0711-5274.3 360304	
1.5 TSi	110 02/17→		Required quantity: 2; Comfort Equipment Variant (trim package): for cruise control system; Fitting Position: Rear Axle	2 24.0711-6337.3 360390	
1.6 TDI	88 03/15→				
1.8 TSI	132 03/15→				
2.0 TDI	90 - 03/15→ 147		Required quantity: 2; Vehicle Equipment: for vehicles with parking assistant system; Fitting Position: Rear Axle	2 24.0711-6337.3 360390	
2.0 TSI	140 - 03/15→ 162				
1.4 TSI 4x4	110 03/15→		Fitting Position: Front Axle Left	24.0711-5273.3 360303	
			Fitting Position: Front Axle Right	24.0711-5274.3 360304	
			Comfort Equipment Variant (trim package): for cruise control system; Fitting Position: Rear Axle Left	24.0711-5401.3 360330	
			Vehicle Equipment: for vehicles with parking assistant system; Comfort Equipment Variant (trim package): for cruise control system; Fitting Position: Rear Axle Left	24.0711-5401.3 360330	
			Comfort Equipment Variant (trim package): for cruise control system; Fitting Position: Rear Axle Right	24.0711-5402.3 360331	
→					

	kW				
SKODA - SUPERB III Estate (3V5) 03/15→					
 Wheel Speed Sensor					
1.4 TSI 4x4	110 03/15→	Vehicle Equipment: for vehicles with parking assistant system; Fitting Position: Rear Axle Right		24.0711-5402.3 360331	
2.0 TDI 4x4	110 - 03/15→ 147	Fitting Position: Front Axle Left		24.0711-5273.3 360303	
2.0 TSI 4x4	200 - 03/15→ 206	Fitting Position: Front Axle Right		24.0711-5274.3 360304	
		Vehicle Equipment: for vehicles with parking assistant system; Fitting Position: Rear Axle Left		24.0711-5401.3 360330	
		Comfort Equipment Variant (trim package): for cruise control system; Fitting Position: Rear Axle Left		24.0711-5401.3 360330	
		Comfort Equipment Variant (trim package): for cruise control system; Fitting Position: Rear Axle Right		24.0711-5402.3 360331	
		Vehicle Equipment: for vehicles with parking assistant system; Fitting Position: Rear Axle Right		24.0711-5402.3 360331	
Control Element, parking brake caliper					
1.4 TSI	92 - 03/15→ 110	for PR number: 1KU / 1KZ / 2EM / 2ER; Fitting Position: Rear Axle Left		11.9282-1001.3 250159	Brake System: ATE
1.4 TSI 4x4	110 03/15→			11.9282-1002.3 250160	Brake System: ATE
1.4 TSI iV	115 - 08/19→ 160	for PR number: 1KU / 1KZ / 2EM / 2ER; Fitting Position: Rear Axle Right			
1.5 TSi	110 02/17→				
1.6 TDI	88 03/15→				
1.8 TSI	132 03/15→				
2.0 TDI	90 - 03/15→ 147				
2.0 TDI 4x4	110 - 03/15→ 147				
2.0 TSI	140 - 03/15→ 162				
2.0 TSI 4x4	200 - 03/15→ 206				
SKODA - YETI (5L) 05/09→12/17					
Guide Bolt, brake caliper					
1.2 TSI	77 - 09/09→12/17 81	for PR number: 1ZA / 1ZE; Required quantity: 2	2	11.8171-0008.1 990049	Brake System: ATE
1.4 TSI	90 - 06/10→12/17 92				
1.4 TSI 4x4	110 05/15→12/17				
1.6	81 04/14→12/17				
1.6 TDI	77 11/10→05/15				
1.8 TSI 4x4	112 - 05/09→12/17 118				
2.0 TDI	81 - 11/09→12/17 110				
2.0 TDI 4x4	81 - 05/09→12/17 125				
 Brake Disc					
1.2 TSI	77 09/09→05/15	for PR number: 1ZE;		24.0125-0145.1 425145	Outer diameter [mm]: 288 Brake Disc Thickness [mm] 25 Minimum thickness [mm] 22 Brake Disc Type: Vented Supplementary Article/Info 2: with bolts/screws
1.8 TSI 4x4	118 05/09→12/17	Fitting Position: Front Axle			
		for PR number: 1ZA; Fitting Position: Front Axle		24.0125-0158.1 425158	Outer diameter [mm]: 312 Brake Disc Thickness [mm] 25 Minimum thickness [mm] 22 Brake Disc Type: Vented Supplementary Article/Info 2: with bolts/screws
				24.0325-0158.1 525158	Outer diameter [mm]: 312 Brake Disc Thickness [mm] 25 Minimum thickness [mm] 22 Brake Disc Type: Vented Supplementary Article/Info 2: with bolts/screws
		Construction year from: 11/09 →; for PR number: 1KS; Fitting Position: Rear Axle		24.0110-0356.1 410356	Outer diameter [mm]: 272 Brake Disc Thickness [mm] 9.7 Minimum thickness [mm] 8 Brake Disc Type: Solid Supplementary Article/Info 2: with bolts/screws
→					







		kW					
SKODA - YETI (5L) 05/09→12/17							
 Brake Disc							
1.2 TSI 1.8 TSI 4x4	77 09/09→05/15 118 05/09→12/17	Construction year from: 11/09 →; for PR number: 1KS; Fitting Position: Rear Axle		24.0310-0356.1 510356	Outer diameter [mm]: 272 Brake Disc Thickness [mm] 9.7 Minimum thickness [mm] 8 Brake Disc Type: Solid Supplementary Article/Info 2: with bolts/screws		
1.2 TSI 1.4 TSI 1.4 TSI 4x4 1.6 TDI 1.8 TSI 4x4 2.0 TDI	81 05/15→12/17 90 - 06/10→12/17 92 110 05/15→12/17 77 11/10→05/15 112 11/09→12/17 81 - 11/09→12/17 110	for PR number: 1ZE; Fitting Position: Front Axle		24.0125-0145.1 425145	Outer diameter [mm]: 288 Brake Disc Thickness [mm] 25 Minimum thickness [mm] 22 Brake Disc Type: Vented Supplementary Article/Info 2: with bolts/screws		
2.0 TDI 4x4	81 - 11/09→12/17 110 125	for PR number: 1ZA; Fitting Position: Front Axle		24.0125-0158.1 425158	Outer diameter [mm]: 312 Brake Disc Thickness [mm] 25 Minimum thickness [mm] 22 Brake Disc Type: Vented Supplementary Article/Info 2: with bolts/screws		
		for PR number: 1KS; Fitting Position: Rear Axle		24.0110-0356.1 410356	Outer diameter [mm]: 272 Brake Disc Thickness [mm] 9.7 Minimum thickness [mm] 8 Brake Disc Type: Solid Supplementary Article/Info 2: with bolts/screws		
				24.0310-0356.1 510356	Outer diameter [mm]: 272 Brake Disc Thickness [mm] 9.7 Minimum thickness [mm] 8 Brake Disc Type: Solid Supplementary Article/Info 2: with bolts/screws		
1.6	81 04/14→12/17	for PR number: 1ZE; Fitting Position: Front Axle		24.0125-0145.1 425145	Outer diameter [mm]: 288 Brake Disc Thickness [mm] 25 Minimum thickness [mm] 22 Brake Disc Type: Vented Supplementary Article/Info 2: with bolts/screws		
		for PR number: 1ZA; Fitting Position: Front Axle		24.0125-0158.1 425158	Outer diameter [mm]: 312 Brake Disc Thickness [mm] 25 Minimum thickness [mm] 22 Brake Disc Type: Vented Supplementary Article/Info 2: with bolts/screws		
		for PR number: 1KS; Fitting Position: Rear Axle		24.0110-0356.1 410356	Outer diameter [mm]: 272 Brake Disc Thickness [mm] 9.7 Minimum thickness [mm] 8 Brake Disc Type: Solid Supplementary Article/Info 2: with bolts/screws		
				24.0310-0356.1 510356	Outer diameter [mm]: 272 Brake Disc Thickness [mm] 9.7 Minimum thickness [mm] 8 Brake Disc Type: Solid Supplementary Article/Info 2: with bolts/screws		
2.0 TDI 4x4	103 05/09→12/17	for PR number: 1ZE; Fitting Position: Front Axle		24.0125-0145.1 425145	Outer diameter [mm]: 288 Brake Disc Thickness [mm] 25 Minimum thickness [mm] 22 Brake Disc Type: Vented Supplementary Article/Info 2: with bolts/screws		
		for PR number: 1ZA; Fitting Position: Front Axle		24.0125-0158.1 425158	Outer diameter [mm]: 312 Brake Disc Thickness [mm] 25 Minimum thickness [mm] 22 Brake Disc Type: Vented Supplementary Article/Info 2: with bolts/screws		
				24.0325-0158.1 525158	Outer diameter [mm]: 312 Brake Disc Thickness [mm] 25 Minimum thickness [mm] 22 Brake Disc Type: Vented Supplementary Article/Info 2: with bolts/screws		

→

	kW				
SKODA - YETI (5L) 05/09→12/17					
 Brake Disc					
2.0 TDI 4x4	103 05/09→12/17	Construction year from: 05/15 →; for PR number: 1ZA; Fitting Position: Front Axle		24.0125-0158.1 425158	Outer diameter [mm]: 312 Brake Disc Thickness [mm] 25 Minimum thickness [mm] 22 Brake Disc Type: Vented Supplementary Article/Info 2: with bolts/screws
				24.0325-0158.1 525158	Outer diameter [mm]: 312 Brake Disc Thickness [mm] 25 Minimum thickness [mm] 22 Brake Disc Type: Vented Supplementary Article/Info 2: with bolts/screws
		Construction year from: 11/09 →; for PR number: 1KS; Fitting Position: Rear Axle		24.0110-0356.1 410356	Outer diameter [mm]: 272 Brake Disc Thickness [mm] 9.7 Minimum thickness [mm] 8 Brake Disc Type: Solid Supplementary Article/Info 2: with bolts/screws
				24.0310-0356.1 510356	Outer diameter [mm]: 272 Brake Disc Thickness [mm] 9.7 Minimum thickness [mm] 8 Brake Disc Type: Solid Supplementary Article/Info 2: with bolts/screws
SUZUKI - S-CROSS (AKK414) 01/22→					
 Brake Disc					
1.4 Smart Hybrid	95 01/22→	Fitting Position: Front Axle		24.0122-0290.1 422290	Outer diameter [mm]: 280 Brake Disc Thickness [mm] 22 Minimum thickness [mm] 20 Brake Disc Type: Vented
1.4 Smart Hybrid AllGrip	95 01/22→				
		Fitting Position: Rear Axle		24.0109-0182.1 409182	Outer diameter [mm]: 259.4 Brake Disc Thickness [mm] 9 Minimum thickness [mm] 8 Brake Disc Type: Solid
SUZUKI - SX4 S-CROSS (JY) 08/13→					
 Brake Disc					
1.0	82 08/16→	Fitting Position: Front Axle		24.0122-0290.1 422290	Outer diameter [mm]: 280 Brake Disc Thickness [mm] 22 Minimum thickness [mm] 20 Brake Disc Type: Vented
1.0 AllGrip	82 08/16→				
1.4 T	103 08/16→				
1.4 T AllGrip	103 08/16→				
1.4 Turbo 4Style	107 01/17→				
1.6	85 - 08/13→	Fitting Position: Rear Axle		24.0109-0182.1 409182	Outer diameter [mm]: 259.4 Brake Disc Thickness [mm] 9 Minimum thickness [mm] 8 Brake Disc Type: Solid
	88				
1.6 AllGrip	85 - 08/13→				
	88				
1.6 DDiS	88 08/13→				
1.6 DDiS AllGrip	88 08/13→				
1.6 VVT	93 08/16→				
SUZUKI - VITARA (LY) 02/15→					
 Brake Disc					
1.4 4Sport Turbo / 4 Style AllGrip	107 01/16→	Fitting Position: Front Axle		24.0122-0290.1 422290	Outer diameter [mm]: 280 Brake Disc Thickness [mm] 22 Minimum thickness [mm] 20 Brake Disc Type: Vented
1.4 T	103 09/15→				
1.4 T AllGrip	103 09/15→				
1.6	85 - 02/15→	Fitting Position: Rear Axle		24.0109-0182.1 409182	Outer diameter [mm]: 259.4 Brake Disc Thickness [mm] 9 Minimum thickness [mm] 8 Brake Disc Type: Solid
	88				
1.6 AllGrip	85 - 02/15→				
	88				
1.6 DDiS	88 02/15→				
1.6 DDiS AllGrip	88 02/15→				
1.6 VVT	93 08/16→				
1.6 VVT AllGrip	93 08/16→				
TALBOT - 1307-1510 07/75→04/84					
Guide Sleeve Kit, brake caliper					
1510 1.6	66 07/81→06/82	Fitting Position: Front Axle		11.0101-5407.2 260011	Brake System: ATE
Simca 1510 1.6	54 11/80→12/83				
Simca 1510 1.4	51 - 01/80→04/84	Construction year from: 09/80 →; Fitting Position: Front Axle		11.0101-5407.2 260011	Brake System: ATE
	63				
Guide Bolt, brake caliper					
1510 1.6	66 07/81→06/82	Required quantity: 2;	2	11.8171-0008.1 990049	Brake System: ATE
Simca 1510 1.6	54 11/80→12/83	Fitting Position: Front Axle			
→					

	kW				
TALBOT - 1307-1510 07/75→04/84					
Guide Bolt, brake caliper					
Simca 1510 1.4	51 - 01/80→04/84 63	Construction year from: 09/80 →; Required quantity: 2; Fitting Position: Front Axle	2	11.8171-0008.1 990049	Brake System: ATE
TALBOT - SOLARA 02/80→07/86					
Guide Sleeve Kit, brake caliper					
1.3	40 02/80→07/86	Construction year from: 09/80 → → Construction year to: 06/82; Fitting Position: Front Axle		11.0101-5407.2 260011	Brake System: ATE
1.6	51 - 09/81→07/86 66	Fitting Position: Front Axle		11.0101-5407.2 260011	Brake System: ATE
1.6	65 02/80→06/81	Construction year from: 09/80 →; Fitting Position: Front Axle		11.0101-5407.2 260011	Brake System: ATE
Guide Bolt, brake caliper					
1.3	40 02/80→07/86	Construction year from: 09/80 → → Construction year to: 06/82; Required quantity: 2; Fitting Position: Front Axle	2	11.8171-0008.1 990049	Brake System: ATE
1.6	51 - 09/81→07/86 66	Required quantity: 2; Fitting Position: Front Axle	2	11.8171-0008.1 990049	Brake System: ATE
1.6	65 02/80→06/81	Construction year from: 09/80 →; Required quantity: 2; Fitting Position: Front Axle	2	11.8171-0008.1 990049	Brake System: ATE
TOYOTA - ALPHARD I (_H1_) 04/03→04/08					
 Brake Pad Set, disc brake					
2.4	117 09/03→04/08	Fitting Position: Rear Axle		13.0460-5847.2 605847	Brake System: Sumitomo 23646 16,5 Wear Warning Contact: with acoustic wear warning
2.4 4WD	117 09/03→04/08				
2.4 Hybrid 4WD	117 09/03→04/08				
3.0	162 04/03→04/08				
3.0 4WD	162 04/03→04/08				
TOYOTA - AVENSIS (_T22_) 09/97→02/03					
Guide Sleeve Kit, brake caliper					
1.6	74 09/97→10/00	→ Construction year to: 09/00;		11.0101-5407.2 260011	Brake System: ATE
1.8	81 09/97→10/00	Braking System: for vehicles with drum brakes on the rear axle;			
2.0	94 09/97→10/00	Fitting Position: Front Axle			
1.6	81 10/97→06/00	Braking System: for vehicles with drum brakes on the rear axle;		11.0101-5407.2 260011	Brake System: ATE
2.0 D	61 10/97→05/98	Fitting Position: Front Axle			
1.6 VVT-i	81 10/00→02/03	Construction year from: 07/01 →;		11.0101-5407.2 260011	Brake System: ATE
1.8 VVT-i	95 10/00→02/03	Braking System: for vehicles with disc brakes on the rear axle;			
2.0 VVT-i	110 10/00→02/03	Fitting Position: Front Axle			
2.0 D-4D	81 10/99→02/03	Construction year from: 07/01 →;		11.0101-5407.2 260011	Brake System: ATE
2.0 TD	66 09/97→02/03	Braking System: for vehicles with disc brakes on the rear axle;			
		Fitting Position: Front Axle			
		Braking System: for vehicles with drum brakes on the rear axle;		11.0101-5407.2 260011	Brake System: ATE
		Fitting Position: Front Axle			
Guide Bolt, brake caliper					
1.6	74 09/97→10/00	→ Construction year to: 09/00;	2	11.8171-0008.1 990049	Brake System: ATE
1.8	81 09/97→10/00	Braking System: for vehicles with drum brakes on the rear axle;			
2.0	94 09/97→10/00	Required quantity: 2			
1.6	81 10/97→06/00	Braking System: for vehicles with drum brakes on the rear axle;	2	11.8171-0008.1 990049	Brake System: ATE
2.0 D	61 10/97→05/98	Required quantity: 2			
1.6 VVT-i	81 10/00→02/03	Construction year from: 07/01 →;	2	11.8171-0008.1 990049	Brake System: ATE
1.8 VVT-i	95 10/00→02/03	Braking System: for vehicles with disc brakes on the rear axle;			
2.0 VVT-i	110 10/00→02/03	Required quantity: 2			
2.0 D-4D	81 10/99→02/03	Construction year from: 07/01 →;	2	11.8171-0008.1 990049	Brake System: ATE
2.0 TD	66 09/97→02/03	Braking System: for vehicles with disc brakes on the rear axle;			
		Required quantity: 2			
		Braking System: for vehicles with drum brakes on the rear axle;	2	11.8171-0008.1 990049	Brake System: ATE
		Required quantity: 2			

	kW				
TOYOTA - AVENSIS Estate (_T22_) 09/97→02/03					
Guide Sleeve Kit, brake caliper					
1.6	74 - 09/97→10/00	→ Construction year to: 09/00;		11.0101-5407.2 260011	Brake System: ATE
1.8	81 09/97→10/00	Braking System: for vehicles with drum			
2.0	94 09/97→10/00	brakes on the rear axle;			
		Fitting Position: Front Axle			
1.6	81 07/00→02/03	Construction year from: 07/01 →;		11.0101-5407.2 260011	Brake System: ATE
1.8	95 10/00→02/03	Braking System: for vehicles with disc			
2.0	110 10/00→02/03	brakes on the rear axle;			
		Fitting Position: Front Axle			
2.0 D	85 09/02→02/03	Braking System: for vehicles with disc		11.0101-5407.2 260011	Brake System: ATE
		brakes on the rear axle;			
		Fitting Position: Front Axle			
2.0 D	61 10/97→05/98	Braking System: for vehicles with drum		11.0101-5407.2 260011	Brake System: ATE
		brakes on the rear axle;			
		Fitting Position: Front Axle			
2.0 D-4D	81 10/99→02/03	Construction year from: 07/01 →;		11.0101-5407.2 260011	Brake System: ATE
2.0 TD	66 09/97→02/03	Braking System: for vehicles with disc			
		brakes on the rear axle;			
		Fitting Position: Front Axle			
		Braking System: for vehicles with drum		11.0101-5407.2 260011	Brake System: ATE
		brakes on the rear axle;			
		Fitting Position: Front Axle			
Guide Bolt, brake caliper					
1.6	74 - 09/97→10/00	→ Construction year to: 09/00;	2	11.8171-0008.1 990049	Brake System: ATE
1.8	81 09/97→10/00	Braking System: for vehicles with drum			
2.0	94 09/97→10/00	brakes on the rear axle;			
		Required quantity: 2			
1.6	81 07/00→02/03	Construction year from: 07/01 →;	2	11.8171-0008.1 990049	Brake System: ATE
1.8	95 10/00→02/03	Braking System: for vehicles with disc			
2.0	110 10/00→02/03	brakes on the rear axle;			
		Required quantity: 2			
2.0 D	85 09/02→02/03	Braking System: for vehicles with disc	2	11.8171-0008.1 990049	Brake System: ATE
		brakes on the rear axle;			
		Required quantity: 2			
2.0 D	61 10/97→05/98	Braking System: for vehicles with drum	2	11.8171-0008.1 990049	Brake System: ATE
		brakes on the rear axle;			
		Required quantity: 2			
2.0 D-4D	81 10/99→02/03	Construction year from: 07/01 →;	2	11.8171-0008.1 990049	Brake System: ATE
2.0 TD	66 09/97→02/03	Braking System: for vehicles with disc			
		brakes on the rear axle;			
		Required quantity: 2			
		Braking System: for vehicles with drum	2	11.8171-0008.1 990049	Brake System: ATE
		brakes on the rear axle;			
		Required quantity: 2			
TOYOTA - AVENSIS Liftback (_T22_) 09/97→02/03					
Guide Sleeve Kit, brake caliper					
1.6	74 - 09/97→10/00	→ Construction year to: 09/00;		11.0101-5407.2 260011	Brake System: ATE
1.8	81 09/97→10/00	Braking System: for vehicles with drum			
2.0	94 09/97→10/00	brakes on the rear axle;			
		Fitting Position: Front Axle			
1.6	81 10/00→02/03	Construction year from: 07/01 →;		11.0101-5407.2 260011	Brake System: ATE
1.8	95 10/00→02/03	Braking System: for vehicles with disc			
2.0	110 10/00→02/03	brakes on the rear axle;			
		Fitting Position: Front Axle			
2.0 D	85 09/02→02/03	Braking System: for vehicles with disc		11.0101-5407.2 260011	Brake System: ATE
		brakes on the rear axle;			
		Fitting Position: Front Axle			
2.0 D-4D	81 10/99→02/03	Construction year from: 07/01 →;		11.0101-5407.2 260011	Brake System: ATE
2.0 TD	66 09/97→02/03	Braking System: for vehicles with disc			
		brakes on the rear axle;			
		Fitting Position: Front Axle			
		Braking System: for vehicles with drum		11.0101-5407.2 260011	Brake System: ATE
		brakes on the rear axle;			
		Fitting Position: Front Axle			
Guide Bolt, brake caliper					
1.6	74 - 09/97→10/00	→ Construction year to: 09/00;	2	11.8171-0008.1 990049	Brake System: ATE
1.8	81 09/97→10/00	Braking System: for vehicles with drum			
2.0	94 09/97→10/00	brakes on the rear axle;			
		Required quantity: 2			
1.6	81 10/00→02/03	Construction year from: 07/01 →;	2	11.8171-0008.1 990049	Brake System: ATE
1.8	95 10/00→02/03	Braking System: for vehicles with disc			
2.0	110 10/00→02/03	brakes on the rear axle;			
		Required quantity: 2			
2.0 D	85 09/02→02/03	Braking System: for vehicles with disc	2	11.8171-0008.1 990049	Brake System: ATE
		brakes on the rear axle;			
		Required quantity: 2			
→					

	kW				
TOYOTA - AVENSIS Liftback (_T22_) 09/97→02/03					
Guide Bolt, brake caliper					
2.0 D-4D 2.0 TD	81 10/99→02/03 66 09/97→02/03	Construction year from: 07/01 →; Braking System: for vehicles with disc brakes on the rear axle; Required quantity: 2	2	11.8171-0008.1 990049	Brake System: ATE
		Braking System: for vehicles with drum brakes on the rear axle; Required quantity: 2	2	11.8171-0008.1 990049	Brake System: ATE
TOYOTA - AVENSIS VERSO (_M2_) 05/01→12/11					
 Brake Pad Set, disc brake					
2.0 2.0 D 2.4 2.4 4WD 2.4 VVTi 4WD	110 08/01→11/09 85 08/01→08/05 115 - 05/01→12/11 118 115 11/03→08/06 118 05/01→12/10	Fitting Position: Rear Axle		13.0460-5847.2 605847	Brake System: Sumitomo 23646 16,5 Wear Warning Contact: with acoustic wear warning
TOYOTA - ISIS (_M1_) 07/04→					
 Brake Pad Set, disc brake					
2.0 VVTi 2.0 VVTi 4WD	114 - 07/04→08/14 116 114 07/04→08/14	Fitting Position: Rear Axle		13.0460-5847.2 605847	Brake System: Sumitomo 23646 16,5 Wear Warning Contact: with acoustic wear warning
TOYOTA - NOAH/VOXY (_R7_) 06/07→12/13					
 Brake Pad Set, disc brake					
2.0 2.0 4WD	103 06/07→12/13 103 06/07→12/13	Fitting Position: Rear Axle		13.0460-5847.2 605847	Brake System: Sumitomo 23646 16,5 Wear Warning Contact: with acoustic wear warning
TOYOTA - PREVIA II (_R3_) 02/00→02/06					
 Brake Pad Set, disc brake					
2.0 D-4D 2.4	85 03/01→01/06 115 - 02/00→02/06 125	→ Construction year to: 12/05; Fitting Position: Rear Axle		13.0460-5847.2 605847	Brake System: Sumitomo 23646 16,5 Wear Warning Contact: with acoustic wear warning
2.4 4WD 3.0 3.0 4WD	125 02/00→01/06 162 08/00→12/05 162 02/00→12/05	Fitting Position: Rear Axle		13.0460-5847.2 605847	Brake System: Sumitomo 23646 16,5 Wear Warning Contact: with acoustic wear warning
TOYOTA - SIENNA (_L2_) 01/03→12/10					
 Brake Pad Set, disc brake					
3.3	169 01/03→12/06	Fitting Position: Rear Axle		13.0460-5847.2 605847	Brake System: Sumitomo 23646 16,5 Wear Warning Contact: with acoustic wear warning
TOYOTA - SUPRA (DB_) 03/19→					
 Brake Pad Set, disc brake					
2.0	145 - 06/19→ 190	Fitting Position: Rear Axle		13.0460-5525.2 605525	Brake System: Mando Wear Warning Contact: prepared for wear indicator / excl. wear warning contact Supplementary Article/Supple- mentary Info: with accessories
				13.0470-5525.2 LD5525	Brake System: Mando Wear Warning Contact: prepared for wear indicator / excl. wear warning contact Supplementary Article/Supple- mentary Info: with accessories Ceramic
3.0 GR	250 03/19→	Fitting Position: Rear Axle		13.0460-5525.2 605525	Brake System: Mando Wear Warning Contact: prepared for wear indicator / excl. wear warning contact Supplementary Article/Supple- mentary Info: with accessories

	kW				
VAUXHALL - ASTRA Mk II Hatchback (T85) 09/84→08/91					
Guide Bolt, brake caliper					
1.8 GTE	82 09/84→08/91	for brake disc thickness [mm]: 24;	2	11.8171-0008.1 990049	Brake System: ATE
2.0 GTE	95 09/86→08/91	Required quantity: 2			
2.0 GTE 16V	115 05/88→08/91				
VAUXHALL - ASTRA Mk III (F) Convertible (T92) 09/91→03/01					
Guide Sleeve Kit, brake caliper					
1.6 i	52 03/93→08/96	Fitting Position: Front Axle		11.0101-5407.2 260011	Brake System: ATE
1.8	92 09/94→08/96				
2.0 i	85 03/93→10/94				
1.6 i	55 01/96→03/01	Fitting Position: Front Axle		11.0101-5407.2 260011	Brake System: ATE
1.8 16V	85 11/94→03/01	→ Construction year to: 09/98; Fitting Position: Front Axle		11.0101-5407.2 260011	Brake System: ATE
2.0 i 16V	100 01/94→02/98	→ Construction year to: 10/94; Fitting Position: Front Axle		11.0101-5407.2 260011	Brake System: ATE
Guide Bolt, brake caliper					
1.6 i	52 03/93→08/96	Required quantity: 2	2	11.8171-0008.1 990049	Brake System: ATE
		Required quantity: 2; Fitting Position: Front Axle	2	11.8171-0008.1 990049	Brake System: ATE
1.6 i	55 01/96→03/01	→ Construction year to: 09/98; Required quantity: 2	2	11.8171-0008.1 990049	Brake System: ATE
		Required quantity: 2; Fitting Position: Front Axle	2	11.8171-0008.1 990049	Brake System: ATE
1.8	92 09/94→08/96	Required quantity: 2	2	11.8171-0008.1 990049	Brake System: ATE
2.0 i	85 03/93→10/94				
1.8 16V	85 11/94→03/01	→ Construction year to: 09/98; Required quantity: 2	2	11.8171-0008.1 990049	Brake System: ATE
		Required quantity: 2	2	11.8171-0008.1 990049	Brake System: ATE
2.0 i 16V	100 01/94→02/98	→ Construction year to: 10/94; Required quantity: 2	2	11.8171-0008.1 990049	Brake System: ATE
VAUXHALL - ASTRA Mk III (F) Estate (T92) 03/91→12/98					
Guide Sleeve Kit, brake caliper					
1.4 i	44 09/91→02/98	Construction year from: 10/91 →;		11.0101-5407.2 260011	Brake System: ATE
1.6 Si	74 03/91→12/94	Fitting Position: Front Axle			
1.7 D	44 03/91→12/94				
1.8 i	66 09/91→02/98				
2.0 i	85 09/91→02/98				
1.4 i	60 03/91→02/98	Construction year from: 10/91 →; Transmission Type: Automatic Transmis- sion; Braking System: not for vehicles with reinforced brakes; Fitting Position: Front Axle		11.0101-5407.2 260011	Brake System: ATE
		Construction year from: 10/91 →; Transmission Type: Manual Transmis- sion; Braking System: not for vehicles with reinforced brakes; Fitting Position: Front Axle		11.0101-5407.2 260011	Brake System: ATE
		Construction year from: 10/91 →; Braking System: for vehicles with rein- forced brakes; Fitting Position: Front Axle		11.0101-5407.2 260011	Brake System: ATE
1.4 i 16V	66 02/96→01/98	Fitting Position: Front Axle		11.0101-5407.2 260011	Brake System: ATE
1.6 i	52 07/94→02/98				
1.6 i 16V	74 01/94→02/98				
1.7 D	42 12/91→02/98				
1.7 TD	50 - 12/91→02/98				
	60				
1.8 i 16V	85 - 09/94→02/98				
	92				
2.0 i 16V	100 01/94→02/98				
1.6 i	55 09/91→12/98	Construction year from: 10/91 → → Construction year to: 09/98; Fitting Position: Front Axle		11.0101-5407.2 260011	Brake System: ATE
Guide Bolt, brake caliper					
1.4 i	44 09/91→02/98	Construction year from: 10/91 →;	2	11.8171-0008.1 990049	Brake System: ATE
1.6 Si	74 03/91→12/94	Required quantity: 2; Fitting Position: Front Axle			
1.4 i	60 03/91→02/98	Construction year from: 10/91 →; Braking System: for vehicles with rein- forced brakes; Required quantity: 2	2	11.8171-0008.1 990049	Brake System: ATE
		Construction year from: 10/91 →; Transmission Type: Manual Transmis- sion; Braking System: not for vehicles with	2	11.8171-0008.1 990049	Brake System: ATE

→

	kW				
VAUXHALL - ASTRA Mk III (F) Estate (T92) 03/91→12/98					
Guide Bolt, brake caliper					
1.4 i	60	03/91→02/98	reinforced brakes; Required quantity: 2; Fitting Position: Front Axle		
			Construction year from: 10/91 →; Transmission Type: Automatic Transmis- sion; Braking System: not for vehicles with reinforced brakes; Required quantity: 2; Fitting Position: Front Axle	2	11.8171-0008.1 990049 Brake System: ATE
1.4 i 16V 1.7 D 1.7 TD	66 42	02/96→01/98 12/91→02/98	Braking System: for vehicles with rein- forced brakes; Required quantity: 2	2	11.8171-0008.1 990049 Brake System: ATE
	50 - 60	12/91→02/98	Braking System: not for vehicles with reinforced brakes; Required quantity: 2; Fitting Position: Front Axle	2	11.8171-0008.1 990049 Brake System: ATE
1.6 i	52	07/94→02/98	Required quantity: 2	2	11.8171-0008.1 990049 Brake System: ATE
			Required quantity: 2; Fitting Position: Front Axle	2	11.8171-0008.1 990049 Brake System: ATE
1.6 i	55	09/91→12/98	Construction year from: 10/91 → → Construction year to: 09/98; Required quantity: 2	2	11.8171-0008.1 990049 Brake System: ATE
			Construction year from: 10/91 → → Construction year to: 09/98; Required quantity: 2; Fitting Position: Front Axle	2	11.8171-0008.1 990049 Brake System: ATE
1.6 i 16V 1.8 i 16V	74 85 -	01/94→02/98 09/94→02/98	Required quantity: 2	2	11.8171-0008.1 990049 Brake System: ATE
	92				
2.0 i 16V	100	01/94→02/98			
1.7 D	44	03/91→12/94	Construction year from: 10/91 →; Braking System: for vehicles with rein- forced brakes; Required quantity: 2	2	11.8171-0008.1 990049 Brake System: ATE
			Construction year from: 10/91 →; Braking System: not for vehicles with reinforced brakes; Required quantity: 2; Fitting Position: Front Axle	2	11.8171-0008.1 990049 Brake System: ATE
1.8 i	66	09/91→02/98	Construction year from: 10/91 →; Required quantity: 2	2	11.8171-0008.1 990049 Brake System: ATE
			Construction year from: 10/91 →; Required quantity: 2; Fitting Position: Front Axle	2	11.8171-0008.1 990049 Brake System: ATE
2.0 i	85	09/91→02/98	Construction year from: 10/91 →; Required quantity: 2	2	11.8171-0008.1 990049 Brake System: ATE
VAUXHALL - ASTRA Mk III (F) Hatchback (T92) 09/91→02/98					
Guide Sleeve Kit, brake caliper					
1.4 i 1.4 S 1.7 D 1.8 i 2.0 i 2.0 i 16V	44 55 44 66 85 110	09/91→02/98 09/91→02/98 09/91→12/94 09/91→02/98 09/91→02/98 09/91→02/98	Construction year from: 10/91 →; Fitting Position: Front Axle		11.0101-5407.2 260011 Brake System: ATE
1.4 i	60	03/92→02/98	Transmission Type: Manual Transmis- sion; Braking System: not for vehicles with reinforced brakes; Fitting Position: Front Axle		11.0101-5407.2 260011 Brake System: ATE
			Transmission Type: Automatic Transmis- sion; Braking System: not for vehicles with reinforced brakes; Fitting Position: Front Axle		11.0101-5407.2 260011 Brake System: ATE
			Braking System: for vehicles with rein- forced brakes; Fitting Position: Front Axle		11.0101-5407.2 260011 Brake System: ATE
1.4 i 16V 1.6 i 1.6 i 16V 1.7 D 1.7 TD 1.8 i 16V 2.0 i 16V	66 74 74 42 50 - 60 85 - 92 100	02/96→02/98 03/92→02/98 01/94→02/98 12/91→02/98 12/91→02/98 09/94→02/98 09/94→02/98 01/94→02/98	Fitting Position: Front Axle		11.0101-5407.2 260011 Brake System: ATE
1.6 i	52	02/93→12/96	Fitting Position: Front Axle		11.0101-5407.2 260011 Brake System: ATE
			Transmission Type: Manual Transmis- sion; Fitting Position: Front Axle		11.0101-5407.2 260011 Brake System: ATE
			Transmission Type: Automatic Transmis- sion; Fitting Position: Front Axle		11.0101-5407.2 260011 Brake System: ATE
→					

	kW				
VAUXHALL - ASTRA Mk III (F) Hatchback (T92) 09/91→02/98					
Guide Sleeve Kit, brake caliper					
1.6 i	55	09/91→02/98	Construction year from: 10/91 →; Transmission Type: Automatic Transmis- sion; Fitting Position: Front Axle	2	11.0101-5407.2 260011 Brake System: ATE
			Construction year from: 10/91 →; Transmission Type: Manual Transmis- sion; Fitting Position: Front Axle	2	11.0101-5407.2 260011 Brake System: ATE
			Construction year from: 10/91 →; Fitting Position: Front Axle	2	11.0101-5407.2 260011 Brake System: ATE
Guide Bolt, brake caliper					
1.4 i 1.4 S	44 55	09/91→02/98 09/91→02/98	Construction year from: 10/91 →; Required quantity: 2; Fitting Position: Front Axle	2	11.8171-0008.1 990049 Brake System: ATE
1.4 i	60	03/92→02/98	Braking System: for vehicles with rein- forced brakes; Required quantity: 2	2	11.8171-0008.1 990049 Brake System: ATE
			Transmission Type: Manual Transmis- sion; Braking System: not for vehicles with reinforced brakes; Required quantity: 2; Fitting Position: Front Axle	2	11.8171-0008.1 990049 Brake System: ATE
			Transmission Type: Automatic Transmis- sion; Braking System: not for vehicles with reinforced brakes; Required quantity: 2; Fitting Position: Front Axle	2	11.8171-0008.1 990049 Brake System: ATE
1.4 i 16V 1.7 D 1.7 TD	66 42 50 - 60	02/96→02/98 12/91→02/98 12/91→02/98	Braking System: for vehicles with rein- forced brakes; Required quantity: 2	2	11.8171-0008.1 990049 Brake System: ATE
			Braking System: not for vehicles with reinforced brakes; Required quantity: 2; Fitting Position: Front Axle	2	11.8171-0008.1 990049 Brake System: ATE
1.6 i	52	02/93→12/96	Required quantity: 2	2	11.8171-0008.1 990049 Brake System: ATE
			Transmission Type: Automatic Transmis- sion; Required quantity: 2; Fitting Position: Front Axle	2	11.8171-0008.1 990049 Brake System: ATE
			Transmission Type: Manual Transmis- sion; Required quantity: 2; Fitting Position: Front Axle	2	11.8171-0008.1 990049 Brake System: ATE
1.6 i	55	09/91→02/98	Construction year from: 10/91 →; Required quantity: 2	2	11.8171-0008.1 990049 Brake System: ATE
			Construction year from: 10/91 →; Transmission Type: Manual Transmis- sion; Required quantity: 2; Fitting Position: Front Axle	2	11.8171-0008.1 990049 Brake System: ATE
			Construction year from: 10/91 →; Transmission Type: Automatic Transmis- sion; Required quantity: 2; Fitting Position: Front Axle	2	11.8171-0008.1 990049 Brake System: ATE
1.6 i 1.6 i 16V	74 74	03/92→02/98 01/94→02/98	Required quantity: 2	2	11.8171-0008.1 990049 Brake System: ATE
			Required quantity: 2; Fitting Position: Front Axle	2	11.8171-0008.1 990049 Brake System: ATE
1.7 D	44	09/91→12/94	Construction year from: 10/91 →; Braking System: for vehicles with rein- forced brakes; Required quantity: 2	2	11.8171-0008.1 990049 Brake System: ATE
			Construction year from: 10/91 →; Braking System: not for vehicles with reinforced brakes; Required quantity: 2; Fitting Position: Front Axle	2	11.8171-0008.1 990049 Brake System: ATE
1.8 i	66	09/91→02/98	Construction year from: 10/91 →; Required quantity: 2	2	11.8171-0008.1 990049 Brake System: ATE
			Construction year from: 10/91 →; Required quantity: 2; Fitting Position: Front Axle	2	11.8171-0008.1 990049 Brake System: ATE
1.8 i 16V 2.0 i 16V	85 - 100	09/94→02/98 01/94→02/98	Required quantity: 2	2	11.8171-0008.1 990049 Brake System: ATE
2.0 i 2.0 i 16V	85 110	09/91→02/98 09/91→02/98	Construction year from: 10/91 →; Required quantity: 2	2	11.8171-0008.1 990049 Brake System: ATE
VAUXHALL - ASTRA Mk III (F) Saloon (T92) 09/91→09/98					
Guide Sleeve Kit, brake caliper					
1.4 i 1.4 i 16V 1.6 i 1.6 i 16V 1.7 D →	44 66 74 74 42 - 44	04/92→09/98 02/96→09/98 05/92→12/94 08/94→09/98 03/92→09/98 44	Fitting Position: Front Axle	2	11.0101-5407.2 260011 Brake System: ATE



	kW				
VAUXHALL - ASTRA Mk III (F) Saloon (T92) 09/91→09/98					
Guide Sleeve Kit, brake caliper					
1.7 TD	50 - 12/91→09/98 60	Fitting Position: Front Axle		11.0101-5407.2 260011	Brake System: ATE
1.8 i	66 03/92→09/98				
1.8 i 16V	82 - 06/93→02/98 92				
2.0 i	85 03/92→09/98				
2.0 i 16V	100 02/95→09/98				
1.4 i	60 04/92→09/98	→ Construction year to: 07/95; Fitting Position: Front Axle		11.0101-5407.2 260011	Brake System: ATE
		Construction year from: 08/95 →; Fitting Position: Front Axle		11.0101-5407.2 260011	Brake System: ATE
1.6 i	52 - 03/92→09/98 55	Fitting Position: Front Axle		11.0101-5407.2 260011	Brake System: ATE
		Transmission Type: Manual Transmis- sion; Fitting Position: Front Axle		11.0101-5407.2 260011	Brake System: ATE
		Transmission Type: Automatic Transmis- sion; Fitting Position: Front Axle		11.0101-5407.2 260011	Brake System: ATE
Guide Bolt, brake caliper					
1.4 i	44 04/92→09/98	Required quantity: 2; Fitting Position: Front Axle	2	11.8171-0008.1 990049	Brake System: ATE
1.4 i	60 04/92→09/98	Construction year from: 08/95 →; Required quantity: 2; Fitting Position: Front Axle	2	11.8171-0008.1 990049	Brake System: ATE
		→ Construction year to: 07/95; Required quantity: 2; Fitting Position: Front Axle	2	11.8171-0008.1 990049	Brake System: ATE
1.4 i 16V	66 02/96→09/98	Braking System: for vehicles with rein- forced brakes; Required quantity: 2	2	11.8171-0008.1 990049	Brake System: ATE
1.7 D	42 - 03/92→09/98 44	Braking System: not for vehicles with reinforced brakes; Required quantity: 2; Fitting Position: Front Axle	2	11.8171-0008.1 990049	Brake System: ATE
1.7 TD	50 - 12/91→09/98 60	Braking System: not for vehicles with reinforced brakes; Required quantity: 2; Fitting Position: Front Axle	2	11.8171-0008.1 990049	Brake System: ATE
1.6 i	52 - 03/92→09/98 55	Required quantity: 2	2	11.8171-0008.1 990049	Brake System: ATE
		Transmission Type: Manual Transmis- sion; Required quantity: 2; Fitting Position: Front Axle	2	11.8171-0008.1 990049	Brake System: ATE
		Transmission Type: Automatic Transmis- sion; Required quantity: 2; Fitting Position: Front Axle	2	11.8171-0008.1 990049	Brake System: ATE
1.6 i	74 05/92→12/94	Required quantity: 2	2	11.8171-0008.1 990049	Brake System: ATE
1.8 i	66 03/92→09/98	Required quantity: 2; Fitting Position: Front Axle	2	11.8171-0008.1 990049	Brake System: ATE
1.6 i 16V	74 08/94→09/98	Required quantity: 2	2	11.8171-0008.1 990049	Brake System: ATE
1.8 i 16V	82 - 06/93→02/98 92				
2.0 i	85 03/92→09/98				
2.0 i 16V	100 02/95→09/98				
VAUXHALL - ASTRA Mk IV (G) Convertible (T98) 03/01→10/05					
Guide Sleeve Kit, brake caliper					
1.6 16V	74 - 03/01→10/05 76	Fitting Position: Front Axle		11.0101-5407.2 260011	Brake System: ATE
1.8 16V	92 03/01→10/05				
2.0	147 09/02→10/05				
2.0 Turbo	141 03/02→10/05				
2.2 16V	108 03/01→10/05				
Guide Bolt, brake caliper					
1.6 16V	74 - 03/01→10/05 76	Required quantity: 2; Fitting Position: Front Axle	2	11.8171-0008.1 990049	Brake System: ATE
1.8 16V	92 03/01→10/05				
2.0 Turbo	141 03/02→10/05				
2.2 16V	108 03/01→10/05				
2.0	147 09/02→10/05	Required quantity: 2	2	11.8171-0008.1 990049	Brake System: ATE
VAUXHALL - ASTRA Mk IV (G) Coupe (T98) 03/00→08/05					
Brake Caliper Axle Kit					
1.6 16V	76 03/00→08/05	Fitting Position: Rear Axle		24.0530-0001.5 241269	Brake System: Lucas / TRW Supplementary Article/Supple- mentary Info: with holder
Guide Sleeve Kit, brake caliper					
1.6 16V	76 03/00→08/05	Fitting Position: Front Axle		11.0101-5407.2 260011	Brake System: ATE
1.8 16V	85 - 03/00→08/05 92				
1.8 16V Dualfuel	87 - 07/02→08/05 92				
→					





	kW				
VAUXHALL - ASTRA Mk IV (G) Coupe (T98) 03/00→08/05					
Guide Sleeve Kit, brake caliper					
2.0 16V Turbo	140	09/00→08/05	Fitting Position: Front Axle	11.0101-5407.2 260011	Brake System: ATE
2.2 16V	108	03/00→08/05	Construction year from: 09/00 →; Fitting Position: Front Axle	11.0101-5407.2 260011	Brake System: ATE
Guide Bolt, brake caliper					
1.6 16V	76	03/00→08/05	Required quantity: 2;	2	11.8171-0008.1 990049 Brake System: ATE
1.8 16V	85 - 92	03/00→08/05	Fitting Position: Front Axle		
1.8 16V Dualfuel	87 - 92	07/02→08/05			
2.0 16V Turbo	140	09/00→08/05			
2.2 16V	108	03/00→08/05	Construction year from: 09/00 →; Required quantity: 2; Fitting Position: Front Axle	2	11.8171-0008.1 990049 Brake System: ATE
VAUXHALL - ASTRA Mk IV (G) Estate (T98) 02/98→05/05					
Brake Caliper Axle Kit					
1.4 16V	66	02/98→05/05	Fitting Position: Rear Axle	24.0530-0001.5 241269	Brake System: Lucas / TRW Supplementary Article/Supplementary Info: with holder
1.4 16V Dualfuel	66	09/99→06/03			
1.6	55 - 76	03/98→05/05			
1.6 16V	74	03/98→04/04			
1.6 Dualfuel	55 - 74	02/98→05/05			
1.7 CDTI 16V	59	04/03→05/05			
1.7 DTI 16V	55	02/00→05/05			
1.7 TD	50	02/98→08/00			
1.8 16V	85 - 92	02/98→05/05	- ABS; Fitting Position: Rear Axle		
1.8 16V Dualfuel	87 - 92	07/02→05/05			
2.0 DI	60	03/98→04/04			
Guide Sleeve Kit, brake caliper					
1.4 16V	66	02/98→05/05	Construction year from: 04/98 →;	11.0101-5407.2 260011	Brake System: ATE
1.6	55 - 62	03/98→04/04	Fitting Position: Front Axle		
1.6 16V	74	03/98→04/04			
1.6 Dualfuel	63	03/98→04/04			
1.7 TD	50	02/98→08/00			
1.8 16V	85	02/98→08/00			
2.0 DI	60	03/98→04/04			
1.4 16V Dualfuel	66	09/99→06/03	Fitting Position: Front Axle		
1.6	76	12/02→05/05			
1.6 Dualfuel	55 - 74	02/98→05/05			
1.7 CDTI 16V	59	04/03→05/05			
1.7 DTI 16V	55	02/00→05/05			
1.8 16V	92	09/00→05/05			
1.8 16V Dualfuel	87 - 92	07/02→05/05			
2.2 16V	108	03/01→05/05			
2.0 DTI 16V	74	03/98→04/04	Construction year from: 08/99 →; Fitting Position: Front Axle	11.0101-5407.2 260011	Brake System: ATE
Guide Bolt, brake caliper					
1.4 16V	66	02/98→05/05	Construction year from: 04/98 →;	2	11.8171-0008.1 990049 Brake System: ATE
1.6	55 - 62	03/98→04/04	Required quantity: 2;		
1.6 16V	74	03/98→04/04	Fitting Position: Front Axle		
1.6 Dualfuel	63	03/98→04/04			
1.7 TD	50	02/98→08/00			
1.8 16V	85	02/98→08/00			
2.0 DI	60	03/98→04/04			
1.4 16V Dualfuel	66	09/99→06/03	Required quantity: 2;		
1.6	76	12/02→05/05	Fitting Position: Front Axle		
1.6 Dualfuel	55 - 74	02/98→05/05			
1.7 CDTI 16V	59	04/03→05/05			
1.7 DTI 16V	55	02/00→05/05			
1.8 16V	92	09/00→05/05			
1.8 16V Dualfuel	87 - 92	07/02→05/05			
2.2 16V	108	03/01→05/05			
2.0 DTI 16V	74	03/98→04/04	Construction year from: 08/99 →; Required quantity: 2; Fitting Position: Front Axle	2	11.8171-0008.1 990049 Brake System: ATE

	kW							
VAUXHALL - ASTRA Mk IV (G) Hatchback (T98) 02/98→05/05								
Brake Caliper Axle Kit								
1.4 16V	66	02/98→05/05	Fitting Position: Rear Axle	24.0530-0001.5 241269	Brake System: Lucas / TRW Supplementary Article/Supplementary Info: with holder			
1.4 16V Dualfuel	66	09/99→06/03						
1.6	55	02/98→05/05						
	62							
1.6 16V	74	02/98→05/05						
1.6 Dualfuel	55	02/98→05/05						
	74							
1.7 CDTI 16V	59	04/03→05/05						
1.7 DTI 16V	55	02/00→05/05						
1.7 TD	50	02/98→08/00						
1.8 16V	85	02/98→05/05	- ABS; Fitting Position: Rear Axle	24.0530-0001.5 241269	Brake System: Lucas / TRW Supplementary Article/Supplementary Info: with holder			
	92							
1.8 16V Dualfuel	87	07/02→05/05						
	92							
2.0 DI	60	02/98→05/05						
Guide Sleeve Kit, brake caliper								
1.4 16V	66	02/98→05/05	Construction year from: 04/98 →; Fitting Position: Front Axle	11.0101-5407.2 260011	Brake System: ATE			
1.6	55	02/98→09/00						
1.6 16V	74	02/98→05/05						
1.6 Dualfuel	55	02/98→12/00						
1.7 TD	50	02/98→08/00						
1.8 16V	85	02/98→09/00						
2.0 16V	100	02/98→05/05						
2.0 DI	60	02/98→05/05						
1.4 16V Dualfuel	66	09/99→06/03				Fitting Position: Front Axle	11.0101-5407.2 260011	Brake System: ATE
1.6	62	09/00→05/05						
	76							
1.6 Dualfuel	62	09/99→05/05						
	74							
1.7 CDTI 16V	59	04/03→05/05						
1.7 DTI 16V	55	02/00→05/05						
1.8 16V	92	09/00→05/05						
1.8 16V Dualfuel	87	07/02→05/05						
	92							
2.0	147	08/02→05/05						
2.0 DTI 16V	74	08/99→05/05						
2.0 SRI Turbo	141	11/01→05/05						
2.2 16V	108	03/01→05/05						
Guide Bolt, brake caliper								
1.4 16V	66	02/98→05/05	Construction year from: 04/98 →; Required quantity: 2; Fitting Position: Front Axle	2 11.8171-0008.1 990049	Brake System: ATE			
1.6	55	02/98→09/00						
1.6 16V	74	02/98→05/05						
1.6 Dualfuel	55	02/98→12/00						
1.7 TD	50	02/98→08/00						
1.8 16V	85	02/98→09/00						
2.0 16V	100	02/98→05/05						
2.0 DI	60	02/98→05/05						
1.4 16V Dualfuel	66	09/99→06/03				Required quantity: 2; Fitting Position: Front Axle	2 11.8171-0008.1 990049	Brake System: ATE
1.6	62	09/00→05/05						
	76							
1.6 Dualfuel	62	09/99→05/05						
	74							
1.7 CDTI 16V	59	04/03→05/05						
1.7 DTI 16V	55	02/00→05/05						
1.8 16V	92	09/00→05/05						
1.8 16V Dualfuel	87	07/02→05/05						
	92							
2.0 DTI 16V	74	08/99→05/05						
2.0 SRI Turbo	141	11/01→05/05						
2.2 16V	108	03/01→05/05						
2.0	147	08/02→05/05	Required quantity: 2	2 11.8171-0008.1 990049	Brake System: ATE			
VAUXHALL - ASTRA Mk IV (G) Saloon (T98) 02/98→05/05								
Brake Caliper Axle Kit								
1.4 16V	66	09/98→05/05	Fitting Position: Rear Axle	24.0530-0001.5 241269	Brake System: Lucas / TRW Supplementary Article/Supplementary Info: with holder			
1.6	55	09/98→05/05						
	62							
1.6 16V	74	09/98→05/05						
1.6 Dualfuel	55	02/98→05/05						
	74							
1.7 CDTI 16V	59	04/03→05/05						
1.7 DTI 16V	55	02/00→05/05						
1.7 TD	50	09/98→08/00						
1.8 16V	85	02/98→07/04				- ABS; Fitting Position: Rear Axle	24.0530-0001.5 241269	Brake System: Lucas / TRW Supplementary Article/Supplementary Info: with holder
	92							
1.8 16V Dualfuel	87	02/98→07/04						
	92							
2.0 DI	60	02/98→07/04						
→								

	kW				
VAUXHALL - ASTRA Mk IV (G) Saloon (T98) 02/98→05/05					
Guide Sleeve Kit, brake caliper					
1.4 16V	66	09/98→05/05	Fitting Position: Front Axle	11.0101-5407.2 260011	Brake System: ATE
1.6	55 - 62	09/98→05/05			
1.6 16V	74	09/98→05/05			
1.6 Dualfuel	55 - 74	02/98→05/05			
1.7 CDTI 16V	59	04/03→05/05			
1.7 DTI 16V	55	02/00→05/05			
1.7 TD	50	09/98→08/00			
1.8 16V Dualfuel	92	07/02→12/03			
2.0 16V	100	09/98→05/05			
1.8 16V	85 - 92	02/98→07/04	Construction year from: 04/98 →; Fitting Position: Front Axle	11.0101-5407.2 260011	Brake System: ATE
1.8 16V Dualfuel	87	02/98→07/04			
2.0 DI	60	02/98→07/04			
2.0 DTI 16V	74	02/98→07/04	Construction year from: 08/99 →; Fitting Position: Front Axle	11.0101-5407.2 260011	Brake System: ATE
Guide Bolt, brake caliper					
1.4 16V	66	09/98→05/05	Required quantity: 2;	2	11.8171-0008.1 990049 Brake System: ATE
1.6	55 - 62	09/98→05/05	Fitting Position: Front Axle		
1.6 16V	74	09/98→05/05			
1.6 Dualfuel	55 - 74	02/98→05/05			
1.7 CDTI 16V	59	04/03→05/05			
1.7 DTI 16V	55	02/00→05/05			
1.7 TD	50	09/98→08/00			
1.8 16V Dualfuel	92	07/02→12/03			
2.0 16V	100	09/98→05/05			
1.8 16V	85 - 92	02/98→07/04	Construction year from: 04/98 →; Required quantity: 2;	2	11.8171-0008.1 990049 Brake System: ATE
1.8 16V Dualfuel	87	02/98→07/04	Fitting Position: Front Axle		
2.0 DI	60	02/98→07/04			
2.0 DTI 16V	74	02/98→07/04	Construction year from: 08/99 →; Required quantity: 2;	2	11.8171-0008.1 990049 Brake System: ATE
			Fitting Position: Front Axle		
VAUXHALL - ASTRA Mk V (H) (A04) 01/04→03/11					
Spring, brake caliper					
2.0 Turbo	177	01/04→05/09	Construction year from: 03/05 →; Required quantity: 2	2	11.8116-0356.1 390586 Brake System: ATE
Guide Sleeve Kit, brake caliper					
1.3 CDTI	66	01/04→05/09	Construction year from: 08/05 →; Fitting Position: Front Axle	11.0101-5407.2 260011	Brake System: ATE
1.4	66	01/04→05/09	Fitting Position: Front Axle	11.0101-5407.2 260011	Brake System: ATE
1.6	77	01/04→05/09			
1.7 CDTI	59 - 74	01/04→05/09			
1.8	92	01/04→05/09			
2.0 Turbo	125	01/04→05/09			
1.6	85	01/04→05/09	Construction year from: 01/07 →;	11.0101-5407.2 260011	Brake System: ATE
1.6 Turbo	132	09/06→09/09	Fitting Position: Front Axle		
1.7 CDTi	81	01/04→03/11	Construction year from: 04/07 →; Fitting Position: Front Axle	11.0101-5407.2 260011	Brake System: ATE
1.8	103	01/04→05/09	Construction year from: 01/06 →; Fitting Position: Front Axle	11.0101-5407.2 260011	Brake System: ATE
1.9 CDTI	88 - 110	01/04→05/09	Construction year from: 09/04 →; Fitting Position: Front Axle	11.0101-5407.2 260011	Brake System: ATE
1.9 CDTI 16V	88	01/04→05/09			
2.0 Turbo	147	01/04→05/09			
2.0 Turbo	177	01/04→05/09	Construction year from: 03/05 →; Fitting Position: Front Axle	11.0101-5407.2 260011	Brake System: ATE
Guide Bolt, brake caliper					
1.3 CDTI	66	01/04→05/09	Construction year from: 08/05 →; Required quantity: 2	2	11.8171-0008.1 990049 Brake System: ATE
1.4	66	01/04→05/09	Required quantity: 2	2	11.8171-0008.1 990049 Brake System: ATE
1.6	77	01/04→05/09			
1.7 CDTI	59 - 74	01/04→05/09			
1.8	92	01/04→05/09			
2.0 Turbo	125	01/04→05/09			
1.6	85	01/04→05/09	Construction year from: 01/07 →; Required quantity: 2	2	11.8171-0008.1 990049 Brake System: ATE
1.6 Turbo	132	09/06→09/09			
1.7 CDTi	81	01/04→03/11	Construction year from: 04/07 →; Required quantity: 2	2	11.8171-0008.1 990049 Brake System: ATE
→					

	kW				
VAUXHALL - ASTRA Mk V (H) (A04) 01/04→03/11					
Guide Bolt, brake caliper					
1.8	103	01/04→05/09	Construction year from: 01/06 →; Required quantity: 2	2	11.8171-0008.1 990049 Brake System: ATE
1.9 CDTi	88 - 110	01/04→05/09	Construction year from: 09/04 →; Required quantity: 2	2	11.8171-0008.1 990049 Brake System: ATE
1.9 CDTi 16V	88	01/04→05/09			
2.0 Turbo	147	01/04→05/09			
2.0 Turbo	177	01/04→05/09	Construction year from: 03/05 →; Required quantity: 2	2	11.8171-0008.1 990049 Brake System: ATE
VAUXHALL - ASTRA Mk V (H) Estate (A04) 08/04→10/12					
Guide Sleeve Kit, brake caliper					
1.3 CDTi	66	08/04→03/09	Construction year from: 08/05 →; Fitting Position: Front Axle		11.0101-5407.2 260011 Brake System: ATE
1.4	66	08/04→03/09	Fitting Position: Front Axle		11.0101-5407.2 260011 Brake System: ATE
1.6	77	08/04→03/09			
1.7 CDTi	74	08/04→03/09			
1.7 CDTi	59	08/04→05/09			
1.8	92 - 103	10/04→10/10			
1.9 CDTi	88	08/04→03/09			
1.9 CDTi 16V	88	08/04→03/09			
2.0 Turbo	125	08/04→10/10			
1.6	85 - 132	08/04→03/11	Construction year from: 01/07 →; Fitting Position: Front Axle		11.0101-5407.2 260011 Brake System: ATE
1.7 CDTi	81	08/04→10/12	Construction year from: 04/07 → → Construction year to: 11/10; Fitting Position: Front Axle		11.0101-5407.2 260011 Brake System: ATE
1.9 CDTi	110	08/04→03/09	Construction year from: 09/04 →;		11.0101-5407.2 260011 Brake System: ATE
2.0 Turbo	147	08/04→10/10	Fitting Position: Front Axle		
Guide Bolt, brake caliper					
1.3 CDTi	66	08/04→03/09	Construction year from: 08/05 →; Required quantity: 2; Fitting Position: Front Axle	2	11.8171-0008.1 990049 Brake System: ATE
1.4	66	08/04→03/09	Required quantity: 2;	2	11.8171-0008.1 990049 Brake System: ATE
1.6	77	08/04→03/09	Fitting Position: Front Axle		
1.7 CDTi	74	08/04→03/09			
1.7 CDTi	59	08/04→05/09			
1.8	92 - 103	10/04→10/10			
1.9 CDTi	88	08/04→03/09			
1.9 CDTi 16V	88	08/04→03/09			
2.0 Turbo	125	08/04→10/10			
1.6	85 - 132	08/04→03/11	Construction year from: 01/07 →; Required quantity: 2; Fitting Position: Front Axle	2	11.8171-0008.1 990049 Brake System: ATE
1.7 CDTi	81	08/04→10/12	Construction year from: 04/07 → → Construction year to: 11/10; Required quantity: 2; Fitting Position: Front Axle	2	11.8171-0008.1 990049 Brake System: ATE
1.9 CDTi	110	08/04→03/09	Construction year from: 09/04 →;	2	11.8171-0008.1 990049 Brake System: ATE
2.0 Turbo	147	08/04→10/10	Required quantity: 2; Fitting Position: Front Axle		
VAUXHALL - ASTRA Mk V (H) Sport Hatch (A04) 02/05→11/10					
Spring, brake caliper					
2.0 VXR	176	02/09→11/10	Required quantity: 2	2	11.8116-0356.1 390586 Brake System: ATE
Guide Sleeve Kit, brake caliper					
1.3 CDTi	66	04/05→11/10	Construction year from: 08/05 →; Fitting Position: Front Axle		11.0101-5407.2 260011 Brake System: ATE
1.4 i 16V	66	03/05→11/10	Fitting Position: Front Axle		11.0101-5407.2 260011 Brake System: ATE
1.6	77	02/05→11/10			
1.7 CDTi	74	02/05→11/10			
1.8	92	02/05→11/10			
1.8 i 16V	103	03/07→11/10			
1.9 CDTi	88 - 110	02/05→11/10			
2.0 Turbo	125	02/05→11/10			
2.0 VXR	176	02/09→11/10			
1.6	132	10/06→11/10	Construction year from: 01/07 →; Fitting Position: Front Axle		11.0101-5407.2 260011 Brake System: ATE
1.6 i 16V	85	12/06→11/10			
1.7 CDTi	81	02/07→11/09	Construction year from: 04/07 →; Fitting Position: Front Axle		11.0101-5407.2 260011 Brake System: ATE
1.9 CDTi	74	08/05→11/10	Construction year from: 09/05 →; Fitting Position: Front Axle		11.0101-5407.2 260011 Brake System: ATE
→					

	kW							
VAUXHALL - ASTRA Mk V (H) Sport Hatch (A04) 02/05→11/10								
Guide Bolt, brake caliper								
1.3 CDTi	66	04/05→11/10	Construction year from: 08/05 →; Required quantity: 2	2	11.8171-0008.1 990049 Brake System: ATE			
1.4 i 16V	66	03/05→11/10	Required quantity: 2	2	11.8171-0008.1 990049 Brake System: ATE			
1.6	77	02/05→11/10						
1.7 CDTi	74	02/05→11/10						
1.8	92	02/05→11/10						
1.8 i 16V	103	03/07→11/10						
1.9 CDTi	88 -	02/05→11/10						
2.0 Turbo	125	02/05→11/10						
2.0 VXR	176	02/09→11/10						
1.6	132	10/06→11/10	Construction year from: 01/07 →; Required quantity: 2	2	11.8171-0008.1 990049 Brake System: ATE			
1.6 i 16V	85	12/06→11/10						
1.7 CDTi	81	02/07→11/09	Construction year from: 04/07 →; Required quantity: 2	2	11.8171-0008.1 990049 Brake System: ATE			
1.9 CDTi	74	08/05→11/10	Construction year from: 09/05 →; Required quantity: 2	2	11.8171-0008.1 990049 Brake System: ATE			
VAUXHALL - ASTRA Mk V (H) TwinTop (A04) 09/05→08/11								
Guide Sleeve Kit, brake caliper								
1.6	77	09/05→11/10	Construction year from: 03/06 →; Fitting Position: Front Axle		11.0101-5407.2 260011 Brake System: ATE			
1.9 CDTi	110	01/06→11/10						
2.0	125	02/06→11/10						
2.0 Turbo	147	01/06→11/10						
1.6 i 16V	85	10/06→08/11	Construction year from: 12/06 →; Fitting Position: Front Axle		11.0101-5407.2 260011 Brake System: ATE			
1.8	103	05/08→11/10	Fitting Position: Front Axle		11.0101-5407.2 260011 Brake System: ATE			
Guide Bolt, brake caliper								
1.6	77	09/05→11/10	Construction year from: 03/06 →; Required quantity: 2	2	11.8171-0008.1 990049 Brake System: ATE			
1.9 CDTi	110	01/06→11/10						
2.0	125	02/06→11/10						
2.0 Turbo	147	01/06→11/10						
1.6 i 16V	85	10/06→08/11	Construction year from: 12/06 →; Required quantity: 2	2	11.8171-0008.1 990049 Brake System: ATE			
1.8	103	05/08→11/10	Required quantity: 2	2	11.8171-0008.1 990049 Brake System: ATE			
VAUXHALL - ASTRA Mk VI (J) (P10) 12/09→10/15								
 Brake Hose								
1.3 CDTi	70	12/09→10/15	Number of Doors: 3; Fitting Position: Front Axle Left		24.5176-0673.3 331651 Length [mm]: 685			
1.4	64 -	12/09→10/15						
	74							
1.4 Turbo	103	12/09→10/15						
1.6	85	12/09→10/15						
1.6 Turbo	132	12/09→10/15						
1.7 CDTi	81 -	12/09→10/15						
	96							
1.7 CDTi	74	10/10→10/15						
2.0 BiTurbo CDTi	143	12/12→10/15						
2.0 CDTi	118 -	12/09→10/15						
	121							
1.4 Turbo	88	08/10→10/15				Construction year from: 11/10 →; Number of Doors: 3; Fitting Position: Front Axle Left		24.5176-0673.3 331651 Length [mm]: 685
1.6 CDTi	81	11/13→10/15				Construction year from: 02/14 →; Number of Doors: 3; Fitting Position: Front Axle Left		24.5176-0673.3 331651 Length [mm]: 685
1.6 CDTi	100	11/13→10/15	Construction year from: 01/14 →; Number of Doors: 3; Fitting Position: Front Axle Left		24.5176-0673.3 331651 Length [mm]: 685			
VAUXHALL - ASTRA Mk VI (J) Estate (P10) 10/10→10/15								
 Brake Caliper								
1.3 CDTi	70	10/10→10/15	Construction year from: 11/10 →; Vehicle Equipment: for vehicles with electric parking brake; Fitting Position: Rear Axle Left		24.3402-7003.5 241457 Brake System: ATE Supplementary Article/Supple- mentary Info: without holder Brake Caliper Type: Fist-type Caliper			
1.4	64 -	10/10→10/15						
	74							
1.4 Turbo	103	10/10→10/15	Construction year from: 11/10 →; Vehicle Equipment: for vehicles with electric parking brake; Fitting Position: Rear Axle Right		24.3402-7004.5 241458 Brake System: ATE Supplementary Article/Supple- mentary Info: without holder Brake Caliper Type: Fist-type Caliper			
1.6	85	10/10→10/15						
1.6 Turbo	132	10/10→10/15						
1.7 CDTi	81 -	10/10→10/15						
	92							
2.0 CDTi	118	10/10→06/11						
→								

	kW				
VAUXHALL - ASTRA Mk VI (J) Estate (P10) 10/10→10/15					
 Brake Caliper					
1.6 CDTi	81	01/14→10/15	Construction year from: 02/14 →; Vehicle Equipment: for vehicles with electric parking brake; Fitting Position: Rear Axle Left	24.3402-7003.5 241457	Brake System: ATE Supplementary Article/Supplementary Info: without holder Brake Caliper Type: Fist-type Caliper
			Construction year from: 02/14 →; Vehicle Equipment: for vehicles with electric parking brake; Fitting Position: Rear Axle Right	24.3402-7004.5 241458	Brake System: ATE Supplementary Article/Supplementary Info: without holder Brake Caliper Type: Fist-type Caliper
1.6 CDTi 1.7 CDTi 2.0 BiTurbo CDTI 2.0 CDTi	100 96 143 121	01/14→10/15 06/11→10/15 12/12→10/15 08/11→10/15	Vehicle Equipment: for vehicles with electric parking brake; Fitting Position: Rear Axle Left	24.3402-7003.5 241457	Brake System: ATE Supplementary Article/Supplementary Info: without holder Brake Caliper Type: Fist-type Caliper
			Vehicle Equipment: for vehicles with electric parking brake; Fitting Position: Rear Axle Right	24.3402-7004.5 241458	Brake System: ATE Supplementary Article/Supplementary Info: without holder Brake Caliper Type: Fist-type Caliper
VAUXHALL - ASTRA Mk VI (J) GTC (P10) 10/11→10/15					
 Brake Disc					
1.6 SIDI	125	09/13→10/15	Fitting Position: Front Axle	24.0326-0165.1 526165	Outer diameter [mm]: 276 Brake Disc Thickness [mm] 26 Minimum thickness [mm] 23 Brake Disc Type: Vented Supplementary Article/Info 2: with bolts/screws
				24.0326-0166.1 526166	Outer diameter [mm]: 300 Brake Disc Thickness [mm] 26 Minimum thickness [mm] 23 Brake Disc Type: Vented Supplementary Article/Info 2: with bolts/screws
			Fitting Position: Rear Axle	24.0312-0188.1 512188	Outer diameter [mm]: 268 Brake Disc Thickness [mm] 12 Minimum thickness [mm] 10 Brake Disc Type: Solid Supplementary Article/Info 2: with bolts/screws
				24.0312-0189.1 512189	Outer diameter [mm]: 292 Brake Disc Thickness [mm] 12 Minimum thickness [mm] 10 Brake Disc Type: Solid Supplementary Article/Info 2: with bolts/screws
 Brake Hose					
1.4 1.6 1.6 CDTi 1.6 SIDI 1.7 CDTi 2.0 BiTurbo CDTI 2.0 CDTi	74 103 132 81 - 100 125 - 147 81 - 96 143 121	10/11→10/15 10/11→10/15 07/14→10/15 09/13→10/15 10/11→10/15 12/12→10/15 10/11→10/15	Number of Doors: 3; Fitting Position: Front Axle Left	24.5176-0673.3 331651	Length [mm]: 685
VAUXHALL - ASTRA Mk VI (J) Saloon (P10) 06/12→10/15					
 Brake Hose					
1.3 CDTI 1.4 1.4 Turbo 1.6 1.6 Turbo 1.7 CDTI	70 74 103 85 132 81 -	06/12→10/15 06/12→10/15 06/12→10/15 06/12→10/15 06/12→10/15 06/12→10/15	Number of Doors: 3; Fitting Position: Front Axle Left	24.5176-0673.3 331651	Length [mm]: 685
VAUXHALL - ASTRA Mk VII (K) (B16) 07/15→					
Guide Sleeve Kit, brake caliper					
1.0 1.2 Turbo 1.4 →	77 81 - 107 74	07/15→ 08/19→ 07/15→	Fitting Position: Front Axle	11.0101-5407.2 260011	Brake System: ATE

	kW				
VAUXHALL - ASTRA Mk VII (K) (B16) 07/15→					
Guide Sleeve Kit, brake caliper					
1.4 Turbo	92 - 07/15→ 110	Fitting Position: Front Axle		11.0101-5407.2 260011	Brake System: ATE
1.5 CRDI	77 - 08/19→ 90				
1.6 BiTurbo	110 08/18→				
1.6 CDTi	70 - 07/15→ 118				
1.6 Turbo	147 11/15→				
Guide Bolt, brake caliper					
1.0	77 07/15→	Fitting Position: Front Axle		11.8171-0008.1 990049	Brake System: ATE
1.4	74 07/15→				
1.4 Turbo	92 - 07/15→ 110				
1.6 BiTurbo	110 08/18→				
1.6 CDTi	70 - 07/15→ 118				
1.6 Turbo	147 11/15→				
VAUXHALL - ASTRA Mk VII (K) Estate (B16) 07/15→					
Guide Sleeve Kit, brake caliper					
1.0	77 11/15→	Fitting Position: Front Axle		11.0101-5407.2 260011	Brake System: ATE
1.2 Turbo	81 - 08/19→ 107				
1.4	74 11/15→				
1.4 Turbo	92 - 11/15→ 110				
1.5 CRDI	77 - 08/19→ 90				
1.6 BiTurbo	110 08/18→				
1.6 CDTi	70 - 07/15→ 118				
1.6 Turbo	147 11/15→				
Guide Bolt, brake caliper					
1.0	77 11/15→	Fitting Position: Front Axle		11.8171-0008.1 990049	Brake System: ATE
1.4	74 11/15→				
1.4 Turbo	92 - 11/15→ 110				
1.6 BiTurbo	110 08/18→				
1.6 CDTi	70 - 07/15→ 118				
1.6 Turbo	147 11/15→				
VAUXHALL - ASTRAVAN Mk III (F) Estate Van (T92) 01/91→08/98					
Guide Sleeve Kit, brake caliper					
1.4 i	44 09/91→08/95	Construction year from: 10/91 →; Fitting Position: Front Axle		11.0101-5407.2 260011	Brake System: ATE
1.6 i	52 - 10/91→08/98 55	Fitting Position: Front Axle		11.0101-5407.2 260011	Brake System: ATE
1.7 D	44 10/91→12/94				
1.7 TD	50 - 09/94→08/98 60				
Guide Bolt, brake caliper					
1.4 i	44 09/91→08/95	Construction year from: 10/91 →; Required quantity: 2; Fitting Position: Front Axle	2	11.8171-0008.1 990049	Brake System: ATE
1.6 i	52 - 10/91→08/98 55	Required quantity: 2	2	11.8171-0008.1 990049	Brake System: ATE
		Required quantity: 2; Fitting Position: Front Axle	2	11.8171-0008.1 990049	Brake System: ATE
1.7 D	44 10/91→12/94	Braking System: for vehicles with rein- forced brakes; Required quantity: 2	2	11.8171-0008.1 990049	Brake System: ATE
1.7 TD	50 - 09/94→08/98 60	Braking System: not for vehicles with reinforced brakes; Required quantity: 2; Fitting Position: Front Axle	2	11.8171-0008.1 990049	Brake System: ATE
VAUXHALL - ASTRAVAN Mk IV (G) Estate Van (T98) 01/93→08/06					
Brake Caliper Axle Kit					
1.4 16V	66 09/00→05/05	Fitting Position: Rear Axle		24.0530-0001.5 241269	Brake System: Lucas / TRW Supplementary Article/Supple- mentary Info: with holder
1.6 Dualfuel	55 - 02/98→08/05 74				
1.6 Dualfuel 16V	77 10/04→12/05				
1.6 i	55 - 08/98→08/06 62				
1.7 CDTi	59 07/03→08/06				
1.7 DTI 16V	55 04/01→08/06				
1.7 TD	50 08/98→08/06				
→					

	kW				
VAUXHALL - CARLTON Mk III Estate (V87) 09/86→03/94					
Guide Sleeve Kit, brake caliper					
1.8	65 09/87→03/94	Vehicle Identification Number from:		11.0101-5407.2 260011	Brake System: ATE
1.8 i	85 09/86→03/94	L1019855 →;			
1.8 S	66 09/86→03/94	→ Construction year to: 08/93;			
2.3 D	54 09/86→03/94	Fitting Position: Front Axle			
2.3 TD Interc.	74 09/88→03/94				
2.0	85 09/86→03/94	Vehicle Identification Number from:		11.0101-5407.2 260011	Brake System: ATE
2.0 i	90 09/86→03/94	K1000099 →;			
		→ Construction year to: 08/93;			
		Fitting Position: Front Axle			
		→ Vehicle Identification Number to:		11.0101-5407.2 260011	Brake System: ATE
		K1000098; Fitting Position: Front Axle			
2.2 TD	66 09/86→08/88	Vehicle Identification Number from:		11.0101-5407.2 260011	Brake System: ATE
		L1019855 →; Fitting Position: Front Axle			
3.0	130 03/87→03/94	→ Vehicle Identification Number to:		11.0101-5407.2 260011	Brake System: ATE
		M1000000; Fitting Position: Front Axle			
Guide Bolt, brake caliper					
1.8	65 09/87→03/94	Vehicle Identification Number from:	2	11.8171-0008.1 990049	Brake System: ATE
1.8 i	85 09/86→03/94	L1019855 →;			
1.8 S	66 09/86→03/94	→ Construction year to: 08/93;			
2.3 D	54 09/86→03/94	Required quantity: 2;			
2.3 TD Interc.	74 09/88→03/94	Fitting Position: Front Axle			
2.0	85 09/86→03/94	→ Vehicle Identification Number to:	2	11.8171-0008.1 990049	Brake System: ATE
2.0 i	90 09/86→03/94	K1000098; Required quantity: 2			
		Vehicle Identification Number from:	2	11.8171-0008.1 990049	Brake System: ATE
		K1000099 →;			
		→ Construction year to: 08/93;			
		Required quantity: 2;			
		Fitting Position: Front Axle			
2.2 TD	66 09/86→08/88	Vehicle Identification Number from:	2	11.8171-0008.1 990049	Brake System: ATE
		L1019855 →; Required quantity: 2;			
		Fitting Position: Front Axle			
3.0	130 03/87→03/94	→ Vehicle Identification Number to:	2	11.8171-0008.1 990049	Brake System: ATE
		M1000000; Required quantity: 2;			
		Fitting Position: Front Axle			
VAUXHALL - CARLTON Mk III Saloon (V87) 09/86→03/94					
Guide Sleeve Kit, brake caliper					
1.8	65 09/87→03/94	Vehicle Identification Number from:		11.0101-5407.2 260011	Brake System: ATE
1.8 i	85 09/86→03/94	L1019855 →;			
1.8 S	66 09/86→03/94	→ Construction year to: 08/93;			
2.3 D	54 09/86→03/94	Fitting Position: Front Axle			
2.3 TD Interc.	74 08/88→03/94				
2.0	74 - 09/86→03/94	Vehicle Identification Number from:		11.0101-5407.2 260011	Brake System: ATE
2.0 i	85	K1000099 →;			
	90 09/86→03/94	→ Construction year to: 08/93;			
		Fitting Position: Front Axle			
		→ Vehicle Identification Number to:		11.0101-5407.2 260011	Brake System: ATE
		K1000098; Fitting Position: Front Axle			
2.2 TD	66 10/86→08/88	Vehicle Identification Number from:		11.0101-5407.2 260011	Brake System: ATE
		L1019855 →; Fitting Position: Front Axle			
3.0 3000	130 03/87→09/90	→ Vehicle Identification Number to:		11.0101-5407.2 260011	Brake System: ATE
3000 Cat	130 03/88→03/94	M1000000; Fitting Position: Front Axle			
Guide Bolt, brake caliper					
1.8	65 09/87→03/94	Vehicle Identification Number from:	2	11.8171-0008.1 990049	Brake System: ATE
1.8 i	85 09/86→03/94	L1019855 →;			
1.8 S	66 09/86→03/94	→ Construction year to: 08/93;			
2.3 D	54 09/86→03/94	Required quantity: 2;			
2.3 TD Interc.	74 08/88→03/94	Fitting Position: Front Axle			
2.0	74 - 09/86→03/94	→ Vehicle Identification Number to:	2	11.8171-0008.1 990049	Brake System: ATE
2.0 i	85	K1000098; Required quantity: 2			
	90 09/86→03/94	Vehicle Identification Number from:	2	11.8171-0008.1 990049	Brake System: ATE
		K1000099 →;			
		→ Construction year to: 08/93;			
		Required quantity: 2;			
		Fitting Position: Front Axle			
2.2 TD	66 10/86→08/88	Vehicle Identification Number from:	2	11.8171-0008.1 990049	Brake System: ATE
		L1019855 →; Required quantity: 2;			
		Fitting Position: Front Axle			
3.0 3000	130 03/87→09/90	→ Vehicle Identification Number to:	2	11.8171-0008.1 990049	Brake System: ATE
3000 Cat	130 03/88→03/94	M1000000; Required quantity: 2;			
		Fitting Position: Front Axle			

	kW				
VAUXHALL - CAVALIER Mk III Hatchback (J89) 09/88→11/95					
Guide Sleeve Kit, brake caliper					
1.4 S 1.6 i	55 09/88→11/95 52 - 09/88→11/95 55	Vehicle Identification Number from: N1038530 →; → Construction year to: 08/95; Fitting Position: Front Axle		11.0101-5407.2 260011	Brake System: ATE
		Vehicle Identification Number from: N5000001 →; → Construction year to: 08/95; Fitting Position: Front Axle		11.0101-5407.2 260011	Brake System: ATE
1.6	60 09/88→05/93	Vehicle Identification Number from: N5000001 →; Fitting Position: Front Axle		11.0101-5407.2 260011	Brake System: ATE
		Vehicle Identification Number from: N1038530 →; Fitting Position: Front Axle		11.0101-5407.2 260011	Brake System: ATE
1.7 D 1.8	42 09/88→09/92 66 09/88→10/90	Vehicle Identification Number from: S1000001 →; Fitting Position: Front Axle		11.0101-5407.2 260011	Brake System: ATE
		Vehicle Identification Number from: S5000001 →; Fitting Position: Front Axle		11.0101-5407.2 260011	Brake System: ATE
		Vehicle Identification Number from: N1038530 → → Vehicle Identification Number to: R1999999; Fitting Position: Front Axle		11.0101-5407.2 260011	Brake System: ATE
		Vehicle Identification Number from: N5000001 → → Vehicle Identification Number to: R5999999; Fitting Position: Front Axle		11.0101-5407.2 260011	Brake System: ATE
1.7 D 1.8 i Cat	44 07/92→11/95 66 03/90→11/95	Vehicle Identification Number from: S1000001 →; → Construction year to: 08/95; Fitting Position: Front Axle		11.0101-5407.2 260011	Brake System: ATE
		Vehicle Identification Number from: S5000001 →; → Construction year to: 08/95; Fitting Position: Front Axle		11.0101-5407.2 260011	Brake System: ATE
		Vehicle Identification Number from: N1038530 → → Vehicle Identification Number to: R1999999; Fitting Position: Front Axle		11.0101-5407.2 260011	Brake System: ATE
		Vehicle Identification Number from: N5000001 → → Vehicle Identification Number to: R5999999; Fitting Position: Front Axle		11.0101-5407.2 260011	Brake System: ATE
1.7 TD	60 09/88→11/95	Vehicle Identification Number from: S1000001 →; → Construction year to: 08/95; Fitting Position: Front Axle		11.0101-5407.2 260011	Brake System: ATE
		Vehicle Identification Number from: N1038530 → → Vehicle Identification Number to: R1999999; Fitting Position: Front Axle		11.0101-5407.2 260011	Brake System: ATE
		Vehicle Identification Number from: N5000001 → → Vehicle Identification Number to: R5999999; Fitting Position: Front Axle		11.0101-5407.2 260011	Brake System: ATE
2.0 i 2.0 i 16V 2.0 i 16V 4x4 2.0 i 4x4 2.0 SRi	85 09/88→10/92 100 09/92→08/95 110 01/92→11/93 85 09/91→10/92 95 09/88→09/92	Fitting Position: Front Axle		11.0101-5407.2 260011	Brake System: ATE
2.0 i 16V 2.0 i Cat	110 09/88→11/95 85 09/90→11/95	→ Construction year to: 08/95; Fitting Position: Front Axle		11.0101-5407.2 260011	Brake System: ATE
2.5 V6	125 09/88→06/94	Construction year from: 02/93 →; Fitting Position: Front Axle		11.0101-5407.2 260011	Brake System: ATE
Guide Bolt, brake caliper					
1.4 S 1.6 i	55 09/88→11/95 52 - 09/88→11/95 55	Vehicle Identification Number from: N1038530 →; → Construction year to: 08/95; Required quantity: 2; Fitting Position: Front Axle	2	11.8171-0008.1 990049	Brake System: ATE
		Vehicle Identification Number from: N5000001 →; → Construction year to: 08/95; Required quantity: 2; Fitting Position: Front Axle	2	11.8171-0008.1 990049	Brake System: ATE
1.6	60 09/88→05/93	Vehicle Identification Number from: N1038530 →; Required quantity: 2; Fitting Position: Front Axle	2	11.8171-0008.1 990049	Brake System: ATE
		Vehicle Identification Number from: N5000001 →; Required quantity: 2; Fitting Position: Front Axle	2	11.8171-0008.1 990049	Brake System: ATE
→					

	kW				
VAUXHALL - CAVALIER Mk III Hatchback (J89) 09/88→11/95					
Guide Bolt, brake caliper					
1.7 D 1.8	42 09/88→09/92 66 09/88→10/90	Vehicle Identification Number from: S1000001 →; Required quantity: 2	2	11.8171-0008.1 990049	Brake System: ATE
		Vehicle Identification Number from: S5000001 →; Required quantity: 2	2	11.8171-0008.1 990049	Brake System: ATE
		Vehicle Identification Number from: N1038530 → → Vehicle Identification Number to: R1999999; Required quantity: 2; Fitting Position: Front Axle	2	11.8171-0008.1 990049	Brake System: ATE
		Vehicle Identification Number from: N5000001 → → Vehicle Identification Number to: R5999999; Required quantity: 2; Fitting Position: Front Axle	2	11.8171-0008.1 990049	Brake System: ATE
1.7 D 1.8 i Cat	44 07/92→11/95 66 03/90→11/95	Vehicle Identification Number from: S1000001 →; → Construction year to: 08/95; Required quantity: 2	2	11.8171-0008.1 990049	Brake System: ATE
		Vehicle Identification Number from: S5000001 →; → Construction year to: 08/95; Required quantity: 2	2	11.8171-0008.1 990049	Brake System: ATE
		Vehicle Identification Number from: N1038530 → → Vehicle Identification Number to: R1999999; Required quantity: 2; Fitting Position: Front Axle	2	11.8171-0008.1 990049	Brake System: ATE
		Vehicle Identification Number from: N5000001 → → Vehicle Identification Number to: R5999999; Required quantity: 2; Fitting Position: Front Axle	2	11.8171-0008.1 990049	Brake System: ATE
1.7 TD	60 09/88→11/95	Vehicle Identification Number from: S1000001 →; → Construction year to: 08/95; Required quantity: 2	2	11.8171-0008.1 990049	Brake System: ATE
		Vehicle Identification Number from: N1038530 → → Vehicle Identification Number to: R1999999; Required quantity: 2; Fitting Position: Front Axle	2	11.8171-0008.1 990049	Brake System: ATE
		Vehicle Identification Number from: N5000001 → → Vehicle Identification Number to: R5999999; Required quantity: 2; Fitting Position: Front Axle	2	11.8171-0008.1 990049	Brake System: ATE
2.0 i 2.0 i 16V 2.0 SRi	85 09/88→10/92 100 09/92→08/95 95 09/88→09/92	Required quantity: 2	2	11.8171-0008.1 990049	Brake System: ATE
2.0 i 16V 2.0 i Cat	110 09/88→11/95 85 09/90→11/95	→ Construction year to: 08/95; Required quantity: 2	2	11.8171-0008.1 990049	Brake System: ATE
2.0 i 16V 4x4 2.0 i 4x4	110 01/92→11/93 85 09/91→10/92	Required quantity: 2	2	11.8171-0008.1 990049	Brake System: ATE
		Required quantity: 2; Fitting Position: Front Axle	2	11.8171-0008.1 990049	Brake System: ATE
2.5 V6	125 09/88→06/94	Construction year from: 02/93 →; Required quantity: 2; Fitting Position: Front Axle	2	11.8171-0008.1 990049	Brake System: ATE
VAUXHALL - CAVALIER Mk III Saloon (J89) 08/88→11/95					
Guide Sleeve Kit, brake caliper					
1.4 S 1.6 i	55 09/88→11/95 52 - 09/88→11/95 55	Vehicle Identification Number from: N1038530 →; → Construction year to: 08/95; Fitting Position: Front Axle		11.0101-5407.2 260011	Brake System: ATE
		Vehicle Identification Number from: N5000001 →; → Construction year to: 08/95; Fitting Position: Front Axle		11.0101-5407.2 260011	Brake System: ATE
1.6	60 09/88→05/93	Vehicle Identification Number from: N5000001 →; Fitting Position: Front Axle		11.0101-5407.2 260011	Brake System: ATE
		Vehicle Identification Number from: N1038530 →; Fitting Position: Front Axle		11.0101-5407.2 260011	Brake System: ATE
1.7 D 1.8	42 09/88→09/92 66 09/88→08/95	Vehicle Identification Number from: S1000001 →; Fitting Position: Front Axle		11.0101-5407.2 260011	Brake System: ATE
		Vehicle Identification Number from: S5000001 →; Fitting Position: Front Axle		11.0101-5407.2 260011	Brake System: ATE
		Vehicle Identification Number from: N1038530 → → Vehicle Identification		11.0101-5407.2 260011	Brake System: ATE
→					

	kW				
VAUXHALL - CAVALIER Mk III Saloon (J89) 08/88→11/95					
Guide Sleeve Kit, brake caliper					
1.7 D 1.8	42 09/88→09/92 66 09/88→08/95	Number to: R1999999; Fitting Position: Front Axle			
		Vehicle Identification Number from: N5000001 → → Vehicle Identification Number to: R5999999; Fitting Position: Front Axle	11.0101-5407.2	260011	Brake System: ATE
1.7 D 1.8 i Cat	44 07/92→11/95 66 03/90→11/95	Vehicle Identification Number from: S1000001 →; → Construction year to: 08/95; Fitting Position: Front Axle	11.0101-5407.2	260011	Brake System: ATE
		Vehicle Identification Number from: S5000001 →; → Construction year to: 08/95; Fitting Position: Front Axle	11.0101-5407.2	260011	Brake System: ATE
		Vehicle Identification Number from: N1038530 → → Vehicle Identification Number to: R1999999; Fitting Position: Front Axle	11.0101-5407.2	260011	Brake System: ATE
		Vehicle Identification Number from: N5000001 → → Vehicle Identification Number to: R5999999; Fitting Position: Front Axle	11.0101-5407.2	260011	Brake System: ATE
1.7 TD	60 09/88→11/95	Vehicle Identification Number from: S1000001 →; → Construction year to: 08/95; Fitting Position: Front Axle	11.0101-5407.2	260011	Brake System: ATE
		Vehicle Identification Number from: N1038530 → → Vehicle Identification Number to: R1999999; Fitting Position: Front Axle	11.0101-5407.2	260011	Brake System: ATE
		Vehicle Identification Number from: N5000001 → → Vehicle Identification Number to: R5999999; Fitting Position: Front Axle	11.0101-5407.2	260011	Brake System: ATE
2.0 i 2.0 i 4x4 2.0 i Turbo 4x4 2.0 SRi 2.0 SRi 16V 2.0 i 16V 2.0 i 16V 4x4 2.0 i Cat	85 09/88→10/90 85 - 09/88→10/92 95 150 09/92→06/94 95 09/88→08/92 100 09/92→08/95 110 09/88→11/95 110 09/88→11/95 85 09/88→11/95	Fitting Position: Front Axle	11.0101-5407.2	260011	Brake System: ATE
2.5 V6	125 08/88→06/94	Construction year from: 02/93 →; Fitting Position: Front Axle	11.0101-5407.2	260011	Brake System: ATE
Guide Bolt, brake caliper					
1.4 S 1.6 i	55 09/88→11/95 52 - 09/88→11/95 55	Vehicle Identification Number from: N1038530 →; → Construction year to: 08/95; Required quantity: 2; Fitting Position: Front Axle	2	11.8171-0008.1	990049 Brake System: ATE
		Vehicle Identification Number from: N5000001 →; → Construction year to: 08/95; Required quantity: 2; Fitting Position: Front Axle	2	11.8171-0008.1	990049 Brake System: ATE
1.6	60 09/88→05/93	Vehicle Identification Number from: N1038530 →; Required quantity: 2; Fitting Position: Front Axle	2	11.8171-0008.1	990049 Brake System: ATE
		Vehicle Identification Number from: N5000001 →; Required quantity: 2; Fitting Position: Front Axle	2	11.8171-0008.1	990049 Brake System: ATE
1.7 D 1.8	42 09/88→09/92 66 09/88→08/95	Vehicle Identification Number from: S1000001 →; Required quantity: 2	2	11.8171-0008.1	990049 Brake System: ATE
		Vehicle Identification Number from: S5000001 →; Required quantity: 2	2	11.8171-0008.1	990049 Brake System: ATE
		Vehicle Identification Number from: N5000001 → → Vehicle Identification Number to: R5999999; Required quantity: 2; Fitting Position: Front Axle	2	11.8171-0008.1	990049 Brake System: ATE
		Vehicle Identification Number from: N1038530 → → Vehicle Identification Number to: R1999999; Required quantity: 2; Fitting Position: Front Axle	2	11.8171-0008.1	990049 Brake System: ATE
1.7 D 1.8 i Cat →	44 07/92→11/95 66 03/90→11/95	Vehicle Identification Number from: S1000001 →;	2	11.8171-0008.1	990049 Brake System: ATE



	kW				
VAUXHALL - CAVALIER Mk III Saloon (J89) 08/88→11/95					
Guide Bolt, brake caliper					
1.7 D 1.8 i Cat	44 07/92→11/95 66 03/90→11/95	→ Construction year to: 08/95; Required quantity: 2			
		Vehicle Identification Number from: S5000001 →; → Construction year to: 08/95; Required quantity: 2	2	11.8171-0008.1 990049	Brake System: ATE
		Vehicle Identification Number from: N5000001 → → Vehicle Identification Number to: R5999999; Required quantity: 2; Fitting Position: Front Axle	2	11.8171-0008.1 990049	Brake System: ATE
		Vehicle Identification Number from: N1038530 → → Vehicle Identification Number to: R1999999; Required quantity: 2; Fitting Position: Front Axle	2	11.8171-0008.1 990049	Brake System: ATE
1.7 TD	60 09/88→11/95	Vehicle Identification Number from: S1000001 →; → Construction year to: 08/95; Required quantity: 2	2	11.8171-0008.1 990049	Brake System: ATE
		Vehicle Identification Number from: N5000001 → → Vehicle Identification Number to: R5999999; Required quantity: 2; Fitting Position: Front Axle	2	11.8171-0008.1 990049	Brake System: ATE
		Vehicle Identification Number from: N1038530 → → Vehicle Identification Number to: R1999999; Required quantity: 2; Fitting Position: Front Axle	2	11.8171-0008.1 990049	Brake System: ATE
2.0 i 2.0 SRi 2.0 SRi 16V	85 09/88→10/90 95 09/88→08/92 100 09/92→08/95	Required quantity: 2	2	11.8171-0008.1 990049	Brake System: ATE
2.0 i 16V 2.0 i Cat	110 09/88→11/95 85 09/88→11/95	→ Construction year to: 08/95; Required quantity: 2	2	11.8171-0008.1 990049	Brake System: ATE
2.0 i 16V 4x4	110 09/88→11/95	→ Construction year to: 08/95; Required quantity: 2; Fitting Position: Front Axle	2	11.8171-0008.1 990049	Brake System: ATE
2.0 i 4x4 2.0 i Turbo 4x4	85 - 09/88→10/92 95 150 09/92→06/94	Required quantity: 2; Fitting Position: Front Axle	2	11.8171-0008.1 990049	Brake System: ATE
2.5 V6	125 08/88→06/94	Construction year from: 02/93 →; Required quantity: 2; Fitting Position: Front Axle	2	11.8171-0008.1 990049	Brake System: ATE
VAUXHALL - COMBO Mk I (B) (S93) 07/94→10/01					
Guide Sleeve Kit, brake caliper					
1.4 1.4 16V 1.7 D	44 07/94→10/01 66 08/99→10/01 44 07/94→10/01	→ Construction year to: 09/00; Fitting Position: Front Axle		11.0101-5407.2 260011	Brake System: ATE
Guide Bolt, brake caliper					
1.4 1.4 16V 1.7 D	44 07/94→10/01 66 08/99→10/01 44 07/94→10/01	→ Construction year to: 09/00; Required quantity: 2; Fitting Position: Front Axle	2	11.8171-0008.1 990049	Brake System: ATE
VAUXHALL - COMBO Mk II (C) Box Body/MPV (F25) 09/01→02/12					
Guide Sleeve Kit, brake caliper					
1.3 CDTI 16V 1.4 i 16V 1.6 1.7 DI 16V 1.7 DTI 16V	51 - 09/04→02/12 55 66 01/04→11/11 64 10/01→11/11 48 09/01→11/11 55 10/01→11/11	Vehicle Identification Number from: 43033899, 53000001 →; → Construction year to: 10/11; Payload: for increased payload; Fitting Position: Front Axle		11.0101-5407.2 260011	Brake System: ATE
1.4 16V 1.6	66 10/01→05/07 62 09/01→10/04	Vehicle Identification Number from: 43033899, 53000001 →; Payload: for increased payload; Fitting Position: Front Axle		11.0101-5407.2 260011	Brake System: ATE
1.6 CNG 16V 1.7 CDTI 16V	69 - 04/05→02/12 71 74 12/04→11/11	→ Construction year to: 10/11; Fitting Position: Front Axle		11.0101-5407.2 260011	Brake System: ATE
Guide Bolt, brake caliper					
1.3 CDTI 16V 1.4 i 16V 1.6 1.7 DI 16V →	51 - 09/04→02/12 55 66 01/04→11/11 64 10/01→11/11 48 09/01→11/11	Vehicle Identification Number from: 43033899, 53000001 →; → Construction year to: 10/11; Payload: for increased payload; Required quantity: 2	2	11.8171-0008.1 990049	Brake System: ATE



VAUXHALL - COMBO Mk II (C) Box Body/MPV (F25) 09/01→02/12						
Guide Bolt, brake caliper						
1.7 DTI 16V	55	10/01→11/11	Vehicle Identification Number from: 43033899, 53000001 →; → Construction year to: 10/11; Payload: for increased payload; Required quantity: 2	2	11.8171-0008.1 990049	Brake System: ATE
1.4 16V 1.6	66 62	10/01→05/07 09/01→10/04	Vehicle Identification Number from: 43033899, 53000001 →; Payload: for increased payload; Required quantity: 2	2	11.8171-0008.1 990049	Brake System: ATE
1.6 CNG 16V 1.7 CDTI 16V	69 74	04/05→02/12 12/04→11/11	→ Construction year to: 10/11; Required quantity: 2	2	11.8171-0008.1 990049	Brake System: ATE
VAUXHALL - COMBO Mk IV (E) Box Body/MPV (K9) 06/18→						
Guide Sleeve Kit, brake caliper						
1.2 1.5 D 1.5 D 4x4 1.6 D Combo-e	81 56 96 96 55 73 100	02/19→ 08/18→ 08/18→ 06/18→ 07/21→	Fitting Position: Front Axle		11.0101-5407.2 260011	Brake System: ATE
Guide Bolt, brake caliper						
1.2 1.5 D 1.5 D 4x4 1.6 D Combo-e	81 56 96 55 73 100	02/19→ 08/18→ 08/18→ 06/18→ 07/21→	Fitting Position: Front Axle		11.8171-0008.1 990049	Brake System: ATE
VAUXHALL - COMBO Mk IV (E) Life (K9) 06/18→						
Guide Sleeve Kit, brake caliper						
1.2 1.5 Combo-e	81 75 96 100	06/18→ 06/18→ 06/21→	Fitting Position: Front Axle		11.0101-5407.2 260011	Brake System: ATE
Guide Bolt, brake caliper						
1.2 1.5 Combo-e	81 75 96 100	06/18→ 06/18→ 06/21→	Fitting Position: Front Axle		11.8171-0008.1 990049	Brake System: ATE
VAUXHALL - COMBO TOUR Mk II (C) (F25) 09/01→02/12						
Guide Sleeve Kit, brake caliper						
1.3 CDTI 16V 1.4 1.6 1.7 DI 16V	51 66 64 48	09/04→09/06 10/04→09/10 10/01→06/04 09/01→06/04	Vehicle Identification Number from: 43033899, 53000001 →; Payload: for increased payload; Fitting Position: Front Axle		11.0101-5407.2 260011	Brake System: ATE
1.3 CDTI 16V 1.7 DTI 16V	55 55	07/06→02/12 10/01→02/12	Vehicle Identification Number from: 43033899, 53000001 →; → Construction year to: 10/11; Payload: for increased payload; Fitting Position: Front Axle		11.0101-5407.2 260011	Brake System: ATE
1.6 CNG 1.7 CDTI 16V	69 74	06/06→09/10 12/04→09/10	Fitting Position: Front Axle		11.0101-5407.2 260011	Brake System: ATE
1.6 CNG	71	04/05→02/12	→ Construction year to: 10/11; Fitting Position: Front Axle		11.0101-5407.2 260011	Brake System: ATE
Guide Bolt, brake caliper						
1.3 CDTI 16V 1.4 1.6 1.7 DI 16V	51 66 64 48	09/04→09/06 10/04→09/10 10/01→06/04 09/01→06/04	Vehicle Identification Number from: 43033899, 53000001 →; Payload: for increased payload; Required quantity: 2	2	11.8171-0008.1 990049	Brake System: ATE
1.3 CDTI 16V 1.7 DTI 16V	55 55	07/06→02/12 10/01→02/12	Vehicle Identification Number from: 43033899, 53000001 →; → Construction year to: 10/11; Payload: for increased payload; Required quantity: 2	2	11.8171-0008.1 990049	Brake System: ATE
1.6 CNG 1.7 CDTI 16V	69 74	06/06→09/10 12/04→09/10	Required quantity: 2	2	11.8171-0008.1 990049	Brake System: ATE
1.6 CNG	71	04/05→02/12	→ Construction year to: 10/11; Required quantity: 2	2	11.8171-0008.1 990049	Brake System: ATE

	kW				
VAUXHALL - CORSA Mk I (B) (S93) 12/92→09/00					
Guide Sleeve Kit, brake caliper					
1.0 i 12V	40	11/96→09/00	Fitting Position: Front Axle	11.0101-5407.2	260011 Brake System: ATE
1.4 i 16V	66	09/94→09/00			
1.4 i S	60	03/93→09/00			
1.5 TD	49	03/93→10/96			
1.6 i 16V	78	09/94→09/00			
1.7 D	44	02/96→09/00			
1.2 i	33	03/93→09/00	Construction year from: 04/98 →; Vehicle Equipment: for vehicles without sports package; Fitting Position: Front Axle	11.0101-5407.2	260011 Brake System: ATE
			Transmission Type: Manual Transmission; Vehicle Equipment: for vehicles without sports package; Fitting Position: Front Axle	11.0101-5407.2	260011 Brake System: ATE
			Transmission Type: Automatic Transmission; Vehicle Equipment: for vehicles without sports package; Fitting Position: Front Axle	11.0101-5407.2	260011 Brake System: ATE
			Construction year from: 04/98 →; Transmission Type: Manual Transmission; Vehicle Equipment: for vehicles without sports package; Fitting Position: Front Axle	11.0101-5407.2	260011 Brake System: ATE
			Construction year from: 04/98 →; Transmission Type: Automatic Transmission; Vehicle Equipment: for vehicles without sports package; Fitting Position: Front Axle	11.0101-5407.2	260011 Brake System: ATE
			Construction year from: 04/98 →; Vehicle Equipment: for vehicles with sports package; Fitting Position: Front Axle	11.0101-5407.2	260011 Brake System: ATE
1.2 i 16V	48	03/98→09/00	Construction year from: 04/98 →; Vehicle Equipment: for vehicles with sports package; Fitting Position: Front Axle	11.0101-5407.2	260011 Brake System: ATE
			Construction year from: 04/98 →; Vehicle Equipment: for vehicles without sports package; Fitting Position: Front Axle	11.0101-5407.2	260011 Brake System: ATE
			Construction year from: 04/98 →; Transmission Type: Manual Transmission; Vehicle Equipment: for vehicles without sports package; Fitting Position: Front Axle	11.0101-5407.2	260011 Brake System: ATE
			Construction year from: 04/98 →; Transmission Type: Automatic Transmission; Vehicle Equipment: for vehicles without sports package; Fitting Position: Front Axle	11.0101-5407.2	260011 Brake System: ATE
1.4 i	44	03/93→09/00	Transmission Type: Automatic Transmission; Vehicle Equipment: for vehicles without sports package; Fitting Position: Front Axle	11.0101-5407.2	260011 Brake System: ATE
			Transmission Type: Manual Transmission; Vehicle Equipment: for vehicles without sports package; Fitting Position: Front Axle	11.0101-5407.2	260011 Brake System: ATE
			Vehicle Equipment: for vehicles with sports package; Fitting Position: Front Axle	11.0101-5407.2	260011 Brake System: ATE
1.5 D	37	12/92→12/96	Construction year from: 03/93 →; Fitting Position: Front Axle	11.0101-5407.2	260011 Brake System: ATE
1.6 GSI 16V	80	03/93→09/00	Construction year from: 09/93 →; Fitting Position: Front Axle	11.0101-5407.2	260011 Brake System: ATE
Guide Bolt, brake caliper					
1.0 i 12V	40	11/96→09/00	Required quantity: 2; Fitting Position: Front Axle	2	11.8171-0008.1 990049 Brake System: ATE
1.4 i 16V	66	09/94→09/00			
1.4 i S	60	03/93→09/00			
1.5 TD	49	03/93→10/96			
1.6 i 16V	78	09/94→09/00			
→					



	kW				
VAUXHALL - CORSA Mk I (B) (S93) 12/92→09/00					
Guide Bolt, brake caliper					
1.7 D	44	02/96→09/00	Required quantity: 2; Fitting Position: Front Axle	2	11.8171-0008.1 990049 Brake System: ATE
1.2 i	33	03/93→09/00	Transmission Type: Automatic Transmission; Required quantity: 2; Vehicle Equipment: for vehicles without sports package; Fitting Position: Front Axle	2	11.8171-0008.1 990049 Brake System: ATE
			Construction year from: 04/98 →; Required quantity: 2; Vehicle Equipment: for vehicles with sports package; Fitting Position: Front Axle	2	11.8171-0008.1 990049 Brake System: ATE
			Construction year from: 04/98 →; Required quantity: 2; Vehicle Equipment: for vehicles without sports package; Fitting Position: Front Axle	2	11.8171-0008.1 990049 Brake System: ATE
			Construction year from: 04/98 →; Transmission Type: Manual Transmission; Required quantity: 2; Vehicle Equipment: for vehicles without sports package; Fitting Position: Front Axle	2	11.8171-0008.1 990049 Brake System: ATE
			Construction year from: 04/98 →; Transmission Type: Automatic Transmission; Required quantity: 2; Vehicle Equipment: for vehicles without sports package; Fitting Position: Front Axle	2	11.8171-0008.1 990049 Brake System: ATE
			Transmission Type: Manual Transmission; Required quantity: 2; Vehicle Equipment: for vehicles without sports package; Fitting Position: Front Axle	2	11.8171-0008.1 990049 Brake System: ATE
1.2 i 16V	48	03/98→09/00	Construction year from: 04/98 →; Required quantity: 2; Vehicle Equipment: for vehicles with sports package; Fitting Position: Front Axle	2	11.8171-0008.1 990049 Brake System: ATE
			Construction year from: 04/98 →; Required quantity: 2; Vehicle Equipment: for vehicles without sports package; Fitting Position: Front Axle	2	11.8171-0008.1 990049 Brake System: ATE
			Construction year from: 04/98 →; Transmission Type: Manual Transmission; Required quantity: 2; Vehicle Equipment: for vehicles without sports package; Fitting Position: Front Axle	2	11.8171-0008.1 990049 Brake System: ATE
			Construction year from: 04/98 →; Transmission Type: Automatic Transmission; Required quantity: 2; Vehicle Equipment: for vehicles without sports package; Fitting Position: Front Axle	2	11.8171-0008.1 990049 Brake System: ATE
1.4 i	44	03/93→09/00	Required quantity: 2; Vehicle Equipment: for vehicles with sports package; Fitting Position: Front Axle	2	11.8171-0008.1 990049 Brake System: ATE
			Transmission Type: Automatic Transmission; Required quantity: 2; Vehicle Equipment: for vehicles without sports package; Fitting Position: Front Axle	2	11.8171-0008.1 990049 Brake System: ATE
			Transmission Type: Manual Transmission; Required quantity: 2; Vehicle Equipment: for vehicles without sports package; Fitting Position: Front Axle	2	11.8171-0008.1 990049 Brake System: ATE
1.5 D	37	12/92→12/96	Construction year from: 03/93 →; Required quantity: 2; Fitting Position: Front Axle	2	11.8171-0008.1 990049 Brake System: ATE
1.6 GSI 16V	80	03/93→09/00	Construction year from: 09/93 →; Required quantity: 2; Fitting Position: Front Axle	2	11.8171-0008.1 990049 Brake System: ATE



	kW				
VAUXHALL - CORSA Mk II (C) (X01) 08/00→04/07					
Guide Sleeve Kit, brake caliper					
1.7 CDTi 16V	74	08/00→09/06	Construction year from: 06/03 →; Fitting Position: Front Axle	11.0101-5407.2 260011	Brake System: ATE
Guide Bolt, brake caliper					
1.7 CDTi 16V	74	08/00→09/06	Construction year from: 06/03 →; Required quantity: 2	2 11.8171-0008.1 990049	Brake System: ATE
VAUXHALL - CORSA Mk III (D) (S07) 07/06→08/14					
Guide Bolt, brake caliper					
1.6 SRi	110	05/07→08/14	Construction year from: 06/07 →; Required quantity: 2	2 11.8171-0008.1 990049	Brake System: ATE
1.6 VXR	141 - 155	11/06→08/14	Required quantity: 2	2 11.8171-0008.1 990049	Brake System: ATE
VAUXHALL - CORSA Mk IV (E) (X15) 08/14→					
Spring, brake caliper					
1.0	66 - 85	08/14→	Construction year from: 11/14 →; for brake disc diameter [mm]: 284; Required quantity: 2; Fitting Position: Front Axle	2 11.8116-0356.1 390586	Brake System: ATE
1.2	51	08/14→			
1.3 CDTi	55 - 70	08/14→			
1.4	55 - 74	08/14→			
1.4	110	07/15→	for brake disc diameter [mm]: 284; Required quantity: 2; Fitting Position: Front Axle	2 11.8116-0356.1 390586	Brake System: ATE
Guide Sleeve Kit, brake caliper					
1.0	66 - 85	08/14→	Construction year from: 11/14 →; for brake disc diameter [mm]: 308; Fitting Position: Front Axle	11.0101-5407.2 260011	Brake System: ATE
1.2	51	08/14→			
1.3 CDTi	55 - 70	08/14→			
1.4	55 - 74	08/14→			
1.4	110	07/15→	for brake disc diameter [mm]: 308; Fitting Position: Front Axle	11.0101-5407.2 260011	Brake System: ATE
Guide Bolt, brake caliper					
1.0	66 - 85	08/14→	Construction year from: 11/14 →; for brake disc diameter [mm]: 308; Required quantity: 2	2 11.8171-0008.1 990049	Brake System: ATE
1.2	51	08/14→			
1.3 CDTi	55 - 70	08/14→			
1.4	55 - 74	08/14→			
1.4	110	07/15→	for brake disc diameter [mm]: 308; Required quantity: 2	2 11.8171-0008.1 990049	Brake System: ATE
 Cable Pull, parking brake					
1.0	66 - 85	08/14→	Required quantity: 1; Brake Type: Disc Brake; Fitting Position: Rear	1 24.3727-3503.2 583503	Length [mm]: 1,453 Length 2 [mm]: 1,468
1.2	51	08/14→			
1.3 CDTi	55 - 70	08/14→			
1.4	55 - 110	08/14→			
1.6 VXR	151	04/15→			
VAUXHALL - CORSAVAN Mk I (B) Hatchback Van (S93) 01/94→09/00					
Guide Sleeve Kit, brake caliper					
1.4 i	44	01/94→09/00	Transmission Type: Automatic Transmission; Vehicle Equipment: for vehicles without sports package; Fitting Position: Front Axle	11.0101-5407.2 260011	Brake System: ATE
			Transmission Type: Manual Transmission; Vehicle Equipment: for vehicles without sports package; Fitting Position: Front Axle		
			Vehicle Equipment: for vehicles with sports package; Fitting Position: Front Axle		
			Fitting Position: Front Axle		
1.5 D	37	08/94→12/95	Fitting Position: Front Axle	11.0101-5407.2 260011	Brake System: ATE
1.7 D	44	01/94→09/00		11.0101-5407.2 260011	Brake System: ATE
→					



	kW				
VAUXHALL - CORSAVAN Mk I (B) Hatchback Van (S93) 01/94→09/00					
Guide Bolt, brake caliper					
1.4 i	44	01/94→09/00	Required quantity: 2; Fitting Position: Front Axle	2	11.8171-0008.1 990049 Brake System: ATE
			Required quantity: 2; Vehicle Equipment: for vehicles with sports package; Fitting Position: Front Axle	2	11.8171-0008.1 990049 Brake System: ATE
			Transmission Type: Manual Transmission; Required quantity: 2; Vehicle Equipment: for vehicles without sports package; Fitting Position: Front Axle	2	11.8171-0008.1 990049 Brake System: ATE
			Transmission Type: Automatic Transmission; Required quantity: 2; Vehicle Equipment: for vehicles without sports package; Fitting Position: Front Axle	2	11.8171-0008.1 990049 Brake System: ATE
1.5 D	37	08/94→12/95	Required quantity: 2;	2	11.8171-0008.1 990049 Brake System: ATE
1.7 D	44	01/94→09/00	Fitting Position: Front Axle		
VAUXHALL - CORSAVAN Mk IV (E) Hatchback Van (X15) 10/14→					
Spring, brake caliper					
1.2	51	10/14→	Construction year from: 11/14 →;	2	11.8116-0356.1 390586 Brake System: ATE
1.3 CDTi	55 - 70	10/14→	for brake disc diameter [mm]: 284; Required quantity: 2; Fitting Position: Front Axle		
Guide Sleeve Kit, brake caliper					
1.2	51	10/14→	Construction year from: 11/14 →;		
1.3 CDTi	55 - 70	10/14→	for brake disc diameter [mm]: 308; Fitting Position: Front Axle		11.0101-5407.2 260011 Brake System: ATE
Guide Bolt, brake caliper					
1.2	51	10/14→	Construction year from: 11/14 →;	2	11.8171-0008.1 990049 Brake System: ATE
1.3 CDTi	55 - 70	10/14→	for brake disc diameter [mm]: 308; Required quantity: 2		
 Cable Pull, parking brake					
1.2	51	10/14→	Required quantity: 1;	1	24.3727-3503.2 583503 Length [mm]: 1,453
1.3 CDTi	55 - 70	10/14→	Brake Type: Disc Brake; Fitting Position: Rear		Length 2 [mm]: 1,468
VAUXHALL - GRANDLAND X / GRANDLAND (A18) 06/17→					
Guide Sleeve Kit, brake caliper					
1.2 Turbo	96	06/17→	for brake disc diameter [mm]: 304;		
1.5 Turbo D	96	04/18→	→ for RPO number (vehicle manufacturing date) up to: 16246;		11.0101-5407.2 260011 Brake System: ATE
1.6 Turbo D	88	06/17→	Fitting Position: Front Axle		
1.6 Turbo Hybrid	133 - 165	12/19→			
1.6 Turbo Hybrid4	147 - 221	06/19→			
2.0 D	130	10/17→			
Guide Bolt, brake caliper					
1.2 Turbo	96	06/17→	for brake disc diameter [mm]: 304;		
1.5 Turbo D	96	04/18→	→ for RPO number (vehicle manufacturing date) up to: 16246;		11.8171-0008.1 990049 Brake System: ATE
1.6 Turbo D	88	06/17→	Fitting Position: Front Axle		
1.6 Turbo Hybrid	133 - 165	12/19→			
1.6 Turbo Hybrid4	147 - 221	06/19→			
2.0 D	130	10/17→			
VAUXHALL - INSIGNIA Mk I (A) Country Tourer (G09) 07/08→05/17					
 Brake Caliper					
1.6 CDTi	100	07/15→05/17	for brake disc diameter [mm]: 337;		
1.6 Turbo	125	07/13→05/17	Fitting Position: Front Axle Left		24.3421-1723.5 241449 Supplementary Article/Supplementary Info: without holder
2.0 Biturbo CDTi 4x4	143	09/13→05/17			Brake Caliper Type: Fist-type Caliper
2.0 CDTi	125	11/14→05/17			
2.0 CDTi 4x4	125	11/14→05/17			
2.0 CDTi	120	07/13→05/17	Construction year from: 09/13 →;		
			for brake disc diameter [mm]: 337; Fitting Position: Front Axle Left		24.3421-1723.5 241449 Supplementary Article/Supplementary Info: without holder
			for brake disc diameter [mm]: 337; Fitting Position: Front Axle Left		24.3421-1723.5 241449 Supplementary Article/Supplementary Info: without holder
					Brake Caliper Type: Fist-type Caliper

	kW				
VAUXHALL - INSIGNIA Mk I (A) Hatchback (G09) 07/08→05/17					
 Brake Caliper					
1.4	103	04/11→05/17	Construction year from: 06/11 →; for brake disc diameter [mm]: 337; Fitting Position: Front Axle Left	24.3421-1723.5 241449	Supplementary Article/Supplementary Info: without holder Brake Caliper Type: Fist-type Caliper
1.4 LPG 1.6 1.6 CDTI 1.6 Turbo 1.8 2.0 Biturbo CDTI 2.0 Biturbo CDTI 4x4 2.0 CDTI 2.0 CDTI 4x4 2.0 Turbo 2.0 Turbo 4x4 2.8 V6 Turbo 4x4	103 85 100 125 - 132 103 143 143 81 - 140 125 - 140 162 162 191	07/12→05/17 07/08→07/12 07/15→05/17 01/09→05/17 07/08→05/17 03/12→05/17 03/12→05/17 07/08→05/17 05/09→05/17 07/08→05/17 07/08→05/17 07/08→05/17	for brake disc diameter [mm]: 337; Fitting Position: Front Axle Left	24.3421-1723.5 241449	Supplementary Article/Supplementary Info: without holder Brake Caliper Type: Fist-type Caliper
2.0 CDTI	88	03/12→03/16	Construction year from: 03/13 →; for brake disc diameter [mm]: 337; Fitting Position: Front Axle Left	24.3421-1723.5 241449	Supplementary Article/Supplementary Info: without holder Brake Caliper Type: Fist-type Caliper
2.0 CDTI 4x4	118	07/08→05/17	Construction year from: 06/10 →; for brake disc diameter [mm]: 337; Fitting Position: Front Axle Left	24.3421-1723.5 241449	Supplementary Article/Supplementary Info: without holder Brake Caliper Type: Fist-type Caliper
2.0 Turbo	184	07/11→05/17	Construction year from: 04/14 →; for brake disc diameter [mm]: 337; Fitting Position: Front Axle Left	24.3421-1723.5 241449	Supplementary Article/Supplementary Info: without holder Brake Caliper Type: Fist-type Caliper
VAUXHALL - INSIGNIA Mk I (A) Saloon (G09) 07/08→05/17					
 Brake Caliper					
1.4	103	04/11→05/17	Construction year from: 06/11 →; for brake disc diameter [mm]: 337; Fitting Position: Front Axle Left	24.3421-1723.5 241449	Supplementary Article/Supplementary Info: without holder Brake Caliper Type: Fist-type Caliper
1.4 LPG 1.6 1.6 CDTi 1.6 Turbo 1.8 2.0 Biturbo CDTI 2.0 Biturbo CDTI 4x4 2.0 CDTI 2.0 CDTI 4x4 2.0 Turbo 2.0 Turbo 4x4 2.8 V6 Turbo 4x4	103 85 100 132 103 143 143 96 - 140 125 - 140 162 162 - 184 191	07/12→05/17 07/08→07/12 07/15→05/17 01/09→05/17 07/08→05/17 03/12→05/17 03/12→05/17 07/08→05/17 05/09→05/17 07/08→05/17 07/08→05/17 07/08→05/17	for brake disc diameter [mm]: 337; Fitting Position: Front Axle Left	24.3421-1723.5 241449	Supplementary Article/Supplementary Info: without holder Brake Caliper Type: Fist-type Caliper
2.0 CDTI 4x4	118	07/08→05/17	Construction year from: 06/10 →; for brake disc diameter [mm]: 337; Fitting Position: Front Axle Left	24.3421-1723.5 241449	Supplementary Article/Supplementary Info: without holder Brake Caliper Type: Fist-type Caliper
2.0 Turbo	184	09/11→05/17	Construction year from: 04/14 →; for brake disc diameter [mm]: 337; Fitting Position: Front Axle Left	24.3421-1723.5 241449	Supplementary Article/Supplementary Info: without holder Brake Caliper Type: Fist-type Caliper
VAUXHALL - INSIGNIA Mk I (A) Sports Tourer (G09) 07/08→05/17					
 Brake Caliper					
1.4	103	04/11→05/17	Construction year from: 06/11 →; for brake disc diameter [mm]: 337; Fitting Position: Front Axle Left	24.3421-1723.5 241449	Supplementary Article/Supplementary Info: without holder Brake Caliper Type: Fist-type Caliper
1.4 LPG 1.6 1.6 CDTI 1.6 Turbo 1.8 2.0 Biturbo CDTI 2.0 Biturbo CDTI 4x4 2.0 CDTI →	103 85 100 125 - 132 103 143 143 81 - 140 →	07/12→05/17 07/08→07/12 07/15→05/17 01/09→05/17 07/08→05/17 03/12→05/17 03/12→05/17 07/08→05/17 07/08→05/17 03/12→05/17 03/12→05/17 07/08→05/17 →	for brake disc diameter [mm]: 337; Fitting Position: Front Axle Left	24.3421-1723.5 241449	Supplementary Article/Supplementary Info: without holder Brake Caliper Type: Fist-type Caliper

	kW				
VAUXHALL - INSIGNIA Mk I (A) Sports Tourer (G09) 07/08→05/17					
 Brake Caliper					
2.0 CDTI 4x4 2.0 Turbo 2.0 Turbo 4x4 2.8 V6 Turbo	125 - 05/09→05/17 140 162 07/08→05/17 162 07/08→05/17 191 08/08→05/17	for brake disc diameter [mm]: 337; Fitting Position: Front Axle Left		24.3421-1723.5 241449	Supplementary Article/Supplementary Info: without holder Brake Caliper Type: Fist-type Caliper
2.0 CDTI	88 03/12→03/16	Construction year from: 03/13 →; for brake disc diameter [mm]: 337; Fitting Position: Front Axle Left		24.3421-1723.5 241449	Supplementary Article/Supplementary Info: without holder Brake Caliper Type: Fist-type Caliper
2.0 CDTI 4x4	118 07/08→05/17	Construction year from: 06/10 →; for brake disc diameter [mm]: 337; Fitting Position: Front Axle Left		24.3421-1723.5 241449	Supplementary Article/Supplementary Info: without holder Brake Caliper Type: Fist-type Caliper
2.0 Turbo	184 07/11→05/17	Construction year from: 04/14 →; for brake disc diameter [mm]: 337; Fitting Position: Front Axle Left		24.3421-1723.5 241449	Supplementary Article/Supplementary Info: without holder Brake Caliper Type: Fist-type Caliper
VAUXHALL - MERIVA A (X03) 01/03→06/10					
Guide Sleeve Kit, brake caliper					
1.3 CDTI 1.7 DTI 1.8 i 16V	51 04/05→06/10 55 06/03→06/10 92 05/03→06/10	→ Construction year to: 05/10; Fitting Position: Front Axle		11.0101-5407.2 260011	Brake System: ATE
1.3 CDTI	55 01/03→10/09	Construction year from: 09/03 →; Fitting Position: Front Axle		11.0101-5407.2 260011	Brake System: ATE
1.4 16V Twinport	66 01/03→06/10	Construction year from: 07/04 → → Construction year to: 05/10; Rim Hole Number: 5; Fitting Position: Front Axle		11.0101-5407.2 260011	Brake System: ATE
1.6 i 16V	74 01/03→09/05	Construction year from: 05/03 →; Fitting Position: Front Axle		11.0101-5407.2 260011	Brake System: ATE
1.6 i 16V Twinport	77 05/03→06/10	Construction year from: 01/06 → → Construction year to: 05/10; Fitting Position: Front Axle		11.0101-5407.2 260011	Brake System: ATE
1.7 CDTi	74 09/03→08/05	Fitting Position: Front Axle		11.0101-5407.2 260011	Brake System: ATE
Guide Bolt, brake caliper					
1.3 CDTI 1.7 DTI 1.8 i 16V	51 04/05→06/10 55 06/03→06/10 92 05/03→06/10	→ Construction year to: 05/10; Required quantity: 2	2	11.8171-0008.1 990049	Brake System: ATE
1.3 CDTI	55 01/03→10/09	Construction year from: 09/03 →; Required quantity: 2	2	11.8171-0008.1 990049	Brake System: ATE
1.4 16V Twinport	66 01/03→06/10	Construction year from: 07/04 → → Construction year to: 05/10; Rim Hole Number: 5; Required quantity: 2	2	11.8171-0008.1 990049	Brake System: ATE
1.6 i 16V	74 01/03→09/05	Construction year from: 05/03 →; Required quantity: 2	2	11.8171-0008.1 990049	Brake System: ATE
1.6 i 16V Twinport	77 05/03→06/10	Construction year from: 01/06 → → Construction year to: 05/10; Required quantity: 2	2	11.8171-0008.1 990049	Brake System: ATE
1.7 CDTi	74 09/03→08/05	Required quantity: 2	2	11.8171-0008.1 990049	Brake System: ATE
VAUXHALL - MERIVA Mk II (B) (S10) 06/10→					
Guide Sleeve Kit, brake caliper					
1.3 CDTi 1.3 CDTi 1.4 1.4 LPG 1.6 CDTi 1.7 CDTi 1.7 CDTi	70 06/10→ 55 06/10→ 74 - 06/10→ 103 88 06/11→ 81 - 08/13→ 100 81 - 06/10→ 96 74 06/10→	Fitting Position: Front Axle		11.0101-5407.2 260011	Brake System: ATE
1.6 CDTi	70 01/14→	Construction year from: 03/14 →; Fitting Position: Front Axle		11.0101-5407.2 260011	Brake System: ATE
Guide Bolt, brake caliper					
1.3 CDTi 1.3 CDTi 1.4 1.4 LPG 1.6 CDTi →	70 06/10→ 55 06/10→ 74 - 06/10→ 103 88 06/11→ 81 - 08/13→ 100	Required quantity: 2	2	11.8171-0008.1 990049	Brake System: ATE

	kW				
VAUXHALL - MERIVA Mk II (B) (S10) 06/10→					
Guide Bolt, brake caliper					
1.7 CDTi	81 - 06/10→ 96	Required quantity: 2	2	11.8171-0008.1 990049	Brake System: ATE
1.7 CDTi	74 06/10→				
1.6 CDTi	70 01/14→	Construction year from: 03/14 →; Required quantity: 2	2	11.8171-0008.1 990049	Brake System: ATE
VAUXHALL - MOKKA / MOKKA X (J13) 06/12→					
 Brake Pad Set, disc brake					
1.4	103 04/13→	Vehicle Identification Number from: JB000001 / J4000001 →; Fitting Position: Front Axle		13.0460-5527.2 605527	Brake System: Mando Wear Warning Contact: with acoustic wear warning Supplementary Article/Supple- mentary Info: with accessories
1.4 4x4	103 - 06/12→ 112				
1.6	85 06/12→				
1.6 CDTi	100 01/15→				
1.6 CDTi	81 06/15→				
1.6 CDTi 4x4	100 01/15→				
1.7 CDTi	96 06/12→				
1.7 CDTi 4x4	96 06/12→				
VAUXHALL - MOVANO Mk II (B) Chassis/Cab (X62) 05/10→					
 Brake Caliper					
2.3 CDTi FWD	74 - 05/10→ 132	Fitting Position: Front Axle Left		24.3481-1821.5 241355	Brake System: Brembo Supplementary Article/Supple- mentary Info: without holder Brake Caliper Type: Fist-type Caliper (2 pistons)
2.3 CDTi RWD	74 - 05/10→ 120				
		Fitting Position: Front Axle Right		24.3481-1822.5 241356	Brake System: Brembo Supplementary Article/Supple- mentary Info: without holder Brake Caliper Type: Fist-type Caliper (2 pistons)
		Tyres: for single tyres; Fitting Position: Rear Axle Left		24.3484-1703.5 241303	Brake System: Bosch Supplementary Article/Supple- mentary Info: without holder Brake Caliper Type: Fist-type Caliper
		Tyres: for single tyres; Fitting Position: Rear Axle Right		24.3484-1704.5 241304	Brake System: Bosch Supplementary Article/Supple- mentary Info: without holder Brake Caliper Type: Fist-type Caliper
2.3 CDTi FWD	96 10/16→	Fitting Position: Front Axle Left		24.3481-1821.5 241355	Brake System: Brembo Supplementary Article/Supple- mentary Info: without holder Brake Caliper Type: Fist-type Caliper (2 pistons)
2.3 CDTi RWD	96 10/16→				
		Fitting Position: Front Axle Right		24.3481-1822.5 241356	Brake System: Brembo Supplementary Article/Supple- mentary Info: without holder Brake Caliper Type: Fist-type Caliper (2 pistons)
		Construction year from: 11/16 →; Tyres: for single tyres; Fitting Position: Rear Axle Left		24.3484-1703.5 241303	Brake System: Bosch Supplementary Article/Supple- mentary Info: without holder Brake Caliper Type: Fist-type Caliper
		Construction year from: 11/16 →; Tyres: for single tyres; Fitting Position: Rear Axle Right		24.3484-1704.5 241304	Brake System: Bosch Supplementary Article/Supple- mentary Info: without holder Brake Caliper Type: Fist-type Caliper
 Brake Disc					
2.3 CDTi FWD	74 - 05/10→ 132	Fitting Position: Front Axle		24.0128-0252.1 428252	Outer diameter [mm]: 302 Brake Disc Thickness [mm] 28 Minimum thickness [mm] 24.5 Brake Disc Type: Vented Supplementary Article/Info 2: with bolts/screws
		Fitting Position: Rear Axle		24.0112-0191.1 412191	Outer diameter [mm]: 305 Brake Disc Thickness [mm] 12 Minimum thickness [mm] 10 Brake Disc Type: Solid Supplementary Article/Info 2: with bolts/screws
→					

		kW						
VAUXHALL - MOVANO Mk II (B) Chassis/Cab (X62) 05/10→								
 Brake Disc								
2.3 CDTI FWD	96 10/16→	Construction year from: 11/16 →; Fitting Position: Front Axle		24.0128-0252.1 428252	Outer diameter [mm]: 302 Brake Disc Thickness [mm] 28 Minimum thickness [mm] 24.5 Brake Disc Type: Vented Supplementary Article/Info 2: with bolts/screws			
		Construction year from: 11/16 →; Fitting Position: Rear Axle			24.0112-0191.1 412191	Outer diameter [mm]: 305 Brake Disc Thickness [mm] 12 Minimum thickness [mm] 10 Brake Disc Type: Solid Supplementary Article/Info 2: with bolts/screws		
2.3 CDTI RWD	74 - 05/10→ 120	Fitting Position: Front Axle		24.0128-0252.1 428252	Outer diameter [mm]: 302 Brake Disc Thickness [mm] 28 Minimum thickness [mm] 24.5 Brake Disc Type: Vented Supplementary Article/Info 2: with bolts/screws			
		Tyres: for single tyres; Fitting Position: Rear Axle			24.0112-0190.1 412190	Outer diameter [mm]: 305 Brake Disc Thickness [mm] 12 Minimum thickness [mm] 10 Brake Disc Type: Solid Supplementary Article/Info 2: with bolts/screws		
		Tyres: for dual tyres; Fitting Position: Rear Axle				24.0118-0153.1 418153	Outer diameter [mm]: 302 Brake Disc Thickness [mm] 18 Minimum thickness [mm] 15 Brake Disc Type: Solid	
2.3 CDTI RWD	96 10/16→	Construction year from: 11/16 →; Fitting Position: Front Axle		24.0128-0252.1 428252	Outer diameter [mm]: 302 Brake Disc Thickness [mm] 28 Minimum thickness [mm] 24.5 Brake Disc Type: Vented Supplementary Article/Info 2: with bolts/screws			
		Construction year from: 11/16 →; Tyres: for single tyres; Fitting Position: Rear Axle			24.0112-0190.1 412190	Outer diameter [mm]: 305 Brake Disc Thickness [mm] 12 Minimum thickness [mm] 10 Brake Disc Type: Solid Supplementary Article/Info 2: with bolts/screws		
		Construction year from: 11/16 →; Tyres: for dual tyres; Fitting Position: Rear Axle				24.0118-0153.1 418153	Outer diameter [mm]: 302 Brake Disc Thickness [mm] 18 Minimum thickness [mm] 15 Brake Disc Type: Solid	
VAUXHALL - MOVANO Mk II (B) Combi (X62) 05/10→								
 Brake Caliper								
2.3 CDTI FWD	74 - 05/10→ 125	Fitting Position: Front Axle Left		24.3481-1821.5 241355	Brake System: Brembo Supplementary Article/Supplementary Info: without holder Brake Caliper Type: Fist-type Caliper (2 pistons)			
		Fitting Position: Front Axle Right			24.3481-1822.5 241356	Brake System: Brembo Supplementary Article/Supplementary Info: without holder Brake Caliper Type: Fist-type Caliper (2 pistons)		
		Tyres: for single tyres; Fitting Position: Rear Axle Left			24.3484-1703.5 241303	Brake System: Bosch Supplementary Article/Supplementary Info: without holder Brake Caliper Type: Fist-type Caliper		
		Tyres: for single tyres; Fitting Position: Rear Axle Right				24.3484-1704.5 241304	Brake System: Bosch Supplementary Article/Supplementary Info: without holder Brake Caliper Type: Fist-type Caliper	
 Brake Disc								
2.3 CDTI FWD	74 - 05/10→ 125	Fitting Position: Front Axle		24.0128-0252.1 428252	Outer diameter [mm]: 302 Brake Disc Thickness [mm] 28 Minimum thickness [mm] 24.5 Brake Disc Type: Vented Supplementary Article/Info 2: with bolts/screws			
→								

	kW				
VAUXHALL - MOVANO Mk II (B) Combi (X62) 05/10→					
 Brake Disc					
2.3 CDTI FWD	74 - 05/10→ 125	Fitting Position: Rear Axle	24.0112-0191.1 412191	Outer diameter [mm]: 305 Brake Disc Thickness [mm] 12 Minimum thickness [mm] 10 Brake Disc Type: Solid Supplementary Article/Info 2: with bolts/screws	
VAUXHALL - MOVANO Mk II (B) VAN (X62) 05/10→					
 Brake Caliper					
2.3 CDTI FWD	74 - 05/10→ 132	Fitting Position: Front Axle Left	24.3481-1821.5 241355	Brake System: Brembo Supplementary Article/Supplementary Info: without holder Brake Caliper Type: Fist-type Caliper (2 pistons)	
2.3 CDTI RWD	74 - 05/10→ 120	Fitting Position: Front Axle Right	24.3481-1822.5 241356	Brake System: Brembo Supplementary Article/Supplementary Info: without holder Brake Caliper Type: Fist-type Caliper (2 pistons)	
		Tyres: for single tyres; Fitting Position: Rear Axle Left	24.3484-1703.5 241303	Brake System: Bosch Supplementary Article/Supplementary Info: without holder Brake Caliper Type: Fist-type Caliper	
		Tyres: for single tyres; Fitting Position: Rear Axle Right	24.3484-1704.5 241304	Brake System: Bosch Supplementary Article/Supplementary Info: without holder Brake Caliper Type: Fist-type Caliper	
2.3 CDTI FWD	81 02/12→	Fitting Position: Front Axle Left	24.3481-1821.5 241355	Brake System: Brembo Supplementary Article/Supplementary Info: without holder Brake Caliper Type: Fist-type Caliper (2 pistons)	
		Fitting Position: Front Axle Right	24.3481-1822.5 241356	Brake System: Brembo Supplementary Article/Supplementary Info: without holder Brake Caliper Type: Fist-type Caliper (2 pistons)	
		Construction year from: 05/14 →; Tyres: for single tyres; Fitting Position: Rear Axle Left	24.3484-1703.5 241303	Brake System: Bosch Supplementary Article/Supplementary Info: without holder Brake Caliper Type: Fist-type Caliper	
		Construction year from: 05/14 →; Tyres: for single tyres; Fitting Position: Rear Axle Right	24.3484-1704.5 241304	Brake System: Bosch Supplementary Article/Supplementary Info: without holder Brake Caliper Type: Fist-type Caliper	
2.3 CDTI FWD	96 10/16→	Fitting Position: Front Axle Left	24.3481-1821.5 241355	Brake System: Brembo Supplementary Article/Supplementary Info: without holder Brake Caliper Type: Fist-type Caliper (2 pistons)	
2.3 CDTI RWD	96 10/16→	Fitting Position: Front Axle Right	24.3481-1822.5 241356	Brake System: Brembo Supplementary Article/Supplementary Info: without holder Brake Caliper Type: Fist-type Caliper (2 pistons)	
		Construction year from: 11/16 →; Tyres: for single tyres; Fitting Position: Rear Axle Left	24.3484-1703.5 241303	Brake System: Bosch Supplementary Article/Supplementary Info: without holder Brake Caliper Type: Fist-type Caliper	
		Construction year from: 11/16 →; Tyres: for single tyres; Fitting Position: Rear Axle Right	24.3484-1704.5 241304	Brake System: Bosch Supplementary Article/Supplementary Info: without holder Brake Caliper Type: Fist-type Caliper	
 Brake Disc					
2.3 CDTI FWD	74 - 05/10→ 132	Fitting Position: Front Axle	24.0128-0252.1 428252	Outer diameter [mm]: 302 Brake Disc Thickness [mm] 28 Minimum thickness [mm] 24.5 Brake Disc Type: Vented Supplementary Article/Info 2: with bolts/screws	
→					

	kW				
VAUXHALL - MOVANO Mk II (B) VAN (X62) 05/10→					
Brake Disc					
2.3 CDTI FWD	74 - 05/10→ 132		Fitting Position: Rear Axle	24.0112-0191.1 412191	Outer diameter [mm]: 305 Brake Disc Thickness [mm] 12 Minimum thickness [mm] 10 Brake Disc Type: Solid Supplementary Article/Info 2: with bolts/screws
2.3 CDTI FWD	81 02/12→		Construction year from: 05/14 →; Fitting Position: Front Axle	24.0128-0252.1 428252	Outer diameter [mm]: 302 Brake Disc Thickness [mm] 28 Minimum thickness [mm] 24.5 Brake Disc Type: Vented Supplementary Article/Info 2: with bolts/screws
			Construction year from: 05/14 →; Fitting Position: Rear Axle	24.0112-0191.1 412191	Outer diameter [mm]: 305 Brake Disc Thickness [mm] 12 Minimum thickness [mm] 10 Brake Disc Type: Solid Supplementary Article/Info 2: with bolts/screws
2.3 CDTI FWD	96 10/16→		Construction year from: 11/16 →; Fitting Position: Front Axle	24.0128-0252.1 428252	Outer diameter [mm]: 302 Brake Disc Thickness [mm] 28 Minimum thickness [mm] 24.5 Brake Disc Type: Vented Supplementary Article/Info 2: with bolts/screws
			Construction year from: 11/16 →; Fitting Position: Rear Axle	24.0112-0191.1 412191	Outer diameter [mm]: 305 Brake Disc Thickness [mm] 12 Minimum thickness [mm] 10 Brake Disc Type: Solid Supplementary Article/Info 2: with bolts/screws
2.3 CDTI RWD	74 - 05/10→ 120		Fitting Position: Front Axle	24.0128-0252.1 428252	Outer diameter [mm]: 302 Brake Disc Thickness [mm] 28 Minimum thickness [mm] 24.5 Brake Disc Type: Vented Supplementary Article/Info 2: with bolts/screws
			Tyres: for single tyres; Fitting Position: Rear Axle	24.0112-0190.1 412190	Outer diameter [mm]: 305 Brake Disc Thickness [mm] 12 Minimum thickness [mm] 10 Brake Disc Type: Solid Supplementary Article/Info 2: with bolts/screws
			Tyres: for dual tyres; Fitting Position: Rear Axle	24.0118-0153.1 418153	Outer diameter [mm]: 302 Brake Disc Thickness [mm] 18 Minimum thickness [mm] 15 Brake Disc Type: Solid
2.3 CDTI RWD	96 10/16→		Construction year from: 11/16 →; Fitting Position: Front Axle	24.0128-0252.1 428252	Outer diameter [mm]: 302 Brake Disc Thickness [mm] 28 Minimum thickness [mm] 24.5 Brake Disc Type: Vented Supplementary Article/Info 2: with bolts/screws
			Construction year from: 11/16 →; Tyres: for single tyres; Fitting Position: Rear Axle	24.0112-0190.1 412190	Outer diameter [mm]: 305 Brake Disc Thickness [mm] 12 Minimum thickness [mm] 10 Brake Disc Type: Solid Supplementary Article/Info 2: with bolts/screws
			Construction year from: 11/16 →; Tyres: for dual tyres; Fitting Position: Rear Axle	24.0118-0153.1 418153	Outer diameter [mm]: 302 Brake Disc Thickness [mm] 18 Minimum thickness [mm] 15 Brake Disc Type: Solid
VAUXHALL - NOVA Hatchback (S83) 05/83→03/93					
Guide Sleeve Kit, brake caliper					
1.0	33 05/83→03/93		Vehicle Identification Number from:	11.0101-5407.2 260011	Brake System: ATE
1.2	33 09/89→03/93		N4000001 →;		
1.2 N	38 01/90→03/93		→ Construction year to: 10/92;		
1.4 i	44 01/90→03/93		Fitting Position: Front Axle		
1.4 i S	60 09/91→03/93				
1.4 S	55 01/90→03/93				
1.5 D	37 09/87→03/93				
1.5 TD	49 01/90→03/93				
1.6 GSI	72 09/89→03/93				
1.6 GSI Cat	74 02/92→03/93				
1.2 S	40 05/83→02/90		Vehicle Identification Number from:	11.0101-5407.2 260011	Brake System: ATE
1.6 GSI	74 05/88→03/92		N4000001 →; Fitting Position: Front Axle		
→					

	kW				
VAUXHALL - NOVA Hatchback (S83) 05/83→03/93					
Guide Bolt, brake caliper					
1.0	33	05/83→03/93	Vehicle Identification Number from: N4000001 →; → Construction year to: 10/92; Required quantity: 2; Fitting Position: Front Axle	2	11.8171-0008.1 990049 Brake System: ATE
1.2	33	09/89→03/93			
1.2 N	38	01/90→03/93			
1.4 i	44	01/90→03/93			
1.4 i S	60	09/91→03/93			
1.4 S	55	01/90→03/93			
1.5 D	37	09/87→03/93			
1.5 TD	49	01/90→03/93			
1.6 GSI	72	09/89→03/93			
1.6 GSI Cat	74	02/92→03/93			
1.2 S	40	05/83→02/90	Vehicle Identification Number from: N4000001 →; Required quantity: 2; Fitting Position: Front Axle	2	11.8171-0008.1 990049 Brake System: ATE
1.6 GSI	74	05/88→03/92			
VAUXHALL - NOVA Saloon (S83) 09/82→12/93					
Guide Sleeve Kit, brake caliper					
1.0	33	09/82→10/87	Vehicle Identification Number from: N4000001 →; Fitting Position: Front Axle		11.0101-5407.2 260011 Brake System: ATE
1.2	33	02/92→12/93			
1.2 S	40	09/82→10/87			
1.4	44 - 60	09/90→08/92			
1.4 S	55	01/90→02/93	Vehicle Identification Number from: N4000001 →; → Construction year to: 10/92; Fitting Position: Front Axle	2	11.0101-5407.2 260011 Brake System: ATE
1.5 TD	49	01/90→02/93			
Guide Bolt, brake caliper					
1.0	33	09/82→10/87	Vehicle Identification Number from: N4000001 →; Required quantity: 2; Fitting Position: Front Axle	2	11.8171-0008.1 990049 Brake System: ATE
1.2	33	02/92→12/93			
1.2 S	40	09/82→10/87			
1.4	44 - 60	09/90→08/92			
1.4 S	55	01/90→02/93	Vehicle Identification Number from: N4000001 →; → Construction year to: 10/92; Required quantity: 2; Fitting Position: Front Axle	2	11.8171-0008.1 990049 Brake System: ATE
1.5 TD	49	01/90→02/93			
VAUXHALL - NOVAVAN Hatchback Van (S83) 01/90→10/94					
Guide Sleeve Kit, brake caliper					
1.2	38	01/90→10/94	Vehicle Identification Number from: N4000001 →; → Construction year to: 10/92; Fitting Position: Front Axle		11.0101-5407.2 260011 Brake System: ATE
1.4	55	11/90→03/93			
1.5 D	37	01/91→10/94			
Guide Bolt, brake caliper					
1.2	38	01/90→10/94	Vehicle Identification Number from: N4000001 →; → Construction year to: 10/92; Required quantity: 2; Fitting Position: Front Axle	2	11.8171-0008.1 990049 Brake System: ATE
1.4	55	11/90→03/93			
1.5 D	37	01/91→10/94			
VAUXHALL - OMEGA (B) Estate (V94) 12/93→06/03					
Guide Sleeve Kit, brake caliper					
2.0	85	03/94→09/99	→ Vehicle Identification Number to: V1999999; Special Purpose Vehicle: not for special-purpose vehicles / not for police vehicles; Fitting Position: Front Axle		11.0101-5407.2 260011 Brake System: ATE
2.0 16V	100	03/94→07/01			
2.0 Dualfuel	100	01/99→07/01			
Guide Bolt, brake caliper					
2.0	85	03/94→09/99	→ Vehicle Identification Number to: V1999999; Special Purpose Vehicle: not for special-purpose vehicles / not for police vehicles; Required quantity: 2; Fitting Position: Front Axle	2	11.8171-0008.1 990049 Brake System: ATE
2.0 16V	100	03/94→07/01			
2.0 Dualfuel	100	01/99→07/01			
VAUXHALL - OMEGA (B) Saloon (V94) 12/93→07/03					
Guide Sleeve Kit, brake caliper					
2.0	85	03/94→09/99	→ Vehicle Identification Number to: V1999999; Special Purpose Vehicle: not for special-purpose vehicles / not for police vehicles; Fitting Position: Front Axle		11.0101-5407.2 260011 Brake System: ATE
2.0 16V	100	03/94→07/01			
2.0 Dualfuel	100	05/98→07/01			
→					

	kW				
VAUXHALL - OMEGA (B) Saloon (V94) 12/93→07/03					
Guide Bolt, brake caliper					
2.0 2.0 16V 2.0 Dualfuel	85 03/94→09/99 100 03/94→07/01 100 05/98→07/01	→ Vehicle Identification Number to: V1999999; Special Purpose Vehicle: not for special- purpose vehicles / not for police vehicles; Required quantity: 2; Fitting Position: Front Axle	2	11.8171-0008.1 990049	Brake System: ATE
VAUXHALL - ROYALE 02/78→08/87					
Guide Sleeve Kit, brake caliper					
3.0	132 10/79→10/82	Vehicle Identification Number from: E1019586 →; Fitting Position: Front Axle		11.0101-5407.2 260011	Brake System: ATE
Guide Bolt, brake caliper					
3.0	132 10/79→10/82	Vehicle Identification Number from: E1019586 →; Required quantity: 2	2	11.8171-0008.1 990049	Brake System: ATE
VAUXHALL - ROYALE Coupe 02/78→08/86					
Guide Sleeve Kit, brake caliper					
3.0	132 10/79→10/82	Vehicle Identification Number from: E1019586 →; Fitting Position: Front Axle		11.0101-5407.2 260011	Brake System: ATE
Guide Bolt, brake caliper					
3.0	132 10/79→10/82	Vehicle Identification Number from: E1019586 →; Required quantity: 2	2	11.8171-0008.1 990049	Brake System: ATE
VAUXHALL - SENATOR 02/78→08/87					
Guide Sleeve Kit, brake caliper					
2.0 E	85 03/83→10/84	Vehicle Identification Number from: E1019586 →; Vehicle Equipment: for vehicles with air conditioning; Fitting Position: Front Axle		11.0101-5407.2 260011	Brake System: ATE
2.2 E 2.2 TD	85 11/84→08/87 63 11/84→08/87	Fitting Position: Front Axle		11.0101-5407.2 260011	Brake System: ATE
2.5 2.5 i 3.0 3.0 i	85 05/78→12/80 103 09/84→08/87 110 - 04/78→08/87 115 132 09/84→12/86	Vehicle Identification Number from: E1019586 →; Fitting Position: Front Axle		11.0101-5407.2 260011	Brake System: ATE
Guide Bolt, brake caliper					
2.0 E	85 03/83→10/84	Vehicle Identification Number from: E1019586 →; Vehicle Equipment: for vehicles with air conditioning; Required quantity: 2	2	11.8171-0008.1 990049	Brake System: ATE
2.2 E 2.2 TD	85 11/84→08/87 63 11/84→08/87	Required quantity: 2	2	11.8171-0008.1 990049	Brake System: ATE
2.5 2.5 i 3.0 3.0 i	85 05/78→12/80 103 09/84→08/87 110 - 04/78→08/87 115 132 09/84→12/86	Vehicle Identification Number from: E1019586 →; Required quantity: 2	2	11.8171-0008.1 990049	Brake System: ATE
VAUXHALL - SENATOR Mk II (B) (V88) 09/87→09/93					
Guide Sleeve Kit, brake caliper					
2.5 i	103 09/87→10/90	Construction year from: 09/90 →; → Vehicle Identification Number to: L1999999; Fitting Position: Front Axle		11.0101-5407.2 260011	Brake System: ATE
2.6 i 3.0 3.0 i Cat	110 09/90→09/93 130 01/88→09/90 130 01/88→09/93	→ Vehicle Identification Number to: L1999999; Fitting Position: Front Axle		11.0101-5407.2 260011	Brake System: ATE
Guide Bolt, brake caliper					
2.5 i	103 09/87→10/90	Construction year from: 09/90 →; → Vehicle Identification Number to: L1999999; Required quantity: 2; Fitting Position: Front Axle	2	11.8171-0008.1 990049	Brake System: ATE
2.6 i 3.0 3.0 i Cat	110 09/90→09/93 130 01/88→09/90 130 01/88→09/93	→ Vehicle Identification Number to: L1999999; Required quantity: 2; Fitting Position: Front Axle	2	11.8171-0008.1 990049	Brake System: ATE
VAUXHALL - SIGNUM (Z03) 03/03→10/08					
Spring, brake caliper					
1.8 1.9 CDTI 1.9 CDTI 16V 2.2 DTI →	90 06/03→07/05 88 04/04→03/08 110 04/04→03/08 92 05/03→05/08	Suspension: for vehicles without sports suspension; Required quantity: 2; Brake Caliper Type: Cast iron brake caliper; Fitting Position: Front Axle	2	11.8116-0356.1 390586	Brake System: ATE

	kW				
VAUXHALL - SIGNUM (Z03) 03/03→10/08					
Spring, brake caliper					
2.2 i	114	05/03→05/08	Vehicle Identification Number from: 51066207 →; Suspension: for vehicles with sports suspension; Required quantity: 2; Fitting Position: Front Axle	2	11.8116-0356.1 390586 Brake System: ATE
1.8	103	08/05→05/08	Construction year from: 09/05 →; Required quantity: 2; Fitting Position: Front Axle	2	11.8116-0356.1 390586 Brake System: ATE
2.0 DTI	74	05/03→04/04	Suspension: for vehicles without sports suspension; Required quantity: 2; Brake Caliper Type: Cast iron brake caliper; Fitting Position: Front Axle	2	11.8116-0356.1 390586 Brake System: ATE
2.0 i Turbo	129	03/03→10/08	Vehicle Identification Number from: 51066207 →; → Construction year to: 05/08; Required quantity: 2; Fitting Position: Front Axle	2	11.8116-0356.1 390586 Brake System: ATE
Guide Sleeve Kit, brake caliper					
1.8	90	06/03→07/05	Suspension: for vehicles without sports suspension; Fitting Position: Front Axle		11.0101-5407.2 260011 Brake System: ATE
1.9 CDTI	88	04/04→03/08			
1.9 CDTI 16V	110	04/04→03/08	→ Vehicle Identification Number to: 51066206;		11.0101-5407.2 260011 Brake System: ATE
2.2 DTI	92	05/03→05/08	Suspension: for vehicles with sports suspension; Fitting Position: Front Axle		
2.2 i	114	05/03→05/08	Vehicle Identification Number from: 51066207 →; Suspension: for vehicles with sports suspension; Fitting Position: Front Axle		11.0101-5407.2 260011 Brake System: ATE
			→ Vehicle Identification Number to: 41085480; Fitting Position: Rear Axle		11.0101-5407.2 260011 Brake System: ATE
			Vehicle Identification Number from: 41085481 →; Fitting Position: Rear Axle		11.0101-5407.2 260011 Brake System: ATE
1.8	103	08/05→05/08	Construction year from: 09/05 →; Fitting Position: Front Axle		11.0101-5407.2 260011 Brake System: ATE
2.8 V6 Turbo	169	07/05→05/08	Construction year from: 09/05 →; Fitting Position: Rear Axle		11.0101-5407.2 260011 Brake System: ATE
2.0 DTI	74	05/03→04/04	Suspension: for vehicles without sports suspension; Fitting Position: Front Axle		11.0101-5407.2 260011 Brake System: ATE
			Vehicle Identification Number from: 41085481 →; Fitting Position: Rear Axle		11.0101-5407.2 260011 Brake System: ATE
			→ Vehicle Identification Number to: 41085480; Fitting Position: Rear Axle		11.0101-5407.2 260011 Brake System: ATE
2.0 i Turbo	129	03/03→10/08	Construction year from: 05/03 →; → Vehicle Identification Number to: 51066206; Fitting Position: Front Axle		11.0101-5407.2 260011 Brake System: ATE
			Vehicle Identification Number from: 51066207 →; → Construction year to: 05/08; Fitting Position: Front Axle		11.0101-5407.2 260011 Brake System: ATE
			Construction year from: 05/03 →; → Vehicle Identification Number to: 41085480; Fitting Position: Rear Axle		11.0101-5407.2 260011 Brake System: ATE
			Vehicle Identification Number from: 41085481 →; → Construction year to: 05/08; Fitting Position: Rear Axle		11.0101-5407.2 260011 Brake System: ATE
2.8 V6 Turbo	184	05/07→10/08	→ Construction year to: 05/08; Fitting Position: Front Axle		11.0101-5407.2 260011 Brake System: ATE
			→ Construction year to: 05/08; Fitting Position: Rear Axle		11.0101-5407.2 260011 Brake System: ATE
3.0 CDTi	130	05/03→05/08	Vehicle Identification Number from: 31068239 → → Vehicle Identification Number to: 51999999;		11.0101-5407.2 260011 Brake System: ATE
3.2 V6	155	05/03→05/08	Fitting Position: Front Axle		
			→ Vehicle Identification Number to: 31068238; Fitting Position: Front Axle		11.0101-5407.2 260011 Brake System: ATE
			→ Vehicle Identification Number to: 41085480; Fitting Position: Rear Axle		11.0101-5407.2 260011 Brake System: ATE
			Vehicle Identification Number from: 41085481 →; Fitting Position: Rear Axle		11.0101-5407.2 260011 Brake System: ATE
3.0 V6 CDTI	135	07/05→06/08	Construction year from: 09/05 → → Construction year to: 05/08; Fitting Position: Front Axle		11.0101-5407.2 260011 Brake System: ATE
			Construction year from: 09/05 → → Construction year to: 05/08; Fitting Position: Rear Axle		11.0101-5407.2 260011 Brake System: ATE
→					

	kW				
VAUXHALL - SIGNUM (Z03) 03/03→10/08					
Guide Bolt, brake caliper					
1.8	90	06/03→07/05	Vehicle Identification Number from: 41085481 →; Required quantity: 2	2	11.8171-0008.1 990049 Brake System: ATE
1.9 CDTI	88	04/04→03/08	→ Vehicle Identification Number to: 51066206; Suspension: for vehicles with sports suspension; Required quantity: 2	2	11.8171-0008.1 990049 Brake System: ATE
1.9 CDTI 16V	110	04/04→03/08		2	11.8171-0008.1 990049 Brake System: ATE
2.2 DTI	92	05/03→05/08		2	11.8171-0008.1 990049 Brake System: ATE
2.2 i	114	05/03→05/08		2	11.8171-0008.1 990049 Brake System: ATE
				2	11.8171-0008.1 990049 Brake System: ATE
			Suspension: for vehicles without sports suspension; Required quantity: 2	2	11.8171-0008.1 990049 Brake System: ATE
1.8	103	08/05→05/08	Construction year from: 09/05 →; Required quantity: 2	2	11.8171-0008.1 990049 Brake System: ATE
2.8 V6 Turbo	169	07/05→05/08			
2.0 DTI	74	05/03→04/04	Vehicle Identification Number from: 41085481 →; Required quantity: 2	2	11.8171-0008.1 990049 Brake System: ATE
			→ Vehicle Identification Number to: 41085480; Required quantity: 2	2	11.8171-0008.1 990049 Brake System: ATE
			Suspension: for vehicles without sports suspension; Required quantity: 2	2	11.8171-0008.1 990049 Brake System: ATE
2.0 i Turbo	129	03/03→10/08	Construction year from: 05/03 →; → Vehicle Identification Number to: 41085480; Required quantity: 2	2	11.8171-0008.1 990049 Brake System: ATE
			Construction year from: 05/03 →; → Vehicle Identification Number to: 51066206; Required quantity: 2	2	11.8171-0008.1 990049 Brake System: ATE
			Vehicle Identification Number from: 41085481 →; → Construction year to: 05/08; Required quantity: 2	2	11.8171-0008.1 990049 Brake System: ATE
			Vehicle Identification Number from: 51066207 →; → Construction year to: 05/08; Required quantity: 2	2	11.8171-0008.1 990049 Brake System: ATE
2.8 V6 Turbo	184	05/07→10/08	→ Construction year to: 05/08; Required quantity: 2	2	11.8171-0008.1 990049 Brake System: ATE
3.0 CDTi	130	05/03→05/08	→ Vehicle Identification Number to: 31068238; Required quantity: 2	2	11.8171-0008.1 990049 Brake System: ATE
3.2 V6	155	05/03→05/08	Vehicle Identification Number from: 41085481 →; Required quantity: 2	2	11.8171-0008.1 990049 Brake System: ATE
			Vehicle Identification Number from: 31068239 → → Vehicle Identification Number to: 51999999; Required quantity: 2	2	11.8171-0008.1 990049 Brake System: ATE
			→ Vehicle Identification Number to: 41085480; Required quantity: 2	2	11.8171-0008.1 990049 Brake System: ATE
3.0 V6 CDTI	135	07/05→06/08	Construction year from: 09/05 → → Construction year to: 05/08; Required quantity: 2	2	11.8171-0008.1 990049 Brake System: ATE
VAUXHALL - TIGRA Mk I (S93) 07/94→12/00					
Guide Sleeve Kit, brake caliper					
1.4 16V	66	07/94→12/00	Fitting Position: Front Axle		11.0101-5407.2 260011 Brake System: ATE
1.6 16V	78	07/94→12/00	→ Construction year to: 08/98; Fitting Position: Front Axle		11.0101-5407.2 260011 Brake System: ATE
Guide Bolt, brake caliper					
1.4 16V	66	07/94→12/00	Required quantity: 2; Fitting Position: Front Axle	2	11.8171-0008.1 990049 Brake System: ATE
1.6 16V	78	07/94→12/00	→ Construction year to: 08/98; Required quantity: 2; Fitting Position: Front Axle	2	11.8171-0008.1 990049 Brake System: ATE
VAUXHALL - VECTRA (B) Estate (J96) 08/95→03/02					
Guide Sleeve Kit, brake caliper					
1.8 Dualfuel	92	09/00→03/02	Vehicle Identification Number from: X1000001 →; Fitting Position: Front Axle		11.0101-5407.2 260011 Brake System: ATE
1.8 i 16V	85 - 92	09/96→03/02	→ Vehicle Identification Number to: W7999999; Fitting Position: Front Axle		11.0101-5407.2 260011 Brake System: ATE
2.0 DI 16V	60	08/95→10/01	Vehicle Identification Number from: X1000001 →; Fitting Position: Front Axle		11.0101-5407.2 260011 Brake System: ATE
			Construction year from: 11/96 →; → Vehicle Identification Number to: W7999999; Fitting Position: Front Axle		11.0101-5407.2 260011 Brake System: ATE
→					

	kW				
VAUXHALL - VECTRA (B) Estate (J96) 08/95→03/02					
Guide Sleeve Kit, brake caliper					
2.0 DTI 16V	74	08/95→10/01	Vehicle Identification Number from: X1000001 →; Fitting Position: Front Axle	11.0101-5407.2 260011	Brake System: ATE
			Construction year from: 06/97 →; → Vehicle Identification Number to: W7999999; Fitting Position: Front Axle	11.0101-5407.2 260011	Brake System: ATE
2.0 Dualfuel	100	10/98→01/01	Fitting Position: Front Axle	11.0101-5407.2 260011	Brake System: ATE
2.0 i 16V	100	10/95→01/01			
2.5 i GSi	143	05/98→09/99			
2.5 i V6	125	11/96→08/00			
2.6 i V6	125	09/00→03/02			
2.2 DTI 16V	92	08/95→10/01	Construction year from: 09/00 →; Fitting Position: Front Axle	11.0101-5407.2 260011	Brake System: ATE
2.2 i 16V	108	08/95→10/01			
Guide Bolt, brake caliper					
1.8 Dualfuel	92	09/00→03/02	→ Vehicle Identification Number to: W7999999; Required quantity: 2	2 11.8171-0008.1 990049	Brake System: ATE
1.8 i 16V	85 - 92	09/96→03/02	Vehicle Identification Number from: X1000001 →; Required quantity: 2; Fitting Position: Front Axle	2 11.8171-0008.1 990049	Brake System: ATE
2.0 DI 16V	60	08/95→10/01	Construction year from: 11/96 →; → Vehicle Identification Number to: W7999999; Required quantity: 2	2 11.8171-0008.1 990049	Brake System: ATE
			Vehicle Identification Number from: X1000001 →; Required quantity: 2; Fitting Position: Front Axle	2 11.8171-0008.1 990049	Brake System: ATE
2.0 DTI 16V	74	08/95→10/01	Construction year from: 06/97 →; → Vehicle Identification Number to: W7999999; Required quantity: 2	2 11.8171-0008.1 990049	Brake System: ATE
			Vehicle Identification Number from: X1000001 →; Required quantity: 2; Fitting Position: Front Axle	2 11.8171-0008.1 990049	Brake System: ATE
2.0 Dualfuel	100	10/98→01/01	Required quantity: 2; Fitting Position: Front Axle	2 11.8171-0008.1 990049	Brake System: ATE
2.0 i 16V	100	10/95→01/01			
2.5 i GSi	143	05/98→09/99			
2.5 i V6	125	11/96→08/00			
2.6 i V6	125	09/00→03/02			
2.2 DTI 16V	92	08/95→10/01	Construction year from: 09/00 →; Required quantity: 2; Fitting Position: Front Axle	2 11.8171-0008.1 990049	Brake System: ATE
2.2 i 16V	108	08/95→10/01			
VAUXHALL - VECTRA (B) Hatchback (J96) 08/95→07/03					
Guide Sleeve Kit, brake caliper					
1.6 i	55	08/95→10/01	Vehicle Identification Number from: X1000001 →; Fitting Position: Front Axle	11.0101-5407.2 260011	Brake System: ATE
1.6 i 16V	74	08/95→10/01	Construction year from: 09/95 →; → Vehicle Identification Number to: W7999999; Fitting Position: Front Axle	11.0101-5407.2 260011	Brake System: ATE
1.7 TD	60	10/95→11/96	Fitting Position: Front Axle	11.0101-5407.2 260011	Brake System: ATE
2.0 Dualfuel	100	08/98→01/01			
2.0 i 16V	100	10/95→01/01			
2.5 i GSi	143	03/98→07/00			
2.5 i V6	125	09/95→08/00			
1.8 Dualfuel	92	09/00→07/03	Vehicle Identification Number from: X1000001 →; → Construction year to: 04/02; Fitting Position: Front Axle	11.0101-5407.2 260011	Brake System: ATE
1.8 i 16V	92	09/00→07/03	→ Vehicle Identification Number to: W7999999; Fitting Position: Front Axle	11.0101-5407.2 260011	Brake System: ATE
1.8 i 16V	85	09/95→09/00	Vehicle Identification Number from: X1000001 →; Fitting Position: Front Axle	11.0101-5407.2 260011	Brake System: ATE
2.0 DTi 16V	74	06/97→10/01	→ Vehicle Identification Number to: W7999999; Fitting Position: Front Axle	11.0101-5407.2 260011	Brake System: ATE
2.0 Di 16V	60	08/95→10/01	Vehicle Identification Number from: X1000001 →; Fitting Position: Front Axle	11.0101-5407.2 260011	Brake System: ATE
			Construction year from: 11/96 →; → Vehicle Identification Number to: W7999999; Fitting Position: Front Axle	11.0101-5407.2 260011	Brake System: ATE
2.2 DTI 16V	92	08/95→10/01	Construction year from: 09/00 →; Fitting Position: Front Axle	11.0101-5407.2 260011	Brake System: ATE
2.2 i 16V	108	09/00→07/03	→ Construction year to: 04/02; Fitting Position: Front Axle	11.0101-5407.2 260011	Brake System: ATE
2.6 i V6	125	09/00→07/03			
Guide Bolt, brake caliper					
1.6 i	55	08/95→10/01	Construction year from: 09/95 →; → Vehicle Identification Number to: W7999999; Required quantity: 2	2 11.8171-0008.1 990049	Brake System: ATE
1.6 i 16V	74	08/95→10/01			
→					

	kW				
VAUXHALL - VECTRA (B) Hatchback (J96) 08/95→07/03					
Guide Bolt, brake caliper					
1.6 i 1.6 i 16V	55 08/95→10/01 74 08/95→10/01	Vehicle Identification Number from: X1000001 →; Required quantity: 2; Fitting Position: Front Axle	2	11.8171-0008.1 990049	Brake System: ATE
1.7 TD	60 10/95→11/96	Required quantity: 2	2	11.8171-0008.1 990049	Brake System: ATE
1.8 Dualfuel 1.8 i 16V	92 09/00→07/03 92 09/00→07/03	→ Vehicle Identification Number to: W7999999; Required quantity: 2	2	11.8171-0008.1 990049	Brake System: ATE
		Vehicle Identification Number from: X1000001 →; → Construction year to: 04/02; Required quantity: 2; Fitting Position: Front Axle	2	11.8171-0008.1 990049	Brake System: ATE
1.8 i 16V 2.0 DTi 16V	85 09/95→09/00 74 06/97→10/01	→ Vehicle Identification Number to: W7999999; Required quantity: 2	2	11.8171-0008.1 990049	Brake System: ATE
		Vehicle Identification Number from: X1000001 →; Required quantity: 2; Fitting Position: Front Axle	2	11.8171-0008.1 990049	Brake System: ATE
2.0 Di 16V	60 08/95→10/01	Construction year from: 11/96 →; → Vehicle Identification Number to: W7999999; Required quantity: 2	2	11.8171-0008.1 990049	Brake System: ATE
		Vehicle Identification Number from: X1000001 →; Required quantity: 2; Fitting Position: Front Axle	2	11.8171-0008.1 990049	Brake System: ATE
2.0 Dualfuel 2.0 i 16V 2.5 i GSi 2.5 i V6	100 08/98→01/01 100 10/95→01/01 143 03/98→07/00 125 09/95→08/00	Required quantity: 2; Fitting Position: Front Axle	2	11.8171-0008.1 990049	Brake System: ATE
2.2 DTi 16V	92 08/95→10/01	Construction year from: 09/00 →; Required quantity: 2; Fitting Position: Front Axle	2	11.8171-0008.1 990049	Brake System: ATE
2.2 i 16V 2.6 i V6	108 09/00→07/03 125 09/00→07/03	→ Construction year to: 04/02; Required quantity: 2; Fitting Position: Front Axle	2	11.8171-0008.1 990049	Brake System: ATE
VAUXHALL - VECTRA (B) Saloon (J96) 08/95→03/02					
Guide Sleeve Kit, brake caliper					
1.6 i 1.6 i 16V	55 08/95→10/01 74 08/95→10/01	Vehicle Identification Number from: X1000001 →; Fitting Position: Front Axle		11.0101-5407.2 260011	Brake System: ATE
		Construction year from: 09/95 →; → Vehicle Identification Number to: W7999999; Fitting Position: Front Axle		11.0101-5407.2 260011	Brake System: ATE
1.7 TD 2.0 Dualfuel 2.0 i 16V 2.5 i GSi 2.5 i V6 2.6 i V6	60 10/95→11/96 100 05/98→01/01 100 10/95→01/01 143 03/98→07/00 125 09/95→08/00 125 09/00→03/02	Fitting Position: Front Axle		11.0101-5407.2 260011	Brake System: ATE
1.8 Dualfuel 1.8 i 16V	92 09/00→03/02 85 - 10/95→03/02	Vehicle Identification Number from: X1000001 →; Fitting Position: Front Axle		11.0101-5407.2 260011	Brake System: ATE
	92	→ Vehicle Identification Number to: W7999999; Fitting Position: Front Axle		11.0101-5407.2 260011	Brake System: ATE
2.0 DI 16V	60 08/95→10/01	Vehicle Identification Number from: X1000001 →; Fitting Position: Front Axle		11.0101-5407.2 260011	Brake System: ATE
		Construction year from: 11/96 →; → Vehicle Identification Number to: W7999999; Fitting Position: Front Axle		11.0101-5407.2 260011	Brake System: ATE
2.0 DTi 16V	74 08/95→10/01	Vehicle Identification Number from: X1000001 →; Fitting Position: Front Axle		11.0101-5407.2 260011	Brake System: ATE
		Construction year from: 06/97 →; → Vehicle Identification Number to: W7999999; Fitting Position: Front Axle		11.0101-5407.2 260011	Brake System: ATE
2.2 DTi 16V 2.2 i 16V	92 08/95→10/01 108 08/95→10/01	Construction year from: 09/00 →; Fitting Position: Front Axle		11.0101-5407.2 260011	Brake System: ATE
Guide Bolt, brake caliper					
1.6 i 1.6 i 16V	55 08/95→10/01 74 08/95→10/01	Construction year from: 09/95 →; → Vehicle Identification Number to: W7999999; Required quantity: 2	2	11.8171-0008.1 990049	Brake System: ATE
		Vehicle Identification Number from: X1000001 →; Required quantity: 2; Fitting Position: Front Axle	2	11.8171-0008.1 990049	Brake System: ATE
1.7 TD	60 10/95→11/96	Required quantity: 2	2	11.8171-0008.1 990049	Brake System: ATE
1.8 Dualfuel 1.8 i 16V	92 09/00→03/02 85 - 10/95→03/02	→ Vehicle Identification Number to: W7999999; Required quantity: 2	2	11.8171-0008.1 990049	Brake System: ATE
	92	Vehicle Identification Number from: X1000001 →; Required quantity: 2; Fitting Position: Front Axle	2	11.8171-0008.1 990049	Brake System: ATE
→					

	kW				
VAUXHALL - VECTRA (B) Saloon (J96) 08/95→03/02					
Guide Bolt, brake caliper					
2.0 DI 16V	60 08/95→10/01	Construction year from: 11/96 →; → Vehicle Identification Number to: W7999999; Required quantity: 2	2	11.8171-0008.1 990049	Brake System: ATE
		Vehicle Identification Number from: X1000001 →; Required quantity: 2; Fitting Position: Front Axle	2	11.8171-0008.1 990049	Brake System: ATE
2.0 DTI 16V	74 08/95→10/01	Construction year from: 06/97 →; → Vehicle Identification Number to: W7999999; Required quantity: 2	2	11.8171-0008.1 990049	Brake System: ATE
		Vehicle Identification Number from: X1000001 →; Required quantity: 2; Fitting Position: Front Axle	2	11.8171-0008.1 990049	Brake System: ATE
2.0 Dualfuel	100 05/98→01/01	Required quantity: 2;	2	11.8171-0008.1 990049	Brake System: ATE
2.0 i 16V	100 10/95→01/01	Fitting Position: Front Axle			
2.5 i GSi	143 03/98→07/00				
2.5 i V6	125 09/95→08/00				
2.6 i V6	125 09/00→03/02				
2.2 DTI 16V	92 08/95→10/01	Construction year from: 09/00 →;	2	11.8171-0008.1 990049	Brake System: ATE
2.2 i 16V	108 08/95→10/01	Required quantity: 2; Fitting Position: Front Axle			
VAUXHALL - VECTRA Mk II (C) (Z02) 01/00→10/08					
Spring, brake caliper					
1.8	103 01/06→07/08	Suspension: for vehicles with sports suspension; Required quantity: 2; Brake Caliper Type: Cast iron brake caliper; Fitting Position: Front Axle	2	11.8116-0356.1 390586	Brake System: ATE
		Suspension: for vehicles with sports suspension; Special Purpose Vehicle: for police vehi- cles; Required quantity: 2; Fitting Position: Front Axle	2	11.8116-0356.1 390586	Brake System: ATE
1.8 16V	90 04/02→07/08	Suspension: for vehicles without sports suspension; Required quantity: 2;	2	11.8116-0356.1 390586	Brake System: ATE
1.8 16V Dualfuel	90 04/02→07/08	Brake Caliper Type: Cast iron brake caliper; Fitting Position: Front Axle			
2.2 DTI 16V	92 04/02→10/08				
1.9 CDTI	88 04/02→09/08	Construction year from: 04/04 →; Required quantity: 2; Brake Caliper Type: Cast iron brake caliper; Fitting Position: Front Axle	2	11.8116-0356.1 390586	Brake System: ATE
1.9 CDTI 16V	110 04/04→08/08	Required quantity: 2;	2	11.8116-0356.1 390586	Brake System: ATE
2.0 DTI 16V	74 04/02→10/08	Brake Caliper Type: Cast iron brake caliper; Fitting Position: Front Axle			
2.2 16V	108 01/02→10/08	Construction year from: 04/02 →; Suspension: for vehicles without sports suspension; Required quantity: 2; Brake Caliper Type: Cast iron brake caliper; Fitting Position: Front Axle	2	11.8116-0356.1 390586	Brake System: ATE
2.2 direct	114 01/02→10/08	Construction year from: 10/03 →; Suspension: for vehicles without sports suspension; Required quantity: 2; Brake Caliper Type: Cast iron brake caliper; Fitting Position: Front Axle	2	11.8116-0356.1 390586	Brake System: ATE
Guide Sleeve Kit, brake caliper					
1.8	103 01/06→07/08	Suspension: for vehicles with sports suspension; Fitting Position: Front Axle		11.0101-5407.2 260011	Brake System: ATE
		Suspension: for vehicles with sports suspension; Special Purpose Vehicle: for police vehi- cles; Fitting Position: Front Axle		11.0101-5407.2 260011	Brake System: ATE
		Brake Disc Type: Solid; Fitting Position: Rear Axle		11.0101-5407.2 260011	Brake System: ATE
		Brake Disc Type: Internally Vented; Fitting Position: Rear Axle		11.0101-5407.2 260011	Brake System: ATE
1.8 16V	90 04/02→07/08	Fitting Position: Front Axle		11.0101-5407.2 260011	Brake System: ATE
1.8 16V Dualfuel	90 04/02→07/08				
1.9 CDTI 16V	110 04/04→08/08	Brake Disc Type: Solid; Fitting Position: Rear Axle		11.0101-5407.2 260011	Brake System: ATE
2.0 DTI 16V	74 04/02→10/08	Brake Disc Type: Vented; Fitting Position: Rear Axle		11.0101-5407.2 260011	Brake System: ATE
2.2 DTI 16V	92 04/02→10/08				
1.9 CDTI	88 04/02→09/08	Construction year from: 04/04 →; Fitting Position: Front Axle		11.0101-5407.2 260011	Brake System: ATE
		Construction year from: 04/04 →; Brake Disc Type: Solid; Fitting Position: Rear Axle		11.0101-5407.2 260011	Brake System: ATE
		Construction year from: 04/04 →; Brake Disc Type: Vented; Fitting Position: Rear Axle		11.0101-5407.2 260011	Brake System: ATE
→					

	kW					
VAUXHALL - VECTRA Mk II (C) (Z02) 01/00→10/08						
Guide Sleeve Kit, brake caliper						
2.0 16V Turbo	129 01/00→10/08	Construction year from: 03/03 →;	Fitting Position: Front Axle	11.0101-5407.2 260011	Brake System: ATE	
		Construction year from: 03/03 →;	Brake Disc Type: Solid;			Fitting Position: Rear Axle
		Construction year from: 03/03 →;	Brake Disc Type: Vented;			Fitting Position: Rear Axle
2.2 16V	108 01/02→10/08	Construction year from: 04/02 →;	Fitting Position: Front Axle	11.0101-5407.2 260011	Brake System: ATE	
		Construction year from: 04/02 →;	Brake Disc Type: Vented;			Fitting Position: Rear Axle
		Construction year from: 04/02 →;	Brake Disc Type: Solid;			Fitting Position: Rear Axle
2.2 direct	114 01/02→10/08	Construction year from: 10/03 →;	Fitting Position: Front Axle	11.0101-5407.2 260011	Brake System: ATE	
		Construction year from: 10/03 →;	Brake Disc Type: Vented;			Fitting Position: Rear Axle
		Construction year from: 10/03 →;	Brake Disc Type: Solid;			Fitting Position: Rear Axle
3.0 CDTi	135 08/05→07/08	Vehicle Identification Number from:	61000001 →; Fitting Position: Front Axle	11.0101-5407.2 260011	Brake System: ATE	
		Brake Disc Type: Solid;	Fitting Position: Rear Axle			
		Brake Disc Type: Internally Vented;	Fitting Position: Rear Axle			
3.0 V6 CDTi	130 06/03→08/05	→ Vehicle Identification Number to:		11.0101-5407.2 260011	Brake System: ATE	
3.2 V6	155 06/03→07/08	31070293; Fitting Position: Front Axle				
		Vehicle Identification Number from:	31070294 →; Fitting Position: Front Axle			
		Brake Disc Type: Solid;	Fitting Position: Rear Axle	11.0101-5407.2 260011	Brake System: ATE	
		Brake Disc Type: Vented;	Fitting Position: Rear Axle	11.0101-5407.2 260011	Brake System: ATE	
Guide Bolt, brake caliper						
1.8	103 01/06→07/08	Brake Disc Type: Solid;	Required quantity: 2	2 11.8171-0008.1 990049	Brake System: ATE	
		Brake Disc Type: Internally Vented;	Required quantity: 2			
		Suspension: for vehicles with sports suspension;	Required quantity: 2			
		Suspension: for vehicles with sports suspension;	Special Purpose Vehicle: for police vehicles; Required quantity: 2			
1.8 16V	90 04/02→07/08	Required quantity: 2		2 11.8171-0008.1 990049	Brake System: ATE	
1.8 16V Dualfuel	90 04/02→07/08	Required quantity: 2		2 11.8171-0008.1 990049	Brake System: ATE	
1.9 CDTi 16V	110 04/04→08/08	Required quantity: 2		2 11.8171-0008.1 990049	Brake System: ATE	
2.0 DTI 16V	74 04/02→10/08	Required quantity: 2		2 11.8171-0008.1 990049	Brake System: ATE	
2.2 DTI 16V	92 04/02→10/08	Required quantity: 2		2 11.8171-0008.1 990049	Brake System: ATE	
1.9 CDTi	88 04/02→09/08	Construction year from: 04/04 →;	Brake Disc Type: Solid;	2 11.8171-0008.1 990049	Brake System: ATE	
		Construction year from: 04/04 →;	Brake Disc Type: Vented;			Required quantity: 2
		Construction year from: 04/04 →;	Required quantity: 2			
2.0 16V Turbo	129 01/00→10/08	Construction year from: 03/03 →;	Brake Disc Type: Solid;	2 11.8171-0008.1 990049	Brake System: ATE	
		Construction year from: 03/03 →;	Brake Disc Type: Vented;			Required quantity: 2
		Construction year from: 03/03 →;	Required quantity: 2			
2.2 16V	108 01/02→10/08	Construction year from: 04/02 →;	Brake Disc Type: Solid;	2 11.8171-0008.1 990049	Brake System: ATE	
		Construction year from: 04/02 →;	Brake Disc Type: Vented;			Required quantity: 2

→





	kW				
VAUXHALL - VECTRA Mk II (C) (Z02) 01/00→10/08					
Guide Bolt, brake caliper					
2.2 16V	108	01/02→10/08	Construction year from: 04/02 →; Required quantity: 2	2	11.8171-0008.1 990049 Brake System: ATE
2.2 direct	114	01/02→10/08	Construction year from: 10/03 →; Brake Disc Type: Solid; Required quantity: 2	2	11.8171-0008.1 990049 Brake System: ATE
			Construction year from: 10/03 →; Brake Disc Type: Vented; Required quantity: 2	2	11.8171-0008.1 990049 Brake System: ATE
			Construction year from: 10/03 →; Required quantity: 2	2	11.8171-0008.1 990049 Brake System: ATE
3.0 CDTi	135	08/05→07/08	Brake Disc Type: Solid; Required quantity: 2	2	11.8171-0008.1 990049 Brake System: ATE
			Brake Disc Type: Internally Vented; Required quantity: 2	2	11.8171-0008.1 990049 Brake System: ATE
			Vehicle Identification Number from: 61000001 →; Required quantity: 2	2	11.8171-0008.1 990049 Brake System: ATE
3.0 V6 CDTI 3.2 V6	130	06/03→08/05	Brake Disc Type: Solid; Required quantity: 2	2	11.8171-0008.1 990049 Brake System: ATE
	155	06/03→07/08	Brake Disc Type: Vented; Required quantity: 2	2	11.8171-0008.1 990049 Brake System: ATE
			→ Vehicle Identification Number to: 31070293; Required quantity: 2	2	11.8171-0008.1 990049 Brake System: ATE
			Vehicle Identification Number from: 31070294 →; Required quantity: 2	2	11.8171-0008.1 990049 Brake System: ATE
VAUXHALL - VECTRA Mk II (C) Estate (Z02) 10/03→05/09					
Spring, brake caliper					
1.8	103	01/06→07/08	Suspension: for vehicles with sports suspension; Special Purpose Vehicle: for police vehi- cles; Required quantity: 2	2	11.8116-0356.1 390586 Brake System: ATE
			Suspension: for vehicles with sports suspension; Special Purpose Vehicle: not for police vehicles; Required quantity: 2; Brake Caliper Type: Cast iron brake caliper; Fitting Position: Front Axle	2	11.8116-0356.1 390586 Brake System: ATE
1.8 16V	90	10/03→08/05	Suspension: for vehicles without sports suspension; Required quantity: 2; Brake Caliper Type: Cast iron brake caliper; Fitting Position: Front Axle	2	11.8116-0356.1 390586 Brake System: ATE
2.2 direct	114	10/03→07/08			
2.2 DTI 16V	92	10/03→07/08			
1.9 CDTI	88	04/04→07/08	Suspension: for vehicles with sports suspension; Special Purpose Vehicle: for police vehi- cles; Required quantity: 2	2	11.8116-0356.1 390586 Brake System: ATE
			Suspension: for vehicles without sports suspension; Special Purpose Vehicle: not for police vehicles; Required quantity: 2; Brake Caliper Type: Cast iron brake caliper; Fitting Position: Front Axle	2	11.8116-0356.1 390586 Brake System: ATE
1.9 CDTI 16V	110	04/04→05/09	→ Construction year to: 10/08; Required quantity: 2; Brake Caliper Type: Cast iron brake caliper; Fitting Position: Front Axle	2	11.8116-0356.1 390586 Brake System: ATE
2.0 DTI 16V	74	10/03→07/08	Required quantity: 2; Brake Caliper Type: Cast iron brake caliper; Fitting Position: Front Axle	2	11.8116-0356.1 390586 Brake System: ATE
Guide Sleeve Kit, brake caliper					
1.8	103	01/06→07/08	Suspension: for vehicles with sports suspension; Special Purpose Vehicle: for police vehi- cles; Fitting Position: Front Axle		11.0101-5407.2 260011 Brake System: ATE
			Suspension: for vehicles with sports suspension; Special Purpose Vehicle: not for police vehicles; Fitting Position: Front Axle		11.0101-5407.2 260011 Brake System: ATE
			Vehicle Identification Number from: 41085481 →; Fitting Position: Rear Axle		11.0101-5407.2 260011 Brake System: ATE
			Brake Disc Type: Solid; → Vehicle Identification Number to: 41085480; Fitting Position: Rear Axle		11.0101-5407.2 260011 Brake System: ATE
			→ Vehicle Identification Number to: 41085480; Brake Disc Type: Internally Vented; Fitting Position: Rear Axle		11.0101-5407.2 260011 Brake System: ATE
→					





	kW				
VAUXHALL - VECTRA Mk II (C) Estate (Z02) 10/03→05/09					
Guide Sleeve Kit, brake caliper					
1.8 16V	90	10/03→08/05	Fitting Position: Front Axle	11.0101-5407.2 260011	Brake System: ATE
2.0 16V Turbo	129	10/03→07/08	Vehicle Identification Number from: 41085481 →; Fitting Position: Rear Axle	11.0101-5407.2 260011	Brake System: ATE
2.0 DTI 16V	74	10/03→07/08		11.0101-5407.2 260011	Brake System: ATE
2.2 direct	114	10/03→07/08	Brake Disc Type: Solid; → Vehicle Identification Number to: 41085480; Fitting Position: Rear Axle	11.0101-5407.2 260011	Brake System: ATE
2.2 DTI 16V	92	10/03→07/08		11.0101-5407.2 260011	Brake System: ATE
1.9 CDTI	88	04/04→07/08	Suspension: for vehicles with sports suspension; Special Purpose Vehicle: for police vehicles; Fitting Position: Front Axle	11.0101-5407.2 260011	Brake System: ATE
			Suspension: for vehicles without sports suspension; Special Purpose Vehicle: not for police vehicles; Fitting Position: Front Axle	11.0101-5407.2 260011	Brake System: ATE
			Vehicle Identification Number from: 41085481 →; Fitting Position: Rear Axle	11.0101-5407.2 260011	Brake System: ATE
			Brake Disc Type: Solid; → Vehicle Identification Number to: 41085480; Fitting Position: Rear Axle	11.0101-5407.2 260011	Brake System: ATE
			Brake Disc Type: Vented; → Vehicle Identification Number to: 41085480; Fitting Position: Rear Axle	11.0101-5407.2 260011	Brake System: ATE
1.9 CDTI 16V	110	04/04→05/09	→ Construction year to: 10/08; Fitting Position: Front Axle	11.0101-5407.2 260011	Brake System: ATE
			Brake Disc Type: Vented; → Vehicle Identification Number to: 41085480; Fitting Position: Rear Axle	11.0101-5407.2 260011	Brake System: ATE
			Vehicle Identification Number from: 41085481 →; → Construction year to: 10/08; Fitting Position: Rear Axle	11.0101-5407.2 260011	Brake System: ATE
			Brake Disc Type: Solid; → Vehicle Identification Number to: 41085480; Fitting Position: Rear Axle	11.0101-5407.2 260011	Brake System: ATE
2.8 V6 Turbo	169	08/05→05/09	Vehicle Identification Number from: 61000001 →; Fitting Position: Front Axle	11.0101-5407.2 260011	Brake System: ATE
			Vehicle Identification Number from: 41085481 →; Fitting Position: Rear Axle	11.0101-5407.2 260011	Brake System: ATE
2.8 V6 Turbo	188	08/06→05/09	Vehicle Identification Number from: 61000001 →; Fitting Position: Front Axle	11.0101-5407.2 260011	Brake System: ATE
			Fitting Position: Rear Axle	11.0101-5407.2 260011	Brake System: ATE
2.8 V6 Turbo	206	10/06→05/09	Fitting Position: Front Axle	11.0101-5407.2 260011	Brake System: ATE
			Fitting Position: Rear Axle	11.0101-5407.2 260011	Brake System: ATE
3.0 CDTi	135	08/05→07/08	Fitting Position: Front Axle	11.0101-5407.2 260011	Brake System: ATE
			Vehicle Identification Number from: 41085481 →; Fitting Position: Rear Axle	11.0101-5407.2 260011	Brake System: ATE
			Brake Disc Type: Solid; → Vehicle Identification Number to: 41085480; Fitting Position: Rear Axle	11.0101-5407.2 260011	Brake System: ATE
			→ Vehicle Identification Number to: 41085480; Brake Disc Type: Internally Vented; Fitting Position: Rear Axle	11.0101-5407.2 260011	Brake System: ATE
3.0 V6 CDTI 3.2 V6	130	10/03→08/05	Vehicle Identification Number from: 31070294 →; Fitting Position: Front Axle	11.0101-5407.2 260011	Brake System: ATE
			→ Vehicle Identification Number to: 31070293; Fitting Position: Front Axle	11.0101-5407.2 260011	Brake System: ATE
	155	10/03→08/05	Vehicle Identification Number from: 41085481 →; Fitting Position: Rear Axle	11.0101-5407.2 260011	Brake System: ATE
			Brake Disc Type: Vented; → Vehicle Identification Number to: 41085480; Fitting Position: Rear Axle	11.0101-5407.2 260011	Brake System: ATE
			Brake Disc Type: Solid; → Vehicle Identification Number to: 41085480; Fitting Position: Rear Axle	11.0101-5407.2 260011	Brake System: ATE
Guide Bolt, brake caliper					
1.8	103	01/06→07/08	Brake Disc Type: Solid; → Vehicle Identification Number to: 41085480; Required quantity: 2	2 11.8171-0008.1 990049	Brake System: ATE
			Vehicle Identification Number from: 41085481 →; Required quantity: 2	2 11.8171-0008.1 990049	Brake System: ATE
→					







	kW				
VAUXHALL - VECTRA Mk II (C) Estate (Z02) 10/03→05/09					
Guide Bolt, brake caliper					
1.8	103	01/06→07/08	→ Vehicle Identification Number to: 41085480; Brake Disc Type: Internally Vented; Required quantity: 2	2	11.8171-0008.1 990049 Brake System: ATE
			Suspension: for vehicles with sports suspension; Special Purpose Vehicle: for police vehicles; Required quantity: 2	2	11.8171-0008.1 990049 Brake System: ATE
			Suspension: for vehicles with sports suspension; Special Purpose Vehicle: not for police vehicles; Required quantity: 2	2	11.8171-0008.1 990049 Brake System: ATE
1.8 16V	90	10/03→08/05	Vehicle Identification Number from: 41085481 →; Required quantity: 2	2	11.8171-0008.1 990049 Brake System: ATE
2.0 16V Turbo	129	10/03→07/08			
2.0 DTI 16V	74	10/03→07/08	Required quantity: 2	2	11.8171-0008.1 990049 Brake System: ATE
2.2 direct	114	10/03→07/08			
2.2 DTI 16V	92	10/03→07/08	Brake Disc Type: Vented; → Vehicle Identification Number to: 41085480; Required quantity: 2	2	11.8171-0008.1 990049 Brake System: ATE
			Brake Disc Type: Solid; → Vehicle Identification Number to: 41085480; Required quantity: 2	2	11.8171-0008.1 990049 Brake System: ATE
1.9 CDTI	88	04/04→07/08	Brake Disc Type: Solid; → Vehicle Identification Number to: 41085480; Required quantity: 2	2	11.8171-0008.1 990049 Brake System: ATE
			Vehicle Identification Number from: 41085481 →; Required quantity: 2	2	11.8171-0008.1 990049 Brake System: ATE
			Brake Disc Type: Vented; → Vehicle Identification Number to: 41085480; Required quantity: 2	2	11.8171-0008.1 990049 Brake System: ATE
			Suspension: for vehicles with sports suspension; Special Purpose Vehicle: for police vehicles; Required quantity: 2	2	11.8171-0008.1 990049 Brake System: ATE
			Suspension: for vehicles without sports suspension; Special Purpose Vehicle: not for police vehicles; Required quantity: 2	2	11.8171-0008.1 990049 Brake System: ATE
1.9 CDTI 16V	110	04/04→05/09	Vehicle Identification Number from: 41085481 →; → Construction year to: 10/08; Required quantity: 2	2	11.8171-0008.1 990049 Brake System: ATE
			→ Construction year to: 10/08; Required quantity: 2	2	11.8171-0008.1 990049 Brake System: ATE
			Brake Disc Type: Vented; → Vehicle Identification Number to: 41085480; Required quantity: 2	2	11.8171-0008.1 990049 Brake System: ATE
			Brake Disc Type: Solid; → Vehicle Identification Number to: 41085480; Required quantity: 2	2	11.8171-0008.1 990049 Brake System: ATE
2.8 V6 Turbo	169	08/05→05/09	Vehicle Identification Number from: 41085481 →; Required quantity: 2	2	11.8171-0008.1 990049 Brake System: ATE
			Vehicle Identification Number from: 61000001 →; Required quantity: 2	2	11.8171-0008.1 990049 Brake System: ATE
2.8 V6 Turbo	188	08/06→05/09	Required quantity: 2	2	11.8171-0008.1 990049 Brake System: ATE
			Vehicle Identification Number from: 61000001 →; Required quantity: 2	2	11.8171-0008.1 990049 Brake System: ATE
2.8 V6 Turbo	206	10/06→05/09	Required quantity: 2	2	11.8171-0008.1 990049 Brake System: ATE
3.0 CDTi	135	08/05→07/08	Vehicle Identification Number from: 41085481 →; Required quantity: 2	2	11.8171-0008.1 990049 Brake System: ATE
			Required quantity: 2	2	11.8171-0008.1 990049 Brake System: ATE
			→ Vehicle Identification Number to: 41085480; Brake Disc Type: Internally Vented; Required quantity: 2	2	11.8171-0008.1 990049 Brake System: ATE
			Brake Disc Type: Solid; → Vehicle Identification Number to: 41085480; Required quantity: 2	2	11.8171-0008.1 990049 Brake System: ATE
3.0 V6 CDTI	130	10/03→08/05	Vehicle Identification Number from: 31070294 →; Required quantity: 2	2	11.8171-0008.1 990049 Brake System: ATE
3.2 V6	155	10/03→08/05	Vehicle Identification Number from: 41085481 →; Required quantity: 2	2	11.8171-0008.1 990049 Brake System: ATE
			Brake Disc Type: Vented; → Vehicle Identification Number to: 41085480; Required quantity: 2	2	11.8171-0008.1 990049 Brake System: ATE
			→ Vehicle Identification Number to: 31070293; Required quantity: 2	2	11.8171-0008.1 990049 Brake System: ATE
→					





VAUXHALL - VECTRA Mk II (C) Estate (Z02) 10/03→05/09						
Guide Bolt, brake caliper						
3.0 V6 CDTI 3.2 V6	130 10/03→08/05 155 10/03→08/05	Brake Disc Type: Solid; → Vehicle Identification Number to: 41085480; Required quantity: 2	2	11.8171-0008.1	990049	Brake System: ATE
VAUXHALL - VECTRA Mk II (C) GTS (Z02) 08/02→05/09						
Spring, brake caliper						
1.8	103 01/06→07/08	Suspension: for vehicles with sports suspension; Required quantity: 2; Brake Caliper Type: Cast iron brake caliper; Fitting Position: Front Axle	2	11.8116-0356.1	390586	Brake System: ATE
		Suspension: for vehicles with sports suspension; Special Purpose Vehicle: for police vehicles; Required quantity: 2; Fitting Position: Front Axle	2	11.8116-0356.1	390586	Brake System: ATE
1.8 16V 1.8 16V Dualfuel 2.2 16V 2.2 direct 2.2 DTI 16V	90 08/02→07/08 90 08/02→07/08 108 08/02→07/08 114 10/03→08/05 92 08/02→07/08	Suspension: for vehicles without sports suspension; Required quantity: 2; Brake Caliper Type: Cast iron brake caliper; Fitting Position: Front Axle	2	11.8116-0356.1	390586	Brake System: ATE
1.9 CDTI	88 08/02→07/08	Construction year from: 04/04 →; Required quantity: 2; Brake Caliper Type: Cast iron brake caliper; Fitting Position: Front Axle	2	11.8116-0356.1	390586	Brake System: ATE
1.9 CDTI 16V 2.0 DTI 16V	110 04/04→07/08 74 08/02→07/08	Required quantity: 2; Brake Caliper Type: Cast iron brake caliper; Fitting Position: Front Axle	2	11.8116-0356.1	390586	Brake System: ATE
Guide Sleeve Kit, brake caliper						
1.8	103 01/06→07/08	Suspension: for vehicles with sports suspension; Fitting Position: Front Axle		11.0101-5407.2	260011	Brake System: ATE
		Suspension: for vehicles with sports suspension; Special Purpose Vehicle: for police vehicles; Fitting Position: Front Axle		11.0101-5407.2	260011	Brake System: ATE
		Brake Disc Type: Solid; Fitting Position: Rear Axle		11.0101-5407.2	260011	Brake System: ATE
		Brake Disc Type: Internally Vented; Fitting Position: Rear Axle		11.0101-5407.2	260011	Brake System: ATE
1.8 16V 1.8 16V Dualfuel 1.9 CDTI 16V 2.0 16V Turbo 2.0 DTI 16V 2.2 16V 2.2 direct 2.2 DTI 16V	90 08/02→07/08 90 08/02→07/08 110 04/04→07/08 129 03/03→07/08 74 08/02→07/08 108 08/02→07/08 114 10/03→08/05 92 08/02→07/08	Fitting Position: Front Axle		11.0101-5407.2	260011	Brake System: ATE
		Brake Disc Type: Solid; Fitting Position: Rear Axle		11.0101-5407.2	260011	Brake System: ATE
		Brake Disc Type: Vented; Fitting Position: Rear Axle		11.0101-5407.2	260011	Brake System: ATE
1.9 CDTI	88 08/02→07/08	Construction year from: 04/04 →; Fitting Position: Front Axle		11.0101-5407.2	260011	Brake System: ATE
		Construction year from: 04/04 →; Brake Disc Type: Solid; Fitting Position: Rear Axle		11.0101-5407.2	260011	Brake System: ATE
		Construction year from: 04/04 →; Brake Disc Type: Vented; Fitting Position: Rear Axle		11.0101-5407.2	260011	Brake System: ATE
2.8 V6 Turbo	169 - 08/05→05/09 184	Vehicle Identification Number from: 61000001 →; Trim Level: + OPC / +VXR; Fitting Position: Front Axle		11.0101-5407.2	260011	Brake System: ATE
		Vehicle Identification Number from: 61000001 →; Trim Level: - OPC / -VXR; Fitting Position: Front Axle		11.0101-5407.2	260011	Brake System: ATE
		Brake Disc Type: Solid; Fitting Position: Rear Axle		11.0101-5407.2	260011	Brake System: ATE
		Brake Disc Type: Internally Vented; Fitting Position: Rear Axle		11.0101-5407.2	260011	Brake System: ATE
2.8 V6 Turbo	188 - 08/05→05/09 206	Vehicle Identification Number from: 61000001 →; Fitting Position: Front Axle		11.0101-5407.2	260011	Brake System: ATE
		Fitting Position: Rear Axle		11.0101-5407.2	260011	Brake System: ATE
3.0 CDTi	135 08/05→07/08	Vehicle Identification Number from: 61000001 →; Fitting Position: Front Axle		11.0101-5407.2	260011	Brake System: ATE
		Brake Disc Type: Solid; Fitting Position: Rear Axle		11.0101-5407.2	260011	Brake System: ATE
		Brake Disc Type: Internally Vented; Fitting Position: Rear Axle		11.0101-5407.2	260011	Brake System: ATE
3.0 V6 CDTI 3.2 V6 →	130 06/03→08/05 155 08/02→07/08	→ Vehicle Identification Number to: 31070293; Fitting Position: Front Axle		11.0101-5407.2	260011	Brake System: ATE



	kw				
VAUXHALL - VECTRA Mk II (C) GTS (Z02) 08/02→05/09					
Guide Sleeve Kit, brake caliper					
3.0 V6 CDTI 3.2 V6	130 06/03→08/05 155 08/02→07/08	Vehicle Identification Number from: 31070294 →; Fitting Position: Front Axle		11.0101-5407.2 260011	Brake System: ATE
		Brake Disc Type: Solid; Fitting Position: Rear Axle		11.0101-5407.2 260011	Brake System: ATE
		Brake Disc Type: Vented; Fitting Position: Rear Axle		11.0101-5407.2 260011	Brake System: ATE
Guide Bolt, brake caliper					
1.8	103 01/06→07/08	Brake Disc Type: Solid; Required quantity: 2	2	11.8171-0008.1 990049	Brake System: ATE
		Brake Disc Type: Internally Vented; Required quantity: 2	2	11.8171-0008.1 990049	Brake System: ATE
		Suspension: for vehicles with sports suspension; Special Purpose Vehicle: for police vehi- cles; Required quantity: 2	2	11.8171-0008.1 990049	Brake System: ATE
		Suspension: for vehicles with sports suspension; Required quantity: 2	2	11.8171-0008.1 990049	Brake System: ATE
1.8 16V	90 08/02→07/08	Required quantity: 2	2	11.8171-0008.1 990049	Brake System: ATE
1.8 16V Dualfuel	90 08/02→07/08				
1.9 CDTI 16V	110 04/04→07/08	Brake Disc Type: Vented; Required quantity: 2	2	11.8171-0008.1 990049	Brake System: ATE
2.0 16V Turbo	129 03/03→07/08				
2.0 DTI 16V	74 08/02→07/08	Brake Disc Type: Solid; Required quantity: 2	2	11.8171-0008.1 990049	Brake System: ATE
2.2 16V	108 08/02→07/08				
2.2 direct	114 10/03→08/05				
2.2 DTI 16V	92 08/02→07/08				
1.9 CDTI	88 08/02→07/08	Construction year from: 04/04 →; Brake Disc Type: Solid; Required quantity: 2	2	11.8171-0008.1 990049	Brake System: ATE
		Construction year from: 04/04 →; Brake Disc Type: Vented; Required quantity: 2	2	11.8171-0008.1 990049	Brake System: ATE
		Construction year from: 04/04 →; Required quantity: 2	2	11.8171-0008.1 990049	Brake System: ATE
2.8 V6 Turbo	169 - 08/05→05/09 184	Brake Disc Type: Solid; Required quantity: 2	2	11.8171-0008.1 990049	Brake System: ATE
		Brake Disc Type: Internally Vented; Required quantity: 2	2	11.8171-0008.1 990049	Brake System: ATE
		Vehicle Identification Number from: 61000001 →; Trim Level: - OPC / -VXR; Required quantity: 2	2	11.8171-0008.1 990049	Brake System: ATE
		Vehicle Identification Number from: 61000001 →; Trim Level: + OPC / +VXR; Required quantity: 2	2	11.8171-0008.1 990049	Brake System: ATE
2.8 V6 Turbo	188 - 08/05→05/09 206	Required quantity: 2	2	11.8171-0008.1 990049	Brake System: ATE
		Vehicle Identification Number from: 61000001 →; Required quantity: 2	2	11.8171-0008.1 990049	Brake System: ATE
3.0 CDTi	135 08/05→07/08	Brake Disc Type: Solid; Required quantity: 2	2	11.8171-0008.1 990049	Brake System: ATE
		Brake Disc Type: Internally Vented; Required quantity: 2	2	11.8171-0008.1 990049	Brake System: ATE
		Vehicle Identification Number from: 61000001 →; Required quantity: 2	2	11.8171-0008.1 990049	Brake System: ATE
3.0 V6 CDTI 3.2 V6	130 06/03→08/05 155 08/02→07/08	Brake Disc Type: Vented; Required quantity: 2	2	11.8171-0008.1 990049	Brake System: ATE
		Brake Disc Type: Solid; Required quantity: 2	2	11.8171-0008.1 990049	Brake System: ATE
		→ Vehicle Identification Number to: 31070293; Required quantity: 2	2	11.8171-0008.1 990049	Brake System: ATE
		Vehicle Identification Number from: 31070294 →; Required quantity: 2	2	11.8171-0008.1 990049	Brake System: ATE
VAUXHALL - VIVARO A Bus (X83) 08/01→07/14					
 Brake Caliper					
1.9 DI 1.9 DTI 2.0 16V	59 08/01→12/06 74 08/01→12/06 88 08/01→12/06	Vehicle Identification Number from: 2V607599 →; Fitting Position: Rear Axle Left		24.3414-1707.5 240337	Brake System: Lucas / TRW Supplementary Article/Supple- mentary Info: without holder Brake Caliper Type: Fist-type Caliper
		Vehicle Identification Number from: 2V607599 →; Fitting Position: Rear Axle Right		24.3414-1708.5 240338	Brake System: Lucas / TRW Supplementary Article/Supple- mentary Info: without holder Brake Caliper Type: Fist-type Caliper
→					

	kW				
VAUXHALL - VIVARO A Bus (X83) 08/01→07/14					
 Brake Caliper					
2.0 CDTI 2.0 ECOTEC 2.5 CDTI 2.5 DTI	66 - 01/06→07/14 84 86 08/06→07/14 84 - 01/06→07/14 107 99 07/03→07/14	Vehicle Identification Number from: 2V607599 →; → Construction year to: 06/14; Fitting Position: Rear Axle Left		24.3414-1707.5 240337	Brake System: Lucas / TRW Supplementary Article/Supplementary Info: without holder Brake Caliper Type: Fist-type Caliper
		Vehicle Identification Number from: 2V607599 →; → Construction year to: 06/14; Fitting Position: Rear Axle Right		24.3414-1708.5 240338	Brake System: Lucas / TRW Supplementary Article/Supplementary Info: without holder Brake Caliper Type: Fist-type Caliper
 Brake Pad Set, disc brake					
1.9 DI 1.9 DTI 2.0 16V	59 08/01→12/06 74 08/01→12/06 88 08/01→12/06	Fitting Position: Rear Axle		13.0460-2840.2 602840	Brake System: Lucas / TRW 23980 16,5 Wear Warning Contact: prepared for wear indicator / excl. wear warning contact
2.0 CDTI 2.5 CDTI	66 01/06→07/14 107 01/06→07/14	Construction year from: 08/06 → → Construction year to: 06/14; Fitting Position: Rear Axle		13.0460-2840.2 602840	Brake System: Lucas / TRW 23980 16,5 Wear Warning Contact: prepared for wear indicator / excl. wear warning contact
2.0 CDTI 2.0 ECOTEC 2.5 CDTI 2.5 DTI	84 08/06→07/14 86 08/06→07/14 84 08/06→07/14 99 07/03→07/14	→ Construction year to: 06/14; Fitting Position: Rear Axle		13.0460-2840.2 602840	Brake System: Lucas / TRW 23980 16,5 Wear Warning Contact: prepared for wear indicator / excl. wear warning contact
 Brake Hose					
1.9 DI 1.9 DTI 2.0 16V	59 08/01→12/06 74 08/01→12/06 88 08/01→12/06	Required quantity: 2; Fitting Position: Rear Axle		2 24.5229-0200.3 330572	Length [mm]: 200
2.0 CDTI 2.5 CDTI	66 01/06→07/14 107 01/06→07/14	Construction year from: 08/06 → → Construction year to: 06/14; Required quantity: 2; Fitting Position: Rear Axle		2 24.5229-0200.3 330572	Length [mm]: 200
2.0 CDTI 2.0 ECOTEC 2.5 CDTI 2.5 DTI	84 08/06→07/14 86 08/06→07/14 84 08/06→07/14 99 07/03→07/14	→ Construction year to: 06/14; Required quantity: 2; Fitting Position: Rear Axle		2 24.5229-0200.3 330572	Length [mm]: 200
 Wheel Speed Sensor					
1.9 DI 1.9 DTI 2.0 16V 2.0 CDTI	59 08/01→12/06 74 08/01→12/06 88 08/01→12/06 66 - 01/06→07/14 84	Vehicle Identification Number from: 2V603869 → → Vehicle Identification Number to: 7V631679 / 7Y999999; Required quantity: 2; Fitting Position: Front Axle		2 24.0710-2097.3 360647	Length [mm]: 720
2.0 ECOTEC 2.5 CDTI 2.5 DTI	86 08/06→07/14 84 - 01/06→07/14 107 99 07/03→07/14	Vehicle Identification Number from: 9V620474 / 9Y708999 →; Required quantity: 2; Fitting Position: Rear Axle		2 24.0710-2100.3 360649	Length [mm]: 956
VAUXHALL - VIVARO A Platform/Chassis (X83) 04/03→07/14					
 Brake Caliper					
1.9 DI 2.0 16V 2.0 CDTI	59 04/03→07/14 88 04/03→07/14 66 - 01/06→07/14 84	Vehicle Identification Number from: 2V607599 →; → Construction year to: 06/14; Fitting Position: Rear Axle Left		24.3414-1707.5 240337	Brake System: Lucas / TRW Supplementary Article/Supplementary Info: without holder Brake Caliper Type: Fist-type Caliper
2.0 ECOTEC 2.5 CDTI	86 08/06→07/14 84 - 08/06→07/14 107	Vehicle Identification Number from: 2V607599 →; → Construction year to: 06/14; Fitting Position: Rear Axle Right		24.3414-1708.5 240338	Brake System: Lucas / TRW Supplementary Article/Supplementary Info: without holder Brake Caliper Type: Fist-type Caliper
2.5 CDTI	99 04/03→07/06	Vehicle Identification Number from: 2V607599 →; Fitting Position: Rear Axle Left		24.3414-1707.5 240337	Brake System: Lucas / TRW Supplementary Article/Supplementary Info: without holder Brake Caliper Type: Fist-type Caliper
		Vehicle Identification Number from: 2V607599 →; Fitting Position: Rear Axle Right		24.3414-1708.5 240338	Brake System: Lucas / TRW Supplementary Article/Supplementary Info: without holder Brake Caliper Type: Fist-type Caliper
→					

	kW				
VAUXHALL - VIVARO A Platform/Chassis (X83) 04/03→07/14					
 Brake Pad Set, disc brake					
1.9 DI 2.0 16V 2.0 CDTI 2.0 ECOTEC 2.5 CDTI	59 04/03→07/14 88 04/03→07/14 84 08/06→07/14 86 08/06→07/14 84 - 08/06→07/14 107	→ Construction year to: 06/14; Fitting Position: Rear Axle		13.0460-2840.2 602840	Brake System: Lucas / TRW 23980 16,5 Wear Warning Contact: prepared for wear indicator / excl. wear warning contact
2.0 CDTI	66 01/06→07/14	Construction year from: 08/06 → → Construction year to: 06/14; Fitting Position: Rear Axle		13.0460-2840.2 602840	Brake System: Lucas / TRW 23980 16,5 Wear Warning Contact: prepared for wear indicator / excl. wear warning contact
2.5 CDTI	99 04/03→07/06	Construction year from: 05/03 →; Fitting Position: Rear Axle		13.0460-2840.2 602840	Brake System: Lucas / TRW 23980 16,5 Wear Warning Contact: prepared for wear indicator / excl. wear warning contact
 Brake Hose					
1.9 DI 2.0 16V 2.0 CDTI 2.0 ECOTEC 2.5 CDTI	59 04/03→07/14 88 04/03→07/14 84 08/06→07/14 86 08/06→07/14 84 - 08/06→07/14 107	→ Construction year to: 06/14; Required quantity: 2; Fitting Position: Rear Axle	2	24.5229-0200.3 330572	Length [mm]: 200
2.0 CDTI	66 01/06→07/14	Construction year from: 08/06 → → Construction year to: 06/14; Required quantity: 2; Fitting Position: Rear Axle	2	24.5229-0200.3 330572	Length [mm]: 200
2.5 CDTI	99 04/03→07/06	Construction year from: 05/03 →; Required quantity: 2; Fitting Position: Rear Axle	2	24.5229-0200.3 330572	Length [mm]: 200
 Wheel Speed Sensor					
1.9 DI 2.0 16V 2.0 CDTI	59 04/03→07/14 88 04/03→07/14 66 - 01/06→07/14 84	Vehicle Identification Number from: 2V603869 → → Vehicle Identification Number to: 7V631679 / 7Y999999; Required quantity: 2; Fitting Position: Front Axle	2	24.0710-2097.3 360647	Length [mm]: 720
2.0 ECOTEC 2.5 CDTI	86 08/06→07/14 84 - 04/03→07/14 107	Vehicle Identification Number from: 9V620474 / 9Y708999 →; Required quantity: 2; Fitting Position: Rear Axle	2	24.0710-2100.3 360649	Length [mm]: 956
VAUXHALL - VIVARO A Van (X83) 08/01→07/14					
 Brake Caliper					
1.9 DI 1.9 DTI 2.0 16V 2.5 CDTI	59 08/01→12/06 74 08/01→12/06 88 08/01→12/06 84 08/06→08/08	Vehicle Identification Number from: 2V607599 →; Fitting Position: Rear Axle Left		24.3414-1707.5 240337	Brake System: Lucas / TRW Supplementary Article/Supplementary Info: without holder Brake Caliper Type: Fist-type Caliper
		Vehicle Identification Number from: 2V607599 →; Fitting Position: Rear Axle Right		24.3414-1708.5 240338	Brake System: Lucas / TRW Supplementary Article/Supplementary Info: without holder Brake Caliper Type: Fist-type Caliper
2.0 CDTI 2.0 ECOTEC 2.5 CDTI 2.5 DTI	66 - 01/06→07/14 84 86 08/06→07/14 107 08/06→07/14 99 07/03→07/14	Vehicle Identification Number from: 2V607599 →; → Construction year to: 06/14; Fitting Position: Rear Axle Left		24.3414-1707.5 240337	Brake System: Lucas / TRW Supplementary Article/Supplementary Info: without holder Brake Caliper Type: Fist-type Caliper
		Vehicle Identification Number from: 2V607599 →; → Construction year to: 06/14; Fitting Position: Rear Axle Right		24.3414-1708.5 240338	Brake System: Lucas / TRW Supplementary Article/Supplementary Info: without holder Brake Caliper Type: Fist-type Caliper
 Brake Pad Set, disc brake					
1.9 DI 1.9 DTI 2.0 16V 2.5 CDTI	59 08/01→12/06 74 08/01→12/06 88 08/01→12/06 84 08/06→08/08	Fitting Position: Rear Axle		13.0460-2840.2 602840	Brake System: Lucas / TRW 23980 16,5 Wear Warning Contact: prepared for wear indicator / excl. wear warning contact
2.0 CDTI	66 01/06→07/14	Construction year from: 08/06 → → Construction year to: 06/14; Fitting Position: Rear Axle		13.0460-2840.2 602840	Brake System: Lucas / TRW 23980 16,5 Wear Warning Contact: prepared for wear indicator / excl. wear warning contact

	kW				
VAUXHALL - VIVARO A Van (X83) 08/01→07/14					
 Brake Pad Set, disc brake					
2.0 CDTi 2.0 ECOTEC 2.5 CDTi 2.5 DTI	84 08/06→07/14 86 08/06→07/14 107 08/06→07/14 99 07/03→07/14	→ Construction year to: 06/14; Fitting Position: Rear Axle		13.0460-2840.2 602840	Brake System: Lucas / TRW 23980 16,5 Wear Warning Contact: prepared for wear indicator / excl. wear warning contact
 Brake Hose					
1.9 DI 1.9 DTI 2.0 16V 2.5 CDTi	59 08/01→12/06 74 08/01→12/06 88 08/01→12/06 84 08/06→08/08	Required quantity: 2; Fitting Position: Rear Axle	2	24.5229-0200.3 330572	Length [mm]: 200
2.0 CDTi	66 01/06→07/14	Construction year from: 08/06 → → Construction year to: 06/14; Required quantity: 2; Fitting Position: Rear Axle	2	24.5229-0200.3 330572	Length [mm]: 200
2.0 CDTi 2.0 ECOTEC 2.5 CDTi 2.5 DTI	84 08/06→07/14 86 08/06→07/14 107 08/06→07/14 99 07/03→07/14	→ Construction year to: 06/14; Required quantity: 2; Fitting Position: Rear Axle	2	24.5229-0200.3 330572	Length [mm]: 200
 Wheel Speed Sensor					
1.9 DI 1.9 DTI 2.0 16V 2.0 CDTi	59 08/01→12/06 74 08/01→12/06 88 08/01→12/06 66 - 01/06→07/14 84	Vehicle Identification Number from: 2V603869 → → Vehicle Identification Number to: 7V631679 / 7Y999999; Required quantity: 2; Fitting Position: Front Axle	2	24.0710-2097.3 360647	Length [mm]: 720
2.0 ECOTEC 2.5 CDTi 2.5 DTI	86 08/06→07/14 84 - 08/06→07/14 107 99 07/03→07/14	Vehicle Identification Number from: 9V620474 / 9Y708999 →; Required quantity: 2; Fitting Position: Rear Axle	2	24.0710-2100.3 360649	Length [mm]: 956
VAUXHALL - VIVARO B Bus (X82) 05/14→					
 Brake Caliper					
1.6 CDTi	66 - 05/14→ 103	Construction year from: 07/14 →; Fitting Position: Rear Axle Left		24.3414-1707.5 240337	Brake System: Lucas / TRW Supplementary Article/Supplementary Info: without holder Brake Caliper Type: Fist-type Caliper
		Construction year from: 07/14 →; Fitting Position: Rear Axle Right		24.3414-1708.5 240338	Brake System: Lucas / TRW Supplementary Article/Supplementary Info: without holder Brake Caliper Type: Fist-type Caliper
1.6 CDTi 1.6 CDTi	70 - 08/16→ 107 89 01/19→	Fitting Position: Rear Axle Left		24.3414-1707.5 240337	Brake System: Lucas / TRW Supplementary Article/Supplementary Info: without holder Brake Caliper Type: Fist-type Caliper
		Fitting Position: Rear Axle Right		24.3414-1708.5 240338	Brake System: Lucas / TRW Supplementary Article/Supplementary Info: without holder Brake Caliper Type: Fist-type Caliper
 Brake Pad Set, disc brake					
1.6 CDTi	66 - 05/14→ 103	Construction year from: 07/14 →; Fitting Position: Rear Axle		13.0460-2840.2 602840	Brake System: Lucas / TRW 23980 16,5 Wear Warning Contact: prepared for wear indicator / excl. wear warning contact
1.6 CDTi 1.6 CDTi	70 - 08/16→ 107 89 01/19→	Fitting Position: Rear Axle		13.0460-2840.2 602840	Brake System: Lucas / TRW 23980 16,5 Wear Warning Contact: prepared for wear indicator / excl. wear warning contact
 Brake Disc					
1.6 CDTi	66 - 05/14→ 103	Construction year from: 07/14 →; Fitting Position: Front Axle		24.0128-0287.1 428287	Outer diameter [mm]: 296 Brake Disc Thickness [mm] 28 Minimum thickness [mm] 23.4 Brake Disc Type: Vented Supplementary Article/Info 2: with bolts/screws
→					

	kW				
VAUXHALL - VIVARO B Bus (X82) 05/14→					
 Brake Disc					
1.6 CDTi	70 - 08/16→		Fitting Position: Front Axle	24.0128-0287.1 428287	Outer diameter [mm]: 296 Brake Disc Thickness [mm] 28 Minimum thickness [mm] 23.4 Brake Disc Type: Vented Supplementary Article/Info 2: with bolts/screws
1.6 CDTi	107 89 01/19→				
VAUXHALL - VIVARO B Platform/Chassis (X82) 05/14→					
 Brake Caliper					
1.6 CDTi	85 - 05/14→		Construction year from: 07/14 →; Fitting Position: Rear Axle Left	24.3414-1707.5 240337	Brake System: Lucas / TRW Supplementary Article/Supplementary Info: without holder Brake Caliper Type: Fist-type Caliper
	103				
			Construction year from: 07/14 →; Fitting Position: Rear Axle Right	24.3414-1708.5 240338	Brake System: Lucas / TRW Supplementary Article/Supplementary Info: without holder Brake Caliper Type: Fist-type Caliper
1.6 CDTi	107 08/16→		Fitting Position: Rear Axle Left	24.3414-1707.5 240337	Brake System: Lucas / TRW Supplementary Article/Supplementary Info: without holder Brake Caliper Type: Fist-type Caliper
1.6 CDTi	92 08/16→				
			Fitting Position: Rear Axle Right	24.3414-1708.5 240338	Brake System: Lucas / TRW Supplementary Article/Supplementary Info: without holder Brake Caliper Type: Fist-type Caliper
 Brake Pad Set, disc brake					
1.6 CDTi	85 - 05/14→		Construction year from: 07/14 →; Fitting Position: Rear Axle	13.0460-2840.2 602840	Brake System: Lucas / TRW 23980 16,5 Wear Warning Contact: prepared for wear indicator / excl. wear warning contact
	103				
1.6 CDTi	107 08/16→		Fitting Position: Rear Axle	13.0460-2840.2 602840	Brake System: Lucas / TRW 23980 16,5 Wear Warning Contact: prepared for wear indicator / excl. wear warning contact
1.6 CDTi	92 08/16→				
 Brake Disc					
1.6 CDTi	85 - 05/14→		Construction year from: 07/14 →; Fitting Position: Front Axle	24.0128-0287.1 428287	Outer diameter [mm]: 296 Brake Disc Thickness [mm] 28 Minimum thickness [mm] 23.4 Brake Disc Type: Vented Supplementary Article/Info 2: with bolts/screws
	103				
1.6 CDTi	107 08/16→		Fitting Position: Front Axle	24.0128-0287.1 428287	Outer diameter [mm]: 296 Brake Disc Thickness [mm] 28 Minimum thickness [mm] 23.4 Brake Disc Type: Vented Supplementary Article/Info 2: with bolts/screws
1.6 CDTi	92 08/16→				
VAUXHALL - VIVARO B Van (X82) 05/14→					
 Brake Caliper					
1.6 CDTi	66 - 05/14→		Construction year from: 07/14 →; Fitting Position: Rear Axle Left	24.3414-1707.5 240337	Brake System: Lucas / TRW Supplementary Article/Supplementary Info: without holder Brake Caliper Type: Fist-type Caliper
	103				
			Construction year from: 07/14 →; Fitting Position: Rear Axle Right	24.3414-1708.5 240338	Brake System: Lucas / TRW Supplementary Article/Supplementary Info: without holder Brake Caliper Type: Fist-type Caliper
1.6 CDTi	70 - 08/16→		Fitting Position: Rear Axle Left	24.3414-1707.5 240337	Brake System: Lucas / TRW Supplementary Article/Supplementary Info: without holder Brake Caliper Type: Fist-type Caliper
1.6 CDTi	107 89 08/16→				
→					

	kW				
VAUXHALL - VIVARO B Van (X82) 05/14→					
 Brake Caliper					
1.6 CDTi 1.6 CDTi	70 - 08/16→ 107 89 08/16→	Fitting Position: Rear Axle Right	24.3414-1708.5 240338	Brake System: Lucas / TRW Supplementary Article/Supplementary Info: without holder Brake Caliper Type: Fist-type Caliper	
 Brake Pad Set, disc brake					
1.6 CDTi	66 - 05/14→ 103	Construction year from: 07/14 →; Fitting Position: Rear Axle	13.0460-2840.2 602840	Brake System: Lucas / TRW 23980 16,5 Wear Warning Contact: prepared for wear indicator / excl. wear warning contact	
1.6 CDTi 1.6 CDTi	70 - 08/16→ 107 89 08/16→	Fitting Position: Rear Axle	13.0460-2840.2 602840	Brake System: Lucas / TRW 23980 16,5 Wear Warning Contact: prepared for wear indicator / excl. wear warning contact	
 Brake Disc					
1.6 CDTi	66 - 05/14→ 103	Construction year from: 07/14 →; Fitting Position: Front Axle	24.0128-0287.1 428287	Outer diameter [mm]: 296 Brake Disc Thickness [mm] 28 Minimum thickness [mm] 23.4 Brake Disc Type: Vented Supplementary Article/Info 2: with bolts/screws	
1.6 CDTi 1.6 CDTi	70 - 08/16→ 107 89 08/16→	Fitting Position: Front Axle	24.0128-0287.1 428287	Outer diameter [mm]: 296 Brake Disc Thickness [mm] 28 Minimum thickness [mm] 23.4 Brake Disc Type: Vented Supplementary Article/Info 2: with bolts/screws	
VAUXHALL - ZAFIRA A (T98) 11/98→08/05					
Guide Sleeve Kit, brake caliper					
1.6 16V 1.8 16V 1.8 Dualfuel 2.0 DI 16V	74 04/99→08/05 92 09/00→08/05 92 09/00→08/05 60 10/99→08/05	→ Construction year to: 06/05; Fitting Position: Front Axle	11.0101-5407.2 260011	Brake System: ATE	
1.6 CNG 1.8 16V 2.0 2.0 GSI Turbo	71 09/01→06/05 85 05/99→08/00 147 06/02→06/05 141 09/01→06/05	Fitting Position: Front Axle	11.0101-5407.2 260011	Brake System: ATE	
1.6 Dualfuel	74 11/98→08/05	Construction year from: 04/99 → → Construction year to: 06/05; Fitting Position: Front Axle	11.0101-5407.2 260011	Brake System: ATE	
2.0 DTI 16V	74 04/99→08/05	Construction year from: 06/00 → → Construction year to: 06/05; Fitting Position: Front Axle	11.0101-5407.2 260011	Brake System: ATE	
2.2 16V	108 11/98→08/04	Construction year from: 09/00 →; Fitting Position: Front Axle	11.0101-5407.2 260011	Brake System: ATE	
Guide Bolt, brake caliper					
1.6 16V 1.8 16V 1.8 Dualfuel 2.0 DI 16V	74 04/99→08/05 92 09/00→08/05 92 09/00→08/05 60 10/99→08/05	→ Construction year to: 06/05; Required quantity: 2; Fitting Position: Front Axle	2 11.8171-0008.1 990049	Brake System: ATE	
1.6 CNG 1.8 16V 2.0 2.0 GSI Turbo	71 09/01→06/05 85 05/99→08/00 147 06/02→06/05 141 09/01→06/05	Required quantity: 2; Fitting Position: Front Axle	2 11.8171-0008.1 990049	Brake System: ATE	
1.6 Dualfuel	74 11/98→08/05	Construction year from: 04/99 → → Construction year to: 06/05; Required quantity: 2; Fitting Position: Front Axle	2 11.8171-0008.1 990049	Brake System: ATE	
2.0 DTI 16V	74 04/99→08/05	Construction year from: 06/00 → → Construction year to: 06/05; Required quantity: 2; Fitting Position: Front Axle	2 11.8171-0008.1 990049	Brake System: ATE	
2.2 16V	108 11/98→08/04	Construction year from: 09/00 →; Required quantity: 2; Fitting Position: Front Axle	2 11.8171-0008.1 990049	Brake System: ATE	
VAUXHALL - ZAFIRA Mk II (B) (A05) 04/05→11/14					
Spring, brake caliper					
2.0 →	176 01/06→11/14	Required quantity: 2; Fitting Position: Front Axle	2 11.8116-0356.1 390586	Brake System: ATE	

	kW				
VAUXHALL - ZAFIRA Mk II (B) (A05) 04/05→11/14					
Guide Sleeve Kit, brake caliper					
1.6	77 - 07/05→11/14 85	Fitting Position: Front Axle		11.0101-5407.2 260011	Brake System: ATE
1.9 CDTI	88 - 07/05→11/14 110				
2.0	147 - 07/05→11/14 176				
2.2	110 07/05→11/14				
1.7 CDTI	81 - 01/08→11/14 92	for brake disc diameter [mm]: 308; Fitting Position: Front Axle		11.0101-5407.2 260011	Brake System: ATE
		for brake disc diameter [mm]: 280; Fitting Position: Front Axle		11.0101-5407.2 260011	Brake System: ATE
1.8	88 04/13→11/14	Construction year from: 06/13 →; for brake disc diameter [mm]: 280; Fitting Position: Front Axle		11.0101-5407.2 260011	Brake System: ATE
		Construction year from: 06/13 →; for brake disc diameter [mm]: 308; Fitting Position: Front Axle		11.0101-5407.2 260011	Brake System: ATE
1.8	103 04/05→11/14	Construction year from: 07/05 →; for brake disc diameter [mm]: 280; Fitting Position: Front Axle		11.0101-5407.2 260011	Brake System: ATE
		Construction year from: 07/05 →; for brake disc diameter [mm]: 308; Fitting Position: Front Axle		11.0101-5407.2 260011	Brake System: ATE
Guide Bolt, brake caliper					
1.6	77 - 07/05→11/14 85	Required quantity: 2	2	11.8171-0008.1 990049	Brake System: ATE
1.9 CDTI	88 - 07/05→11/14 110				
2.0	147 - 07/05→11/14 176				
2.2	110 07/05→11/14				
1.7 CDTI	81 - 01/08→11/14 92	for brake disc diameter [mm]: 308; Required quantity: 2	2	11.8171-0008.1 990049	Brake System: ATE
		for brake disc diameter [mm]: 280; Required quantity: 2	2	11.8171-0008.1 990049	Brake System: ATE
1.8	88 04/13→11/14	Construction year from: 06/13 →; for brake disc diameter [mm]: 280; Required quantity: 2	2	11.8171-0008.1 990049	Brake System: ATE
		Construction year from: 06/13 →; for brake disc diameter [mm]: 308; Required quantity: 2	2	11.8171-0008.1 990049	Brake System: ATE
1.8	103 04/05→11/14	Construction year from: 07/05 →; for brake disc diameter [mm]: 280; Required quantity: 2	2	11.8171-0008.1 990049	Brake System: ATE
		Construction year from: 07/05 →; for brake disc diameter [mm]: 308; Required quantity: 2	2	11.8171-0008.1 990049	Brake System: ATE
VAUXHALL - ZAFIRA Mk III (P12) 10/11→08/18					
 Brake Caliper					
1.4	88 - 10/11→08/18 103	Construction year from: 11/11 →; for brake disc diameter [mm]: 292;		24.3402-7003.5 241457	Brake System: ATE Supplementary Article/Supplementary Info: without holder
1.6 CNG	110 10/11→08/18	Vehicle Equipment: for vehicles with electric parking brake;			Brake Caliper Type: Fist-type Caliper
1.8	85 - 10/11→08/18 103	Fitting Position: Rear Axle Left			
2.0 CDTi	81 - 10/11→08/18 121	Construction year from: 11/11 →; for brake disc diameter [mm]: 292; Vehicle Equipment: for vehicles with electric parking brake; Fitting Position: Rear Axle Right		24.3402-7004.5 241458	Brake System: ATE Supplementary Article/Supplementary Info: without holder Brake Caliper Type: Fist-type Caliper
1.6 CDTi	99 - 03/13→08/18 100	for brake disc diameter [mm]: 292; Vehicle Equipment: for vehicles with electric parking brake;		24.3402-7003.5 241457	Brake System: ATE Supplementary Article/Supplementary Info: without holder
1.6 SIDI	147 07/13→08/18	Fitting Position: Rear Axle Left			Brake Caliper Type: Fist-type Caliper
2.0 CDTi	125 01/15→08/18	for brake disc diameter [mm]: 292; Vehicle Equipment: for vehicles with electric parking brake; Fitting Position: Rear Axle Right		24.3402-7004.5 241458	Brake System: ATE Supplementary Article/Supplementary Info: without holder Brake Caliper Type: Fist-type Caliper
2.0 BiTurbo CDTi	143 11/12→08/18	Construction year from: 12/12 →; for brake disc diameter [mm]: 292; Vehicle Equipment: for vehicles with electric parking brake; Fitting Position: Rear Axle Left		24.3402-7003.5 241457	Brake System: ATE Supplementary Article/Supplementary Info: without holder Brake Caliper Type: Fist-type Caliper
→					

	kW				
VAUXHALL - ZAFIRA Mk III (P12) 10/11→08/18					
 Brake Caliper					
2.0 BiTurbo CDTI	143	11/12→08/18	Construction year from: 12/12 →; for brake disc diameter [mm]: 292; Vehicle Equipment: for vehicles with electric parking brake; Fitting Position: Rear Axle Right	24.3402-7004.5 241458	Brake System: ATE Supplementary Article/Supple- mentary Info: without holder Brake Caliper Type: Fist-type Caliper
VOLVO - 440 (445) 08/88→12/96					
Guide Sleeve Kit, brake caliper					
1.7 Turbo	88 - 90	08/88→12/96	Fitting Position: Front Axle	11.0101-5407.2 260011	Brake System: ATE
2.0	80 - 81	08/92→07/96			
Guide Bolt, brake caliper					
1.6	61 - 69	09/88→12/96	Required quantity: 2; Fitting Position: Rear Axle	2 11.8171-0008.1 990049	Brake System: ATE
1.7	75 - 78	09/88→12/96			
1.8	66	08/91→12/96			
1.9 Turbo-Diesel	66	07/94→12/96			
1.7 Turbo	88 - 90	08/88→12/96	Required quantity: 2	2 11.8171-0008.1 990049	Brake System: ATE
2.0	81	08/92→07/95	Required quantity: 2; Fitting Position: Rear Axle	2 11.8171-0008.1 990049	Brake System: ATE
2.0	80	08/93→07/96	Required quantity: 2	2 11.8171-0008.1 990049	Brake System: ATE
VOLVO - 460 (464) 09/88→12/96					
Guide Sleeve Kit, brake caliper					
1.7 Turbo	88 - 90	08/89→07/96	Fitting Position: Front Axle	11.0101-5407.2 260011	Brake System: ATE
2.0	80 - 81	08/92→07/96			
Guide Bolt, brake caliper					
1.7	75 - 80	08/89→07/92	Required quantity: 2; Fitting Position: Rear Axle	2 11.8171-0008.1 990049	Brake System: ATE
1.8	66	08/91→07/96			
1.9 Turbo-Diesel	66	07/94→07/96			
1.7 Turbo	88 - 90	08/89→07/96	Required quantity: 2	2 11.8171-0008.1 990049	Brake System: ATE
2.0	81	08/92→07/95	Required quantity: 2; Fitting Position: Rear Axle	2 11.8171-0008.1 990049	Brake System: ATE
2.0	80	08/93→07/96	Required quantity: 2	2 11.8171-0008.1 990049	Brake System: ATE
VOLVO - 480 (482) 04/86→07/96					
Guide Sleeve Kit, brake caliper					
1.7 Turbo	88 - 90	08/87→07/96	Fitting Position: Front Axle	11.0101-5407.2 260011	Brake System: ATE
2.0	81	08/92→09/95			
Guide Bolt, brake caliper					
1.7	70 - 80	04/86→07/96	Required quantity: 2; Fitting Position: Rear Axle	2 11.8171-0008.1 990049	Brake System: ATE
1.7 Turbo	88 - 90	08/87→07/96	Required quantity: 2	2 11.8171-0008.1 990049	Brake System: ATE
2.0	81	08/92→09/95	Required quantity: 2; Fitting Position: Rear Axle	2 11.8171-0008.1 990049	Brake System: ATE
VOLVO - 850 (854) 06/91→10/97					
Guide Sleeve Kit, brake caliper					
2.0	93 - 105	06/91→12/96	Fitting Position: Front Axle	11.0101-5407.2 260011	Brake System: ATE
2.0 Turbo	132 - 155	08/93→12/96			
2.4	103 - 125	06/91→12/96			
2.5 TDI	103	08/95→12/96			
T5	166	08/93→07/96			
T5 R	176	04/96→10/96			
T5-R	184	08/95→12/96			
2.3 Turbo R	177	06/95→10/96	Construction year from: 08/95 →; Fitting Position: Front Axle	11.0101-5407.2 260011	Brake System: ATE
2.3 Turbo R	179	09/94→10/97	Construction year from: 08/95 → → Construction year to: 12/96; Fitting Position: Front Axle	11.0101-5407.2 260011	Brake System: ATE
→					

	kW				
VOLVO - 850 (854) 06/91→10/97					
Guide Bolt, brake caliper					
2.0	93 - 06/91→12/96 105	Required quantity: 2; Fitting Position: Front Axle	2	11.8171-0008.1 990049	Brake System: ATE
2.0 Turbo	132 - 08/93→12/96 155				
2.4	103 - 06/91→12/96 125				
2.5 TDI	103 08/95→12/96				
T5	166 08/93→07/96				
T5 R	176 04/96→10/96				
T5-R	184 08/95→12/96				
2.3 Turbo R	177 06/95→10/96	Construction year from: 08/95 →; Required quantity: 2; Fitting Position: Front Axle	2	11.8171-0008.1 990049	Brake System: ATE
2.3 Turbo R	179 09/94→10/97	Construction year from: 08/95 → → Construction year to: 12/96; Required quantity: 2; Fitting Position: Front Axle	2	11.8171-0008.1 990049	Brake System: ATE
VOLVO - 850 Estate (855) 04/92→10/97					
Guide Sleeve Kit, brake caliper					
2.0	93 - 02/93→12/96 105	Fitting Position: Front Axle		11.0101-5407.2 260011	Brake System: ATE
2.0 Turbo	155 02/93→12/96				
2.4	103 - 08/92→12/96 125				
2.4 AWD	142 04/96→12/96				
2.5 TDI	103 08/95→12/96				
T5	166 02/93→12/96				
T5 R	176 04/96→10/96				
T5-R	184 08/95→12/96				
2.0 Turbo	132 09/93→10/97	→ Construction year to: 12/96; Fitting Position: Front Axle		11.0101-5407.2 260011	Brake System: ATE
2.3 Turbo R	177 06/95→10/97	Construction year from: 08/95 → → Construction year to: 12/96; Fitting Position: Front Axle		11.0101-5407.2 260011	Brake System: ATE
Guide Bolt, brake caliper					
2.0	93 - 02/93→12/96 105	Required quantity: 2; Fitting Position: Front Axle	2	11.8171-0008.1 990049	Brake System: ATE
2.0 Turbo	155 02/93→12/96				
2.4	103 - 08/92→12/96 125				
2.4 AWD	142 04/96→12/96				
2.5 TDI	103 08/95→12/96				
T5	166 02/93→12/96				
T5 R	176 04/96→10/96				
T5-R	184 08/95→12/96				
2.0 Turbo	132 09/93→10/97	→ Construction year to: 12/96; Required quantity: 2; Fitting Position: Front Axle	2	11.8171-0008.1 990049	Brake System: ATE
2.3 Turbo R	177 06/95→10/97	Construction year from: 08/95 → → Construction year to: 12/96; Required quantity: 2; Fitting Position: Front Axle	2	11.8171-0008.1 990049	Brake System: ATE
VOLVO - C30 (533) 09/06→12/13					
Spring, brake caliper					
1.6	74 10/06→12/12	Required quantity: 2;	2	11.8116-0356.1 390586	Brake System: ATE
1.6 D	80 10/06→12/12	Fitting Position: Front Axle			
1.8	92 10/06→12/12				
2.0	107 10/06→12/12				
2.0 D	100 10/06→12/12				
2.0 FlexFuel	107 01/10→12/12				
2.4 i	125 10/06→12/12				
D2	84 10/10→12/12				
D3	110 10/10→12/12				
D4	130 10/10→12/12				
D5	120 - 10/06→12/12 132				
Electric	82 - 12/10→12/12 89				
T5	162 - 10/06→12/13 184				
1.8 FlexFuel	92 01/07→12/12	Construction year from: 04/07 →; Required quantity: 2; Fitting Position: Front Axle	2	11.8116-0356.1 390586	Brake System: ATE
Guide Sleeve Kit, brake caliper					
1.6	74 10/06→12/12	Fitting Position: Front Axle		11.0101-5407.2 260011	Brake System: ATE
1.6 D	80 10/06→12/12				
→					

	kW				
VOLVO - C30 (533) 09/06→12/13					
Guide Sleeve Kit, brake caliper					
1.8	92	10/06→12/12	Vehicle Identification Number from: 146187 →; Fitting Position: Rear Axle	11.0101-5407.2	260011 Brake System: ATE
2.0	107	10/06→12/12	→ Vehicle Identification Number to: 146186; Fitting Position: Rear Axle	11.0101-5407.2	260011 Brake System: ATE
2.0 D	100	10/06→12/12			
2.0 FlexFuel	107	01/10→12/12			
2.4 i	125	10/06→12/12			
D2	84	10/10→12/12			
D3	110	10/10→12/12			
D4	130	10/10→12/12			
D5	120 -	10/06→12/12			
	132				
T5	162 -	10/06→12/13			
	184				
1.8 FlexFuel	92	01/07→12/12	Construction year from: 04/07 →; Fitting Position: Front Axle	11.0101-5407.2	260011 Brake System: ATE
			Vehicle Identification Number from: 146187 →; Fitting Position: Rear Axle	11.0101-5407.2	260011 Brake System: ATE
			Construction year from: 04/07 →; → Vehicle Identification Number to: 146186; Fitting Position: Rear Axle	11.0101-5407.2	260011 Brake System: ATE
Electric	82 -	12/10→12/12	Fitting Position: Front Axle	11.0101-5407.2	260011 Brake System: ATE
	89		Vehicle Identification Number from: 128 →; Fitting Position: Rear Axle	11.0101-5407.2	260011 Brake System: ATE
			→ Vehicle Identification Number to: 127; Fitting Position: Rear Axle	11.0101-5407.2	260011 Brake System: ATE
Guide Bolt, brake caliper					
1.6	74	10/06→12/12	Required quantity: 2	2	11.8171-0008.1 990049 Brake System: ATE
1.6 D	80	10/06→12/12	Vehicle Identification Number from: 146187 →; Required quantity: 2	2	11.8171-0008.1 990049 Brake System: ATE
1.8	92	10/06→12/12			
2.0	107	10/06→12/12	→ Vehicle Identification Number to: 146186; Required quantity: 2	2	11.8171-0008.1 990049 Brake System: ATE
2.0 D	100	10/06→12/12			
2.0 FlexFuel	107	01/10→12/12			
2.4 i	125	10/06→12/12			
D2	84	10/10→12/12			
D3	110	10/10→12/12			
D4	130	10/10→12/12			
D5	120 -	10/06→12/12			
	132				
T5	162 -	10/06→12/13			
	184				
1.8 FlexFuel	92	01/07→12/12	Construction year from: 04/07 →; Required quantity: 2	2	11.8171-0008.1 990049 Brake System: ATE
			Vehicle Identification Number from: 146187 →; Required quantity: 2	2	11.8171-0008.1 990049 Brake System: ATE
			Construction year from: 04/07 →; → Vehicle Identification Number to: 146186; Required quantity: 2	2	11.8171-0008.1 990049 Brake System: ATE
Electric	82 -	12/10→12/12	Required quantity: 2	2	11.8171-0008.1 990049 Brake System: ATE
	89		Vehicle Identification Number from: 128 →; Required quantity: 2	2	11.8171-0008.1 990049 Brake System: ATE
			→ Vehicle Identification Number to: 127; Required quantity: 2	2	11.8171-0008.1 990049 Brake System: ATE
VOLVO - C40 10/21→					
Guide Sleeve Kit, brake caliper					
Recharge AWD	300	10/21→	Brake Size: 18"; Fitting Position: Rear Axle	11.0101-5407.2	260011 Brake System: ATE
Guide Bolt, brake caliper					
Recharge AWD	300	10/21→	Brake Size: 18"; Fitting Position: Rear Axle	11.8171-0008.1	990049 Brake System: ATE
VOLVO - C70 II Convertible (542) 03/06→12/13					
Spring, brake caliper					
2.0 D	100	01/08→10/09	Construction year from: 06/08 →; Required quantity: 2; Fitting Position: Front Axle	2	11.8116-0356.1 390586 Brake System: ATE
2.4	103	03/06→10/09	Required quantity: 2; Fitting Position: Front Axle	2	11.8116-0356.1 390586 Brake System: ATE
2.4 D	120	03/07→06/13			
2.4 i	125	03/06→10/09			
D3	110	10/10→06/13			
D4	130	10/10→06/13			
D5	132	03/06→06/13			
T5	162 -	03/06→06/13			
	169				
→					

VOLVO - C70 II Convertible (542) 03/06→12/13						
Guide Sleeve Kit, brake caliper						
2.0 D	100 01/08→10/09	Vehicle Identification Number from: 77107 →; Fitting Position: Rear Axle		11.0101-5407.2 260011	Brake System: ATE	
		Construction year from: 06/08 →; → Vehicle Identification Number to: 77106; Fitting Position: Rear Axle		11.0101-5407.2 260011	Brake System: ATE	
2.4	103 03/06→10/09	Vehicle Identification Number from: 77107 →; Fitting Position: Rear Axle		11.0101-5407.2 260011	Brake System: ATE	
2.4 D	120 03/07→06/13					
2.4 i	125 03/06→10/09	→ Vehicle Identification Number to: 77106; Fitting Position: Rear Axle		11.0101-5407.2 260011	Brake System: ATE	
D3	110 10/10→06/13					
D4	130 10/10→06/13					
D5	132 03/06→06/13					
T5	162 - 03/06→06/13					
	169					
Guide Bolt, brake caliper						
2.0 D	100 01/08→10/09	Vehicle Identification Number from: 77107 →; Required quantity: 2	2	11.8171-0008.1 990049	Brake System: ATE	
		Construction year from: 06/08 →; → Vehicle Identification Number to: 77106; Required quantity: 2	2	11.8171-0008.1 990049	Brake System: ATE	
2.4	103 03/06→10/09	Vehicle Identification Number from: 77107 →; Required quantity: 2	2	11.8171-0008.1 990049	Brake System: ATE	
2.4 D	120 03/07→06/13					
2.4 i	125 03/06→10/09	→ Vehicle Identification Number to: 77106; Required quantity: 2	2	11.8171-0008.1 990049	Brake System: ATE	
D3	110 10/10→06/13					
D4	130 10/10→06/13					
D5	132 03/06→06/13					
T5	162 - 03/06→06/13					
	169					
VOLVO - S40 II (544) 12/03→12/12						
Spring, brake caliper						
1.6	74 01/05→12/12	→ Construction year to: 05/12;	2	11.8116-0356.1 390586	Brake System: ATE	
1.6 D	81 01/05→12/12	Required quantity: 2;				
2.0	107 10/06→12/12	Fitting Position: Front Axle				
2.0 F	107 10/09→12/12					
D2	84 10/10→12/12					
D3	110 10/10→12/12					
D4	130 10/10→12/12					
T5	169 03/07→12/12					
1.8	92 04/04→12/10	Required quantity: 2;	2	11.8116-0356.1 390586	Brake System: ATE	
2.0 CDI	98 07/05→12/06	Fitting Position: Front Axle				
2.0 D	100 01/04→12/10					
2.4	103 - 01/04→12/12					
	125					
2.4 CDI	120 03/07→12/10					
D4	96 07/05→12/06					
D5	132 03/06→12/10					
T5	162 01/04→12/07					
T5 AWD	162 - 04/04→12/10					
	169					
1.8 FlexFuel	92 01/06→12/10	Construction year from: 04/07 →; Required quantity: 2; Fitting Position: Front Axle	2	11.8116-0356.1 390586	Brake System: ATE	
Guide Sleeve Kit, brake caliper						
1.6	74 01/05→12/12	→ Construction year to: 05/12;		11.0101-5407.2 260011	Brake System: ATE	
1.6 D	81 01/05→12/12	Fitting Position: Front Axle				
2.0	107 10/06→12/12	Vehicle Identification Number from: 462753 →;		11.0101-5407.2 260011	Brake System: ATE	
2.0 F	107 10/09→12/12	→ Construction year to: 05/12;				
D2	84 10/10→12/12	Fitting Position: Rear Axle				
D3	110 10/10→12/12					
D4	130 10/10→12/12	→ Vehicle Identification Number to: 462752; Fitting Position: Rear Axle		11.0101-5407.2 260011	Brake System: ATE	
T5	169 03/07→12/12					
1.8	92 04/04→12/10	Fitting Position: Front Axle		11.0101-5407.2 260011	Brake System: ATE	
2.0 CDI	98 07/05→12/06	Vehicle Identification Number from: 462753 →; Fitting Position: Rear Axle		11.0101-5407.2 260011	Brake System: ATE	
2.0 D	100 01/04→12/10					
2.4	103 - 01/04→12/12	→ Vehicle Identification Number to: 462752; Fitting Position: Rear Axle		11.0101-5407.2 260011	Brake System: ATE	
	125					
2.4 CDI	120 03/07→12/10					
D4	96 07/05→12/06					
D5	132 03/06→12/10					
T5	162 01/04→12/07					
T5 AWD	162 - 04/04→12/10					
	169					
1.8 FlexFuel	92 01/06→12/10	Construction year from: 04/07 →; Fitting Position: Front Axle		11.0101-5407.2 260011	Brake System: ATE	
		Vehicle Identification Number from: 462753 →; Fitting Position: Rear Axle		11.0101-5407.2 260011	Brake System: ATE	
→						

VOLVO - S40 II (544) 12/03→12/12							
Guide Sleeve Kit, brake caliper							
1.8 FlexFuel	92	01/06→12/10	Construction year from: 04/07 →; → Vehicle Identification Number to: 462752; Fitting Position: Rear Axle			11.0101-5407.2 260011	Brake System: ATE
Guide Bolt, brake caliper							
1.6	74	01/05→12/12	→ Construction year to: 05/12; Required quantity: 2	2		11.8171-0008.1 990049	Brake System: ATE
1.6 D	81	01/05→12/12					
2.0	107	10/06→12/12	Vehicle Identification Number from: 462753 →;	2		11.8171-0008.1 990049	Brake System: ATE
2.0 F	107	10/09→12/12					
D2	84	10/10→12/12	→ Construction year to: 05/12; Required quantity: 2				
D3	110	10/10→12/12					
D4	130	10/10→12/12					
T5	169	03/07→12/12	→ Vehicle Identification Number to: 462752; Required quantity: 2	2		11.8171-0008.1 990049	Brake System: ATE
1.8	92	04/04→12/10	Required quantity: 2	2		11.8171-0008.1 990049	Brake System: ATE
2.0 CDI	98	07/05→12/06					
2.0 D	100	01/04→12/10	Vehicle Identification Number from: 462753 →; Required quantity: 2	2		11.8171-0008.1 990049	Brake System: ATE
2.4	103 -	01/04→12/12					
	125		→ Vehicle Identification Number to: 462752; Required quantity: 2	2		11.8171-0008.1 990049	Brake System: ATE
2.4 CDI	120	03/07→12/10					
D4	96	07/05→12/06					
D5	132	03/06→12/10					
T5	162	01/04→12/07					
T5 AWD	162 -	04/04→12/10					
	169						
1.8 FlexFuel	92	01/06→12/10	Construction year from: 04/07 →; Required quantity: 2	2		11.8171-0008.1 990049	Brake System: ATE
			Vehicle Identification Number from: 462753 →; Required quantity: 2	2		11.8171-0008.1 990049	Brake System: ATE
			Construction year from: 04/07 →; → Vehicle Identification Number to: 462752; Required quantity: 2	2		11.8171-0008.1 990049	Brake System: ATE
VOLVO - S60 I (384) 07/00→04/10							
Guide Sleeve Kit, brake caliper							
2.0 T	132	07/00→04/10	Construction year from: 09/01 → → Construction year to: 01/09; Fitting Position: Front Axle			11.0101-5407.2 260011	Brake System: ATE
			Construction year from: 09/01 → → Construction year to: 01/09; Fitting Position: Rear Axle			11.0101-5407.2 260011	Brake System: ATE
2.4	103	07/00→04/10	Construction year from: 11/00 → → Construction year to: 01/09; Fitting Position: Front Axle			11.0101-5407.2 260011	Brake System: ATE
2.4 T	147	07/00→04/10					
			Construction year from: 11/00 → → Construction year to: 01/09; Fitting Position: Rear Axle			11.0101-5407.2 260011	Brake System: ATE
2.4	125	11/00→04/10	→ Construction year to: 01/09; Fitting Position: Front Axle			11.0101-5407.2 260011	Brake System: ATE
2.4 D	120	07/05→12/09					
T5	191	04/04→04/10	→ Construction year to: 01/09; Fitting Position: Rear Axle			11.0101-5407.2 260011	Brake System: ATE
2.4	132	01/05→10/06	Fitting Position: Front Axle			11.0101-5407.2 260011	Brake System: ATE
2.4 CDI	85	10/03→12/05					
2.4 D	90	05/05→12/06	Fitting Position: Rear Axle			11.0101-5407.2 260011	Brake System: ATE
T5	195	07/00→09/02					
2.4 Bifuel	103	07/01→04/10	Construction year from: 06/02 → → Construction year to: 01/09; Fitting Position: Front Axle			11.0101-5407.2 260011	Brake System: ATE
			Construction year from: 06/02 → → Construction year to: 01/09; Fitting Position: Rear Axle			11.0101-5407.2 260011	Brake System: ATE
2.4 D	93	03/05→04/10	Construction year from: 09/05 → → Construction year to: 01/09; Fitting Position: Front Axle			11.0101-5407.2 260011	Brake System: ATE
D5	136	03/05→04/10					
			Construction year from: 09/05 → → Construction year to: 01/09; Fitting Position: Rear Axle			11.0101-5407.2 260011	Brake System: ATE
2.4 D	96	05/01→04/10	Construction year from: 12/01 → → Construction year to: 01/09; Fitting Position: Front Axle			11.0101-5407.2 260011	Brake System: ATE
			Construction year from: 12/01 → → Construction year to: 01/09; Fitting Position: Rear Axle			11.0101-5407.2 260011	Brake System: ATE
2.4 T AWD	147	06/01→04/10	Construction year from: 11/01 → → Construction year to: 01/09; Fitting Position: Front Axle			11.0101-5407.2 260011	Brake System: ATE
			Construction year from: 11/01 → → Construction year to: 01/09; Fitting Position: Rear Axle			11.0101-5407.2 260011	Brake System: ATE
→							

	kW				
VOLVO - S60 I (384) 07/00→04/10					
Guide Sleeve Kit, brake caliper					
2.5 T	154 01/03→04/10	Construction year from: 02/04 → → Construction year to: 01/09; Fitting Position: Front Axle		11.0101-5407.2	260011 Brake System: ATE
		Construction year from: 02/04 → → Construction year to: 01/09; Fitting Position: Rear Axle			
2.5 T AWD	154 07/02→04/10	Construction year from: 04/04 → → Construction year to: 01/09; Fitting Position: Front Axle		11.0101-5407.2	260011 Brake System: ATE
		Construction year from: 04/04 → → Construction year to: 01/09; Fitting Position: Rear Axle			
D5	120 01/01→04/10	Construction year from: 07/01 → → Construction year to: 01/09; Fitting Position: Front Axle		11.0101-5407.2	260011 Brake System: ATE
		Construction year from: 07/01 → → Construction year to: 01/09; Fitting Position: Rear Axle			
T5	184 07/00→04/10	Construction year from: 08/00 → → Construction year to: 04/04; Fitting Position: Front Axle		11.0101-5407.2	260011 Brake System: ATE
		Construction year from: 08/00 → → Construction year to: 04/04; Fitting Position: Rear Axle			
Guide Bolt, brake caliper					
2.0 T	132 07/00→04/10	Construction year from: 09/01 → → Construction year to: 01/09; Required quantity: 2; Fitting Position: Front Axle		2	11.8171-0008.1 990049 Brake System: ATE
2.4 2.4 T	103 07/00→04/10 147 07/00→04/10	Construction year from: 11/00 → → Construction year to: 01/09; Required quantity: 2; Fitting Position: Front Axle		2	11.8171-0008.1 990049 Brake System: ATE
2.4 2.4 D T5	125 11/00→04/10 120 07/05→12/09 191 04/04→04/10	→ Construction year to: 01/09; Required quantity: 2; Fitting Position: Front Axle		2	11.8171-0008.1 990049 Brake System: ATE
2.4 2.4 CDI 2.4 D T5	132 01/05→10/06 85 10/03→12/05 90 05/05→12/06 195 07/00→09/02	Required quantity: 2; Fitting Position: Front Axle		2	11.8171-0008.1 990049 Brake System: ATE
2.4 Bifuel	103 07/01→04/10	Construction year from: 06/02 → → Construction year to: 01/09; Required quantity: 2; Fitting Position: Front Axle		2	11.8171-0008.1 990049 Brake System: ATE
2.4 D D5	93 03/05→04/10 136 03/05→04/10	Construction year from: 09/05 → → Construction year to: 01/09; Required quantity: 2; Fitting Position: Front Axle		2	11.8171-0008.1 990049 Brake System: ATE
2.4 D	96 05/01→04/10	Construction year from: 12/01 → → Construction year to: 01/09; Required quantity: 2; Fitting Position: Front Axle		2	11.8171-0008.1 990049 Brake System: ATE
2.4 T AWD	147 06/01→04/10	Construction year from: 11/01 → → Construction year to: 01/09; Required quantity: 2; Fitting Position: Front Axle		2	11.8171-0008.1 990049 Brake System: ATE
2.5 T	154 01/03→04/10	Construction year from: 02/04 → → Construction year to: 01/09; Required quantity: 2; Fitting Position: Front Axle		2	11.8171-0008.1 990049 Brake System: ATE
2.5 T AWD	154 07/02→04/10	Construction year from: 04/04 → → Construction year to: 01/09; Required quantity: 2; Fitting Position: Front Axle		2	11.8171-0008.1 990049 Brake System: ATE
D5	120 01/01→04/10	Construction year from: 07/01 → → Construction year to: 01/09; Required quantity: 2; Fitting Position: Front Axle		2	11.8171-0008.1 990049 Brake System: ATE
T5	184 07/00→04/10	Construction year from: 08/00 → → Construction year to: 04/04; Required quantity: 2; Fitting Position: Front Axle		2	11.8171-0008.1 990049 Brake System: ATE

	kW			
VOLVO - S60 II (134) 04/10→12/18				
Guide Sleeve Kit, brake caliper				
2.0 T	132 05/12→12/15	Construction year from: 12/13 →; for brake disc diameter [mm]: 300; Fitting Position: Front Axle		11.0101-5407.2 260011 Brake System: ATE
2.0 T 2.5 T D2 D3 D4 D4 AWD D4 Drive-E Polestar D5 D5 AWD D5 Drive-E Polestar DRive / D2 T2 T3 T4 T4F T5 T5 AWD T5 DRive T6 T6 AWD	149 04/10→12/11 183 01/13→01/16 88 03/15→05/18 100 - 04/10→05/18 120 133 - 09/13→05/18 140 140 03/15→05/18 147 03/15→05/18 151 - 04/10→05/18 169 151 - 04/10→12/15 169 171 03/15→05/18 84 01/11→12/15 90 10/15→05/18 110 - 04/10→05/18 112 132 04/10→12/15 132 04/11→12/15 177 - 04/10→12/18 225 180 - 09/12→12/18 187 180 09/14→12/15 225 09/13→12/18 224 - 04/10→12/18 242	for brake disc diameter [mm]: 300; Fitting Position: Front Axle		11.0101-5407.2 260011 Brake System: ATE
D4	120 04/10→12/14	Construction year from: 05/12 →; for brake disc diameter [mm]: 300; Fitting Position: Front Axle		11.0101-5407.2 260011 Brake System: ATE
D5 D5 AWD	158 04/11→12/15 158 04/11→12/15	Construction year from: 06/11 →; for brake disc diameter [mm]: 300; Fitting Position: Front Axle		11.0101-5407.2 260011 Brake System: ATE
T4	140 03/15→05/18	Construction year from: 05/15 →; for brake disc diameter [mm]: 300; Fitting Position: Front Axle		11.0101-5407.2 260011 Brake System: ATE
Guide Bolt, brake caliper				
2.0 T	132 05/12→12/15	Construction year from: 12/13 →; for brake disc diameter [mm]: 300; Required quantity: 2; Fitting Position: Front Axle	2	11.8171-0008.1 990049 Brake System: ATE
2.0 T 2.5 T D2 D3 D4 D4 AWD D4 Drive-E Polestar D5 D5 AWD D5 Drive-E Polestar DRive / D2 T2 T3 T4 T4F T5 T5 AWD T5 DRive T6 T6 AWD	149 04/10→12/11 183 01/13→01/16 88 03/15→05/18 100 - 04/10→05/18 120 133 - 09/13→05/18 140 140 03/15→05/18 147 03/15→05/18 151 - 04/10→05/18 169 151 - 04/10→12/15 169 171 03/15→05/18 84 01/11→12/15 90 10/15→05/18 110 - 04/10→05/18 112 132 04/10→12/15 132 04/11→12/15 177 - 04/10→12/18 225 180 - 09/12→12/18 187 180 09/14→12/15 225 09/13→12/18 224 - 04/10→12/18 242	for brake disc diameter [mm]: 300; Required quantity: 2; Fitting Position: Front Axle	2	11.8171-0008.1 990049 Brake System: ATE
D4	120 04/10→12/14	Construction year from: 05/12 →; for brake disc diameter [mm]: 300; Required quantity: 2; Fitting Position: Front Axle	2	11.8171-0008.1 990049 Brake System: ATE
D5 D5 AWD	158 04/11→12/15 158 04/11→12/15	Construction year from: 06/11 →; for brake disc diameter [mm]: 300; Required quantity: 2; Fitting Position: Front Axle	2	11.8171-0008.1 990049 Brake System: ATE
→				

	kW				
VOLVO - S60 II (134) 04/10→12/18					
Guide Bolt, brake caliper					
T4	140 03/15→05/18	Construction year from: 05/15 →; for brake disc diameter [mm]: 300; Required quantity: 2; Fitting Position: Front Axle	2	11.8171-0008.1 990049	Brake System: ATE
VOLVO - S60 II Cross Country (134) 03/15→12/18					
Guide Sleeve Kit, brake caliper					
D4 Polestar AWD T5 AWD T5 Drive-E Polestar AWD	162 03/15→07/18 183 03/15→12/18 186 06/16→05/18	for brake disc diameter [mm]: 300; Fitting Position: Front Axle		11.0101-5407.2 260011	Brake System: ATE
Guide Bolt, brake caliper					
D4 Polestar AWD T5 AWD T5 Drive-E Polestar AWD	162 03/15→07/18 183 03/15→12/18 186 06/16→05/18	for brake disc diameter [mm]: 300; Required quantity: 2; Fitting Position: Front Axle	2	11.8171-0008.1 990049	Brake System: ATE
VOLVO - S60 III (224) 02/19→					
Guide Sleeve Kit, brake caliper					
B3 MHEV B4 Mild-Hybrid B5 Mild-Hybrid B5 Mild-Hybrid AWD	120 03/20→ 145 03/20→ 184 03/20→ 183 - 03/20→	Brake Size: 16" / 17"; Fitting Position: Front Axle Fitting Position: Rear Axle		11.0101-5407.2 260011	Brake System: ATE Brake System: ATE
B6 Mild-Hybrid AWD T4 T4 Polestar T5 T5 AWD T5 Polestar T5 Polestar AWD T6 AWD T6 Polestar AWD	220 04/21→ 140 02/19→ 155 07/19→ 184 02/19→ 183 - 02/19→ 187 186 07/19→ 186 07/19→ 228 05/19→ 240 05/19→				
T6 Drive-E Polestar AWD T6 Hybrid Polestar AWD T6 Twin Engine AWD T8 Plug-in Hybrid AWD	233 02/19→ 245 05/19→ 186 02/19→ 228 - 05/19→	Brake Size: 17"; Fitting Position: Front Axle Fitting Position: Rear Axle		11.0101-5407.2 260011	Brake System: ATE Brake System: ATE
T8 Twin Engine AWD T8 Twin Engine Polestar AWD	223 02/19→ 233 10/19→				
Guide Bolt, brake caliper					
B3 MHEV B4 Mild-Hybrid B5 Mild-Hybrid B5 Mild-Hybrid AWD	120 03/20→ 145 03/20→ 184 03/20→ 183 - 03/20→	Brake Size: 16" / 17"; Fitting Position: Front Axle Fitting Position: Rear Axle		11.8171-0008.1 990049	Brake System: ATE Brake System: ATE
B6 Mild-Hybrid AWD T4 T4 Polestar T5 T5 AWD T5 Polestar T5 Polestar AWD T6 AWD T6 Polestar AWD	220 04/21→ 140 02/19→ 155 07/19→ 184 02/19→ 183 - 02/19→ 187 186 07/19→ 186 07/19→ 228 05/19→ 240 05/19→				
T6 Drive-E Polestar AWD T6 Hybrid Polestar AWD T6 Twin Engine AWD T8 Plug-in Hybrid AWD	233 02/19→ 245 05/19→ 186 02/19→ 228 - 05/19→	Brake Size: 17"; Fitting Position: Front Axle Fitting Position: Rear Axle		11.8171-0008.1 990049	Brake System: ATE Brake System: ATE
T8 Twin Engine AWD T8 Twin Engine Polestar AWD	223 02/19→ 233 10/19→				
Brake Pad Set, disc brake					
T4 T4 Polestar T5 T5 AWD T5 Polestar	140 02/19→ 155 07/19→ 184 02/19→ 183 - 02/19→ 187 186 07/19→	Brake Size: 17"; Fitting Position: Rear Axle		13.0460-7326.2 607326 13.0470-7326.2 LD7326	Brake System: ATE 22141 15,5 Wear Warning Contact: prepared for wear indicator / excl. wear warning contact Brake System: ATE Wear Warning Contact: prepared for wear indicator / excl. wear warning contact Ceramic

	kW				
VOLVO - S60 III (224) 02/19→					
 Brake Pad Set, disc brake					
T4 T4 Polestar T5 T5 AWD T5 Polestar	140 02/19→ 155 07/19→ 184 02/19→ 183 - 02/19→ 187 186 07/19→	Brake Size: 16"; Fitting Position: Rear Axle		13.0470-7337.2 LD7337	Brake System: ATE Wear Warning Contact: prepared for wear indicator / excl. wear warning contact Ceramic
T6 AWD T6 Polestar AWD	228 05/19→ 240 05/19→	Brake Size: 17"; Fitting Position: Rear Axle		13.0460-7326.2 607326	Brake System: ATE 22141 15,5 Wear Warning Contact: prepared for wear indicator / excl. wear warning contact
T6 Drive-E Polestar AWD T6 Hybrid Polestar AWD T8 Plug-in Hybrid AWD T8 Twin Engine Polestar AWD	233 02/19→ 245 05/19→ 228 - 05/19→ 335 233 10/19→	Fitting Position: Rear Axle		13.0460-7326.2 607326	Brake System: ATE 22141 15,5 Wear Warning Contact: prepared for wear indicator / excl. wear warning contact
T6 Twin Engine AWD T8 Twin Engine AWD	186 02/19→ 223 02/19→	Fitting Position: Rear Axle		13.0460-7326.2 607326 13.0470-7326.2 LD7326	Brake System: ATE 22141 15,5 Wear Warning Contact: prepared for wear indicator / excl. wear warning contact Brake System: ATE Wear Warning Contact: prepared for wear indicator / excl. wear warning contact Ceramic
VOLVO - S70 (874) 11/96→11/00					
Guide Sleeve Kit, brake caliper					
2.0 2.0 Turbo 2.3 2.3 Turbo 2.4 2.4 AWD 2.4 Bifuel 2.4 Blu-Fuel 2.4 T5 AWD 2.4 Turbo 2.5 TDI 2.5 TDi AWD T5	93 - 01/97→11/00 132 155 - 01/97→11/00 166 195 04/99→09/00 184 01/97→11/00 103 - 01/97→11/00 125 103 - 11/96→09/00 121 106 10/98→11/00 103 07/97→09/00 142 11/96→04/99 142 01/97→11/00 103 01/97→11/00 103 10/99→09/00 176 01/97→11/00	Fitting Position: Front Axle		11.0101-5407.2 260011	Brake System: ATE
2.3 2.4 AWD 2.4 Bifuel	177 11/96→11/00 125 04/99→09/00 103 07/99→11/00	Construction year from: 01/97 →; Fitting Position: Front Axle → Construction year to: 05/99; Fitting Position: Front Axle Fitting Position: Front Axle		11.0101-5407.2 260011 11.0101-5407.2 260011 11.0101-5407.2 260011	Brake System: ATE Brake System: ATE Brake System: ATE
		→ Construction year to: 09/00; Fitting Position: Front Axle		11.0101-5407.2 260011	Brake System: ATE
Guide Bolt, brake caliper					
2.0 2.0 Turbo 2.3 2.3 Turbo 2.4 2.4 AWD 2.4 Bifuel 2.4 Blu-Fuel 2.4 T5 AWD 2.4 Turbo 2.5 TDI 2.5 TDi AWD T5	93 - 01/97→11/00 132 155 - 01/97→11/00 166 195 04/99→09/00 184 01/97→11/00 103 - 01/97→11/00 125 103 - 11/96→09/00 121 106 10/98→11/00 103 07/97→09/00 142 11/96→04/99 142 01/97→11/00 103 01/97→11/00 103 10/99→09/00 176 01/97→11/00	Required quantity: 2; Fitting Position: Front Axle		2 11.8171-0008.1 990049	Brake System: ATE
2.3 2.4 AWD	177 11/96→11/00 125 04/99→09/00	Construction year from: 01/97 →; Required quantity: 2; Fitting Position: Front Axle → Construction year to: 05/99; Required quantity: 2; Fitting Position: Front Axle		2 11.8171-0008.1 990049 2 11.8171-0008.1 990049	Brake System: ATE Brake System: ATE
→					

	kW				
VOLVO - S70 (874) 11/96→11/00					
Guide Bolt, brake caliper					
2.4 Bifuel	103	07/99→11/00	→ Construction year to: 09/00; Required quantity: 2; Fitting Position: Front Axle	2	11.8171-0008.1 990049 Brake System: ATE
			Required quantity: 2; Fitting Position: Front Axle	2	11.8171-0008.1 990049 Brake System: ATE
VOLVO - S80 I (184) 05/98→02/08					
Guide Sleeve Kit, brake caliper					
2.0	120	06/98→07/06	→ Construction year to: 02/06; Fitting Position: Front Axle		11.0101-5407.2 260011 Brake System: ATE
2.0 T	132 - 166	06/98→07/06			
2.4	103 - 125	01/99→07/06	→ Construction year to: 02/06; Fitting Position: Rear Axle		11.0101-5407.2 260011 Brake System: ATE
2.4 Bifuel	103	09/01→07/06			
2.4 D	96	10/01→07/06			
2.4 T	147	06/00→07/06			
2.5 T AWD	154	07/03→07/06			
2.5 TDI	103	01/99→07/06			
2.9	147 - 150	05/98→07/06			
3.0	144	06/01→07/06			
D5	120	08/01→07/06			
T6	200	06/01→07/06			
2.3 R	195	04/00→08/05	Fitting Position: Front Axle		11.0101-5407.2 260011 Brake System: ATE
T6	200	05/98→12/01	Fitting Position: Rear Axle		11.0101-5407.2 260011 Brake System: ATE
2.5 T	154	03/03→07/06	Construction year from: 07/03 → → Construction year to: 02/06; Fitting Position: Front Axle		11.0101-5407.2 260011 Brake System: ATE
			Construction year from: 07/03 → → Construction year to: 02/06; Fitting Position: Rear Axle		11.0101-5407.2 260011 Brake System: ATE
T5 AWD	147	04/00→09/03	Construction year from: 06/00 →; Fitting Position: Front Axle		11.0101-5407.2 260011 Brake System: ATE
			Construction year from: 06/00 →; Fitting Position: Rear Axle		11.0101-5407.2 260011 Brake System: ATE
Guide Bolt, brake caliper					
2.0	120	06/98→07/06	→ Construction year to: 02/06;	2	11.8171-0008.1 990049 Brake System: ATE
2.0 T	132 - 166	06/98→07/06	Required quantity: 2		
2.4	103 - 125	01/99→07/06			
2.4 Bifuel	103	09/01→07/06			
2.4 D	96	10/01→07/06			
2.4 T	147	06/00→07/06			
2.5 T AWD	154	07/03→07/06			
2.5 TDI	103	01/99→07/06			
2.9	147 - 150	05/98→07/06			
3.0	144	06/01→07/06			
D5	120	08/01→07/06			
T6	200	06/01→07/06			
2.3 R	195	04/00→08/05	Required quantity: 2	2	11.8171-0008.1 990049 Brake System: ATE
T6	200	05/98→12/01			
2.5 T	154	03/03→07/06	Construction year from: 07/03 → → Construction year to: 02/06; Required quantity: 2	2	11.8171-0008.1 990049 Brake System: ATE
T5 AWD	147	04/00→09/03	Construction year from: 06/00 →; Required quantity: 2	2	11.8171-0008.1 990049 Brake System: ATE
VOLVO - S80 II (124) 03/06→12/16					
Guide Bolt, brake caliper					
1.6 D DRIVE	80	01/10→12/11	Required quantity: 2	2	11.8171-0008.1 990049 Brake System: ATE
1.6 DRIVE	84	06/11→01/14			
2.0	107	01/08→09/12			
2.0 Drive- E	180	12/14→12/16			
2.0 FlexFuel	107	01/08→12/11			
2.0 T	149	01/10→05/11			
2.0 TDi	100	02/08→03/11			
2.4 D	120 - 129	03/06→03/11			
2.5 T	147 - 187	03/06→12/16			
2.5 T FlexFuel	147 - 170	05/08→12/11			
3.2	175 - 179	03/06→12/14			
3.2 AWD	175 - 179	01/07→12/12			
→					

	kW				
VOLVO - S80 II (124) 03/06→12/16					
Guide Bolt, brake caliper					
3.2 Flexifuel AWD	177	01/09→03/10	Required quantity: 2	2	11.8171-0008.1 990049 Brake System: ATE
4.4 V8 AWD	232	03/06→03/12			
D2	85	01/14→12/16			
D3	100	05/12→05/14			
D3 / D4	120	01/10→12/16			
D4	133	09/13→12/16			
D5	136 -	03/06→04/15			
	158				
D5 AWD	136 -	01/07→04/15			
	158				
T4	132	10/10→04/14			
T4F	132	05/11→01/14			
T5	162 -	10/10→12/16			
	180				
T6 AWD	210 -	01/07→12/16			
	224				
VOLVO - S90 II (234) 01/16→					
Guide Sleeve Kit, brake caliper					
2.0	183	03/16→	Brake Size: 16" / 17";	11.0101-5407.2 260011	Brake System: ATE
B4 Mild-Hybrid	145	03/20→	Fitting Position: Front Axle		
B5 Mild-Hybrid	183 -	03/20→	Fitting Position: Rear Axle	11.0101-5407.2 260011	Brake System: ATE
	184				
B5 Mild Hybrid AWD	173	05/20→			
B6 Mild-Hybrid AWD	220	03/20→			
D3	110	03/16→08/18			
D4	120 -	03/16→			
	140				
D4 AWD	140	03/16→			
D4 Drive-E Polestar	147	03/16→			
D4 Drive-E Polestar AWD	147	03/16→			
D5 AWD	173	03/16→			
D5 Polestar AWD	177	06/19→			
T4	140	10/17→			
T4 Polestar	155	06/19→			
T5	184 -	03/16→			
	187				
T5 Drive-E Polestar	186 -	03/16→			
	192				
T6 AWD	228 -	03/16→			
	235				
T6 Drive-E Polestar AWD	240 -	03/16→			
	246				
T8 Hybrid AWD	223	04/18→			
T8 Hybrid Polestar AWD	233	01/19→			
T8 Plug-in Hybrid AWD	235	10/17→			
T8 Plug-in Hybrid Polestar AWD	246	10/17→			
T8 Plug-in Hybrid AWD	228 -	01/22→	Brake Size: 17";	11.0101-5407.2 260011	Brake System: ATE
	335		Fitting Position: Front Axle		
			Fitting Position: Rear Axle	11.0101-5407.2 260011	Brake System: ATE
Guide Bolt, brake caliper					
2.0	183	03/16→	Brake Size: 16" / 17";	11.8171-0008.1 990049	Brake System: ATE
B4 Mild-Hybrid	145	03/20→	Fitting Position: Front Axle		
B5 Mild-Hybrid	183 -	03/20→	Fitting Position: Rear Axle	11.8171-0008.1 990049	Brake System: ATE
	184				
B5 Mild Hybrid AWD	173	05/20→			
B6 Mild-Hybrid AWD	220	03/20→			
D3	110	03/16→08/18			
D4	120 -	03/16→			
	140				
D4 AWD	140	03/16→			
D4 Drive-E Polestar	147	03/16→			
D4 Drive-E Polestar AWD	147	03/16→			
D5 AWD	173	03/16→			
D5 Polestar AWD	177	06/19→			
T4	140	10/17→			
T4 Polestar	155	06/19→			
T5	184 -	03/16→			
	187				
T5 Drive-E Polestar	186 -	03/16→			
	192				
T6 AWD	228 -	03/16→			
	235				
T6 Drive-E Polestar AWD	240 -	03/16→			
	246				
T8 Hybrid AWD	223	04/18→			
T8 Hybrid Polestar AWD	233	01/19→			
T8 Plug-in Hybrid AWD	235	10/17→			
→					

	kW				
VOLVO - S90 II (234) 01/16→					
Guide Bolt, brake caliper					
T8 Plug-in Hybrid Polestar AWD	246 10/17→		Brake Size: 16" / 17"; Fitting Position: Front Axle	11.8171-0008.1 990049	Brake System: ATE
			Fitting Position: Rear Axle	11.8171-0008.1 990049	Brake System: ATE
T8 Plug-in Hybrid AWD	228 - 01/22→ 335		Brake Size: 17"; Fitting Position: Front Axle	11.8171-0008.1 990049	Brake System: ATE
			Fitting Position: Rear Axle	11.8171-0008.1 990049	Brake System: ATE
 Brake Pad Set, disc brake					
2.0	183 03/16→		Brake Size: 17"; Fitting Position: Rear Axle	13.0460-7326.2 607326	Brake System: ATE 22141 15,5 Wear Warning Contact: prepared for wear indicator / excl. wear warning contact
B4 Mild-Hybrid	145 03/20→				
B5 Mild-Hybrid	184 03/20→			13.0470-7326.2 LD7326	Brake System: ATE Wear Warning Contact: prepared for wear indicator / excl. wear warning contact Ceramic
B5 Mild Hybrid AWD	173 05/20→				
B6 Mild-Hybrid AWD	220 03/20→				
D3	110 03/16→08/18				
D4	120 - 03/16→ 140				
D4 AWD	140 03/16→				
D4 Drive-E Polestar	147 03/16→		Brake Size: 16"; Fitting Position: Rear Axle	13.0470-7337.2 LD7337	Brake System: ATE Wear Warning Contact: prepared for wear indicator / excl. wear warning contact Ceramic
D4 Drive-E Polestar AWD	147 03/16→				
D5 AWD	173 03/16→				
D5 Polestar AWD	177 06/19→				
T4	140 10/17→				
T4 Polestar	155 06/19→				
T5	184 - 03/16→ 187				
T5 Drive-E Polestar	186 - 03/16→ 192				
T8 Hybrid AWD	223 04/18→				
T6 AWD	228 - 03/16→ 235		Brake Size: 17"; Fitting Position: Rear Axle	13.0460-7326.2 607326	Brake System: ATE 22141 15,5 Wear Warning Contact: prepared for wear indicator / excl. wear warning contact
T6 Drive-E Polestar AWD	240 - 03/16→ 246				
T8 Hybrid Polestar AWD	233 01/19→				
T8 Plug-in Hybrid AWD	235 10/17→				
T8 Plug-in Hybrid Polestar AWD	246 10/17→				
VOLVO - V40 Cross Country (526) 10/12→					
Guide Sleeve Kit, brake caliper					
T4 AWD	132 - 07/13→ 140		Fitting Position: Front Axle	11.0101-5407.2 260011	Brake System: ATE
T5 AWD	157 - 01/13→ 187		Fitting Position: Rear Axle	11.0101-5407.2 260011	Brake System: ATE
T5 Polestar AWD	186 01/15→				
Guide Bolt, brake caliper					
T4 AWD	132 - 07/13→ 140		Required quantity: 2	2 11.8171-0008.1 990049	Brake System: ATE
T5 AWD	157 - 01/13→ 187				
VOLVO - V40 Hatchback (525) 03/12→					
Guide Sleeve Kit, brake caliper					
D2	84 03/12→		Construction year from: 09/12 →; Fitting Position: Front Axle	11.0101-5407.2 260011	Brake System: ATE
D3	110 03/12→03/15				
D4	130 03/12→		Construction year from: 09/12 →; Fitting Position: Rear Axle	11.0101-5407.2 260011	Brake System: ATE
T3 GTDi	110 03/12→				
T4 GTDi	132 03/12→12/16				
D2	88 02/15→08/18		Fitting Position: Front Axle	11.0101-5407.2 260011	Brake System: ATE
D3	110 04/15→		Fitting Position: Rear Axle	11.0101-5407.2 260011	Brake System: ATE
D4	140 05/14→				
D4 Polestar	147 05/14→				
T2	90 02/15→				
T2 GTDi	88 03/13→12/15				
T3	90 - 02/15→ 112				
T4	132 - 07/13→ 147				
T5	157 - 12/12→ 187				
T5 Drive-E Polestar	186 05/14→				
T5	183 01/14→		Construction year from: 05/14 →; Fitting Position: Front Axle	11.0101-5407.2 260011	Brake System: ATE
			Construction year from: 05/14 →; Fitting Position: Rear Axle	11.0101-5407.2 260011	Brake System: ATE
→					

	kW								
VOLVO - V40 Hatchback (525) 03/12→									
Guide Bolt, brake caliper									
D2	84 03/12→	Construction year from: 09/12 →; Required quantity: 2	2	11.8171-0008.1 990049	Brake System: ATE				
D3	110 03/12→03/15								
D4	130 03/12→								
T3 GTDi	110 03/12→								
T4 GTDi	132 03/12→12/16								
D2	88 02/15→08/18	Required quantity: 2	2	11.8171-0008.1 990049	Brake System: ATE				
D3	110 04/15→								
D4	140 05/14→								
T2	90 02/15→								
T2 GTDi	88 03/13→12/15								
T3	90 - 02/15→								
	112								
T4	132 - 07/13→								
	147								
T5	157 - 12/12→								
T5	183 01/14→	Construction year from: 05/14 →; Required quantity: 2	2	11.8171-0008.1 990049	Brake System: ATE				
VOLVO - V40 Hatchback Van (525) 09/13→12/15									
Guide Sleeve Kit, brake caliper									
1.6 D2/ DRIVE	84 09/13→12/15	Fitting Position: Front Axle		11.0101-5407.2 260011	Brake System: ATE				
2.0 D3	110 09/13→12/15	Fitting Position: Rear Axle		11.0101-5407.2 260011	Brake System: ATE				
2.0 D4	130 09/13→12/14								
Guide Bolt, brake caliper									
1.6 D2/ DRIVE	84 09/13→12/15	Required quantity: 2	2	11.8171-0008.1 990049	Brake System: ATE				
2.0 D3	110 09/13→12/15								
2.0 D4	130 09/13→12/14								
VOLVO - V50 (545) 12/03→12/12									
Spring, brake caliper									
1.6	74 01/05→12/12	→ Construction year to: 05/12; Required quantity: 2; Fitting Position: Front Axle	2	11.8116-0356.1 390586	Brake System: ATE				
1.6 D	80 03/05→12/12								
2.0	107 10/06→12/12								
2.0 FlexFuel	107 01/10→12/12								
D2	84 01/10→12/12								
D3	110 10/10→12/12								
D4	130 10/10→12/12								
T5	169 03/07→12/12								
1.6 D	81 01/05→12/11	Required quantity: 2; Fitting Position: Front Axle	2	11.8116-0356.1 390586	Brake System: ATE				
1.8	92 04/04→12/10								
1.8 BiFuel	93 01/09→09/10								
1.8 FlexFuel	92 01/05→12/10								
2.0 CDI	98 12/03→12/06								
2.0 D	100 04/04→12/10								
2.0 D4	96 07/05→12/06								
2.4	103 - 04/04→12/10								
	125								
2.4 AWD	125 08/06→12/09								
2.4 Tdi	120 05/07→12/10								
D5	132 03/06→12/10								
T5	162 04/04→12/07								
T5 AWD	162 - 04/04→12/10								
	169								
Guide Sleeve Kit, brake caliper									
1.6	74 01/05→12/12					→ Construction year to: 05/12; Fitting Position: Front Axle		11.0101-5407.2 260011	Brake System: ATE
1.6 D	80 03/05→12/12								
2.0	107 10/06→12/12	Vehicle Identification Number from: 491292 →; → Construction year to: 05/12; Fitting Position: Rear Axle		11.0101-5407.2 260011	Brake System: ATE				
2.0 FlexFuel	107 01/10→12/12								
D2	84 01/10→12/12								
D3	110 10/10→12/12								
D4	130 10/10→12/12								
T5	169 03/07→12/12	→ Vehicle Identification Number to: 491291; Fitting Position: Rear Axle		11.0101-5407.2 260011	Brake System: ATE				
1.6 D	81 01/05→12/11	Fitting Position: Front Axle		11.0101-5407.2 260011	Brake System: ATE				
1.8	92 04/04→12/10	Vehicle Identification Number from: 491292 →; Fitting Position: Rear Axle		11.0101-5407.2 260011	Brake System: ATE				
1.8 BiFuel	93 01/09→09/10								
1.8 FlexFuel	92 01/05→12/10	→ Vehicle Identification Number to: 491291; Fitting Position: Rear Axle		11.0101-5407.2 260011	Brake System: ATE				
2.0 CDI	98 12/03→12/06								
2.0 D	100 04/04→12/10								
2.0 D4	96 07/05→12/06								
2.4	103 - 04/04→12/10								
	125								
2.4 AWD	125 08/06→12/09								
2.4 Tdi	120 05/07→12/10								
D5	132 03/06→12/10								
T5	162 04/04→12/07								
T5 AWD	162 - 04/04→12/10								
	169								
→									

	kW				
VOLVO - V50 (545) 12/03→12/12					
Guide Bolt, brake caliper					
1.6	74	01/05→12/12	→ Construction year to: 05/12; Required quantity: 2	2	11.8171-0008.1 990049 Brake System: ATE
1.6 D	80	03/05→12/12			
2.0	107	10/06→12/12	Vehicle Identification Number from: 491292 →;	2	11.8171-0008.1 990049 Brake System: ATE
2.0 FlexFuel	107	01/10→12/12			
D2	84	01/10→12/12	→ Construction year to: 05/12;		
D3	110	10/10→12/12	Required quantity: 2		
D4	130	10/10→12/12	→ Vehicle Identification Number to: 491291; Required quantity: 2	2	11.8171-0008.1 990049 Brake System: ATE
T5	169	03/07→12/12			
1.6 D	81	01/05→12/11	Required quantity: 2	2	11.8171-0008.1 990049 Brake System: ATE
1.8	92	04/04→12/10			
1.8 BiFuel	93	01/09→09/10	Vehicle Identification Number from: 491292 →; Required quantity: 2	2	11.8171-0008.1 990049 Brake System: ATE
1.8 FlexFuel	92	01/05→12/10			
2.0 CDI	98	12/03→12/06	→ Vehicle Identification Number to: 491291; Required quantity: 2	2	11.8171-0008.1 990049 Brake System: ATE
2.0 D	100	04/04→12/10			
2.0 D4	96	07/05→12/06			
2.4	103 -	04/04→12/10			
	125				
2.4 AWD	125	08/06→12/09			
2.4 Tdi	120	05/07→12/10			
D5	132	03/06→12/10			
T5	162	04/04→12/07			
T5 AWD	162 -	04/04→12/10			
	169				
VOLVO - V60 I (155) 07/10→12/18					
Guide Sleeve Kit, brake caliper					
1.6 DRIVe	84	02/11→12/15	Construction year from: 06/11 →;		11.0101-5407.2 260011 Brake System: ATE
D5	158	04/11→12/15	for brake disc diameter [mm]: 300;		
D5 AWD	158	04/11→12/15	Fitting Position: Front Axle		
2.0 BiFuel	157	03/14→12/15	for brake disc diameter [mm]: 300;		11.0101-5407.2 260011 Brake System: ATE
2.0 T	132	01/14→07/18	Fitting Position: Front Axle		
D2	88	03/15→05/18			
D3	110	03/15→05/18			
D4	133 -	10/13→05/18			
	140				
D4 AWD	133 -	10/13→05/18			
	140				
D5	165 -	04/14→05/18			
	169				
D5 AWD	169	04/14→12/15			
D5 Hybrid AWD	120	03/15→05/18			
D6 Hybrid AWD	162	03/15→05/18			
T3	112	03/15→05/18			
T4F	132	04/11→12/15			
T5	162 -	08/12→12/18			
	180				
T6	224 -	10/13→12/18			
	225				
T6 AWD	225 -	10/13→12/18			
	242				
2.0 T	149	07/10→12/12	Construction year from: 11/10 →;		11.0101-5407.2 260011 Brake System: ATE
D3 / D4	120	07/10→12/14	for brake disc diameter [mm]: 300;		
D5	151	07/10→12/11	Fitting Position: Front Axle		
D5 AWD	151	07/10→12/11			
T3	110	09/10→12/15			
T4	132	09/10→12/15			
T5	177	09/10→12/14			
T6 AWD	224	07/10→12/15			
2.4 Hybrid D6 Polestar AWD	169	06/12→12/15	Construction year from: 11/12 →;		11.0101-5407.2 260011 Brake System: ATE
D6 Hybrid AWD	158	06/12→12/15	for brake disc diameter [mm]: 300;		
			Fitting Position: Front Axle		
D3	100	05/12→12/15	Construction year from: 10/12 →;		11.0101-5407.2 260011 Brake System: ATE
			for brake disc diameter [mm]: 300;		
			Fitting Position: Front Axle		
D4 AWD	120	05/12→12/15	Construction year from: 12/12 →;		11.0101-5407.2 260011 Brake System: ATE
			for brake disc diameter [mm]: 300;		
			Fitting Position: Front Axle		
T2	90	10/15→03/17	Construction year from: 01/16 →;		11.0101-5407.2 260011 Brake System: ATE
			for brake disc diameter [mm]: 300;		
			Fitting Position: Front Axle		
T4	140	03/15→05/18	Construction year from: 05/15 →;		11.0101-5407.2 260011 Brake System: ATE
			for brake disc diameter [mm]: 300;		
			Fitting Position: Front Axle		
T5	157	10/13→05/18	Construction year from: 04/14 →;		11.0101-5407.2 260011 Brake System: ATE
			for brake disc diameter [mm]: 300;		
			Fitting Position: Front Axle		
Guide Bolt, brake caliper					
1.6 DRIVe	84	02/11→12/15	Construction year from: 06/11 →;	2	11.8171-0008.1 990049 Brake System: ATE
D5	158	04/11→12/15	for brake disc diameter [mm]: 300;		
→					

	kW				
VOLVO - V60 I (155) 07/10→12/18					
Guide Bolt, brake caliper					
D5 AWD	158 04/11→12/15	Required quantity: 2; Fitting Position: Front Axle			
		Construction year from: 06/11 →; for brake disc diameter [mm]: 336; Required quantity: 2; Fitting Position: Front Axle	2	11.8171-0008.1 990049	Brake System: ATE
2.0 BiFuel	157 03/14→12/15	for brake disc diameter [mm]: 300;	2	11.8171-0008.1 990049	Brake System: ATE
2.0 T	132 01/14→07/18	Required quantity: 2;			
D2	88 03/15→05/18	Fitting Position: Front Axle			
D3	110 03/15→05/18	for brake disc diameter [mm]: 336;	2	11.8171-0008.1 990049	Brake System: ATE
D4	133 - 10/13→05/18	Required quantity: 2;			
	140	Fitting Position: Front Axle			
D4 AWD	133 - 10/13→05/18				
	140				
D5	165 - 04/14→05/18				
	169				
D5 AWD	169 04/14→12/15				
D5 Hybrid AWD	120 03/15→05/18				
D6 Hybrid AWD	162 03/15→05/18				
T3	112 03/15→05/18				
T4F	132 04/11→12/15				
T5	162 - 08/12→12/18				
	180				
T6	224 - 10/13→12/18				
	225				
T6 AWD	225 - 10/13→12/18				
	242				
2.0 T	149 07/10→12/12	Construction year from: 11/10 →;	2	11.8171-0008.1 990049	Brake System: ATE
D3 / D4	120 07/10→12/14	for brake disc diameter [mm]: 300;			
D5	151 07/10→12/11	Required quantity: 2;			
D5 AWD	151 07/10→12/11	Fitting Position: Front Axle			
T3	110 09/10→12/15	Construction year from: 11/10 →;	2	11.8171-0008.1 990049	Brake System: ATE
T4	132 09/10→12/15	for brake disc diameter [mm]: 336;			
T5	177 09/10→12/14	Required quantity: 2;			
T6 AWD	224 07/10→12/15	Fitting Position: Front Axle			
2.4 Hybrid D6 Polestar AWD	169 06/12→12/15	Construction year from: 11/12 →;	2	11.8171-0008.1 990049	Brake System: ATE
D6 Hybrid AWD	158 06/12→12/15	for brake disc diameter [mm]: 300;			
		Required quantity: 2;			
		Fitting Position: Front Axle			
		Construction year from: 11/12 →;	2	11.8171-0008.1 990049	Brake System: ATE
		for brake disc diameter [mm]: 336;			
		Required quantity: 2;			
		Fitting Position: Front Axle			
D3	100 05/12→12/15	Construction year from: 10/12 →;	2	11.8171-0008.1 990049	Brake System: ATE
		for brake disc diameter [mm]: 336;			
		Required quantity: 2;			
		Fitting Position: Front Axle			
		Construction year from: 10/12 →;	2	11.8171-0008.1 990049	Brake System: ATE
		for brake disc diameter [mm]: 300;			
		Required quantity: 2;			
		Fitting Position: Front Axle			
D4 AWD	120 05/12→12/15	Construction year from: 12/12 →;	2	11.8171-0008.1 990049	Brake System: ATE
		for brake disc diameter [mm]: 300;			
		Required quantity: 2;			
		Fitting Position: Front Axle			
		Construction year from: 12/12 →;	2	11.8171-0008.1 990049	Brake System: ATE
		for brake disc diameter [mm]: 336;			
		Required quantity: 2;			
		Fitting Position: Front Axle			
T2	90 10/15→03/17	Construction year from: 01/16 →;	2	11.8171-0008.1 990049	Brake System: ATE
		for brake disc diameter [mm]: 300;			
		Required quantity: 2;			
		Fitting Position: Front Axle			
		Construction year from: 01/16 →;	2	11.8171-0008.1 990049	Brake System: ATE
		for brake disc diameter [mm]: 336;			
		Required quantity: 2;			
		Fitting Position: Front Axle			
T4	140 03/15→05/18	Construction year from: 05/15 →;	2	11.8171-0008.1 990049	Brake System: ATE
		for brake disc diameter [mm]: 300;			
		Required quantity: 2;			
		Fitting Position: Front Axle			
		Construction year from: 05/15 →;	2	11.8171-0008.1 990049	Brake System: ATE
		for brake disc diameter [mm]: 336;			
		Required quantity: 2;			
		Fitting Position: Front Axle			
T5	157 10/13→05/18	Construction year from: 04/14 →;	2	11.8171-0008.1 990049	Brake System: ATE
		for brake disc diameter [mm]: 300;			
		Required quantity: 2;			
		Fitting Position: Front Axle			
→					

	kW				
VOLVO - V60 II (225) 02/18→					
Guide Bolt, brake caliper					
2.0 T6 Drive-E Polestar AWD	240 02/18→		Brake Size: 16" / 17"; Fitting Position: Front Axle	11.8171-0008.1 990049	Brake System: ATE
B3 Mild-Hybrid	120 03/20→		Fitting Position: Rear Axle	11.8171-0008.1 990049	Brake System: ATE
B4 Mild-Hybrid	145 03/20→				
B5 Mild-Hybrid	184 03/20→				
B5 Mild-Hybrid AWD	184 03/20→				
B6 Mild-Hybrid AWD	220 03/20→				
D3	110 02/18→				
D3 AWD	110 09/18→				
D4	140 02/18→				
D4 AWD	140 09/18→				
D4 Polestar	147 02/18→				
D4 Polestar AWD	147 02/18→12/20				
T4	140 05/19→				
T4 Polestar	155 07/19→				
T5	184 02/18→				
T5 AWD	184 09/18→				
T5 Polestar	186 07/19→				
T5 Polestar AWD	186 07/19→				
T6 AWD	228 02/18→				
T6 Plug-in Hybrid AWD	186 03/19→				
T8 Plug-in Hybrid AWD	223 - 02/18→ 335				
T8 Plug-in Hybrid Polestar AWD	233 05/19→				
 Brake Pad Set, disc brake					
2.0 T6 Drive-E Polestar AWD	240 02/18→		Brake Size: 17"; Fitting Position: Rear Axle	13.0460-7326.2 607326	Brake System: ATE 22141 15,5 Wear Warning Contact: prepared for wear indicator / excl. wear warning contact
T6 AWD	228 02/18→				
T8 Plug-in Hybrid Polestar AWD	233 05/19→				
D3	110 02/18→		Brake Size: 17"; Fitting Position: Rear Axle	13.0460-7326.2 607326	Brake System: ATE 22141 15,5 Wear Warning Contact: prepared for wear indicator / excl. wear warning contact
D3 AWD	110 09/18→				
D4	140 02/18→				
D4 AWD	140 09/18→				
D4 Polestar	147 02/18→				
D4 Polestar AWD	147 02/18→12/20			13.0470-7326.2 LD7326	Brake System: ATE Wear Warning Contact: prepared for wear indicator / excl. wear warning contact Ceramic
T4	140 05/19→				
T4 Polestar	155 07/19→				
T5	184 02/18→				
T5 AWD	184 09/18→		Brake Size: 16"; Fitting Position: Rear Axle	13.0470-7337.2 LD7337	Brake System: ATE Wear Warning Contact: prepared for wear indicator / excl. wear warning contact Ceramic
T5 Polestar	186 07/19→				
T5 Polestar AWD	186 07/19→				
T6 Plug-in Hybrid AWD	186 03/19→				
T8 Plug-in Hybrid AWD	223 02/18→				
VOLVO - V60 II Cross Country (227) 02/18→					
Guide Sleeve Kit, brake caliper					
B4 Mild-Hybrid AWD	145 10/20→		Brake Size: 16" / 17"; Fitting Position: Front Axle	11.0101-5407.2 260011	Brake System: ATE
B5 Mild-Hybrid AWD	183 03/22→		Fitting Position: Rear Axle	11.0101-5407.2 260011	Brake System: ATE
Guide Bolt, brake caliper					
B4 Mild-Hybrid AWD	145 10/20→		Brake Size: 16" / 17"; Fitting Position: Front Axle	11.8171-0008.1 990049	Brake System: ATE
B5 Mild-Hybrid AWD	183 03/22→		Fitting Position: Rear Axle	11.8171-0008.1 990049	Brake System: ATE
VOLVO - V70 I (875, 876) 12/95→12/00					
Guide Sleeve Kit, brake caliper					
2.0	93 - 12/95→03/00 132		Construction year from: 01/97 →; Fitting Position: Front Axle	11.0101-5407.2 260011	Brake System: ATE
2.0 Turbo	155 12/95→03/00				
2.3 Turbo	184 12/95→03/00				
2.4	106 12/95→03/00				
2.5 TDi AWD	103 11/96→02/00				
2.0	120 01/97→12/00		→ Construction year to: 03/00; Fitting Position: Front Axle	11.0101-5407.2 260011	Brake System: ATE
2.3 T-5 AWD	176 01/97→12/00				
2.4 Bifuel	103 08/99→12/00				
2.4 Turbo AWD	195 03/99→12/00				
2.0 Turbo	166 11/96→12/00		Construction year from: 01/97 → → Construction year to: 03/00; Fitting Position: Front Axle	11.0101-5407.2 260011	Brake System: ATE
2.0 Turbo AWD	166 11/96→12/00				
2.3	177 11/96→11/00				
2.3 T-5	176 11/96→12/00				
2.4	125 12/95→05/00				
2.4 Turbo	142 04/96→12/00				
2.4 Turbo AWD	142 04/96→12/00				
2.5 TDI	103 12/95→12/00				
2.3 AWD	177 04/97→09/98		Fitting Position: Front Axle	11.0101-5407.2 260011	Brake System: ATE
→					

	kW				
VOLVO - V70 I (875, 876) 12/95→12/00					
Guide Sleeve Kit, brake caliper					
2.3 T AWD	184	04/97→03/00	Fitting Position: Front Axle	11.0101-5407.2 260011	Brake System: ATE
2.4	121	06/98→12/99			
2.4	103	03/99→12/00	Construction year from: 08/99 → → Construction year to: 03/00; Fitting Position: Front Axle	11.0101-5407.2 260011	Brake System: ATE
2.4 AWD	121	06/98→12/99	Construction year from: 10/98 → → Construction year to: 05/99; Fitting Position: Front Axle	11.0101-5407.2 260011	Brake System: ATE
2.4 Bifuel	106	05/98→12/99	Construction year from: 10/98 → → Construction year to: 08/99; Fitting Position: Front Axle	11.0101-5407.2 260011	Brake System: ATE
Guide Bolt, brake caliper					
2.0	93 - 132	12/95→03/00	Construction year from: 01/97 → ; Required quantity: 2; Fitting Position: Front Axle	2 11.8171-0008.1 990049	Brake System: ATE
2.0 Turbo	155	12/95→03/00			
2.3 Turbo	184	12/95→03/00			
2.4	106	12/95→03/00			
2.5 TDi AWD	103	11/96→02/00			
2.0	120	01/97→12/00	→ Construction year to: 03/00; Required quantity: 2; Fitting Position: Front Axle	2 11.8171-0008.1 990049	Brake System: ATE
2.3 T-5 AWD	176	01/97→12/00			
2.4 Bifuel	103	08/99→12/00			
2.4 Turbo AWD	195	03/99→12/00			
2.0 Turbo	166	11/96→12/00	Construction year from: 01/97 → → Construction year to: 03/00; Required quantity: 2; Fitting Position: Front Axle	2 11.8171-0008.1 990049	Brake System: ATE
2.0 Turbo AWD	166	11/96→12/00			
2.3	177	11/96→11/00			
2.3 T-5	176	11/96→12/00			
2.4	125	12/95→05/00			
2.4 Turbo	142	04/96→12/00			
2.4 Turbo AWD	142	04/96→12/00			
2.5 TDI	103	12/95→12/00			
2.3 AWD	177	04/97→09/98	Required quantity: 2; Fitting Position: Front Axle	2 11.8171-0008.1 990049	Brake System: ATE
2.3 T AWD	184	04/97→03/00			
2.4	121	06/98→12/99			
2.4	103	03/99→12/00	Construction year from: 08/99 → → Construction year to: 03/00; Required quantity: 2; Fitting Position: Front Axle	2 11.8171-0008.1 990049	Brake System: ATE
2.4 AWD	121	06/98→12/99	Construction year from: 10/98 → → Construction year to: 05/99; Required quantity: 2; Fitting Position: Front Axle	2 11.8171-0008.1 990049	Brake System: ATE
2.4 Bifuel	106	05/98→12/99	Construction year from: 10/98 → → Construction year to: 08/99; Required quantity: 2; Fitting Position: Front Axle	2 11.8171-0008.1 990049	Brake System: ATE
VOLVO - V70 II (285) 11/99→12/08					
Guide Sleeve Kit, brake caliper					
2.0 T	132	11/99→08/07	Construction year from: 01/03 → → Construction year to: 07/07; Fitting Position: Front Axle	11.0101-5407.2 260011	Brake System: ATE
			Construction year from: 07/01 → → Construction year to: 12/02; Fitting Position: Front Axle	11.0101-5407.2 260011	Brake System: ATE
			Construction year from: 07/01 → → Construction year to: 07/07; Fitting Position: Rear Axle	11.0101-5407.2 260011	Brake System: ATE
2.3	195	10/00→09/04	→ Construction year to: 12/02; Fitting Position: Front Axle	11.0101-5407.2 260011	Brake System: ATE
2.5 AWD	155	09/02→12/04	Construction year from: 01/03 → ; Fitting Position: Front Axle	11.0101-5407.2 260011	Brake System: ATE
			Fitting Position: Rear Axle	11.0101-5407.2 260011	Brake System: ATE
2.4	103 - 125	03/00→08/07	Construction year from: 01/03 → → Construction year to: 07/07; Fitting Position: Front Axle	11.0101-5407.2 260011	Brake System: ATE
2.4 Bifuel	103	09/01→08/07	→ Construction year to: 12/02; Fitting Position: Front Axle	11.0101-5407.2 260011	Brake System: ATE
			→ Construction year to: 07/07; Fitting Position: Rear Axle	11.0101-5407.2 260011	Brake System: ATE
2.4 CDI	90	07/05→12/08	Fitting Position: Front Axle	11.0101-5407.2 260011	Brake System: ATE
2.4 T AWD	147	09/01→08/02	Fitting Position: Rear Axle	11.0101-5407.2 260011	Brake System: ATE
2.4 D	93	04/05→12/08	Construction year from: 05/05 → → Construction year to: 07/07; Fitting Position: Front Axle	11.0101-5407.2 260011	Brake System: ATE
→					

	kW				
VOLVO - V70 II (285) 11/99→12/08					
Guide Sleeve Kit, brake caliper					
2.4 D	93	04/05→12/08	Construction year from: 05/05 → → Construction year to: 07/07; Fitting Position: Rear Axle	11.0101-5407.2 260011	Brake System: ATE
2.4 D	96	07/01→08/07	Construction year from: 01/03 → → Construction year to: 07/07; Fitting Position: Front Axle	11.0101-5407.2 260011	Brake System: ATE
			Construction year from: 12/01 → → Construction year to: 12/02; Fitting Position: Front Axle	11.0101-5407.2 260011	Brake System: ATE
			Construction year from: 12/01 → → Construction year to: 07/07; Fitting Position: Rear Axle	11.0101-5407.2 260011	Brake System: ATE
2.4 T T5	147 184	11/99→08/03 11/99→12/04	Construction year from: 03/00 → → Construction year to: 12/02; Fitting Position: Front Axle	11.0101-5407.2 260011	Brake System: ATE
			Construction year from: 01/03 → →; Fitting Position: Front Axle	11.0101-5407.2 260011	Brake System: ATE
			Construction year from: 03/00 → →; Fitting Position: Rear Axle	11.0101-5407.2 260011	Brake System: ATE
2.5 T	154	07/01→08/07	Construction year from: 04/04 → → Construction year to: 07/07; Fitting Position: Front Axle	11.0101-5407.2 260011	Brake System: ATE
			Construction year from: 04/04 → → Construction year to: 07/07; Fitting Position: Rear Axle	11.0101-5407.2 260011	Brake System: ATE
2.5 T AWD	154	07/02→08/07	Construction year from: 01/03 → → Construction year to: 07/07; Fitting Position: Front Axle	11.0101-5407.2 260011	Brake System: ATE
			Construction year from: 09/02 → → Construction year to: 12/02; Fitting Position: Front Axle	11.0101-5407.2 260011	Brake System: ATE
			Construction year from: 09/02 → → Construction year to: 07/07; Fitting Position: Rear Axle	11.0101-5407.2 260011	Brake System: ATE
2.5 TDI	103	11/99→08/07	Construction year from: 03/00 → → Construction year to: 12/02; Fitting Position: Front Axle	11.0101-5407.2 260011	Brake System: ATE
			Construction year from: 01/03 → → Construction year to: 07/07; Fitting Position: Front Axle	11.0101-5407.2 260011	Brake System: ATE
			Construction year from: 01/03 → → Construction year to: 07/07; Fitting Position: Rear Axle	11.0101-5407.2 260011	Brake System: ATE
D5	120	01/01→12/08	Construction year from: 01/03 → → Construction year to: 07/07; Fitting Position: Front Axle	11.0101-5407.2 260011	Brake System: ATE
			Construction year from: 08/01 → → Construction year to: 12/02; Fitting Position: Front Axle	11.0101-5407.2 260011	Brake System: ATE
			Construction year from: 08/01 → → Construction year to: 07/07; Fitting Position: Rear Axle	11.0101-5407.2 260011	Brake System: ATE
D5 D5 AWD	136 136	04/05→12/08 05/05→08/07	Construction year from: 12/05 → → Construction year to: 07/07; Fitting Position: Front Axle	11.0101-5407.2 260011	Brake System: ATE
			Construction year from: 12/05 → → Construction year to: 07/07; Fitting Position: Rear Axle	11.0101-5407.2 260011	Brake System: ATE
D5 AWD	120	07/02→08/07	Construction year from: 03/03 → → Construction year to: 07/07; Fitting Position: Front Axle	11.0101-5407.2 260011	Brake System: ATE
			Construction year from: 03/03 → → Construction year to: 07/07; Fitting Position: Rear Axle	11.0101-5407.2 260011	Brake System: ATE
T5	191	04/04→08/07	→ Construction year to: 07/07; Fitting Position: Front Axle	11.0101-5407.2 260011	Brake System: ATE
			→ Construction year to: 07/07; Fitting Position: Rear Axle	11.0101-5407.2 260011	Brake System: ATE
Guide Bolt, brake caliper					
2.0 T	132	11/99→08/07	Construction year from: 01/03 → → Construction year to: 07/07; Required quantity: 2	2 11.8171-0008.1 990049	Brake System: ATE
			Construction year from: 07/01 → → Construction year to: 12/02; Required quantity: 2	2 11.8171-0008.1 990049	Brake System: ATE
→					



	kW				
VOLVO - V70 II (285) 11/99→12/08					
Guide Bolt, brake caliper					
2.0 T	132	11/99→08/07	Construction year from: 07/01 → → Construction year to: 07/07; Required quantity: 2	2	11.8171-0008.1 990049 Brake System: ATE
2.3	195	10/00→09/04	→ Construction year to: 12/02; Required quantity: 2	2	11.8171-0008.1 990049 Brake System: ATE
2.5 AWD	155	09/02→12/04	Construction year from: 01/03 → ; Required quantity: 2	2	11.8171-0008.1 990049 Brake System: ATE
			Required quantity: 2	2	11.8171-0008.1 990049 Brake System: ATE
2.4	103 -	03/00→08/07	Construction year from: 01/03 → → Construction year to: 07/07; Required quantity: 2	2	11.8171-0008.1 990049 Brake System: ATE
2.4 Bifuel	125	09/01→08/07	→ Construction year to: 12/02; Required quantity: 2	2	11.8171-0008.1 990049 Brake System: ATE
			→ Construction year to: 07/07; Required quantity: 2	2	11.8171-0008.1 990049 Brake System: ATE
2.4 CDI	90	07/05→12/08	Required quantity: 2	2	11.8171-0008.1 990049 Brake System: ATE
2.4 T AWD	147	09/01→08/02			
2.4 D	93	04/05→12/08	Construction year from: 05/05 → → Construction year to: 07/07; Required quantity: 2	2	11.8171-0008.1 990049 Brake System: ATE
2.4 D	96	07/01→08/07	Construction year from: 01/03 → → Construction year to: 07/07; Required quantity: 2	2	11.8171-0008.1 990049 Brake System: ATE
			Construction year from: 12/01 → → Construction year to: 12/02; Required quantity: 2	2	11.8171-0008.1 990049 Brake System: ATE
			Construction year from: 12/01 → → Construction year to: 07/07; Required quantity: 2	2	11.8171-0008.1 990049 Brake System: ATE
2.4 T	147	11/99→08/03	Construction year from: 03/00 → → Construction year to: 12/02; Required quantity: 2	2	11.8171-0008.1 990049 Brake System: ATE
T5	184	11/99→12/04	Construction year from: 03/00 → ; Required quantity: 2	2	11.8171-0008.1 990049 Brake System: ATE
			Construction year from: 01/03 → ; Required quantity: 2	2	11.8171-0008.1 990049 Brake System: ATE
2.5 T	154	07/01→08/07	Construction year from: 04/04 → → Construction year to: 07/07; Required quantity: 2	2	11.8171-0008.1 990049 Brake System: ATE
2.5 T AWD	154	07/02→08/07	Construction year from: 01/03 → → Construction year to: 07/07; Required quantity: 2	2	11.8171-0008.1 990049 Brake System: ATE
			Construction year from: 09/02 → → Construction year to: 07/07; Required quantity: 2	2	11.8171-0008.1 990049 Brake System: ATE
			Construction year from: 09/02 → → Construction year to: 12/02; Required quantity: 2	2	11.8171-0008.1 990049 Brake System: ATE
2.5 TDI	103	11/99→08/07	Construction year from: 03/00 → → Construction year to: 12/02; Required quantity: 2	2	11.8171-0008.1 990049 Brake System: ATE
			Construction year from: 01/03 → → Construction year to: 07/07; Required quantity: 2	2	11.8171-0008.1 990049 Brake System: ATE
D5	120	01/01→12/08	Construction year from: 08/01 → → Construction year to: 12/02; Required quantity: 2	2	11.8171-0008.1 990049 Brake System: ATE
			Construction year from: 01/03 → → Construction year to: 07/07; Required quantity: 2	2	11.8171-0008.1 990049 Brake System: ATE
			Construction year from: 08/01 → → Construction year to: 07/07; Required quantity: 2	2	11.8171-0008.1 990049 Brake System: ATE
D5	136	04/05→12/08	Construction year from: 12/05 → → Construction year to: 07/07; Required quantity: 2	2	11.8171-0008.1 990049 Brake System: ATE
D5 AWD	136	05/05→08/07			
D5 AWD	120	07/02→08/07	Construction year from: 03/03 → → Construction year to: 07/07; Required quantity: 2	2	11.8171-0008.1 990049 Brake System: ATE
T5	191	04/04→08/07	→ Construction year to: 07/07; Required quantity: 2	2	11.8171-0008.1 990049 Brake System: ATE
VOLVO - V70 III (135) 04/07→04/16					
Guide Sleeve Kit, brake caliper					
1.6 D	80	07/09→12/11	Construction year from: 01/10 → ; for brake disc diameter [mm]: 300; Fitting Position: Front Axle		11.0101-5407.2 260011 Brake System: ATE
2.0 T	149	09/09→12/11			
→					



	kW				
VOLVO - V70 III (135) 04/07→04/16					
Guide Sleeve Kit, brake caliper					
1.6 DRiVe / D2	84	04/11→12/15	for brake disc diameter [mm]: 300; Fitting Position: Front Axle	11.0101-5407.2	260011 Brake System: ATE
2.0	107	10/07→12/11			
2.0 BiFuel	157	03/13→12/15			
2.0 D	100	10/07→12/15			
2.0 FlexiFuel	107	01/08→12/11			
2.5 T	147	08/07→12/09			
2.5 T FlexiFuel	147	05/08→12/09			
3.2	175	08/07→12/14			
	179				
3.2 AWD	179	04/10→12/15			
D2	88	03/15→04/16			
D3	100	10/07→04/16			
	110				
D3 / D4	120	03/10→12/15			
D4	133	10/13→04/16			
D4 AWD	120	10/07→04/16			
	133				
D5	158	03/11→04/16			
	169				
D5 AWD	151	12/09→04/16			
	169				
T4	132	10/10→04/16			
	140				
T4F	132	01/11→12/15			
T5	177	01/10→04/16			
	180				
T6 AWD	210	08/07→04/16			
	242				
2.0 GDI	157	04/12→12/15	Construction year from: 03/13 →; for brake disc diameter [mm]: 300; Fitting Position: Front Axle	11.0101-5407.2	260011 Brake System: ATE
2.4 D	120	04/07→12/10	Construction year from: 08/07 →; for brake disc diameter [mm]: 300; Fitting Position: Front Axle	11.0101-5407.2	260011 Brake System: ATE
3.2 AWD	175	04/07→12/10			
D5	136	04/07→12/09			
2.4 D	129	04/09→12/10	Construction year from: 10/09 →; for brake disc diameter [mm]: 300; Fitting Position: Front Axle	11.0101-5407.2	260011 Brake System: ATE
2.5 T	170	04/09→12/12			
2.5 T FlexiFuel	170	04/09→12/11			
D5	151	10/08→12/11	Construction year from: 12/09 →; for brake disc diameter [mm]: 300; Fitting Position: Front Axle	11.0101-5407.2	260011 Brake System: ATE
D5 AWD	136	04/07→12/09	Construction year from: 10/07 →; for brake disc diameter [mm]: 300; Fitting Position: Front Axle	11.0101-5407.2	260011 Brake System: ATE
D5 AWD	158	04/11→12/15	Construction year from: 06/11 →; for brake disc diameter [mm]: 300; Fitting Position: Front Axle	11.0101-5407.2	260011 Brake System: ATE
Guide Bolt, brake caliper					
1.6 D	80	07/09→12/11	Construction year from: 01/10 →; for brake disc diameter [mm]: 300; Required quantity: 2; Fitting Position: Front Axle	2	11.8171-0008.1 990049 Brake System: ATE
2.0 T	149	09/09→12/11			
			Construction year from: 01/10 →; for brake disc diameter [mm]: 316; Required quantity: 2; Fitting Position: Front Axle	2	11.8171-0008.1 990049 Brake System: ATE
			Construction year from: 01/10 →; for brake disc diameter [mm]: 336; Required quantity: 2; Fitting Position: Front Axle	2	11.8171-0008.1 990049 Brake System: ATE
1.6 DRiVe / D2	84	04/11→12/15	for brake disc diameter [mm]: 316; Required quantity: 2; Fitting Position: Front Axle	2	11.8171-0008.1 990049 Brake System: ATE
2.0	107	10/07→12/11			
2.0 BiFuel	157	03/13→12/15			
2.0 D	100	10/07→12/15	for brake disc diameter [mm]: 336; Required quantity: 2; Fitting Position: Front Axle	2	11.8171-0008.1 990049 Brake System: ATE
2.0 FlexiFuel	107	01/08→12/11			
2.5 T	147	08/07→12/09			
2.5 T FlexiFuel	147	05/08→12/09			
3.2	175	08/07→12/14	for brake disc diameter [mm]: 300; Required quantity: 2; Fitting Position: Front Axle	2	11.8171-0008.1 990049 Brake System: ATE
	179				
3.2 AWD	179	04/10→12/15			
D2	88	03/15→04/16			
D3	100	10/07→04/16			
	110				
D3 / D4	120	03/10→12/15			
D4	133	10/13→04/16			
D4 AWD	120	10/07→04/16			
	133				
D5	158	03/11→04/16			
	169				
D5 AWD	151	12/09→04/16			
	169				
→					

	kW				
VOLVO - V70 III (135) 04/07→04/16					
Guide Bolt, brake caliper					
T4	132 - 10/10→04/16 140		for brake disc diameter [mm]: 316; Required quantity: 2; Fitting Position: Front Axle	2	11.8171-0008.1 990049 Brake System: ATE
T4F	132 01/11→12/15				
T5	177 - 01/10→04/16 180		for brake disc diameter [mm]: 336; Required quantity: 2; Fitting Position: Front Axle	2	11.8171-0008.1 990049 Brake System: ATE
T6 AWD	210 - 08/07→04/16 242		for brake disc diameter [mm]: 300; Required quantity: 2; Fitting Position: Front Axle	2	11.8171-0008.1 990049 Brake System: ATE
2.0 GDI	157 04/12→12/15		Construction year from: 03/13 →; for brake disc diameter [mm]: 316; Required quantity: 2; Fitting Position: Front Axle	2	11.8171-0008.1 990049 Brake System: ATE
			Construction year from: 03/13 →; for brake disc diameter [mm]: 336; Required quantity: 2; Fitting Position: Front Axle	2	11.8171-0008.1 990049 Brake System: ATE
			Construction year from: 03/13 →; for brake disc diameter [mm]: 300; Required quantity: 2; Fitting Position: Front Axle	2	11.8171-0008.1 990049 Brake System: ATE
2.4 D	120 04/07→12/10		Construction year from: 08/07 →; for brake disc diameter [mm]: 316; Required quantity: 2; Fitting Position: Front Axle	2	11.8171-0008.1 990049 Brake System: ATE
3.2 AWD	175 04/07→12/10				
D5	136 04/07→12/09		Construction year from: 08/07 →; for brake disc diameter [mm]: 336; Required quantity: 2; Fitting Position: Front Axle	2	11.8171-0008.1 990049 Brake System: ATE
			Construction year from: 08/07 →; for brake disc diameter [mm]: 300; Required quantity: 2; Fitting Position: Front Axle	2	11.8171-0008.1 990049 Brake System: ATE
2.4 D	129 04/09→12/10		Construction year from: 10/09 →; for brake disc diameter [mm]: 300; Required quantity: 2; Fitting Position: Front Axle	2	11.8171-0008.1 990049 Brake System: ATE
2.5 T	170 04/09→12/12				
2.5 T FlexiFuel	170 04/09→12/11		Construction year from: 10/09 →; for brake disc diameter [mm]: 316; Required quantity: 2; Fitting Position: Front Axle	2	11.8171-0008.1 990049 Brake System: ATE
			Construction year from: 10/09 →; for brake disc diameter [mm]: 336; Required quantity: 2; Fitting Position: Front Axle	2	11.8171-0008.1 990049 Brake System: ATE
D5	151 10/08→12/11		Construction year from: 12/09 →; for brake disc diameter [mm]: 300; Required quantity: 2; Fitting Position: Front Axle	2	11.8171-0008.1 990049 Brake System: ATE
			Construction year from: 12/09 →; for brake disc diameter [mm]: 316; Required quantity: 2; Fitting Position: Front Axle	2	11.8171-0008.1 990049 Brake System: ATE
			Construction year from: 12/09 →; for brake disc diameter [mm]: 336; Required quantity: 2; Fitting Position: Front Axle	2	11.8171-0008.1 990049 Brake System: ATE
D5 AWD	136 04/07→12/09		Construction year from: 10/07 →; for brake disc diameter [mm]: 336; Required quantity: 2; Fitting Position: Front Axle	2	11.8171-0008.1 990049 Brake System: ATE
			Construction year from: 10/07 →; for brake disc diameter [mm]: 300; Required quantity: 2; Fitting Position: Front Axle	2	11.8171-0008.1 990049 Brake System: ATE
			Construction year from: 10/07 →; for brake disc diameter [mm]: 316; Required quantity: 2; Fitting Position: Front Axle	2	11.8171-0008.1 990049 Brake System: ATE
D5 AWD	158 04/11→12/15		Construction year from: 06/11 →; for brake disc diameter [mm]: 336; Required quantity: 2; Fitting Position: Front Axle	2	11.8171-0008.1 990049 Brake System: ATE
			Construction year from: 06/11 →; for brake disc diameter [mm]: 316; Required quantity: 2; Fitting Position: Front Axle	2	11.8171-0008.1 990049 Brake System: ATE
			Construction year from: 06/11 →; for brake disc diameter [mm]: 300;	2	11.8171-0008.1 990049 Brake System: ATE

→

	kW				
VOLVO - V70 III (135) 04/07→04/16					
Guide Bolt, brake caliper					
D5 AWD	158 04/11→12/15	Required quantity: 2; Fitting Position: Front Axle			
VOLVO - V70 III Estate Van (135) 09/13→					
Guide Sleeve Kit, brake caliper					
2.0 D3 DRIVe	100 09/13→	for brake disc diameter [mm]: 300; Fitting Position: Front Axle	2	11.0101-5407.2 260011	Brake System: ATE
2.4 D4 AWD	120 09/13→				
2.4 D5	158 09/13→				
Guide Bolt, brake caliper					
2.0 D3 DRIVe	100 09/13→	for brake disc diameter [mm]: 300; Required quantity: 2; Fitting Position: Front Axle	2	11.8171-0008.1 990049	Brake System: ATE
2.4 D4 AWD	120 09/13→				
2.4 D5	158 09/13→				
		for brake disc diameter [mm]: 316; Required quantity: 2; Fitting Position: Front Axle	2	11.8171-0008.1 990049	Brake System: ATE
		for brake disc diameter [mm]: 336; Required quantity: 2; Fitting Position: Front Axle	2	11.8171-0008.1 990049	Brake System: ATE
VOLVO - V90 II Cross Country (236) 03/16→					
Guide Sleeve Kit, brake caliper					
B5 Mild-Hybrid AWD	184 03/20→	Brake Size: 16" / 17"; Fitting Position: Front Axle		11.0101-5407.2 260011	Brake System: ATE
D4 AWD	120 09/18→				
T6 Polestar AWD	246 10/16→12/17	Fitting Position: Rear Axle		11.0101-5407.2 260011	Brake System: ATE
T5 AWD	183 - 03/16→	Brake Size: 17"; Fitting Position: Front Axle		11.0101-5407.2 260011	Brake System: ATE
	187				
T5 Polestar AWD	186 10/17→	Fitting Position: Rear Axle		11.0101-5407.2 260011	Brake System: ATE
Guide Bolt, brake caliper					
B5 Mild-Hybrid AWD	184 03/20→	Brake Size: 16" / 17"; Fitting Position: Front Axle		11.8171-0008.1 990049	Brake System: ATE
D4 AWD	120 09/18→				
T6 Polestar AWD	246 10/16→12/17	Fitting Position: Rear Axle		11.8171-0008.1 990049	Brake System: ATE
T5 AWD	183 - 03/16→	Brake Size: 17"; Fitting Position: Front Axle		11.8171-0008.1 990049	Brake System: ATE
	187				
T5 Polestar AWD	186 10/17→	Fitting Position: Rear Axle		11.8171-0008.1 990049	Brake System: ATE
 Brake Pad Set, disc brake					
D4 AWD	120 09/18→	Brake Size: 17"; Fitting Position: Rear Axle		13.0460-7326.2 607326	Brake System: ATE 22141 15,5 Wear Warning Contact: prepared for wear indicator / excl. wear warning contact
T5 AWD	183 - 03/16→				
	187				
T5 Polestar AWD	186 10/17→			13.0470-7326.2 LD7326	Brake System: ATE Wear Warning Contact: prepared for wear indicator / excl. wear warning contact Ceramic
		Brake Size: 16"; Fitting Position: Rear Axle		13.0470-7337.2 LD7337	Brake System: ATE Wear Warning Contact: prepared for wear indicator / excl. wear warning contact Ceramic
T6 Polestar AWD	246 10/16→12/17	Brake Size: 17"; Fitting Position: Rear Axle		13.0460-7326.2 607326	Brake System: ATE 22141 15,5 Wear Warning Contact: prepared for wear indicator / excl. wear warning contact
VOLVO - V90 II Estate (235) 03/16→					
Guide Sleeve Kit, brake caliper					
B4 Mild-Hybrid	145 03/20→	Brake Size: 16" / 17"; Fitting Position: Front Axle		11.0101-5407.2 260011	Brake System: ATE
B5 Mild-Hybrid	184 - 03/20→				
	196	Fitting Position: Rear Axle		11.0101-5407.2 260011	Brake System: ATE
B5 Mild Hybrid AWD	173 12/20→				
B6 Mild-Hybrid AWD	220 - 03/20→				
	256				
D3	110 03/16→08/18				
D3 AWD	110 03/16→				
D4	120 - 03/16→				
	140				
D4 AWD	140 03/16→				
D4 Polestar	147 10/16→				
D5 AWD	173 03/16→				
D5 Polestar AWD	176 10/16→				
Polestar AWD	147 10/16→				
T4	140 10/17→				
T4 Polestar	155 06/19→				
T5	184 - 03/16→				
	187				
→					





	kW				
VOLVO - V90 II Estate (235) 03/16→					
Guide Sleeve Kit, brake caliper					
T5 Polestar	186 06/19→		Brake Size: 16" / 17"; Fitting Position: Front Axle	11.0101-5407.2 260011	Brake System: ATE
T6 AWD	228 - 03/16→				
T6 Polestar AWD	240 10/17→		Fitting Position: Rear Axle	11.0101-5407.2 260011	Brake System: ATE
T8 Hybrid AWD	223 04/18→				
T8 Plug-in-Hybrid AWD	235 03/16→12/18				
T8 Plug-in Hybrid Polestar AWD	233 - 03/16→				
B4 Mild-Hybrid AWD	145 10/20→		Fitting Position: Rear Axle	11.0101-5407.2 260011	Brake System: ATE
T8 Plug-in Hybrid AWD	228 - 03/22→				
T6 Plug-In Hybrid AWD	186 04/21→		Brake Size: 17"; Fitting Position: Front Axle	11.0101-5407.2 260011	Brake System: ATE
T6 Plug-in-Hybrid AWD	250 06/20→				
T8 Plug-in-Hybrid AWD	287 06/20→		Fitting Position: Rear Axle	11.0101-5407.2 260011	Brake System: ATE
Guide Bolt, brake caliper					
B4 Mild-Hybrid	145 03/20→		Brake Size: 16" / 17"; Fitting Position: Front Axle	11.8171-0008.1 990049	Brake System: ATE
B5 Mild-Hybrid	184 - 03/20→				
B5 Mild Hybrid AWD	173 12/20→		Fitting Position: Rear Axle	11.8171-0008.1 990049	Brake System: ATE
B6 Mild-Hybrid AWD	220 - 03/20→				
D3	110 03/16→08/18				
D3 AWD	110 03/16→				
D4	120 - 03/16→				
D4 AWD	140 03/16→				
D4 Polestar	147 10/16→				
D5 AWD	173 03/16→				
D5 Polestar AWD	176 10/16→				
Polestar AWD	147 10/16→				
T4	140 10/17→				
T4 Polestar	155 06/19→				
T5	184 - 03/16→				
T5 Polestar	186 06/19→				
T6 AWD	228 - 03/16→				
T6 Polestar AWD	240 10/17→				
T8 Hybrid AWD	223 04/18→				
T8 Plug-in-Hybrid AWD	235 03/16→12/18				
T8 Plug-in Hybrid Polestar AWD	233 - 03/16→				
T6 Plug-In Hybrid AWD	186 04/21→		Brake Size: 17"; Fitting Position: Front Axle	11.8171-0008.1 990049	Brake System: ATE
T6 Plug-in-Hybrid AWD	250 06/20→				
T8 Plug-in-Hybrid AWD	287 06/20→		Fitting Position: Rear Axle	11.8171-0008.1 990049	Brake System: ATE
 Brake Pad Set, disc brake					
D3	110 03/16→08/18		Brake Size: 17"; Fitting Position: Rear Axle	13.0460-7326.2 607326	Brake System: ATE 22141 15,5 Wear Warning Contact: prepared for wear indicator / excl. wear warning contact
D3 AWD	110 03/16→				
D4	120 - 03/16→		Fitting Position: Rear Axle	13.0470-7326.2 LD7326	Brake System: ATE Wear Warning Contact: prepared for wear indicator / excl. wear warning contact Ceramic
D4 AWD	140 03/16→				
D4 Polestar	147 10/16→				
D5 AWD	173 03/16→				
D5 Polestar AWD	176 10/16→				
Polestar AWD	147 10/16→				
T4	140 10/17→		Brake Size: 16"; Fitting Position: Rear Axle	13.0470-7337.2 LD7337	Brake System: ATE Wear Warning Contact: prepared for wear indicator / excl. wear warning contact Ceramic
T4 Polestar	155 06/19→				
T5	184 - 03/16→				
T5 Polestar	186 06/19→				
T8 Hybrid AWD	223 04/18→				
T6 AWD	228 - 03/16→		Brake Size: 17"; Fitting Position: Rear Axle	13.0460-7326.2 607326	Brake System: ATE 22141 15,5 Wear Warning Contact: prepared for wear indicator / excl. wear warning contact
T6 Polestar AWD	240 10/17→				
T8 Plug-in-Hybrid AWD	235 03/16→12/18				
T8 Plug-in Hybrid Polestar AWD	233 - 03/16→				
	246				
VOLVO - XC40 (536) 10/17→					
Guide Bolt, brake caliper					
Recharge AWD	160 - 11/20→		Required quantity: 2; Fitting Position: Rear Axle	2 11.8171-0008.1 990049	Brake System: ATE
 Brake Pad Set, disc brake					
Recharge AWD	160 11/20→		Brake Size: 18"; → Vehicle Identification Number to: 560621; Fitting Position: Rear Axle	13.0460-7326.2 607326	Brake System: ATE 22141 15,5 Wear Warning Contact: prepared for wear indicator / excl. wear warning contact



	kW				
VOLVO - XC40 (536) 10/17→					
 Brake Pad Set, disc brake					
Recharge AWD	160 11/20→		Brake Size: 18"; → Vehicle Identification Number to: 560621; Fitting Position: Rear Axle	13.0470-7326.2 LD7326	Brake System: ATE Wear Warning Contact: prepared for wear indicator / excl. wear warning contact Ceramic
Recharge AWD	300 06/21→		Brake Size: 18"; → Vehicle Identification Number to: 560621; Fitting Position: Rear Axle	13.0460-7326.2 607326	Brake System: ATE 22141 15,5 Wear Warning Contact: prepared for wear indicator / excl. wear warning contact
 Wheel Speed Sensor					
B4 Mild-Hybrid	145 09/19→		Equipment Code: CB01 / CB03; Required quantity: 2; Fitting Position: Front Axle	2 24.0710-2127.3 360652	Length [mm]: 55.4
B4 Mild-Hybrid AWD	145 09/19→				
B5 Mild-Hybrid AWD	183 - 09/19→				
	184				
D3	110 09/18→09/21		Equipment Code: AG02 / XE0A / CB01 / CB03; Required quantity: 2; Fitting Position: Rear Axle	2 24.0710-2127.3 360652	Length [mm]: 55.4
D3 AWD	110 09/18→09/21				
D4 AWD	140 10/17→09/21				
D4 Polestar AWD	147 01/19→09/21		Equipment Code: XE09 / CB01 / CB03; Required quantity: 2; Fitting Position: Rear Axle	2 24.0710-2127.3 360652	Length [mm]: 55.4
Recharge AWD	160 - 11/20→				
	300				
T2	95 06/19→		Equipment Code: AG01 / XE0A / CB01 / CB03; Required quantity: 2; Fitting Position: Rear Axle	2 24.0710-2128.3 360653	Length [mm]: 43.4
T3	110 - 03/18→				
	120				
T4	140 09/18→				
T4 AWD	140 09/18→				
T4 Plug-in Hybrid	95 06/20→				
T5 AWD	182 - 10/17→				
	184				
T5 Plug-in Hybrid	132 06/19→				
T5 Plug-in Hybrid Pole- star Performance	143 06/19→				
T5 Polestar AWD	183 10/17→09/19				
VOLVO - XC60 II (246) 03/17→					
Guide Sleeve Kit, brake caliper					
2.0 B5 Mild-Hybrid	183 03/22→		Brake Size: 17"; Fitting Position: Front Axle	11.0101-5407.2 260011	Brake System: ATE
2.0 B5 Mild-Hybrid AWD	183 03/22→				
B4 Mild-Hybrid	145 05/19→		Fitting Position: Rear Axle	11.0101-5407.2 260011	Brake System: ATE
B4 Mild-Hybrid AWD	145 04/19→				
B5 Mild-Hybrid	184 01/20→				
B5 Mild-Hybrid AWD	173 - 04/19→				
	184				
B6 Mild-Hybrid AWD	220 03/20→				
D3	110 03/17→				
D4	120 - 03/17→				
	140				
D4 AWD	140 03/17→				
D4 Polestar	147 05/20→				
D4 Polestar AWD	147 01/19→				
D5 AWD	173 03/17→				
D5 Polestar AWD	177 10/18→				
T4	140 09/18→				
T4 Polestar	155 07/19→				
T5	184 - 03/17→				
	187				
T5 AWD	183 - 03/17→				
	187				
T5 Polestar	186 05/19→				
T5 Polestar AWD	186 - 03/17→				
	192				
T6 AWD	228 - 03/17→				
	235				
T6 Polestar AWD	240 - 03/17→				
	246				
T8 Hybrid AWD	223 - 03/17→				
	246				
T8 Hybrid Polestar AWD	233 01/19→				
B4 Plug-In Hybrid	186 01/21→		Brake Size: 17"; Fitting Position: Front Axle	11.0101-5407.2 260011	Brake System: ATE
B4 Plug-In Hybrid AWD	186 - 01/21→				
	250				
T6 Plug-In Hybrid AWD	186 04/21→				
T8 Hybrid Polestar AWD	246 05/21→				
Guide Bolt, brake caliper					
2.0 B5 Mild-Hybrid	183 03/22→		Brake Size: 17"; Fitting Position: Front Axle	11.8171-0008.1 990049	Brake System: ATE
2.0 B5 Mild-Hybrid AWD	183 03/22→				
B4 Mild-Hybrid	145 05/19→		Fitting Position: Rear Axle	11.8171-0008.1 990049	Brake System: ATE
B4 Mild-Hybrid AWD	145 04/19→				
B5 Mild-Hybrid	184 01/20→				
B5 Mild-Hybrid AWD	173 - 04/19→				
	184				
→					





	kW				
VOLVO - XC60 II (246) 03/17→					
Guide Bolt, brake caliper					
B6 Mild-Hybrid AWD	220 03/20→		Brake Size: 17"; Fitting Position: Front Axle	11.8171-0008.1 990049	Brake System: ATE
D3	110 03/17→				
D4	120 - 03/17→		Fitting Position: Rear Axle	11.8171-0008.1 990049	Brake System: ATE
	140				
D4 AWD	140 03/17→				
D4 Polestar	147 05/20→				
D4 Polestar AWD	147 01/19→				
D5 AWD	173 03/17→				
D5 Polestar AWD	177 10/18→				
T4	140 09/18→				
T4 Polestar	155 07/19→				
T5	184 - 03/17→				
	187				
T5 AWD	183 - 03/17→				
	187				
T5 Polestar	186 05/19→				
T5 Polestar AWD	186 - 03/17→				
	192				
T6 AWD	228 - 03/17→				
	235				
T6 Polestar AWD	240 - 03/17→				
	246				
T8 Hybrid AWD	223 - 03/17→				
	246				
T8 Hybrid Polestar AWD	233 01/19→				
B4 Plug-In Hybrid	186 01/21→		Brake Size: 17"; Fitting Position: Front Axle	11.8171-0008.1 990049	Brake System: ATE
B4 Plug-In Hybrid AWD	186 - 01/21→				
	250				
T6 Plug-In Hybrid AWD	186 04/21→				
T8 Hybrid Polestar AWD	246 05/21→				
 Brake Pad Set, disc brake					
2.0 B5 Mild-Hybrid	183 03/22→		Brake Size: 17"; Fitting Position: Rear Axle	13.0460-7326.2 607326	Brake System: ATE 22141 15,5 Wear Warning Contact: prepared for wear indicator / excl. wear warning contact
2.0 B5 Mild-Hybrid AWD	183 03/22→				
B4 Mild-Hybrid	145 05/19→			13.0470-7326.2 LD7326	Brake System: ATE Wear Warning Contact: prepared for wear indicator / excl. wear warning contact Ceramic
B4 Mild-Hybrid AWD	145 04/19→				
B4 Plug-In Hybrid	186 01/21→				
B4 Plug-In Hybrid AWD	186 01/21→				
B5 Mild-Hybrid	184 01/20→				
B5 Mild-Hybrid AWD	173 - 04/19→				
	184				
B6 Mild-Hybrid AWD	220 03/20→		Brake Size: 16"; Fitting Position: Rear Axle	13.0470-7337.2 LD7337	Brake System: ATE Wear Warning Contact: prepared for wear indicator / excl. wear warning contact Ceramic
D3	110 03/17→				
D4	120 - 03/17→				
	140				
D4 AWD	140 03/17→				
D4 Polestar	147 05/20→				
D4 Polestar AWD	147 01/19→				
D5 AWD	173 03/17→				
D5 Polestar AWD	177 10/18→				
T4	140 09/18→				
T4 Polestar	155 07/19→				
T5	184 - 03/17→				
	187				
T5 AWD	183 - 03/17→				
	187				
T5 Polestar	186 05/19→				
T5 Polestar AWD	186 - 03/17→				
	192				
T6 Plug-In Hybrid AWD	186 04/21→				
T8 Hybrid AWD	223 02/18→				
B4 Plug-In Hybrid AWD	250 01/21→		Brake Size: 17"; Fitting Position: Rear Axle	13.0460-7326.2 607326	Brake System: ATE 22141 15,5 Wear Warning Contact: prepared for wear indicator / excl. wear warning contact
T6 AWD	228 - 03/17→				
	235				
T6 Polestar AWD	240 - 03/17→				
	246				
T8 Hybrid AWD	233 - 03/17→				
	246				
T8 Hybrid Polestar AWD	233 - 01/19→				
	246				
VOLVO - XC70 I Cross Country (295) 10/97→10/07					
Guide Sleeve Kit, brake caliper					
2.4 T XC AWD	142 - 11/97→09/02		Fitting Position: Front Axle	11.0101-5407.2 260011	Brake System: ATE
	147		Fitting Position: Rear Axle		
2.5 T XC AWD	154 09/02→08/07		→ Construction year to: 07/07;	11.0101-5407.2 260011	Brake System: ATE
D5 AWD	136 12/05→08/07		Fitting Position: Front Axle		
D5 XC AWD	120 09/02→08/07		→ Construction year to: 07/07;	11.0101-5407.2 260011	Brake System: ATE
			Fitting Position: Rear Axle		
→					

	kW				
VOLVO - XC70 I Cross Country (295) 10/97→10/07					
Guide Bolt, brake caliper					
2.4 T XC AWD	142 - 11/97→09/02 147	Required quantity: 2	2	11.8171-0008.1 990049	Brake System: ATE
2.5 T XC AWD	154 09/02→08/07	→ Construction year to: 07/07;	2	11.8171-0008.1 990049	Brake System: ATE
D5 AWD	136 12/05→08/07	Required quantity: 2			
D5 XC AWD	120 09/02→08/07				
VOLVO - XC70 II (136) 04/07→12/16					
Guide Sleeve Kit, brake caliper					
2.4 D	129 06/09→12/10	Construction year from: 01/10 →; Fitting Position: Front Axle		11.0101-5407.2 260011	Brake System: ATE
2.4 D / D4 AWD	120 08/07→04/16	Fitting Position: Front Axle		11.0101-5407.2 260011	Brake System: ATE
3.2 AWD	175 - 08/07→12/14 179				
D3	120 04/10→12/15				
D4	133 10/13→04/16				
D4 AWD	133 10/13→04/16				
D5 AWD	158 - 04/11→04/16 169				
T5	180 10/13→12/16				
T5 AWD	187 08/15→12/16				
T6 AWD	183 - 01/08→12/16 224				
T6 Polestar AWD	242 11/13→12/16				
D5 AWD	136 04/07→12/09	Construction year from: 08/07 →; Fitting Position: Front Axle		11.0101-5407.2 260011	Brake System: ATE
D5 AWD	151 04/09→12/11	Construction year from: 12/09 →; Fitting Position: Front Axle		11.0101-5407.2 260011	Brake System: ATE
Guide Bolt, brake caliper					
2.4 D	129 06/09→12/10	Construction year from: 01/10 →; Required quantity: 2	2	11.8171-0008.1 990049	Brake System: ATE
		Construction year from: 01/10 →; Required quantity: 2; Fitting Position: Front Axle	2	11.8171-0008.1 990049	Brake System: ATE
2.4 D / D4 AWD	120 08/07→04/16	Required quantity: 2	2	11.8171-0008.1 990049	Brake System: ATE
3.2 AWD	175 - 08/07→12/14 179	Required quantity: 2; Fitting Position: Front Axle	2	11.8171-0008.1 990049	Brake System: ATE
D3	120 04/10→12/15				
D4	133 10/13→04/16				
D4 AWD	133 10/13→04/16				
D5 AWD	158 - 04/11→04/16 169				
T5	180 10/13→12/16				
T5 AWD	187 08/15→12/16				
T6 AWD	183 - 01/08→12/16 224				
T6 Polestar AWD	242 11/13→12/16				
D5 AWD	136 04/07→12/09	Construction year from: 08/07 →; Required quantity: 2	2	11.8171-0008.1 990049	Brake System: ATE
		Construction year from: 08/07 →; Required quantity: 2; Fitting Position: Front Axle	2	11.8171-0008.1 990049	Brake System: ATE
D5 AWD	151 04/09→12/11	Construction year from: 12/09 →; Required quantity: 2	2	11.8171-0008.1 990049	Brake System: ATE
		Construction year from: 12/09 →; Required quantity: 2; Fitting Position: Front Axle	2	11.8171-0008.1 990049	Brake System: ATE
VOLVO - XC70 II VAN (136) 04/07→12/16					
Guide Sleeve Kit, brake caliper					
2.0 D4	120 09/13→12/16	Fitting Position: Front Axle		11.0101-5407.2 260011	Brake System: ATE
2.4 D4 AWD	120 09/13→04/16				
2.4 D5 AWD	158 09/13→12/16				
Guide Bolt, brake caliper					
2.0 D4	120 09/13→12/16	Required quantity: 2; Fitting Position: Front Axle	2	11.8171-0008.1 990049	Brake System: ATE
		Required quantity: 2; Fitting Position: Rear Axle	2	11.8171-0008.1 990049	Brake System: ATE
2.4 D4 AWD	120 09/13→04/16	Required quantity: 2;	2	11.8171-0008.1 990049	Brake System: ATE
2.4 D5 AWD	158 09/13→12/16	Fitting Position: Front Axle			
VOLVO - XC90 I (275) 06/02→01/15					
Guide Bolt, brake caliper					
2.5	153 01/03→12/06	Required quantity: 2;	2	11.8171-0008.1 990049	Brake System: ATE
2.5 AWD	153 06/02→12/14	Fitting Position: Rear Axle			
2.5 T AWD	154 10/02→09/14				
→					

	kW				
VOLVO - XC90 I (275) 06/02→01/15					
Guide Bolt, brake caliper					
3.2	175 - 09/11→09/14 179	Required quantity: 2; Fitting Position: Rear Axle	2	11.8171-0008.1 990049	Brake System: ATE
3.2 AWD	179 04/10→09/14				
D3 / D5	120 04/09→12/14				
D5 AWD	120 - 10/02→12/14 155				
T6 AWD	200 10/02→12/06				
V8 AWD	232 - 09/04→12/10 235				
3.2 AWD	175 03/06→12/10	Construction year from: 05/06 →;	2	11.8171-0008.1 990049	Brake System: ATE
D5 AWD	136 04/05→12/10	Required quantity: 2; Fitting Position: Rear Axle			
VOLVO - XC90 I VAN (275) 06/02→01/15					
Guide Bolt, brake caliper					
2.4 D4	120 09/13→12/14	Required quantity: 2;	2	11.8171-0008.1 990049	Brake System: ATE
2.4 D5 AWD	147 09/13→12/14	Fitting Position: Rear Axle			
VOLVO - XC90 II (256) 09/14→					
Guide Sleeve Kit, brake caliper					
2.0 T8 Hybrid AWD	223 04/18→	Fitting Position: Rear Axle		11.0101-5407.2 260011	Brake System: ATE
B5 Mild-Hybrid	183 - 01/22→ 184				
B5 Mild-Hybrid AWD	173 - 04/19→ 184				
B6 Mild-Hybrid AWD	220 03/20→				
D4	140 06/15→12/18				
D4 AWD	140 10/15→12/18				
D5 AWD	165 - 09/14→12/19 173				
D5 DRiVe Polestar AWD	176 03/16→				
D5 Polestar AWD	177 10/18→				
T5 AWD	183 - 06/15→ 187				
T5 Drive-E Polestar AWD	176 - 10/17→ 192				
T5 Polestar AWD	186 07/19→				
T6 AWD	228 - 09/14→ 235				
T6 Polestar AWD	240 - 01/17→ 246				
T8 Hybrid AWD	235 - 06/15→ 298				
T8 Hybrid Polestar AWD	233 01/19→				
T8 Plug-in Hybrid AWD	228 - 03/22→ 335				
T8 Plug-in Hybrid Polestar AWD	246 06/15→				
T8 Twin Engine AWD	287 06/19→				
Guide Bolt, brake caliper					
2.0 T8 Hybrid AWD	223 04/18→	Fitting Position: Rear Axle		11.8171-0008.1 990049	Brake System: ATE
B5 Mild-Hybrid	183 - 01/22→ 184				
B5 Mild-Hybrid AWD	173 - 04/19→ 184				
B6 Mild-Hybrid AWD	220 03/20→				
D4	140 06/15→12/18				
D4 AWD	140 10/15→12/18				
D5 AWD	165 - 09/14→12/19 173				
D5 DRiVe Polestar AWD	176 03/16→				
D5 Polestar AWD	177 10/18→				
T5 AWD	183 - 06/15→ 187				
T5 Drive-E Polestar AWD	176 - 10/17→ 192				
T5 Polestar AWD	186 07/19→				
T6 AWD	228 - 09/14→ 235				
T6 Polestar AWD	240 - 01/17→ 246				
T8 Hybrid AWD	235 - 06/15→ 298				
T8 Hybrid Polestar AWD	233 01/19→				
T8 Plug-in Hybrid AWD	228 - 03/22→ 335				
T8 Plug-in Hybrid Polestar AWD	246 06/15→				
T8 Twin Engine AWD	287 06/19→				

	kW				
VOLVO - XC90 II (256) 09/14→					
 Brake Pad Set, disc brake					
2.0 T8 Hybrid AWD B5 Mild-Hybrid AWD	223 04/18→ 173 - 04/19→ 184		Fitting Position: Rear Axle	13.0460-7326.2 607326	Brake System: ATE 22141 15,5 Wear Warning Contact: prepared for wear indicator / excl. wear warning contact
B6 Mild-Hybrid AWD D4 D4 AWD D5 AWD	220 03/20→ 140 06/15→12/18 140 10/15→12/18 165 - 09/14→12/19 173			13.0470-7326.2 LD7326	Brake System: ATE Wear Warning Contact: prepared for wear indicator / excl. wear warning contact Ceramic
D5 DRIVe Polestar AWD D5 Polestar AWD T5 AWD	176 03/16→ 177 10/18→ 183 - 06/15→ 187				
T5 Drive-E Polestar AWD T5 Polestar AWD	176 - 10/17→ 192 186 07/19→				
T6 AWD T6 Polestar AWD	228 - 09/14→ 235 240 - 01/17→ 246		Fitting Position: Rear Axle	13.0460-7326.2 607326	Brake System: ATE 22141 15,5 Wear Warning Contact: prepared for wear indicator / excl. wear warning contact
T8 Hybrid AWD T8 Hybrid Polestar AWD T8 Plug-in Hybrid Polestar AWD T8 Twin Engine AWD	235 - 06/15→ 298 233 01/19→ 246 06/15→ 287 06/19→				
VW - AMAROK (2HA, 2HB, S1B, S6B, S7A, S7B) 09/10→					
 Brake Master Cylinder					
2.0 BiTDI 2.0 BiTDI 4motion 2.0 TDI 2.0 TDI 4motion 2.0 TSI 3.0 TDI 3.0 TDI 4motion	120 - 09/10→ 132 120 - 09/10→ 132 90 - 09/10→ 103 90 - 09/10→ 103 118 12/10→10/16 120 06/16→ 150 - 06/16→ 190			24.2126-3131.3 011038	Brake System: ATE Diameter [mm]: 27 Supplementary Article/Info 2: without brake fluid reservoir
3.0 TDI 4motion	120 - 06/16→ 165	Construction year from: 09/16 →		24.2126-3131.3 011038	Brake System: ATE Diameter [mm]: 27 Supplementary Article/Info 2: without brake fluid reservoir
VW - AMAROK Platform/Chassis (S1B, S6B, S7B) 09/11→					
 Brake Master Cylinder					
2.0 BiTDI 2.0 BiTDI 4motion	132 09/11→07/19 132 09/11→07/19	Construction year from: 11/11 →		24.2126-3131.3 011038	Brake System: ATE Diameter [mm]: 27 Supplementary Article/Info 2: without brake fluid reservoir
2.0 TDI	90 - 09/11→10/16 103	Construction year from: 07/12 →		24.2126-3131.3 011038	Brake System: ATE Diameter [mm]: 27 Supplementary Article/Info 2: without brake fluid reservoir
2.0 TDI 4motion	103 09/11→10/16	Construction year from: 06/12 →		24.2126-3131.3 011038	Brake System: ATE Diameter [mm]: 27 Supplementary Article/Info 2: without brake fluid reservoir
3.0 TDI 4motion	150 - 06/16→ 190			24.2126-3131.3 011038	Brake System: ATE Diameter [mm]: 27 Supplementary Article/Info 2: without brake fluid reservoir
VW - ARTEON (3H7, 3H8) 03/17→					
 Brake Caliper					
1.5 TSI 2.0 TDI	110 11/17→07/19 110 - 03/17→ 147	for PR number: 1ZA / 1ZD / 1ZK / 1ZL; Fitting Position: Front Axle Left		24.3571-1801.5 241387	Supplementary Article/Supplementary Info: without holder Brake Caliper Type: Fist-type Caliper
2.0 TDI 4motion 2.0 TSI 2.0 TSI 4motion	140 - 03/17→ 176 140 05/17→ 200 - 04/17→ 206	for PR number: 1ZA / 1ZD / 1ZK / 1ZL; Fitting Position: Front Axle Right		24.3571-1802.5 241388	Supplementary Article/Supplementary Info: without holder Brake Caliper Type: Fist-type Caliper
→					

	kW				
VW - ARTEON (3H7, 3H8) 03/17→					
 Brake Pad Set, disc brake					
1.5 TSI 2.0 TDI	110 11/17→07/19 110 - 03/17→06/20 140	for PR number: 1ZL; Fitting Position: Front Axle		13.0470-2609.2 LD2609	Brake System: Lucas / TRW Wear Warning Contact: prepared for wear indicator / excl. wear warning contact Ceramic
2.0 TDI 4motion 2.0 TSI 4motion	140 - 03/17→07/20 176 206 04/17→06/20				
2.0 TDI 2.0 TDI 4motion	147 09/20→ 147 09/20→	for PR number: 1ZL; Fitting Position: Front Axle		13.0460-2609.2 602609	Brake System: Lucas / TRW 25683 20,4 Wear Warning Contact: prepared for wear indicator / excl. wear warning contact
				13.0470-2609.2 LD2609	Brake System: Lucas / TRW Wear Warning Contact: prepared for wear indicator / excl. wear warning contact Ceramic
2.0 TSI	140 05/17→	for PR number: 1ZL; Construction year from: 08/20 →; Fitting Position: Front Axle		13.0460-2609.2 602609	Brake System: Lucas / TRW 25683 20,4 Wear Warning Contact: prepared for wear indicator / excl. wear warning contact
		for PR number: 1ZL; Fitting Position: Front Axle		13.0470-2609.2 LD2609	Brake System: Lucas / TRW Wear Warning Contact: prepared for wear indicator / excl. wear warning contact Ceramic
2.0 TSI 4motion	200 04/18→	for PR number: 1ZL; Construction year from: 08/20 →; Fitting Position: Front Axle		13.0460-2609.2 602609	Brake System: Lucas / TRW 25683 20,4 Wear Warning Contact: prepared for wear indicator / excl. wear warning contact
				13.0470-2609.2 LD2609	Brake System: Lucas / TRW Wear Warning Contact: prepared for wear indicator / excl. wear warning contact Ceramic
 Brake Disc					
1.5 TSI 2.0 TDI	110 11/17→07/19 110 - 03/17→ 147	for PR number: 1ZA / 1ZD / 1ZK / 1ZL; Fitting Position: Front Axle		24.0125-0158.1 425158	Outer diameter [mm]: 312 Brake Disc Thickness [mm] 25 Minimum thickness [mm] 22 Brake Disc Type: Vented Supplementary Article/Info 2: with bolts/screws
2.0 TDI 4motion 2.0 TSI 2.0 TSI 4motion	140 - 03/17→ 176 140 05/17→ 200 - 04/17→ 206				
		for PR number: 1KU / 2EM; Fitting Position: Rear Axle		24.0112-0210.1 412210	Outer diameter [mm]: 300 Brake Disc Thickness [mm] 12 Minimum thickness [mm] 10 Brake Disc Type: Solid Supplementary Article/Info 2: with bolts/screws
 Wheel Speed Sensor					
1.5 TSI 2.0 TDI	110 11/17→07/19 110 - 03/17→06/20 140	Fitting Position: Front Axle Left		24.0711-5273.3 360303	
		Fitting Position: Front Axle Right		24.0711-5274.3 360304	
		Required quantity: 2; Fitting Position: Rear Axle	2	24.0711-6337.3 360390	
2.0 TDI	147 09/20→	Fitting Position: Front Axle Left		24.0711-5273.3 360303	
		Fitting Position: Front Axle Right		24.0711-5274.3 360304	
2.0 TDI 4motion 2.0 TSI 4motion	140 - 03/17→07/20 176 200 - 04/17→ 206	Fitting Position: Front Axle Left		24.0711-5273.3 360303	
		Fitting Position: Front Axle Right		24.0711-5274.3 360304	
		→ Construction year to: 11/19; Fitting Position: Rear Axle Left		24.0711-5401.3 360330	
		Construction year from: 12/19 →; Fitting Position: Rear Axle Left		24.0711-5401.3 360330	
		Construction year from: 12/19 →; Fitting Position: Rear Axle Right		24.0711-5402.3 360331	
		→ Construction year to: 11/19; Fitting Position: Rear Axle Right		24.0711-5402.3 360331	
2.0 TDI 4motion	147 09/20→	Fitting Position: Front Axle Left		24.0711-5273.3 360303	
		Fitting Position: Front Axle Right		24.0711-5274.3 360304	
		Fitting Position: Rear Axle Left		24.0711-5401.3 360330	
		Fitting Position: Rear Axle Right		24.0711-5402.3 360331	
2.0 TSI	140 05/17→	Fitting Position: Front Axle Left		24.0711-5273.3 360303	
		Fitting Position: Front Axle Right		24.0711-5274.3 360304	
		Required quantity: 2; → Construction year to: 07/20; Fitting Position: Rear Axle	2	24.0711-6337.3 360390	

	kW				
VW - ARTEON (3H7, 3H8) 03/17→					
Control Element, parking brake caliper					
1.5 TSI	110 11/17→07/19		Fitting Position: Rear Axle Left	11.9282-1001.3 250159	Brake System: ATE
2.0 TDI	110 - 03/17→ 147		Fitting Position: Rear Axle Right	11.9282-1002.3 250160	Brake System: ATE
2.0 TDI 4motion	140 - 03/17→ 176				
2.0 TSI	140 05/17→				
2.0 TSI 4motion	200 - 04/17→ 206				
VW - ARTEON SHOOTING BRAKE (3H9) 06/20→					
 Brake Caliper					
1.5 TSi	110 08/20→		for PR number: 1ZA / 1ZD / 1ZK / 1ZL;	24.3571-1801.5 241387	Supplementary Article/Supplementary Info: without holder
2.0 TDI	110 - 09/20→ 147		Fitting Position: Front Axle Left		Brake Caliper Type: Fist-type Caliper
2.0 TDI 4motion	140 - 09/20→ 147				
2.0 TSi	140 09/20→		for PR number: 1ZA / 1ZD / 1ZK / 1ZL;	24.3571-1802.5 241388	Supplementary Article/Supplementary Info: without holder
2.0 TSi 4motion	200 09/20→		Fitting Position: Front Axle Right		Brake Caliper Type: Fist-type Caliper
2.0 TSi 4motion	206 06/20→				
 Brake Pad Set, disc brake					
1.5 TSi	110 08/20→		for PR number: 1ZL;	13.0460-2609.2 602609	Brake System: Lucas / TRW 25683 20,4
2.0 TDI	110 - 09/20→ 147		Fitting Position: Front Axle		Wear Warning Contact: prepared for wear indicator / excl. wear warning contact
2.0 TDI 4motion	140 - 09/20→ 147				
2.0 TSi	140 09/20→			13.0470-2609.2 LD2609	Brake System: Lucas / TRW
2.0 TSi 4motion	200 09/20→				Wear Warning Contact: prepared for wear indicator / excl. wear warning contact Ceramic
2.0 TSi 4motion	206 06/20→		for PR number: 1ZL;	13.0460-2609.2 602609	Brake System: Lucas / TRW 25683 20,4
			Construction year from: 08/20 →;		Wear Warning Contact: prepared for wear indicator / excl. wear warning contact
			Fitting Position: Front Axle		
				13.0470-2609.2 LD2609	Brake System: Lucas / TRW
					Wear Warning Contact: prepared for wear indicator / excl. wear warning contact Ceramic
 Brake Disc					
1.5 TSi	110 08/20→		for PR number: 1ZA / 1ZD / 1ZK / 1ZL;	24.0125-0158.1 425158	Outer diameter [mm]: 312
2.0 TDI	110 - 09/20→ 147		Fitting Position: Front Axle		Brake Disc Thickness [mm] 25
2.0 TDI 4motion	140 - 09/20→ 147				Minimum thickness [mm] 22
2.0 TSi	140 09/20→				Brake Disc Type: Vented
2.0 TSi 4motion	200 09/20→				Supplementary Article/Info 2: with bolts/screws
2.0 TSi 4motion	206 06/20→		for PR number: 1KU / 2EM;	24.0112-0210.1 412210	Outer diameter [mm]: 300
			Fitting Position: Rear Axle		Brake Disc Thickness [mm] 12
					Minimum thickness [mm] 10
					Brake Disc Type: Solid
					Supplementary Article/Info 2: with bolts/screws
 Wheel Speed Sensor					
1.5 TSi	110 08/20→		Fitting Position: Front Axle Left	24.0711-5273.3 360303	
2.0 TDI	110 - 09/20→ 147		Fitting Position: Front Axle Right	24.0711-5274.3 360304	
2.0 TSi	140 09/20→				
2.0 TDI 4motion	140 - 09/20→ 147		Fitting Position: Front Axle Left	24.0711-5273.3 360303	
2.0 TSi 4motion	200 09/20→		Fitting Position: Front Axle Right	24.0711-5274.3 360304	
2.0 TSi 4motion	206 06/20→		Fitting Position: Rear Axle Left	24.0711-5401.3 360330	
			Fitting Position: Rear Axle Right	24.0711-5402.3 360331	
Control Element, parking brake caliper					
1.5 TSi	110 08/20→		Fitting Position: Rear Axle Left	11.9282-1001.3 250159	Brake System: ATE
2.0 TDI	110 - 09/20→ 147		Fitting Position: Rear Axle Right	11.9282-1002.3 250160	Brake System: ATE
2.0 TDI 4motion	140 - 09/20→ 147				
2.0 TSi	140 09/20→				
2.0 TSi 4motion	200 09/20→				
2.0 TSi 4motion	206 06/20→				

		kW					
VW - BEETLE (5C1, 5C2) 04/11→07/19							
Guide Bolt, brake caliper							
1.2 TSI	77	07/11→07/19	for PR number: 1ZA / 1ZE / 1ZP; Required quantity: 2	2	11.8171-0008.1	990049	Brake System: ATE
1.2 TSI 16V	77	12/14→07/19					
1.4 TSI	110 - 118	10/11→07/19	for PR number: 1LV / 1ZB / 1ZD; Required quantity: 2	2	11.8171-0008.1	990049	Brake System: ATE
1.6 TDI	77	10/11→07/16					
2.0 TDI	103	04/11→07/16					
2.0 TFSI	147	04/11→07/16					
2.0 TSI	130 - 162	12/14→07/19					
2.5	125	04/11→07/19					
2.0 TDI	81	06/14→09/18	Construction year from: 12/14 →; for PR number: 1ZA / 1ZE / 1ZP; Required quantity: 2	2	11.8171-0008.1	990049	Brake System: ATE
			Construction year from: 12/14 →; for PR number: 1LV / 1ZB / 1ZD; Required quantity: 2	2	11.8171-0008.1	990049	Brake System: ATE
2.0 TDI	110	07/14→09/18	Construction year from: 09/14 →; for PR number: 1ZA / 1ZE / 1ZP; Required quantity: 2	2	11.8171-0008.1	990049	Brake System: ATE
			Construction year from: 09/14 →; for PR number: 1LV / 1ZB / 1ZD; Required quantity: 2	2	11.8171-0008.1	990049	Brake System: ATE
2.0 TSI	155	12/12→07/19	Construction year from: 05/13 →; for PR number: 1ZA / 1ZE / 1ZP; Required quantity: 2	2	11.8171-0008.1	990049	Brake System: ATE
			Construction year from: 05/13 →; for PR number: 1LV / 1ZB / 1ZD; Required quantity: 2	2	11.8171-0008.1	990049	Brake System: ATE
 Brake Disc							
1.2 TSI	77	07/11→07/19	for PR number: 1ZE / 1ZP; Fitting Position: Front Axle		24.0125-0145.1	425145	Outer diameter [mm]: 288 Brake Disc Thickness [mm] 25 Minimum thickness [mm] 22 Brake Disc Type: Vented Supplementary Article/Info 2: with bolts/screws
1.2 TSI 16V	77	12/14→07/19					
1.4 TSI	110 - 118	10/11→07/19					
1.6 TDI	77	10/11→07/16					
2.0 TDI	103	04/11→07/16					
2.0 TFSI	147	04/11→07/16					
2.0 TSI	130 - 162	12/14→07/19	for PR number: 1ZA / 1ZB / 1ZD / 1LV; Fitting Position: Front Axle		24.0125-0158.1	425158	Outer diameter [mm]: 312 Brake Disc Thickness [mm] 25 Minimum thickness [mm] 22 Brake Disc Type: Vented Supplementary Article/Info 2: with bolts/screws
					24.0325-0158.1	525158	Outer diameter [mm]: 312 Brake Disc Thickness [mm] 25 Minimum thickness [mm] 22 Brake Disc Type: Vented Supplementary Article/Info 2: with bolts/screws
			for PR number: 1KS / 1KT; Fitting Position: Rear Axle		24.0110-0356.1	410356	Outer diameter [mm]: 272 Brake Disc Thickness [mm] 9.7 Minimum thickness [mm] 8 Brake Disc Type: Solid Supplementary Article/Info 2: with bolts/screws
					24.0310-0356.1	510356	Outer diameter [mm]: 272 Brake Disc Thickness [mm] 9.7 Minimum thickness [mm] 8 Brake Disc Type: Solid Supplementary Article/Info 2: with bolts/screws
2.0 TDI	81	06/14→09/18	Construction year from: 12/14 →; for PR number: 1ZE / 1ZP; Fitting Position: Front Axle		24.0125-0145.1	425145	Outer diameter [mm]: 288 Brake Disc Thickness [mm] 25 Minimum thickness [mm] 22 Brake Disc Type: Vented Supplementary Article/Info 2: with bolts/screws
			Construction year from: 12/14 →; for PR number: 1ZA / 1ZB / 1ZD / 1LV; Fitting Position: Front Axle		24.0125-0158.1	425158	Outer diameter [mm]: 312 Brake Disc Thickness [mm] 25 Minimum thickness [mm] 22 Brake Disc Type: Vented Supplementary Article/Info 2: with bolts/screws
					24.0325-0158.1	525158	Outer diameter [mm]: 312 Brake Disc Thickness [mm] 25 Minimum thickness [mm] 22 Brake Disc Type: Vented Supplementary Article/Info 2: with bolts/screws

→

		kW					
VW - BEETLE (5C1, 5C2) 04/11→07/19							
 Brake Disc							
2.0 TDI	81 06/14→09/18	Construction year from: 12/14 →; for PR number: 1KS / 1KT; Fitting Position: Rear Axle	24.0110-0356.1 410356	Outer diameter [mm]: 272 Brake Disc Thickness [mm] 9.7 Minimum thickness [mm] 8 Brake Disc Type: Solid Supplementary Article/Info 2: with bolts/screws			
			24.0310-0356.1 510356	Outer diameter [mm]: 272 Brake Disc Thickness [mm] 9.7 Minimum thickness [mm] 8 Brake Disc Type: Solid Supplementary Article/Info 2: with bolts/screws			
2.0 TDI	110 07/14→09/18	Construction year from: 09/14 →; for PR number: 1ZE / 1ZP; Fitting Position: Front Axle	24.0125-0145.1 425145	Outer diameter [mm]: 288 Brake Disc Thickness [mm] 25 Minimum thickness [mm] 22 Brake Disc Type: Vented Supplementary Article/Info 2: with bolts/screws			
			24.0125-0158.1 425158	Outer diameter [mm]: 312 Brake Disc Thickness [mm] 25 Minimum thickness [mm] 22 Brake Disc Type: Vented Supplementary Article/Info 2: with bolts/screws			
			24.0325-0158.1 525158	Outer diameter [mm]: 312 Brake Disc Thickness [mm] 25 Minimum thickness [mm] 22 Brake Disc Type: Vented Supplementary Article/Info 2: with bolts/screws			
2.0 TDI	110 07/14→09/18	Construction year from: 09/14 →; for PR number: 1ZA / 1ZB / 1ZD / 1LV; Fitting Position: Front Axle	24.0110-0356.1 410356	Outer diameter [mm]: 272 Brake Disc Thickness [mm] 9.7 Minimum thickness [mm] 8 Brake Disc Type: Solid Supplementary Article/Info 2: with bolts/screws			
			24.0310-0356.1 510356	Outer diameter [mm]: 272 Brake Disc Thickness [mm] 9.7 Minimum thickness [mm] 8 Brake Disc Type: Solid Supplementary Article/Info 2: with bolts/screws			
			24.0125-0145.1 425145	Outer diameter [mm]: 288 Brake Disc Thickness [mm] 25 Minimum thickness [mm] 22 Brake Disc Type: Vented Supplementary Article/Info 2: with bolts/screws			
2.0 TSI	155 12/12→07/19	Construction year from: 05/13 →; for PR number: 1ZE / 1ZP; Fitting Position: Front Axle	24.0125-0145.1 425145	Outer diameter [mm]: 288 Brake Disc Thickness [mm] 25 Minimum thickness [mm] 22 Brake Disc Type: Vented Supplementary Article/Info 2: with bolts/screws			
			24.0125-0158.1 425158	Outer diameter [mm]: 312 Brake Disc Thickness [mm] 25 Minimum thickness [mm] 22 Brake Disc Type: Vented Supplementary Article/Info 2: with bolts/screws			
			24.0325-0158.1 525158	Outer diameter [mm]: 312 Brake Disc Thickness [mm] 25 Minimum thickness [mm] 22 Brake Disc Type: Vented Supplementary Article/Info 2: with bolts/screws			
2.0 TSI	155 12/12→07/19	Construction year from: 05/13 →; for PR number: 1KS / 1KT; Fitting Position: Rear Axle	24.0110-0356.1 410356	Outer diameter [mm]: 272 Brake Disc Thickness [mm] 9.7 Minimum thickness [mm] 8 Brake Disc Type: Solid Supplementary Article/Info 2: with bolts/screws			
			24.0310-0356.1 510356	Outer diameter [mm]: 272 Brake Disc Thickness [mm] 9.7 Minimum thickness [mm] 8 Brake Disc Type: Solid Supplementary Article/Info 2: with bolts/screws			
			24.0125-0145.1 425145	Outer diameter [mm]: 288 Brake Disc Thickness [mm] 25 Minimum thickness [mm] 22 Brake Disc Type: Vented Supplementary Article/Info 2: with bolts/screws			
2.5	125 04/11→07/19	for PR number: 1ZE / 1ZP; Fitting Position: Front Axle	24.0125-0145.1 425145	Outer diameter [mm]: 288 Brake Disc Thickness [mm] 25 Minimum thickness [mm] 22 Brake Disc Type: Vented Supplementary Article/Info 2: with bolts/screws			
→							

	kW				
VW - BEETLE (5C1, 5C2) 04/11→07/19					
 Brake Disc					
2.5	125 04/11→07/19	for PR number: 1ZA / 1ZB / 1ZD / 1LV; Fitting Position: Front Axle		24.0125-0158.1 425158	Outer diameter [mm]: 312 Brake Disc Thickness [mm] 25 Minimum thickness [mm] 22 Brake Disc Type: Vented Supplementary Article/Info 2: with bolts/screws
		for PR number: 1KS / 1KT; Fitting Position: Rear Axle		24.0110-0356.1 410356	Outer diameter [mm]: 272 Brake Disc Thickness [mm] 9.7 Minimum thickness [mm] 8 Brake Disc Type: Solid Supplementary Article/Info 2: with bolts/screws
				24.0310-0356.1 510356	Outer diameter [mm]: 272 Brake Disc Thickness [mm] 9.7 Minimum thickness [mm] 8 Brake Disc Type: Solid Supplementary Article/Info 2: with bolts/screws
VW - BEETLE Convertible (5C7, 5C8) 12/11→07/19					
Guide Bolt, brake caliper					
1.2 TSI	77 12/11→07/19	Construction year from: 11/12 →; for PR number: 1ZA; Required quantity: 2; Fitting Position: Front Axle	2	11.8171-0008.1 990049	Brake System: ATE
1.4 TSI	118 12/11→07/16				
1.6 TDI	77 12/11→07/16				
2.0 TDI	103 04/12→07/16				
2.0 TFSI	147 12/11→07/16				
		Construction year from: 11/12 →; for PR number: 1ZE / 1ZP; Required quantity: 2; Fitting Position: Front Axle	2	11.8171-0008.1 990049	Brake System: ATE
		Construction year from: 11/12 →; for PR number: 1LV / 1ZB; Required quantity: 2; Fitting Position: Front Axle	2	11.8171-0008.1 990049	Brake System: ATE
1.2 TSI 16V	77 12/14→07/19	for PR number: 1ZE / 1ZP; Required quantity: 2; Fitting Position: Front Axle	2	11.8171-0008.1 990049	Brake System: ATE
1.4 TSI	110 12/14→09/18				
2.0 TDI	110 09/14→09/18				
2.0 TSI	162 12/14→09/18				
		for PR number: 1ZA; Required quantity: 2; Fitting Position: Front Axle	2	11.8171-0008.1 990049	Brake System: ATE
		for PR number: 1LV / 1ZB; Required quantity: 2; Fitting Position: Front Axle	2	11.8171-0008.1 990049	Brake System: ATE
2.0 TDI	81 06/14→09/18	Construction year from: 12/14 →; for PR number: 1ZE / 1ZP; Required quantity: 2; Fitting Position: Front Axle	2	11.8171-0008.1 990049	Brake System: ATE
		Construction year from: 12/14 →; for PR number: 1ZA; Required quantity: 2; Fitting Position: Front Axle	2	11.8171-0008.1 990049	Brake System: ATE
		Construction year from: 12/14 →; for PR number: 1LV / 1ZB; Required quantity: 2; Fitting Position: Front Axle	2	11.8171-0008.1 990049	Brake System: ATE
2.0 TSI	155 12/12→07/19	Construction year from: 05/13 →; for PR number: 1ZA; Required quantity: 2; Fitting Position: Front Axle	2	11.8171-0008.1 990049	Brake System: ATE
		Construction year from: 05/13 →; for PR number: 1LV / 1ZB; Required quantity: 2; Fitting Position: Front Axle	2	11.8171-0008.1 990049	Brake System: ATE
		Construction year from: 05/13 →; for PR number: 1ZE / 1ZP; Required quantity: 2; Fitting Position: Front Axle	2	11.8171-0008.1 990049	Brake System: ATE
2.5	125 12/11→07/16	Construction year from: 12/12 →; for PR number: 1ZE / 1ZP; Required quantity: 2; Fitting Position: Front Axle	2	11.8171-0008.1 990049	Brake System: ATE
		Construction year from: 12/12 →; for PR number: 1ZA; Required quantity: 2; Fitting Position: Front Axle	2	11.8171-0008.1 990049	Brake System: ATE
		Construction year from: 12/12 →; for PR number: 1LV / 1ZB; Required quantity: 2; Fitting Position: Front Axle	2	11.8171-0008.1 990049	Brake System: ATE

→

		kW					
VW - BEETLE Convertible (5C7, 5C8) 12/11→07/19							
 Brake Disc							
1.2 TSI 1.4 TSI 1.6 TDI 2.0 TDI 2.0 TFSI	77 12/11→07/19 118 12/11→07/16 77 12/11→07/16 103 04/12→07/16 147 12/11→07/16	Construction year from: 11/12 →; for PR number: 1ZE / 1ZP; Fitting Position: Front Axle	24.0125-0145.1 425145	Outer diameter [mm]: 288 Brake Disc Thickness [mm] 25 Minimum thickness [mm] 22 Brake Disc Type: Vented Supplementary Article/Info 2: with bolts/screws			
		Construction year from: 11/12 →; for PR number: 1ZA / 1ZB / 1LV; Fitting Position: Front Axle	24.0125-0158.1 425158	Outer diameter [mm]: 312 Brake Disc Thickness [mm] 25 Minimum thickness [mm] 22 Brake Disc Type: Vented Supplementary Article/Info 2: with bolts/screws			
			24.0325-0158.1 525158	Outer diameter [mm]: 312 Brake Disc Thickness [mm] 25 Minimum thickness [mm] 22 Brake Disc Type: Vented Supplementary Article/Info 2: with bolts/screws			
		Construction year from: 11/12 →; for PR number: 1KS / 1KT; Fitting Position: Rear Axle	24.0110-0356.1 410356	Outer diameter [mm]: 272 Brake Disc Thickness [mm] 9.7 Minimum thickness [mm] 8 Brake Disc Type: Solid Supplementary Article/Info 2: with bolts/screws			
			24.0310-0356.1 510356	Outer diameter [mm]: 272 Brake Disc Thickness [mm] 9.7 Minimum thickness [mm] 8 Brake Disc Type: Solid Supplementary Article/Info 2: with bolts/screws			
1.2 TSI 16V 1.4 TSI 2.0 TDI 2.0 TSI	77 12/14→07/19 110 12/14→09/18 110 09/14→09/18 162 12/14→09/18	for PR number: 1ZE / 1ZP; Fitting Position: Front Axle	24.0125-0145.1 425145	Outer diameter [mm]: 288 Brake Disc Thickness [mm] 25 Minimum thickness [mm] 22 Brake Disc Type: Vented Supplementary Article/Info 2: with bolts/screws			
		for PR number: 1ZA / 1ZB / 1LV; Fitting Position: Front Axle	24.0125-0158.1 425158	Outer diameter [mm]: 312 Brake Disc Thickness [mm] 25 Minimum thickness [mm] 22 Brake Disc Type: Vented Supplementary Article/Info 2: with bolts/screws			
			24.0325-0158.1 525158	Outer diameter [mm]: 312 Brake Disc Thickness [mm] 25 Minimum thickness [mm] 22 Brake Disc Type: Vented Supplementary Article/Info 2: with bolts/screws			
		for PR number: 1KS / 1KT; Fitting Position: Rear Axle	24.0110-0356.1 410356	Outer diameter [mm]: 272 Brake Disc Thickness [mm] 9.7 Minimum thickness [mm] 8 Brake Disc Type: Solid Supplementary Article/Info 2: with bolts/screws			
			24.0310-0356.1 510356	Outer diameter [mm]: 272 Brake Disc Thickness [mm] 9.7 Minimum thickness [mm] 8 Brake Disc Type: Solid Supplementary Article/Info 2: with bolts/screws			
2.0 TDI	81 06/14→09/18	Construction year from: 12/14 →; for PR number: 1ZE / 1ZP; Fitting Position: Front Axle	24.0125-0145.1 425145	Outer diameter [mm]: 288 Brake Disc Thickness [mm] 25 Minimum thickness [mm] 22 Brake Disc Type: Vented Supplementary Article/Info 2: with bolts/screws			
		Construction year from: 12/14 →; for PR number: 1ZA / 1ZB / 1LV; Fitting Position: Front Axle	24.0125-0158.1 425158	Outer diameter [mm]: 312 Brake Disc Thickness [mm] 25 Minimum thickness [mm] 22 Brake Disc Type: Vented Supplementary Article/Info 2: with bolts/screws			
			24.0325-0158.1 525158	Outer diameter [mm]: 312 Brake Disc Thickness [mm] 25 Minimum thickness [mm] 22 Brake Disc Type: Vented Supplementary Article/Info 2: with bolts/screws			

→

		kW					
VW - BEETLE Convertible (5C7, 5C8) 12/11→07/19							
 Brake Disc							
2.0 TDI	81 06/14→09/18	Construction year from: 12/14 →; for PR number: 1KS / 1KT; Fitting Position: Rear Axle	24.0110-0356.1 410356	Outer diameter [mm]: 272 Brake Disc Thickness [mm] 9.7 Minimum thickness [mm] 8 Brake Disc Type: Solid Supplementary Article/Info 2: with bolts/screws			
			24.0310-0356.1 510356	Outer diameter [mm]: 272 Brake Disc Thickness [mm] 9.7 Minimum thickness [mm] 8 Brake Disc Type: Solid Supplementary Article/Info 2: with bolts/screws			
2.0 TSI	155 12/12→07/19	Construction year from: 05/13 →; for PR number: 1ZE / 1ZP; Fitting Position: Front Axle	24.0125-0145.1 425145	Outer diameter [mm]: 288 Brake Disc Thickness [mm] 25 Minimum thickness [mm] 22 Brake Disc Type: Vented Supplementary Article/Info 2: with bolts/screws			
			24.0125-0158.1 425158	Outer diameter [mm]: 312 Brake Disc Thickness [mm] 25 Minimum thickness [mm] 22 Brake Disc Type: Vented Supplementary Article/Info 2: with bolts/screws			
			24.0325-0158.1 525158	Outer diameter [mm]: 312 Brake Disc Thickness [mm] 25 Minimum thickness [mm] 22 Brake Disc Type: Vented Supplementary Article/Info 2: with bolts/screws			
2.5	125 12/11→07/16	Construction year from: 05/13 →; for PR number: 1KS / 1KT; Fitting Position: Rear Axle	24.0110-0356.1 410356	Outer diameter [mm]: 272 Brake Disc Thickness [mm] 9.7 Minimum thickness [mm] 8 Brake Disc Type: Solid Supplementary Article/Info 2: with bolts/screws			
			24.0310-0356.1 510356	Outer diameter [mm]: 272 Brake Disc Thickness [mm] 9.7 Minimum thickness [mm] 8 Brake Disc Type: Solid Supplementary Article/Info 2: with bolts/screws			
			24.0125-0145.1 425145	Outer diameter [mm]: 288 Brake Disc Thickness [mm] 25 Minimum thickness [mm] 22 Brake Disc Type: Vented Supplementary Article/Info 2: with bolts/screws			
2.5	125 12/11→07/16	Construction year from: 12/12 →; for PR number: 1ZA / 1ZB / 1LV; Fitting Position: Front Axle	24.0125-0158.1 425158	Outer diameter [mm]: 312 Brake Disc Thickness [mm] 25 Minimum thickness [mm] 22 Brake Disc Type: Vented Supplementary Article/Info 2: with bolts/screws			
			24.0110-0356.1 410356	Outer diameter [mm]: 272 Brake Disc Thickness [mm] 9.7 Minimum thickness [mm] 8 Brake Disc Type: Solid Supplementary Article/Info 2: with bolts/screws			
			24.0310-0356.1 510356	Outer diameter [mm]: 272 Brake Disc Thickness [mm] 9.7 Minimum thickness [mm] 8 Brake Disc Type: Solid Supplementary Article/Info 2: with bolts/screws			
VW - BORA (9M2) 01/05→12/14							
Guide Bolt, brake caliper							
2.0	85 01/05→12/14	Vehicle Identification Number from: 1J-2W315309 →; for PR number: 1LJ; Required quantity: 2	2 11.8171-0008.1 990049	Brake System: ATE			
		→ Vehicle Identification Number to: 1J-2W315308; for PR number: 1LJ; Required quantity: 2	2 11.8171-0008.1 990049	Brake System: ATE			
		for PR number: 1ZQ; Required quantity: 2	2 11.8171-0008.1 990049	Brake System: ATE			
→							



VW - BORA (9M2) 01/05→12/14						
Guide Bolt, brake caliper						
2.0	85	01/05→12/14	for PR number: 1LN / 1ZD / 1ZE / 1ZH; Required quantity: 2	2	11.8171-0008.1 990049	Brake System: ATE
			for PR number: 1LR / 1LS / 1ZM / 1LQ / 1ZP; Required quantity: 2	2	11.8171-0008.1 990049	Brake System: ATE
VW - BORA I (1J2) 10/98→12/13						
Guide Bolt, brake caliper						
1.4 16V	55	03/00→05/05	→ Construction year to: 12/04; for PR number: 1LR / 1LS / 1ZM / 1LQ / 1ZP; Required quantity: 2	2	11.8171-0008.1 990049	Brake System: ATE
1.6	74 - 75	10/98→05/05				
1.6 16V	77	05/00→05/05	→ Vehicle Identification Number to: 1J-2W315308; for PR number: 1LJ; Required quantity: 2	2	11.8171-0008.1 990049	Brake System: ATE
1.6 FSI	81	01/02→05/05				
1.8	92	10/98→05/05				
1.8 4motion	92	02/99→05/05	→ Construction year to: 12/04; for PR number: 1LN / 1ZD / 1ZE / 1ZH; Required quantity: 2	2	11.8171-0008.1 990049	Brake System: ATE
1.9 SDI	50	10/98→05/05				
1.9 TDI	74	09/00→05/05				
1.9 TDI 4motion	74	09/00→05/05				
2.0	85	10/98→12/13	Vehicle Identification Number from: 1J-2W315309 →;	2	11.8171-0008.1 990049	Brake System: ATE
2.0 4motion	85	04/00→05/05	→ Construction year to: 12/04; for PR number: 1LJ; Required quantity: 2			
2.3 V5	125	10/00→05/05				
2.3 V5 4motion	125	10/00→05/05	→ Construction year to: 12/04; for PR number: 1ZQ; Required quantity: 2	2	11.8171-0008.1 990049	Brake System: ATE
1.6	78	06/02→10/04	Vehicle Identification Number from: 1J-2W315309 →; for PR number: 1LJ; Required quantity: 2	2	11.8171-0008.1 990049	Brake System: ATE
1.9 TDI	81	10/98→06/01				
1.9 TDI 4motion	85	02/99→06/01				
2.3 V5	110	10/98→10/00	→ Vehicle Identification Number to: 1J-2W315308; for PR number: 1LJ; Required quantity: 2	2	11.8171-0008.1 990049	Brake System: ATE
			for PR number: 1LR / 1LS / 1ZM / 1LQ / 1ZP; Required quantity: 2	2	11.8171-0008.1 990049	Brake System: ATE
			for PR number: 1LN / 1ZD / 1ZE / 1ZH; Required quantity: 2	2	11.8171-0008.1 990049	Brake System: ATE
			for PR number: 1ZQ; Required quantity: 2	2	11.8171-0008.1 990049	Brake System: ATE
1.8 T	110	05/00→05/05	Construction year from: 09/00 → → Construction year to: 12/04; for PR number: 1ZQ; Required quantity: 2	2	11.8171-0008.1 990049	Brake System: ATE
			Construction year from: 09/00 → → Construction year to: 12/04; for PR number: 1LR / 1LS / 1ZM / 1LQ / 1ZP; Required quantity: 2	2	11.8171-0008.1 990049	Brake System: ATE
			Construction year from: 09/00 → → Construction year to: 12/04; for PR number: 1LN / 1ZD / 1ZE / 1ZH; Required quantity: 2	2	11.8171-0008.1 990049	Brake System: ATE
			Vehicle Identification Number from: 1J-2W315309 →; → Construction year to: 12/04; for PR number: 1LJ; Required quantity: 2	2	11.8171-0008.1 990049	Brake System: ATE
			Construction year from: 09/00 → →; → Vehicle Identification Number to: 1J-2W315308; for PR number: 1LJ; Required quantity: 2	2	11.8171-0008.1 990049	Brake System: ATE
1.8 T	132	03/02→05/05	Construction year from: 05/02 → → Construction year to: 12/04; for PR number: 1LR / 1LS / 1ZM / 1LQ / 1ZP; Required quantity: 2	2	11.8171-0008.1 990049	Brake System: ATE
			Construction year from: 05/02 → → Construction year to: 12/04; for PR number: 1ZQ; Required quantity: 2	2	11.8171-0008.1 990049	Brake System: ATE
			Construction year from: 05/02 → → Construction year to: 12/04; for PR number: 1LN / 1ZD / 1ZE / 1ZH; Required quantity: 2	2	11.8171-0008.1 990049	Brake System: ATE
			Vehicle Identification Number from: 1J-2W315309 →; → Construction year to: 12/04; for PR number: 1LJ; Required quantity: 2	2	11.8171-0008.1 990049	Brake System: ATE
			Construction year from: 05/02 → →; → Vehicle Identification Number to: 1J-2W315308; for PR number: 1LJ; Required quantity: 2	2	11.8171-0008.1 990049	Brake System: ATE
1.9 TDI	66	10/98→05/05	→ Construction year to: 06/01; for PR number: 1LR / 1LS / 1ZM / 1LQ / 1ZP; Required quantity: 2	2	11.8171-0008.1 990049	Brake System: ATE
→						

	kw				
VW - BORA I (1J2) 10/98→12/13					
Guide Bolt, brake caliper					
1.9 TDI	66 10/98→05/05	→ Vehicle Identification Number to: 1J-2W315308; for PR number: 1LJ; Required quantity: 2	2	11.8171-0008.1	990049 Brake System: ATE
		→ Construction year to: 06/01; for PR number: 1LN / 1ZD / 1ZE / 1ZH; Required quantity: 2	2	11.8171-0008.1	990049 Brake System: ATE
		Vehicle Identification Number from: 1J-2W315309 →; → Construction year to: 06/01; for PR number: 1LJ; Required quantity: 2	2	11.8171-0008.1	990049 Brake System: ATE
		→ Construction year to: 06/01; for PR number: 1ZQ; Required quantity: 2	2	11.8171-0008.1	990049 Brake System: ATE
1.9 TDI 1.9 TDI 4motion	85 12/98→01/02 66 11/98→04/02	Construction year from: 02/99 → → Construction year to: 06/01; for PR number: 1LN / 1ZD / 1ZE / 1ZH; Required quantity: 2	2	11.8171-0008.1	990049 Brake System: ATE
		Construction year from: 02/99 → → Construction year to: 06/01; for PR number: 1ZQ; Required quantity: 2	2	11.8171-0008.1	990049 Brake System: ATE
		Construction year from: 02/99 → → Construction year to: 06/01; for PR number: 1LR / 1LS / 1ZM / 1LQ / 1ZP; Required quantity: 2	2	11.8171-0008.1	990049 Brake System: ATE
		Vehicle Identification Number from: 1J-2W315309 →; → Construction year to: 06/01; for PR number: 1LJ; Required quantity: 2	2	11.8171-0008.1	990049 Brake System: ATE
		Construction year from: 02/99 →; → Vehicle Identification Number to: 1J-2W315308; for PR number: 1LJ; Required quantity: 2	2	11.8171-0008.1	990049 Brake System: ATE
1.9 TDI 1.9 TDI 4motion	96 11/00→05/05 96 11/00→05/05	Construction year from: 04/01 → → Construction year to: 12/04; for PR number: 1LN / 1ZD / 1ZE / 1ZH; Required quantity: 2	2	11.8171-0008.1	990049 Brake System: ATE
		Construction year from: 04/01 → → Construction year to: 12/04; for PR number: 1ZQ; Required quantity: 2	2	11.8171-0008.1	990049 Brake System: ATE
		Construction year from: 04/01 → → Construction year to: 12/04; for PR number: 1LR / 1LS / 1ZM / 1LQ / 1ZP; Required quantity: 2	2	11.8171-0008.1	990049 Brake System: ATE
		Vehicle Identification Number from: 1J-2W315309 →; → Construction year to: 12/04; for PR number: 1LJ; Required quantity: 2	2	11.8171-0008.1	990049 Brake System: ATE
		Construction year from: 04/01 →; → Vehicle Identification Number to: 1J-2W315308; for PR number: 1LJ; Required quantity: 2	2	11.8171-0008.1	990049 Brake System: ATE
		Construction year from: 10/00 → → Construction year to: 12/04; for PR number: 1ZQ; Required quantity: 2	2	11.8171-0008.1	990049 Brake System: ATE
1.9 TDI 1.9 TDI 4motion	110 05/00→05/05 110 05/00→05/05	Construction year from: 10/00 → → Construction year to: 12/04; for PR number: 1ZQ; Required quantity: 2	2	11.8171-0008.1	990049 Brake System: ATE
		Construction year from: 10/00 → → Construction year to: 12/04; for PR number: 1LR / 1LS / 1ZM / 1LQ / 1ZP; Required quantity: 2	2	11.8171-0008.1	990049 Brake System: ATE
		Construction year from: 10/00 → → Construction year to: 12/04; for PR number: 1LN / 1ZD / 1ZE / 1ZH; Required quantity: 2	2	11.8171-0008.1	990049 Brake System: ATE
		Vehicle Identification Number from: 1J-2W315309 →; → Construction year to: 12/04; for PR number: 1LJ; Required quantity: 2	2	11.8171-0008.1	990049 Brake System: ATE
		Construction year from: 10/00 →; → Vehicle Identification Number to: 1J-2W315308; for PR number: 1LJ; Required quantity: 2	2	11.8171-0008.1	990049 Brake System: ATE
2.3 V5 4motion	110 12/98→10/00	Construction year from: 02/99 →; for PR number: 1LN / 1ZD / 1ZE / 1ZH; Required quantity: 2	2	11.8171-0008.1	990049 Brake System: ATE
		Construction year from: 02/99 →; for PR number: 1LR / 1LS / 1ZM / 1LQ / 1ZP; Required quantity: 2	2	11.8171-0008.1	990049 Brake System: ATE
→					

	kW				
VW - BORA I (1J2) 10/98→12/13					
Guide Bolt, brake caliper					
2.3 V5 4motion	110 12/98→10/00	Construction year from: 02/99 →; for PR number: 1ZQ; Required quantity: 2	2	11.8171-0008.1	990049 Brake System: ATE
		Vehicle Identification Number from: 1J-2W315309 →; for PR number: 1LJ; Required quantity: 2	2	11.8171-0008.1	990049 Brake System: ATE
		Construction year from: 02/99 →; → Vehicle Identification Number to: 1J-2W315308; for PR number: 1LJ; Required quantity: 2	2	11.8171-0008.1	990049 Brake System: ATE
2.8 V6 4motion	150 03/99→05/05	Construction year from: 05/99 → → Construction year to: 12/04; for PR number: 1LN / 1ZD / 1ZE / 1ZH; Required quantity: 2	2	11.8171-0008.1	990049 Brake System: ATE
		Construction year from: 05/99 → → Construction year to: 12/04; for PR number: 1ZQ; Required quantity: 2	2	11.8171-0008.1	990049 Brake System: ATE
		Construction year from: 05/99 → → Construction year to: 12/04; for PR number: 1LR / 1LS / 1ZM / 1LQ / 1ZP; Required quantity: 2	2	11.8171-0008.1	990049 Brake System: ATE
		Vehicle Identification Number from: 1J-2W315309 →; → Construction year to: 12/04; for PR number: 1LJ; Required quantity: 2	2	11.8171-0008.1	990049 Brake System: ATE
		Construction year from: 05/99 →; → Vehicle Identification Number to: 1J-2W315308; for PR number: 1LJ; Required quantity: 2	2	11.8171-0008.1	990049 Brake System: ATE
VW - BORA Variant (1J6) 05/99→05/05					
Guide Bolt, brake caliper					
1.4 16V	55 09/01→05/05	→ Construction year to: 12/04; for PR number: 1LR / 1LS / 1ZM / 1LQ / 1ZP; Required quantity: 2	2	11.8171-0008.1	990049 Brake System: ATE
1.6	74 - 05/99→05/05				
1.6 16V	77 02/00→05/05	→ Vehicle Identification Number to: 1J-2W315308; for PR number: 1LJ; Required quantity: 2	2	11.8171-0008.1	990049 Brake System: ATE
1.6 FSI	81 01/02→05/05				
1.8 4motion	92 05/99→05/05				
1.8 T	132 05/02→05/05	→ Construction year to: 12/04;	2	11.8171-0008.1	990049 Brake System: ATE
1.9 TDI	74 - 09/00→05/05	for PR number: 1ZQ; Required quantity: 2			
1.9 TDI 4motion	74 - 09/00→05/05				
2.0	110	Vehicle Identification Number from: 1J-2W315309 →;	2	11.8171-0008.1	990049 Brake System: ATE
2.0 4motion	85 05/99→05/05	→ Construction year to: 12/04;			
2.3 V5	85 04/00→05/05	for PR number: 1LJ; Required quantity: 2			
2.3 V5 4motion	125 10/00→05/05	→ Construction year to: 12/04;	2	11.8171-0008.1	990049 Brake System: ATE
2.8 V6 4motion	125 10/00→05/05	for PR number: 1LN / 1ZD / 1ZE / 1ZH; Required quantity: 2			
1.8 T	110 05/00→05/05	Construction year from: 09/00 → → Construction year to: 12/04; for PR number: 1ZQ; Required quantity: 2	2	11.8171-0008.1	990049 Brake System: ATE
		Construction year from: 09/00 → → Construction year to: 12/04; for PR number: 1LR / 1LS / 1ZM / 1LQ / 1ZP; Required quantity: 2	2	11.8171-0008.1	990049 Brake System: ATE
		Construction year from: 09/00 → → Construction year to: 12/04; for PR number: 1LN / 1ZD / 1ZE / 1ZH; Required quantity: 2	2	11.8171-0008.1	990049 Brake System: ATE
		Vehicle Identification Number from: 1J-2W315309 →; → Construction year to: 12/04; for PR number: 1LJ; Required quantity: 2	2	11.8171-0008.1	990049 Brake System: ATE
		Construction year from: 09/00 →; → Vehicle Identification Number to: 1J-2W315308; for PR number: 1LJ; Required quantity: 2	2	11.8171-0008.1	990049 Brake System: ATE
1.9 TDI	66 07/04→05/05	→ Vehicle Identification Number to: 1J-2W315308; for PR number: 1LJ; Required quantity: 2	2	11.8171-0008.1	990049 Brake System: ATE
1.9 TDI	81 - 05/99→06/01	Vehicle Identification Number from: 1J-2W315309 →; for PR number: 1LJ; Required quantity: 2	2	11.8171-0008.1	990049 Brake System: ATE
1.9 TDI 4motion	85 05/99→06/01				
2.3 V5	110 05/99→10/00	→ Vehicle Identification Number to: 1J-2W315308; for PR number: 1LJ; Required quantity: 2	2	11.8171-0008.1	990049 Brake System: ATE
2.3 V5 4motion	110 05/99→10/00				
→					





	kW				
VW - BORA Variant (1J6) 05/99→05/05					
Guide Bolt, brake caliper					
1.9 TDI	81 - 05/99→06/01 85	for PR number: 1LR / 1LS / 1ZM / 1LQ / 1ZP; Required quantity: 2	2	11.8171-0008.1 990049	Brake System: ATE
1.9 TDI 4motion	85 05/99→06/01	for PR number: 1ZQ; Required quantity: 2	2	11.8171-0008.1 990049	Brake System: ATE
2.3 V5	110 05/99→10/00				
2.3 V5 4motion	110 05/99→10/00	for PR number: 1LN / 1ZD / 1ZE / 1ZH; Required quantity: 2	2	11.8171-0008.1 990049	Brake System: ATE
1.9 TDI	96 11/00→05/05	Construction year from: 04/01 → → Construction year to: 12/04; for PR number: 1ZQ; Required quantity: 2	2	11.8171-0008.1 990049	Brake System: ATE
1.9 TDI 4motion	96 11/00→05/05				
		Construction year from: 04/01 → → Construction year to: 12/04; for PR number: 1LR / 1LS / 1ZM / 1LQ / 1ZP; Required quantity: 2	2	11.8171-0008.1 990049	Brake System: ATE
		Construction year from: 04/01 → → Construction year to: 12/04; for PR number: 1LN / 1ZD / 1ZE / 1ZH; Required quantity: 2	2	11.8171-0008.1 990049	Brake System: ATE
		Vehicle Identification Number from: 1J-2W315309 →; → Construction year to: 12/04; for PR number: 1LJ; Required quantity: 2	2	11.8171-0008.1 990049	Brake System: ATE
		Construction year from: 04/01 →; → Vehicle Identification Number to: 1J-2W315308; for PR number: 1LJ; Required quantity: 2	2	11.8171-0008.1 990049	Brake System: ATE
2.0 4motion	88 12/99→05/03	Construction year from: 04/00 →; for PR number: 1ZQ; Required quantity: 2	2	11.8171-0008.1 990049	Brake System: ATE
		Construction year from: 04/00 →; for PR number: 1LR / 1LS / 1ZM / 1LQ / 1ZP; Required quantity: 2	2	11.8171-0008.1 990049	Brake System: ATE
		Construction year from: 04/00 →; for PR number: 1LN / 1ZD / 1ZE / 1ZH; Required quantity: 2	2	11.8171-0008.1 990049	Brake System: ATE
		Vehicle Identification Number from: 1J-2W315309 →; for PR number: 1LJ; Required quantity: 2	2	11.8171-0008.1 990049	Brake System: ATE
		Construction year from: 04/00 →; → Vehicle Identification Number to: 1J-2W315308; for PR number: 1LJ; Required quantity: 2	2	11.8171-0008.1 990049	Brake System: ATE
VW - CADDY III Box Body/MPV (2KA, 2KH, 2CA, 2CH) 03/04→05/15					
Guide Bolt, brake caliper					
1.2 TSI	63 - 09/10→05/15 77	for PR number: 1ZE; Required quantity: 2	2	11.8171-0008.1 990049	Brake System: ATE
1.4	55 - 03/04→08/10 59	for PR number: 1LJ / 1ZA; Required quantity: 2	2	11.8171-0008.1 990049	Brake System: ATE
1.6	75 04/04→05/15				
1.6 BiFuel	75 05/11→05/15				
1.6 TDI	55 - 08/10→05/15 75				
1.9 TDI	55 - 04/04→08/10 77				
1.9 TDI 4motion	77 11/08→08/10				
2.0 EcoFuel	80 04/06→05/15				
2.0 SDI	51 03/04→08/10				
2.0 TDI	62 - 09/07→05/15 125				
2.0 TDI 16V	103 11/10→05/15				
2.0 TDI 16V 4motion	103 11/10→05/15				
2.0 TDI 4motion	62 12/10→05/15				
2.0 TDI	81 08/10→05/15	Construction year from: 10/10 →; for PR number: 1ZE; Required quantity: 2	2	11.8171-0008.1 990049	Brake System: ATE
2.0 TDI 4motion	81 08/10→05/15	Construction year from: 10/10 →; for PR number: 1LJ / 1ZA; Required quantity: 2	2	11.8171-0008.1 990049	Brake System: ATE
 Brake Disc					
1.2 TSI	63 - 09/10→05/15 77	for PR number: 1ZE; Fitting Position: Front Axle		24.0125-0145.1 425145	Outer diameter [mm]: 288 Brake Disc Thickness [mm] 25 Minimum thickness [mm] 22 Brake Disc Type: Vented Supplementary Article/Info 2: with bolts/screws
1.4	55 - 03/04→08/10 59				
1.6	75 04/04→05/15				
1.6 BiFuel	75 05/11→05/15				
1.6 TDI	55 - 08/10→05/15 75				
→					



		kW						
VW - CADDY III Box Body/MPV (2KA, 2KH, 2CA, 2CH) 03/04→05/15								
 Brake Disc								
1.9 TDI	55 - 04/04→08/10	for PR number: 1LJ / 1ZA; Fitting Position: Front Axle	24.0125-0158.1 425158	Outer diameter [mm]: 312 Brake Disc Thickness [mm] 25 Minimum thickness [mm] 22 Brake Disc Type: Vented Supplementary Article/Info 2: with bolts/screws				
1.9 TDI 4motion	77 11/08→08/10							
2.0 EcoFuel	80 04/06→05/15							
2.0 SDI	51 03/04→08/10							
2.0 TDI	62 - 09/07→05/15							
2.0 TDI 16V	103 11/10→05/15							
2.0 TDI 16V 4motion	103 11/10→05/15							
2.0 TDI 4motion	62 12/10→05/15		24.0325-0158.1 525158	Outer diameter [mm]: 312 Brake Disc Thickness [mm] 25 Minimum thickness [mm] 22 Brake Disc Type: Vented Supplementary Article/Info 2: with bolts/screws				
		Vehicle Identification Number from: 2K-B-200 001 →; for PR number: 1ZA / 1ZE / 1ZF / 2E3; Fitting Position: Rear Axle	24.0110-0356.1 410356	Outer diameter [mm]: 272 Brake Disc Thickness [mm] 9.7 Minimum thickness [mm] 8 Brake Disc Type: Solid Supplementary Article/Info 2: with bolts/screws				
			24.0310-0356.1 510356	Outer diameter [mm]: 272 Brake Disc Thickness [mm] 9.7 Minimum thickness [mm] 8 Brake Disc Type: Solid Supplementary Article/Info 2: with bolts/screws				
2.0 TDI	81 08/10→05/15	Construction year from: 10/10 →; for PR number: 1ZE; Fitting Position: Front Axle	24.0125-0145.1 425145	Outer diameter [mm]: 288 Brake Disc Thickness [mm] 25 Minimum thickness [mm] 22 Brake Disc Type: Vented Supplementary Article/Info 2: with bolts/screws				
		Construction year from: 10/10 →; for PR number: 1LJ / 1ZA; Fitting Position: Front Axle	24.0125-0158.1 425158	Outer diameter [mm]: 312 Brake Disc Thickness [mm] 25 Minimum thickness [mm] 22 Brake Disc Type: Vented Supplementary Article/Info 2: with bolts/screws				
		Vehicle Identification Number from: 2K-B-200 001 →; for PR number: 1ZA / 1ZE / 1ZF / 2E3; Fitting Position: Rear Axle	24.0110-0356.1 410356	Outer diameter [mm]: 272 Brake Disc Thickness [mm] 9.7 Minimum thickness [mm] 8 Brake Disc Type: Solid Supplementary Article/Info 2: with bolts/screws				
			24.0310-0356.1 510356	Outer diameter [mm]: 272 Brake Disc Thickness [mm] 9.7 Minimum thickness [mm] 8 Brake Disc Type: Solid Supplementary Article/Info 2: with bolts/screws				
2.0 TDI	125 05/12→05/15	for PR number: 1ZE; Fitting Position: Front Axle	24.0125-0145.1 425145	Outer diameter [mm]: 288 Brake Disc Thickness [mm] 25 Minimum thickness [mm] 22 Brake Disc Type: Vented Supplementary Article/Info 2: with bolts/screws				
		for PR number: 1LJ / 1ZA; Fitting Position: Front Axle	24.0125-0158.1 425158	Outer diameter [mm]: 312 Brake Disc Thickness [mm] 25 Minimum thickness [mm] 22 Brake Disc Type: Vented Supplementary Article/Info 2: with bolts/screws				
		for PR number: 1ZA / 1ZE / 1ZF / 2E3; Fitting Position: Rear Axle	24.0110-0356.1 410356	Outer diameter [mm]: 272 Brake Disc Thickness [mm] 9.7 Minimum thickness [mm] 8 Brake Disc Type: Solid Supplementary Article/Info 2: with bolts/screws				
			24.0310-0356.1 510356	Outer diameter [mm]: 272 Brake Disc Thickness [mm] 9.7 Minimum thickness [mm] 8 Brake Disc Type: Solid Supplementary Article/Info 2: with bolts/screws				
→								





		kW					
VW - CADDY III Box Body/MPV (2KA, 2KH, 2CA, 2CH) 03/04→05/15							
 Brake Disc							
2.0 TDI 4motion	81 08/10→05/15	Construction year from: 10/10 →; for PR number: 1ZE; Fitting Position: Front Axle		24.0125-0145.1 425145	Outer diameter [mm]: 288 Brake Disc Thickness [mm] 25 Minimum thickness [mm] 22 Brake Disc Type: Vented Supplementary Article/Info 2: with bolts/screws		
		Construction year from: 10/10 →; for PR number: 1LJ / 1ZA; Fitting Position: Front Axle		24.0125-0158.1 425158	Outer diameter [mm]: 312 Brake Disc Thickness [mm] 25 Minimum thickness [mm] 22 Brake Disc Type: Vented Supplementary Article/Info 2: with bolts/screws		
				24.0325-0158.1 525158	Outer diameter [mm]: 312 Brake Disc Thickness [mm] 25 Minimum thickness [mm] 22 Brake Disc Type: Vented Supplementary Article/Info 2: with bolts/screws		
Vehicle Identification Number from: 2K-B-200 001 →; for PR number: 1ZA / 1ZE / 1ZF / 2E3; Fitting Position: Rear Axle		24.0110-0356.1 410356	Outer diameter [mm]: 272 Brake Disc Thickness [mm] 9.7 Minimum thickness [mm] 8 Brake Disc Type: Solid Supplementary Article/Info 2: with bolts/screws				
		24.0310-0356.1 510356	Outer diameter [mm]: 272 Brake Disc Thickness [mm] 9.7 Minimum thickness [mm] 8 Brake Disc Type: Solid Supplementary Article/Info 2: with bolts/screws				
 Wheel Speed Sensor							
1.9 TDI 4motion	77 11/08→08/10	Fitting Position: Rear Axle Left		24.0711-5401.3 360330			
		Fitting Position: Rear Axle Right		24.0711-5402.3 360331			
2.0 TDI	81 08/10→05/15	Construction year from: 10/10 →; Required quantity: 2; Vehicle Equipment: for vehicles with parking assistant system; Fitting Position: Rear Axle	2	24.0711-6337.3 360390			
2.0 TDI	125 05/12→05/15	Required quantity: 2; Vehicle Equipment: for vehicles with parking assistant system; Fitting Position: Rear Axle	2	24.0711-6337.3 360390			
2.0 TDI 4motion	62 - 81 08/10→05/15	Construction year from: 06/12 →; Fitting Position: Rear Axle Left		24.0711-5401.3 360330			
		Construction year from: 06/12 →; Fitting Position: Rear Axle Right		24.0711-5402.3 360331			
VW - CADDY III MPV (2KB, 2KJ, 2CB, 2CJ) 03/04→05/15							
Guide Bolt, brake caliper							
1.2 TSI	63 - 77 09/10→05/15	for PR number: 1ZE; Required quantity: 2	2	11.8171-0008.1 990049	Brake System: ATE		
1.4	55 - 59 03/04→08/10	for PR number: 1LJ / 1ZA; Required quantity: 2	2	11.8171-0008.1 990049	Brake System: ATE		
1.6	75 04/04→05/15						
1.6 BiFuel	75 05/11→05/15						
1.6 TDI	55 - 75 08/10→05/15						
1.9 D	48 10/05→06/09						
1.9 TDI	55 - 77 04/04→08/10						
1.9 TDI 4motion	77 05/08→08/10						
2.0 EcoFuel	80 04/06→05/15						
2.0 SDI	51 03/04→08/10						
2.0 TDI	103 - 125 09/07→05/15						
2.0 TDI 16V	103 11/10→05/15						
2.0 TDI 16V 4motion	103 11/10→05/15						
2.0 TDI	81 08/10→05/15	Construction year from: 10/10 →; for PR number: 1ZE; Required quantity: 2	2	11.8171-0008.1 990049	Brake System: ATE		
2.0 TDI 4motion	81 08/10→05/15	Construction year from: 10/10 →; for PR number: 1LJ / 1ZA; Required quantity: 2	2	11.8171-0008.1 990049	Brake System: ATE		
→							





	kW			
VW - CADDY III MPV (2KB, 2KJ, 2CB, 2CJ) 03/04→05/15				
 Brake Disc				
1.2 TSI 1.4 1.6 1.6 BiFuel 1.6 TDI	63 - 09/10→05/15 77 55 - 03/04→08/10 59 75 04/04→05/15 75 05/11→05/15	for PR number: 1ZE; Fitting Position: Front Axle	24.0125-0145.1 425145	Outer diameter [mm]: 288 Brake Disc Thickness [mm] 25 Minimum thickness [mm] 22 Brake Disc Type: Vented Supplementary Article/Info 2: with bolts/screws
1.9 D 1.9 TDI 1.9 TDI 4motion 2.0 EcoFuel 2.0 SDI 2.0 TDI 2.0 TDI 16V 2.0 TDI 16V 4motion	55 - 08/10→05/15 75 48 10/05→06/09 55 - 04/04→08/10 77 77 05/08→08/10 80 04/06→05/15 51 03/04→08/10 103 09/07→08/10 103 11/10→05/15 103 11/10→05/15	for PR number: 1LJ / 1ZA; Fitting Position: Front Axle	24.0125-0158.1 425158 24.0325-0158.1 525158	Outer diameter [mm]: 312 Brake Disc Thickness [mm] 25 Minimum thickness [mm] 22 Brake Disc Type: Vented Supplementary Article/Info 2: with bolts/screws Outer diameter [mm]: 312 Brake Disc Thickness [mm] 25 Minimum thickness [mm] 22 Brake Disc Type: Vented Supplementary Article/Info 2: with bolts/screws
		Vehicle Identification Number from: 2K-B-200 001 →; for PR number: 1ZA / 1ZE / 1ZF / 2E3; Fitting Position: Rear Axle	24.0110-0356.1 410356 24.0310-0356.1 510356	Outer diameter [mm]: 272 Brake Disc Thickness [mm] 9.7 Minimum thickness [mm] 8 Brake Disc Type: Solid Supplementary Article/Info 2: with bolts/screws Outer diameter [mm]: 272 Brake Disc Thickness [mm] 9.7 Minimum thickness [mm] 8 Brake Disc Type: Solid Supplementary Article/Info 2: with bolts/screws
2.0 TDI	81 08/10→05/15	Construction year from: 10/10 →; for PR number: 1ZE; Fitting Position: Front Axle	24.0125-0145.1 425145	Outer diameter [mm]: 288 Brake Disc Thickness [mm] 25 Minimum thickness [mm] 22 Brake Disc Type: Vented Supplementary Article/Info 2: with bolts/screws
		Construction year from: 10/10 →; for PR number: 1LJ / 1ZA; Fitting Position: Front Axle	24.0125-0158.1 425158	Outer diameter [mm]: 312 Brake Disc Thickness [mm] 25 Minimum thickness [mm] 22 Brake Disc Type: Vented Supplementary Article/Info 2: with bolts/screws
		Vehicle Identification Number from: 2K-B-200 001 →; for PR number: 1ZA / 1ZE / 1ZF / 2E3; Fitting Position: Rear Axle	24.0110-0356.1 410356 24.0310-0356.1 510356	Outer diameter [mm]: 272 Brake Disc Thickness [mm] 9.7 Minimum thickness [mm] 8 Brake Disc Type: Solid Supplementary Article/Info 2: with bolts/screws Outer diameter [mm]: 272 Brake Disc Thickness [mm] 9.7 Minimum thickness [mm] 8 Brake Disc Type: Solid Supplementary Article/Info 2: with bolts/screws
2.0 TDI	125 05/12→05/15	for PR number: 1ZE; Fitting Position: Front Axle	24.0125-0145.1 425145	Outer diameter [mm]: 288 Brake Disc Thickness [mm] 25 Minimum thickness [mm] 22 Brake Disc Type: Vented Supplementary Article/Info 2: with bolts/screws
		for PR number: 1LJ / 1ZA; Fitting Position: Front Axle	24.0125-0158.1 425158 24.0325-0158.1 525158	Outer diameter [mm]: 312 Brake Disc Thickness [mm] 25 Minimum thickness [mm] 22 Brake Disc Type: Vented Supplementary Article/Info 2: with bolts/screws Outer diameter [mm]: 312 Brake Disc Thickness [mm] 25 Minimum thickness [mm] 22 Brake Disc Type: Vented Supplementary Article/Info 2: with bolts/screws
		for PR number: 1ZA / 1ZE / 1ZF / 2E3; Fitting Position: Rear Axle	24.0110-0356.1 410356	Outer diameter [mm]: 272 Brake Disc Thickness [mm] 9.7 Minimum thickness [mm] 8 Brake Disc Type: Solid Supplementary Article/Info 2: with bolts/screws







→



	kW				
VW - CADDY III MPV (2KB, 2KJ, 2CB, 2CJ) 03/04→05/15					
 Brake Disc					
2.0 TDI	125	05/12→05/15	for PR number: 1ZA / 1ZE / 1ZF / 2E3; Fitting Position: Rear Axle	24.0310-0356.1 510356	Outer diameter [mm]: 272 Brake Disc Thickness [mm] 9.7 Minimum thickness [mm] 8 Brake Disc Type: Solid Supplementary Article/Info 2: with bolts/screws
2.0 TDI 4motion	81	08/10→05/15	Construction year from: 10/10 →; for PR number: 1ZE; Fitting Position: Front Axle	24.0125-0145.1 425145	Outer diameter [mm]: 288 Brake Disc Thickness [mm] 25 Minimum thickness [mm] 22 Brake Disc Type: Vented Supplementary Article/Info 2: with bolts/screws
			Construction year from: 10/10 →; for PR number: 1LJ / 1ZA; Fitting Position: Front Axle	24.0125-0158.1 425158	Outer diameter [mm]: 312 Brake Disc Thickness [mm] 25 Minimum thickness [mm] 22 Brake Disc Type: Vented Supplementary Article/Info 2: with bolts/screws
			Vehicle Identification Number from: 2K-B-200 001 →; for PR number: 1ZA / 1ZE / 1ZF / 2E3; Fitting Position: Rear Axle	24.0110-0356.1 410356	Outer diameter [mm]: 272 Brake Disc Thickness [mm] 9.7 Minimum thickness [mm] 8 Brake Disc Type: Solid Supplementary Article/Info 2: with bolts/screws
				24.0310-0356.1 510356	Outer diameter [mm]: 272 Brake Disc Thickness [mm] 9.7 Minimum thickness [mm] 8 Brake Disc Type: Solid Supplementary Article/Info 2: with bolts/screws
 Wheel Speed Sensor					
2.0 TDI	81	08/10→05/15	Construction year from: 10/10 →; Required quantity: 2; Vehicle Equipment: for vehicles with parking assistant system; Fitting Position: Rear Axle	2 24.0711-6337.3 360390	
2.0 TDI	125	05/12→05/15	Required quantity: 2; Vehicle Equipment: for vehicles with parking assistant system; Fitting Position: Rear Axle	2 24.0711-6337.3 360390	
2.0 TDI 16V 4motion	103	11/10→05/15	Construction year from: 06/12 →; Fitting Position: Rear Axle Left	24.0711-5401.3 360330	
2.0 TDI 4motion	81	08/10→05/15	Construction year from: 06/12 →; Fitting Position: Rear Axle Right	24.0711-5402.3 360331	
VW - CADDY IV Box Body/MPV (SAA, SAH) 05/15→					
 Brake Caliper					
1.0 TSI	75	11/15→09/20	for PR number: 1ZA; Fitting Position: Front Axle Left	24.3571-1801.5 241387	Supplementary Article/Supplementary Info: without holder Brake Caliper Type: Fist-type Caliper
1.2 TSI	62	06/15→09/20			
1.4 TGI CNG	81	06/15→09/20			
1.4 TSI	92 - 05/15→09/20				
1.6	96		for PR number: 1ZA; Fitting Position: Front Axle Right	24.3571-1802.5 241388	Supplementary Article/Supplementary Info: without holder Brake Caliper Type: Fist-type Caliper
1.6	81	11/15→09/20			
1.6 TDI	55 - 05/15→09/20				
	75				
2.0 TDI	55 - 05/15→09/20				
	110				
2.0 TDI 4motion	55 - 05/15→09/20				
	110				
ABT e-Caddy	83	04/20→			
 Brake Pad Set, disc brake					
1.0 TSI	75	11/15→09/20	for PR number: 1ZE; Fitting Position: Front Axle	13.0460-2609.2 602609	Brake System: Lucas / TRW 25683 20,4 Wear Warning Contact: prepared for wear indicator / excl. wear warning contact
1.2 TSI	62	06/15→09/20			
1.4 TGI CNG	81	06/15→09/20			
1.4 TSI	92 - 05/15→09/20				
1.6	96		for PR number: 1ZE; Fitting Position: Front Axle	13.0470-2609.2 LD2609	Brake System: Lucas / TRW Wear Warning Contact: prepared for wear indicator / excl. wear warning contact Ceramic
1.6	81	11/15→09/20			
1.6 TDI	55 - 05/15→09/20				
	75				





	kW				
VW - CADDY IV Box Body/MPV (SAA, SAH) 05/15→					
 Brake Pad Set, disc brake					
2.0 TDI	55 - 05/15→09/20 110	for PR number: 1ZA; Fitting Position: Front Axle	13.0460-2609.2 602609	Brake System: Lucas / TRW 25683 20,4 Wear Warning Contact: prepared for wear indicator / excl. wear warning contact	
2.0 TDI 4motion	55 - 05/15→09/20 110		13.0470-2609.2 LD2609	Brake System: Lucas / TRW Wear Warning Contact: prepared for wear indicator / excl. wear warning contact Ceramic	
ABT e-Caddy	83 04/20→				
 Brake Disc					
1.0 TSI	75 11/15→09/20	for PR number: 1ZE; Fitting Position: Front Axle	24.0125-0145.1 425145	Outer diameter [mm]: 288 Brake Disc Thickness [mm] 25 Minimum thickness [mm] 22 Brake Disc Type: Vented Supplementary Article/Info 2: with bolts/screws	
1.2 TSI	62 06/15→09/20				
1.4 TGI CNG	81 06/15→09/20				
1.4 TSI	92 - 05/15→09/20 96				
2.0 TDI	55 - 05/15→09/20 110	for PR number: 1ZA; Fitting Position: Front Axle	24.0125-0158.1 425158	Outer diameter [mm]: 312 Brake Disc Thickness [mm] 25 Minimum thickness [mm] 22 Brake Disc Type: Vented Supplementary Article/Info 2: with bolts/screws	
2.0 TDI 4motion	55 - 05/15→09/20 110		24.0325-0158.1 525158	Outer diameter [mm]: 312 Brake Disc Thickness [mm] 25 Minimum thickness [mm] 22 Brake Disc Type: Vented Supplementary Article/Info 2: with bolts/screws	
ABT e-Caddy	83 04/20→				
		Fitting Position: Rear Axle	24.0110-0356.1 410356	Outer diameter [mm]: 272 Brake Disc Thickness [mm] 9.7 Minimum thickness [mm] 8 Brake Disc Type: Solid Supplementary Article/Info 2: with bolts/screws	
			24.0310-0356.1 510356	Outer diameter [mm]: 272 Brake Disc Thickness [mm] 9.7 Minimum thickness [mm] 8 Brake Disc Type: Solid Supplementary Article/Info 2: with bolts/screws	
1.6	81 11/15→09/20	for PR number: 1ZE; Fitting Position: Front Axle	24.0125-0145.1 425145	Outer diameter [mm]: 288 Brake Disc Thickness [mm] 25 Minimum thickness [mm] 22 Brake Disc Type: Vented Supplementary Article/Info 2: with bolts/screws	
1.6 TDI	55 - 05/15→09/20 75		24.0125-0158.1 425158	Outer diameter [mm]: 312 Brake Disc Thickness [mm] 25 Minimum thickness [mm] 22 Brake Disc Type: Vented Supplementary Article/Info 2: with bolts/screws	
2.0 TDI	103 05/15→09/20		24.0110-0356.1 410356	Outer diameter [mm]: 272 Brake Disc Thickness [mm] 9.7 Minimum thickness [mm] 8 Brake Disc Type: Solid Supplementary Article/Info 2: with bolts/screws	
		Fitting Position: Rear Axle	24.0310-0356.1 510356	Outer diameter [mm]: 272 Brake Disc Thickness [mm] 9.7 Minimum thickness [mm] 8 Brake Disc Type: Solid Supplementary Article/Info 2: with bolts/screws	
 Wheel Speed Sensor					
1.0 TSI	75 11/15→09/20	Required quantity: 2; for PR number: 1BH / 1BJ / 7X0 / 7X1; Fitting Position: Rear Axle	2 24.0711-6337.3 360390		
1.2 TSI	62 06/15→09/20				
1.4 TGI CNG	81 06/15→09/20				
1.4 TSI	92 - 05/15→09/20 96	Required quantity: 2; for PR number: 7X5 / 7X6 / 7X7 / 7X9; Fitting Position: Rear Axle	2 24.0711-6337.3 360390		
1.6	81 11/15→09/20				
1.6 TDI	55 - 05/15→09/20 75				
2.0 TDI	55 - 05/15→09/20 110				
2.0 TDI 4motion	55 - 05/15→09/20 110				



	kW				
VW - CADDY IV Box Body/MPV (SAA, SAH) 05/15→					
 Wheel Speed Sensor					
2.0 TDI 4motion	90 - 05/15→09/20		Fitting Position: Rear Axle Left	24.0711-5401.3	360330
	103				
ABT e-Caddy	83 04/20→		Fitting Position: Rear Axle Right	24.0711-5402.3	360331
VW - CADDY IV MPV (SAB, SAJ) 05/15→					
 Brake Caliper					
1.0 TSI	62 - 11/15→09/20		for PR number: 1ZA; Fitting Position: Front Axle Left	24.3571-1801.5	241387 Supplementary Article/Supplementary Info: without holder Brake Caliper Type: Fist-type Caliper
	75				
1.2 TSI	62 06/15→09/20				
1.4 TGI CNG	81 06/15→09/20				
1.4 TSI	92 - 05/15→09/20		for PR number: 1ZA; Fitting Position: Front Axle Right	24.3571-1802.5	241388 Supplementary Article/Supplementary Info: without holder Brake Caliper Type: Fist-type Caliper
	96				
1.6	81 11/15→09/20				
1.6 TDI	55 - 05/15→09/20				
	75				
2.0 TDI	55 - 05/15→09/20				
	110				
2.0 TDI 4motion	81 - 05/15→09/20				
	110				
ABT e-Caddy	83 04/20→				
 Brake Pad Set, disc brake					
1.0 TSI	62 - 11/15→09/20		for PR number: 1ZE; Fitting Position: Front Axle	13.0460-2609.2	602609 Brake System: Lucas / TRW 25683 20,4 Wear Warning Contact: prepared for wear indicator / excl. wear warning contact
	75				
1.2 TSI	62 06/15→09/20				
1.4 TGI CNG	81 06/15→09/20				
1.4 TSI	92 - 05/15→09/20			13.0470-2609.2	LD2609 Brake System: Lucas / TRW Wear Warning Contact: prepared for wear indicator / excl. wear warning contact Ceramic
	96				
1.6	81 11/15→09/20				
1.6 TDI	55 - 05/15→09/20				
	75				
2.0 TDI	55 - 05/15→09/20				
	110				
2.0 TDI 4motion	81 - 05/15→09/20		for PR number: 1ZA; Fitting Position: Front Axle	13.0460-2609.2	602609 Brake System: Lucas / TRW 25683 20,4 Wear Warning Contact: prepared for wear indicator / excl. wear warning contact
	110				
ABT e-Caddy	83 04/20→			13.0470-2609.2	LD2609 Brake System: Lucas / TRW Wear Warning Contact: prepared for wear indicator / excl. wear warning contact Ceramic
 Brake Disc					
1.0 TSI	62 - 11/15→09/20		for PR number: 1ZE; Fitting Position: Front Axle	24.0125-0145.1	425145 Outer diameter [mm]: 288 Brake Disc Thickness [mm] 25 Minimum thickness [mm] 22 Brake Disc Type: Vented Supplementary Article/Info 2: with bolts/screws
	75				
1.2 TSI	62 06/15→09/20				
1.4 TGI CNG	81 06/15→09/20				
1.4 TSI	92 - 05/15→09/20				
	96				
2.0 TDI	55 - 05/15→09/20		for PR number: 1ZA; Fitting Position: Front Axle	24.0125-0158.1	425158 Outer diameter [mm]: 312 Brake Disc Thickness [mm] 25 Minimum thickness [mm] 22 Brake Disc Type: Vented Supplementary Article/Info 2: with bolts/screws
	110				
2.0 TDI 4motion	81 - 05/15→09/20				
	110				
ABT e-Caddy	83 04/20→			24.0325-0158.1	525158 Outer diameter [mm]: 312 Brake Disc Thickness [mm] 25 Minimum thickness [mm] 22 Brake Disc Type: Vented Supplementary Article/Info 2: with bolts/screws
			Fitting Position: Rear Axle	24.0110-0356.1	410356 Outer diameter [mm]: 272 Brake Disc Thickness [mm] 9.7 Minimum thickness [mm] 8 Brake Disc Type: Solid Supplementary Article/Info 2: with bolts/screws
				24.0310-0356.1	510356 Outer diameter [mm]: 272 Brake Disc Thickness [mm] 9.7 Minimum thickness [mm] 8 Brake Disc Type: Solid Supplementary Article/Info 2: with bolts/screws
1.6	81 11/15→09/20		for PR number: 1ZE; Fitting Position: Front Axle	24.0125-0145.1	425145 Outer diameter [mm]: 288 Brake Disc Thickness [mm] 25 Minimum thickness [mm] 22 Brake Disc Type: Vented Supplementary Article/Info 2: with bolts/screws
1.6 TDI	55 - 05/15→09/20				
	75				
2.0 TDI	103 05/15→09/20				
2.0 TDI 4motion	103 05/15→09/20				



	kW				
VW - CADDY IV MPV (SAB, SAJ) 05/15→					
 Brake Disc					
1.6 1.6 TDI	81 11/15→09/20 55 - 05/15→09/20		for PR number: 1ZA; Fitting Position: Front Axle	24.0125-0158.1 425158	Outer diameter [mm]: 312 Brake Disc Thickness [mm] 25 Minimum thickness [mm] 22 Brake Disc Type: Vented Supplementary Article/Info 2: with bolts/screws
2.0 TDI 2.0 TDI 4motion	103 05/15→09/20 103 05/15→09/20				
			Fitting Position: Rear Axle	24.0110-0356.1 410356	Outer diameter [mm]: 272 Brake Disc Thickness [mm] 9.7 Minimum thickness [mm] 8 Brake Disc Type: Solid Supplementary Article/Info 2: with bolts/screws
				24.0310-0356.1 510356	Outer diameter [mm]: 272 Brake Disc Thickness [mm] 9.7 Minimum thickness [mm] 8 Brake Disc Type: Solid Supplementary Article/Info 2: with bolts/screws
 Wheel Speed Sensor					
1.0 TSI	62 - 11/15→09/20		Required quantity: 2; for PR number: 1BH / 1BJ / 7X0 / 7X1; Fitting Position: Rear Axle	2 24.0711-6337.3 360390	
1.2 TSI	62 06/15→09/20				
1.4 TGI CNG	81 06/15→09/20		Required quantity: 2; for PR number: 7X5 / 7X6 / 7X7 / 7X9; Fitting Position: Rear Axle	2 24.0711-6337.3 360390	
1.4 TSI	92 - 05/15→09/20				
1.6	81 11/15→09/20				
1.6 TDI	55 - 05/15→09/20				
2.0 TDI	55 - 05/15→09/20				
2.0 TDI 4motion	81 - 05/15→09/20				
2.0 TDI 4motion	90 - 05/15→09/20		Fitting Position: Rear Axle Left	24.0711-5401.3 360330	
	103		Fitting Position: Rear Axle Right	24.0711-5402.3 360331	
ABT e-Caddy	83 04/20→				
VW - CADDY V Box Body/MPV (SBA, SBH) 09/20→					
 Brake Caliper					
1.5 TSi EVO	84 01/21→		for PR number: 1ZK; Fitting Position: Front Axle Left	24.3571-1801.5 241387	Supplementary Article/Supplementary Info: without holder Brake Caliper Type: Fist-type Caliper
1.6 SRE	81 02/21→				
2.0 TDi BMT	55 - 09/20→				
2.0 TDI BMT 4motion	90 03/21→		for PR number: 1ZK; Fitting Position: Front Axle Right	24.3571-1802.5 241388	Supplementary Article/Supplementary Info: without holder Brake Caliper Type: Fist-type Caliper
 Brake Pad Set, disc brake					
1.5 TSi EVO	84 01/21→		for PR number: 1ZK; Fitting Position: Front Axle	13.0460-2609.2 602609	Brake System: Lucas / TRW 25683 20,4 Wear Warning Contact: prepared for wear indicator / excl. wear warning contact
1.6 SRE	81 02/21→				
2.0 TDi BMT	55 - 09/20→				
2.0 TDI BMT 4motion	90 03/21→			13.0470-2609.2 LD2609	Brake System: Lucas / TRW Wear Warning Contact: prepared for wear indicator / excl. wear warning contact Ceramic
 Brake Disc					
1.5 TSi EVO	84 01/21→		for PR number: 1ZE; Fitting Position: Front Axle	24.0125-0145.1 425145	Outer diameter [mm]: 288 Brake Disc Thickness [mm] 25 Minimum thickness [mm] 22 Brake Disc Type: Vented Supplementary Article/Info 2: with bolts/screws
1.6 SRE	81 02/21→				
2.0 TDi BMT	55 - 09/20→				
2.0 TDI BMT 4motion	90 03/21→		for PR number: 1ZK; Fitting Position: Front Axle	24.0125-0158.1 425158	Outer diameter [mm]: 312 Brake Disc Thickness [mm] 25 Minimum thickness [mm] 22 Brake Disc Type: Vented Supplementary Article/Info 2: with bolts/screws
→					



	kW				
VW - CADDY V Box Body/MPV (SBA, SBH) 09/20→					
 Brake Disc					
1.5 TSi EVO	84	01/21→	for PR number: 1KE; Fitting Position: Rear Axle	24.0110-0356.1 410356	Outer diameter [mm]: 272 Brake Disc Thickness [mm] 9.7 Minimum thickness [mm] 8 Brake Disc Type: Solid Supplementary Article/Info 2: with bolts/screws
1.6 SRE	81	02/21→			
2.0 TDi BMT	55 - 09/20→	90			
2.0 TDI BMT 4motion	90	03/21→			
			for PR number: 1KU; Fitting Position: Rear Axle	24.0112-0210.1 412210	Outer diameter [mm]: 300 Brake Disc Thickness [mm] 12 Minimum thickness [mm] 10 Brake Disc Type: Solid Supplementary Article/Info 2: with bolts/screws
 Wheel Speed Sensor					
1.5 TSi EVO	84	01/21→	Fitting Position: Front Axle Left	24.0711-5273.3 360303	
1.6 SRE	81	02/21→	Fitting Position: Front Axle Right	24.0711-5274.3 360304	
2.0 TDi BMT	55 - 09/20→	90			
2.0 TDI BMT 4motion	90	03/21→			
VW - CADDY V MPV (SBB, SBJ) 09/20→					
 Brake Caliper					
1.5 TSi EVO	84	01/21→	for PR number: 1ZK; Fitting Position: Front Axle Left	24.3571-1801.5 241387	Supplementary Article/Supplementary Info: without holder Brake Caliper Type: Fist-type Caliper
1.6 SRE	81	02/21→	for PR number: 1ZK; Fitting Position: Front Axle Right	24.3571-1802.5 241388	Supplementary Article/Supplementary Info: without holder Brake Caliper Type: Fist-type Caliper
2.0 TDi BMT	55 - 09/20→	90			
2.0 TDI BMT 4WD	90	03/21→			
 Brake Pad Set, disc brake					
1.5 TSi EVO	84	01/21→	for PR number: 1ZK; Fitting Position: Front Axle	13.0460-2609.2 602609	Brake System: Lucas / TRW 25683 20,4 Wear Warning Contact: prepared for wear indicator / excl. wear warning contact
1.6 SRE	81	02/21→			
2.0 TDi BMT	55 - 09/20→	90		13.0470-2609.2 LD2609	Brake System: Lucas / TRW Wear Warning Contact: prepared for wear indicator / excl. wear warning contact Ceramic
2.0 TDI BMT 4WD	90	03/21→			
 Brake Disc					
1.5 TSi EVO	84	01/21→	for PR number: 1ZE; Fitting Position: Front Axle	24.0125-0145.1 425145	Outer diameter [mm]: 288 Brake Disc Thickness [mm] 25 Minimum thickness [mm] 22 Brake Disc Type: Vented Supplementary Article/Info 2: with bolts/screws
1.6 SRE	81	02/21→			
2.0 TDi BMT	55 - 09/20→	90		24.0125-0158.1 425158	Outer diameter [mm]: 312 Brake Disc Thickness [mm] 25 Minimum thickness [mm] 22 Brake Disc Type: Vented Supplementary Article/Info 2: with bolts/screws
2.0 TDI BMT 4WD	90	03/21→			
			for PR number: 1KE; Fitting Position: Rear Axle	24.0110-0356.1 410356	Outer diameter [mm]: 272 Brake Disc Thickness [mm] 9.7 Minimum thickness [mm] 8 Brake Disc Type: Solid Supplementary Article/Info 2: with bolts/screws
			for PR number: 1KU; Fitting Position: Rear Axle	24.0112-0210.1 412210	Outer diameter [mm]: 300 Brake Disc Thickness [mm] 12 Minimum thickness [mm] 10 Brake Disc Type: Solid Supplementary Article/Info 2: with bolts/screws
 Wheel Speed Sensor					
1.5 TSi EVO	84	01/21→	Fitting Position: Front Axle Left	24.0711-5273.3 360303	
1.6 SRE	81	02/21→	Fitting Position: Front Axle Right	24.0711-5274.3 360304	
2.0 TDi BMT	55 - 09/20→	90			
2.0 TDI BMT 4WD	90	03/21→			



	kW				
VW - CADDY ALLTRACK Box Body/MPV (SAA) 05/15→					
 Brake Caliper					
1.0 TSI	75 11/15→	for PR number: 1ZA; Fitting Position: Front Axle Left	24.3571-1801.5 241387	Supplementary Article/Supplementary Info: without holder Brake Caliper Type: Fist-type Caliper	
1.2 TSI	62 06/15→				
1.4 TGI CNG	81 06/15→				
1.4 TSI	92 - 05/15→				
	96	for PR number: 1ZA; Fitting Position: Front Axle Right	24.3571-1802.5 241388	Supplementary Article/Supplementary Info: without holder Brake Caliper Type: Fist-type Caliper	
1.6 SRE	81 11/15→09/20				
1.6 TDI	55 - 05/15→				
	75				
2.0 TDI	55 - 05/15→				
	110				
2.0 TDI 4motion	81 - 05/15→				
	110				
 Brake Pad Set, disc brake					
1.0 TSI	75 11/15→	for PR number: 1ZE; Fitting Position: Front Axle	13.0460-2609.2 602609	Brake System: Lucas / TRW 25683 20,4 Wear Warning Contact: prepared for wear indicator / excl. wear warning contact	
1.2 TSI	62 06/15→				
1.4 TGI CNG	81 06/15→				
1.4 TSI	92 - 05/15→				
	96	for PR number: 1ZA; Fitting Position: Front Axle	13.0470-2609.2 LD2609	Brake System: Lucas / TRW 25683 20,4 Wear Warning Contact: prepared for wear indicator / excl. wear warning contact Ceramic	
1.6 SRE	81 11/15→09/20				
1.6 TDI	55 - 05/15→				
	75				
2.0 TDI	55 - 05/15→				
	110	for PR number: 1ZA; Fitting Position: Front Axle	13.0460-2609.2 602609	Brake System: Lucas / TRW 25683 20,4 Wear Warning Contact: prepared for wear indicator / excl. wear warning contact	
2.0 TDI 4motion	81 - 05/15→				
	110				
	110			13.0470-2609.2 LD2609 Brake System: Lucas / TRW 25683 20,4 Wear Warning Contact: prepared for wear indicator / excl. wear warning contact Ceramic	
 Brake Disc					
1.0 TSI	75 11/15→	for PR number: 1ZE; Fitting Position: Front Axle	24.0125-0145.1 425145	Outer diameter [mm]: 288 Brake Disc Thickness [mm] 25 Minimum thickness [mm] 22 Brake Disc Type: Vented Supplementary Article/Info 2: with bolts/screws	
1.2 TSI	62 06/15→				
1.4 TGI CNG	81 06/15→				
1.4 TSI	92 05/15→				
1.6 SRE	81 11/15→09/20	for PR number: 1ZA; Fitting Position: Front Axle	24.0125-0158.1 425158	Outer diameter [mm]: 312 Brake Disc Thickness [mm] 25 Minimum thickness [mm] 22 Brake Disc Type: Vented Supplementary Article/Info 2: with bolts/screws	
2.0 TDI	55 - 05/15→				
	110				
2.0 TDI 4motion	90 - 05/15→				
	110				
	110	Fitting Position: Rear Axle	24.0110-0356.1 410356	Outer diameter [mm]: 272 Brake Disc Thickness [mm] 9.7 Minimum thickness [mm] 8 Brake Disc Type: Solid Supplementary Article/Info 2: with bolts/screws	
	110				
	110			24.0325-0158.1 525158 Outer diameter [mm]: 312 Brake Disc Thickness [mm] 25 Minimum thickness [mm] 22 Brake Disc Type: Vented Supplementary Article/Info 2: with bolts/screws	
	110			24.0310-0356.1 510356 Outer diameter [mm]: 272 Brake Disc Thickness [mm] 9.7 Minimum thickness [mm] 8 Brake Disc Type: Solid Supplementary Article/Info 2: with bolts/screws	
1.4 TSI	96 06/19→	for PR number: 1ZE; Fitting Position: Front Axle	24.0125-0145.1 425145	Outer diameter [mm]: 288 Brake Disc Thickness [mm] 25 Minimum thickness [mm] 22 Brake Disc Type: Vented Supplementary Article/Info 2: with bolts/screws	
1.6 TDI	55 - 05/15→				
	75				
2.0 TDI	103 05/15→				
2.0 TDI 4motion	81 - 05/15→	for PR number: 1ZA; Fitting Position: Front Axle	24.0125-0158.1 425158	Outer diameter [mm]: 312 Brake Disc Thickness [mm] 25 Minimum thickness [mm] 22 Brake Disc Type: Vented Supplementary Article/Info 2: with bolts/screws	
	103				
	103				

	kW				
VW - CADDY ALLTRACK Box Body/MPV (SAA) 05/15→					
 Brake Disc					
1.4 TSI	96 06/19→	Fitting Position: Rear Axle		24.0110-0356.1 410356	Outer diameter [mm]: 272 Brake Disc Thickness [mm] 9.7 Minimum thickness [mm] 8 Brake Disc Type: Solid Supplementary Article/Info 2: with bolts/screws
1.6 TDI	55 - 05/15→ 75				
2.0 TDI	103 05/15→				
2.0 TDI 4motion	81 - 05/15→ 103				
				24.0310-0356.1 510356	Outer diameter [mm]: 272 Brake Disc Thickness [mm] 9.7 Minimum thickness [mm] 8 Brake Disc Type: Solid Supplementary Article/Info 2: with bolts/screws
 Wheel Speed Sensor					
1.0 TSI	75 11/15→	Required quantity: 2; for PR number: 1BH / 1BJ / 7X0 / 7X1; Fitting Position: Rear Axle		2 24.0711-6337.3 360390	
1.2 TSI	62 06/15→				
1.4 TGI CNG	81 06/15→				
1.4 TSI	92 - 05/15→ 96				
1.6 SRE	81 11/15→09/20	Required quantity: 2; for PR number: 7X5 / 7X6 / 7X7 / 7X9; Fitting Position: Rear Axle		2 24.0711-6337.3 360390	
1.6 TDI	55 - 05/15→ 75				
2.0 TDI	55 - 05/15→ 110				
2.0 TDI 4motion	110 11/15→				
2.0 TDI 4motion	81 - 05/15→ 103				
		Fitting Position: Rear Axle Left		24.0711-5401.3 360330	
		Fitting Position: Rear Axle Right		24.0711-5402.3 360331	
VW - CADDY ALLTRACK MPV (SAB) 05/15→					
 Brake Caliper					
1.0 TSI	62 - 11/15→ 75	for PR number: 1ZA; Fitting Position: Front Axle Left		24.3571-1801.5 241387	Supplementary Article/Supplementary Info: without holder Brake Caliper Type: Fist-type Caliper
1.2 TSI	62 06/15→				
1.4 TGI CNG	81 06/15→				
1.4 TSI	92 - 05/15→ 96				
1.6 TDI	55 - 05/15→ 75	for PR number: 1ZA; Fitting Position: Front Axle Right		24.3571-1802.5 241388	Supplementary Article/Supplementary Info: without holder Brake Caliper Type: Fist-type Caliper
2.0 TDI	55 - 05/15→ 110				
2.0 TDI 4motion	90 - 05/15→ 110				
2.0 TDI 4motion	81 - 05/15→ 103				
		Construction year from: 11/15 →; for PR number: 1ZA; Fitting Position: Front Axle Left		24.3571-1801.5 241387	Supplementary Article/Supplementary Info: without holder Brake Caliper Type: Fist-type Caliper
		Construction year from: 11/15 →; for PR number: 1ZA; Fitting Position: Front Axle Right		24.3571-1802.5 241388	Supplementary Article/Supplementary Info: without holder Brake Caliper Type: Fist-type Caliper
 Brake Pad Set, disc brake					
1.0 TSI	62 - 11/15→ 75	for PR number: 1ZE; Fitting Position: Front Axle		13.0460-2609.2 602609	Brake System: Lucas / TRW 25683 20,4 Wear Warning Contact: prepared for wear indicator / excl. wear warning contact
1.2 TSI	62 06/15→				
1.4 TGI CNG	81 06/15→				
1.4 TSI	92 - 05/15→ 96				
1.6 TDI	55 - 05/15→ 75				
2.0 TDI	55 - 05/15→ 110	for PR number: 1ZA; Fitting Position: Front Axle		13.0470-2609.2 LD2609	Brake System: Lucas / TRW 25683 20,4 Wear Warning Contact: prepared for wear indicator / excl. wear warning contact Ceramic
2.0 TDI 4motion	81 - 05/15→ 110				
				13.0460-2609.2 602609	Brake System: Lucas / TRW 25683 20,4 Wear Warning Contact: prepared for wear indicator / excl. wear warning contact
				13.0470-2609.2 LD2609	Brake System: Lucas / TRW 25683 20,4 Wear Warning Contact: prepared for wear indicator / excl. wear warning contact Ceramic



		kW					
VW - CADDY ALLTRACK MPV (SAB) 05/15→							
 Brake Disc							
1.0 TSI	62 11/18→	for PR number: 1ZE; Fitting Position: Front Axle		24.0125-0145.1 425145	Outer diameter [mm]: 288 Brake Disc Thickness [mm] 25 Minimum thickness [mm] 22 Brake Disc Type: Vented Supplementary Article/Info 2: with bolts/screws		
1.4 TSI	96 07/18→						
1.6 TDI	55 - 05/15→ 75	for PR number: 1ZA; Fitting Position: Front Axle		24.0125-0158.1 425158	Outer diameter [mm]: 312 Brake Disc Thickness [mm] 25 Minimum thickness [mm] 22 Brake Disc Type: Vented Supplementary Article/Info 2: with bolts/screws		
2.0 TDI	103 05/15→						
2.0 TDI 4motion	81 - 05/15→ 103	Fitting Position: Rear Axle		24.0110-0356.1 410356	Outer diameter [mm]: 272 Brake Disc Thickness [mm] 9.7 Minimum thickness [mm] 8 Brake Disc Type: Solid Supplementary Article/Info 2: with bolts/screws		
				24.0310-0356.1 510356	Outer diameter [mm]: 272 Brake Disc Thickness [mm] 9.7 Minimum thickness [mm] 8 Brake Disc Type: Solid Supplementary Article/Info 2: with bolts/screws		
1.0 TSI	75 11/15→	for PR number: 1ZE; Fitting Position: Front Axle		24.0125-0145.1 425145	Outer diameter [mm]: 288 Brake Disc Thickness [mm] 25 Minimum thickness [mm] 22 Brake Disc Type: Vented Supplementary Article/Info 2: with bolts/screws		
1.2 TSI	62 06/15→						
1.4 TGI CNG	81 06/15→	for PR number: 1ZA; Fitting Position: Front Axle		24.0125-0158.1 425158	Outer diameter [mm]: 312 Brake Disc Thickness [mm] 25 Minimum thickness [mm] 22 Brake Disc Type: Vented Supplementary Article/Info 2: with bolts/screws		
1.4 TSI	92 05/15→						
2.0 TDI	55 - 05/15→ 110	Fitting Position: Rear Axle		24.0110-0356.1 410356	Outer diameter [mm]: 272 Brake Disc Thickness [mm] 9.7 Minimum thickness [mm] 8 Brake Disc Type: Solid Supplementary Article/Info 2: with bolts/screws		
2.0 TDI 4motion	90 - 05/15→ 110						
				24.0325-0158.1 525158	Outer diameter [mm]: 312 Brake Disc Thickness [mm] 25 Minimum thickness [mm] 22 Brake Disc Type: Vented Supplementary Article/Info 2: with bolts/screws		
				24.0310-0356.1 510356	Outer diameter [mm]: 272 Brake Disc Thickness [mm] 9.7 Minimum thickness [mm] 8 Brake Disc Type: Solid Supplementary Article/Info 2: with bolts/screws		
 Wheel Speed Sensor							
1.0 TSI	62 - 11/15→ 75	Required quantity: 2; for PR number: 1BH / 1BJ / 7X0 / 7X1; Fitting Position: Rear Axle		2	24.0711-6337.3 360390		
1.2 TSI	62 06/15→						
1.4 TGI CNG	81 06/15→	Required quantity: 2; for PR number: 7X5 / 7X6 / 7X7 / 7X9; Fitting Position: Rear Axle		2	24.0711-6337.3 360390		
1.4 TSI	92 - 05/15→ 96						
1.6 TDI	55 - 05/15→ 75	Fitting Position: Rear Axle Left			24.0711-5401.3 360330		
2.0 TDI	55 - 05/15→ 110						
2.0 TDI 4motion	81 - 05/15→ 110	Fitting Position: Rear Axle Right			24.0711-5402.3 360331		
2.0 TDI 4motion	90 05/15→						
VW - CADDY Box Body/MPV (6K9, 9E7, 9E9) 09/02→12/09							
Guide Bolt, brake caliper							
1.9 D	47 02/98→06/09	for PR number: 1ZE; Required quantity: 2		2	11.8171-0008.1 990049	Brake System: ATE	
		for PR number: 1LJ / 1ZA; Required quantity: 2		2	11.8171-0008.1 990049	Brake System: ATE	
→							

	kW				
VW - CADDY CALIFORNIA V Camper (SBB, SBJ) 09/20→					
 Brake Disc					
1.5 TSi EVO	84	01/21→	for PR number: 1ZK; Fitting Position: Front Axle	24.0325-0158.1	525158 Outer diameter [mm]: 312 Brake Disc Thickness [mm] 25 Minimum thickness [mm] 22 Brake Disc Type: Vented Supplementary Article/Info 2: with bolts/screws
1.6 SRE	81	02/21→			
2.0 TDi BMT	55 - 09/20→	90			
2.0 TDI BMT 4WD	90	03/21→			
			for PR number: 1KE; Fitting Position: Rear Axle	24.0110-0356.1	410356 Outer diameter [mm]: 272 Brake Disc Thickness [mm] 9.7 Minimum thickness [mm] 8 Brake Disc Type: Solid Supplementary Article/Info 2: with bolts/screws
				24.0310-0356.1	510356 Outer diameter [mm]: 272 Brake Disc Thickness [mm] 9.7 Minimum thickness [mm] 8 Brake Disc Type: Solid Supplementary Article/Info 2: with bolts/screws
			for PR number: 1KU; Fitting Position: Rear Axle	24.0112-0210.1	412210 Outer diameter [mm]: 300 Brake Disc Thickness [mm] 12 Minimum thickness [mm] 10 Brake Disc Type: Solid Supplementary Article/Info 2: with bolts/screws
 Wheel Speed Sensor					
1.5 TSi EVO	84	01/21→	→ Construction year to: 11/21; Fitting Position: Front Axle Left	24.0711-5273.3	360303
1.6 SRE	81	02/21→			
2.0 TDi BMT	55 - 09/20→	90	→ Construction year to: 11/21; Fitting Position: Front Axle Right	24.0711-5274.3	360304
			Construction year from: 03/21 →; for PR number: 1X1; Fitting Position: Rear Axle Right	24.0711-5401.3	360330
			Construction year from: 03/21 →; for PR number: 1X1; Fitting Position: Rear Axle Left	24.0711-5402.3	360331
			for PR number: 1X0; Required quantity: 2; Fitting Position: Rear Axle	2	24.0711-6337.3 360390
2.0 TDI BMT 4WD	90	03/21→	→ Construction year to: 11/21; Fitting Position: Front Axle Left	24.0711-5273.3	360303
			→ Construction year to: 11/21; Fitting Position: Front Axle Right	24.0711-5274.3	360304
			for PR number: 1X1; Fitting Position: Rear Axle Right	24.0711-5401.3	360330
			for PR number: 1X1; Fitting Position: Rear Axle Left	24.0711-5402.3	360331
			for PR number: 1X0; Required quantity: 2; Fitting Position: Rear Axle	2	24.0711-6337.3 360390
VW - CALIFORNIA T5 Camper (7EC, 7EF, 7EG, 7HF) 04/03→08/15					
Guide Bolt, brake caliper					
1.9 TDI	63 - 05/07→11/09	77	for PR number: 0WR; → Vehicle Identification Number to: 7H-8-027999; Required quantity: 2	2	11.8171-0008.1 990049 Brake System: ATE
2.5 TDi	120	05/07→11/09			
2.5 TDI	96 - 05/07→11/09	128			
2.5 TDI 4motion	96 - 05/07→11/09	128			
 Cable Pull, parking brake					
1.9 TDI	63 - 05/07→11/09	77	Vehicle Identification Number from: 7H-7-000001 →; for PR number: 0WR / 0E2; Required quantity: 2; Fitting Position: Rear	2	24.3727-3408.2 583408 Length [mm]: 1,936
2.0 TDI	62 - 09/09→08/15	132			
2.0 TDI 4motion	100 - 10/09→08/15	132			
2.5 TDi	120	05/07→11/09			
2.5 TDI	96 - 05/07→11/09	128			
2.5 TDI 4motion	96 - 05/07→11/09	128			

	kW				
VW - CC B7 (358) 11/11→12/16					
Guide Bolt, brake caliper					
1.4 TSI	110 - 11/11→12/16	for PR number: 1ZM / 1ZG; Required quantity: 2	2	11.8171-0008.1	990049 Brake System: ATE
1.4 TSI MultiFuel	118 11/11→12/16				
1.8 TSI	112 - 11/11→12/16				
2.0 TDI	100 - 11/11→12/16				
2.0 TDI 4motion	103 - 11/11→12/16				
2.0 TFSI	147 11/11→12/16				
2.0 TSI	155 11/11→12/16				
3.6 FSI 4motion	220 11/11→12/16				
 Brake Disc					
1.4 TSI	110 - 11/11→12/16	for PR number: 1ZM / 1ZG; Fitting Position: Front Axle		24.0125-0158.1	425158 Outer diameter [mm]: 312 Brake Disc Thickness [mm] 25 Minimum thickness [mm] 22 Brake Disc Type: Vented Supplementary Article/Info 2: with bolts/screws
1.4 TSI MultiFuel	118 11/11→12/16				
1.8 TSI	118 11/11→12/16				
2.0 TDI	103 - 11/11→12/16				
2.0 TDI 4motion	103 - 11/11→12/16			24.0325-0158.1	525158 Outer diameter [mm]: 312 Brake Disc Thickness [mm] 25 Minimum thickness [mm] 22 Brake Disc Type: Vented Supplementary Article/Info 2: with bolts/screws
2.0 TSI	155 11/11→12/16				
3.6 FSI 4motion	220 11/11→12/16				
1.8 TSI	112 11/11→12/16	for PR number: 1ZM / 1ZG; Fitting Position: Front Axle		24.0125-0158.1	425158 Outer diameter [mm]: 312 Brake Disc Thickness [mm] 25 Minimum thickness [mm] 22 Brake Disc Type: Vented Supplementary Article/Info 2: with bolts/screws
2.0 TDI	100 11/11→12/16				
2.0 TFSI	147 11/11→12/16				
 Wheel Speed Sensor					
2.0 TDI 4motion	103 - 11/11→12/16	Fitting Position: Rear Axle Left		24.0711-5401.3	360330
	130				
3.6 FSI 4motion	220 11/11→12/16	Fitting Position: Rear Axle Right		24.0711-5402.3	360331
VW - CRAFTER Bus (SYI, SYJ) 09/16→					
Warning Contact, brake pad wear					
2.0 TDI	75 - 09/16→	Required quantity: 1; for PR number: 1LA / 1LB / 1LC; Fitting Position: Front Axle	1	24.8190-0831.2	620831
2.0 TDI 4motion	103 - 03/17→				
	130				
2.0 TDI	130 09/16→	Required quantity: 1; Construction year from: 07/19 →; Fitting Position: Front Axle	1	24.8190-0831.2	620831
		Required quantity: 1; Construction year from: 07/19 →; Fitting Position: Rear Axle	1	24.8190-0831.2	620831
 Wheel Speed Sensor					
2.0 TDI	75 - 09/16→	Construction year from: 08/20 →; Fitting Position: Front Axle Left		24.0711-5401.3	360330
	130	Construction year from: 08/20 →; Fitting Position: Front Axle Right		24.0711-5402.3	360331
		Required quantity: 2; for PR number: 6K2 / 6K3 / 7X0 / 7X2; Fitting Position: Rear Axle	2	24.0711-6337.3	360390
2.0 TDI 4motion	103 - 03/17→	Construction year from: 08/20 →; Fitting Position: Front Axle Left		24.0711-5401.3	360330
	130	Construction year from: 08/20 →; Fitting Position: Front Axle Right		24.0711-5402.3	360331
		Fitting Position: Rear Axle Left		24.0711-5401.3	360330
		Fitting Position: Rear Axle Right		24.0711-5402.3	360331
VW - CRAFTER Platform/Chassis (SZ_) 11/16→					
Warning Contact, brake pad wear					
2.0 TDI	75 - 11/16→	Required quantity: 1; for PR number: 1LA / 1LB / 1LC;	1	24.8190-0831.2	620831
2.0 TDI 4motion	103 - 03/17→	Fitting Position: Front Axle			
	130				
2.0 TDI RWD	80 - 11/16→				
	130				
→					



	kW				
VW - CRAFTER Platform/Chassis (SZ_) 11/16→					
 Wheel Speed Sensor					
2.0 TDI	75 - 11/16→ 130	Construction year from: 08/20 →; Fitting Position: Front Axle Left		24.0711-5401.3	360330
		Construction year from: 08/20 →; Fitting Position: Front Axle Right		24.0711-5402.3	360331
		Required quantity: 2; for PR number: 6K2 / 6K3 / 7X0 / 7X2; Fitting Position: Rear Axle		2	24.0711-6337.3 360390
2.0 TDI 4motion	103 - 03/17→ 130	Construction year from: 08/20 →; Fitting Position: Front Axle Left		24.0711-5401.3	360330
		Construction year from: 08/20 →; Fitting Position: Front Axle Right		24.0711-5402.3	360331
		Fitting Position: Rear Axle Left		24.0711-5401.3	360330
		Fitting Position: Rear Axle Right		24.0711-5402.3	360331
2.0 TDI RWD	80 - 11/16→ 130	Construction year from: 08/20 →; Fitting Position: Front Axle Left		24.0711-5401.3	360330
		Construction year from: 08/20 →; Fitting Position: Front Axle Right		24.0711-5402.3	360331
		Required quantity: 2; Fitting Position: Rear Axle		2	24.0711-6337.3 360390
VW - CRAFTER Van (SY_, SX_) 09/16→					
Warning Contact, brake pad wear					
2.0 TDI	75 - 09/16→ 130	Required quantity: 1; for PR number: 1LA / 1LB / 1LC; Fitting Position: Front Axle		1	24.8190-0831.2 620831
2.0 TDI 4motion	103 - 03/17→ 130				
2.0 TDI RWD	80 - 05/17→ 130				
e-Crafter	100 07/18→	Required quantity: 1; Construction year from: 07/19 →; Fitting Position: Front Axle		1	24.8190-0831.2 620831
		Required quantity: 1; Construction year from: 07/19 →; Fitting Position: Rear Axle		1	24.8190-0831.2 620831
 Wheel Speed Sensor					
2.0 TDI	75 - 09/16→ 130	Construction year from: 08/20 →; Fitting Position: Front Axle Left		24.0711-5401.3	360330
		Construction year from: 08/20 →; Fitting Position: Front Axle Right		24.0711-5402.3	360331
		Required quantity: 2; for PR number: 6K2 / 6K3 / 7X0 / 7X2; Fitting Position: Rear Axle		2	24.0711-6337.3 360390
2.0 TDI 4motion	103 - 03/17→ 130	Construction year from: 08/20 →; Fitting Position: Front Axle Left		24.0711-5401.3	360330
		Construction year from: 08/20 →; Fitting Position: Front Axle Right		24.0711-5402.3	360331
		Fitting Position: Rear Axle Left		24.0711-5401.3	360330
		Fitting Position: Rear Axle Right		24.0711-5402.3	360331
2.0 TDI RWD	80 - 05/17→ 130	Construction year from: 08/20 →; Fitting Position: Front Axle Left		24.0711-5401.3	360330
		Construction year from: 08/20 →; Fitting Position: Front Axle Right		24.0711-5402.3	360331
		Required quantity: 2; Fitting Position: Rear Axle		2	24.0711-6337.3 360390
e-Crafter	100 07/18→	Construction year from: 08/20 →; Fitting Position: Front Axle Left		24.0711-5401.3	360330
		Construction year from: 08/20 →; Fitting Position: Front Axle Right		24.0711-5402.3	360331
		Required quantity: 2; Construction year from: 10/18 →; Fitting Position: Rear Axle		2	24.0711-6337.3 360390
VW - EOS (1F7, 1F8) 03/06→08/15					
Guide Bolt, brake caliper					
1.4 TSI	90 - 11/07→08/15 118	for PR number: 1ZE; Required quantity: 2		2	11.8171-0008.1 990049 Brake System: ATE
1.6 FSI	85 06/06→05/08	for PR number: 1LJ / 1ZA / 1ZD; Required quantity: 2		2	11.8171-0008.1 990049 Brake System: ATE
2.0 TDI	103 06/06→05/08				
2.0 TDI 16V	103 05/08→08/15				
2.0 TSI	155 11/09→08/15	for PR number: 1LK; Required quantity: 2		2	11.8171-0008.1 990049 Brake System: ATE
3.2 V6	184 06/06→05/09				
3.6 V6	191 05/09→11/10				
→					



	kW				
VW - EOS (1F7, 1F8) 03/06→08/15					
Guide Bolt, brake caliper					
2.0 FSI 2.0 TFSI	110 03/06→05/08 147 03/06→08/15	Construction year from: 05/06 →; for PR number: 1ZE; Required quantity: 2	2	11.8171-0008.1 990049	Brake System: ATE
		Construction year from: 05/06 →; for PR number: 1LJ / 1ZA / 1ZD; Required quantity: 2	2	11.8171-0008.1 990049	Brake System: ATE
		Construction year from: 05/06 →; for PR number: 1LK; Required quantity: 2	2	11.8171-0008.1 990049	Brake System: ATE
2.0 TDI	100 11/10→08/15	Required quantity: 2	2	11.8171-0008.1 990049	Brake System: ATE
		for PR number: 1ZE; Required quantity: 2	2	11.8171-0008.1 990049	Brake System: ATE
		for PR number: 1LJ / 1ZA / 1ZD; Required quantity: 2	2	11.8171-0008.1 990049	Brake System: ATE
 Brake Disc					
1.4 TSI 1.6 FSI 2.0 TDI	90 - 11/07→08/15 118 85 06/06→05/08 100 - 06/06→08/15 103	for PR number: 1ZE; Fitting Position: Front Axle		24.0125-0145.1 425145	Outer diameter [mm]: 288 Brake Disc Thickness [mm] 25 Minimum thickness [mm] 22 Brake Disc Type: Vented Supplementary Article/Info 2: with bolts/screws
2.0 TDI 16V 2.0 TSI 3.2 V6 3.6 V6	103 05/08→08/15 155 11/09→08/15 184 06/06→05/09 191 05/09→11/10	for PR number: 1LJ / 1ZA / 1ZD; Fitting Position: Front Axle		24.0125-0158.1 425158 24.0325-0158.1 525158	Outer diameter [mm]: 312 Brake Disc Thickness [mm] 25 Minimum thickness [mm] 22 Brake Disc Type: Vented Supplementary Article/Info 2: with bolts/screws Outer diameter [mm]: 312 Brake Disc Thickness [mm] 25 Minimum thickness [mm] 22 Brake Disc Type: Vented Supplementary Article/Info 2: with bolts/screws
		for PR number: 1KS; Fitting Position: Rear Axle		24.0110-0356.1 410356 24.0310-0356.1 510356	Outer diameter [mm]: 272 Brake Disc Thickness [mm] 9.7 Minimum thickness [mm] 8 Brake Disc Type: Solid Supplementary Article/Info 2: with bolts/screws Outer diameter [mm]: 272 Brake Disc Thickness [mm] 9.7 Minimum thickness [mm] 8 Brake Disc Type: Solid Supplementary Article/Info 2: with bolts/screws
2.0 FSI 2.0 TFSI	110 03/06→05/08 147 03/06→08/15	Construction year from: 05/06 →; for PR number: 1ZE; Fitting Position: Front Axle		24.0125-0145.1 425145	Outer diameter [mm]: 288 Brake Disc Thickness [mm] 25 Minimum thickness [mm] 22 Brake Disc Type: Vented Supplementary Article/Info 2: with bolts/screws
		Construction year from: 05/06 →; for PR number: 1LJ / 1ZA / 1ZD; Fitting Position: Front Axle		24.0125-0158.1 425158 24.0325-0158.1 525158	Outer diameter [mm]: 312 Brake Disc Thickness [mm] 25 Minimum thickness [mm] 22 Brake Disc Type: Vented Supplementary Article/Info 2: with bolts/screws Outer diameter [mm]: 312 Brake Disc Thickness [mm] 25 Minimum thickness [mm] 22 Brake Disc Type: Vented Supplementary Article/Info 2: with bolts/screws
		Construction year from: 05/06 →; for PR number: 1KS; Fitting Position: Rear Axle		24.0110-0356.1 410356 24.0310-0356.1 510356	Outer diameter [mm]: 272 Brake Disc Thickness [mm] 9.7 Minimum thickness [mm] 8 Brake Disc Type: Solid Supplementary Article/Info 2: with bolts/screws Outer diameter [mm]: 272 Brake Disc Thickness [mm] 9.7 Minimum thickness [mm] 8 Brake Disc Type: Solid Supplementary Article/Info 2: with bolts/screws



VW - FOX Hatchback (5Z1, 5Z3, 5Z4) 08/03→10/15							
 Wheel Speed Sensor							
1.2	40	04/05→07/11	Fitting Position: Front Axle Left			24.0711-5273.3	360303
1.4	55	04/05→12/09	Fitting Position: Front Axle Right			24.0711-5274.3	360304
1.4 TDI	51	04/05→12/09					
1.2	44	09/10→12/11	→ Construction year to: 08/11;			24.0711-5273.3	360303
1.6	74	10/03→08/14	Fitting Position: Front Axle Left				
1.6 Total Flex	74	10/03→08/14	→ Construction year to: 08/11;			24.0711-5274.3	360304
			Fitting Position: Front Axle Right				
VW - FOX Van (5Z1) 09/10→12/11							
 Wheel Speed Sensor							
1.2	44	09/10→12/11	→ Construction year to: 08/11;			24.0711-5273.3	360303
			Fitting Position: Front Axle Left				
			→ Construction year to: 08/11;			24.0711-5274.3	360304
			Fitting Position: Front Axle Right				
VW - GOLF III (1H1) 10/89→07/98							
Guide Bolt, brake caliper							
2.0	85	11/91→08/97	Construction year from: 05/96 →;	2	11.8171-0008.1	990049	Brake System: ATE
2.0 GTI 16V	110	08/92→08/97	Required quantity: 2;				
			Fitting Position: Front Axle				
2.8 VR6	120	08/95→09/97	Vehicle Identification Number from: 1H-S-400001 →;	2	11.8171-0008.1	990049	Brake System: ATE
			→ Construction year to: 08/97;				
			Required quantity: 2;				
			Fitting Position: Front Axle				
2.8 VR6	128	01/92→08/97	Vehicle Identification Number from: 1H-S-400001 →; Required quantity: 2;	2	11.8171-0008.1	990049	Brake System: ATE
			Fitting Position: Front Axle				
2.9 VR6 Syncro	140	10/94→08/97	Required quantity: 2;	2	11.8171-0008.1	990049	Brake System: ATE
			Fitting Position: Front Axle				
VW - GOLF III Variant (1H5) 07/93→04/99							
Guide Bolt, brake caliper							
2.9 VR6 Syncro	140	10/94→04/99	Construction year from: 07/95 →;	2	11.8171-0008.1	990049	Brake System: ATE
			Required quantity: 2;				
			Fitting Position: Front Axle				
VW - GOLF IV (1J1) 08/97→04/08							
Guide Bolt, brake caliper							
1.8 T	110	08/97→06/05	Vehicle Identification Number from: 1J-Y-115041 → → Vehicle Identification	2	11.8171-0008.1	990049	Brake System: ATE
2.3 V5	110	08/97→10/00	Number to: 1J-2-315308;				
			for PR number: 1LJ / 1ZQ;				
			Required quantity: 2				
			Vehicle Identification Number from:	2	11.8171-0008.1	990049	Brake System: ATE
			1J-2-315309 →;				
			for PR number: 1LJ / 1ZQ;				
			Required quantity: 2				
			Construction year from: 10/97 →;	2	11.8171-0008.1	990049	Brake System: ATE
			for PR number: 1LE / 1LN / 1ZE / 1ZH;				
			Required quantity: 2;				
			Fitting Position: Front Axle				
			Construction year from: 10/97 →;	2	11.8171-0008.1	990049	Brake System: ATE
			→ Vehicle Identification Number to: 1J-YB115040; for PR number: 1LJ / 1ZQ;				
			Required quantity: 2;				
			Fitting Position: Front Axle				
1.8 T GTI	132	08/01→06/05	→ Construction year to: 10/03;	2	11.8171-0008.1	990049	Brake System: ATE
			Required quantity: 2				
1.9 TDI	96	11/00→06/05	Construction year from: 04/01 → →	2	11.8171-0008.1	990049	Brake System: ATE
1.9 TDI 4motion	96	11/00→06/05	Construction year to: 10/03;				
			for PR number: 1LE / 1LN / 1ZE / 1ZH;				
			Required quantity: 2;				
			Fitting Position: Front Axle				
1.9 TDI	110	05/00→06/05	Construction year from: 09/00 → →	2	11.8171-0008.1	990049	Brake System: ATE
1.9 TDI 4motion	110	02/00→06/05	Construction year to: 10/03;				
			for PR number: 1LE / 1LN / 1ZE / 1ZH;				
			Required quantity: 2;				
			Fitting Position: Front Axle				
2.3 V5	125	10/00→06/05	Vehicle Identification Number from: 1J-Y-115041 → → Vehicle Identification	2	11.8171-0008.1	990049	Brake System: ATE
2.3 V5 4motion	125	10/00→06/05	Number to: 1J-2-315308;				
2.8 VR6 4motion	150	03/99→06/05	for PR number: 1LJ / 1ZQ;				
			Required quantity: 2				
			Vehicle Identification Number from:	2	11.8171-0008.1	990049	Brake System: ATE
			1J-2-315309 →;				
→							



	kW				
VW - GOLF IV (1J1) 08/97→04/08					
Guide Bolt, brake caliper					
2.3 V5	125	10/00→06/05	→ Construction year to: 10/03; for PR number: 1LJ / 1ZQ; Required quantity: 2		
2.3 V5 4motion	125	10/00→06/05			
2.8 VR6 4motion	150	03/99→06/05			
			→ Vehicle Identification Number to: 1J-YB115040; for PR number: 1LJ / 1ZQ; Required quantity: 2; Fitting Position: Front Axle	2	11.8171-0008.1 990049 Brake System: ATE
			→ Construction year to: 10/03; for PR number: 1LE / 1LN / 1ZE / 1ZH; Required quantity: 2; Fitting Position: Front Axle	2	11.8171-0008.1 990049 Brake System: ATE
2.3 V5 4motion	110	12/98→10/00	Vehicle Identification Number from: 1J-Y-115041 → → Vehicle Identification Number to: 1J-2-315308; for PR number: 1LJ / 1ZQ; Required quantity: 2	2	11.8171-0008.1 990049 Brake System: ATE
2.8 VR6	147	03/02→06/05			
			Vehicle Identification Number from: 1J-2-315309 →; for PR number: 1LJ / 1ZQ; Required quantity: 2	2	11.8171-0008.1 990049 Brake System: ATE
			→ Vehicle Identification Number to: 1J-YB115040; for PR number: 1LJ / 1ZQ; Required quantity: 2; Fitting Position: Front Axle	2	11.8171-0008.1 990049 Brake System: ATE
			for PR number: 1LE / 1LN / 1ZE / 1ZH; Required quantity: 2; Fitting Position: Front Axle	2	11.8171-0008.1 990049 Brake System: ATE
3.2 R32 4motion	177	09/02→06/05	→ Construction year to: 10/03; for PR number: 1ZT; Required quantity: 2	2	11.8171-0008.1 990049 Brake System: ATE
VW - GOLF IV (9B3) 03/06→					
Guide Bolt, brake caliper					
1.6	74	03/07→12/10	for PR number: 1ZE / 1ZP; Required quantity: 2	2	11.8171-0008.1 990049 Brake System: ATE
1.6 Total Flex	74 - 77	03/07→06/14			
1.8 GTI	132 - 142	01/07→12/10	for PR number: 1LJ / 1LL / 1LV / 1ZA / 1ZB / 1ZD; Required quantity: 2	2	11.8171-0008.1 990049 Brake System: ATE
2.0	85	01/07→12/10	for PR number: 1LM; Required quantity: 2	2	11.8171-0008.1 990049 Brake System: ATE
			for PR number: 1ZK; Required quantity: 2	2	11.8171-0008.1 990049 Brake System: ATE
Brake Disc					
1.6	74	03/07→12/10	for PR number: 1ZE / 1ZP; Fitting Position: Front Axle	24.0125-0145.1 425145	Outer diameter [mm]: 288 Brake Disc Thickness [mm] 25 Minimum thickness [mm] 22 Brake Disc Type: Vented Supplementary Article/Info 2: with bolts/screws
1.6 Total Flex	74 - 77	03/07→06/14			
1.8 GTI	132 - 142	01/07→12/10			
2.0	85	01/07→12/10			
			for PR number: 1LJ / 1LL / 1LV / 1ZA / 1ZB / 1ZD; Fitting Position: Front Axle	24.0125-0158.1 425158	Outer diameter [mm]: 312 Brake Disc Thickness [mm] 25 Minimum thickness [mm] 22 Brake Disc Type: Vented Supplementary Article/Info 2: with bolts/screws
			for PR number: 1KS / 1KT; Fitting Position: Rear Axle	24.0110-0356.1 410356	Outer diameter [mm]: 272 Brake Disc Thickness [mm] 9.7 Minimum thickness [mm] 8 Brake Disc Type: Solid Supplementary Article/Info 2: with bolts/screws
				24.0310-0356.1 510356	Outer diameter [mm]: 272 Brake Disc Thickness [mm] 9.7 Minimum thickness [mm] 8 Brake Disc Type: Solid Supplementary Article/Info 2: with bolts/screws
VW - GOLF IV Van (1J1) 10/97→05/04					
Guide Bolt, brake caliper					
1.9 TDI	96	04/01→05/04	→ Construction year to: 10/03; for PR number: 1LE / 1LN / 1ZE / 1ZH; Required quantity: 2; Fitting Position: Front Axle	2	11.8171-0008.1 990049 Brake System: ATE

	kW				
VW - GOLF IV Variant (1J5) 05/99→06/06					
Guide Bolt, brake caliper					
1.8 T	110 05/00→06/06	for PR number: 1ZD / 1ZE; Required quantity: 2; Fitting Position: Front Axle	2	11.8171-0008.1 990049	Brake System: ATE
1.9 TDI	110 06/01→06/06				
1.9 TDI 4motion	110 05/02→06/05				
2.3 V5	110 - 05/99→06/06				
2.3 V5 4motion	125 110 - 05/99→06/06				
1.9 TDI	96 11/00→06/06	Construction year from: 04/01 →; for PR number: 1ZD / 1ZE; Required quantity: 2; Fitting Position: Front Axle	2	11.8171-0008.1 990049	Brake System: ATE
1.9 TDI 4motion	96 11/00→06/06				
2.8 V6 4motion	150 05/99→06/06	Required quantity: 2; Fitting Position: Front Axle	2	11.8171-0008.1 990049	Brake System: ATE
VW - GOLF V (1K1) 10/03→07/10					
Guide Bolt, brake caliper					
1.4 16V	55 10/03→05/06	for PR number: 1ZE / 1ZP; Required quantity: 2	2	11.8171-0008.1 990049	Brake System: ATE
1.4 FSI	66 10/03→07/06				
1.6 FSI	85 10/03→07/08	for PR number: 1LJ / 1ZD; Required quantity: 2	2	11.8171-0008.1 990049	Brake System: ATE
		for PR number: 1LL / 1LV; Required quantity: 2	2	11.8171-0008.1 990049	Brake System: ATE
		for PR number: 1LK / 1LM; Required quantity: 2	2	11.8171-0008.1 990049	Brake System: ATE
1.4 16V	59 05/06→11/08	for PR number: 1ZE / 1ZP; → Construction year to: 09/08; Required quantity: 2	2	11.8171-0008.1 990049	Brake System: ATE
1.4 TSI	90 - 11/05→11/08 125				
1.6	75 01/04→11/08	for PR number: 1LJ / 1ZD; → Construction year to: 09/08; Required quantity: 2	2	11.8171-0008.1 990049	Brake System: ATE
1.6 MultiFuel	75 10/07→11/08				
1.9 TDI	66 - 10/03→11/08 77				
1.9 TDI 4motion	77 08/04→11/08	for PR number: 1LL / 1LV; → Construction year to: 09/08; Required quantity: 2	2	11.8171-0008.1 990049	Brake System: ATE
2.0	85 01/05→11/08				
2.0 FSI	110 01/04→11/08				
2.0 FSI 4motion	110 08/04→11/08	for PR number: 1LK / 1LM; → Construction year to: 09/08; Required quantity: 2	2	11.8171-0008.1 990049	Brake System: ATE
2.0 GTI	147 - 10/04→02/09 169				
2.0 SDI	55 01/04→11/08				
2.0 TDI	100 - 10/03→11/08 125				
2.0 TDI 16V	103 10/03→11/08				
2.0 TDI 16V 4motion	103 08/04→11/08				
2.0 TDI 4motion	103 01/07→11/08				
2.5	125 05/07→11/08				
3.2 R32 4motion	184 11/05→11/08				
 Brake Disc					
1.4 16V	55 10/03→05/06	for PR number: 1ZE / 1ZP; Fitting Position: Front Axle		24.0125-0145.1 425145	Outer diameter [mm]: 288 Brake Disc Thickness [mm] 25 Minimum thickness [mm] 22 Brake Disc Type: Vented Supplementary Article/Info 2: with bolts/screws
1.4 FSI	66 10/03→07/06				
1.6 FSI	85 10/03→07/08				
		for PR number: 1LJ / 1LL / 1LV / 1ZD; Fitting Position: Front Axle		24.0125-0158.1 425158	Outer diameter [mm]: 312 Brake Disc Thickness [mm] 25 Minimum thickness [mm] 22 Brake Disc Type: Vented Supplementary Article/Info 2: with bolts/screws
				24.0325-0158.1 525158	Outer diameter [mm]: 312 Brake Disc Thickness [mm] 25 Minimum thickness [mm] 22 Brake Disc Type: Vented Supplementary Article/Info 2: with bolts/screws
1.4 16V	59 05/06→11/08	for PR number: 1ZE / 1ZP; → Construction year to: 09/08; Fitting Position: Front Axle		24.0125-0145.1 425145	Outer diameter [mm]: 288 Brake Disc Thickness [mm] 25 Minimum thickness [mm] 22 Brake Disc Type: Vented Supplementary Article/Info 2: with bolts/screws
1.4 TSI	90 - 11/05→11/08 125				
1.6	75 01/04→11/08				
1.9 TDI	66 - 10/03→11/08 77				
1.9 TDI 4motion	77 08/04→11/08				
2.0 FSI	110 01/04→11/08	for PR number: 1LJ / 1LL / 1LV / 1ZD; → Construction year to: 09/08; Fitting Position: Front Axle		24.0125-0158.1 425158	Outer diameter [mm]: 312 Brake Disc Thickness [mm] 25 Minimum thickness [mm] 22 Brake Disc Type: Vented Supplementary Article/Info 2: with bolts/screws
2.0 FSI 4motion	110 08/04→11/08				
2.0 GTI	147 - 10/04→02/09 169				
2.0 SDI	55 01/04→11/08				
2.0 TDI	100 - 10/03→11/08 125				
2.0 TDI 16V	103 10/03→11/08				
→					

		kW					
VW - GOLF V (1K1) 10/03→07/10							
 Brake Disc							
2.0 TDI 16V 4motion 2.0 TDI 4motion 2.5 3.2 R32 4motion	103 08/04→11/08 103 01/07→11/08 125 05/07→11/08 184 11/05→11/08	for PR number: 1LJ / 1LL / 1LV / 1ZD; → Construction year to: 09/08; Fitting Position: Front Axle		24.0325-0158.1 525158	Outer diameter [mm]: 312 Brake Disc Thickness [mm] 25 Minimum thickness [mm] 22 Brake Disc Type: Vented Supplementary Article/Info 2: with bolts/screws		
1.6 MultiFuel 2.0	75 10/07→11/08 85 01/05→11/08	for PR number: 1ZE / 1ZP; → Construction year to: 09/08; Fitting Position: Front Axle		24.0125-0145.1 425145	Outer diameter [mm]: 288 Brake Disc Thickness [mm] 25 Minimum thickness [mm] 22 Brake Disc Type: Vented Supplementary Article/Info 2: with bolts/screws		
		for PR number: 1LJ / 1LL / 1LV / 1ZD; → Construction year to: 09/08; Fitting Position: Front Axle		24.0125-0158.1 425158	Outer diameter [mm]: 312 Brake Disc Thickness [mm] 25 Minimum thickness [mm] 22 Brake Disc Type: Vented Supplementary Article/Info 2: with bolts/screws		
VW - GOLF V Variant (1K5) 01/07→07/09							
Guide Bolt, brake caliper							
1.4 1.4 TSI 1.6 1.6 MultiFuel 1.9 TDI 1.9 TDI 4motion 2.0 TDI 2.0 TDI 16V 2.0 TFSI	59 06/07→07/09 90 - 06/07→07/09 125 75 06/07→07/09 75 11/07→07/09 77 06/07→07/09 77 01/08→07/09 96 - 06/07→07/09 103 103 06/07→07/09 147 06/07→07/09	→ Construction year to: 06/09; for PR number: 1ZE / 1ZP; Required quantity: 2		2 11.8171-0008.1 990049	Brake System: ATE		
		→ Construction year to: 06/09; for PR number: 1LJ / 1ZD; Required quantity: 2		2 11.8171-0008.1 990049	Brake System: ATE		
 Brake Disc							
1.4 1.4 TSI 1.6 1.6 MultiFuel 1.9 TDI 1.9 TDI 4motion 2.0 TDI 2.0 TDI 16V 2.0 TFSI	59 06/07→07/09 90 - 06/07→07/09 125 75 06/07→07/09 75 11/07→07/09 77 06/07→07/09 77 01/08→07/09 96 - 06/07→07/09 103 103 06/07→07/09 147 06/07→07/09	→ Construction year to: 06/09; for PR number: 1ZE / 1ZP; Fitting Position: Front Axle		24.0125-0145.1 425145	Outer diameter [mm]: 288 Brake Disc Thickness [mm] 25 Minimum thickness [mm] 22 Brake Disc Type: Vented Supplementary Article/Info 2: with bolts/screws		
		→ Construction year to: 06/09; for PR number: 1LJ / 1ZD; Fitting Position: Front Axle		24.0125-0158.1 425158	Outer diameter [mm]: 312 Brake Disc Thickness [mm] 25 Minimum thickness [mm] 22 Brake Disc Type: Vented Supplementary Article/Info 2: with bolts/screws		
				24.0325-0158.1 525158	Outer diameter [mm]: 312 Brake Disc Thickness [mm] 25 Minimum thickness [mm] 22 Brake Disc Type: Vented Supplementary Article/Info 2: with bolts/screws		
VW - GOLF VI (5K1) 10/08→12/14							
Guide Bolt, brake caliper							
1.2 TSI 1.4 1.4 TSI 1.6 1.6 BiFuel 1.6 MultiFuel 1.6 TDI 1.8 TSI 2.0 GTi 2.0 R 4motion 2.0 TDI 2.0 TDI 4motion 2.0 TFSI 4motion 2.5	63 05/10→11/12 59 10/08→11/12 90 - 10/08→11/12 118 75 10/08→11/12 75 03/09→11/12 75 10/08→11/12 66 - 02/09→11/12 77 118 06/09→01/11 147 - 04/09→11/13 173 188 - 11/09→11/13 199 81 - 10/08→05/13 125 103 05/09→11/12 191 09/11→11/13 125 07/09→05/13	for PR number: 1ZE / 1ZP; Required quantity: 2		2 11.8171-0008.1 990049	Brake System: ATE		
		for PR number: 1LJ / 1LL / 1LV / 1ZA / 1ZB / 1ZD; Required quantity: 2		2 11.8171-0008.1 990049	Brake System: ATE		
		for PR number: 1LM; Required quantity: 2		2 11.8171-0008.1 990049	Brake System: ATE		
		for PR number: 1ZK; Required quantity: 2		2 11.8171-0008.1 990049	Brake System: ATE		
1.2 TSI	77 11/08→11/12	Construction year from: 05/09 →; for PR number: 1ZE / 1ZP; Required quantity: 2		2 11.8171-0008.1 990049	Brake System: ATE		
→							

	kW				
VW - GOLF VI (5K1) 10/08→12/14					
 Brake Disc					
2.0 GTi 2.0 R 4motion 2.5	147 06/09→11/13 195 11/09→05/11 125 07/09→05/13	for PR number: 1LJ / 1LL / 1LV / 1ZA / 1ZB / 1ZD; Fitting Position: Front Axle		24.0125-0158.1 425158	Outer diameter [mm]: 312 Brake Disc Thickness [mm] 25 Minimum thickness [mm] 22 Brake Disc Type: Vented Supplementary Article/Info 2: with bolts/screws
		for PR number: 1KS / 1KT; Fitting Position: Rear Axle		24.0110-0356.1 410356	Outer diameter [mm]: 272 Brake Disc Thickness [mm] 9.7 Minimum thickness [mm] 8 Brake Disc Type: Solid Supplementary Article/Info 2: with bolts/screws
				24.0310-0356.1 510356	Outer diameter [mm]: 272 Brake Disc Thickness [mm] 9.7 Minimum thickness [mm] 8 Brake Disc Type: Solid Supplementary Article/Info 2: with bolts/screws
VW - GOLF VI Convertible (517) 03/11→05/16					
Guide Sleeve Kit, brake caliper					
1.2 TSI 1.4 TSI 1.6 TDI	77 03/11→05/16 118 03/11→05/16 77 03/11→05/16	Construction year from: 06/11 →; for PR number: 1ZK; Fitting Position: Front Axle		11.0101-5407.2 260011	Brake System: ATE
1.2 TSI 16V 1.4 TSI	77 11/13→05/16 90 - 11/11→05/16 110	for PR number: 1ZK; Fitting Position: Front Axle		11.0101-5407.2 260011	Brake System: ATE
2.0 GTI 2.0 R 2.0 TDI 2.0 TSI	155 05/12→05/16 195 01/13→05/16 81 - 11/11→05/16 110 162 11/13→05/16				
Guide Bolt, brake caliper					
1.2 TSI 1.4 TSI 1.6 TDI	77 03/11→05/16 118 03/11→05/16 77 03/11→05/16	Construction year from: 06/11 →; for PR number: 1ZE / 1ZP; Required quantity: 2	2	11.8171-0008.1 990049	Brake System: ATE
		Construction year from: 06/11 →; for PR number: 1ZA / 1ZD / 1ZB; Required quantity: 2	2	11.8171-0008.1 990049	Brake System: ATE
		Construction year from: 06/11 →; for PR number: 1ZK; Required quantity: 2	2	11.8171-0008.1 990049	Brake System: ATE
1.2 TSI 16V 1.4 TSI	77 11/13→05/16 90 - 11/11→05/16 110	for PR number: 1ZE / 1ZP; Required quantity: 2	2	11.8171-0008.1 990049	Brake System: ATE
2.0 GTI 2.0 R 2.0 TDI 2.0 TSI	155 05/12→05/16 195 01/13→05/16 81 - 11/11→05/16 110 162 11/13→05/16	for PR number: 1ZA / 1ZD / 1ZB; Required quantity: 2	2	11.8171-0008.1 990049	Brake System: ATE
		for PR number: 1ZK; Required quantity: 2	2	11.8171-0008.1 990049	Brake System: ATE
 Brake Disc					
1.2 TSI 1.4 TSI 1.6 TDI	77 03/11→05/16 118 03/11→05/16 77 03/11→05/16	Construction year from: 06/11 →; for PR number: 1ZE / 1ZP; Fitting Position: Front Axle		24.0125-0145.1 425145	Outer diameter [mm]: 288 Brake Disc Thickness [mm] 25 Minimum thickness [mm] 22 Brake Disc Type: Vented Supplementary Article/Info 2: with bolts/screws
		Construction year from: 06/11 →; for PR number: 1ZA / 1ZD / 1ZB; Fitting Position: Front Axle		24.0125-0158.1 425158	Outer diameter [mm]: 312 Brake Disc Thickness [mm] 25 Minimum thickness [mm] 22 Brake Disc Type: Vented Supplementary Article/Info 2: with bolts/screws
				24.0325-0158.1 525158	Outer diameter [mm]: 312 Brake Disc Thickness [mm] 25 Minimum thickness [mm] 22 Brake Disc Type: Vented Supplementary Article/Info 2: with bolts/screws
		Construction year from: 06/11 →; for PR number: 1KS / 1KT; Fitting Position: Rear Axle		24.0110-0356.1 410356	Outer diameter [mm]: 272 Brake Disc Thickness [mm] 9.7 Minimum thickness [mm] 8 Brake Disc Type: Solid Supplementary Article/Info 2: with bolts/screws

		kW					
VW - GOLF VI Convertible (517) 03/11→05/16							
 Brake Disc							
1.2 TSI 1.4 TSI 1.6 TDI	77 03/11→05/16 118 03/11→05/16 77 03/11→05/16	Construction year from: 06/11 →; for PR number: 1KS / 1KT; Fitting Position: Rear Axle		24.0310-0356.1 510356	Outer diameter [mm]: 272 Brake Disc Thickness [mm] 9.7 Minimum thickness [mm] 8 Brake Disc Type: Solid Supplementary Article/Info 2: with bolts/screws		
1.2 TSI 16V 1.4 TSI 2.0 GTI 2.0 R 2.0 TDI 2.0 TSI	77 11/13→05/16 90 - 11/11→05/16 110 155 05/12→05/16 195 01/13→05/16 81 - 11/11→05/16 110 162 11/13→05/16	for PR number: 1ZE / 1ZP; Fitting Position: Front Axle		24.0125-0145.1 425145	Outer diameter [mm]: 288 Brake Disc Thickness [mm] 25 Minimum thickness [mm] 22 Brake Disc Type: Vented Supplementary Article/Info 2: with bolts/screws		
		for PR number: 1ZA / 1ZD / 1ZB; Fitting Position: Front Axle		24.0125-0158.1 425158	Outer diameter [mm]: 312 Brake Disc Thickness [mm] 25 Minimum thickness [mm] 22 Brake Disc Type: Vented Supplementary Article/Info 2: with bolts/screws		
		for PR number: 1KS / 1KT; Fitting Position: Rear Axle		24.0110-0356.1 410356	Outer diameter [mm]: 272 Brake Disc Thickness [mm] 9.7 Minimum thickness [mm] 8 Brake Disc Type: Solid Supplementary Article/Info 2: with bolts/screws		
				24.0310-0356.1 510356	Outer diameter [mm]: 272 Brake Disc Thickness [mm] 9.7 Minimum thickness [mm] 8 Brake Disc Type: Solid Supplementary Article/Info 2: with bolts/screws		
VW - GOLF VI Van (5K1_) 10/08→11/12							
Guide Bolt, brake caliper							
1.2 TSi 1.2 TSi BlueMotion 1.4 TSi 1.6 TDi 1.6 TDi BlueMotion 2.0 GTi 2.0 TDi 2.0 TSi R 4motion TSi	63 05/10→11/12 77 05/09→11/12 118 10/08→11/12 66 02/09→11/12 77 05/09→11/12 155 02/09→11/12 103 - 09/09→11/12 125 199 11/09→11/12 90 10/08→11/12	for PR number: 1ZE / 1ZP; Required quantity: 2		2	11.8171-0008.1 990049	Brake System: ATE	
		for PR number: 1LJ / 1LL / 1LV / 1ZA / 1ZB / 1ZD; Required quantity: 2		2	11.8171-0008.1 990049	Brake System: ATE	
		for PR number: 1LM; Required quantity: 2		2	11.8171-0008.1 990049	Brake System: ATE	
		for PR number: 1ZK; Required quantity: 2		2	11.8171-0008.1 990049	Brake System: ATE	
 Brake Disc							
1.2 TSi 1.2 TSi BlueMotion 1.4 TSi 1.6 TDi 1.6 TDi BlueMotion 2.0 GTi 2.0 TDi 2.0 TSi R 4motion TSi	63 05/10→11/12 77 05/09→11/12 118 10/08→11/12 66 02/09→11/12 77 05/09→11/12 155 02/09→11/12 103 - 09/09→11/12 125 199 11/09→11/12 90 10/08→11/12	for PR number: 1ZE / 1ZP; Fitting Position: Front Axle		24.0125-0145.1 425145	Outer diameter [mm]: 288 Brake Disc Thickness [mm] 25 Minimum thickness [mm] 22 Brake Disc Type: Vented Supplementary Article/Info 2: with bolts/screws		
		for PR number: 1LJ / 1LL / 1LV / 1ZA / 1ZB / 1ZD; Fitting Position: Front Axle		24.0125-0158.1 425158	Outer diameter [mm]: 312 Brake Disc Thickness [mm] 25 Minimum thickness [mm] 22 Brake Disc Type: Vented Supplementary Article/Info 2: with bolts/screws		
		for PR number: 1KS / 1KT; Fitting Position: Rear Axle		24.0110-0356.1 410356	Outer diameter [mm]: 272 Brake Disc Thickness [mm] 9.7 Minimum thickness [mm] 8 Brake Disc Type: Solid Supplementary Article/Info 2: with bolts/screws		
				24.0310-0356.1 510356	Outer diameter [mm]: 272 Brake Disc Thickness [mm] 9.7 Minimum thickness [mm] 8 Brake Disc Type: Solid Supplementary Article/Info 2: with bolts/screws		

	kW				
VW - GOLF VI Variant (AJ5) 07/09→07/14					
Guide Bolt, brake caliper					
1.2 TSI	63 - 07/09→07/13 77	for PR number: 1LJ / 1ZA / 1ZD / 1ZE / 1ZP; Required quantity: 2	2	11.8171-0008.1 990049	Brake System: ATE
1.4	59 07/09→07/13				
1.4 TSI	90 - 07/09→07/13 118				
1.6	75 07/09→07/13				
1.6 BiFuel	75 07/09→12/10				
1.6 MultiFuel	75 07/10→07/13				
1.6 TDI	66 - 07/09→07/13 77				
1.6 TDI 4motion	77 07/09→07/13				
2.0 TDI	81 - 07/09→07/13 103				
2.0 TFSI	147 07/09→07/13				
 Brake Disc					
1.2 TSI	63 - 07/09→07/13 77	for PR number: 1ZE / 1ZP; Fitting Position: Front Axle		24.0125-0145.1 425145	Outer diameter [mm]: 288 Brake Disc Thickness [mm] 25 Minimum thickness [mm] 22 Brake Disc Type: Vented Supplementary Article/Info 2: with bolts/screws
1.4	59 07/09→07/13				
1.4 TSI	90 - 07/09→07/13 118				
1.6	75 07/09→07/13				
1.6 MultiFuel	75 07/10→07/13				
1.6 TDI	66 - 07/09→07/13 77	for PR number: 1LJ / 1ZA / 1ZD; Fitting Position: Front Axle		24.0125-0158.1 425158	Outer diameter [mm]: 312 Brake Disc Thickness [mm] 25 Minimum thickness [mm] 22 Brake Disc Type: Vented Supplementary Article/Info 2: with bolts/screws
1.6 TDI 4motion	77 07/09→07/13				
2.0 TDI	103 07/09→07/13				
				24.0325-0158.1 525158	Outer diameter [mm]: 312 Brake Disc Thickness [mm] 25 Minimum thickness [mm] 22 Brake Disc Type: Vented Supplementary Article/Info 2: with bolts/screws
		for PR number: 1KS; Fitting Position: Rear Axle		24.0110-0356.1 410356	Outer diameter [mm]: 272 Brake Disc Thickness [mm] 9.7 Minimum thickness [mm] 8 Brake Disc Type: Solid Supplementary Article/Info 2: with bolts/screws
				24.0310-0356.1 510356	Outer diameter [mm]: 272 Brake Disc Thickness [mm] 9.7 Minimum thickness [mm] 8 Brake Disc Type: Solid Supplementary Article/Info 2: with bolts/screws
1.6 BiFuel	75 07/09→12/10	for PR number: 1ZE / 1ZP; Fitting Position: Front Axle		24.0125-0145.1 425145	Outer diameter [mm]: 288 Brake Disc Thickness [mm] 25 Minimum thickness [mm] 22 Brake Disc Type: Vented Supplementary Article/Info 2: with bolts/screws
2.0 TDI	81 - 07/09→07/13 100				
2.0 TFSI	147 07/09→07/13				
		for PR number: 1LJ / 1ZA / 1ZD; Fitting Position: Front Axle		24.0125-0158.1 425158	Outer diameter [mm]: 312 Brake Disc Thickness [mm] 25 Minimum thickness [mm] 22 Brake Disc Type: Vented Supplementary Article/Info 2: with bolts/screws
		for PR number: 1KS; Fitting Position: Rear Axle		24.0110-0356.1 410356	Outer diameter [mm]: 272 Brake Disc Thickness [mm] 9.7 Minimum thickness [mm] 8 Brake Disc Type: Solid Supplementary Article/Info 2: with bolts/screws
				24.0310-0356.1 510356	Outer diameter [mm]: 272 Brake Disc Thickness [mm] 9.7 Minimum thickness [mm] 8 Brake Disc Type: Solid Supplementary Article/Info 2: with bolts/screws
VW - GOLF VII (5G1, BQ1, BE1, BE2) 08/12→					
 Brake Caliper					
1.0 TSI	63 - 05/15→ 85	for PR number: 1ZA / 1ZD; Fitting Position: Front Axle Left		24.3571-1801.5 241387	Supplementary Article/Supplementary Info: without holder Brake Caliper Type: Fist-type Caliper
1.2 TSI	77 - 11/12→ 81				
1.4 GTE Hybrid	110 05/14→				
→					

	kW				
VW - GOLF VII (5G1, BQ1, BE1, BE2) 08/12→					
 Brake Caliper					
1.4 TSI	92 - 05/14→ 110	for PR number: 1ZA / 1ZD; Fitting Position: Front Axle Right	24.3571-1802.5 241388	Supplementary Article/Supplementary Info: without holder Brake Caliper Type: Fist-type Caliper	
1.4 TSI MultiFuel	90 - 04/13→ 92				
1.5 TGI	96 11/18→				
1.5 TSI	96 - 04/17→ 110	for PR number: 1LJ; Fitting Position: Front Axle Left	24.3601-2607.5 241487	Brake System: TRW Supplementary Article/Supplementary Info: without holder Brake Caliper Type: Fist-type Caliper	
1.6	81 05/14→07/17				
1.6 TDI	66 - 04/13→08/20 85				
1.6 TDI 4motion	77 - 11/12→ 81	for PR number: 1LJ; Fitting Position: Front Axle Right	24.3601-2608.5 241488	Brake System: TRW Supplementary Article/Supplementary Info: without holder Brake Caliper Type: Fist-type Caliper	
2.0 GTD	135 04/13→				
2.0 GTI	155 - 04/13→ 180				
2.0 GTI Clubsport	195 02/16→03/17				
2.0 GTI Clubsport S	228 09/16→				
2.0 GTI TCR	213 11/18→				
2.0 R 360S 4motion	265 09/16→				
2.0 R 4motion	206 - 11/13→ 228				
2.0 TDI	81 - 08/12→ 110				
2.0 TDI 4motion	110 11/12→08/20				
1.2 TSI	63 08/12→03/17	Construction year from: 11/12 →; for PR number: 1ZA / 1ZD; Fitting Position: Front Axle Left	24.3571-1801.5 241387	Supplementary Article/Supplementary Info: without holder Brake Caliper Type: Fist-type Caliper	
1.4 TSI	103 08/12→03/17				
1.6 TDI	77 08/12→03/17				
		Construction year from: 11/12 →; for PR number: 1ZA / 1ZD; Fitting Position: Front Axle Right	24.3571-1802.5 241388	Supplementary Article/Supplementary Info: without holder Brake Caliper Type: Fist-type Caliper	
		for PR number: 1LJ; Fitting Position: Front Axle Left	24.3601-2607.5 241487	Brake System: TRW Supplementary Article/Supplementary Info: without holder Brake Caliper Type: Fist-type Caliper	
		for PR number: 1LJ; Fitting Position: Front Axle Right	24.3601-2608.5 241488	Brake System: TRW Supplementary Article/Supplementary Info: without holder Brake Caliper Type: Fist-type Caliper	
1.4 TGI CNG	81 06/13→	Construction year from: 08/13 →; for PR number: 1ZA / 1ZD; Fitting Position: Front Axle Left	24.3571-1801.5 241387	Supplementary Article/Supplementary Info: without holder Brake Caliper Type: Fist-type Caliper	
		Construction year from: 08/13 →; for PR number: 1ZA / 1ZD; Fitting Position: Front Axle Right	24.3571-1802.5 241388	Supplementary Article/Supplementary Info: without holder Brake Caliper Type: Fist-type Caliper	
		for PR number: 1LJ; Fitting Position: Front Axle Left	24.3601-2607.5 241487	Brake System: TRW Supplementary Article/Supplementary Info: without holder Brake Caliper Type: Fist-type Caliper	
		for PR number: 1LJ; Fitting Position: Front Axle Right	24.3601-2608.5 241488	Brake System: TRW Supplementary Article/Supplementary Info: without holder Brake Caliper Type: Fist-type Caliper	
1.4 TSI	90 11/12→	Construction year from: 06/13 →; for PR number: 1ZA / 1ZD; Fitting Position: Front Axle Left	24.3571-1801.5 241387	Supplementary Article/Supplementary Info: without holder Brake Caliper Type: Fist-type Caliper	
1.6 TDI	81 01/13→				
		Construction year from: 06/13 →; for PR number: 1ZA / 1ZD; Fitting Position: Front Axle Right	24.3571-1802.5 241388	Supplementary Article/Supplementary Info: without holder Brake Caliper Type: Fist-type Caliper	
		for PR number: 1LJ; Fitting Position: Front Axle Left	24.3601-2607.5 241487	Brake System: TRW Supplementary Article/Supplementary Info: without holder Brake Caliper Type: Fist-type Caliper	
		for PR number: 1LJ; Fitting Position: Front Axle Right	24.3601-2608.5 241488	Brake System: TRW Supplementary Article/Supplementary Info: without holder Brake Caliper Type: Fist-type Caliper	



→

		kW					
VW - GOLF VII (5G1, BQ1, BE1, BE2) 08/12→							
Guide Sleeve Kit, brake caliper							
1.0 TSI	63 - 05/15→ 85	for PR number: 1KE; Fitting Position: Rear Axle		11.0101-5407.2 260011	Brake System: ATE		
1.2 TSI	63 - 08/12→ 81						
1.4 GTE Hybrid	110 05/14→						
1.4 TGI CNG	81 06/13→						
1.4 TSI	90 - 08/12→ 110						
1.4 TSI MultiFuel	90 - 04/13→ 92						
1.5 TGI	96 11/18→						
1.5 TSI	96 - 04/17→ 110						
1.6	81 05/14→07/17						
1.6 TDI	66 - 08/12→ 85						
1.6 TDI 4motion	77 - 11/12→ 81						
1.8 TSI	125 07/13→						
2.0 GTD	135 04/13→						
2.0 GTI	155 - 04/13→ 180						
2.0 GTI Clubsport	195 02/16→03/17						
2.0 GTI Clubsport S	228 09/16→						
2.0 GTI TCR	213 11/18→						
2.0 R 360S 4motion	265 09/16→						
2.0 R 4motion	206 - 11/13→ 228						
2.0 TDI	81 - 08/12→ 110						
2.0 TDI 4motion e-Golf	110 11/12→08/20 85 - 03/14→ 100						
 Brake Disc							
1.0 TSI	63 - 05/15→ 85	for PR number: 1ZE / 1ZP; Fitting Position: Front Axle		24.0125-0145.1 425145	Outer diameter [mm]: 288 Brake Disc Thickness [mm] 25 Minimum thickness [mm] 22 Brake Disc Type: Vented Supplementary Article/Info 2: with bolts/screws		
1.2 TSI	77 - 11/12→ 81						
1.4 GTE Hybrid	110 05/14→						
1.4 TSI	92 - 05/14→ 110						
1.4 TSI MultiFuel	90 - 04/13→ 92	for PR number: 1ZA / 1ZB / 1ZD / 1LV / 1ZC / 1ZG; Fitting Position: Front Axle		24.0125-0158.1 425158	Outer diameter [mm]: 312 Brake Disc Thickness [mm] 25 Minimum thickness [mm] 22 Brake Disc Type: Vented Supplementary Article/Info 2: with bolts/screws		
1.5 TGI	96 11/18→						
1.5 TSI	96 - 04/17→ 110						
1.6 TDI	66 - 04/13→08/20 85			24.0325-0158.1 525158	Outer diameter [mm]: 312 Brake Disc Thickness [mm] 25 Minimum thickness [mm] 22 Brake Disc Type: Vented Supplementary Article/Info 2: with bolts/screws		
1.6 TDI 4motion	77 - 11/12→ 81						
2.0 GTD	135 04/13→						
2.0 GTI	162 - 04/13→ 180						
2.0 GTI Clubsport	195 02/16→03/17						
2.0 GTI Clubsport S	228 09/16→	for PR number: 1KE / 1KK; Vehicle Equipment: for vehicles with electric parking brake; Fitting Position: Rear Axle		24.0110-0356.1 410356	Outer diameter [mm]: 272 Brake Disc Thickness [mm] 9.7 Minimum thickness [mm] 8 Brake Disc Type: Solid Supplementary Article/Info 2: with bolts/screws		
2.0 GTI TCR	213 11/18→						
2.0 R 4motion	206 - 11/13→ 228						
2.0 TDI	110 08/12→			24.0310-0356.1 510356	Outer diameter [mm]: 272 Brake Disc Thickness [mm] 9.7 Minimum thickness [mm] 8 Brake Disc Type: Solid Supplementary Article/Info 2: with bolts/screws		
2.0 TDI 4motion	110 11/12→08/20						
		for PR number: 1KV; Vehicle Equipment: for vehicles with electric parking brake; Fitting Position: Rear Axle		24.0112-0210.1 412210	Outer diameter [mm]: 300 Brake Disc Thickness [mm] 12 Minimum thickness [mm] 10 Brake Disc Type: Solid Supplementary Article/Info 2: with bolts/screws		
1.2 TSI	63 08/12→03/17	Construction year from: 11/12 →;		24.0125-0145.1 425145	Outer diameter [mm]: 288 Brake Disc Thickness [mm] 25 Minimum thickness [mm] 22 Brake Disc Type: Vented Supplementary Article/Info 2: with bolts/screws		
1.4 TSI	103 08/12→03/17	for PR number: 1ZE / 1ZP;					
1.6 TDI	77 08/12→03/17	Fitting Position: Front Axle					
→							



		kW					
VW - GOLF VII (5G1, BQ1, BE1, BE2) 08/12→							
 Brake Disc							
1.2 TSI 1.4 TSI 1.6 TDI	63 08/12→03/17 103 08/12→03/17 77 08/12→03/17	Construction year from: 11/12 →; for PR number: 1ZA / 1ZB / 1ZD / 1LV / 1ZC / 1ZG; Fitting Position: Front Axle	24.0125-0158.1 425158	Outer diameter [mm]: 312 Brake Disc Thickness [mm] 25 Minimum thickness [mm] 22 Brake Disc Type: Vented Supplementary Article/Info 2: with bolts/screws			
			24.0325-0158.1 525158	Outer diameter [mm]: 312 Brake Disc Thickness [mm] 25 Minimum thickness [mm] 22 Brake Disc Type: Vented Supplementary Article/Info 2: with bolts/screws			
		Construction year from: 11/12 →; for PR number: 1KE / 1KK; Vehicle Equipment: for vehicles with electric parking brake; Fitting Position: Rear Axle	24.0110-0356.1 410356	Outer diameter [mm]: 272 Brake Disc Thickness [mm] 9.7 Minimum thickness [mm] 8 Brake Disc Type: Solid Supplementary Article/Info 2: with bolts/screws			
			24.0310-0356.1 510356	Outer diameter [mm]: 272 Brake Disc Thickness [mm] 9.7 Minimum thickness [mm] 8 Brake Disc Type: Solid Supplementary Article/Info 2: with bolts/screws			
		Construction year from: 11/12 →; for PR number: 1KV; Vehicle Equipment: for vehicles with electric parking brake; Fitting Position: Rear Axle	24.0112-0210.1 412210	Outer diameter [mm]: 300 Brake Disc Thickness [mm] 12 Minimum thickness [mm] 10 Brake Disc Type: Solid Supplementary Article/Info 2: with bolts/screws			
1.4 TGI CNG	81 06/13→	Construction year from: 08/13 →; for PR number: 1ZE / 1ZP; Fitting Position: Front Axle	24.0125-0145.1 425145	Outer diameter [mm]: 288 Brake Disc Thickness [mm] 25 Minimum thickness [mm] 22 Brake Disc Type: Vented Supplementary Article/Info 2: with bolts/screws			
		Construction year from: 08/13 →; for PR number: 1ZA / 1ZB / 1ZD / 1LV / 1ZC / 1ZG; Fitting Position: Front Axle	24.0125-0158.1 425158	Outer diameter [mm]: 312 Brake Disc Thickness [mm] 25 Minimum thickness [mm] 22 Brake Disc Type: Vented Supplementary Article/Info 2: with bolts/screws			
			24.0325-0158.1 525158	Outer diameter [mm]: 312 Brake Disc Thickness [mm] 25 Minimum thickness [mm] 22 Brake Disc Type: Vented Supplementary Article/Info 2: with bolts/screws			
		Construction year from: 08/13 →; for PR number: 1KE / 1KK; Vehicle Equipment: for vehicles with electric parking brake; Fitting Position: Rear Axle	24.0110-0356.1 410356	Outer diameter [mm]: 272 Brake Disc Thickness [mm] 9.7 Minimum thickness [mm] 8 Brake Disc Type: Solid Supplementary Article/Info 2: with bolts/screws			
			24.0310-0356.1 510356	Outer diameter [mm]: 272 Brake Disc Thickness [mm] 9.7 Minimum thickness [mm] 8 Brake Disc Type: Solid Supplementary Article/Info 2: with bolts/screws			
		Construction year from: 08/13 →; for PR number: 1KV; Vehicle Equipment: for vehicles with electric parking brake; Fitting Position: Rear Axle	24.0112-0210.1 412210	Outer diameter [mm]: 300 Brake Disc Thickness [mm] 12 Minimum thickness [mm] 10 Brake Disc Type: Solid Supplementary Article/Info 2: with bolts/screws			
1.4 TSI 1.6 TDI	90 11/12→ 81 01/13→	Construction year from: 06/13 →; for PR number: 1ZE / 1ZP; Fitting Position: Front Axle	24.0125-0145.1 425145	Outer diameter [mm]: 288 Brake Disc Thickness [mm] 25 Minimum thickness [mm] 22 Brake Disc Type: Vented Supplementary Article/Info 2: with bolts/screws			
		Construction year from: 06/13 →; for PR number: 1ZA / 1ZB / 1ZD / 1LV / 1ZC / 1ZG; Fitting Position: Front Axle	24.0125-0158.1 425158	Outer diameter [mm]: 312 Brake Disc Thickness [mm] 25 Minimum thickness [mm] 22 Brake Disc Type: Vented Supplementary Article/Info 2: with bolts/screws			



→



		kW					
VW - GOLF VII (5G1, BQ1, BE1, BE2) 08/12→							
 Brake Disc							
1.4 TSI 1.6 TDI	90 11/12→ 81 01/13→	Construction year from: 06/13 →; for PR number: 1ZA / 1ZB / 1ZD / 1LV / 1ZC / 1ZG; Fitting Position: Front Axle	24.0325-0158.1 525158	Outer diameter [mm]: 312 Brake Disc Thickness [mm] 25 Minimum thickness [mm] 22 Brake Disc Type: Vented Supplementary Article/Info 2: with bolts/screws			
		Construction year from: 06/13 →; for PR number: 1KE / 1KK; Vehicle Equipment: for vehicles with electric parking brake; Fitting Position: Rear Axle	24.0110-0356.1 410356	Outer diameter [mm]: 272 Brake Disc Thickness [mm] 9.7 Minimum thickness [mm] 8 Brake Disc Type: Solid Supplementary Article/Info 2: with bolts/screws			
			24.0310-0356.1 510356	Outer diameter [mm]: 272 Brake Disc Thickness [mm] 9.7 Minimum thickness [mm] 8 Brake Disc Type: Solid Supplementary Article/Info 2: with bolts/screws			
		Construction year from: 06/13 →; for PR number: 1KV; Vehicle Equipment: for vehicles with electric parking brake; Fitting Position: Rear Axle	24.0112-0210.1 412210	Outer diameter [mm]: 300 Brake Disc Thickness [mm] 12 Minimum thickness [mm] 10 Brake Disc Type: Solid Supplementary Article/Info 2: with bolts/screws			
1.6 2.0 GTI 2.0 R 360S 4motion 2.0 TDI	81 05/14→07/17 155 11/13→ 265 09/16→ 81 - 08/12→ 105	for PR number: 1ZE / 1ZP; Fitting Position: Front Axle	24.0125-0145.1 425145	Outer diameter [mm]: 288 Brake Disc Thickness [mm] 25 Minimum thickness [mm] 22 Brake Disc Type: Vented Supplementary Article/Info 2: with bolts/screws			
		for PR number: 1ZA / 1ZB / 1ZD / 1LV / 1ZC / 1ZG; Fitting Position: Front Axle	24.0125-0158.1 425158	Outer diameter [mm]: 312 Brake Disc Thickness [mm] 25 Minimum thickness [mm] 22 Brake Disc Type: Vented Supplementary Article/Info 2: with bolts/screws			
		for PR number: 1KE / 1KK; Vehicle Equipment: for vehicles with electric parking brake; Fitting Position: Rear Axle	24.0110-0356.1 410356	Outer diameter [mm]: 272 Brake Disc Thickness [mm] 9.7 Minimum thickness [mm] 8 Brake Disc Type: Solid Supplementary Article/Info 2: with bolts/screws			
			24.0310-0356.1 510356	Outer diameter [mm]: 272 Brake Disc Thickness [mm] 9.7 Minimum thickness [mm] 8 Brake Disc Type: Solid Supplementary Article/Info 2: with bolts/screws			
		for PR number: 1KV; Vehicle Equipment: for vehicles with electric parking brake; Fitting Position: Rear Axle	24.0112-0210.1 412210	Outer diameter [mm]: 300 Brake Disc Thickness [mm] 12 Minimum thickness [mm] 10 Brake Disc Type: Solid Supplementary Article/Info 2: with bolts/screws			
e-Golf	85 03/14→02/17	Construction year from: 08/14 →; for PR number: 1ZE / 1ZP; Fitting Position: Front Axle	24.0125-0145.1 425145	Outer diameter [mm]: 288 Brake Disc Thickness [mm] 25 Minimum thickness [mm] 22 Brake Disc Type: Vented Supplementary Article/Info 2: with bolts/screws			
		Construction year from: 08/14 →; for PR number: 1KE / 1KR; Vehicle Equipment: for vehicles with electric parking brake; Fitting Position: Rear Axle	24.0110-0356.1 410356	Outer diameter [mm]: 272 Brake Disc Thickness [mm] 9.7 Minimum thickness [mm] 8 Brake Disc Type: Solid Supplementary Article/Info 2: with bolts/screws			
			24.0310-0356.1 510356	Outer diameter [mm]: 272 Brake Disc Thickness [mm] 9.7 Minimum thickness [mm] 8 Brake Disc Type: Solid Supplementary Article/Info 2: with bolts/screws			
e-Golf	100 12/16→	for PR number: 1ZE / 1ZP; Fitting Position: Front Axle	24.0125-0145.1 425145	Outer diameter [mm]: 288 Brake Disc Thickness [mm] 25 Minimum thickness [mm] 22 Brake Disc Type: Vented Supplementary Article/Info 2: with bolts/screws			
→							

		kW					
VW - GOLF VII (5G1, BQ1, BE1, BE2) 08/12→							
 Brake Disc							
e-Golf	100 12/16→	for PR number: 1KE / 1KR; Vehicle Equipment: for vehicles with electric parking brake; Fitting Position: Rear Axle		24.0110-0356.1 410356	Outer diameter [mm]: 272 Brake Disc Thickness [mm] 9.7 Minimum thickness [mm] 8 Brake Disc Type: Solid Supplementary Article/Info 2: with bolts/screws		
				24.0310-0356.1 510356	Outer diameter [mm]: 272 Brake Disc Thickness [mm] 9.7 Minimum thickness [mm] 8 Brake Disc Type: Solid Supplementary Article/Info 2: with bolts/screws		
 Wheel Speed Sensor							
1.0 TSI	63 - 05/15→ 85	Fitting Position: Front Axle Left		24.0711-5273.3 360303			
1.2 TSI	77 - 11/12→ 81	Fitting Position: Front Axle Right		24.0711-5274.3 360304			
1.4 GTE Hybrid	110 05/14→	Required quantity: 2; Comfort Equipment Variant (trim package): for cruise control system; Fitting Position: Rear Axle		2 24.0711-6337.3 360390			
1.4 TSI	92 - 05/14→ 110						
1.4 TSI MultiFuel	90 - 04/13→ 92	Required quantity: 2; Vehicle Equipment: for vehicles with parking assistant system; Fitting Position: Rear Axle		2 24.0711-6337.3 360390			
1.5 TGI	96 11/18→						
1.5 TSI	96 - 04/17→ 110						
1.6	81 05/14→07/17						
1.6 TDI	66 - 04/13→08/20 85						
2.0 GTD	135 04/13→						
2.0 GTI	155 - 04/13→ 180						
2.0 GTI Clubsport	195 02/16→03/17						
2.0 GTI Clubsport S	228 09/16→						
2.0 GTI TCR	213 11/18→						
2.0 TDI	81 - 08/12→ 110						
e-Golf	100 12/16→						
1.2 TSI	63 08/12→03/17	Construction year from: 11/12 →; Fitting Position: Front Axle Left		24.0711-5273.3 360303			
1.4 TSI	103 08/12→03/17						
1.6 TDI	77 08/12→03/17	Construction year from: 11/12 →; Fitting Position: Front Axle Right		24.0711-5274.3 360304			
		Construction year from: 11/12 →; Required quantity: 2; Comfort Equipment Variant (trim package): for cruise control system; Fitting Position: Rear Axle		2 24.0711-6337.3 360390			
		Construction year from: 11/12 →; Required quantity: 2; Vehicle Equipment: for vehicles with parking assistant system; Fitting Position: Rear Axle		2 24.0711-6337.3 360390			
1.4 TGI CNG	81 06/13→	Construction year from: 08/13 →; Fitting Position: Front Axle Left		24.0711-5273.3 360303			
		Construction year from: 08/13 →; Fitting Position: Front Axle Right		24.0711-5274.3 360304			
		Construction year from: 08/13 →; Required quantity: 2; Comfort Equipment Variant (trim package): for cruise control system; Fitting Position: Rear Axle		2 24.0711-6337.3 360390			
		Construction year from: 08/13 →; Required quantity: 2; Vehicle Equipment: for vehicles with parking assistant system; Fitting Position: Rear Axle		2 24.0711-6337.3 360390			
1.4 TSI	90 11/12→	Construction year from: 06/13 →; Fitting Position: Front Axle Left		24.0711-5273.3 360303			
1.6 TDI	81 01/13→	Construction year from: 06/13 →; Fitting Position: Front Axle Right		24.0711-5274.3 360304			
		Construction year from: 06/13 →; Required quantity: 2; Comfort Equipment Variant (trim package): for cruise control system; Fitting Position: Rear Axle		2 24.0711-6337.3 360390			
		Construction year from: 06/13 →; Required quantity: 2; Vehicle Equipment: for vehicles with parking assistant system; Fitting Position: Rear Axle		2 24.0711-6337.3 360390			
→							

	kW				
VW - GOLF VII (5G1, BQ1, BE1, BE2) 08/12→					
 Wheel Speed Sensor					
1.6 TDI 4motion	77 - 11/12→ 81		Fitting Position: Front Axle Left	24.0711-5273.3	360303
2.0 R 360S 4motion	265 09/16→		Fitting Position: Front Axle Right	24.0711-5274.3	360304
2.0 R 4motion	206 - 11/13→ 228		Vehicle Equipment: for vehicles with parking assistant system; Fitting Position: Rear Axle Left	24.0711-5401.3	360330
2.0 TDI 4motion	110 11/12→08/20		Comfort Equipment Variant (trim package): for cruise control system; Fitting Position: Rear Axle Left	24.0711-5401.3	360330
			Comfort Equipment Variant (trim package): for cruise control system; Fitting Position: Rear Axle Right	24.0711-5402.3	360331
			Vehicle Equipment: for vehicles with parking assistant system; Fitting Position: Rear Axle Right	24.0711-5402.3	360331
e-Golf	85 03/14→02/17		Construction year from: 08/14 →; Fitting Position: Front Axle Left	24.0711-5273.3	360303
			Construction year from: 08/14 →; Fitting Position: Front Axle Right	24.0711-5274.3	360304
			Construction year from: 08/14 →; Required quantity: 2; Comfort Equipment Variant (trim package): for cruise control system; Fitting Position: Rear Axle	2 24.0711-6337.3	360390
			Construction year from: 08/14 →; Required quantity: 2; Vehicle Equipment: for vehicles with parking assistant system; Fitting Position: Rear Axle	2 24.0711-6337.3	360390
Control Element, parking brake caliper					
1.0 TSI	63 - 05/15→ 85		for PR number: 1KE; Fitting Position: Rear Axle Left	11.9282-1001.3	250159 Brake System: ATE
1.2 TSI	77 - 11/12→ 81		for PR number: 1KE; Fitting Position: Rear Axle Right	11.9282-1002.3	250160 Brake System: ATE
1.4 GTE Hybrid	110 05/14→				
1.4 TSI	92 - 05/14→ 110				
1.4 TSI MultiFuel	90 - 04/13→ 92				
1.5 TGI	96 11/18→				
1.5 TSI	96 - 04/17→ 110				
1.6	81 05/14→07/17				
1.6 TDI	66 - 04/13→08/20 85				
1.6 TDI 4motion	77 - 11/12→ 81				
2.0 GTD	135 04/13→				
2.0 GTI	155 - 04/13→ 180				
2.0 GTI Clubsport	195 02/16→03/17				
2.0 GTI Clubsport S	228 09/16→				
2.0 GTI TCR	213 11/18→				
2.0 R 360S 4motion	265 09/16→				
2.0 R 4motion	206 - 11/13→ 228				
2.0 TDI	81 - 08/12→ 110				
2.0 TDI 4motion	110 11/12→08/20				
1.2 TSI	63 08/12→03/17		Construction year from: 11/12 →; for PR number: 1KE;	11.9282-1001.3	250159 Brake System: ATE
1.4 TSI	103 08/12→03/17		Fitting Position: Rear Axle Left		
1.6 TDI	77 08/12→03/17		Construction year from: 11/12 →; for PR number: 1KE; Fitting Position: Rear Axle Right	11.9282-1002.3	250160 Brake System: ATE
1.4 TGI CNG	81 06/13→		Construction year from: 08/13 →; for PR number: 1KE; Fitting Position: Rear Axle Left	11.9282-1001.3	250159 Brake System: ATE
			Construction year from: 08/13 →; for PR number: 1KE; Fitting Position: Rear Axle Right	11.9282-1002.3	250160 Brake System: ATE
1.4 TSI	90 11/12→		Construction year from: 06/13 →; for PR number: 1KE;	11.9282-1001.3	250159 Brake System: ATE
1.6 TDI	81 01/13→		Fitting Position: Rear Axle Left		
			Construction year from: 06/13 →; for PR number: 1KE; Fitting Position: Rear Axle Right	11.9282-1002.3	250160 Brake System: ATE
→					



	kW				
VW - GOLF VII (5G1, BQ1, BE1, BE2) 08/12→					
Control Element, parking brake caliper					
e-Golf	85 03/14→02/17	Construction year from: 08/14 →; for PR number: 1KE / 1KR; Fitting Position: Rear Axle Left	11.9282-1001.3 250159	Brake System: ATE	
		Construction year from: 08/14 →; for PR number: 1KE / 1KR; Fitting Position: Rear Axle Right	11.9282-1002.3 250160	Brake System: ATE	
e-Golf	100 12/16→	for PR number: 1KE / 1KR; Fitting Position: Rear Axle Left	11.9282-1001.3 250159	Brake System: ATE	
		for PR number: 1KE / 1KR; Fitting Position: Rear Axle Right	11.9282-1002.3 250160	Brake System: ATE	
VW - GOLF VII Van (5G1) 08/12→					
 Brake Caliper					
1.2 TSi BlueMotion 1.4 TSi BlueMotion 1.6 TDi BlueMotion	63 08/12→ 103 08/12→ 77 08/12→	Construction year from: 11/12 →; for PR number: 1ZA / 1ZD; Fitting Position: Front Axle Left	24.3571-1801.5 241387	Supplementary Article/Supplementary Info: without holder Brake Caliper Type: Fist-type Caliper	
		Construction year from: 11/12 →; for PR number: 1ZA / 1ZD; Fitting Position: Front Axle Right	24.3571-1802.5 241388	Supplementary Article/Supplementary Info: without holder Brake Caliper Type: Fist-type Caliper	
		for PR number: 1LJ; Fitting Position: Front Axle Left	24.3601-2607.5 241487	Brake System: TRW Supplementary Article/Supplementary Info: without holder Brake Caliper Type: Fist-type Caliper	
		for PR number: 1LJ; Fitting Position: Front Axle Right	24.3601-2608.5 241488	Brake System: TRW Supplementary Article/Supplementary Info: without holder Brake Caliper Type: Fist-type Caliper	
1.2 TSi BlueMotion 1.4 TSi BlueMotion 1.6 TDi BlueMotion 2.0 GTD 2.0 GTI 2.0 TDi BlueMotion 2.0 TDi BlueMotion 4motion	77 11/12→ 90 05/13→ 66 - 04/13→ 81 135 04/13→ 162 - 04/13→ 169 110 05/13→ 110 05/13→	for PR number: 1ZA / 1ZD; Fitting Position: Front Axle Left	24.3571-1801.5 241387	Supplementary Article/Supplementary Info: without holder Brake Caliper Type: Fist-type Caliper	
		for PR number: 1ZA / 1ZD; Fitting Position: Front Axle Right	24.3571-1802.5 241388	Supplementary Article/Supplementary Info: without holder Brake Caliper Type: Fist-type Caliper	
		for PR number: 1LJ; Fitting Position: Front Axle Left	24.3601-2607.5 241487	Brake System: TRW Supplementary Article/Supplementary Info: without holder Brake Caliper Type: Fist-type Caliper	
		for PR number: 1LJ; Fitting Position: Front Axle Right	24.3601-2608.5 241488	Brake System: TRW Supplementary Article/Supplementary Info: without holder Brake Caliper Type: Fist-type Caliper	
		for PR number: 1LJ; Fitting Position: Front Axle Right	24.3601-2608.5 241488	Brake System: TRW Supplementary Article/Supplementary Info: without holder Brake Caliper Type: Fist-type Caliper	
 Brake Disc					
1.2 TSi BlueMotion 1.4 TSi BlueMotion 1.6 TDi BlueMotion	63 08/12→ 103 08/12→ 77 08/12→	Construction year from: 11/12 →; for PR number: 1ZE / 1ZP; Fitting Position: Front Axle	24.0125-0145.1 425145	Outer diameter [mm]: 288 Brake Disc Thickness [mm] 25 Minimum thickness [mm] 22 Brake Disc Type: Vented Supplementary Article/Info 2: with bolts/screws	
		Construction year from: 11/12 →; for PR number: 1ZA / 1ZB / 1ZD / 1LV / 1ZC / 1ZG; Fitting Position: Front Axle	24.0125-0158.1 425158	Outer diameter [mm]: 312 Brake Disc Thickness [mm] 25 Minimum thickness [mm] 22 Brake Disc Type: Vented Supplementary Article/Info 2: with bolts/screws	
		Construction year from: 11/12 →; for PR number: 1KE / 1KK; Vehicle Equipment: for vehicles with electric parking brake; Fitting Position: Rear Axle	24.0110-0356.1 410356	Outer diameter [mm]: 272 Brake Disc Thickness [mm] 9.7 Minimum thickness [mm] 8 Brake Disc Type: Solid Supplementary Article/Info 2: with bolts/screws	
			24.0310-0356.1 510356	Outer diameter [mm]: 272 Brake Disc Thickness [mm] 9.7 Minimum thickness [mm] 8 Brake Disc Type: Solid Supplementary Article/Info 2: with bolts/screws	
→					

	kW				
VW - GOLF VII Van (5G1) 08/12→					
 Brake Disc					
1.2 TSi BlueMotion 1.4 TSi BlueMotion 1.6 TDi BlueMotion	63 08/12→ 103 08/12→ 77 08/12→	Construction year from: 11/12 →; for PR number: 1KV; Vehicle Equipment: for vehicles with electric parking brake; Fitting Position: Rear Axle		24.0112-0210.1 412210	Outer diameter [mm]: 300 Brake Disc Thickness [mm] 12 Minimum thickness [mm] 10 Brake Disc Type: Solid Supplementary Article/Info 2: with bolts/screws
1.2 TSi BlueMotion 1.4 TSi BlueMotion 1.6 TDi BlueMotion	77 11/12→ 90 05/13→ 66 - 04/13→ 81	for PR number: 1ZE / 1ZP; Fitting Position: Front Axle		24.0125-0145.1 425145	Outer diameter [mm]: 288 Brake Disc Thickness [mm] 25 Minimum thickness [mm] 22 Brake Disc Type: Vented Supplementary Article/Info 2: with bolts/screws
2.0 GTD 2.0 GTi	135 04/13→ 162 - 04/13→ 169	for PR number: 1ZA / 1ZB / 1ZD / 1LV / 1ZC / 1ZG; Fitting Position: Front Axle		24.0125-0158.1 425158	Outer diameter [mm]: 312 Brake Disc Thickness [mm] 25 Minimum thickness [mm] 22 Brake Disc Type: Vented Supplementary Article/Info 2: with bolts/screws
2.0 TDi BlueMotion 2.0 TDi BlueMotion 4motion	110 05/13→ 110 05/13→	for PR number: 1KE / 1KK; Vehicle Equipment: for vehicles with electric parking brake; Fitting Position: Rear Axle		24.0110-0356.1 410356 24.0310-0356.1 510356	Outer diameter [mm]: 272 Brake Disc Thickness [mm] 9.7 Minimum thickness [mm] 8 Brake Disc Type: Solid Supplementary Article/Info 2: with bolts/screws Outer diameter [mm]: 272 Brake Disc Thickness [mm] 9.7 Minimum thickness [mm] 8 Brake Disc Type: Solid Supplementary Article/Info 2: with bolts/screws
		for PR number: 1KV; Vehicle Equipment: for vehicles with electric parking brake; Fitting Position: Rear Axle		24.0112-0210.1 412210	Outer diameter [mm]: 300 Brake Disc Thickness [mm] 12 Minimum thickness [mm] 10 Brake Disc Type: Solid Supplementary Article/Info 2: with bolts/screws
 Wheel Speed Sensor					
1.2 TSi BlueMotion 1.4 TSi BlueMotion 1.6 TDi BlueMotion	63 08/12→ 103 08/12→ 77 08/12→	Construction year from: 11/12 →; Fitting Position: Front Axle Left		24.0711-5273.3 360303	
		Construction year from: 11/12 →; Fitting Position: Front Axle Right		24.0711-5274.3 360304	
		Construction year from: 11/12 →; Required quantity: 2; Comfort Equipment Variant (trim package): for cruise control system; Fitting Position: Rear Axle	2	24.0711-6337.3 360390	
		Construction year from: 11/12 →; Required quantity: 2; Vehicle Equipment: for vehicles with parking assistant system; Fitting Position: Rear Axle	2	24.0711-6337.3 360390	
1.2 TSi BlueMotion 1.4 TSi BlueMotion 1.6 TDi BlueMotion	77 11/12→ 90 05/13→ 66 - 04/13→ 81	Fitting Position: Front Axle Left		24.0711-5273.3 360303	
		Fitting Position: Front Axle Right		24.0711-5274.3 360304	
2.0 GTD 2.0 GTi	135 04/13→ 162 - 04/13→ 169	Required quantity: 2; Comfort Equipment Variant (trim package): for cruise control system; Fitting Position: Rear Axle	2	24.0711-6337.3 360390	
2.0 TDi BlueMotion	110 05/13→	Required quantity: 2; Vehicle Equipment: for vehicles with parking assistant system; Fitting Position: Rear Axle	2	24.0711-6337.3 360390	
2.0 TDi BlueMotion 4motion	110 05/13→	Fitting Position: Front Axle Left		24.0711-5273.3 360303	
		Fitting Position: Front Axle Right		24.0711-5274.3 360304	
		Vehicle Equipment: for vehicles with parking assistant system; Fitting Position: Rear Axle Left		24.0711-5401.3 360330	
		Comfort Equipment Variant (trim package): for cruise control system; Fitting Position: Rear Axle Left		24.0711-5401.3 360330	
		Comfort Equipment Variant (trim package): for cruise control system; Fitting Position: Rear Axle Right		24.0711-5402.3 360331	
		Vehicle Equipment: for vehicles with parking assistant system; Fitting Position: Rear Axle Right		24.0711-5402.3 360331	



	kW				
VW - GOLF VII Van (5G1) 08/12→					
Control Element, parking brake caliper					
1.2 TSi BlueMotion 1.4 TSi BlueMotion 1.6 TDi BlueMotion	63 08/12→ 103 08/12→ 77 08/12→	Construction year from: 11/12 →; for PR number: 1KE; Fitting Position: Rear Axle Left	11.9282-1001.3 250159	Brake System: ATE	
		Construction year from: 11/12 →; for PR number: 1KE; Fitting Position: Rear Axle Right	11.9282-1002.3 250160	Brake System: ATE	
1.2 TSi BlueMotion 1.4 TSi BlueMotion 1.6 TDi BlueMotion	77 11/12→ 90 05/13→ 66 - 04/13→	for PR number: 1KE; Fitting Position: Rear Axle Left	11.9282-1001.3 250159	Brake System: ATE	
2.0 GTD 2.0 GTi	81 135 04/13→ 162 - 04/13→ 169	for PR number: 1KE; Fitting Position: Rear Axle Right	11.9282-1002.3 250160	Brake System: ATE	
2.0 TDi BlueMotion 2.0 TDi BlueMotion 4motion	110 05/13→ 110 05/13→				
VW - GOLF VII Variant (BA5, BV5) 04/13→					
 Brake Caliper					
1.0 TSI 1.2 TSI 1.4 TGI CNG 1.4 TSI	63 - 05/15→ 85 81 04/14→ 81 09/13→ 92 - 05/14→ 110	for PR number: 1ZA / 1ZD; Fitting Position: Front Axle Left	24.3571-1801.5 241387	Supplementary Article/Supplementary Info: without holder Brake Caliper Type: Fist-type Caliper	
1.4 TSI MultiFuel 1.5 TSI	90 - 04/13→03/17 92 96 - 04/17→ 110	for PR number: 1ZA / 1ZD; Fitting Position: Front Axle Right	24.3571-1802.5 241388	Supplementary Article/Supplementary Info: without holder Brake Caliper Type: Fist-type Caliper	
1.6 1.6 TDI 1.8 TSI 4motion 2.0 GTD 2.0 R 360S 4motion 2.0 R 4motion	81 05/14→03/17 85 11/16→ 132 11/16→ 135 01/15→03/17 265 09/16→ 206 - 03/15→ 228				
1.2 TSI 1.4 TSI 1.6 TDI	63 - 05/13→ 77 90 - 05/13→ 103 66 - 05/13→03/17 81	Construction year from: 07/13 →; for PR number: 1ZA / 1ZD; Fitting Position: Front Axle Left	24.3571-1801.5 241387	Supplementary Article/Supplementary Info: without holder Brake Caliper Type: Fist-type Caliper	
1.6 TDI 4motion 2.0 TDI	77 - 05/13→03/17 81 81 - 04/13→ 110	Construction year from: 07/13 →; for PR number: 1ZA / 1ZD; Fitting Position: Front Axle Right	24.3571-1802.5 241388	Supplementary Article/Supplementary Info: without holder Brake Caliper Type: Fist-type Caliper	
2.0 TDI 4motion	110 04/13→05/18				
1.5 TGI	96 12/18→	for PR number: 1ZA / 1ZD; Fitting Position: Front Axle Left	24.3571-1801.5 241387	Supplementary Article/Supplementary Info: without holder Brake Caliper Type: Fist-type Caliper	
		for PR number: 1ZA / 1ZD; Fitting Position: Front Axle Right	24.3571-1802.5 241388	Supplementary Article/Supplementary Info: without holder Brake Caliper Type: Fist-type Caliper	
		for PR number: 1LJ; Fitting Position: Front Axle Left	24.3601-2607.5 241487	Brake System: TRW Supplementary Article/Supplementary Info: without holder Brake Caliper Type: Fist-type Caliper	
		for PR number: 1LJ; Fitting Position: Front Axle Right	24.3601-2608.5 241488	Brake System: TRW Supplementary Article/Supplementary Info: without holder Brake Caliper Type: Fist-type Caliper	
 Brake Disc					
1.0 TSI 1.2 TSI 1.4 TGI CNG 1.4 TSI	63 - 05/15→ 85 81 04/14→ 81 09/13→ 92 - 05/14→ 110	for PR number: 1ZE / 1ZP; Fitting Position: Front Axle	24.0125-0145.1 425145	Outer diameter [mm]: 288 Brake Disc Thickness [mm] 25 Minimum thickness [mm] 22 Brake Disc Type: Vented Supplementary Article/Info 2: with bolts/screws	
1.4 TSI MultiFuel 1.5 TSI	90 - 04/13→03/17 92 96 - 04/17→ 110	for PR number: 1ZA / 1ZB / 1ZD / 1LV; Fitting Position: Front Axle	24.0125-0158.1 425158	Outer diameter [mm]: 312 Brake Disc Thickness [mm] 25 Minimum thickness [mm] 22 Brake Disc Type: Vented Supplementary Article/Info 2: with bolts/screws	
1.6 TDI 2.0 GTD	85 11/16→ 135 01/15→03/17				
→					



	kW				
VW - GOLF VII Variant (BA5, BV5) 04/13→					
 Brake Disc					
2.0 R 4motion	213 - 03/15→ 228	for PR number: 1ZA / 1ZB / 1ZD / 1LV; Fitting Position: Front Axle	24.0325-0158.1 525158	Outer diameter [mm]: 312 Brake Disc Thickness [mm] 25 Minimum thickness [mm] 22 Brake Disc Type: Vented Supplementary Article/Info 2: with bolts/screws	
		for PR number: 1KE; Fitting Position: Rear Axle	24.0110-0356.1 410356	Outer diameter [mm]: 272 Brake Disc Thickness [mm] 9.7 Minimum thickness [mm] 8 Brake Disc Type: Solid Supplementary Article/Info 2: with bolts/screws	
			24.0310-0356.1 510356	Outer diameter [mm]: 272 Brake Disc Thickness [mm] 9.7 Minimum thickness [mm] 8 Brake Disc Type: Solid Supplementary Article/Info 2: with bolts/screws	
		for PR number: 1KV; Vehicle Equipment: for vehicles with electric parking brake; Fitting Position: Rear Axle	24.0112-0210.1 412210	Outer diameter [mm]: 300 Brake Disc Thickness [mm] 12 Minimum thickness [mm] 10 Brake Disc Type: Solid Supplementary Article/Info 2: with bolts/screws	
1.2 TSI	63 - 05/13→ 77	Construction year from: 07/13 →; for PR number: 1ZE / 1ZP; Fitting Position: Front Axle	24.0125-0145.1 425145	Outer diameter [mm]: 288 Brake Disc Thickness [mm] 25 Minimum thickness [mm] 22 Brake Disc Type: Vented Supplementary Article/Info 2: with bolts/screws	
1.4 TSI	90 - 05/13→ 103				
1.6 TDI	66 - 05/13→03/17 81				
1.6 TDI 4motion	77 - 05/13→03/17 81	Construction year from: 07/13 →; for PR number: 1ZA / 1ZB / 1ZD / 1LV; Fitting Position: Front Axle	24.0125-0158.1 425158	Outer diameter [mm]: 312 Brake Disc Thickness [mm] 25 Minimum thickness [mm] 22 Brake Disc Type: Vented Supplementary Article/Info 2: with bolts/screws	
2.0 TDI	81 - 04/13→ 110				
2.0 TDI 4motion	110 04/13→05/18				
		Construction year from: 07/13 →; for PR number: 1KE; Fitting Position: Rear Axle	24.0110-0356.1 410356	Outer diameter [mm]: 272 Brake Disc Thickness [mm] 9.7 Minimum thickness [mm] 8 Brake Disc Type: Solid Supplementary Article/Info 2: with bolts/screws	
			24.0310-0356.1 510356	Outer diameter [mm]: 272 Brake Disc Thickness [mm] 9.7 Minimum thickness [mm] 8 Brake Disc Type: Solid Supplementary Article/Info 2: with bolts/screws	
		Construction year from: 07/13 →; for PR number: 1KV; Vehicle Equipment: for vehicles with electric parking brake; Fitting Position: Rear Axle	24.0112-0210.1 412210	Outer diameter [mm]: 300 Brake Disc Thickness [mm] 12 Minimum thickness [mm] 10 Brake Disc Type: Solid Supplementary Article/Info 2: with bolts/screws	
1.5 TGI	96 12/18→	for PR number: 1ZE / 1ZP; Fitting Position: Front Axle	24.0125-0145.1 425145	Outer diameter [mm]: 288 Brake Disc Thickness [mm] 25 Minimum thickness [mm] 22 Brake Disc Type: Vented Supplementary Article/Info 2: with bolts/screws	
		for PR number: 1ZA / 1ZB / 1ZD / 1LV / 1ZC / 1ZG; Fitting Position: Front Axle	24.0125-0158.1 425158	Outer diameter [mm]: 312 Brake Disc Thickness [mm] 25 Minimum thickness [mm] 22 Brake Disc Type: Vented Supplementary Article/Info 2: with bolts/screws	
			24.0325-0158.1 525158	Outer diameter [mm]: 312 Brake Disc Thickness [mm] 25 Minimum thickness [mm] 22 Brake Disc Type: Vented Supplementary Article/Info 2: with bolts/screws	



→



	kW			
VW - GOLF VII Variant (BA5, BV5) 04/13→				
 Brake Disc				
1.5 TGI	96 12/18→	for PR number: 1KE / 1KK; Vehicle Equipment: for vehicles with electric parking brake; Fitting Position: Rear Axle	24.0110-0356.1 410356	Outer diameter [mm]: 272 Brake Disc Thickness [mm] 9.7 Minimum thickness [mm] 8 Brake Disc Type: Solid Supplementary Article/Info 2: with bolts/screws
			24.0310-0356.1 510356	Outer diameter [mm]: 272 Brake Disc Thickness [mm] 9.7 Minimum thickness [mm] 8 Brake Disc Type: Solid Supplementary Article/Info 2: with bolts/screws
		for PR number: 1KV; Vehicle Equipment: for vehicles with electric parking brake; Fitting Position: Rear Axle	24.0112-0210.1 412210	Outer diameter [mm]: 300 Brake Disc Thickness [mm] 12 Minimum thickness [mm] 10 Brake Disc Type: Solid Supplementary Article/Info 2: with bolts/screws
1.6 1.8 TSI 4motion 2.0 R 360S 4motion 2.0 R 4motion	81 05/14→03/17 132 11/16→ 265 09/16→ 206 03/15→03/17	for PR number: 1ZE / 1ZP; Fitting Position: Front Axle	24.0125-0145.1 425145	Outer diameter [mm]: 288 Brake Disc Thickness [mm] 25 Minimum thickness [mm] 22 Brake Disc Type: Vented Supplementary Article/Info 2: with bolts/screws
		for PR number: 1ZA / 1ZB / 1ZD / 1LV; Fitting Position: Front Axle	24.0125-0158.1 425158	Outer diameter [mm]: 312 Brake Disc Thickness [mm] 25 Minimum thickness [mm] 22 Brake Disc Type: Vented Supplementary Article/Info 2: with bolts/screws
		for PR number: 1KE; Fitting Position: Rear Axle	24.0110-0356.1 410356	Outer diameter [mm]: 272 Brake Disc Thickness [mm] 9.7 Minimum thickness [mm] 8 Brake Disc Type: Solid Supplementary Article/Info 2: with bolts/screws
			24.0310-0356.1 510356	Outer diameter [mm]: 272 Brake Disc Thickness [mm] 9.7 Minimum thickness [mm] 8 Brake Disc Type: Solid Supplementary Article/Info 2: with bolts/screws
		for PR number: 1KV; Vehicle Equipment: for vehicles with electric parking brake; Fitting Position: Rear Axle	24.0112-0210.1 412210	Outer diameter [mm]: 300 Brake Disc Thickness [mm] 12 Minimum thickness [mm] 10 Brake Disc Type: Solid Supplementary Article/Info 2: with bolts/screws
 Wheel Speed Sensor				
1.0 TSI	63 - 05/15→07/18 85	Fitting Position: Front Axle Left	24.0711-5273.3 360303	
		Fitting Position: Front Axle Right	24.0711-5274.3 360304	
1.2 TSI 1.4 TGI CNG 1.4 TSI 1.4 TSI MultiFuel	81 04/14→ 81 09/13→ 92 - 05/14→ 110 90 - 04/13→03/17	Required quantity: 2; Comfort Equipment Variant (trim package): for cruise control system; Fitting Position: Rear Axle	2	24.0711-6337.3 360390
1.5 TGI 1.5 TSI 1.6 1.6 TDI 1.8 TSI 4motion 2.0 GTD	96 12/18→ 96 - 04/17→ 110 81 05/14→03/17 85 11/16→ 132 11/16→ 135 01/15→03/17	Required quantity: 2; Vehicle Equipment: for vehicles with parking assistant system; Fitting Position: Rear Axle	2	24.0711-6337.3 360390
1.0 TSI	81 11/16→	Construction year from: 01/17 →; Fitting Position: Front Axle Left	24.0711-5273.3 360303	
		Construction year from: 01/17 →; Fitting Position: Front Axle Right	24.0711-5274.3 360304	
		Required quantity: 2; Vehicle Equipment: for vehicles with parking assistant system; Fitting Position: Rear Axle	2	24.0711-6337.3 360390
		Required quantity: 2; Comfort Equipment Variant (trim package): for cruise control system; Fitting Position: Rear Axle	2	24.0711-6337.3 360390
1.2 TSI	63 - 05/13→ 77	Construction year from: 07/13 →; Fitting Position: Front Axle Left	24.0711-5273.3 360303	
→				



	kW				
VW - GOLF VII Variant (BA5, BV5) 04/13→					
 Wheel Speed Sensor					
1.4 TSI	90 - 05/13→ 103		Construction year from: 07/13 →; Fitting Position: Front Axle Right		24.0711-5274.3 360304
1.6 TDI	66 - 05/13→03/17 81		Construction year from: 07/13 →; Required quantity: 2; Comfort Equipment Variant (trim package): for cruise control system; Fitting Position: Rear Axle	2	24.0711-6337.3 360390
2.0 TDI	81 - 04/13→ 110		Construction year from: 07/13 →; Required quantity: 2; Vehicle Equipment: for vehicles with parking assistant system; Fitting Position: Rear Axle	2	24.0711-6337.3 360390
1.6 TDI 4motion	77 - 05/13→03/17 81		Construction year from: 07/13 →; Fitting Position: Front Axle Left		24.0711-5273.3 360303
2.0 TDI 4motion	110 04/13→05/18		Construction year from: 07/13 →; Fitting Position: Front Axle Right		24.0711-5274.3 360304
			Construction year from: 07/13 →; Vehicle Equipment: for vehicles with parking assistant system; Fitting Position: Rear Axle Left		24.0711-5401.3 360330
			Construction year from: 07/13 →; Comfort Equipment Variant (trim package): for cruise control system; Fitting Position: Rear Axle Left		24.0711-5401.3 360330
			Construction year from: 07/13 →; Vehicle Equipment: for vehicles with parking assistant system; Fitting Position: Rear Axle Right		24.0711-5402.3 360331
			Construction year from: 07/13 →; Comfort Equipment Variant (trim package): for cruise control system; Fitting Position: Rear Axle Right		24.0711-5402.3 360331
2.0 R 360S 4motion	265 09/16→		Fitting Position: Front Axle Left		24.0711-5273.3 360303
2.0 R 4motion	206 - 03/15→ 228		Fitting Position: Front Axle Right		24.0711-5274.3 360304
			Vehicle Equipment: for vehicles with parking assistant system; Fitting Position: Rear Axle Left		24.0711-5401.3 360330
			Comfort Equipment Variant (trim package): for cruise control system; Fitting Position: Rear Axle Left		24.0711-5401.3 360330
			Comfort Equipment Variant (trim package): for cruise control system; Fitting Position: Rear Axle Right		24.0711-5402.3 360331
			Vehicle Equipment: for vehicles with parking assistant system; Fitting Position: Rear Axle Right		24.0711-5402.3 360331
Control Element, parking brake caliper					
1.0 TSI	63 - 05/15→ 85		for PR number: 1KE; Fitting Position: Rear Axle Left		11.9282-1001.3 250159 Brake System: ATE
1.2 TSI	81 04/14→		for PR number: 1KE;		11.9282-1002.3 250160 Brake System: ATE
1.4 TGI CNG	81 09/13→		Fitting Position: Rear Axle Right		
1.4 TSI	92 - 05/14→ 110				
1.4 TSI MultiFuel	90 - 04/13→03/17 92				
1.5 TGI	96 12/18→				
1.5 TSI	96 - 04/17→ 110				
1.6	81 05/14→03/17				
1.6 TDI	85 11/16→				
1.8 TSI 4motion	132 11/16→				
2.0 GTD	135 01/15→03/17				
2.0 R 360S 4motion	265 09/16→				
2.0 R 4motion	206 - 03/15→ 228				
1.2 TSI	63 - 05/13→ 77		Construction year from: 07/13 →; for PR number: 1KE;		11.9282-1001.3 250159 Brake System: ATE
1.4 TSI	90 - 05/13→ 103		Fitting Position: Rear Axle Left		
1.6 TDI	66 - 05/13→03/17 81		Construction year from: 07/13 →; for PR number: 1KE;		11.9282-1002.3 250160 Brake System: ATE
1.6 TDI 4motion	77 - 05/13→03/17 81		Fitting Position: Rear Axle Right		
2.0 TDI	81 - 04/13→ 110				
2.0 TDI 4motion	110 04/13→05/18				



	kW				
VW - GOLF VIII (CD1) 07/19→					
 Brake Caliper					
1.0 TSI	66 - 02/20→ 81		for PR number: 1ZK; Fitting Position: Front Axle Left	24.3571-1801.5 241387	Supplementary Article/Supplementary Info: without holder Brake Caliper Type: Fist-type Caliper
1.4 GTE Plug-in Hybrid	110 - 07/20→ 180				
1.4 TSI eHybrid	110 - 07/20→ 150		for PR number: 1ZK; Fitting Position: Front Axle Right	24.3571-1802.5 241388	Supplementary Article/Supplementary Info: without holder Brake Caliper Type: Fist-type Caliper
1.5 TGI	96 09/20→				
1.5 TSI	96 - 07/19→ 110				
2.0 GTI	180 08/20→				
2.0 GTI Clubsport	221 10/20→				
2.0 TDI	85 - 08/19→ 110				
2.0 TDI 4motion	110 - 09/20→ 147				
2.0 TDI GTD	147 09/20→				
2.0 TSI	140 06/21→				
2.0 TSI 4motion	140 06/21→				
2.0 TSI R 4motion	235 09/20→				
 Brake Disc					
1.0 eTSI	81 06/20→		for PR number: 1ZE / 1ZJ / 1ZP / 1ZQ; Fitting Position: Front Axle	24.0125-0145.1 425145	Outer diameter [mm]: 288 Brake Disc Thickness [mm] 25 Minimum thickness [mm] 22 Brake Disc Type: Vented Supplementary Article/Info 2: with bolts/screws
1.5 eTSI	96 - 12/19→ 110				
			for PR number: 1KE / 1KJ / 2EG / 2EJ; Fitting Position: Rear Axle	24.0110-0356.1 410356	Outer diameter [mm]: 272 Brake Disc Thickness [mm] 9.7 Minimum thickness [mm] 8 Brake Disc Type: Solid Supplementary Article/Info 2: with bolts/screws
1.0 TSI	66 - 02/20→ 81		for PR number: 1ZE; Fitting Position: Front Axle	24.0125-0145.1 425145	Outer diameter [mm]: 288 Brake Disc Thickness [mm] 25 Minimum thickness [mm] 22 Brake Disc Type: Vented Supplementary Article/Info 2: with bolts/screws
1.4 GTE Plug-in Hybrid	110 - 07/20→ 180				
1.4 TSI eHybrid	110 - 07/20→ 150				
1.5 TGI	96 09/20→		for PR number: 1ZK / 1ZU; Fitting Position: Front Axle	24.0125-0158.1 425158	Outer diameter [mm]: 312 Brake Disc Thickness [mm] 25 Minimum thickness [mm] 22 Brake Disc Type: Vented Supplementary Article/Info 2: with bolts/screws
1.5 TSI	96 - 07/19→ 110				
2.0 GTI	180 08/20→				
2.0 GTI Clubsport	221 10/20→				
2.0 TDI	85 - 08/19→ 110				
2.0 TDI 4motion	110 - 09/20→ 147		for PR number: 1KE / 2EC / 2EJ; Fitting Position: Rear Axle	24.0110-0356.1 410356	Outer diameter [mm]: 272 Brake Disc Thickness [mm] 9.7 Minimum thickness [mm] 8 Brake Disc Type: Solid Supplementary Article/Info 2: with bolts/screws
2.0 TDI GTD	147 09/20→				
2.0 TSI	140 06/21→				
2.0 TSI 4motion	140 06/21→				
2.0 TSI R 4motion	235 09/20→				
 Wheel Speed Sensor					
1.0 eTSI	81 06/20→		Fitting Position: Front Axle Left	24.0711-5273.3 360303	
1.0 TSI	66 - 02/20→ 81		Fitting Position: Front Axle Right	24.0711-5274.3 360304	
1.4 GTE Plug-in Hybrid	110 - 07/20→ 180		Required quantity: 2; Fitting Position: Rear Axle	2 24.0711-6337.3 360390	
1.4 TSI eHybrid	110 - 07/20→ 150				
1.5 eTSI	96 - 12/19→ 110				
1.5 TGI	96 09/20→				
1.5 TSI	96 - 07/19→ 110				
2.0 GTI	180 08/20→				
2.0 GTI Clubsport	221 10/20→				
2.0 TDI	85 - 08/19→ 110				
2.0 TDI GTD	147 09/20→				
2.0 TSI	140 06/21→				
2.0 TDI 4motion	110 - 09/20→ 147		Fitting Position: Front Axle Left	24.0711-5273.3 360303	
2.0 TSI 4motion	140 06/21→		Fitting Position: Front Axle Right	24.0711-5274.3 360304	
2.0 TSI R 4motion	235 09/20→		Fitting Position: Rear Axle Left	24.0711-5401.3 360330	
			Fitting Position: Rear Axle Right	24.0711-5402.3 360331	
Control Element, parking brake caliper					
1.0 eTSI	81 06/20→		Fitting Position: Rear Axle Left	11.9282-1001.3 250159	Brake System: ATE
→					



	kW				
VW - GOLF VIII (CD1) 07/19→					
Control Element, parking brake caliper					
1.0 TSI	66 - 02/20→ 81	Fitting Position: Rear Axle Right	11.9282-1002.3	250160	Brake System: ATE
1.4 GTE Plug-in Hybrid	110 - 07/20→ 180				
1.4 TSI eHybrid	110 - 07/20→ 150				
1.5 eTSI	96 - 12/19→ 110				
1.5 TGI	96 09/20→				
1.5 TSI	96 - 07/19→ 110				
2.0 GTI	180 08/20→				
2.0 GTI Clubsport	221 10/20→				
2.0 TDI	85 - 08/19→ 110				
2.0 TDI 4motion	110 - 09/20→ 147				
2.0 TDI GTD	147 09/20→				
2.0 TSI	140 06/21→				
2.0 TSI 4motion	140 06/21→				
2.0 TSI R 4motion	235 09/20→				
VW - GOLF VIII Variant (CG5) 08/20→					
 Brake Caliper					
1.0 TSI	66 - 08/20→ 81	for PR number: 1ZK; Fitting Position: Front Axle Left	24.3571-1801.5	241387	Supplementary Article/Supplementary Info: without holder Brake Caliper Type: Fist-type Caliper
1.5 TGI	96 09/20→				
1.5 TSI	96 - 08/20→ 110				
2.0 GTI	180 09/20→	for PR number: 1ZK; Fitting Position: Front Axle Right	24.3571-1802.5	241388	Supplementary Article/Supplementary Info: without holder Brake Caliper Type: Fist-type Caliper
2.0 TDI	85 - 08/20→ 110				
2.0 TDI 4motion	110 - 09/20→ 147				
2.0 TSI	140 06/21→				
2.0 TSI 4motion	140 06/21→				
2.0 TSI R 4motion	235 06/21→				
 Brake Disc					
1.0 eTSI	81 09/20→	for PR number: 1ZE / 1ZJ / 1ZP / 1ZQ; Fitting Position: Front Axle	24.0125-0145.1	425145	Outer diameter [mm]: 288 Brake Disc Thickness [mm] 25 Minimum thickness [mm] 22 Brake Disc Type: Vented Supplementary Article/Info 2: with bolts/screws
1.5 eTSI	96 - 12/20→ 110				
		for PR number: 1KE / 1KJ / 2EG / 2EJ; Fitting Position: Rear Axle	24.0110-0356.1	410356	Outer diameter [mm]: 272 Brake Disc Thickness [mm] 9.7 Minimum thickness [mm] 8 Brake Disc Type: Solid Supplementary Article/Info 2: with bolts/screws
1.0 TSI	66 - 08/20→ 81	for PR number: 1ZE; Fitting Position: Front Axle	24.0125-0145.1	425145	Outer diameter [mm]: 288 Brake Disc Thickness [mm] 25 Minimum thickness [mm] 22 Brake Disc Type: Vented Supplementary Article/Info 2: with bolts/screws
1.5 TGI	96 09/20→				
1.5 TSI	96 - 08/20→ 110				
2.0 GTI	180 09/20→				
2.0 TDI	85 - 08/20→ 110	for PR number: 1ZK / 1ZU; Fitting Position: Front Axle	24.0125-0158.1	425158	Outer diameter [mm]: 312 Brake Disc Thickness [mm] 25 Minimum thickness [mm] 22 Brake Disc Type: Vented Supplementary Article/Info 2: with bolts/screws
2.0 TDI 4motion	110 - 09/20→ 147				
2.0 TSI	140 06/21→				
2.0 TSI 4motion	140 06/21→				
2.0 TSI R 4motion	235 06/21→	for PR number: 1KE / 2EC / 2EJ; Fitting Position: Rear Axle	24.0110-0356.1	410356	Outer diameter [mm]: 272 Brake Disc Thickness [mm] 9.7 Minimum thickness [mm] 8 Brake Disc Type: Solid Supplementary Article/Info 2: with bolts/screws
 Wheel Speed Sensor					
1.0 eTSI	81 09/20→	Fitting Position: Front Axle Left	24.0711-5273.3	360303	
1.0 TSI	66 - 08/20→ 81	Fitting Position: Front Axle Right	24.0711-5274.3	360304	
1.5 eTSI	96 - 12/20→ 110	Required quantity: 2; Fitting Position: Rear Axle	2	24.0711-6337.3	360390
1.5 TGI	96 09/20→				
1.5 TSI	96 - 08/20→ 110				
2.0 GTI	180 09/20→				





	kW				
VW - GOLF VIII Variant (CG5) 08/20→					
 Wheel Speed Sensor					
2.0 TDI	85 - 08/20→ 110		Fitting Position: Front Axle Left	24.0711-5273.3	360303
2.0 TSI	140 06/21→		Fitting Position: Front Axle Right	24.0711-5274.3	360304
			Required quantity: 2; Fitting Position: Rear Axle	24.0711-6337.3	360390
2.0 TDI 4motion	110 - 09/20→ 147		Fitting Position: Front Axle Left	24.0711-5273.3	360303
2.0 TSI 4motion	140 06/21→		Fitting Position: Front Axle Right	24.0711-5274.3	360304
2.0 TSI R 4motion	235 06/21→		Fitting Position: Rear Axle Left	24.0711-5401.3	360330
			Fitting Position: Rear Axle Right	24.0711-5402.3	360331
Control Element, parking brake caliper					
1.0 eTSI	81 09/20→		Fitting Position: Rear Axle Left	11.9282-1001.3	250159 Brake System: ATE
1.0 TSI	66 - 08/20→ 81		Fitting Position: Rear Axle Right	11.9282-1002.3	250160 Brake System: ATE
1.5 eTSI	96 - 12/20→ 110				
1.5 TGI	96 09/20→				
1.5 TSI	96 - 08/20→ 110				
2.0 GTI	180 09/20→				
2.0 TDI	85 - 08/20→ 110				
2.0 TDI 4motion	110 - 09/20→ 147				
2.0 TSI	140 06/21→				
2.0 TSI 4motion	140 06/21→				
2.0 TSI R 4motion	235 06/21→				
VW - GOLF ALLTRACK VII Variant (BA5, BV5) 12/14→					
 Brake Caliper					
1.6 TDI 4motion	81 12/14→		for PR number: 1ZA / 1ZD; Fitting Position: Front Axle Left	24.3571-1801.5	241387 Supplementary Article/Supplementary Info: without holder Brake Caliper Type: Fist-type Caliper
1.8 TSI 4motion	132 12/14→				
2.0 TDI 4motion	110 - 12/14→ 135		for PR number: 1ZA / 1ZD; Fitting Position: Front Axle Right	24.3571-1802.5	241388 Supplementary Article/Supplementary Info: without holder Brake Caliper Type: Fist-type Caliper
Brake Disc					
1.6 TDI 4motion	81 12/14→		for PR number: 1ZE / 1ZP; Fitting Position: Front Axle	24.0125-0145.1	425145 Outer diameter [mm]: 288 Brake Disc Thickness [mm] 25 Minimum thickness [mm] 22 Brake Disc Type: Vented Supplementary Article/Info 2: with bolts/screws
1.8 TSI 4motion	132 12/14→				
2.0 TDI 4motion	110 - 12/14→ 135		for PR number: 1ZA / 1ZB / 1ZD / 1LV; Fitting Position: Front Axle	24.0125-0158.1	425158 Outer diameter [mm]: 312 Brake Disc Thickness [mm] 25 Minimum thickness [mm] 22 Brake Disc Type: Vented Supplementary Article/Info 2: with bolts/screws
				24.0325-0158.1	525158 Outer diameter [mm]: 312 Brake Disc Thickness [mm] 25 Minimum thickness [mm] 22 Brake Disc Type: Vented Supplementary Article/Info 2: with bolts/screws
			for PR number: 1KE; Fitting Position: Rear Axle	24.0110-0356.1	410356 Outer diameter [mm]: 272 Brake Disc Thickness [mm] 9.7 Minimum thickness [mm] 8 Brake Disc Type: Solid Supplementary Article/Info 2: with bolts/screws
				24.0310-0356.1	510356 Outer diameter [mm]: 272 Brake Disc Thickness [mm] 9.7 Minimum thickness [mm] 8 Brake Disc Type: Solid Supplementary Article/Info 2: with bolts/screws
			for PR number: 1KV; Vehicle Equipment: for vehicles with electric parking brake; Fitting Position: Rear Axle	24.0112-0210.1	412210 Outer diameter [mm]: 300 Brake Disc Thickness [mm] 12 Minimum thickness [mm] 10 Brake Disc Type: Solid Supplementary Article/Info 2: with bolts/screws



	kW				
VW - GOLF PLUS Van (521) 01/09→08/14					
 Brake Disc					
1.2 TSi	77	11/09→08/14	for PR number: 1LJ / 1ZA; Fitting Position: Front Axle	24.0125-0158.1 425158	Outer diameter [mm]: 312 Brake Disc Thickness [mm] 25 Minimum thickness [mm] 22 Brake Disc Type: Vented Supplementary Article/Info 2: with bolts/screws
1.4 TSi	90	01/09→08/14			
	118				
1.6 TDi	66	02/09→08/14			
	77				
2.0 TDi	103	11/09→08/14			
VW - GOLF SPORTSVAN VII (AM1, AN1) 02/14→					
 Brake Caliper					
1.0 TSI	63	05/15→	for PR number: 1ZA; Fitting Position: Front Axle Left	24.3571-1801.5 241387	Supplementary Article/Supplementary Info: without holder Brake Caliper Type: Fist-type Caliper
	85				
1.2 TSI	63	04/14→			
	81				
1.4 TSI	92	04/14→	for PR number: 1ZA; Fitting Position: Front Axle Right	24.3571-1802.5 241388	Supplementary Article/Supplementary Info: without holder Brake Caliper Type: Fist-type Caliper
1.4 TSI MultiFuel	92	04/14→			
1.5 TSI	96	05/17→			
	110				
1.6	81	05/14→			
1.6 TDI	66	02/14→			
	85				
2.0 TDI	81	05/14→11/17			
1.4 TSI	110	02/14→	Construction year from: 05/14 →; for PR number: 1ZA; Fitting Position: Front Axle Left	24.3571-1801.5 241387	Supplementary Article/Supplementary Info: without holder Brake Caliper Type: Fist-type Caliper
1.6 TDI	81	02/14→			
2.0 TDI	110	02/14→			
			Construction year from: 05/14 →; for PR number: 1ZA; Fitting Position: Front Axle Right	24.3571-1802.5 241388	Supplementary Article/Supplementary Info: without holder Brake Caliper Type: Fist-type Caliper
 Brake Disc					
1.0 TSI	63	05/15→	for PR number: 1ZE / 1ZP; Fitting Position: Front Axle	24.0125-0145.1 425145	Outer diameter [mm]: 288 Brake Disc Thickness [mm] 25 Minimum thickness [mm] 22 Brake Disc Type: Vented Supplementary Article/Info 2: with bolts/screws
	85				
1.2 TSI	63	04/14→			
	81				
1.4 TSI	92	04/14→	for PR number: 1ZA; Fitting Position: Front Axle	24.0125-0158.1 425158	Outer diameter [mm]: 312 Brake Disc Thickness [mm] 25 Minimum thickness [mm] 22 Brake Disc Type: Vented Supplementary Article/Info 2: with bolts/screws
1.4 TSI MultiFuel	92	04/14→			
1.5 TSI	96	05/17→			
	110				
1.6 TDI	66	02/14→			
2.0 TDI	81	05/14→11/17			
				24.0325-0158.1 525158	Outer diameter [mm]: 312 Brake Disc Thickness [mm] 25 Minimum thickness [mm] 22 Brake Disc Type: Vented Supplementary Article/Info 2: with bolts/screws
			for PR number: 1KE; Fitting Position: Rear Axle	24.0110-0356.1 410356	Outer diameter [mm]: 272 Brake Disc Thickness [mm] 9.7 Minimum thickness [mm] 8 Brake Disc Type: Solid Supplementary Article/Info 2: with bolts/screws
				24.0310-0356.1 510356	Outer diameter [mm]: 272 Brake Disc Thickness [mm] 9.7 Minimum thickness [mm] 8 Brake Disc Type: Solid Supplementary Article/Info 2: with bolts/screws
1.4 TSI	110	02/14→	Construction year from: 05/14 →; for PR number: 1ZE / 1ZP; Fitting Position: Front Axle	24.0125-0145.1 425145	Outer diameter [mm]: 288 Brake Disc Thickness [mm] 25 Minimum thickness [mm] 22 Brake Disc Type: Vented Supplementary Article/Info 2: with bolts/screws
1.6 TDI	81	02/14→			
2.0 TDI	110	02/14→			
			Construction year from: 05/14 →; for PR number: 1ZA; Fitting Position: Front Axle	24.0125-0158.1 425158	Outer diameter [mm]: 312 Brake Disc Thickness [mm] 25 Minimum thickness [mm] 22 Brake Disc Type: Vented Supplementary Article/Info 2: with bolts/screws

		kW					
VW - GOLF SPORTSVAN VII (AM1, AN1) 02/14→							
 Brake Disc							
1.4 TSI 1.6 TDI 2.0 TDI	110 02/14→ 81 02/14→ 110 02/14→	Construction year from: 05/14 →; for PR number: 1ZA; Fitting Position: Front Axle		24.0325-0158.1	525158	Outer diameter [mm]: 312 Brake Disc Thickness [mm] 25 Minimum thickness [mm] 22 Brake Disc Type: Vented Supplementary Article/Info 2: with bolts/screws	
		Construction year from: 05/14 →; for PR number: 1KE; Fitting Position: Rear Axle		24.0110-0356.1	410356	Outer diameter [mm]: 272 Brake Disc Thickness [mm] 9.7 Minimum thickness [mm] 8 Brake Disc Type: Solid Supplementary Article/Info 2: with bolts/screws	
				24.0310-0356.1	510356	Outer diameter [mm]: 272 Brake Disc Thickness [mm] 9.7 Minimum thickness [mm] 8 Brake Disc Type: Solid Supplementary Article/Info 2: with bolts/screws	
1.6	81 05/14→	for PR number: 1ZE / 1ZP; Fitting Position: Front Axle		24.0125-0145.1	425145	Outer diameter [mm]: 288 Brake Disc Thickness [mm] 25 Minimum thickness [mm] 22 Brake Disc Type: Vented Supplementary Article/Info 2: with bolts/screws	
		for PR number: 1ZA; Fitting Position: Front Axle		24.0125-0158.1	425158	Outer diameter [mm]: 312 Brake Disc Thickness [mm] 25 Minimum thickness [mm] 22 Brake Disc Type: Vented Supplementary Article/Info 2: with bolts/screws	
		for PR number: 1KE; Fitting Position: Rear Axle		24.0110-0356.1	410356	Outer diameter [mm]: 272 Brake Disc Thickness [mm] 9.7 Minimum thickness [mm] 8 Brake Disc Type: Solid Supplementary Article/Info 2: with bolts/screws	
				24.0310-0356.1	510356	Outer diameter [mm]: 272 Brake Disc Thickness [mm] 9.7 Minimum thickness [mm] 8 Brake Disc Type: Solid Supplementary Article/Info 2: with bolts/screws	
1.6 TDI	85 11/16→	for PR number: 1ZE; Fitting Position: Front Axle		24.0125-0145.1	425145	Outer diameter [mm]: 288 Brake Disc Thickness [mm] 25 Minimum thickness [mm] 22 Brake Disc Type: Vented Supplementary Article/Info 2: with bolts/screws	
		for PR number: 1ZA; Fitting Position: Front Axle		24.0125-0158.1	425158	Outer diameter [mm]: 312 Brake Disc Thickness [mm] 25 Minimum thickness [mm] 22 Brake Disc Type: Vented Supplementary Article/Info 2: with bolts/screws	
		for PR number: 1KE; Fitting Position: Rear Axle		24.0110-0356.1	410356	Outer diameter [mm]: 272 Brake Disc Thickness [mm] 9.7 Minimum thickness [mm] 8 Brake Disc Type: Solid Supplementary Article/Info 2: with bolts/screws	
				24.0310-0356.1	510356	Outer diameter [mm]: 272 Brake Disc Thickness [mm] 9.7 Minimum thickness [mm] 8 Brake Disc Type: Solid Supplementary Article/Info 2: with bolts/screws	
 Wheel Speed Sensor							
1.0 TSI	63 - 05/15→ 85	Fitting Position: Front Axle Left		24.0711-5273.3	360303		
1.2 TSI	63 - 04/14→ 81	Fitting Position: Front Axle Right		24.0711-5274.3	360304		
1.4 TSI →	92 04/14→	Required quantity: 2; Comfort Equipment Variant (trim		2	24.0711-6337.3	360390	

	kW				
VW - GOLF SPORTSVAN VII (AM1, AN1) 02/14→					
 Wheel Speed Sensor					
1.4 TSI MultiFuel	92	04/14→	package): for cruise control system;		
1.5 TSI	96	05/17→	Fitting Position: Rear Axle		
		110	Required quantity: 2;	2	24.0711-6337.3 360390
1.6	81	05/14→	Vehicle Equipment: for vehicles with		
1.6 TDI	66	02/14→	parking assistant system;		
		85	Fitting Position: Rear Axle		
2.0 TDI	81	05/14→11/17			
1.4 TSI	110	02/14→	Construction year from: 05/14 →;	24.0711-5273.3	360303
1.6 TDI	81	02/14→	Fitting Position: Front Axle Left		
2.0 TDI	110	02/14→	Construction year from: 05/14 →;	24.0711-5274.3	360304
			Fitting Position: Front Axle Right		
			Construction year from: 05/14 →;	2	24.0711-6337.3 360390
			Required quantity: 2;		
			Comfort Equipment Variant (trim		
			package): for cruise control system;		
			Fitting Position: Rear Axle		
			Construction year from: 05/14 →;	2	24.0711-6337.3 360390
			Required quantity: 2;		
			Vehicle Equipment: for vehicles with		
			parking assistant system;		
			Fitting Position: Rear Axle		
Control Element, parking brake caliper					
1.0 TSI	63	05/15→	for PR number: 1KE;	11.9282-1001.3	250159 Brake System: ATE
		85	Fitting Position: Rear Axle Left		
1.2 TSI	63	04/14→	for PR number: 1KE;	11.9282-1002.3	250160 Brake System: ATE
		81	Fitting Position: Rear Axle Right		
1.4 TSI	92	04/14→			
1.4 TSI MultiFuel	92	04/14→			
1.5 TSI	96	05/17→			
		110			
1.6	81	05/14→			
1.6 TDI	66	02/14→			
		85			
2.0 TDI	81	05/14→11/17			
1.4 TSI	110	02/14→	Construction year from: 05/14 →;	11.9282-1001.3	250159 Brake System: ATE
1.6 TDI	81	02/14→	for PR number: 1KE;		
2.0 TDI	110	02/14→	Fitting Position: Rear Axle Left		
			Construction year from: 05/14 →;	11.9282-1002.3	250160 Brake System: ATE
			for PR number: 1KE;		
			Fitting Position: Rear Axle Right		
VW - GOLF VAN IV Variant (1J5) 05/99→06/06					
Guide Bolt, brake caliper					
1.9 TDI	96	04/01→05/06	→ Construction year to: 10/03;	2	11.8171-0008.1 990049 Brake System: ATE
			for PR number: 1LE / 1LN / 1ZE / 1ZH;		
			Required quantity: 2;		
			Fitting Position: Front Axle		
VW - GOLF VAN VI Variant (AJ5) 07/09→05/14					
Guide Bolt, brake caliper					
1.2 TSi	77	09/09→05/14	for PR number: 1LJ / 1ZA / 1ZD / 1ZE /	2	11.8171-0008.1 990049 Brake System: ATE
1.4 TSi	90	07/09→05/14	1ZP; Required quantity: 2		
		118			
1.6 TDi	66	12/09→10/12			
1.6 TDi BlueMotion	77	07/09→05/14			
2.0 TDi	103	07/09→05/14			
 Brake Disc					
1.2 TSi	77	09/09→05/14	for PR number: 1ZE / 1ZP;	24.0125-0145.1	425145 Outer diameter [mm]: 288
1.4 TSi	90	07/09→05/14	Fitting Position: Front Axle		Brake Disc Thickness [mm] 25
		118			Minimum thickness [mm] 22
1.6 TDi	66	12/09→10/12			Brake Disc Type: Vented
1.6 TDi BlueMotion	77	07/09→05/14			Supplementary Article/Info 2: with
2.0 TDi	103	07/09→05/14			bolts/screws
			for PR number: 1LJ / 1ZA / 1ZD;	24.0125-0158.1	425158 Outer diameter [mm]: 312
			Fitting Position: Front Axle		Brake Disc Thickness [mm] 25
					Minimum thickness [mm] 22
					Brake Disc Type: Vented
					Supplementary Article/Info 2: with
					bolts/screws
			for PR number: 1KS;	24.0110-0356.1	410356 Outer diameter [mm]: 272
			Fitting Position: Rear Axle		Brake Disc Thickness [mm] 9.7
					Minimum thickness [mm] 8
					Brake Disc Type: Solid
					Supplementary Article/Info 2: with
					bolts/screws

	kW				
VW - GOLF VAN VI Variant (AJ5) 07/09→05/14					
 Brake Disc					
1.2 TSi	77 09/09→05/14	for PR number: 1KS;		24.0310-0356.1 510356	Outer diameter [mm]: 272 Brake Disc Thickness [mm] 9.7 Minimum thickness [mm] 8 Brake Disc Type: Solid Supplementary Article/Info 2: with bolts/screws
1.4 TSi	90 - 07/09→05/14	Fitting Position: Rear Axle			
	118				
1.6 TDi	66 12/09→10/12				
1.6 TDi BlueMotion	77 07/09→05/14				
2.0 TDi	103 07/09→05/14				
VW - GOLF VAN VII Variant (BA5) 04/13→03/17					
 Brake Caliper					
1.2 TSi BlueMotion	63 - 04/13→03/17	for PR number: 1ZA / 1ZD;		24.3571-1801.5 241387	Supplementary Article/Supplementary Info: without holder Brake Caliper Type: Fist-type Caliper
1.4 TSi BlueMotion	77	Fitting Position: Front Axle Left			
	90 - 05/13→03/17				
	103				
1.6 TDi BlueMotion	66 - 05/13→03/17	for PR number: 1ZA / 1ZD;		24.3571-1802.5 241388	Supplementary Article/Supplementary Info: without holder Brake Caliper Type: Fist-type Caliper
	81	Fitting Position: Front Axle Right			
1.6 TDi BlueMotion 4motion	77 05/13→03/17				
2.0 TDi BlueMotion	110 04/13→03/17	for PR number: 1LJ;		24.3601-2607.5 241487	Brake System: TRW Supplementary Article/Supplementary Info: without holder Brake Caliper Type: Fist-type Caliper
2.0 TDi BlueMotion 4motion	110 04/13→03/17	Fitting Position: Front Axle Left			
		for PR number: 1LJ;		24.3601-2608.5 241488	Brake System: TRW Supplementary Article/Supplementary Info: without holder Brake Caliper Type: Fist-type Caliper
		Fitting Position: Front Axle Right			
Brake Disc					
1.2 TSi BlueMotion	63 - 04/13→03/17	for PR number: 1ZE / 1ZP;		24.0125-0145.1 425145	Outer diameter [mm]: 288 Brake Disc Thickness [mm] 25 Minimum thickness [mm] 22 Brake Disc Type: Vented Supplementary Article/Info 2: with bolts/screws
1.4 TSi BlueMotion	77	Fitting Position: Front Axle			
	90 - 05/13→03/17				
	103				
1.6 TDi BlueMotion	66 - 05/13→03/17	for PR number: 1ZA / 1ZB / 1ZD / 1LV / 1ZC / 1ZG; Fitting Position: Front Axle		24.0125-0158.1 425158	Outer diameter [mm]: 312 Brake Disc Thickness [mm] 25 Minimum thickness [mm] 22 Brake Disc Type: Vented Supplementary Article/Info 2: with bolts/screws
	81				
1.6 TDi BlueMotion 4motion	77 05/13→03/17				
2.0 TDi BlueMotion	110 04/13→03/17	for PR number: 1KE / 1KK;		24.0110-0356.1 410356	Outer diameter [mm]: 272 Brake Disc Thickness [mm] 9.7 Minimum thickness [mm] 8 Brake Disc Type: Solid Supplementary Article/Info 2: with bolts/screws
2.0 TDi BlueMotion 4motion	110 04/13→03/17	Vehicle Equipment: for vehicles with electric parking brake; Fitting Position: Rear Axle			
				24.0310-0356.1 510356	Outer diameter [mm]: 272 Brake Disc Thickness [mm] 9.7 Minimum thickness [mm] 8 Brake Disc Type: Solid Supplementary Article/Info 2: with bolts/screws
		for PR number: 1KV;		24.0112-0210.1 412210	Outer diameter [mm]: 300 Brake Disc Thickness [mm] 12 Minimum thickness [mm] 10 Brake Disc Type: Solid Supplementary Article/Info 2: with bolts/screws
		Vehicle Equipment: for vehicles with electric parking brake; Fitting Position: Rear Axle			
Wheel Speed Sensor					
1.2 TSi BlueMotion	63 - 04/13→03/17	Fitting Position: Front Axle Left		24.0711-5273.3 360303	
	77				
1.4 TSi BlueMotion	90 - 05/13→03/17	Fitting Position: Front Axle Right		24.0711-5274.3 360304	
	103				
1.6 TDi BlueMotion	66 - 05/13→03/17	Required quantity: 2; Comfort Equipment Variant (trim package): for cruise control system; Fitting Position: Rear Axle		2 24.0711-6337.3 360390	
	77				
1.6 TDi BlueMotion 4motion	77 05/13→03/17				
2.0 TDi BlueMotion	110 04/13→03/17	Required quantity: 2; Vehicle Equipment: for vehicles with parking assistant system; Fitting Position: Rear Axle		2 24.0711-6337.3 360390	
2.0 TDi BlueMotion 4motion	110 04/13→03/17				
1.6 TDi BlueMotion	81 05/13→03/17	Fitting Position: Front Axle Left		24.0711-5273.3 360303	
		Fitting Position: Front Axle Right		24.0711-5274.3 360304	
		Vehicle Equipment: for vehicles with parking assistant system; Fitting Position: Rear Axle Left		24.0711-5401.3 360330	





	kW				
VW - GOLF VAN VII Variant (BA5) 04/13→03/17					
 Wheel Speed Sensor					
1.6 TDi BlueMotion	81	05/13→03/17	Comfort Equipment Variant (trim package): for cruise control system; Fitting Position: Rear Axle Left		24.0711-5401.3 360330
			Comfort Equipment Variant (trim package): for cruise control system; Fitting Position: Rear Axle Right		24.0711-5402.3 360331
			Vehicle Equipment: for vehicles with parking assistant system; Fitting Position: Rear Axle Right		24.0711-5402.3 360331
Control Element, parking brake caliper					
1.2 TSi BlueMotion	63 - 77	04/13→03/17	for PR number: 1KE; Fitting Position: Rear Axle Left		11.9282-1001.3 250159 Brake System: ATE
1.4 TSi BlueMotion	90 - 103	05/13→03/17	for PR number: 1KE; Fitting Position: Rear Axle Right		11.9282-1002.3 250160 Brake System: ATE
1.6 TDi BlueMotion	66 - 81	05/13→03/17			
1.6 TDi BlueMotion 4motion	77	05/13→03/17			
2.0 TDi BlueMotion	110	04/13→03/17			
2.0 TDi BlueMotion 4motion	110	04/13→03/17			
VW - GRAND CALIFORNIA Camper (SCB, SCC) 04/19→					
Warning Contact, brake pad wear					
2.0 TDI	103 - 130	04/19→	Required quantity: 1; for PR number: 1LA / 1LB / 1LC; Fitting Position: Front Axle	1	24.8190-0831.2 620831
2.0 TDI 4motion	103 - 130	04/19→			
 Wheel Speed Sensor					
2.0 TDI	103 - 130	04/19→	Vehicle Equipment: for vehicles with parking assistant system; Required quantity: 2; Fitting Position: Rear Axle	2	24.0711-6337.3 360390
2.0 TDI 4motion	103 - 130	04/19→	Fitting Position: Rear Axle Left		24.0711-5401.3 360330
			Fitting Position: Rear Axle Right		24.0711-5402.3 360331
VW - ID.3 (E11) 11/19→					
Warning Contact, brake pad wear					
1st Pro	150 - 150	11/19→ 11/20→	Required quantity: 1; for PR number: 1LA; Fitting Position: Front Axle	1	24.8190-0830.2 620830
Pro S	150	11/21→			
Pure	110	03/20→			
 Wheel Speed Sensor					
1st Pro	150 - 150	11/19→ 11/20→	Fitting Position: Front Axle Left		24.0711-5401.3 360330
			Fitting Position: Front Axle Right		24.0711-5402.3 360331
Pro S	150	11/21→	Fitting Position: Rear Axle Left		24.0711-5401.3 360330
Pure	110	03/20→	Fitting Position: Rear Axle Right		24.0711-5402.3 360331
VW - ID.4 (E21) 05/20→					
Warning Contact, brake pad wear					
GTX	220	05/21→	for PR number: 1LB / 1LF; Fitting Position: Front Axle		24.8190-0830.2 620830
Performance	150	05/20→			
Pure	109	01/21→			
Pure Performance	125	01/21→			
 Wheel Speed Sensor					
GTX	220	05/21→	Fitting Position: Front Axle Left		24.0711-5401.3 360330
Performance	150	05/20→	Fitting Position: Front Axle Right		24.0711-5402.3 360331
Pure	109	01/21→	Fitting Position: Rear Axle Left		24.0711-5401.3 360330
Pure Performance	125	01/21→	Fitting Position: Rear Axle Right		24.0711-5402.3 360331
VW - ID.5 (E39) 07/21→					
Warning Contact, brake pad wear					
GTX	220	08/21→	Required quantity: 1; Fitting Position: Front Axle	1	24.8190-0830.2 620830
Pro	128	07/21→			
Pro Performance	150	08/21→			
→					

	kW				
VW - ID.5 (E39) 07/21→					
 Wheel Speed Sensor					
GTX	220	08/21→		Fitting Position: Front Axle Left	24.0711-5401.3 360330
Pro	128	07/21→		Fitting Position: Front Axle Right	24.0711-5402.3 360331
Pro Performance	150	08/21→		Fitting Position: Rear Axle Left	24.0711-5401.3 360330
				Fitting Position: Rear Axle Right	24.0711-5402.3 360331
VW - JETTA III (1K2) 09/04→12/13					
Guide Bolt, brake caliper					
1.4 TSI	90 - 125	07/06→10/10		for PR number: 1ZE / 1ZP; Required quantity: 2	2 11.8171-0008.1 990049 Brake System: ATE
1.6	75	09/04→10/10		for PR number: 1LJ / 1ZD; Required quantity: 2	2 11.8171-0008.1 990049 Brake System: ATE
1.6 FSI	85	09/05→10/10			
1.6 MultiFuel	75	01/08→10/10			
1.6 TDI	66 - 77	06/09→10/10			
1.9 TDI	74 - 77	08/05→10/10			
2.0 FSI	110	08/05→10/10			
2.0 TDI	100 - 125	09/05→10/10			
2.0 TDI 16V	103	08/05→10/10			
2.0 TFSI	147	10/05→10/10			
2.5	125	07/08→10/10			
2.5	110	01/06→10/10		Construction year from: 07/08 →; for PR number: 1ZE / 1ZP; Required quantity: 2	2 11.8171-0008.1 990049 Brake System: ATE
				Construction year from: 07/08 →; for PR number: 1LJ / 1ZD; Required quantity: 2	2 11.8171-0008.1 990049 Brake System: ATE
 Brake Disc					
1.4 TSI	90 - 125	07/06→10/10		for PR number: 1ZE / 1ZP; Fitting Position: Front Axle	24.0125-0145.1 425145 Outer diameter [mm]: 288 Brake Disc Thickness [mm] 25 Minimum thickness [mm] 22 Brake Disc Type: Vented Supplementary Article/Info 2: with bolts/screws
1.6	75	09/04→10/10			
1.6 FSI	85	09/05→10/10			
1.6 MultiFuel	75	01/08→10/10			
1.6 TDI	66 - 77	06/09→10/10			
1.9 TDI	74 - 77	08/05→10/10		for PR number: 1LJ / 1ZD; Fitting Position: Front Axle	24.0125-0158.1 425158 Outer diameter [mm]: 312 Brake Disc Thickness [mm] 25 Minimum thickness [mm] 22 Brake Disc Type: Vented Supplementary Article/Info 2: with bolts/screws
2.0 FSI	110	08/05→10/10			
2.0 TDI	100 - 125	09/05→10/10			
2.0 TDI 16V	103	08/05→10/10			
2.0 TFSI	147	10/05→10/10			
2.5	110	01/06→10/10		Construction year from: 07/08 →; for PR number: 1ZE / 1ZP; Fitting Position: Front Axle	24.0125-0145.1 425145 Outer diameter [mm]: 288 Brake Disc Thickness [mm] 25 Minimum thickness [mm] 22 Brake Disc Type: Vented Supplementary Article/Info 2: with bolts/screws
				Construction year from: 07/08 →; for PR number: 1LJ / 1ZD; Fitting Position: Front Axle	24.0125-0158.1 425158 Outer diameter [mm]: 312 Brake Disc Thickness [mm] 25 Minimum thickness [mm] 22 Brake Disc Type: Vented Supplementary Article/Info 2: with bolts/screws
2.5	125	07/08→10/10		for PR number: 1ZE / 1ZP; Fitting Position: Front Axle	24.0125-0145.1 425145 Outer diameter [mm]: 288 Brake Disc Thickness [mm] 25 Minimum thickness [mm] 22 Brake Disc Type: Vented Supplementary Article/Info 2: with bolts/screws
				for PR number: 1LJ / 1ZD; Fitting Position: Front Axle	24.0125-0158.1 425158 Outer diameter [mm]: 312 Brake Disc Thickness [mm] 25 Minimum thickness [mm] 22 Brake Disc Type: Vented Supplementary Article/Info 2: with bolts/screws

		kW					
VW - JETTA IV (162, 163, AV3, AV2) 01/08→							
Guide Bolt, brake caliper							
1.2 TSI 1.6 TDI 2.0 TDI 2.0 TFSI 2.5	77 10/10→12/17 77 04/10→07/15 103 02/11→ 147 12/10→ 125 04/10→	Construction year from: 04/11 →; for PR number: 1ZA / 1ZB / 1LV; Required quantity: 2	2	11.8171-0008.1	990049	Brake System: ATE	
1.2 TSI 16V 1.4 TSI 1.4 TSI Hybrid 1.6 1.6 MPi 1.8 TSI 2.0 2.0 TDI 2.0 TSI	77 08/14→12/17 90 - 04/11→ 118 110 04/11→ 63 - 12/11→ 81 66 09/15→04/18 125 07/14→ 85 06/10→12/17 81 10/10→ 155 12/12→12/17	for PR number: 1ZA / 1ZB / 1LV; Required quantity: 2	2	11.8171-0008.1	990049	Brake System: ATE	
 Brake Disc							
1.2 TSI 1.6 TDI 2.0 TDI 2.0 TFSI	77 10/10→12/17 77 04/10→07/15 103 02/11→ 147 12/10→	Construction year from: 04/11 →; for PR number: 1ZE / 1ZP; Fitting Position: Front Axle		24.0125-0145.1	425145	Outer diameter [mm]: 288 Brake Disc Thickness [mm] 25 Minimum thickness [mm] 22 Brake Disc Type: Vented Supplementary Article/Info 2: with bolts/screws	
		Construction year from: 04/11 →; for PR number: 1ZA / 1ZB / 1LV; Fitting Position: Front Axle		24.0125-0158.1	425158	Outer diameter [mm]: 312 Brake Disc Thickness [mm] 25 Minimum thickness [mm] 22 Brake Disc Type: Vented Supplementary Article/Info 2: with bolts/screws	
				24.0325-0158.1	525158	Outer diameter [mm]: 312 Brake Disc Thickness [mm] 25 Minimum thickness [mm] 22 Brake Disc Type: Vented Supplementary Article/Info 2: with bolts/screws	
		Construction year from: 04/11 →; for PR number: 1KS / 1KT; Fitting Position: Rear Axle		24.0110-0356.1	410356	Outer diameter [mm]: 272 Brake Disc Thickness [mm] 9.7 Minimum thickness [mm] 8 Brake Disc Type: Solid Supplementary Article/Info 2: with bolts/screws	
				24.0310-0356.1	510356	Outer diameter [mm]: 272 Brake Disc Thickness [mm] 9.7 Minimum thickness [mm] 8 Brake Disc Type: Solid Supplementary Article/Info 2: with bolts/screws	
1.2 TSI 16V 1.4 TSI 1.4 TSI Hybrid 2.0 TDI 2.0 TSI	77 08/14→12/17 90 - 04/11→ 118 110 04/11→ 81 10/10→ 155 12/12→12/17	for PR number: 1ZE / 1ZP; Fitting Position: Front Axle		24.0125-0145.1	425145	Outer diameter [mm]: 288 Brake Disc Thickness [mm] 25 Minimum thickness [mm] 22 Brake Disc Type: Vented Supplementary Article/Info 2: with bolts/screws	
		for PR number: 1ZA / 1ZB / 1LV; Fitting Position: Front Axle		24.0125-0158.1	425158	Outer diameter [mm]: 312 Brake Disc Thickness [mm] 25 Minimum thickness [mm] 22 Brake Disc Type: Vented Supplementary Article/Info 2: with bolts/screws	
				24.0325-0158.1	525158	Outer diameter [mm]: 312 Brake Disc Thickness [mm] 25 Minimum thickness [mm] 22 Brake Disc Type: Vented Supplementary Article/Info 2: with bolts/screws	
		for PR number: 1KS / 1KT; Fitting Position: Rear Axle		24.0110-0356.1	410356	Outer diameter [mm]: 272 Brake Disc Thickness [mm] 9.7 Minimum thickness [mm] 8 Brake Disc Type: Solid Supplementary Article/Info 2: with bolts/screws	
				24.0310-0356.1	510356	Outer diameter [mm]: 272 Brake Disc Thickness [mm] 9.7 Minimum thickness [mm] 8 Brake Disc Type: Solid Supplementary Article/Info 2: with bolts/screws	
→							

		kW					
VW - JETTA IV (162, 163, AV3, AV2) 01/08→							
 Brake Disc							
1.4 TSI 2.0 TDI	92 - 08/14→ 110 110 07/14→	for PR number: 1ZE / 1ZP; Fitting Position: Front Axle	24.0125-0145.1 425145	Outer diameter [mm]: 288 Brake Disc Thickness [mm] 25 Minimum thickness [mm] 22 Brake Disc Type: Vented Supplementary Article/Info 2: with bolts/screws			
		for PR number: 1ZA / 1ZB / 1LV; Fitting Position: Front Axle	24.0125-0158.1 425158 24.0325-0158.1 525158	Outer diameter [mm]: 312 Brake Disc Thickness [mm] 25 Minimum thickness [mm] 22 Brake Disc Type: Vented Supplementary Article/Info 2: with bolts/screws Outer diameter [mm]: 312 Brake Disc Thickness [mm] 25 Minimum thickness [mm] 22 Brake Disc Type: Vented Supplementary Article/Info 2: with bolts/screws			
1.4 TSI 1.6 1.6 MPI 2.0	110 04/11→ 63 - 12/11→ 81 66 09/15→04/18 85 06/10→12/17	for PR number: 1ZE / 1ZP; Fitting Position: Front Axle	24.0125-0145.1 425145	Outer diameter [mm]: 288 Brake Disc Thickness [mm] 25 Minimum thickness [mm] 22 Brake Disc Type: Vented Supplementary Article/Info 2: with bolts/screws			
		for PR number: 1ZA / 1ZB / 1LV; Fitting Position: Front Axle	24.0125-0158.1 425158	Outer diameter [mm]: 312 Brake Disc Thickness [mm] 25 Minimum thickness [mm] 22 Brake Disc Type: Vented Supplementary Article/Info 2: with bolts/screws			
		for PR number: 1KS / 1KT; Fitting Position: Rear Axle	24.0110-0356.1 410356 24.0310-0356.1 510356	Outer diameter [mm]: 272 Brake Disc Thickness [mm] 9.7 Minimum thickness [mm] 8 Brake Disc Type: Solid Supplementary Article/Info 2: with bolts/screws Outer diameter [mm]: 272 Brake Disc Thickness [mm] 9.7 Minimum thickness [mm] 8 Brake Disc Type: Solid Supplementary Article/Info 2: with bolts/screws			
1.8 TSI	125 07/14→	for PR number: 1ZE / 1ZP; Fitting Position: Front Axle	24.0125-0145.1 425145	Outer diameter [mm]: 288 Brake Disc Thickness [mm] 25 Minimum thickness [mm] 22 Brake Disc Type: Vented Supplementary Article/Info 2: with bolts/screws			
		for PR number: 1ZA / 1ZB / 1LV; Fitting Position: Front Axle	24.0125-0158.1 425158	Outer diameter [mm]: 312 Brake Disc Thickness [mm] 25 Minimum thickness [mm] 22 Brake Disc Type: Vented Supplementary Article/Info 2: with bolts/screws			
2.5	125 04/10→	Construction year from: 04/11 →; for PR number: 1ZE / 1ZP; Fitting Position: Front Axle	24.0125-0145.1 425145	Outer diameter [mm]: 288 Brake Disc Thickness [mm] 25 Minimum thickness [mm] 22 Brake Disc Type: Vented Supplementary Article/Info 2: with bolts/screws			
		Construction year from: 04/11 →; for PR number: 1ZA / 1ZB / 1LV; Fitting Position: Front Axle	24.0125-0158.1 425158	Outer diameter [mm]: 312 Brake Disc Thickness [mm] 25 Minimum thickness [mm] 22 Brake Disc Type: Vented Supplementary Article/Info 2: with bolts/screws			
		Construction year from: 04/11 →; for PR number: 1KS / 1KT; Fitting Position: Rear Axle	24.0110-0356.1 410356 24.0310-0356.1 510356	Outer diameter [mm]: 272 Brake Disc Thickness [mm] 9.7 Minimum thickness [mm] 8 Brake Disc Type: Solid Supplementary Article/Info 2: with bolts/screws Outer diameter [mm]: 272 Brake Disc Thickness [mm] 9.7 Minimum thickness [mm] 8 Brake Disc Type: Solid Supplementary Article/Info 2: with bolts/screws			

VW - MULTIVAN T7 (STM, STN) 08/21→							
Guide Bolt, brake caliper							
2.0 TSi	150 10/21→	Required quantity: 2; Fitting Position: Rear Axle	2	11.8171-0008.1	990049	Brake System: ATE	
Warning Contact, brake pad wear							
1.4 e-Hybrid	110 - 08/21→ 160	Required quantity: 1; Fitting Position: Front Axle	1	24.8190-0831.2	620831		
1.5 TSi	100 09/21→						
2.0 TDI	110 03/22→						
2.0 TSi	150 10/21→						
Wheel Speed Sensor							
1.4 e-Hybrid	110 - 08/21→ 160	Fitting Position: Front Axle Left		24.0711-5401.3	360330		
1.5 TSi	100 09/21→	Fitting Position: Front Axle Right		24.0711-5402.3	360331		
2.0 TDI	110 03/22→	Fitting Position: Rear Axle Left		24.0711-5401.3	360330		
2.0 TSi	150 10/21→	Fitting Position: Rear Axle Right		24.0711-5402.3	360331		
Control Element, parking brake caliper							
1.4 e-Hybrid	110 - 08/21→ 160	Fitting Position: Rear Axle Left		11.9282-1001.3	250159	Brake System: ATE	
1.5 TSi	100 09/21→	Fitting Position: Rear Axle Right		11.9282-1002.3	250160	Brake System: ATE	
2.0 TDI	110 03/22→						
2.0 TSi	150 10/21→						
VW - NEW BEETLE (9C1, 1C1) 01/98→11/10							
Guide Bolt, brake caliper							
1.4	55 11/01→09/10	→ Construction year to: 05/10; for PR number: 1ZD / 1ZE; Required quantity: 2	2	11.8171-0008.1	990049	Brake System: ATE	
1.6	75 06/00→09/10						
1.8 T	110 10/99→09/10						
1.9 TDI	74 - 02/01→09/10 77						
2.0	85 01/98→09/10						
2.5	110 07/05→09/10						
1.6	74 10/99→09/00	Construction year from: 11/99 →; for PR number: 1ZD / 1ZE; Required quantity: 2	2	11.8171-0008.1	990049	Brake System: ATE	
1.8 T	132 11/01→06/05	for PR number: 1ZD / 1ZE; Required quantity: 2	2	11.8171-0008.1	990049	Brake System: ATE	
1.9 TDI	66 01/98→06/04	→ Construction year to: 02/01; for PR number: 1ZD / 1ZE; Required quantity: 2	2	11.8171-0008.1	990049	Brake System: ATE	
2.3 V5	125 10/00→09/10	→ Construction year to: 12/05; Required quantity: 2	2	11.8171-0008.1	990049	Brake System: ATE	
3.2 RSI 4motion	165 04/00→05/01	Required quantity: 2	2	11.8171-0008.1	990049	Brake System: ATE	
VW - NEW BEETLE Convertible (1Y7) 09/02→12/11							
Guide Bolt, brake caliper							
1.4	55 01/03→09/10	→ Construction year to: 05/10; for PR number: 1ZD / 1ZE; Required quantity: 2	2	11.8171-0008.1	990049	Brake System: ATE	
1.6	75 01/03→09/10						
1.9 TDI	77 07/05→09/10						
2.5	110 07/05→09/10						
1.8 T	110 01/03→09/10	Construction year from: 12/03 → → Construction year to: 05/10; for PR number: 1ZD / 1ZE; Required quantity: 2	2	11.8171-0008.1	990049	Brake System: ATE	
1.9 TDI	74 06/03→09/10	Construction year from: 07/03 → → Construction year to: 05/10; for PR number: 1ZD / 1ZE; Required quantity: 2	2	11.8171-0008.1	990049	Brake System: ATE	
2.0	85 09/02→10/10	Construction year from: 01/03 → → Construction year to: 05/10; for PR number: 1ZD / 1ZE; Required quantity: 2	2	11.8171-0008.1	990049	Brake System: ATE	
VW - PASSAT ALLTRACK B7 (365) 01/12→12/14							
Guide Bolt, brake caliper							
1.8 TSI	112 - 01/12→12/14 118	for PR number: 1ZM / 1ZG; Required quantity: 2	2	11.8171-0008.1	990049	Brake System: ATE	
2.0 TDI	103 01/12→12/14						
2.0 TDI 4motion	103 - 01/12→12/14 130						
2.0 TSI 4motion	155 01/12→12/14						
→							

	kW				
VW - PASSAT ALLTRACK B7 (365) 01/12→12/14					
 Brake Disc					
1.8 TSI	112	01/12→12/14	for PR number: 1ZM / 1ZG; Fitting Position: Front Axle	24.0125-0158.1 425158	Outer diameter [mm]: 312 Brake Disc Thickness [mm] 25 Minimum thickness [mm] 22 Brake Disc Type: Vented Supplementary Article/Info 2: with bolts/screws
1.8 TSI 2.0 TDI 2.0 TDI 4motion 2.0 TSI 4motion	118 103 103 - 01/12→12/14 130 155	01/12→12/14 01/12→12/14 01/12→12/14 01/12→12/14	for PR number: 1ZM / 1ZG; Fitting Position: Front Axle	24.0125-0158.1 425158 24.0325-0158.1 525158	Outer diameter [mm]: 312 Brake Disc Thickness [mm] 25 Minimum thickness [mm] 22 Brake Disc Type: Vented Supplementary Article/Info 2: with bolts/screws Outer diameter [mm]: 312 Brake Disc Thickness [mm] 25 Minimum thickness [mm] 22 Brake Disc Type: Vented Supplementary Article/Info 2: with bolts/screws
 Wheel Speed Sensor					
2.0 TDI 4motion	103 -	01/12→12/14	Fitting Position: Rear Axle Left	24.0711-5401.3 360330	
2.0 TSI 4motion	130 155	01/12→12/14	Fitting Position: Rear Axle Right	24.0711-5402.3 360331	
VW - PASSAT ALLTRACK B8 Variant (3G5, CB5) 05/15→					
 Brake Caliper					
1.4 TSI 4motion 2.0 TDI 4motion	110 110 -	05/15→ 05/15→	for PR number: 1ZA / 1ZD / 1ZK / 1ZL; Fitting Position: Front Axle Left	24.3571-1801.5 241387	Supplementary Article/Supplementary Info: without holder Brake Caliper Type: Fist-type Caliper
2.0 TSI 4motion	176 162 -	07/15→ 206	for PR number: 1ZA / 1ZD / 1ZK / 1ZL; Fitting Position: Front Axle Right	24.3571-1802.5 241388	Supplementary Article/Supplementary Info: without holder Brake Caliper Type: Fist-type Caliper
 Brake Disc					
1.4 TSI 4motion 2.0 TDI 4motion	110 135 -	05/15→ 07/15→	for PR number: 1ZA / 1ZC / 1ZD / 1ZG / 1ZK / 1ZL; Fitting Position: Front Axle	24.0125-0158.1 425158	Outer diameter [mm]: 312 Brake Disc Thickness [mm] 25 Minimum thickness [mm] 22 Brake Disc Type: Vented Supplementary Article/Info 2: with bolts/screws
2.0 TSI 4motion	200 -	08/18→ 206	for PR number: 1KU / 2EA; Vehicle Equipment: for vehicles with electric parking brake; Fitting Position: Rear Axle	24.0112-0210.1 412210	Outer diameter [mm]: 300 Brake Disc Thickness [mm] 12 Minimum thickness [mm] 10 Brake Disc Type: Solid Supplementary Article/Info 2: with bolts/screws
2.0 TDI 4motion 2.0 TSI 4motion	110 - 176 162	05/15→ 07/15→ 07/15→	for PR number: 1ZA / 1ZC / 1ZD / 1ZG / 1ZK / 1ZL; Fitting Position: Front Axle	24.0125-0158.1 425158 24.0325-0158.1 525158	Outer diameter [mm]: 312 Brake Disc Thickness [mm] 25 Minimum thickness [mm] 22 Brake Disc Type: Vented Supplementary Article/Info 2: with bolts/screws Outer diameter [mm]: 312 Brake Disc Thickness [mm] 25 Minimum thickness [mm] 22 Brake Disc Type: Vented Supplementary Article/Info 2: with bolts/screws
			for PR number: 1KU / 2EA; Vehicle Equipment: for vehicles with electric parking brake; Fitting Position: Rear Axle	24.0112-0210.1 412210	Outer diameter [mm]: 300 Brake Disc Thickness [mm] 12 Minimum thickness [mm] 10 Brake Disc Type: Solid Supplementary Article/Info 2: with bolts/screws
 Wheel Speed Sensor					
1.4 TSI 4motion	110	05/15→	Fitting Position: Front Axle Left	24.0711-5273.3 360303	
2.0 TDI 4motion	110 -	05/15→	Fitting Position: Front Axle Right	24.0711-5274.3 360304	
2.0 TSI 4motion	176 162 -	07/15→ 206	Fitting Position: Rear Axle Left	24.0711-5401.3 360330	
			Fitting Position: Rear Axle Right	24.0711-5402.3 360331	
→					





	kW				
VW - PASSAT ALLTRACK B8 Variant (3G5, CB5) 05/15→					
Control Element, parking brake caliper					
1.4 TSI 4motion	110 05/15→		for PR number: 1KU / 1KZ / 2EA; Fitting Position: Rear Axle Left	11.9282-1001.3 250159	Brake System: ATE
2.0 TDI 4motion	110 - 05/15→ 176				
2.0 TSI 4motion	162 - 07/15→ 206		for PR number: 1KU / 1KZ / 2EA; Fitting Position: Rear Axle Right	11.9282-1002.3 250160	Brake System: ATE
VW - PASSAT B3/B4 (3A2, 35I) 02/88→12/97					
Guide Bolt, brake caliper					
2.0 16V	110 01/94→08/96		Required quantity: 2; Fitting Position: Front Axle	2 11.8171-0008.1 990049	Brake System: ATE
2.8 VR6	128 06/91→08/96		Construction year from: 10/93 →; Required quantity: 2; Fitting Position: Front Axle	2 11.8171-0008.1 990049	Brake System: ATE
VW - PASSAT B3/B4 Variant (3A5, 35I) 02/88→06/97					
Guide Bolt, brake caliper					
2.0 16V	110 01/94→05/97		→ Construction year to: 12/96; Required quantity: 2; Fitting Position: Front Axle	2 11.8171-0008.1 990049	Brake System: ATE
2.8 VR6	128 06/91→05/97		Construction year from: 10/93 → → Construction year to: 12/96; Required quantity: 2; Fitting Position: Front Axle	2 11.8171-0008.1 990049	Brake System: ATE
2.9 VR6 Syncro	135 01/94→05/97		Construction year from: 10/94 → → Construction year to: 12/96; Required quantity: 2; Fitting Position: Front Axle	2 11.8171-0008.1 990049	Brake System: ATE
VW - PASSAT B5.5 (3B3) 10/00→12/05					
Guide Bolt, brake caliper					
1.6 1.8 T 1.8 T 20V 1.8 T 4motion	75 11/00→05/05 125 02/01→11/05 110 11/00→05/05 125 11/03→05/05		→ Vehicle Identification Number to: 3B-X-124107; for PR number: 1LB / 1LE / 1ZC; Required quantity: 2; Fitting Position: Front Axle	2 11.8171-0008.1 990049	Brake System: ATE
			Vehicle Identification Number from: 3B-X-124108 →; for PR number: 1LB / 1LE / 1ZC; Required quantity: 2; Fitting Position: Front Axle	2 11.8171-0008.1 990049	Brake System: ATE
1.9 TDI 1.9 TDI 4motion 2.0 2.0 4motion 2.0	74 - 11/00→05/05 96 96 11/00→05/05 85 11/00→05/05 85 11/00→05/05 96 11/01→05/05		for PR number: 1LB / 1LE / 1ZC; Required quantity: 2; Fitting Position: Front Axle	2 11.8171-0008.1 990049	Brake System: ATE
2.0 TDI	100 12/03→05/05		for PR number: 1LT; Required quantity: 2	2 11.8171-0008.1 990049	Brake System: ATE
			for PR number: 1LB / 1LE / 1ZC; Required quantity: 2; Fitting Position: Front Axle	2 11.8171-0008.1 990049	Brake System: ATE
2.3 V5 2.3 V5 4motion 2.8 2.8 4motion	125 11/00→05/05 125 11/00→05/05 140 - 10/00→05/05 142 140 - 10/00→05/05 142		for PR number: 1LT; Required quantity: 2	2 11.8171-0008.1 990049	Brake System: ATE
			→ Vehicle Identification Number to: 3B-X-124107; for PR number: 1LB / 1LE / 1ZC; Required quantity: 2; Fitting Position: Front Axle	2 11.8171-0008.1 990049	Brake System: ATE
2.5 TDI 2.5 TDI 4motion	110 - 11/00→05/05 120 110 - 11/00→05/05 132		for PR number: 1LT; Required quantity: 2	2 11.8171-0008.1 990049	Brake System: ATE
4.0 W8 4motion	202 09/01→09/04		for PR number: 1ZF / 1ZG; Required quantity: 2	2 11.8171-0008.1 990049	Brake System: ATE
VW - PASSAT B5.5 Variant (3B6) 09/00→08/05					
Guide Bolt, brake caliper					
1.6 1.8 T 20V	75 11/00→05/05 110 11/00→05/05		→ Vehicle Identification Number to: 3B-X-124107; for PR number: 1LB / 1LE / 1ZC; Required quantity: 2; Fitting Position: Front Axle	2 11.8171-0008.1 990049	Brake System: ATE
			Vehicle Identification Number from: 3B-X-124108 →; for PR number: 1LB / 1LE / 1ZC;	2 11.8171-0008.1 990049	Brake System: ATE
→					





	kW				
VW - PASSAT B5.5 Variant (3B6) 09/00→08/05					
Guide Bolt, brake caliper					
1.6	75	11/00→05/05	Required quantity: 2;		
1.8 T 20V	110	11/00→05/05	Fitting Position: Front Axle		
1.8 4motion	125	11/03→05/05	for PR number: 1LB / 1LE / 1ZC;	2	11.8171-0008.1 990049 Brake System: ATE
1.9 TDI	74 -	11/00→05/05	Required quantity: 2;		
	96		Fitting Position: Front Axle		
1.9 TDI 4motion	96	11/00→05/05			
2.0	85	11/00→05/05			
2.0 4motion	85	11/00→05/05			
1.8 T	125	05/02→08/05	→ Vehicle Identification Number to: 3B-X-124107;	2	11.8171-0008.1 990049 Brake System: ATE
			for PR number: 1LB / 1LE / 1ZC;		
			Required quantity: 2;		
			Fitting Position: Front Axle		
			Vehicle Identification Number from: 3B-X-124108 →;	2	11.8171-0008.1 990049 Brake System: ATE
			→ Construction year to: 06/05;		
			for PR number: 1LB / 1LE / 1ZC;		
			Required quantity: 2;		
			Fitting Position: Front Axle		
2.0	96	11/01→05/05	Construction year from: 05/02 →;	2	11.8171-0008.1 990049 Brake System: ATE
			for PR number: 1LB / 1LE / 1ZC;		
			Required quantity: 2;		
			Fitting Position: Front Axle		
2.0 TDI	100	12/03→05/05	for PR number: 1LT; Required quantity: 2	2	11.8171-0008.1 990049 Brake System: ATE
			for PR number: 1LB / 1LE / 1ZC;	2	11.8171-0008.1 990049 Brake System: ATE
			Required quantity: 2;		
			Fitting Position: Front Axle		
2.3 VR5	125	11/00→05/05	for PR number: 1LT; Required quantity: 2	2	11.8171-0008.1 990049 Brake System: ATE
2.3 VR5 4motion	125	11/00→05/05			
2.8 4motion	140 -	10/00→05/05	→ Vehicle Identification Number to: 3B-X-124107;	2	11.8171-0008.1 990049 Brake System: ATE
	142		for PR number: 1LB / 1LE / 1ZC;		
			Required quantity: 2;		
			Fitting Position: Front Axle		
2.5 TDI	110 -	11/00→05/05	for PR number: 1LT; Required quantity: 2	2	11.8171-0008.1 990049 Brake System: ATE
	120				
2.5 TDI 4motion	110 -	11/00→05/05			
	132				
2.8	142	10/00→08/05	→ Construction year to: 06/05;	2	11.8171-0008.1 990049 Brake System: ATE
			for PR number: 1LT; Required quantity: 2		
			→ Vehicle Identification Number to: 3B-X-124107;	2	11.8171-0008.1 990049 Brake System: ATE
			for PR number: 1LB / 1LE / 1ZC;		
			Required quantity: 2;		
			Fitting Position: Front Axle		
4.0 W8 4motion	202	09/01→09/04	for PR number: 1ZF / 1ZG;	2	11.8171-0008.1 990049 Brake System: ATE
			Required quantity: 2		
VW - PASSAT B5 (3B2) 08/96→12/01					
Guide Bolt, brake caliper					
1.6	74	10/96→11/00	→ Vehicle Identification Number to: 3B-X-124107;	2	11.8171-0008.1 990049 Brake System: ATE
1.8	92	10/96→11/00			
1.8 Syncro/4motion	92	12/96→08/00	for PR number: 1LB / 1LE / 1ZC;		
1.8 T	110	10/96→11/00	Required quantity: 2;		
1.9 TDI	66 -	10/96→11/00	Fitting Position: Front Axle		
	85		Vehicle Identification Number from: 3B-X-124108 →;	2	11.8171-0008.1 990049 Brake System: ATE
1.9 TDI 4motion	85	08/99→11/00			
1.9 TDI Syncro/4motion	81	06/97→08/00	for PR number: 1LB / 1LE / 1ZC;		
			Required quantity: 2;		
			Fitting Position: Front Axle		
1.9 TDI	74	02/00→11/00	Construction year from: 10/00 →;	2	11.8171-0008.1 990049 Brake System: ATE
2.0	88	04/00→11/00	for PR number: 1LB / 1LE / 1ZC;		
2.0 4motion	88	04/00→11/00	Required quantity: 2;		
			Fitting Position: Front Axle		
2.3 VR5	110	10/96→11/00	Construction year from: 10/00 →;	2	11.8171-0008.1 990049 Brake System: ATE
2.3 VR5 Syncro/4motion	110	10/97→11/00	for PR number: 1LT; Required quantity: 2		
2.8 V6	140 -	08/96→11/00	→ Vehicle Identification Number to: 3B-X-124107;	2	11.8171-0008.1 990049 Brake System: ATE
	142		for PR number: 1LB / 1LE / 1ZC;		
2.8 V6 4motion	140	09/99→11/00	Required quantity: 2;		
2.8 V6 Syncro/4motion	142	10/96→11/00	Fitting Position: Front Axle		
			Vehicle Identification Number from: 3B-X-124108 →;	2	11.8171-0008.1 990049 Brake System: ATE
			→ Construction year to: 09/00;		
			for PR number: 1LB / 1LE / 1ZC;		
			Required quantity: 2;		
			Fitting Position: Front Axle		
2.5 TDI	110	07/98→11/00	Construction year from: 10/00 →;	2	11.8171-0008.1 990049 Brake System: ATE
			for PR number: 1LT; Required quantity: 2		
→					



VW - PASSAT B5 (3B2) 08/96→12/01						
Guide Bolt, brake caliper						
2.5 TDI	110 07/98→11/00	Construction year from: 08/98 → → Construction year to: 09/00; for PR number: 1LB / 1LE / 1ZC; Required quantity: 2; Fitting Position: Front Axle	2	11.8171-0008.1 990049	Brake System: ATE	
2.5 TDI Syncro/4motion	110 12/98→11/00	Construction year from: 10/00 →; for PR number: 1LT; Required quantity: 2	2	11.8171-0008.1 990049	Brake System: ATE	
		→ Construction year to: 09/00; for PR number: 1LB / 1LE / 1ZC; Required quantity: 2; Fitting Position: Front Axle	2	11.8171-0008.1 990049	Brake System: ATE	
2.8 V6	132 05/97→09/99	Vehicle Identification Number from: 3B-X-124108 →; Required quantity: 2; Fitting Position: Front Axle	2	11.8171-0008.1 990049	Brake System: ATE	
		→ Vehicle Identification Number to: 3B-X-124107; Required quantity: 2; Fitting Position: Front Axle	2	11.8171-0008.1 990049	Brake System: ATE	
VW - PASSAT B5 Variant (3B5) 05/97→12/01						
Guide Bolt, brake caliper						
1.6	74 06/97→11/00	→ Vehicle Identification Number to: 3B-X-124107; for PR number: 1LB / 1LE / 1ZC; Required quantity: 2; Fitting Position: Front Axle	2	11.8171-0008.1 990049	Brake System: ATE	
1.8	92 06/97→11/00					
1.8 Syncro/4motion	92 06/97→11/00					
1.8 T	110 05/97→11/00					
1.9 TDI	66 - 06/97→11/00					
	85	Vehicle Identification Number from: 3B-X-124108 →; for PR number: 1LB / 1LE / 1ZC; Required quantity: 2; Fitting Position: Front Axle	2	11.8171-0008.1 990049	Brake System: ATE	
1.9 TDI 4motion	85 08/99→11/00					
1.9 TDI Syncro/4motion	81 06/97→08/00					
1.9 TDI	74 02/00→11/00	Construction year from: 10/00 →; for PR number: 1LB / 1LE / 1ZC; Required quantity: 2; Fitting Position: Front Axle	2	11.8171-0008.1 990049	Brake System: ATE	
2.0	88 04/00→11/00					
2.0 4motion	88 04/00→11/00					
2.3 VR5	110 06/97→11/00	Construction year from: 10/00 →; for PR number: 1LT; Required quantity: 2	2	11.8171-0008.1 990049	Brake System: ATE	
2.3 VR5 Syncro/4motion	110 10/97→11/00					
2.8 V6	140 - 06/97→11/00					
	142	→ Vehicle Identification Number to: 3B-X-124107; for PR number: 1LB / 1LE / 1ZC; Required quantity: 2; Fitting Position: Front Axle	2	11.8171-0008.1 990049	Brake System: ATE	
2.8 V6 4motion	140 09/99→11/00					
2.8 V6 Syncro/4motion	142 06/97→11/00					
		Vehicle Identification Number from: 3B-X-124108 →; → Construction year to: 09/00; for PR number: 1LB / 1LE / 1ZC; Required quantity: 2; Fitting Position: Front Axle	2	11.8171-0008.1 990049	Brake System: ATE	
2.5 TDI	110 07/98→11/00					
		Construction year from: 10/00 →; for PR number: 1LT; Required quantity: 2	2	11.8171-0008.1 990049	Brake System: ATE	
		Construction year from: 08/98 → → Construction year to: 09/00; for PR number: 1LB / 1LE / 1ZC; Required quantity: 2; Fitting Position: Front Axle	2	11.8171-0008.1 990049	Brake System: ATE	
2.5 TDI Syncro/4motion	110 12/98→11/00	Construction year from: 10/00 →; for PR number: 1LT; Required quantity: 2	2	11.8171-0008.1 990049	Brake System: ATE	
		→ Construction year to: 09/00; for PR number: 1LB / 1LE / 1ZC; Required quantity: 2; Fitting Position: Front Axle	2	11.8171-0008.1 990049	Brake System: ATE	
2.8 V6	132 09/97→09/99	Vehicle Identification Number from: 3B-X-124108 →; Required quantity: 2; Fitting Position: Front Axle	2	11.8171-0008.1 990049	Brake System: ATE	
		→ Vehicle Identification Number to: 3B-X-124107; Required quantity: 2; Fitting Position: Front Axle	2	11.8171-0008.1 990049	Brake System: ATE	
VW - PASSAT B6 (3C2) 03/05→12/10						
Guide Bolt, brake caliper						
1.4 TSI	90 05/07→07/10	Construction year from: 10/07 →; for PR number: 1LJ / 1LH / 1ZG / 1ZM; Required quantity: 2	2	11.8171-0008.1 990049	Brake System: ATE	
1.8 TSI	118 05/07→07/10					
		Construction year from: 10/07 →; for PR number: 1LK / 1LM; Required quantity: 2	2	11.8171-0008.1 990049	Brake System: ATE	
1.4 TSI EcoFuel	110 01/09→07/10	for PR number: 1LJ / 1LH / 1ZG / 1ZM; Required quantity: 2	2	11.8171-0008.1 990049	Brake System: ATE	
1.6	75 05/05→07/10					
1.6 FSI	85 03/05→06/08					
→						



		kW									
VW - PASSAT B6 (3C2) 03/05→12/10											
Guide Bolt, brake caliper											
1.6 TDI	77	08/09→07/10	for PR number: 1LK / 1LM; Required quantity: 2	2	11.8171-0008.1 990049	Brake System: ATE					
1.8 TSI	112	11/09→07/10									
1.9 TDI	77	03/05→07/10									
2.0 FSI	110 - 125	03/05→07/10									
2.0 FSI 4motion	110	09/05→07/10									
2.0 TDI	81 - 125	03/05→07/10									
2.0 TDI 16V	103	03/05→07/10									
2.0 TDI 4motion	103 - 125	03/05→07/10									
2.0 TFSI	147	07/05→07/10									
3.2 FSI 4motion	184	11/05→07/10									
3.6 R36 4motion	220	04/07→07/10									
2.0 BlueTDI	105	01/09→11/10					for PR number: 1LJ / 1LH / 1ZG / 1ZM; → Construction year to: 07/10; Required quantity: 2	2	11.8171-0008.1 990049	Brake System: ATE	
2.0 TDI	100	03/05→11/10									
2.0 TDI 16V 4motion	103	03/05→08/10									
			for PR number: 1LK / 1LM; → Construction year to: 07/10; Required quantity: 2	2	11.8171-0008.1 990049	Brake System: ATE					
 Brake Disc											
1.4 TSI	90	05/07→07/10	Construction year from: 10/07 →; for PR number: 1LJ / 1LH / 1ZG / 1ZM; Fitting Position: Front Axle		24.0125-0158.1 425158	Outer diameter [mm]: 312 Brake Disc Thickness [mm] 25 Minimum thickness [mm] 22 Brake Disc Type: Vented Supplementary Article/Info 2: with bolts/screws					
1.8 TSI	118	05/07→07/10									
					24.0325-0158.1 525158	Outer diameter [mm]: 312 Brake Disc Thickness [mm] 25 Minimum thickness [mm] 22 Brake Disc Type: Vented Supplementary Article/Info 2: with bolts/screws					
1.4 TSI EcoFuel	110	01/09→07/10	for PR number: 1LJ / 1LH / 1ZG / 1ZM; Fitting Position: Front Axle		24.0125-0158.1 425158	Outer diameter [mm]: 312 Brake Disc Thickness [mm] 25 Minimum thickness [mm] 22 Brake Disc Type: Vented Supplementary Article/Info 2: with bolts/screws					
1.6	75	05/05→07/10									
1.6 FSI	85	03/05→06/08									
1.6 TDI	77	08/09→07/10									
1.9 TDI	77	03/05→07/10									
2.0 FSI	110	03/05→07/10									
2.0 FSI 4motion	110	09/05→07/10									
2.0 TDI	81 - 125	03/05→07/10									
2.0 TDI 16V	103	03/05→07/10									
2.0 TDI 4motion	103 - 125	03/05→07/10									
2.0 TFSI	147	07/05→07/10									
3.2 FSI 4motion	184	11/05→07/10									
3.6 R36 4motion	220	04/07→07/10									
1.8 TSI	112	11/09→07/10	for PR number: 1LJ / 1LH / 1ZG / 1ZM; Fitting Position: Front Axle		24.0125-0158.1 425158	Outer diameter [mm]: 312 Brake Disc Thickness [mm] 25 Minimum thickness [mm] 22 Brake Disc Type: Vented Supplementary Article/Info 2: with bolts/screws					
2.0 FSI	125	08/07→07/10									
2.0 BlueTDI	105	01/09→11/10	→ Construction year to: 07/10; for PR number: 1LJ / 1LH / 1ZG / 1ZM; Fitting Position: Front Axle		24.0125-0158.1 425158	Outer diameter [mm]: 312 Brake Disc Thickness [mm] 25 Minimum thickness [mm] 22 Brake Disc Type: Vented Supplementary Article/Info 2: with bolts/screws					
2.0 TDI	100	03/05→11/10									
2.0 TDI 16V 4motion	103	03/05→08/10									
					24.0325-0158.1 525158	Outer diameter [mm]: 312 Brake Disc Thickness [mm] 25 Minimum thickness [mm] 22 Brake Disc Type: Vented Supplementary Article/Info 2: with bolts/screws					
VW - PASSAT B6 Variant (3C5) 08/05→11/11											
Guide Bolt, brake caliper											
1.4 TSI	90	05/07→11/10	Construction year from: 10/07 → → Construction year to: 07/10; for PR number: 1LJ / 1LH / 1ZG / 1ZM; Required quantity: 2	2	11.8171-0008.1 990049	Brake System: ATE					
1.8 TSI	118	05/07→10/11									
			Construction year from: 10/07 → → Construction year to: 07/10; for PR number: 1LK / 1LM; Required quantity: 2	2	11.8171-0008.1 990049	Brake System: ATE					
→											



	kW				
VW - PASSAT B6 Variant (3C5) 08/05→11/11					
Guide Bolt, brake caliper					
1.4 TSI EcoFuel 1.6 1.6 TDI 1.8 TSI 2.0 BlueTDI 2.0 FSI 2.0 FSI 4motion 2.0 TDI	110 01/09→11/10 75 08/05→11/10 77 08/09→11/10 112 11/09→11/10 105 01/09→11/10 110 08/05→11/10 110 09/05→11/10 81 - 08/05→11/10 125	→ Construction year to: 07/10; for PR number: 1LJ / 1LH / 1ZG / 1ZM; Required quantity: 2	2	11.8171-0008.1 990049	Brake System: ATE
2.0 TDI 16V 2.0 TDI 4motion 2.0 TFSI 3.2 FSI 4motion 3.6 R36 4motion	103 08/05→11/10 125 05/09→11/10 147 08/05→11/10 184 11/05→11/10 220 04/07→11/10	→ Construction year to: 07/10; for PR number: 1LK / 1LM; Required quantity: 2	2	11.8171-0008.1 990049	Brake System: ATE
1.6 FSI 1.9 TDI 2.0 TDI	85 08/05→06/08 77 08/05→11/10 88 - 08/05→05/09 120	for PR number: 1LJ / 1LH / 1ZG / 1ZM; Required quantity: 2	2	11.8171-0008.1 990049	Brake System: ATE
2.0 TDI 16V 4motion	103 08/05→11/10	for PR number: 1LK / 1LM; Required quantity: 2	2	11.8171-0008.1 990049	Brake System: ATE
		Construction year from: 09/05 → → Construction year to: 07/10; for PR number: 1LJ / 1LH / 1ZG / 1ZM; Required quantity: 2	2	11.8171-0008.1 990049	Brake System: ATE
		Construction year from: 09/05 → → Construction year to: 07/10; for PR number: 1LK / 1LM; Required quantity: 2	2	11.8171-0008.1 990049	Brake System: ATE
2.0 TDI 4motion	103 08/05→05/09	Construction year from: 09/05 →; for PR number: 1LJ / 1LH / 1ZG / 1ZM; Required quantity: 2	2	11.8171-0008.1 990049	Brake System: ATE
		Construction year from: 09/05 →; for PR number: 1LK / 1LM; Required quantity: 2	2	11.8171-0008.1 990049	Brake System: ATE
 Brake Disc					
1.4 TSI 1.8 TSI	90 05/07→11/10 118 05/07→10/11	Construction year from: 10/07 → → Construction year to: 07/10; for PR number: 1LJ / 1LH / 1ZG / 1ZM; Fitting Position: Front Axle		24.0125-0158.1 425158	Outer diameter [mm]: 312 Brake Disc Thickness [mm] 25 Minimum thickness [mm] 22 Brake Disc Type: Vented Supplementary Article/Info 2: with bolts/screws
				24.0325-0158.1 525158	Outer diameter [mm]: 312 Brake Disc Thickness [mm] 25 Minimum thickness [mm] 22 Brake Disc Type: Vented Supplementary Article/Info 2: with bolts/screws
1.4 TSI EcoFuel 1.6 1.6 TDI 2.0 BlueTDI 2.0 FSI 2.0 FSI 4motion 2.0 TDI	110 01/09→11/10 75 08/05→11/10 77 08/09→11/10 105 01/09→11/10 110 08/05→11/10 110 09/05→11/10 81 - 08/05→11/10 125	→ Construction year to: 07/10; for PR number: 1LJ / 1LH / 1ZG / 1ZM; Fitting Position: Front Axle		24.0125-0158.1 425158	Outer diameter [mm]: 312 Brake Disc Thickness [mm] 25 Minimum thickness [mm] 22 Brake Disc Type: Vented Supplementary Article/Info 2: with bolts/screws
2.0 TDI 16V 2.0 TDI 4motion 2.0 TFSI 3.2 FSI 4motion 3.6 R36 4motion	103 08/05→11/10 125 05/09→11/10 147 08/05→11/10 184 11/05→11/10 220 04/07→11/10			24.0325-0158.1 525158	Outer diameter [mm]: 312 Brake Disc Thickness [mm] 25 Minimum thickness [mm] 22 Brake Disc Type: Vented Supplementary Article/Info 2: with bolts/screws
1.6 FSI 1.9 TDI 2.0 TDI	85 08/05→06/08 77 08/05→11/10 88 - 08/05→05/09 120	for PR number: 1LJ / 1LH / 1ZG / 1ZM; Fitting Position: Front Axle		24.0125-0158.1 425158	Outer diameter [mm]: 312 Brake Disc Thickness [mm] 25 Minimum thickness [mm] 22 Brake Disc Type: Vented Supplementary Article/Info 2: with bolts/screws
				24.0325-0158.1 525158	Outer diameter [mm]: 312 Brake Disc Thickness [mm] 25 Minimum thickness [mm] 22 Brake Disc Type: Vented Supplementary Article/Info 2: with bolts/screws
1.8 TSI	112 11/09→11/10	→ Construction year to: 07/10; for PR number: 1LJ / 1LH / 1ZG / 1ZM; Fitting Position: Front Axle		24.0125-0158.1 425158	Outer diameter [mm]: 312 Brake Disc Thickness [mm] 25 Minimum thickness [mm] 22 Brake Disc Type: Vented Supplementary Article/Info 2: with bolts/screws
→					



	kW				
VW - PASSAT B7 (362) 08/10→12/15					
 Wheel Speed Sensor					
3.6 FSI 4motion	220	01/11→12/14	→ Construction year to: 10/14; Fitting Position: Rear Axle Right	24.0711-5402.3	360331
2.0 TDI 4motion	125	08/10→01/13	Fitting Position: Rear Axle Left	24.0711-5401.3	360330
			Fitting Position: Rear Axle Right	24.0711-5402.3	360331
VW - PASSAT B7 (A32, A33) 01/11→					
Guide Bolt, brake caliper					
2.0 TDI 2.5	103 125	04/11→06/15 01/11→	→ Construction year to: 10/14; for PR number: 1ZM / 1ZG; Required quantity: 2	2 11.8171-0008.1	990049 Brake System: ATE
2.0 TDI	110	06/14→	for PR number: 1ZM / 1ZG; Required quantity: 2	2 11.8171-0008.1	990049 Brake System: ATE
 Brake Disc					
2.0 TDI 2.5	103 125	04/11→06/15 01/11→	→ Construction year to: 10/14; for PR number: 1ZM / 1ZG; Fitting Position: Front Axle	24.0125-0158.1	425158 Outer diameter [mm]: 312 Brake Disc Thickness [mm] 25 Minimum thickness [mm] 22 Brake Disc Type: Vented Supplementary Article/Info 2: with bolts/screws
2.0 TDI	110	06/14→	for PR number: 1ZM / 1ZG; Fitting Position: Front Axle	24.0125-0158.1	425158 Outer diameter [mm]: 312 Brake Disc Thickness [mm] 25 Minimum thickness [mm] 22 Brake Disc Type: Vented Supplementary Article/Info 2: with bolts/screws
VW - PASSAT B7 Estate Van (365) 08/10→12/14					
Guide Bolt, brake caliper					
1.4 TSi BlueMotion 1.6 TDi BlueMotion 1.8 TFSi 2.0 TDi BlueMotion 2.0 TFSi 3.6 FSi 4motion	90 77 118 103 155 220	08/10→12/14 08/10→12/14 08/10→12/14 08/10→12/14 11/10→12/14 01/11→12/14	→ Construction year to: 10/14; for PR number: 1ZM / 1ZG; Required quantity: 2	2 11.8171-0008.1	990049 Brake System: ATE
2.0 TDi BlueMotion	125	08/10→12/14	for PR number: 1ZM / 1ZG; Required quantity: 2	2 11.8171-0008.1	990049 Brake System: ATE
 Brake Disc					
1.4 TSi BlueMotion 1.6 TDi BlueMotion 1.8 TFSi 2.0 TDi BlueMotion 2.0 TFSi 3.6 FSi 4motion	90 77 118 103 155 220	08/10→12/14 08/10→12/14 08/10→12/14 08/10→12/14 11/10→12/14 01/11→12/14	→ Construction year to: 10/14; for PR number: 1ZM / 1ZG; Fitting Position: Front Axle	24.0125-0158.1	425158 Outer diameter [mm]: 312 Brake Disc Thickness [mm] 25 Minimum thickness [mm] 22 Brake Disc Type: Vented Supplementary Article/Info 2: with bolts/screws
2.0 TDi BlueMotion	125	08/10→12/14	for PR number: 1ZM / 1ZG; Fitting Position: Front Axle	24.0125-0158.1	425158 Outer diameter [mm]: 312 Brake Disc Thickness [mm] 25 Minimum thickness [mm] 22 Brake Disc Type: Vented Supplementary Article/Info 2: with bolts/screws
 Wheel Speed Sensor					
2.0 TDi BlueMotion 3.6 FSi 4motion	103 220	08/10→12/14 01/11→12/14	→ Construction year to: 10/14; Fitting Position: Rear Axle Left	24.0711-5401.3	360330
			→ Construction year to: 10/14; Fitting Position: Rear Axle Right	24.0711-5402.3	360331
2.0 TDi BlueMotion	125	08/10→12/14	Fitting Position: Rear Axle Left	24.0711-5401.3	360330
			Fitting Position: Rear Axle Right	24.0711-5402.3	360331
VW - PASSAT B7 Variant (365) 08/10→12/15					
Guide Bolt, brake caliper					
1.4 TSI 1.4 TSI EcoFuel 1.4 TSI MultiFuel 1.6 TDI 1.8 TSI 2.0 TDI 2.0 TDI 4motion 2.0 TSI 3.6 FSI 4motion	90 118 110 118 77 112 118 100 130 103 130 155 220	08/10→12/14 08/10→12/14 11/10→12/14 08/10→12/14 08/10→12/14 08/10→12/14 08/10→12/14 11/10→12/15 01/11→12/14	→ Construction year to: 10/14; for PR number: 1ZM / 1ZG; Required quantity: 2	2 11.8171-0008.1	990049 Brake System: ATE



	kW				
VW - PASSAT B7 Variant (365) 08/10→12/15					
Guide Bolt, brake caliper					
2.0 TDI 4motion	125	08/10→01/13	for PR number: 1ZM / 1ZG; Required quantity: 2	2	11.8171-0008.1 990049 Brake System: ATE
 Brake Disc					
1.4 TSI	90	08/10→12/14	→ Construction year to: 10/14; for PR number: 1ZM / 1ZG; Fitting Position: Front Axle		24.0125-0158.1 425158 Outer diameter [mm]: 312 Brake Disc Thickness [mm] 25 Minimum thickness [mm] 22 Brake Disc Type: Vented Supplementary Article/Info 2: with bolts/screws
1.4 TSI EcoFuel	118	11/10→12/14			
1.4 TSI MultiFuel	118	11/10→12/14			
1.6 TDI	77	08/10→12/14			
1.8 TSI	118	08/10→12/14			
2.0 TDI	100	08/10→12/14			
2.0 TDI 4motion	130	08/10→12/14			
2.0 TDI 4motion	103	08/10→12/14			24.0325-0158.1 525158 Outer diameter [mm]: 312 Brake Disc Thickness [mm] 25 Minimum thickness [mm] 22 Brake Disc Type: Vented Supplementary Article/Info 2: with bolts/screws
2.0 TSI	155	11/10→12/15			
3.6 FSI 4motion	220	01/11→12/14			
1.8 TSI	112	02/11→12/14	→ Construction year to: 10/14; for PR number: 1ZM / 1ZG; Fitting Position: Front Axle		24.0125-0158.1 425158 Outer diameter [mm]: 312 Brake Disc Thickness [mm] 25 Minimum thickness [mm] 22 Brake Disc Type: Vented Supplementary Article/Info 2: with bolts/screws
2.0 TDI 4motion	125	08/10→01/13	for PR number: 1ZM / 1ZG; Fitting Position: Front Axle		24.0125-0158.1 425158 Outer diameter [mm]: 312 Brake Disc Thickness [mm] 25 Minimum thickness [mm] 22 Brake Disc Type: Vented Supplementary Article/Info 2: with bolts/screws
					24.0325-0158.1 525158 Outer diameter [mm]: 312 Brake Disc Thickness [mm] 25 Minimum thickness [mm] 22 Brake Disc Type: Vented Supplementary Article/Info 2: with bolts/screws
 Wheel Speed Sensor					
2.0 TDI 4motion	103	08/10→12/14	→ Construction year to: 10/14; Fitting Position: Rear Axle Left		24.0711-5401.3 360330
3.6 FSI 4motion	220	01/11→12/14			
2.0 TDI 4motion	125	08/10→01/13	Fitting Position: Rear Axle Left		24.0711-5401.3 360330
			Fitting Position: Rear Axle Right		24.0711-5402.3 360331
VW - PASSAT B8 (3G2, CB2) 08/14→					
 Brake Caliper					
1.4 GTE Hybrid	115	06/15→11/18	for PR number: 1ZA / 1ZD / 1ZK / 1ZL; Fitting Position: Front Axle Left		24.3571-1801.5 241387 Supplementary Article/Supplementary Info: without holder Brake Caliper Type: Fist-type Caliper
1.4 TSI	92	11/14→			
1.4 TSI 4motion	110	02/15→	for PR number: 1ZA / 1ZD / 1ZK / 1ZL; Fitting Position: Front Axle Right		24.3571-1802.5 241388 Supplementary Article/Supplementary Info: without holder Brake Caliper Type: Fist-type Caliper
1.5 TSI	110	08/18→			
1.8 TSI	132	02/15→			
2.0 TDI	81	11/14→			
2.0 TDI 4motion	147	11/14→			
2.0 TDI 4motion	140	11/14→			
2.0 TSI	162	02/15→			
2.0 TSI 4motion	200	05/15→			
2.0 TSI 4motion	206	05/15→			
1.6 TDI	88	08/14→	Construction year from: 11/14 →; for PR number: 1ZA / 1ZD / 1ZK / 1ZL; Fitting Position: Front Axle Left		24.3571-1801.5 241387 Supplementary Article/Supplementary Info: without holder Brake Caliper Type: Fist-type Caliper
2.0 TDI 4motion	176	08/14→			
			Construction year from: 11/14 →; for PR number: 1ZA / 1ZD / 1ZK / 1ZL; Fitting Position: Front Axle Right		24.3571-1802.5 241388 Supplementary Article/Supplementary Info: without holder Brake Caliper Type: Fist-type Caliper
 Brake Disc					
1.4 GTE Hybrid	115	06/15→11/18	for PR number: 1ZA / 1ZC / 1ZD / 1ZG / 1ZK / 1ZL; Fitting Position: Front Axle		24.0125-0158.1 425158 Outer diameter [mm]: 312 Brake Disc Thickness [mm] 25 Minimum thickness [mm] 22 Brake Disc Type: Vented Supplementary Article/Info 2: with bolts/screws
1.4 TSI	92	11/14→			
1.4 TSI 4motion	110	02/15→			
1.5 TSI	110	08/18→			
1.6 TDI	88	08/14→			
1.8 TSI	132	02/15→			
→					



	kW				
VW - PASSAT B8 (3G2, CB2) 08/14→					
 Brake Disc					
2.0 TDI	81 - 11/14→ 147	for PR number: 1ZA / 1ZC / 1ZD / 1ZG / 1ZK / 1ZL; Fitting Position: Front Axle		24.0325-0158.1 525158	Outer diameter [mm]: 312 Brake Disc Thickness [mm] 25 Minimum thickness [mm] 22 Brake Disc Type: Vented Supplementary Article/Info 2: with bolts/screws
2.0 TDI 4motion	110 - 08/14→ 176				
2.0 TSI	140 - 02/15→ 162				
2.0 TSI 4motion	200 - 05/15→ 206				
		for PR number: 1KU / 2EA; Vehicle Equipment: for vehicles with electric parking brake; Fitting Position: Rear Axle		24.0112-0210.1 412210	Outer diameter [mm]: 300 Brake Disc Thickness [mm] 12 Minimum thickness [mm] 10 Brake Disc Type: Solid Supplementary Article/Info 2: with bolts/screws
2.0 TDI	135 07/15→	for PR number: 1ZA / 1ZC / 1ZD / 1ZG / 1ZK / 1ZL; Fitting Position: Front Axle		24.0125-0158.1 425158	Outer diameter [mm]: 312 Brake Disc Thickness [mm] 25 Minimum thickness [mm] 22 Brake Disc Type: Vented Supplementary Article/Info 2: with bolts/screws
		for PR number: 1KU / 2EA; Vehicle Equipment: for vehicles with electric parking brake; Fitting Position: Rear Axle		24.0112-0210.1 412210	Outer diameter [mm]: 300 Brake Disc Thickness [mm] 12 Minimum thickness [mm] 10 Brake Disc Type: Solid Supplementary Article/Info 2: with bolts/screws
 Wheel Speed Sensor					
1.4 GTE Hybrid	115 06/15→11/18	Fitting Position: Front Axle Left		24.0711-5273.3 360303	
1.4 TSI	92 - 11/14→ 110	Fitting Position: Front Axle Right		24.0711-5274.3 360304	
1.5 TSI	110 08/18→	Required quantity: 2; Fitting Position: Rear Axle		2 24.0711-6337.3 360390	
1.6 TDI	88 08/14→				
1.8 TSI	132 02/15→				
2.0 TDI	81 - 11/14→ 140				
2.0 TSI	162 02/15→				
1.4 TSI 4motion	110 02/15→	Fitting Position: Front Axle Left		24.0711-5273.3 360303	
2.0 TDI 4motion	110 - 08/14→ 140	Fitting Position: Front Axle Right		24.0711-5274.3 360304	
2.0 TSI 4motion	200 - 05/15→ 206	Fitting Position: Rear Axle Left		24.0711-5401.3 360330	
		Construction year from: 12/19 →; Fitting Position: Rear Axle Left		24.0711-5401.3 360330	
		Fitting Position: Rear Axle Right		24.0711-5402.3 360331	
		Construction year from: 12/19 →; Fitting Position: Rear Axle Right		24.0711-5402.3 360331	
2.0 TDI	90 - 07/20→ 147	Fitting Position: Front Axle Left		24.0711-5273.3 360303	
2.0 TDI 4motion	147 08/20→	Fitting Position: Front Axle Right		24.0711-5274.3 360304	
2.0 TSI	140 11/18→	Fitting Position: Rear Axle Left		24.0711-5401.3 360330	
		Fitting Position: Rear Axle Right		24.0711-5402.3 360331	
2.0 TDI 4motion	176 08/14→	Fitting Position: Front Axle Left		24.0711-5273.3 360303	
		Fitting Position: Front Axle Right		24.0711-5274.3 360304	
		Construction year from: 11/14 →; Fitting Position: Rear Axle Left		24.0711-5401.3 360330	
		Construction year from: 12/19 →; Fitting Position: Rear Axle Left		24.0711-5401.3 360330	
		Construction year from: 12/19 →; Fitting Position: Rear Axle Right		24.0711-5402.3 360331	
		Construction year from: 11/14 →; Fitting Position: Rear Axle Right		24.0711-5402.3 360331	
Control Element, parking brake caliper					
1.4 GTE Hybrid	115 06/15→11/18	for PR number: 1KU / 1KZ / 2EA; Fitting Position: Rear Axle Left		11.9282-1001.3 250159	Brake System: ATE
1.4 TSI	92 - 11/14→ 110				
1.4 TSI 4motion	110 02/15→	for PR number: 1KU / 1KZ / 2EA; Fitting Position: Rear Axle Right		11.9282-1002.3 250160	Brake System: ATE
1.5 TSI	110 08/18→				
1.6 TDI	88 08/14→				
1.8 TSI	132 02/15→				
2.0 TDI	81 - 11/14→ 147				
2.0 TDI 4motion	110 - 08/14→ 176				
2.0 TSI	140 - 02/15→ 162				
2.0 TSI 4motion	200 - 05/15→ 206				





	kW				
VW - PASSAT B8 Variant (3G5, CB5) 08/14→					
 Brake Caliper					
1.4 GTE Hybrid 1.4 TSI	115 06/15→ 92 - 11/14→ 110	for PR number: 1ZA / 1ZD / 1ZK / 1ZL; Fitting Position: Front Axle Left	24.3571-1801.5 241387	Supplementary Article/Supplementary Info: without holder Brake Caliper Type: Fist-type Caliper	
1.4 TSI 4motion 1.5 TSI 1.8 TSI 2.0 TDI	110 02/15→ 110 08/18→ 132 02/15→ 81 - 11/14→ 147	for PR number: 1ZA / 1ZD / 1ZK / 1ZL; Fitting Position: Front Axle Right	24.3571-1802.5 241388	Supplementary Article/Supplementary Info: without holder Brake Caliper Type: Fist-type Caliper	
2.0 TDI 4motion 2.0 TSI 2.0 TSI 4motion	140 - 11/14→ 147 140 11/18→ 200 - 05/15→ 206				
1.6 TDI 2.0 TDI 4motion	88 08/14→ 110 - 08/14→ 176	Construction year from: 11/14 →; for PR number: 1ZA / 1ZD / 1ZK / 1ZL; Fitting Position: Front Axle Left	24.3571-1801.5 241387	Supplementary Article/Supplementary Info: without holder Brake Caliper Type: Fist-type Caliper	
2.0 TSI	162 08/14→	Construction year from: 11/14 →; for PR number: 1ZA / 1ZD / 1ZK / 1ZL; Fitting Position: Front Axle Right	24.3571-1802.5 241388	Supplementary Article/Supplementary Info: without holder Brake Caliper Type: Fist-type Caliper	
 Brake Disc					
1.4 GTE Hybrid 1.4 TSI	115 06/15→ 92 - 11/14→ 110	for PR number: 1ZA / 1ZC / 1ZD / 1ZG / 1ZK / 1ZL; Fitting Position: Front Axle	24.0125-0158.1 425158	Outer diameter [mm]: 312 Brake Disc Thickness [mm] 25 Minimum thickness [mm] 22 Brake Disc Type: Vented Supplementary Article/Info 2: with bolts/screws	
1.4 TSI 4motion 1.5 TSI 1.6 TDI 1.8 TSI 2.0 TDI	110 02/15→ 110 08/18→ 88 08/14→ 132 02/15→ 90 - 11/14→ 147		24.0325-0158.1 525158	Outer diameter [mm]: 312 Brake Disc Thickness [mm] 25 Minimum thickness [mm] 22 Brake Disc Type: Vented Supplementary Article/Info 2: with bolts/screws	
2.0 TDI 4motion 2.0 TSI 2.0 TSI 4motion	110 - 08/14→ 176 140 - 08/14→ 162 200 - 05/15→ 206	for PR number: 1KU / 2EA; Vehicle Equipment: for vehicles with electric parking brake; Fitting Position: Rear Axle	24.0112-0210.1 412210	Outer diameter [mm]: 300 Brake Disc Thickness [mm] 12 Minimum thickness [mm] 10 Brake Disc Type: Solid Supplementary Article/Info 2: with bolts/screws	
2.0 TDI	81 - 07/15→ 135	for PR number: 1ZA / 1ZC / 1ZD / 1ZG / 1ZK / 1ZL; Fitting Position: Front Axle	24.0125-0158.1 425158	Outer diameter [mm]: 312 Brake Disc Thickness [mm] 25 Minimum thickness [mm] 22 Brake Disc Type: Vented Supplementary Article/Info 2: with bolts/screws	
		for PR number: 1KU / 2EA; Vehicle Equipment: for vehicles with electric parking brake; Fitting Position: Rear Axle	24.0112-0210.1 412210	Outer diameter [mm]: 300 Brake Disc Thickness [mm] 12 Minimum thickness [mm] 10 Brake Disc Type: Solid Supplementary Article/Info 2: with bolts/screws	
 Wheel Speed Sensor					
1.4 GTE Hybrid 1.4 TSI	115 06/15→ 92 - 11/14→ 110	Fitting Position: Front Axle Left	24.0711-5273.3 360303		
		Fitting Position: Front Axle Right	24.0711-5274.3 360304		
1.5 TSI 1.6 TDI 1.8 TSI 2.0 TDI	110 08/18→ 88 08/14→ 132 02/15→ 81 - 11/14→ 140	Required quantity: 2; Fitting Position: Rear Axle	2 24.0711-6337.3 360390		
2.0 TSI	162 08/14→				
1.4 TSI 4motion 2.0 TDI 4motion	110 02/15→ 110 - 08/14→ 140	Fitting Position: Front Axle Left	24.0711-5273.3 360303		
		Fitting Position: Front Axle Right	24.0711-5274.3 360304		
2.0 TSI 4motion	200 - 05/15→ 206	Fitting Position: Rear Axle Left	24.0711-5401.3 360330		
		Construction year from: 12/19 →; Fitting Position: Rear Axle Left	24.0711-5401.3 360330		
		Fitting Position: Rear Axle Right	24.0711-5402.3 360331		
		Construction year from: 12/19 →; Fitting Position: Rear Axle Right	24.0711-5402.3 360331		
2.0 TDI	90 - 07/20→ 147	Fitting Position: Front Axle Left	24.0711-5273.3 360303		
2.0 TDI 4motion	147 08/20→	Fitting Position: Front Axle Right	24.0711-5274.3 360304		
2.0 TSI	140 11/18→	Fitting Position: Rear Axle Left	24.0711-5401.3 360330		
		Fitting Position: Rear Axle Right	24.0711-5402.3 360331		
→					

	kW				
VW - PASSAT B8 Variant (3G5, CB5) 08/14→					
 Wheel Speed Sensor					
2.0 TDI 4motion	176 08/14→		Fitting Position: Front Axle Left	24.0711-5273.3	360303
			Fitting Position: Front Axle Right	24.0711-5274.3	360304
			Construction year from: 12/19 →; Fitting Position: Rear Axle Left	24.0711-5401.3	360330
			Construction year from: 11/14 →; Fitting Position: Rear Axle Left	24.0711-5401.3	360330
			Construction year from: 11/14 →; Fitting Position: Rear Axle Right	24.0711-5402.3	360331
			Construction year from: 12/19 →; Fitting Position: Rear Axle Right	24.0711-5402.3	360331
Control Element, parking brake caliper					
1.4 GTE Hybrid	115 06/15→		for PR number: 1KU / 1KZ / 2EA; Fitting Position: Rear Axle Left	11.9282-1001.3	250159 Brake System: ATE
1.4 TSI	92 - 11/14→ 110		for PR number: 1KU / 1KZ / 2EA; Fitting Position: Rear Axle Right	11.9282-1002.3	250160 Brake System: ATE
1.4 TSI 4motion	110 02/15→				
1.5 TSI	110 08/18→				
1.6 TDI	88 08/14→				
1.8 TSI	132 02/15→				
2.0 TDI	81 - 11/14→ 147				
2.0 TDI 4motion	110 - 08/14→ 176				
2.0 TSI	140 - 08/14→ 162				
2.0 TSI 4motion	200 - 05/15→ 206				
VW - PASSAT CC B6 (357) 02/08→01/12					
Guide Bolt, brake caliper					
1.4 TSI MultiFuel	118 01/11→01/12		→ Construction year to: 09/11; for PR number: 1LH / 1ZM / 1ZG; Required quantity: 2	2	11.8171-0008.1 990049 Brake System: ATE
1.8 TSI	118 06/08→01/12				
2.0 TDI	103 - 06/08→01/12 125		→ Construction year to: 09/11; for PR number: 1LK; Required quantity: 2	2	11.8171-0008.1 990049 Brake System: ATE
2.0 TDI 4motion	103 - 08/09→01/12 125				
2.0 TFSI	147 06/08→01/12				
2.0 TSI	155 11/10→01/12				
3.6 FSI 4motion	206 06/08→01/12				
1.8 TSI	112 11/08→05/10		for PR number: 1LH / 1ZM / 1ZG; Required quantity: 2	2	11.8171-0008.1 990049 Brake System: ATE
2.0 BlueTDI	105 05/09→11/10				
2.0 TDI	100 - 05/08→05/11 120		for PR number: 1LK; Required quantity: 2	2	11.8171-0008.1 990049 Brake System: ATE
3.6 FSI 4motion	220 02/08→12/11				
 Brake Disc					
1.4 TSI MultiFuel	118 01/11→01/12		→ Construction year to: 09/11; for PR number: 1LH / 1ZM / 1ZG; Fitting Position: Front Axle	24.0125-0158.1	425158 Outer diameter [mm]: 312 Brake Disc Thickness [mm] 25 Minimum thickness [mm] 22 Brake Disc Type: Vented Supplementary Article/Info 2: with bolts/screws
1.8 TSI	118 06/08→01/12				
2.0 TDI	103 - 06/08→01/12 125				
2.0 TDI 4motion	103 - 08/09→01/12 125				
2.0 TFSI	147 06/08→01/12			24.0325-0158.1	525158 Outer diameter [mm]: 312 Brake Disc Thickness [mm] 25 Minimum thickness [mm] 22 Brake Disc Type: Vented Supplementary Article/Info 2: with bolts/screws
2.0 TSI	155 11/10→01/12				
1.8 TSI	112 11/08→05/10		for PR number: 1LH / 1ZM / 1ZG; Fitting Position: Front Axle	24.0125-0158.1	425158 Outer diameter [mm]: 312 Brake Disc Thickness [mm] 25 Minimum thickness [mm] 22 Brake Disc Type: Vented Supplementary Article/Info 2: with bolts/screws
2.0 TDI	120 05/08→05/11				
2.0 BlueTDI	105 05/09→11/10		for PR number: 1LH / 1ZM / 1ZG; Fitting Position: Front Axle	24.0125-0158.1	425158 Outer diameter [mm]: 312 Brake Disc Thickness [mm] 25 Minimum thickness [mm] 22 Brake Disc Type: Vented Supplementary Article/Info 2: with bolts/screws
2.0 TDI	100 06/08→05/11				
3.6 FSI 4motion	220 02/08→12/11			24.0325-0158.1	525158 Outer diameter [mm]: 312 Brake Disc Thickness [mm] 25 Minimum thickness [mm] 22 Brake Disc Type: Vented Supplementary Article/Info 2: with bolts/screws
→					

	kW				
VW - PASSAT CC B6 (357) 02/08→01/12					
 Brake Disc					
3.6 FSI 4motion	206	06/08→01/12	→ Construction year to: 09/11; for PR number: 1LH / 1ZM / 1ZG; Fitting Position: Front Axle	24.0125-0158.1 425158	Outer diameter [mm]: 312 Brake Disc Thickness [mm] 25 Minimum thickness [mm] 22 Brake Disc Type: Vented Supplementary Article/Info 2: with bolts/screws
VW - POLO (9N_, 9A_) 10/01→10/14					
Guide Bolt, brake caliper					
1.2	40	01/02→05/07	for PR number: 1LJ; Required quantity: 2	2	11.8171-0008.1 990049 Brake System: ATE
1.4 FSI	63	02/02→07/06			
1.6	74	08/02→05/05			
1.6 Flex	74	06/08→04/09			
1.2	44	05/07→11/09	→ Construction year to: 05/09;	2	11.8171-0008.1 990049 Brake System: ATE
1.2 12V	51	05/07→11/09	for PR number: 1LJ; Required quantity: 2		
1.4 16V	59	05/06→11/09			
1.4 BiFuel	60	05/06→11/09			
1.4 TDI	51 -	04/05→11/09			
	59				
1.6 16V	77	05/06→11/09			
1.8 GTI	110	09/05→11/09			
1.9 TDI	96	11/03→11/09			
1.2 12V	47	10/01→07/07	Construction year from: 11/01 →;	2	11.8171-0008.1 990049 Brake System: ATE
1.4 16V	55 -	10/01→05/08	for PR number: 1LJ; Required quantity: 2		
	74				
1.4 TDI	55	10/01→06/05			
1.4	61	08/02→11/09	Construction year from: 05/06 → → Construction year to: 05/09; for PR number: 1LJ; Required quantity: 2	2	11.8171-0008.1 990049 Brake System: ATE
1.8 GTI Cup Edition	132	05/06→11/09	Construction year from: 06/06 → → Construction year to: 05/09; for PR number: 1LJ; Required quantity: 2	2	11.8171-0008.1 990049 Brake System: ATE
1.9 SDI	47	10/01→11/09	Construction year from: 11/01 → →	2	11.8171-0008.1 990049 Brake System: ATE
1.9 TDI	74	10/01→11/09	Construction year to: 05/09; for PR number: 1LJ; Required quantity: 2		
 Wheel Speed Sensor					
1.2	40	01/02→05/07	Fitting Position: Front Axle Left		24.0711-5273.3 360303
1.4 FSI	63	02/02→07/06	Fitting Position: Front Axle Right		24.0711-5274.3 360304
1.6	74	08/02→05/05			
1.6 Flex	74	06/08→04/09			
1.2	44	05/07→11/09	→ Construction year to: 05/09;		24.0711-5273.3 360303
1.2 12V	51	05/07→11/09	Fitting Position: Front Axle Left		
1.4 16V	59	05/06→11/09	→ Construction year to: 05/09;		24.0711-5274.3 360304
1.4 BiFuel	60	05/06→11/09	Fitting Position: Front Axle Right		
1.4 TDI	51 -	04/05→11/09			
	59				
1.6 16V	77	05/06→11/09			
1.8 GTI	110	09/05→11/09			
1.9 TDI	96	11/03→11/09			
1.2 12V	47	10/01→07/07	Construction year from: 11/01 →;		24.0711-5273.3 360303
1.4 16V	55 -	10/01→05/08	Fitting Position: Front Axle Left		
	74				
1.4 TDI	55	10/01→06/05	Construction year from: 11/01 →;		24.0711-5274.3 360304
			Fitting Position: Front Axle Right		
1.4	61	08/02→11/09	Construction year from: 05/06 → → Construction year to: 05/09; Fitting Position: Front Axle Left		24.0711-5273.3 360303
			Construction year from: 05/06 → → Construction year to: 05/09; Fitting Position: Front Axle Right		24.0711-5274.3 360304
1.8 GTI Cup Edition	132	05/06→11/09	Construction year from: 06/06 → → Construction year to: 05/09; Fitting Position: Front Axle Left		24.0711-5273.3 360303
			Construction year from: 06/06 → → Construction year to: 05/09; Fitting Position: Front Axle Right		24.0711-5274.3 360304
1.9 SDI	47	10/01→11/09	Construction year from: 11/01 → →		24.0711-5273.3 360303
1.9 TDI	74	10/01→11/09	Construction year to: 05/09; Fitting Position: Front Axle Left		
			Construction year from: 11/01 → → Construction year to: 05/09; Fitting Position: Front Axle Right		24.0711-5274.3 360304
VW - POLO IV Saloon (9A4, 9A2, 9N2, 9A6) 09/02→					
Guide Bolt, brake caliper					
1.0	58	02/03→10/03	for PR number: 1LJ; Required quantity: 2	2	11.8171-0008.1 990049 Brake System: ATE
1.4	74	11/03→06/05			
1.4 TDI	55	07/03→06/05			
→					

	kW				
VW - POLO IV Saloon (9A4, 9A2, 9N2, 9A6) 09/02→					
Guide Bolt, brake caliper					
1.4	55 - 11/02→04/12 61	→ Construction year to: 05/09; for PR number: 1LJ; Required quantity: 2	2	11.8171-0008.1 990049	Brake System: ATE
1.6 Flex	77 05/08→10/14				
1.9 SDI	47 09/02→04/12				
1.9 TDi	74 09/02→				
2.0 Flex	88 10/08→12/14				
1.6	74 09/02→	Construction year from: 05/06 → → Construction year to: 05/09; for PR number: 1LJ; Required quantity: 2	2	11.8171-0008.1 990049	Brake System: ATE
1.6 Flex	76 12/04→10/14				
1.6 Total Flex	74 10/04→06/06	Construction year from: 05/06 →; for PR number: 1LJ; Required quantity: 2	2	11.8171-0008.1 990049	Brake System: ATE
 Wheel Speed Sensor					
1.0	58 02/03→10/03	Fitting Position: Front Axle Left		24.0711-5273.3 360303	
1.4	74 11/03→06/05				
1.4 TDi	55 07/03→06/05	Fitting Position: Front Axle Right		24.0711-5274.3 360304	
1.4	55 - 11/02→04/12 61	→ Construction year to: 05/09; Fitting Position: Front Axle Left		24.0711-5273.3 360303	
1.6 Flex	77 05/08→10/14				
1.9 SDI	47 09/02→04/12	→ Construction year to: 05/09; Fitting Position: Front Axle Right		24.0711-5274.3 360304	
1.9 TDi	74 09/02→				
2.0 Flex	88 10/08→12/14				
1.6	74 09/02→	Construction year from: 05/06 → → Construction year to: 05/09; Fitting Position: Front Axle Left		24.0711-5273.3 360303	
		Construction year from: 05/06 → → Construction year to: 05/09; Fitting Position: Front Axle Right		24.0711-5274.3 360304	
1.6 Flex	76 12/04→10/14				
1.6 Total Flex	74 10/04→06/06	Construction year from: 05/06 →; Fitting Position: Front Axle Left		24.0711-5273.3 360303	
		Construction year from: 05/06 →; Fitting Position: Front Axle Right		24.0711-5274.3 360304	
VW - POLO IV Saloon (9N4) 09/02→12/10					
Guide Bolt, brake caliper					
1.4 TDi	55 01/03→12/07	for PR number: 1LJ; Required quantity: 2	2	11.8171-0008.1 990049	Brake System: ATE
1.9 TDi	74 07/03→12/10	→ Construction year to: 05/09; for PR number: 1LJ; Required quantity: 2	2	11.8171-0008.1 990049	Brake System: ATE
 Wheel Speed Sensor					
1.4 TDi	55 01/03→12/07	Fitting Position: Front Axle Left		24.0711-5273.3 360303	
		Fitting Position: Front Axle Right		24.0711-5274.3 360304	
1.9 TDi	74 07/03→12/10	→ Construction year to: 05/09; Fitting Position: Front Axle Left		24.0711-5273.3 360303	
		→ Construction year to: 05/09; Fitting Position: Front Axle Right		24.0711-5274.3 360304	
VW - POLO V (6R1, 6C1) 03/09→					
Guide Bolt, brake caliper					
1.0	44 - 01/14→ 55	for PR number: 1ZG / 1LR / 1ZJ; Required quantity: 2	2	11.8171-0008.1 990049	Brake System: ATE
1.0 TSI	70 - 11/14→ 81	for PR number: 1LN / 1ZC; Required quantity: 2	2	11.8171-0008.1 990049	Brake System: ATE
1.4 TDi	55 - 02/14→ 77				
1.4 TSI	110 05/14→10/17				
1.2	44 - 06/09→ 55	for PR number: 1ZD; Required quantity: 2	2	11.8171-0008.1 990049	Brake System: ATE
1.2 TDi	55 10/09→				
1.2 TSI	66 - 11/09→ 81	for PR number: 1ZP / 1ZR; Required quantity: 2	2	11.8171-0008.1 990049	Brake System: ATE
1.2 TSI 16V	66 02/14→10/17	for PR number: 1ZG / 1LR / 1ZJ; Required quantity: 2	2	11.8171-0008.1 990049	Brake System: ATE
1.4	63 03/09→05/14				
1.4 BiFuel	60 03/10→01/11	for PR number: 1LN / 1ZC; Required quantity: 2	2	11.8171-0008.1 990049	Brake System: ATE
1.4 GTI	132 05/10→				
1.4 TSI	103 10/12→05/14				
1.6	66 - 07/14→10/17 81				
1.6 BiFuel	60 01/11→05/14				
1.6 TDi	55 - 06/09→ 77				
2.0 R WRC	162 08/13→05/14				
1.6	77 01/10→	Construction year from: 07/14 →; for PR number: 1LN / 1ZC; Required quantity: 2	2	11.8171-0008.1 990049	Brake System: ATE
→					



	kW				
VW - POLO V (6R1, 6C1) 03/09→					
Guide Bolt, brake caliper					
1.6	77 01/10→		Construction year from: 07/14 →; for PR number: 1ZG / 1LR / 1ZJ; Required quantity: 2	2	11.8171-0008.1 990049 Brake System: ATE
			Construction year from: 07/14 →; for PR number: 1ZD; Required quantity: 2	2	11.8171-0008.1 990049 Brake System: ATE
			Construction year from: 07/14 →; for PR number: 1ZP / 1ZR; Required quantity: 2	2	11.8171-0008.1 990049 Brake System: ATE
1.8 GTI	141 11/14→		for PR number: 1ZP / 1ZR; Required quantity: 2	2	11.8171-0008.1 990049 Brake System: ATE
1.8 GTI 230	169 04/16→		for PR number: 1ZG / 1LR / 1ZJ; Required quantity: 2	2	11.8171-0008.1 990049 Brake System: ATE
			for PR number: 1LN / 1ZC; Required quantity: 2	2	11.8171-0008.1 990049 Brake System: ATE
 Wheel Speed Sensor					
1.0	44 - 01/14→		Fitting Position: Front Axle Left		24.0711-5273.3 360303
	55		Fitting Position: Front Axle Right		24.0711-5274.3 360304
1.0 TSI	70 - 11/14→				
	81				
1.2	44 - 06/09→				
	55				
1.2 TDI	55 10/09→				
1.2 TSI	66 - 11/09→				
	81				
1.2 TSI 16V	66 02/14→10/17				
1.4	63 03/09→05/14				
1.4 BiFuel	60 03/10→01/11				
1.4 GTI	132 05/10→				
1.4 TDI	55 - 02/14→				
	77				
1.4 TSI	103 - 10/12→10/17				
	110				
1.6	66 - 07/14→10/17				
	81				
1.6 BiFuel	60 01/11→05/14				
1.6 TDI	55 - 06/09→				
	77				
1.8 GTI	141 11/14→				
1.8 GTI 230	169 04/16→				
2.0 R WRC	162 08/13→05/14				
1.6	77 01/10→		Construction year from: 07/14 →; Fitting Position: Front Axle Left		24.0711-5273.3 360303
			Construction year from: 07/14 →; Fitting Position: Front Axle Right		24.0711-5274.3 360304
VW - POLO V Saloon (602, 604, 612, 614) 05/09→					
Guide Bolt, brake caliper					
1.2 TSI	77 10/13→		for PR number: 1ZG / 1LR / 1ZJ; Required quantity: 2	2	11.8171-0008.1 990049 Brake System: ATE
1.4 TSi	92 05/16→				
1.6	66 - 07/14→		for PR number: 1LN / 1ZC; Required quantity: 2	2	11.8171-0008.1 990049 Brake System: ATE
	81		for PR number: 1ZD; Required quantity: 2	2	11.8171-0008.1 990049 Brake System: ATE
			for PR number: 1ZP / 1ZR; Required quantity: 2	2	11.8171-0008.1 990049 Brake System: ATE
1.4	63 12/10→		Construction year from: 07/14 →; for PR number: 1LN / 1ZC; Required quantity: 2	2	11.8171-0008.1 990049 Brake System: ATE
1.6	63 - 05/10→		Construction year from: 07/14 →; for PR number: 1ZG / 1LR / 1ZJ; Required quantity: 2	2	11.8171-0008.1 990049 Brake System: ATE
	77		Construction year from: 07/14 →; for PR number: 1ZD; Required quantity: 2	2	11.8171-0008.1 990049 Brake System: ATE
			Construction year from: 07/14 →; for PR number: 1ZP / 1ZR; Required quantity: 2	2	11.8171-0008.1 990049 Brake System: ATE
 Wheel Speed Sensor					
1.2 TSI	77 10/13→		Fitting Position: Front Axle Left		24.0711-5273.3 360303
1.4 TSi	92 05/16→		Fitting Position: Front Axle Right		24.0711-5274.3 360304
1.6	66 - 07/14→				
	81				
1.4	63 12/10→		Construction year from: 07/14 →; Fitting Position: Front Axle Left		24.0711-5273.3 360303
1.6	63 - 05/10→		Construction year from: 07/14 →; Fitting Position: Front Axle Right		24.0711-5274.3 360304
	77				

	kW				
VW - POLO VI (AW1, BZ1, AE1) 06/17→					
 Brake Pad Set, disc brake					
1.0	48 - 06/17→08/21		for PR number: 1ZB / 1ZU; Fitting Position: Front Axle	13.0460-2609.2 602609	Brake System: Lucas / TRW 25683 20,4 Wear Warning Contact: prepared for wear indicator / excl. wear warning contact
1.0 MPI	59 09/18→				
1.0 TGI	66 09/17→				
1.0 TSI	70 - 06/17→				
	85				
1.5 TSI	110 10/18→08/21			13.0470-2609.2 LD2609	Brake System: Lucas / TRW Wear Warning Contact: prepared for wear indicator / excl. wear warning contact Ceramic
1.6 MSi	81 09/17→				
1.6 TDI	59 - 11/17→02/21				
	70				
2.0 GTI	147 11/17→				
GTI	152 04/21→				
 Wheel Speed Sensor					
1.0	48 - 06/17→08/21		Fitting Position: Front Axle Left	24.0711-5273.3 360303	
	55				
1.0 MPI	59 09/18→		Fitting Position: Front Axle Right	24.0711-5274.3 360304	
1.0 TGI	66 09/17→				
1.0 TSI	70 - 06/17→				
	85				
1.5 TSI	110 10/18→08/21				
1.6 MSi	81 09/17→				
1.6 TDI	59 - 11/17→02/21				
	70				
2.0 GTI	147 11/17→				
GTI	152 04/21→				
VW - POLO Van (6R) 03/09→					
Guide Bolt, brake caliper					
1.0	44 - 01/14→		for PR number: 1ZG / 1LR / 1ZJ; Required quantity: 2	2 11.8171-0008.1 990049	Brake System: ATE
	55				
1.0 TSI	70 11/14→		for PR number: 1LN / 1ZC; Required quantity: 2	2 11.8171-0008.1 990049	Brake System: ATE
1.4 TDI	55 - 02/14→				
	66				
1.4 TSI	110 05/14→				
1.2	44 03/09→05/14		for PR number: 1ZG / 1LR / 1ZJ; Required quantity: 2	2 11.8171-0008.1 990049	Brake System: ATE
1.2 BlueMotion	51 03/09→05/14				
1.2 TDi BlueMotion	55 10/09→05/14		for PR number: 1LN / 1ZC; Required quantity: 2	2 11.8171-0008.1 990049	Brake System: ATE
1.2 TSi	66 05/11→05/14				
1.2 TSI	66 - 01/14→		for PR number: 1ZD; Required quantity: 2	2 11.8171-0008.1 990049	Brake System: ATE
	81				
1.2 TSi BlueMotion	77 11/09→05/14		for PR number: 1ZP / 1ZR; Required quantity: 2	2 11.8171-0008.1 990049	Brake System: ATE
1.4	63 03/09→05/14				
1.4 GTi	132 05/10→05/14				
1.6 TDi	55 - 06/09→05/14				
	77				
1.6 TDi BlueMotion	66 06/09→05/14				
	66				
 Wheel Speed Sensor					
1.0	44 - 01/14→		Fitting Position: Front Axle Left	24.0711-5273.3 360303	
	55				
1.0 TSI	70 11/14→		Fitting Position: Front Axle Right	24.0711-5274.3 360304	
1.2	44 03/09→05/14				
1.2 BlueMotion	51 03/09→05/14				
1.2 TDi BlueMotion	55 10/09→05/14				
1.2 TSi	66 05/11→05/14				
1.2 TSI	66 - 01/14→				
	81				
1.2 TSi BlueMotion	77 11/09→05/14				
1.4	63 03/09→05/14				
1.4 GTi	132 05/10→05/14				
1.4 TDI	55 - 02/14→				
	66				
1.4 TSI	110 05/14→				
1.6 TDi	55 - 06/09→05/14				
	77				
1.6 TDi BlueMotion	66 06/09→05/14				
	66				
VW - POLO Van Estate Van (6V5) 05/96→09/01					
Guide Bolt, brake caliper					
1.9 SDI	47 - 05/96→09/01		for PR number: 1LJ; Required quantity: 2	2 11.8171-0008.1 990049	Brake System: ATE
	50				
 Wheel Speed Sensor					
1.9 SDI	47 - 05/96→09/01		Fitting Position: Front Axle Left	24.0711-5273.3 360303	
	50				
			Fitting Position: Front Axle Right	24.0711-5274.3 360304	



		kW					
VW - SCIROCCO III (137, 138) 05/08→11/17							
Guide Bolt, brake caliper							
2.0 TDI	103	08/08→11/17	Construction year from: 10/08 →; for PR number: 1ZE / 1ZP; Required quantity: 2	2	11.8171-0008.1 990049	Brake System: ATE	
			Construction year from: 10/08 →; for PR number: 1LJ / 1ZA / 1ZD; Required quantity: 2	2	11.8171-0008.1 990049	Brake System: ATE	
			Construction year from: 10/08 →; for PR number: 1ZB; Required quantity: 2	2	11.8171-0008.1 990049	Brake System: ATE	
 Brake Disc							
1.4 TSI	90	08/08→11/17	Construction year from: 09/08 →; for PR number: 1ZE / 1ZP; Fitting Position: Front Axle		24.0125-0145.1 425145	Outer diameter [mm]: 288 Brake Disc Thickness [mm] 25 Minimum thickness [mm] 22 Brake Disc Type: Vented Supplementary Article/Info 2: with bolts/screws	
			Construction year from: 09/08 →; for PR number: 1LJ / 1ZA / 1ZB / 1ZD; Fitting Position: Front Axle		24.0125-0158.1 425158	Outer diameter [mm]: 312 Brake Disc Thickness [mm] 25 Minimum thickness [mm] 22 Brake Disc Type: Vented Supplementary Article/Info 2: with bolts/screws	
					24.0325-0158.1 525158	Outer diameter [mm]: 312 Brake Disc Thickness [mm] 25 Minimum thickness [mm] 22 Brake Disc Type: Vented Supplementary Article/Info 2: with bolts/screws	
			Construction year from: 09/08 →; for PR number: 1KS / 1KT; Fitting Position: Rear Axle		24.0110-0356.1 410356	Outer diameter [mm]: 272 Brake Disc Thickness [mm] 9.7 Minimum thickness [mm] 8 Brake Disc Type: Solid Supplementary Article/Info 2: with bolts/screws	
					24.0310-0356.1 510356	Outer diameter [mm]: 272 Brake Disc Thickness [mm] 9.7 Minimum thickness [mm] 8 Brake Disc Type: Solid Supplementary Article/Info 2: with bolts/screws	
1.4 TSI	92 - 110	11/13→11/17	for PR number: 1ZE / 1ZP; Fitting Position: Front Axle		24.0125-0145.1 425145	Outer diameter [mm]: 288 Brake Disc Thickness [mm] 25 Minimum thickness [mm] 22 Brake Disc Type: Vented Supplementary Article/Info 2: with bolts/screws	
2.0 R	188 - 195	11/09→11/17					
2.0 TDI	100 - 135	05/09→11/17					
2.0 TSI	132 - 162	11/09→11/17	for PR number: 1LJ / 1ZA / 1ZB / 1ZD; Fitting Position: Front Axle		24.0125-0158.1 425158	Outer diameter [mm]: 312 Brake Disc Thickness [mm] 25 Minimum thickness [mm] 22 Brake Disc Type: Vented Supplementary Article/Info 2: with bolts/screws	
					24.0325-0158.1 525158	Outer diameter [mm]: 312 Brake Disc Thickness [mm] 25 Minimum thickness [mm] 22 Brake Disc Type: Vented Supplementary Article/Info 2: with bolts/screws	
			for PR number: 1KS / 1KT; Fitting Position: Rear Axle		24.0110-0356.1 410356	Outer diameter [mm]: 272 Brake Disc Thickness [mm] 9.7 Minimum thickness [mm] 8 Brake Disc Type: Solid Supplementary Article/Info 2: with bolts/screws	
					24.0310-0356.1 510356	Outer diameter [mm]: 272 Brake Disc Thickness [mm] 9.7 Minimum thickness [mm] 8 Brake Disc Type: Solid Supplementary Article/Info 2: with bolts/screws	
1.4 TSI	118	05/08→11/17	Construction year from: 08/08 →; for PR number: 1ZE / 1ZP; Fitting Position: Front Axle		24.0125-0145.1 425145	Outer diameter [mm]: 288 Brake Disc Thickness [mm] 25 Minimum thickness [mm] 22 Brake Disc Type: Vented Supplementary Article/Info 2: with bolts/screws	
2.0 TFSI	147	05/08→11/09					
→							





		kW					
VW - SCIROCCO III (137, 138) 05/08→11/17							
 Brake Disc							
1.4 TSI 2.0 TFSI	118 05/08→11/17 147 05/08→11/09	Construction year from: 08/08 →; for PR number: 1LJ / 1ZA / 1ZB / 1ZD; Fitting Position: Front Axle	24.0125-0158.1 425158	Outer diameter [mm]: 312 Brake Disc Thickness [mm] 25 Minimum thickness [mm] 22 Brake Disc Type: Vented Supplementary Article/Info 2: with bolts/screws			
			24.0325-0158.1 525158	Outer diameter [mm]: 312 Brake Disc Thickness [mm] 25 Minimum thickness [mm] 22 Brake Disc Type: Vented Supplementary Article/Info 2: with bolts/screws			
		Construction year from: 08/08 →; for PR number: 1KS / 1KT; Fitting Position: Rear Axle	24.0110-0356.1 410356	Outer diameter [mm]: 272 Brake Disc Thickness [mm] 9.7 Minimum thickness [mm] 8 Brake Disc Type: Solid Supplementary Article/Info 2: with bolts/screws			
			24.0310-0356.1 510356	Outer diameter [mm]: 272 Brake Disc Thickness [mm] 9.7 Minimum thickness [mm] 8 Brake Disc Type: Solid Supplementary Article/Info 2: with bolts/screws			
2.0 R	206 05/14→11/17	Construction year from: 08/14 →; for PR number: 1ZE / 1ZP; Fitting Position: Front Axle	24.0125-0145.1 425145	Outer diameter [mm]: 288 Brake Disc Thickness [mm] 25 Minimum thickness [mm] 22 Brake Disc Type: Vented Supplementary Article/Info 2: with bolts/screws			
			24.0125-0158.1 425158	Outer diameter [mm]: 312 Brake Disc Thickness [mm] 25 Minimum thickness [mm] 22 Brake Disc Type: Vented Supplementary Article/Info 2: with bolts/screws			
			24.0325-0158.1 525158	Outer diameter [mm]: 312 Brake Disc Thickness [mm] 25 Minimum thickness [mm] 22 Brake Disc Type: Vented Supplementary Article/Info 2: with bolts/screws			
		Construction year from: 08/14 →; for PR number: 1LJ / 1ZA / 1ZB / 1ZD; Fitting Position: Front Axle	24.0110-0356.1 410356	Outer diameter [mm]: 272 Brake Disc Thickness [mm] 9.7 Minimum thickness [mm] 8 Brake Disc Type: Solid Supplementary Article/Info 2: with bolts/screws			
			24.0310-0356.1 510356	Outer diameter [mm]: 272 Brake Disc Thickness [mm] 9.7 Minimum thickness [mm] 8 Brake Disc Type: Solid Supplementary Article/Info 2: with bolts/screws			
2.0 TDI	103 08/08→11/17	Construction year from: 10/08 →; for PR number: 1ZE / 1ZP; Fitting Position: Front Axle	24.0125-0145.1 425145	Outer diameter [mm]: 288 Brake Disc Thickness [mm] 25 Minimum thickness [mm] 22 Brake Disc Type: Vented Supplementary Article/Info 2: with bolts/screws			
			24.0125-0158.1 425158	Outer diameter [mm]: 312 Brake Disc Thickness [mm] 25 Minimum thickness [mm] 22 Brake Disc Type: Vented Supplementary Article/Info 2: with bolts/screws			
			24.0325-0158.1 525158	Outer diameter [mm]: 312 Brake Disc Thickness [mm] 25 Minimum thickness [mm] 22 Brake Disc Type: Vented Supplementary Article/Info 2: with bolts/screws			
		Construction year from: 10/08 →; for PR number: 1LJ / 1ZA / 1ZB / 1ZD; Fitting Position: Front Axle	24.0110-0356.1 410356	Outer diameter [mm]: 272 Brake Disc Thickness [mm] 9.7 Minimum thickness [mm] 8 Brake Disc Type: Solid Supplementary Article/Info 2: with bolts/screws			
		Construction year from: 10/08 →; for PR number: 1KS / 1KT; Fitting Position: Rear Axle	24.0125-0158.1 425158	Outer diameter [mm]: 312 Brake Disc Thickness [mm] 25 Minimum thickness [mm] 22 Brake Disc Type: Vented Supplementary Article/Info 2: with bolts/screws			
			24.0325-0158.1 525158	Outer diameter [mm]: 312 Brake Disc Thickness [mm] 25 Minimum thickness [mm] 22 Brake Disc Type: Vented Supplementary Article/Info 2: with bolts/screws			
		Construction year from: 10/08 →; for PR number: 1LJ / 1ZA / 1ZB / 1ZD; Fitting Position: Front Axle	24.0110-0356.1 410356	Outer diameter [mm]: 272 Brake Disc Thickness [mm] 9.7 Minimum thickness [mm] 8 Brake Disc Type: Solid Supplementary Article/Info 2: with bolts/screws			
		Construction year from: 10/08 →; for PR number: 1KS / 1KT; Fitting Position: Rear Axle	24.0125-0158.1 425158	Outer diameter [mm]: 312 Brake Disc Thickness [mm] 25 Minimum thickness [mm] 22 Brake Disc Type: Vented Supplementary Article/Info 2: with bolts/screws			
			24.0325-0158.1 525158	Outer diameter [mm]: 312 Brake Disc Thickness [mm] 25 Minimum thickness [mm] 22 Brake Disc Type: Vented Supplementary Article/Info 2: with bolts/screws			
		Construction year from: 10/08 →; for PR number: 1LJ / 1ZA / 1ZB / 1ZD; Fitting Position: Front Axle	24.0110-0356.1 410356	Outer diameter [mm]: 272 Brake Disc Thickness [mm] 9.7 Minimum thickness [mm] 8 Brake Disc Type: Solid Supplementary Article/Info 2: with bolts/screws			
		Construction year from: 10/08 →; for PR number: 1KS / 1KT; Fitting Position: Rear Axle	24.0125-0158.1 425158	Outer diameter [mm]: 312 Brake Disc Thickness [mm] 25 Minimum thickness [mm] 22 Brake Disc Type: Vented Supplementary Article/Info 2: with bolts/screws			
			24.0325-0158.1 525158	Outer diameter [mm]: 312 Brake Disc Thickness [mm] 25 Minimum thickness [mm] 22 Brake Disc Type: Vented Supplementary Article/Info 2: with bolts/screws			



→



	kw				
VW - SCIROCCO III (137, 138) 05/08→11/17					
 Brake Disc					
2.0 TDI	103 08/08→11/17	Construction year from: 10/08 →; for PR number: 1KS / 1KT; Fitting Position: Rear Axle		24.0310-0356.1 510356	Outer diameter [mm]: 272 Brake Disc Thickness [mm] 9.7 Minimum thickness [mm] 8 Brake Disc Type: Solid Supplementary Article/Info 2: with bolts/screws
VW - SCIROCCO Van (137) 06/08→05/14					
Guide Sleeve Kit, brake caliper					
1.4 TSi	90 08/08→05/14	Construction year from: 09/08 →; for PR number: 1ZK; Fitting Position: Front Axle		11.0101-5407.2 260011	Brake System: ATE
1.4 TSi	118 06/08→05/14	Construction year from: 08/08 →; for PR number: 1ZK; Fitting Position: Front Axle		11.0101-5407.2 260011	Brake System: ATE
2.0 TDi	103 08/08→05/14	Construction year from: 10/08 →; for PR number: 1ZK; Fitting Position: Front Axle		11.0101-5407.2 260011	Brake System: ATE
2.0 TDi	125 05/09→05/14	for PR number: 1ZK;		11.0101-5407.2 260011	Brake System: ATE
2.0 TFSi	155 11/09→05/14	Fitting Position: Front Axle			
Guide Bolt, brake caliper					
1.4 TSi	90 08/08→05/14	Construction year from: 09/08 →; for PR number: 1ZE / 1ZP; Required quantity: 2	2	11.8171-0008.1 990049	Brake System: ATE
		Construction year from: 09/08 →; for PR number: 1LJ / 1ZA / 1ZD; Required quantity: 2	2	11.8171-0008.1 990049	Brake System: ATE
		Construction year from: 09/08 →; for PR number: 1ZB; Required quantity: 2	2	11.8171-0008.1 990049	Brake System: ATE
1.4 TSi	118 06/08→05/14	Construction year from: 08/08 →; for PR number: 1ZE / 1ZP; Required quantity: 2	2	11.8171-0008.1 990049	Brake System: ATE
		Construction year from: 08/08 →; for PR number: 1LJ / 1ZA / 1ZD; Required quantity: 2	2	11.8171-0008.1 990049	Brake System: ATE
		Construction year from: 08/08 →; for PR number: 1ZB; Required quantity: 2	2	11.8171-0008.1 990049	Brake System: ATE
2.0 TDi	103 08/08→05/14	Construction year from: 10/08 →; for PR number: 1LJ / 1ZA / 1ZD; Required quantity: 2	2	11.8171-0008.1 990049	Brake System: ATE
		Construction year from: 10/08 →; for PR number: 1ZE / 1ZP; Required quantity: 2	2	11.8171-0008.1 990049	Brake System: ATE
		Construction year from: 10/08 →; for PR number: 1ZB; Required quantity: 2	2	11.8171-0008.1 990049	Brake System: ATE
2.0 TDi	125 05/09→05/14	for PR number: 1ZE / 1ZP; Required quantity: 2	2	11.8171-0008.1 990049	Brake System: ATE
2.0 TFSi	155 11/09→05/14	for PR number: 1LJ / 1ZA / 1ZD; Required quantity: 2	2	11.8171-0008.1 990049	Brake System: ATE
		for PR number: 1ZB; Required quantity: 2	2	11.8171-0008.1 990049	Brake System: ATE
 Brake Disc					
1.4 TSi	90 08/08→05/14	Construction year from: 09/08 →; for PR number: 1ZE / 1ZP; Fitting Position: Front Axle		24.0125-0145.1 425145	Outer diameter [mm]: 288 Brake Disc Thickness [mm] 25 Minimum thickness [mm] 22 Brake Disc Type: Vented Supplementary Article/Info 2: with bolts/screws
		Construction year from: 09/08 →; for PR number: 1LJ / 1ZA / 1ZB / 1ZD; Fitting Position: Front Axle		24.0125-0158.1 425158	Outer diameter [mm]: 312 Brake Disc Thickness [mm] 25 Minimum thickness [mm] 22 Brake Disc Type: Vented Supplementary Article/Info 2: with bolts/screws
		Construction year from: 09/08 →; for PR number: 1KS / 1KT; Fitting Position: Rear Axle		24.0110-0356.1 410356	Outer diameter [mm]: 272 Brake Disc Thickness [mm] 9.7 Minimum thickness [mm] 8 Brake Disc Type: Solid Supplementary Article/Info 2: with bolts/screws
→					



	kW				
VW - SCIROCCO Van (137) 06/08→05/14					
 Brake Disc					
1.4 TSi	90	08/08→05/14	Construction year from: 09/08 →; for PR number: 1KS / 1KT; Fitting Position: Rear Axle	24.0310-0356.1 510356	Outer diameter [mm]: 272 Brake Disc Thickness [mm] 9.7 Minimum thickness [mm] 8 Brake Disc Type: Solid Supplementary Article/Info 2: with bolts/screws
1.4 TSi	118	06/08→05/14	Construction year from: 08/08 →; for PR number: 1ZE / 1ZP; Fitting Position: Front Axle	24.0125-0145.1 425145	Outer diameter [mm]: 288 Brake Disc Thickness [mm] 25 Minimum thickness [mm] 22 Brake Disc Type: Vented Supplementary Article/Info 2: with bolts/screws
			Construction year from: 08/08 →; for PR number: 1LJ / 1ZA / 1ZB / 1ZD; Fitting Position: Front Axle	24.0125-0158.1 425158	Outer diameter [mm]: 312 Brake Disc Thickness [mm] 25 Minimum thickness [mm] 22 Brake Disc Type: Vented Supplementary Article/Info 2: with bolts/screws
			Construction year from: 08/08 →; for PR number: 1KS / 1KT; Fitting Position: Rear Axle	24.0110-0356.1 410356 24.0310-0356.1 510356	Outer diameter [mm]: 272 Brake Disc Thickness [mm] 9.7 Minimum thickness [mm] 8 Brake Disc Type: Solid Supplementary Article/Info 2: with bolts/screws Outer diameter [mm]: 272 Brake Disc Thickness [mm] 9.7 Minimum thickness [mm] 8 Brake Disc Type: Solid Supplementary Article/Info 2: with bolts/screws
2.0 TDi	103	08/08→05/14	Construction year from: 10/08 →; for PR number: 1ZE / 1ZP; Fitting Position: Front Axle	24.0125-0145.1 425145	Outer diameter [mm]: 288 Brake Disc Thickness [mm] 25 Minimum thickness [mm] 22 Brake Disc Type: Vented Supplementary Article/Info 2: with bolts/screws
			Construction year from: 10/08 →; for PR number: 1LJ / 1ZA / 1ZB / 1ZD; Fitting Position: Front Axle	24.0125-0158.1 425158	Outer diameter [mm]: 312 Brake Disc Thickness [mm] 25 Minimum thickness [mm] 22 Brake Disc Type: Vented Supplementary Article/Info 2: with bolts/screws
			Construction year from: 10/08 →; for PR number: 1KS / 1KT; Fitting Position: Rear Axle	24.0110-0356.1 410356 24.0310-0356.1 510356	Outer diameter [mm]: 272 Brake Disc Thickness [mm] 9.7 Minimum thickness [mm] 8 Brake Disc Type: Solid Supplementary Article/Info 2: with bolts/screws Outer diameter [mm]: 272 Brake Disc Thickness [mm] 9.7 Minimum thickness [mm] 8 Brake Disc Type: Solid Supplementary Article/Info 2: with bolts/screws
2.0 TDi 2.0 TFSi	125 155	05/09→05/14 11/09→05/14	for PR number: 1ZE / 1ZP; Fitting Position: Front Axle	24.0125-0145.1 425145	Outer diameter [mm]: 288 Brake Disc Thickness [mm] 25 Minimum thickness [mm] 22 Brake Disc Type: Vented Supplementary Article/Info 2: with bolts/screws
			for PR number: 1LJ / 1ZA / 1ZB / 1ZD; Fitting Position: Front Axle	24.0125-0158.1 425158	Outer diameter [mm]: 312 Brake Disc Thickness [mm] 25 Minimum thickness [mm] 22 Brake Disc Type: Vented Supplementary Article/Info 2: with bolts/screws
			for PR number: 1KS / 1KT; Fitting Position: Rear Axle	24.0110-0356.1 410356 24.0310-0356.1 510356	Outer diameter [mm]: 272 Brake Disc Thickness [mm] 9.7 Minimum thickness [mm] 8 Brake Disc Type: Solid Supplementary Article/Info 2: with bolts/screws Outer diameter [mm]: 272 Brake Disc Thickness [mm] 9.7 Minimum thickness [mm] 8 Brake Disc Type: Solid Supplementary Article/Info 2: with bolts/screws



	kW				
VW - SHARAN (7M8, 7M9, 7M6) 05/95→03/10					
Guide Bolt, brake caliper					
1.8 T 20V 1.9 TDI 2.0 2.0 16V 2.0 LPG 2.8 VR6 2.8 VR6 Syncro	110 09/97→03/10 66 - 09/95→03/10 81 85 09/95→03/10 110 09/95→02/00 85 04/06→03/10 128 09/95→04/00 128 11/96→04/00	→ Vehicle Identification Number to: 7M-1-070000; Required quantity: 2; Fitting Position: Front Axle	2	11.8171-0008.1 990049	Brake System: ATE
1.9 TDI	85 04/00→03/10	Construction year from: 05/00 →; → Vehicle Identification Number to: 7M-1-070000; Required quantity: 2; Fitting Position: Front Axle	2	11.8171-0008.1 990049	Brake System: ATE
VW - SHARAN (7N1, 7N2) 05/10→					
Guide Bolt, brake caliper					
1.4 TSI 2.0 TDI	110 05/10→ 100 - 05/10→ 103	Construction year from: 07/10 →; for PR number: 1LJ; Required quantity: 2	2	11.8171-0008.1 990049	Brake System: ATE
2.0 TDI 2.0 TDI 4motion 2.0 TFSI	85 - 08/10→ 130 103 05/11→11/15 147 12/10→11/15	for PR number: 1LJ; Required quantity: 2	2	11.8171-0008.1 990049	Brake System: ATE
 Brake Disc					
1.4 TSI 2.0 TDI	110 05/10→ 100 - 05/10→ 103	Construction year from: 07/10 →; for PR number: 1LJ; Fitting Position: Front Axle		24.0125-0158.1 425158	Outer diameter [mm]: 312 Brake Disc Thickness [mm] 25 Minimum thickness [mm] 22 Brake Disc Type: Vented Supplementary Article/Info 2: with bolts/screws
				24.0325-0158.1 525158	Outer diameter [mm]: 312 Brake Disc Thickness [mm] 25 Minimum thickness [mm] 22 Brake Disc Type: Vented Supplementary Article/Info 2: with bolts/screws
1.4 TSI 2.0 TDI 2.0 TDI 4motion 2.0 TSI	110 05/15→ 110 - 05/15→ 135 110 - 05/15→ 135 162 05/15→	Vehicle Equipment: for vehicles with electric parking brake; Fitting Position: Rear Axle		24.0112-0210.1 412210	Outer diameter [mm]: 300 Brake Disc Thickness [mm] 12 Minimum thickness [mm] 10 Brake Disc Type: Solid Supplementary Article/Info 2: with bolts/screws
2.0 TDI 2.0 TDI 4motion 2.0 TFSI	85 - 08/10→ 130 103 05/11→11/15 147 12/10→11/15	for PR number: 1LJ; Fitting Position: Front Axle		24.0125-0158.1 425158	Outer diameter [mm]: 312 Brake Disc Thickness [mm] 25 Minimum thickness [mm] 22 Brake Disc Type: Vented Supplementary Article/Info 2: with bolts/screws
				24.0325-0158.1 525158	Outer diameter [mm]: 312 Brake Disc Thickness [mm] 25 Minimum thickness [mm] 22 Brake Disc Type: Vented Supplementary Article/Info 2: with bolts/screws
VW - SHARAN VAN (7M_) 05/95→03/10					
Guide Bolt, brake caliper					
2.8 VR6	150 08/01→05/03	→ Vehicle Identification Number to: 7M-1-070000; Required quantity: 2; Fitting Position: Front Axle	2	11.8171-0008.1 990049	Brake System: ATE
VW - SHARAN VAN (7N1, 7N2) 05/10→					
Guide Bolt, brake caliper					
1.4 TSI 2.0 TDI	110 05/10→11/15 100 - 05/10→11/15 103	Construction year from: 07/10 →; for PR number: 1LJ; Required quantity: 2	2	11.8171-0008.1 990049	Brake System: ATE
2.0 TDI 2.0 TSI	85 - 08/10→11/15 125 147 12/10→11/15	for PR number: 1LJ; Required quantity: 2	2	11.8171-0008.1 990049	Brake System: ATE
 Brake Disc					
1.4 TSI 2.0 TDI	110 05/10→11/15 100 - 05/10→11/15 103	Construction year from: 07/10 →; for PR number: 1LJ; Fitting Position: Front Axle		24.0125-0158.1 425158	Outer diameter [mm]: 312 Brake Disc Thickness [mm] 25 Minimum thickness [mm] 22 Brake Disc Type: Vented Supplementary Article/Info 2: with bolts/screws
→					

	kW				
VW - SHARAN VAN (7N1, 7N2) 05/10→					
 Brake Disc					
1.4 TSI 2.0 TDI	110 05/10→11/15 100 - 05/10→11/15 103	Construction year from: 07/10 →; for PR number: 1LJ; Fitting Position: Front Axle		24.0325-0158.1 525158	Outer diameter [mm]: 312 Brake Disc Thickness [mm] 25 Minimum thickness [mm] 22 Brake Disc Type: Vented Supplementary Article/Info 2: with bolts/screws
2.0 TDI 2.0 TSI	85 - 08/10→11/15 125 147 12/10→11/15	for PR number: 1LJ; Fitting Position: Front Axle		24.0125-0158.1 425158 24.0325-0158.1 525158	Outer diameter [mm]: 312 Brake Disc Thickness [mm] 25 Minimum thickness [mm] 22 Brake Disc Type: Vented Supplementary Article/Info 2: with bolts/screws Outer diameter [mm]: 312 Brake Disc Thickness [mm] 25 Minimum thickness [mm] 22 Brake Disc Type: Vented Supplementary Article/Info 2: with bolts/screws
VW - TAOS (CL1, CQ1) 07/20→					
 Brake Caliper					
1.4 TSI 1.4 TSI 4motion 1.6 MPI	110 10/20→ 110 05/21→ 81 07/21→	for PR number: 1ZK; Fitting Position: Front Axle Left		24.3571-1801.5 241387	Supplementary Article/Supplementary Info: without holder Brake Caliper Type: Fist-type Caliper
		for PR number: 1ZK; Fitting Position: Front Axle Right		24.3571-1802.5 241388	Supplementary Article/Supplementary Info: without holder Brake Caliper Type: Fist-type Caliper
 Brake Disc					
1.4 TSI 1.4 TSI 4motion 1.6 MPI	110 10/20→ 110 05/21→ 81 07/21→	for PR number: 1ZJ; Fitting Position: Front Axle		24.0125-0145.1 425145	Outer diameter [mm]: 288 Brake Disc Thickness [mm] 25 Minimum thickness [mm] 22 Brake Disc Type: Vented Supplementary Article/Info 2: with bolts/screws
		for PR number: 1ZK; Fitting Position: Front Axle		24.0125-0158.1 425158	Outer diameter [mm]: 312 Brake Disc Thickness [mm] 25 Minimum thickness [mm] 22 Brake Disc Type: Vented Supplementary Article/Info 2: with bolts/screws
		for PR number: 2EJ; Observe dimensions; Fitting Position: Rear Axle		24.0110-0356.1 410356	Outer diameter [mm]: 272 Brake Disc Thickness [mm] 9.7 Minimum thickness [mm] 8 Brake Disc Type: Solid Supplementary Article/Info 2: with bolts/screws
 Wheel Speed Sensor					
1.4 TSI 1.4 TSI 4motion 1.6 MPI	110 10/20→ 110 05/21→ 81 07/21→	→ Construction year to: 12/21; Fitting Position: Front Axle Left		24.0711-5273.3 360303	
		→ Construction year to: 12/21; Fitting Position: Front Axle Right		24.0711-5274.3 360304	
		Fitting Position: Rear Axle Left		24.0711-5401.3 360330	
		Fitting Position: Rear Axle Right		24.0711-5402.3 360331	
		Required quantity: 2; Fitting Position: Rear Axle	2	24.0711-6337.3 360390	
Control Element, parking brake caliper					
1.4 TSI 1.4 TSI 4motion 1.6 MPI	110 10/20→ 110 05/21→ 81 07/21→	Fitting Position: Rear Axle Left		11.9282-1001.3 250159	Brake System: ATE
		Fitting Position: Rear Axle Right		11.9282-1002.3 250160	Brake System: ATE
VW - T-CROSS (C11) 12/18→					
 Wheel Speed Sensor					
1.0 TSi 1.6 TDi	70 - 12/18→ 85 70 12/18→	→ Construction year to: 11/19; Fitting Position: Front Axle Left		24.0711-5273.3 360303	
		→ Construction year to: 11/19; Fitting Position: Front Axle Right		24.0711-5274.3 360304	

	kW				
VW - TIGUAN (5N_) 09/07→07/18					
Guide Bolt, brake caliper					
1.4 TSI	90 - 05/08→07/18 118	Required quantity: 2	2	11.8171-0008.1 990049	Brake System: ATE
1.4 TSI 4motion	110 - 09/07→07/18 118				
2.0 TDI	81 - 03/08→07/18 110				
2.0 TDI 4motion	100 - 11/07→07/18 135				
2.0 TFSI	147 11/07→07/18				
2.0 TFSI 4motion	125 09/07→07/18				
2.0 TSI 4motion	132 - 05/11→07/18 155				
2.0 TDI 4motion	103 09/07→07/18	Construction year from: 11/07 →; Required quantity: 2	2	11.8171-0008.1 990049	Brake System: ATE
2.0 TDI 4motion	125 09/07→07/18	Construction year from: 01/08 →; Required quantity: 2	2	11.8171-0008.1 990049	Brake System: ATE
2.0 TFSI 4motion	147 09/07→07/18	Construction year from: 02/08 →; Required quantity: 2	2	11.8171-0008.1 990049	Brake System: ATE
 Brake Disc					
1.4 TSI	90 - 05/08→07/18 118	Fitting Position: Front Axle		24.0125-0158.1 425158	Outer diameter [mm]: 312 Brake Disc Thickness [mm] 25 Minimum thickness [mm] 22 Brake Disc Type: Vented Supplementary Article/Info 2: with bolts/screws
1.4 TSI 4motion	110 - 09/07→07/18 118				
2.0 TDI	81 - 03/08→07/18 110				
2.0 TDI 4motion	100 - 11/07→07/18 135			24.0325-0158.1 525158	Outer diameter [mm]: 312 Brake Disc Thickness [mm] 25 Minimum thickness [mm] 22 Brake Disc Type: Vented Supplementary Article/Info 2: with bolts/screws
2.0 TFSI 4motion	125 09/07→07/18				
2.0 TSI 4motion	132 - 05/11→07/18 155				
2.0 TDI 4motion	103 09/07→07/18	Construction year from: 11/07 →; Fitting Position: Front Axle		24.0125-0158.1 425158	Outer diameter [mm]: 312 Brake Disc Thickness [mm] 25 Minimum thickness [mm] 22 Brake Disc Type: Vented Supplementary Article/Info 2: with bolts/screws
				24.0325-0158.1 525158	Outer diameter [mm]: 312 Brake Disc Thickness [mm] 25 Minimum thickness [mm] 22 Brake Disc Type: Vented Supplementary Article/Info 2: with bolts/screws
2.0 TDI 4motion	125 09/07→07/18	Construction year from: 01/08 →; Fitting Position: Front Axle		24.0125-0158.1 425158	Outer diameter [mm]: 312 Brake Disc Thickness [mm] 25 Minimum thickness [mm] 22 Brake Disc Type: Vented Supplementary Article/Info 2: with bolts/screws
				24.0325-0158.1 525158	Outer diameter [mm]: 312 Brake Disc Thickness [mm] 25 Minimum thickness [mm] 22 Brake Disc Type: Vented Supplementary Article/Info 2: with bolts/screws
2.0 TFSI	147 11/07→07/18	Fitting Position: Front Axle		24.0125-0158.1 425158	Outer diameter [mm]: 312 Brake Disc Thickness [mm] 25 Minimum thickness [mm] 22 Brake Disc Type: Vented Supplementary Article/Info 2: with bolts/screws
2.0 TFSI 4motion	147 09/07→07/18	Construction year from: 02/08 →; Fitting Position: Front Axle		24.0125-0158.1 425158	Outer diameter [mm]: 312 Brake Disc Thickness [mm] 25 Minimum thickness [mm] 22 Brake Disc Type: Vented Supplementary Article/Info 2: with bolts/screws
				24.0325-0158.1 525158	Outer diameter [mm]: 312 Brake Disc Thickness [mm] 25 Minimum thickness [mm] 22 Brake Disc Type: Vented Supplementary Article/Info 2: with bolts/screws
 Wheel Speed Sensor					
1.4 TSI 4motion	110 - 09/07→07/18 118	for PR number: 7X5 / 7X6; Fitting Position: Rear Axle Left		24.0711-5401.3 360330	
→					

	kW				
VW - TIGUAN (5N_) 09/07→07/18					
 Wheel Speed Sensor					
2.0 TDI 4motion	100 - 11/07→07/18		for PR number: 7X5 / 7X6; Fitting Position: Rear Axle Right	24.0711-5402.3 360331	
2.0 TFSI 4motion	125 09/07→07/18				
2.0 TSI 4motion	132 - 05/11→07/18				
	135				
	155				
2.0 TDI 4motion	103 09/07→07/18		Construction year from: 11/07 →; for PR number: 7X5 / 7X6; Fitting Position: Rear Axle Left	24.0711-5401.3 360330	
			Construction year from: 11/07 →; for PR number: 7X5 / 7X6; Fitting Position: Rear Axle Right	24.0711-5402.3 360331	
2.0 TDI 4motion	125 09/07→07/18		Construction year from: 01/08 →; for PR number: 7X5 / 7X6; Fitting Position: Rear Axle Left	24.0711-5401.3 360330	
			Construction year from: 01/08 →; for PR number: 7X5 / 7X6; Fitting Position: Rear Axle Right	24.0711-5402.3 360331	
2.0 TFSI 4motion	147 09/07→07/18		Construction year from: 02/08 →; for PR number: 7X5 / 7X6; Fitting Position: Rear Axle Left	24.0711-5401.3 360330	
			Construction year from: 02/08 →; for PR number: 7X5 / 7X6; Fitting Position: Rear Axle Right	24.0711-5402.3 360331	
VW - TIGUAN (AD1, AX1) 01/16→					
 Brake Caliper					
1.4 eHybrid	110 11/20→		for PR number: 1ZA / 1ZD; Fitting Position: Front Axle Left	24.3571-1801.5 241387	Supplementary Article/Supplementary Info: without holder Brake Caliper Type: Fist-type Caliper
1.4 TSI	92 - 01/16→07/18				
1.4 TSI 4motion	110 05/16→07/18				
1.5 TSI	96 - 07/18→		for PR number: 1ZA / 1ZD; Fitting Position: Front Axle Right	24.3571-1802.5 241388	Supplementary Article/Supplementary Info: without holder Brake Caliper Type: Fist-type Caliper
1.6 TDI	85 05/16→06/20				
2.0 TDI	81 - 05/16→				
	90				
2.0 TDI 4motion	130 - 04/16→				
	176				
2.0 TSI 4motion	140 - 06/16→				
	180				
2.0 TSI R 4motion	235 11/20→				
2.0 TDI	110 01/16→07/20		Construction year from: 02/16 →; for PR number: 1ZA / 1ZD; Fitting Position: Front Axle Left	24.3571-1801.5 241387	Supplementary Article/Supplementary Info: without holder Brake Caliper Type: Fist-type Caliper
2.0 TDI 4motion	110 01/16→07/20				
2.0 TSI 4motion	132 01/16→		Construction year from: 02/16 →; for PR number: 1ZA / 1ZD; Fitting Position: Front Axle Right	24.3571-1802.5 241388	Supplementary Article/Supplementary Info: without holder Brake Caliper Type: Fist-type Caliper
 Brake Disc					
1.4 eHybrid	110 11/20→		for PR number: 1ZA / 1ZD; Fitting Position: Front Axle	24.0125-0158.1 425158	Outer diameter [mm]: 312 Brake Disc Thickness [mm] 25 Minimum thickness [mm] 22 Brake Disc Type: Vented Supplementary Article/Info 2: with bolts/screws
1.4 TSI	92 - 01/16→07/18				
	110				
1.4 TSI 4motion	110 05/16→07/18				
1.5 TSI	96 - 07/18→				
	110				
1.6 TDI	85 05/16→06/20		for PR number: 1KU; Vehicle Equipment: for vehicles with electric parking brake; Fitting Position: Rear Axle	24.0112-0210.1 412210	Outer diameter [mm]: 300 Brake Disc Thickness [mm] 12 Minimum thickness [mm] 10 Brake Disc Type: Solid Supplementary Article/Info 2: with bolts/screws
2.0 TDI	81 - 05/16→				
	90				
2.0 TDI 4motion	130 - 04/16→				
	176				
2.0 TSI 4motion	140 - 06/16→				
	180				
2.0 TSI R 4motion	235 11/20→				
2.0 TDI	110 01/16→07/20		Construction year from: 02/16 →; for PR number: 1ZA / 1ZD; Fitting Position: Front Axle	24.0125-0158.1 425158	Outer diameter [mm]: 312 Brake Disc Thickness [mm] 25 Minimum thickness [mm] 22 Brake Disc Type: Vented Supplementary Article/Info 2: with bolts/screws
2.0 TDI 4motion	110 01/16→07/20				
2.0 TSI 4motion	132 01/16→		Construction year from: 02/16 →; for PR number: 1KU; Vehicle Equipment: for vehicles with electric parking brake; Fitting Position: Rear Axle	24.0112-0210.1 412210	Outer diameter [mm]: 300 Brake Disc Thickness [mm] 12 Minimum thickness [mm] 10 Brake Disc Type: Solid Supplementary Article/Info 2: with bolts/screws

	kW				
VW - TIGUAN (AD1, AX1) 01/16→					
 Wheel Speed Sensor					
1.4 eHybrid	110 11/20→		Fitting Position: Front Axle Left	24.0711-5273.3	360303
1.4 TSI	92 - 01/16→07/18		Fitting Position: Front Axle Right	24.0711-5274.3	360304
1.5 TSI	96 - 07/18→		Required quantity: 2; Fitting Position: Rear Axle	2	24.0711-6337.3 360390
1.6 TDI	85 05/16→06/20				
2.0 TDI	81 - 05/16→				
	90				
1.4 TSI 4motion	110 05/16→07/18		Fitting Position: Front Axle Left	24.0711-5273.3	360303
2.0 TDI 4motion	130 - 04/16→		Fitting Position: Front Axle Right	24.0711-5274.3	360304
	176				
2.0 TSI 4motion	140 - 06/16→		Fitting Position: Rear Axle Left	24.0711-5401.3	360330
	180		Fitting Position: Rear Axle Right	24.0711-5402.3	360331
2.0 TSI R 4motion	235 11/20→				
2.0 TDI	110 01/16→07/20		Construction year from: 02/16 →; Fitting Position: Front Axle Left	24.0711-5273.3	360303
			Construction year from: 02/16 →; Fitting Position: Front Axle Right	24.0711-5274.3	360304
			Construction year from: 02/16 →; Required quantity: 2; Fitting Position: Rear Axle	2	24.0711-6337.3 360390
2.0 TDI 4motion	110 01/16→07/20		Construction year from: 02/16 →; Fitting Position: Front Axle Left	24.0711-5273.3	360303
2.0 TSI 4motion	132 01/16→		Construction year from: 02/16 →; Fitting Position: Front Axle Right	24.0711-5274.3	360304
			Construction year from: 02/16 →; Fitting Position: Rear Axle Left	24.0711-5401.3	360330
			Construction year from: 02/16 →; Fitting Position: Rear Axle Right	24.0711-5402.3	360331
Control Element, parking brake caliper					
1.4 eHybrid	110 11/20→		for PR number: 1KU / 1KZ; Fitting Position: Rear Axle Left	11.9282-1001.3	250159 Brake System: ATE
1.4 TSI	92 - 01/16→07/18				
	110		for PR number: 1KU / 1KZ; Fitting Position: Rear Axle Right	11.9282-1002.3	250160 Brake System: ATE
1.4 TSI 4motion	110 05/16→07/18				
1.5 TSI	96 - 07/18→				
	110				
1.6 TDI	85 05/16→06/20				
2.0 TDI	81 - 01/16→				
	110				
2.0 TDI 4motion	110 - 01/16→				
	176				
2.0 TSI 4motion	132 - 01/16→				
	180				
2.0 TSI R 4motion	235 11/20→				
VW - TIGUAN ALLSPACE (BW2, BJ2) 03/17→					
 Brake Disc					
1.4 TSI	110 06/17→07/21		for PR number: 1KU / 2EM; Fitting Position: Rear Axle	24.0112-0210.1	412210 Outer diameter [mm]: 300 Brake Disc Thickness [mm] 12 Minimum thickness [mm] 10 Brake Disc Type: Solid Supplementary Article/Info 2: with bolts/screws
1.4 TSI E100 Flex	110 07/17→				
1.5 TSI	110 09/18→				
2.0 TDI	110 06/17→				
2.0 TDI 4motion	140 - 06/17→				
	176				
2.0 TSI	137 04/17→				
2.0 TSI 4motion	132 - 03/17→				
	180				
2.0 TDI 4motion	110 06/17→		Fitting Position: Front Axle	24.0125-0158.1	425158 Outer diameter [mm]: 312 Brake Disc Thickness [mm] 25 Minimum thickness [mm] 22 Brake Disc Type: Vented Supplementary Article/Info 2: with bolts/screws
			for PR number: 1KU / 2EM; Fitting Position: Rear Axle	24.0112-0210.1	412210 Outer diameter [mm]: 300 Brake Disc Thickness [mm] 12 Minimum thickness [mm] 10 Brake Disc Type: Solid Supplementary Article/Info 2: with bolts/screws
 Wheel Speed Sensor					
1.4 TSI	110 06/17→07/21		Fitting Position: Front Axle Left	24.0711-5273.3	360303
1.4 TSI E100 Flex	110 07/17→		Fitting Position: Front Axle Right	24.0711-5274.3	360304
1.5 TSI	110 09/18→				
2.0 TDI	110 06/17→		Fitting Position: Rear Axle Left	24.0711-5401.3	360330
2.0 TDI 4motion	110 - 06/17→		Fitting Position: Rear Axle Right	24.0711-5402.3	360331
	176				
2.0 TSI	137 04/17→				
→					



	kW				
VW - TIGUAN VAN (5N_) 09/07→07/18					
 Brake Disc					
1.4 TSI	90 - 05/08→07/18 118	Fitting Position: Front Axle		24.0125-0158.1 425158	Outer diameter [mm]: 312 Brake Disc Thickness [mm] 25 Minimum thickness [mm] 22 Brake Disc Type: Vented Supplementary Article/Info 2: with bolts/screws
1.4 TSI 4motion	118 09/12→07/18				
2.0 TDI	81 - 11/09→07/18 103				
2.0 TDI 4motion	103 - 11/07→07/18 130				
2.0 TSI 4motion	125 - 11/09→07/18 155			24.0325-0158.1 525158	Outer diameter [mm]: 312 Brake Disc Thickness [mm] 25 Minimum thickness [mm] 22 Brake Disc Type: Vented Supplementary Article/Info 2: with bolts/screws
 Wheel Speed Sensor					
1.4 TSI 4motion	118 09/12→07/18	for PR number: 7X5 / 7X6;		24.0711-5401.3 360330	
2.0 TDI 4motion	103 - 11/07→07/18 130	Fitting Position: Rear Axle Left			
2.0 TSI 4motion	125 - 11/09→07/18 155	for PR number: 7X5 / 7X6; Fitting Position: Rear Axle Right		24.0711-5402.3 360331	
VW - TOUAREG (7LA, 7L6, 7L7) 10/02→01/13					
Guide Bolt, brake caliper					
2.5 R5 TDI	120 - 01/03→05/10 128	for PR number: 1KE; → Construction year to: 03/10; Required quantity: 2	2	11.8171-0008.1 990049	Brake System: ATE
3.0 TDI	155 04/06→05/10				
3.0 V6 TDI	165 - 11/04→05/10 176				
3.2 V6	162 10/02→11/06	Construction year from: 11/02 →; for PR number: 1KE; → Construction year to: 12/05; Required quantity: 2	2	11.8171-0008.1 990049	Brake System: ATE
3.2 V6	177 11/04→11/06	for PR number: 1KE; → Construction year to: 12/05; Required quantity: 2	2	11.8171-0008.1 990049	Brake System: ATE
3.6 V6 FSI	206 10/05→05/10	Construction year from: 01/06 → → Construction year to: 03/10; for PR number: 1KE; Required quantity: 2	2	11.8171-0008.1 990049	Brake System: ATE
4.2 V8	228 12/02→11/06	for PR number: 1KE; Required quantity: 2	2	11.8171-0008.1 990049	Brake System: ATE
4.2 V8 FSI	257 06/06→05/10	Construction year from: 12/06 → → Construction year to: 03/10; for PR number: 1KE; Required quantity: 2	2	11.8171-0008.1 990049	Brake System: ATE
5.0 R50 TDI	257 08/07→05/10	Construction year from: 01/08 → → Construction year to: 03/10; for PR number: 1KE; Required quantity: 2	2	11.8171-0008.1 990049	Brake System: ATE
5.0 V10 TDI	230 10/02→05/10	Construction year from: 11/02 →; for PR number: 1KE; → Construction year to: 03/10; Required quantity: 2	2	11.8171-0008.1 990049	Brake System: ATE
6.0 W12	331 08/04→05/10	for PR number: 1KE; → Construction year to: 11/06; Required quantity: 2	2	11.8171-0008.1 990049	Brake System: ATE
 Wheel Speed Sensor					
2.5 R5 TDI	120 - 01/03→05/10 128	→ Construction year to: 03/10; Fitting Position: Front Axle Left		24.0711-5401.3 360330	
3.0 TDI	155 04/06→05/10				
3.0 V6 TDI	165 - 11/04→05/10 176	→ Construction year to: 03/10; Fitting Position: Front Axle Right		24.0711-5402.3 360331	
		→ Construction year to: 03/10; Fitting Position: Rear Axle Left		24.0711-5401.3 360330	
		→ Construction year to: 03/10; Fitting Position: Rear Axle Right		24.0711-5402.3 360331	
3.2 V6	162 10/02→11/06	Construction year from: 11/02 → → Construction year to: 12/05; Fitting Position: Front Axle Left		24.0711-5401.3 360330	
		Construction year from: 11/02 → → Construction year to: 12/05; Fitting Position: Front Axle Right		24.0711-5402.3 360331	
		Construction year from: 11/02 → → Construction year to: 12/05; Fitting Position: Rear Axle Left		24.0711-5401.3 360330	
		Construction year from: 11/02 → → Construction year to: 12/05; Fitting Position: Rear Axle Right		24.0711-5402.3 360331	
→					





	kW			
VW - TOUAREG (7LA, 7L6, 7L7) 10/02→01/13				
 Wheel Speed Sensor				
3.2 V6	177 11/04→11/06	→ Construction year to: 12/05; Fitting Position: Front Axle Left	24.0711-5401.3 360330	
		→ Construction year to: 12/05; Fitting Position: Front Axle Right	24.0711-5402.3 360331	
		→ Construction year to: 12/05; Fitting Position: Rear Axle Left	24.0711-5401.3 360330	
		→ Construction year to: 12/05; Fitting Position: Rear Axle Right	24.0711-5402.3 360331	
3.6 V6 FSI	206 10/05→05/10	Construction year from: 01/06 → → Construction year to: 03/10; Fitting Position: Front Axle Left	24.0711-5401.3 360330	
		Construction year from: 01/06 → → Construction year to: 03/10; Fitting Position: Front Axle Right	24.0711-5402.3 360331	
		Construction year from: 01/06 → → Construction year to: 03/10; Fitting Position: Rear Axle Left	24.0711-5401.3 360330	
		Construction year from: 01/06 → → Construction year to: 03/10; Fitting Position: Rear Axle Right	24.0711-5402.3 360331	
4.2 V8	228 12/02→11/06	Fitting Position: Front Axle Left	24.0711-5401.3 360330	
		Fitting Position: Front Axle Right	24.0711-5402.3 360331	
		Fitting Position: Rear Axle Left	24.0711-5401.3 360330	
		Fitting Position: Rear Axle Right	24.0711-5402.3 360331	
4.2 V8 FSI	257 06/06→05/10	Construction year from: 12/06 → → Construction year to: 03/10; Fitting Position: Front Axle Left	24.0711-5401.3 360330	
		Construction year from: 12/06 → → Construction year to: 03/10; Fitting Position: Front Axle Right	24.0711-5402.3 360331	
		Construction year from: 12/06 → → Construction year to: 03/10; Fitting Position: Rear Axle Left	24.0711-5401.3 360330	
		Construction year from: 12/06 → → Construction year to: 03/10; Fitting Position: Rear Axle Right	24.0711-5402.3 360331	
5.0 R50 TDI	257 08/07→05/10	Construction year from: 01/08 → → Construction year to: 03/10; Fitting Position: Front Axle Left	24.0711-5401.3 360330	
		Construction year from: 01/08 → → Construction year to: 03/10; Fitting Position: Front Axle Right	24.0711-5402.3 360331	
		Construction year from: 01/08 → → Construction year to: 03/10; Fitting Position: Rear Axle Left	24.0711-5401.3 360330	
		Construction year from: 01/08 → → Construction year to: 03/10; Fitting Position: Rear Axle Right	24.0711-5402.3 360331	
5.0 V10 TDI	230 10/02→05/10	Construction year from: 11/02 → → Construction year to: 03/10; Fitting Position: Front Axle Left	24.0711-5401.3 360330	
		Construction year from: 11/02 → → Construction year to: 03/10; Fitting Position: Front Axle Right	24.0711-5402.3 360331	
		Construction year from: 11/02 → → Construction year to: 03/10; Fitting Position: Rear Axle Left	24.0711-5401.3 360330	
		Construction year from: 11/02 → → Construction year to: 03/10; Fitting Position: Rear Axle Right	24.0711-5402.3 360331	
6.0 W12	331 08/04→05/10	→ Construction year to: 11/06; Fitting Position: Front Axle Left	24.0711-5401.3 360330	
		→ Construction year to: 11/06; Fitting Position: Front Axle Right	24.0711-5402.3 360331	
		→ Construction year to: 11/06; Fitting Position: Rear Axle Left	24.0711-5401.3 360330	
		→ Construction year to: 11/06; Fitting Position: Rear Axle Right	24.0711-5402.3 360331	
VW - TOURAN (1T1, 1T2) 02/03→05/10				
Guide Sleeve Kit, brake caliper				
1.4 TSI	103 02/06→05/10	Construction year from: 09/06 → ; for PR number: 1ZE / 1ZP; Fitting Position: Front Axle	11.0101-5407.2 260011	Brake System: ATE
→				

	kW				
VW - TOURAN (1T1, 1T2) 02/03→05/10					
Guide Sleeve Kit, brake caliper					
1.4 TSI	103	02/06→05/10	Construction year from: 09/06 →; for PR number: 1LJ / 1ZA / 1ZD; Fitting Position: Front Axle	11.0101-5407.2 260011	Brake System: ATE
1.4 TSI	125	11/06→05/10	for PR number: 1ZE / 1ZP;	11.0101-5407.2 260011	Brake System: ATE
1.4 TSI EcoFuel	110	05/09→05/10	Fitting Position: Front Axle		
1.6	75	07/03→05/10	for PR number: 1LJ / 1ZA / 1ZD;	11.0101-5407.2 260011	Brake System: ATE
1.6 BiFuel	75	11/06→05/10	Fitting Position: Front Axle		
1.6 FSI	85	02/03→01/07			
1.9 TDI	66 -	02/03→05/10			
	77				
2.0 EcoFuel	80	02/06→05/09			
2.0 FSI	110	10/03→01/07			
2.0 TDI	103	12/05→05/10			
2.0 TDI 16V	103	08/03→05/10			
2.0 TDI	100	02/03→05/10	Construction year from: 08/03 →; for PR number: 1ZE / 1ZP; Fitting Position: Front Axle	11.0101-5407.2 260011	Brake System: ATE
			Construction year from: 08/03 →; for PR number: 1LJ / 1ZA / 1ZD; Fitting Position: Front Axle	11.0101-5407.2 260011	Brake System: ATE
2.0 TDI	125	12/05→05/10	Construction year from: 02/06 →; for PR number: 1ZE / 1ZP; Fitting Position: Front Axle	11.0101-5407.2 260011	Brake System: ATE
			Construction year from: 02/06 →; for PR number: 1LJ / 1ZA / 1ZD; Fitting Position: Front Axle	11.0101-5407.2 260011	Brake System: ATE
Guide Bolt, brake caliper					
1.4 TSI	103	02/06→05/10	Construction year from: 09/06 →; for PR number: 1LJ / 1ZA / 1ZD; Required quantity: 2	2 11.8171-0008.1 990049	Brake System: ATE
			Construction year from: 09/06 →; for PR number: 1ZE / 1ZP; Required quantity: 2	2 11.8171-0008.1 990049	Brake System: ATE
1.4 TSI	125	11/06→05/10	for PR number: 1ZE / 1ZP;	2 11.8171-0008.1 990049	Brake System: ATE
1.4 TSI EcoFuel	110	05/09→05/10	Required quantity: 2		
1.6	75	07/03→05/10	for PR number: 1LJ / 1ZA / 1ZD;	2 11.8171-0008.1 990049	Brake System: ATE
1.6 BiFuel	75	11/06→05/10	Required quantity: 2		
1.6 FSI	85	02/03→01/07			
1.9 TDI	66 -	02/03→05/10			
	77				
2.0 EcoFuel	80	02/06→05/09			
2.0 FSI	110	10/03→01/07			
2.0 TDI	103	12/05→05/10			
2.0 TDI 16V	103	08/03→05/10			
2.0 TDI	100	02/03→05/10	Construction year from: 08/03 →; for PR number: 1ZE / 1ZP; Required quantity: 2	2 11.8171-0008.1 990049	Brake System: ATE
			Construction year from: 08/03 →; for PR number: 1LJ / 1ZA / 1ZD; Required quantity: 2	2 11.8171-0008.1 990049	Brake System: ATE
2.0 TDI	125	12/05→05/10	Construction year from: 02/06 →; for PR number: 1ZE / 1ZP; Required quantity: 2	2 11.8171-0008.1 990049	Brake System: ATE
			Construction year from: 02/06 →; for PR number: 1LJ / 1ZA / 1ZD; Required quantity: 2	2 11.8171-0008.1 990049	Brake System: ATE
Brake Disc					
1.4 TSI	103	02/06→05/10	Construction year from: 09/06 →; for PR number: 1ZE / 1ZP; Fitting Position: Front Axle	24.0125-0145.1 425145	Outer diameter [mm]: 288 Brake Disc Thickness [mm] 25 Minimum thickness [mm] 22 Brake Disc Type: Vented Supplementary Article/Info 2: with bolts/screws
			Construction year from: 09/06 →; for PR number: 1LJ / 1ZA / 1ZD; Fitting Position: Front Axle	24.0125-0158.1 425158	Outer diameter [mm]: 312 Brake Disc Thickness [mm] 25 Minimum thickness [mm] 22 Brake Disc Type: Vented Supplementary Article/Info 2: with bolts/screws
				24.0325-0158.1 525158	Outer diameter [mm]: 312 Brake Disc Thickness [mm] 25 Minimum thickness [mm] 22 Brake Disc Type: Vented Supplementary Article/Info 2: with bolts/screws
→					



		kW					
VW - TOURAN (1T1, 1T2) 02/03→05/10							
 Brake Disc							
1.4 TSI	103	02/06→05/10	Construction year from: 09/06 →; for PR number: 1KS; Fitting Position: Rear Axle		24.0110-0356.1 410356	Outer diameter [mm]: 272 Brake Disc Thickness [mm] 9.7 Minimum thickness [mm] 8 Brake Disc Type: Solid Supplementary Article/Info 2: with bolts/screws	
					24.0310-0356.1 510356	Outer diameter [mm]: 272 Brake Disc Thickness [mm] 9.7 Minimum thickness [mm] 8 Brake Disc Type: Solid Supplementary Article/Info 2: with bolts/screws	
1.4 TSI 1.4 TSI EcoFuel 1.6 1.6 FSI 1.9 TDI	125 110 75 85 66 -	11/06→05/10 05/09→05/10 07/03→05/10 02/03→01/07 02/03→05/10	for PR number: 1ZE / 1ZP; Fitting Position: Front Axle		24.0125-0145.1 425145	Outer diameter [mm]: 288 Brake Disc Thickness [mm] 25 Minimum thickness [mm] 22 Brake Disc Type: Vented Supplementary Article/Info 2: with bolts/screws	
2.0 EcoFuel 2.0 FSI 2.0 TDI 2.0 TDI 16V	80 110 103 103	02/06→05/09 10/03→01/07 12/05→05/10 08/03→05/10	for PR number: 1LJ / 1ZA / 1ZD; Fitting Position: Front Axle		24.0125-0158.1 425158	Outer diameter [mm]: 312 Brake Disc Thickness [mm] 25 Minimum thickness [mm] 22 Brake Disc Type: Vented Supplementary Article/Info 2: with bolts/screws	
			for PR number: 1KS; Fitting Position: Rear Axle		24.0110-0356.1 410356	Outer diameter [mm]: 272 Brake Disc Thickness [mm] 9.7 Minimum thickness [mm] 8 Brake Disc Type: Solid Supplementary Article/Info 2: with bolts/screws	
					24.0310-0356.1 510356	Outer diameter [mm]: 272 Brake Disc Thickness [mm] 9.7 Minimum thickness [mm] 8 Brake Disc Type: Solid Supplementary Article/Info 2: with bolts/screws	
1.6 BiFuel	75	11/06→05/10	for PR number: 1ZE / 1ZP; Fitting Position: Front Axle		24.0125-0145.1 425145	Outer diameter [mm]: 288 Brake Disc Thickness [mm] 25 Minimum thickness [mm] 22 Brake Disc Type: Vented Supplementary Article/Info 2: with bolts/screws	
			for PR number: 1LJ / 1ZA / 1ZD; Fitting Position: Front Axle		24.0125-0158.1 425158	Outer diameter [mm]: 312 Brake Disc Thickness [mm] 25 Minimum thickness [mm] 22 Brake Disc Type: Vented Supplementary Article/Info 2: with bolts/screws	
			for PR number: 1KS; Fitting Position: Rear Axle		24.0110-0356.1 410356	Outer diameter [mm]: 272 Brake Disc Thickness [mm] 9.7 Minimum thickness [mm] 8 Brake Disc Type: Solid Supplementary Article/Info 2: with bolts/screws	
					24.0310-0356.1 510356	Outer diameter [mm]: 272 Brake Disc Thickness [mm] 9.7 Minimum thickness [mm] 8 Brake Disc Type: Solid Supplementary Article/Info 2: with bolts/screws	
2.0 TDI	100	02/03→05/10	Construction year from: 08/03 →; for PR number: 1ZE / 1ZP; Fitting Position: Front Axle		24.0125-0145.1 425145	Outer diameter [mm]: 288 Brake Disc Thickness [mm] 25 Minimum thickness [mm] 22 Brake Disc Type: Vented Supplementary Article/Info 2: with bolts/screws	
			Construction year from: 08/03 →; for PR number: 1LJ / 1ZA / 1ZD; Fitting Position: Front Axle		24.0125-0158.1 425158	Outer diameter [mm]: 312 Brake Disc Thickness [mm] 25 Minimum thickness [mm] 22 Brake Disc Type: Vented Supplementary Article/Info 2: with bolts/screws	



→

		kW							
VW - TOURAN (1T1, 1T2) 02/03→05/10									
 Brake Disc									
2.0 TDI	100	02/03→05/10	Construction year from: 08/03 →; for PR number: 1LJ / 1ZA / 1ZD; Fitting Position: Front Axle	24.0325-0158.1	525158	Outer diameter [mm]: 312 Brake Disc Thickness [mm] 25 Minimum thickness [mm] 22 Brake Disc Type: Vented Supplementary Article/Info 2: with bolts/screws			
			Construction year from: 08/03 →; for PR number: 1KS; Fitting Position: Rear Axle			24.0110-0356.1	410356	Outer diameter [mm]: 272 Brake Disc Thickness [mm] 9.7 Minimum thickness [mm] 8 Brake Disc Type: Solid Supplementary Article/Info 2: with bolts/screws	
2.0 TDI	125	12/05→05/10	Construction year from: 02/06 →; for PR number: 1ZE / 1ZP; Fitting Position: Front Axle	24.0125-0145.1	425145	Outer diameter [mm]: 288 Brake Disc Thickness [mm] 25 Minimum thickness [mm] 22 Brake Disc Type: Vented Supplementary Article/Info 2: with bolts/screws			
			Construction year from: 02/06 →; for PR number: 1LJ / 1ZA / 1ZD; Fitting Position: Front Axle			24.0125-0158.1	425158	Outer diameter [mm]: 312 Brake Disc Thickness [mm] 25 Minimum thickness [mm] 22 Brake Disc Type: Vented Supplementary Article/Info 2: with bolts/screws	
			Construction year from: 02/06 →; for PR number: 1KS; Fitting Position: Rear Axle					24.0110-0356.1	410356
2.0 TDI	125	12/05→05/10	Construction year from: 02/06 →; for PR number: 1LJ / 1ZA / 1ZD; Fitting Position: Front Axle	24.0125-0158.1	425158	Outer diameter [mm]: 312 Brake Disc Thickness [mm] 25 Minimum thickness [mm] 22 Brake Disc Type: Vented Supplementary Article/Info 2: with bolts/screws			
			Construction year from: 02/06 →; for PR number: 1KS; Fitting Position: Rear Axle			24.0310-0356.1	510356	Outer diameter [mm]: 272 Brake Disc Thickness [mm] 9.7 Minimum thickness [mm] 8 Brake Disc Type: Solid Supplementary Article/Info 2: with bolts/screws	
VW - TOURAN (1T3) 05/10→05/15									
Guide Sleeve Kit, brake caliper									
1.2 TSI	77	05/10→05/15	for PR number: 1ZE / 1ZP; Fitting Position: Front Axle	11.0101-5407.2	260011	Brake System: ATE			
1.4 TSI	103 - 125	05/10→05/15							
1.4 TSI EcoFuel	110	05/10→05/15	for PR number: 1LJ / 1ZA / 1ZD; Fitting Position: Front Axle	11.0101-5407.2	260011	Brake System: ATE			
1.6 TDI	66 - 77	05/10→05/15							
2.0 TDI	81 - 130	05/10→05/15							
Guide Bolt, brake caliper									
1.2 TSI	77	05/10→05/15	for PR number: 1ZE / 1ZP; Required quantity: 2	2	11.8171-0008.1	990049	Brake System: ATE		
1.4 TSI	103 - 125	05/10→05/15							
1.4 TSI EcoFuel	110	05/10→05/15	for PR number: 1LJ / 1ZA / 1ZD; Required quantity: 2	2	11.8171-0008.1	990049	Brake System: ATE		
1.6 TDI	66 - 77	05/10→05/15							
2.0 TDI	81 - 130	05/10→05/15							
 Brake Disc									
1.2 TSI	77	05/10→05/15	for PR number: 1ZE / 1ZP; Fitting Position: Front Axle	24.0125-0145.1	425145	Outer diameter [mm]: 288 Brake Disc Thickness [mm] 25 Minimum thickness [mm] 22 Brake Disc Type: Vented Supplementary Article/Info 2: with bolts/screws			
1.4 TSI	103 - 125	05/10→05/15							
1.4 TSI EcoFuel	110	05/10→05/15							
1.6 TDI	66 - 77	05/10→05/15							
2.0 TDI	81 - 130	05/10→05/15							
→									

	kW				
VW - TOURAN (1T3) 05/10→05/15					
 Brake Disc					
1.2 TSI	77	05/10→05/15	for PR number: 1LJ / 1ZA / 1ZD; Fitting Position: Front Axle	24.0125-0158.1 425158	Outer diameter [mm]: 312 Brake Disc Thickness [mm] 25 Minimum thickness [mm] 22 Brake Disc Type: Vented Supplementary Article/Info 2: with bolts/screws
1.4 TSI	103	05/10→05/15			
1.4 TSI EcoFuel	110	05/10→05/15			
1.6 TDI	66	05/10→05/15			
2.0 TDI	81	05/10→05/15			
		125		24.0325-0158.1 525158	Outer diameter [mm]: 312 Brake Disc Thickness [mm] 25 Minimum thickness [mm] 22 Brake Disc Type: Vented Supplementary Article/Info 2: with bolts/screws
		77			
		130			
			Fitting Position: Rear Axle	24.0110-0356.1 410356	Outer diameter [mm]: 272 Brake Disc Thickness [mm] 9.7 Minimum thickness [mm] 8 Brake Disc Type: Solid Supplementary Article/Info 2: with bolts/screws
				24.0310-0356.1 510356	Outer diameter [mm]: 272 Brake Disc Thickness [mm] 9.7 Minimum thickness [mm] 8 Brake Disc Type: Solid Supplementary Article/Info 2: with bolts/screws
VW - TOURAN (5T1) 05/15→					
 Brake Caliper					
1.0 TSI	85	12/18→	for PR number: 1ZA / 1ZD / 1ZK / 1ZL; Fitting Position: Front Axle Left	24.3571-1801.5 241387	Supplementary Article/Supplementary Info: without holder Brake Caliper Type: Fist-type Caliper
1.2 TSI	81	05/15→			
1.4 TSI	110	05/15→			
1.5 TSI	110	11/18→			
1.6 TDI	81	05/15→			
		85		24.3571-1802.5 241388	Supplementary Article/Supplementary Info: without holder Brake Caliper Type: Fist-type Caliper
		132			
		140			
		140			
 Brake Disc					
1.0 TSI	85	12/18→	for PR number: 1ZK / 1ZL; Fitting Position: Front Axle	24.0125-0158.1 425158	Outer diameter [mm]: 312 Brake Disc Thickness [mm] 25 Minimum thickness [mm] 22 Brake Disc Type: Vented Supplementary Article/Info 2: with bolts/screws
1.2 TSI	81	05/15→			
1.4 TSI	110	05/15→			
1.5 TSI	110	11/18→			
1.6 TDI	81	05/15→			
		85		24.0110-0356.1 410356	Outer diameter [mm]: 272 Brake Disc Thickness [mm] 9.7 Minimum thickness [mm] 8 Brake Disc Type: Solid Supplementary Article/Info 2: with bolts/screws
		132			
		140			
		140			
		140	Vehicle Equipment: for vehicles with electric parking brake; for PR number: 2EI / 2EM; Fitting Position: Rear Axle	24.0112-0210.1 412210	Outer diameter [mm]: 300 Brake Disc Thickness [mm] 12 Minimum thickness [mm] 10 Brake Disc Type: Solid Supplementary Article/Info 2: with bolts/screws
 Wheel Speed Sensor					
1.0 TSI	85	12/18→	Fitting Position: Front Axle Left	24.0711-5273.3 360303	
1.2 TSI	81	05/15→	Fitting Position: Front Axle Right	24.0711-5274.3 360304	
1.4 TSI	110	05/15→			
1.5 TSI	110	11/18→	Required quantity: 2;	2	24.0711-6337.3 360390
1.6 TDI	81	05/15→	Fitting Position: Rear Axle		
		85			
		132			
		140			
		140			
Control Element, parking brake caliper					
1.0 TSI	85	12/18→	Fitting Position: Rear Axle Left	11.9282-1001.3 250159	Brake System: ATE
1.2 TSI	81	05/15→	Fitting Position: Rear Axle Right	11.9282-1002.3 250160	Brake System: ATE
1.4 TSI	110	05/15→			
1.5 TSI	110	11/18→			
1.6 TDI	81	05/15→			
		85			
		132			
		140			
		140			

	kW				
VW - TOURAN VAN (1T1, 1T2) 02/03→05/10					
Guide Sleeve Kit, brake caliper					
1.9 TDI	66 - 08/03→05/10 77	for PR number: 1ZE / 1ZP; Fitting Position: Front Axle		11.0101-5407.2 260011	Brake System: ATE
2.0 EcoFuel	80 02/06→11/06	for PR number: 1LJ / 1ZA / 1ZD; Fitting Position: Front Axle		11.0101-5407.2 260011	Brake System: ATE
2.0 FSI	110 05/04→01/07				
2.0 TDi	103 08/03→05/10				
FSI	85 02/03→11/06				
2.0 TDI	100 02/03→05/10	Construction year from: 08/03 →; for PR number: 1ZE / 1ZP; Fitting Position: Front Axle		11.0101-5407.2 260011	Brake System: ATE
		Construction year from: 08/03 →; for PR number: 1LJ / 1ZA / 1ZD; Fitting Position: Front Axle		11.0101-5407.2 260011	Brake System: ATE
Guide Bolt, brake caliper					
1.9 TDI	66 - 08/03→05/10 77	for PR number: 1ZE / 1ZP; Required quantity: 2	2	11.8171-0008.1 990049	Brake System: ATE
2.0 EcoFuel	80 02/06→11/06	for PR number: 1LJ / 1ZA / 1ZD; Required quantity: 2	2	11.8171-0008.1 990049	Brake System: ATE
2.0 FSI	110 05/04→01/07				
2.0 TDi	103 08/03→05/10				
FSI	85 02/03→11/06				
2.0 TDI	100 02/03→05/10	Construction year from: 08/03 →; for PR number: 1ZE / 1ZP; Required quantity: 2	2	11.8171-0008.1 990049	Brake System: ATE
		Construction year from: 08/03 →; for PR number: 1LJ / 1ZA / 1ZD; Required quantity: 2	2	11.8171-0008.1 990049	Brake System: ATE
 Brake Disc					
1.9 TDI	66 - 08/03→05/10 77	for PR number: 1ZE / 1ZP; Fitting Position: Front Axle		24.0125-0145.1 425145	Outer diameter [mm]: 288 Brake Disc Thickness [mm] 25 Minimum thickness [mm] 22 Brake Disc Type: Vented Supplementary Article/Info 2: with bolts/screws
2.0 EcoFuel	80 02/06→11/06				
2.0 FSI	110 05/04→01/07	for PR number: 1LJ / 1ZA / 1ZD; Fitting Position: Front Axle		24.0125-0158.1 425158	Outer diameter [mm]: 312 Brake Disc Thickness [mm] 25 Minimum thickness [mm] 22 Brake Disc Type: Vented Supplementary Article/Info 2: with bolts/screws
2.0 TDi	103 08/03→05/10				
FSI	85 02/03→11/06				
				24.0325-0158.1 525158	Outer diameter [mm]: 312 Brake Disc Thickness [mm] 25 Minimum thickness [mm] 22 Brake Disc Type: Vented Supplementary Article/Info 2: with bolts/screws
		for PR number: 1KS; Fitting Position: Rear Axle		24.0110-0356.1 410356	Outer diameter [mm]: 272 Brake Disc Thickness [mm] 9.7 Minimum thickness [mm] 8 Brake Disc Type: Solid Supplementary Article/Info 2: with bolts/screws
				24.0310-0356.1 510356	Outer diameter [mm]: 272 Brake Disc Thickness [mm] 9.7 Minimum thickness [mm] 8 Brake Disc Type: Solid Supplementary Article/Info 2: with bolts/screws
2.0 TDI	100 02/03→05/10	Construction year from: 08/03 →; for PR number: 1ZE / 1ZP; Fitting Position: Front Axle		24.0125-0145.1 425145	Outer diameter [mm]: 288 Brake Disc Thickness [mm] 25 Minimum thickness [mm] 22 Brake Disc Type: Vented Supplementary Article/Info 2: with bolts/screws
		Construction year from: 08/03 →; for PR number: 1LJ / 1ZA / 1ZD; Fitting Position: Front Axle		24.0125-0158.1 425158	Outer diameter [mm]: 312 Brake Disc Thickness [mm] 25 Minimum thickness [mm] 22 Brake Disc Type: Vented Supplementary Article/Info 2: with bolts/screws
				24.0325-0158.1 525158	Outer diameter [mm]: 312 Brake Disc Thickness [mm] 25 Minimum thickness [mm] 22 Brake Disc Type: Vented Supplementary Article/Info 2: with bolts/screws
→					





		kW					
VW - TOURAN VAN (1T1, 1T2) 02/03→05/10							
 Brake Disc							
2.0 TDI	100	02/03→05/10	Construction year from: 08/03 →; for PR number: 1KS; Fitting Position: Rear Axle		24.0110-0356.1	410356	Outer diameter [mm]: 272 Brake Disc Thickness [mm] 9.7 Minimum thickness [mm] 8 Brake Disc Type: Solid Supplementary Article/Info 2: with bolts/screws
					24.0310-0356.1	510356	Outer diameter [mm]: 272 Brake Disc Thickness [mm] 9.7 Minimum thickness [mm] 8 Brake Disc Type: Solid Supplementary Article/Info 2: with bolts/screws
VW - TOURAN VAN (1T3) 05/10→05/15							
Guide Sleeve Kit, brake caliper							
1.2 TSI	77	05/10→05/15	for PR number: 1LJ / 1ZA / 1ZD; Fitting Position: Front Axle		11.0101-5407.2	260011	Brake System: ATE
1.4 TSI	103 - 125	05/10→05/15					
1.4 TSi EcoFuel	110	05/10→05/15	for PR number: 1ZE / 1ZP; Fitting Position: Front Axle		11.0101-5407.2	260011	Brake System: ATE
1.6 TDI	66 - 77	05/10→05/15					
2.0 TDi	125	05/10→01/13					
2.0 TDI	103	05/10→05/15					
Guide Bolt, brake caliper							
1.2 TSI	77	05/10→05/15	for PR number: 1ZE / 1ZP; Required quantity: 2		2	11.8171-0008.1	990049 Brake System: ATE
1.4 TSI	103 - 125	05/10→05/15					
1.4 TSi EcoFuel	110	05/10→05/15	for PR number: 1LJ / 1ZA / 1ZD; Required quantity: 2		2	11.8171-0008.1	990049 Brake System: ATE
1.6 TDI	66 - 77	05/10→05/15					
2.0 TDi	125	05/10→01/13					
2.0 TDI	103	05/10→05/15					
 Brake Disc							
1.2 TSI	77	05/10→05/15	for PR number: 1ZE / 1ZP; Fitting Position: Front Axle		24.0125-0145.1	425145	Outer diameter [mm]: 288 Brake Disc Thickness [mm] 25 Minimum thickness [mm] 22 Brake Disc Type: Vented Supplementary Article/Info 2: with bolts/screws
1.4 TSI	103 - 125	05/10→05/15					
1.4 TSi EcoFuel	110	05/10→05/15					
1.6 TDI	66 - 77	05/10→05/15					
2.0 TDi	125	05/10→01/13					
2.0 TDI	103	05/10→05/15	for PR number: 1LJ / 1ZA / 1ZD; Fitting Position: Front Axle		24.0125-0158.1	425158	Outer diameter [mm]: 312 Brake Disc Thickness [mm] 25 Minimum thickness [mm] 22 Brake Disc Type: Vented Supplementary Article/Info 2: with bolts/screws
			Fitting Position: Rear Axle		24.0110-0356.1	410356	Outer diameter [mm]: 272 Brake Disc Thickness [mm] 9.7 Minimum thickness [mm] 8 Brake Disc Type: Solid Supplementary Article/Info 2: with bolts/screws
					24.0310-0356.1	510356	Outer diameter [mm]: 272 Brake Disc Thickness [mm] 9.7 Minimum thickness [mm] 8 Brake Disc Type: Solid Supplementary Article/Info 2: with bolts/screws
VW - TOURAN VAN (5T1) 05/15→							
 Brake Caliper							
2.0 TDI	90 - 110	11/20→	for PR number: 1ZA / 1ZD / 1ZK / 1ZL; Fitting Position: Front Axle Left		24.3571-1801.5	241387	Supplementary Article/Supplementary Info: without holder Brake Caliper Type: Fist-type Caliper
			for PR number: 1ZA / 1ZD / 1ZK / 1ZL; Fitting Position: Front Axle Right		24.3571-1802.5	241388	Supplementary Article/Supplementary Info: without holder Brake Caliper Type: Fist-type Caliper



	kW				
VW - TOURAN VAN (5T1) 05/15→					
 Brake Disc					
2.0 TDI	90 - 11/20→ 110	for PR number: 1ZK / 1ZL; Fitting Position: Front Axle		24.0125-0158.1 425158	Outer diameter [mm]: 312 Brake Disc Thickness [mm] 25 Minimum thickness [mm] 22 Brake Disc Type: Vented Supplementary Article/Info 2: with bolts/screws
		for PR number: 2EG / 2EJ; Fitting Position: Rear Axle		24.0110-0356.1 410356	Outer diameter [mm]: 272 Brake Disc Thickness [mm] 9.7 Minimum thickness [mm] 8 Brake Disc Type: Solid Supplementary Article/Info 2: with bolts/screws
		Vehicle Equipment: for vehicles with electric parking brake; for PR number: 2EI / 2EM; Fitting Position: Rear Axle		24.0112-0210.1 412210	Outer diameter [mm]: 300 Brake Disc Thickness [mm] 12 Minimum thickness [mm] 10 Brake Disc Type: Solid Supplementary Article/Info 2: with bolts/screws
 Wheel Speed Sensor					
2.0 TDI	90 - 11/20→ 110	Fitting Position: Front Axle Left		24.0711-5273.3 360303	
		Fitting Position: Front Axle Right		24.0711-5274.3 360304	
		Required quantity: 2; Fitting Position: Rear Axle	2	24.0711-6337.3 360390	
Control Element, parking brake caliper					
2.0 TDI	90 - 11/20→ 110	Fitting Position: Rear Axle Left		11.9282-1001.3 250159	Brake System: ATE
		Fitting Position: Rear Axle Right		11.9282-1002.3 250160	Brake System: ATE
VW - TRANSPORTER III Bus 05/79→07/92					
Guide Bolt, brake caliper					
1.6 TD 1.7 D 1.9 2.1 2.1 Cat 2.1 i	51 08/84→07/92 42 10/86→07/92 44 - 08/82→07/92 66 64 - 08/84→07/92 82 70 06/89→07/92 68 07/89→07/92	Vehicle Identification Number from: 24-K-000001 →; Brake Caliper Type: Fist-type Caliper; Required quantity: 2; Fitting Position: Front Axle	2	11.8171-0008.1 990049	Brake System: ATE
1.6 TD Syncro 1.9 Syncro 2.1 Syncro	51 03/86→07/92 57 02/85→07/92 64 - 08/85→07/92 82	Vehicle Identification Number from: 24-J-105001 →; Required quantity: 2; Fitting Position: Front Axle	2	11.8171-0008.1 990049	Brake System: ATE
VW - TRANSPORTER III Platform/Chassis 05/79→12/92					
Guide Bolt, brake caliper					
1.6 TD 1.7 D 1.9 2.1 2.1 i	51 10/84→07/92 42 08/85→07/92 44 - 08/82→07/92 61 70 - 08/85→07/92 82 68 07/89→07/92	Vehicle Identification Number from: 24-K-000001 →; Brake Caliper Type: Fist-type Caliper; Required quantity: 2; Fitting Position: Front Axle	2	11.8171-0008.1 990049	Brake System: ATE
1.6 TD Syncro 1.9 Syncro 2.1 Syncro	51 03/86→07/92 57 12/84→07/92 70 - 08/85→07/92 82	Vehicle Identification Number from: 24-J-105001 →; Required quantity: 2; Fitting Position: Front Axle	2	11.8171-0008.1 990049	Brake System: ATE
VW - TRANSPORTER III Van 05/79→12/92					
Guide Bolt, brake caliper					
1.6 TD 1.7 D 1.9 2.1 2.1 i	51 10/84→07/92 42 08/84→07/92 44 - 10/82→07/92 66 70 - 08/85→07/92 82 68 07/89→07/92	Vehicle Identification Number from: 24-K-000001 →; Brake Caliper Type: Fist-type Caliper; Required quantity: 2; Fitting Position: Front Axle	2	11.8171-0008.1 990049	Brake System: ATE
1.6 TD Syncro 1.9 Syncro 2.1 Syncro	51 03/86→07/92 57 11/84→07/92 70 - 08/85→07/92 82	Vehicle Identification Number from: 24-J-105001 →; Required quantity: 2; Fitting Position: Front Axle	2	11.8171-0008.1 990049	Brake System: ATE
VW - TRANSPORTER IV Bus (70B, 70C, 7DB, 7DK, 70J, 70K, 7DC, 7DJ) 09/90→08/04					
Guide Bolt, brake caliper					
1.9 TD 2.0 →	50 10/92→04/03 62 09/90→04/03	Construction year from: 05/96 →; for PR number: 1LU;	2	11.8171-0008.1 990049	Brake System: ATE





	kW				
VW - TRANSPORTER IV Bus (70B, 70C, 7DB, 7DK, 70J, 70K, 7DC, 7DJ) 09/90→08/04					
Guide Bolt, brake caliper					
2.4 D	57	09/90→04/98	Required quantity: 2; Fitting Position: Front Axle		
2.5	81	09/90→06/03			
2.5 TDI	75	09/95→04/03	Construction year from: 05/97 →; → Vehicle Identification Number to: 70-1-000954; for PR number: 1LB; Required quantity: 2; Fitting Position: Front Axle	2	11.8171-0008.1 990049 Brake System: ATE
2.4 D	55	08/97→04/03	→ Vehicle Identification Number to: 70-1-000954; for PR number: 1LB; Required quantity: 2; Fitting Position: Front Axle	2	11.8171-0008.1 990049 Brake System: ATE
2.5 TDI	65 - 111	05/98→04/03			
2.8 VR6	150	04/00→04/03	for PR number: 1LU; Required quantity: 2; Fitting Position: Front Axle	2	11.8171-0008.1 990049 Brake System: ATE
2.4 D Syncro	57	10/92→09/98	Construction year from: 07/95 →; for PR number: 1LU; Required quantity: 2; Fitting Position: Front Axle	2	11.8171-0008.1 990049 Brake System: ATE
2.5 Syncro	81	08/92→04/03			
2.5	85	08/96→04/03	for PR number: 1LU; Required quantity: 2; Fitting Position: Front Axle	2	11.8171-0008.1 990049 Brake System: ATE
2.8 VR 6	103	11/95→04/00	Construction year from: 05/97 →; → Vehicle Identification Number to: 70-1-000954; for PR number: 1LB; Required quantity: 2; Fitting Position: Front Axle	2	11.8171-0008.1 990049 Brake System: ATE
2.5 Syncro	85	07/96→04/03	for PR number: 1LU; Required quantity: 2; Fitting Position: Front Axle	2	11.8171-0008.1 990049 Brake System: ATE
2.5 TDI Syncro	75	01/96→04/03			
VW - TRANSPORTER IV Platform/Chassis (70E, 70L, 70M, 7DE, 7DL, 7D 07/90→04/03					
Guide Bolt, brake caliper					
1.9 TD	50	10/92→04/03	Construction year from: 05/96 →; for PR number: 1LU; Required quantity: 2; Fitting Position: Front Axle	2	11.8171-0008.1 990049 Brake System: ATE
2.0	62	07/90→04/03			
2.4 D	57	09/90→04/98			
2.5	81	11/90→04/03			
2.5 TDI	75	09/95→04/03	Construction year from: 05/97 →; → Vehicle Identification Number to: 70-1-000954; for PR number: 1LB; Required quantity: 2; Fitting Position: Front Axle	2	11.8171-0008.1 990049 Brake System: ATE
2.4 D	55	08/97→04/03	→ Vehicle Identification Number to: 70-1-000954; for PR number: 1LB; Required quantity: 2; Fitting Position: Front Axle	2	11.8171-0008.1 990049 Brake System: ATE
2.5 TDI	65	05/98→04/03	for PR number: 1LU; Required quantity: 2; Fitting Position: Front Axle	2	11.8171-0008.1 990049 Brake System: ATE
2.4 D Syncro	57	10/92→09/98	Construction year from: 07/95 →; for PR number: 1LU; Required quantity: 2; Fitting Position: Front Axle	2	11.8171-0008.1 990049 Brake System: ATE
2.5 Syncro	81	11/92→11/01			
2.5	85	08/96→04/03	for PR number: 1LU; Required quantity: 2; Fitting Position: Front Axle	2	11.8171-0008.1 990049 Brake System: ATE
			Construction year from: 05/97 →; → Vehicle Identification Number to: 70-1-000954; for PR number: 1LB; Required quantity: 2; Fitting Position: Front Axle	2	11.8171-0008.1 990049 Brake System: ATE
2.5 Syncro	85	08/96→04/03	for PR number: 1LU; Required quantity: 2; Fitting Position: Front Axle	2	11.8171-0008.1 990049 Brake System: ATE
2.5 TDI Syncro	75	05/98→04/03			
VW - TRANSPORTER IV Van (70A, 70H, 7DA, 7DH) 07/90→04/03					
Guide Bolt, brake caliper					
1.9 TD	50	10/92→04/03	Construction year from: 05/96 →; for PR number: 1LU; Required quantity: 2; Fitting Position: Front Axle	2	11.8171-0008.1 990049 Brake System: ATE
2.0	62	07/90→04/03			
2.4 D	57	07/90→04/98			
2.5	81	11/90→04/03			
2.5 TDI	75	09/95→04/03	Construction year from: 05/97 →; → Vehicle Identification Number to: 70-1-000954; for PR number: 1LB; Required quantity: 2; Fitting Position: Front Axle	2	11.8171-0008.1 990049 Brake System: ATE
2.4 D	55	08/97→04/03	→ Vehicle Identification Number to: 70-1-000954; for PR number: 1LB; Required quantity: 2; Fitting Position: Front Axle	2	11.8171-0008.1 990049 Brake System: ATE
2.5 TDI	65 - 111	12/98→04/03			
→					

	kW				
VW - TRANSPORTER IV Van (70A, 70H, 7DA, 7DH) 07/90→04/03					
Guide Bolt, brake caliper					
2.8 VR6	150	06/00→04/03	Required quantity: 2; Fitting Position: Front Axle		
			for PR number: 1LU; Required quantity: 2; Fitting Position: Front Axle	2	11.8171-0008.1 990049 Brake System: ATE
2.4 D Syncro	57	10/92→09/98	Construction year from: 07/95 →; for PR number: 1LU; Required quantity: 2; Fitting Position: Front Axle	2	11.8171-0008.1 990049 Brake System: ATE
2.5	85	08/96→04/03	for PR number: 1LU; Required quantity: 2; Fitting Position: Front Axle	2	11.8171-0008.1 990049 Brake System: ATE
2.8 VR6	103	05/96→05/00	Construction year from: 05/97 →; → Vehicle Identification Number to: 70-1-000954; for PR number: 1LB; Required quantity: 2; Fitting Position: Front Axle	2	11.8171-0008.1 990049 Brake System: ATE
2.5 Syncro	81 -	01/96→04/03	for PR number: 1LU; Required quantity: 2; Fitting Position: Front Axle	2	11.8171-0008.1 990049 Brake System: ATE
	85				
2.5 TDI Syncro	75	09/95→04/03			
VW - TRANSPORTER V Bus (7HB, 7HJ, 7EB, 7EJ) 04/03→08/15					
Guide Bolt, brake caliper					
1.9 TDI	62 -	04/03→11/09	for PR number: 0WR; → Vehicle Identification Number to: 7H-8-027999; Required quantity: 2	2	11.8171-0008.1 990049 Brake System: ATE
	77				
2.0	85	11/03→08/15			
2.0 CNG	85	01/06→08/15			
2.5 TDi	120	11/03→11/09			
2.5 TDI	96 -	04/03→11/09			
	128				
2.5 TDI 4motion	96 -	07/04→11/09			
	128				
3.2 V6	170 -	02/04→11/09			
	173				
3.2 V6 4motion	170 -	11/03→12/09	Construction year from: 07/04 →; for PR number: 0WR; → Vehicle Identification Number to: 7H-8-027999; Required quantity: 2	2	11.8171-0008.1 990049 Brake System: ATE
	173				
 Cable Pull, parking brake					
1.9 TDI	62 -	04/03→11/09	Vehicle Identification Number from: 7H-7-000001 →; for PR number: 0WR / 0E2; Required quantity: 2; Fitting Position: Rear	2	24.3727-3408.2 583408 Length [mm]: 1,936
	77				
2.0	85	11/03→08/15			
2.0 BiTDI	132	09/09→08/15			
2.0 BiTDI 4motion	132	09/09→08/15			
2.0 CNG	85	01/06→08/15			
2.0 TDI	62 -	09/09→08/15			
	103				
2.0 TDI 4motion	100 -	09/09→08/15			
	103				
2.5 TDi	120	11/03→11/09			
2.5 TDI	96 -	04/03→11/09			
	128				
2.5 TDI 4motion	96 -	07/04→11/09			
	128				
3.2 V6	170 -	02/04→11/09			
	173				
3.2 V6 4motion	170 -	11/03→12/09			
	173				
VW - TRANSPORTER V Platform/Chassis (7JD, 7JE, 7JL, 7JY, 7JZ, 7FD 04/03→08/15					
Guide Bolt, brake caliper					
1.9 TDI	62 -	04/03→11/09	→ Vehicle Identification Number to: 7J-8-000788; for PR number: 0WR / 0E0 / 0E9; Required quantity: 2	2	11.8171-0008.1 990049 Brake System: ATE
	77				
2.0	85	11/03→05/13			
2.0 CNG	85	11/03→05/11			
2.5 TDI	96 -	04/03→11/09			
	128				
2.5 TDI 4motion	96	07/04→11/09			
3.2 V6	170 -	08/03→11/09			
	173				
2.5 TDI 4motion	128	04/04→11/09	Construction year from: 07/04 →; → Vehicle Identification Number to: 7J-8-000788; for PR number: 0WR / 0E0 / 0E9; Required quantity: 2	2	11.8171-0008.1 990049 Brake System: ATE
3.2 4motion	170	11/03→11/09	Construction year from: 07/04 →; for PR number: 0WR; → Vehicle Identification Number to: 7H-8-027999; Required quantity: 2	2	11.8171-0008.1 990049 Brake System: ATE

→

	kW							
VW - TRANSPORTER V Platform/Chassis (7JD, 7JE, 7JL, 7JY, 7JZ, 7FD 04/03→08/15)								
 Cable Pull, parking brake								
3.2 4motion	170	11/03→11/09	Vehicle Identification Number from: 7H-7-000001 →; for PR number: 0WR / 0E2; Required quantity: 2; Fitting Position: Rear	2	24.3727-3408.2 583408 Length [mm]: 1,936			
VW - TRANSPORTER V Van (7HA, 7HH, 7EA, 7EH) 04/03→								
Guide Bolt, brake caliper								
1.9 TDI	62	04/03→11/09	for PR number: 0WR; → Vehicle Identification Number to: 7H-8-027999; Required quantity: 2	2	11.8171-0008.1 990049 Brake System: ATE			
2.0	85	11/03→08/15						
2.0 BiFuel	85	05/11→08/15						
2.5 TDI	96	04/03→11/09						
2.5 TDI 4motion	96	07/04→11/09						
3.2 V6	170	04/03→11/09						
3.2 4motion	173	11/03→11/09	Construction year from: 07/04 →; for PR number: 0WR; → Vehicle Identification Number to: 7H-8-027999; Required quantity: 2	2	11.8171-0008.1 990049 Brake System: ATE			
3.2 V6 4motion	170	04/03→06/05						
 Cable Pull, parking brake								
1.9 TDI	62	04/03→11/09	Vehicle Identification Number from: 7H-7-000001 →; for PR number: 0WR / 0E2; Required quantity: 2; Fitting Position: Rear	2	24.3727-3408.2 583408 Length [mm]: 1,936			
2.0	85	11/03→08/15						
2.0 BiFuel	85	05/11→08/15						
2.0 BiTDI	132	09/09→08/15						
2.0 BiTDI 4motion	132	09/09→08/15						
2.0 TDI	62	09/09→08/15						
2.0 TDI 4motion	100	09/09→08/15						
2.5 TDI	96	04/03→11/09						
2.5 TDI 4motion	96	07/04→11/09						
3.2 4motion	173	11/03→11/09						
3.2 V6	170	04/03→11/09						
3.2 V6 4motion	170	04/03→06/05						
VW - T-ROC (A11, D11) 07/17→								
 Brake Caliper								
1.0 TSI	81	07/17→	for PR number: 1ZA / 1ZK / 1ZL; Fitting Position: Front Axle Left		24.3571-1801.5 241387 Supplementary Article/Supplementary Info: without holder Brake Caliper Type: Fist-type Caliper			
1.5 TSI	110	11/17→						
1.5 TSI 4motion	110	05/18→11/19						
1.6 TDI	85	03/18→06/21	for PR number: 1ZA / 1ZK / 1ZL; Fitting Position: Front Axle Right		24.3571-1802.5 241388 Supplementary Article/Supplementary Info: without holder Brake Caliper Type: Fist-type Caliper			
2.0 R 4motion	221	09/19→						
2.0 TDI	110	03/18→						
2.0 TDI 4motion	110	09/17→						
2.0 TDI SCR	85	11/20→						
2.0 TSI 4motion	140	07/17→						
 Brake Pad Set, disc brake								
1.0 TSI	81	07/17→	for PR number: 1ZJ / 9U0; Fitting Position: Front Axle		13.0460-2609.2 602609 Brake System: Lucas / TRW 25683 20,4 Wear Warning Contact: prepared for wear indicator / excl. wear warning contact			
1.5 TSI	110	11/17→						
1.5 TSI 4motion	110	05/18→11/19						
1.6 TDI	85	03/18→06/21						
2.0 R 4motion	221	09/19→						
2.0 TDI	110	03/18→			13.0470-2609.2 LD2609 Brake System: Lucas / TRW Wear Warning Contact: prepared for wear indicator / excl. wear warning contact Ceramic			
2.0 TDI 4motion	110	09/17→						
2.0 TDI SCR	85	11/20→						
2.0 TSI 4motion	140	07/17→						
2.0 TSI 4motion	140	07/17→						
 Brake Disc								
1.0 TSI	81	07/17→	for PR number: 1ZE / 1ZJ / 1ZQ; Fitting Position: Front Axle		24.0125-0145.1 425145 Outer diameter [mm]: 288 Brake Disc Thickness [mm] 25 Minimum thickness [mm] 22 Brake Disc Type: Vented Supplementary Article/Info 2: with bolts/screws			
1.5 TSI	110	11/17→						
1.5 TSI 4motion	110	05/18→11/19						
1.6 TDI	85	03/18→06/21						
2.0 R 4motion	221	09/19→						
2.0 TDI	110	03/18→						
→								

	kW				
VW - T-ROC (A11, D11) 07/17→					
 Brake Disc					
2.0 TDI 4motion	110 - 09/17→ 140		for PR number: 1ZA / 1ZB / 1ZK / 1ZL / 1ZU; Fitting Position: Front Axle	24.0125-0158.1 425158	Outer diameter [mm]: 312 Brake Disc Thickness [mm] 25 Minimum thickness [mm] 22 Brake Disc Type: Vented Supplementary Article/Info 2: with bolts/screws
2.0 TDI SCR	85 11/20→				
2.0 TSI 4motion	140 07/17→				
			for PR number: 1KE / 2EC / 2EG / 2EJ / 2EL / 0N4; Fitting Position: Rear Axle	24.0110-0356.1 410356	Outer diameter [mm]: 272 Brake Disc Thickness [mm] 9.7 Minimum thickness [mm] 8 Brake Disc Type: Solid Supplementary Article/Info 2: with bolts/screws
 Wheel Speed Sensor					
1.0 TSI	81 09/20→		Fitting Position: Front Axle Left	24.0711-5273.3 360303	
2.0 TDI SCR	85 11/20→		Fitting Position: Front Axle Right	24.0711-5274.3 360304	
			Required quantity: 2; for PR number: 0N4; Fitting Position: Rear Axle	2 24.0711-5402.3 360331	
1.0 TSI	85 07/17→11/20		Fitting Position: Front Axle Left	24.0711-5273.3 360303	
1.5 TSI	110 11/17→		Fitting Position: Front Axle Right	24.0711-5274.3 360304	
1.6 TDI	85 03/18→06/21				
2.0 TDI	110 03/18→		Required quantity: 2; for PR number: 0N4; Construction year from: 11/19 →; Fitting Position: Rear Axle	2 24.0711-5402.3 360331	
			Required quantity: 2; for PR number: 0N4; Fitting Position: Rear Axle	2 24.0711-6337.3 360390	
1.5 TSI 4motion	110 05/18→11/19		Fitting Position: Front Axle Left	24.0711-5273.3 360303	
			Fitting Position: Front Axle Right	24.0711-5274.3 360304	
			for PR number: 0N4; Fitting Position: Rear Axle Left	24.0711-5401.3 360330	
			for PR number: 0N4; Fitting Position: Rear Axle Right	24.0711-5402.3 360331	
2.0 R 4motion	221 09/19→		Fitting Position: Front Axle Left	24.0711-5273.3 360303	
2.0 TDI 4motion	110 - 09/17→ 140		Fitting Position: Front Axle Right	24.0711-5274.3 360304	
2.0 TSI 4motion	140 07/17→		for PR number: 0N4; Fitting Position: Rear Axle Left	24.0711-5401.3 360330	
			for PR number: 0N4; Construction year from: 12/19 →; Fitting Position: Rear Axle Left	24.0711-5401.3 360330	
			for PR number: 0N4; Construction year from: 12/19 →; Fitting Position: Rear Axle Right	24.0711-5402.3 360331	
			for PR number: 0N4; Fitting Position: Rear Axle Right	24.0711-5402.3 360331	
Control Element, parking brake caliper					
1.0 TSI	81 - 07/17→ 85		for PR number: 1KE / 2EC / 2EG / 2EJ / 2EL; Fitting Position: Rear Axle Left	11.9282-1001.3 250159	Brake System: ATE
1.5 TSI	110 11/17→				
1.5 TSI 4motion	110 05/18→11/19		for PR number: 1KE / 2EC / 2EG / 2EJ / 2EL; Fitting Position: Rear Axle Right	11.9282-1002.3 250160	Brake System: ATE
1.6 TDI	85 03/18→06/21				
2.0 R 4motion	221 09/19→				
2.0 TDI	110 03/18→				
2.0 TDI 4motion	110 - 09/17→ 140				
2.0 TDI SCR	85 11/20→				
2.0 TSI 4motion	140 07/17→				
VW - T-ROC Convertible (AC7, AC8) 12/19→					
 Brake Caliper					
1.0 TSI	81 - 12/19→ 85		for PR number: 1ZK; Fitting Position: Front Axle Left	24.3571-1801.5 241387	Supplementary Article/Supplementary Info: without holder Brake Caliper Type: Fist-type Caliper
1.5 TSI	110 12/19→				
			for PR number: 1ZK; Fitting Position: Front Axle Right	24.3571-1802.5 241388	Supplementary Article/Supplementary Info: without holder Brake Caliper Type: Fist-type Caliper
→					

	kW				
VW - T-ROC Convertible (AC7, AC8) 12/19→					
 Brake Disc					
1.0 TSI	81 - 12/19→		for PR number: 1ZJ; Fitting Position: Front Axle	24.0125-0145.1 425145	Outer diameter [mm]: 288 Brake Disc Thickness [mm] 25 Minimum thickness [mm] 22 Brake Disc Type: Vented Supplementary Article/Info 2: with bolts/screws
1.5 TSI	85				
	110 12/19→				
			for PR number: 1ZK; Fitting Position: Front Axle	24.0125-0158.1 425158	Outer diameter [mm]: 312 Brake Disc Thickness [mm] 25 Minimum thickness [mm] 22 Brake Disc Type: Vented Supplementary Article/Info 2: with bolts/screws
			for PR number: 2EJ; Vehicle Equipment: for vehicles with electric parking brake; Fitting Position: Rear Axle	24.0110-0356.1 410356	Outer diameter [mm]: 272 Brake Disc Thickness [mm] 9.7 Minimum thickness [mm] 8 Brake Disc Type: Solid Supplementary Article/Info 2: with bolts/screws
 Wheel Speed Sensor					
1.0 TSI	81 - 12/19→		Fitting Position: Front Axle Left	24.0711-5273.3 360303	
	85		Fitting Position: Front Axle Right	24.0711-5274.3 360304	
1.5 TSI	110 12/19→		Required quantity: 2; Fitting Position: Rear Axle	2 24.0711-6337.3 360390	
Control Element, parking brake caliper					
1.0 TSI	81 - 12/19→		Fitting Position: Rear Axle Left	11.9282-1001.3 250159	Brake System: ATE
	85		Fitting Position: Rear Axle Right	11.9282-1002.3 250160	Brake System: ATE
1.5 TSI	110 12/19→				
VW - UP! (121, 122, BL1, BL2, BL3, 123) 08/11→					
Guide Bolt, brake caliper					
1.0	44 - 08/11→08/20		Construction year from: 12/11 →; for PR number: 1LA / 1ZQ; Required quantity: 2	2 11.8171-0008.1 990049	Brake System: ATE
	55				
1.0	48 08/20→		for PR number: 1LA / 1ZQ; Required quantity: 2	2 11.8171-0008.1 990049	Brake System: ATE
1.0 EcoFuel	50 11/12→				
1.0 GTI	85 11/17→				
1.0 TSI	66 05/16→09/18				
e-Up	60 - 07/13→		Construction year from: 09/13 →; for PR number: 1LA / 1ZQ; Required quantity: 2	2 11.8171-0008.1 990049	Brake System: ATE
	61				
 Brake Pad Set, disc brake					
1.0	44 - 08/11→08/20		for PR number: 1ZE; Construction year from: 05/16 →; Fitting Position: Front Axle	13.0460-2609.2 602609	Brake System: Lucas / TRW 25683 20,4 Wear Warning Contact: prepared for wear indicator / excl. wear warning contact
	55				
1.0 EcoFuel	50 11/12→				
e-Up	60 - 07/13→				
	61				
				13.0470-2609.2 LD2609	Brake System: Lucas / TRW Wear Warning Contact: prepared for wear indicator / excl. wear warning contact Ceramic
1.0	48 08/20→		for PR number: 1ZE; Fitting Position: Front Axle	13.0460-2609.2 602609	Brake System: Lucas / TRW 25683 20,4 Wear Warning Contact: prepared for wear indicator / excl. wear warning contact
1.0 GTI	85 11/17→				
1.0 TSI	66 05/16→09/18				
				13.0470-2609.2 LD2609	Brake System: Lucas / TRW Wear Warning Contact: prepared for wear indicator / excl. wear warning contact Ceramic
 Wheel Speed Sensor					
1.0	44 - 08/11→08/20		Construction year from: 12/11 →; Fitting Position: Front Axle Left	24.0711-5273.3 360303	
	55		Construction year from: 12/11 →; Fitting Position: Front Axle Right	24.0711-5274.3 360304	
1.0	48 08/20→		Fitting Position: Front Axle Left	24.0711-5273.3 360303	
1.0 EcoFuel	50 11/12→		Fitting Position: Front Axle Right	24.0711-5274.3 360304	
1.0 GTI	85 11/17→				
1.0 TSI	66 05/16→09/18				
e-Up	60 - 07/13→		Construction year from: 09/13 →; Fitting Position: Front Axle Left	24.0711-5273.3 360303	
	61		Construction year from: 09/13 →; Fitting Position: Front Axle Right	24.0711-5274.3 360304	

	kW				
VW - VENTO (1H2) 11/91→09/98					
Guide Bolt, brake caliper					
2.0	85	11/91→09/98	Construction year from: 05/96 →; Required quantity: 2; Fitting Position: Front Axle	2	11.8171-0008.1 990049 Brake System: ATE
2.0 GL	79	05/96→12/97	Required quantity: 2; Fitting Position: Front Axle	2	11.8171-0008.1 990049 Brake System: ATE
2.8 VR6	128	01/92→09/98	Vehicle Identification Number from: 1H-S-560001 →; Required quantity: 2; Fitting Position: Front Axle	2	11.8171-0008.1 990049 Brake System: ATE











- EN** Technical translations
- DE** Technische Übersetzungen
- ES** Traducciones técnicas
- FR** Traductions techniques
- IT** Traduzioni tecniche

08/2022

Technical translations

Technische Übersetzungen - Traducciones tecnicas - Traductions techniques - Traduzioni tecniche

EN		EN	
	Brake Master Cylinder	Article number of recommended accessories	Article number of recommended accessories
	Brake Hose		
	Cable Pull, parking brake	ATE Ceramic	additional article information, ATE Ceramic
	Brake Shoe Set, parking brake	Automatic Transmission	Automatic Transmission
	Brake Caliper	Axle	Axle
	Brake Pad Set, disc brake	Bolt Hole Circle Ø [mm]	Bolt Hole Circle Ø [mm]
	Brake Disc	Bore Ø [mm]	Bore Ø [mm]
	Wheel Brake Cylinder	Brake Caliper Colour	Brake Caliper Colour
	Wheel Speed Sensor	Brake Caliper Type	Brake Caliper Type
+ ABS	for vehicles with ABS	Brake caliper with adjusting element for electr. handbrake	Brake caliper with adjusting element for electr. handbrake
+ ESP	for vehicles with ESP		
14"	14"	Brake diameter, inside [mm]	Brake diameter, inside [mm]
15"	15"		
16"	16"		
17" plus	17" plus	Brake Disc Thickness [mm]	Brake Disc Thickness [mm]
17"	17"		
18"	18"		
6-Speed Automatic Transmission	6-Speed Automatic Transmission	Brake Disc Type	Brake Disc Type
6-Speed Manual Transmission	6-Speed Manual Transmission	Brake Size	Brake Size
- ABS	for vehicles without ABS	Brake System	Brake System
Alloyed / High-carbon	Alloyed / High-carbon	Brake Type	Brake Type
Aluminium	Aluminium	Braking System	Braking System
Aluminium brake caliper	Aluminium brake caliper	Cast Aluminium	Cast Aluminium
		Cast iron brake caliper	Cast iron brake caliper
		CB compatible package	CB compatible package
		Centering Diameter [mm]	Centering Diameter [mm]

Technical translations

Technische Übersetzungen - Traducciones técnicas - Traductions techniques - Traduzioni tecniche

EN		EN	
Centre	Centre	for brake disc diameter [mm]	for brake disc diameter [mm]
Coated	Coated	for brake disc thickness [mm]	for brake disc thickness [mm]
Code	Code	for cruise control system	for cruise control system
Comfort Equipment Variant (trim package)	Comfort Equipment Variant (trim package)	for dual tyres	for dual tyres
Construction year from →	Construction year from	for government vehicles	for government vehicles
Country-spec. model	Country-spec. model	for increased payload	for increased payload
Country specific article information	Country specific article information	for left-hand drive vehicles	for left-hand drive vehicles
Country specific package and status data	Country specific package and status data	for police vehicles	for police vehicles
Diameter [mm]	Diameter [mm]	for PR number	for PR number
Disc Brake	Disc Brake	for right-hand drive vehicles	for right-hand drive vehicles
Electric	Electric	for RPO number (vehicle manufacturing date) from →	for RPO number (vehicle manufacturing date) from
Engine Code	Engine Code	for SA code	for SA code
Equipment Code	Equipment Code	for single tyres	for single tyres
- ESP	for vehicles without ESP	for taxis	for taxis
excl. wear warning contact	excl. wear warning contact	for vehicles with air conditioning	for vehicles with air conditioning
External Thread [mm]	External Thread [mm]	for vehicles with AMG Sports Package	for vehicles with AMG Sports Package
Fist-type Caliper	Fist-type Caliper	for vehicles with autom. distance control	for vehicles with autom. distance control
Fist-type Caliper (2 pistons)	Fist-type Caliper (2 pistons)		
Fitting Position	Fitting Position		
Flange Hole Diameter [mm]	Flange Hole Diameter [mm]		
for armoured vehicles	for armoured vehicles		

Technical translations

Technische Übersetzungen - Traducciones técnicas - Traductions techniques - Traduzioni tecniche

EN	EN
for vehicles with disc brakes on the rear axle for vehicles with disc brakes on the rear axle	for vehicles with parking assistant system for vehicles with parking assistant system
for vehicles with drum brakes on the rear axle for vehicles with drum brakes on the rear axle	for vehicles with reinforced brakes for vehicles with reinforced brakes
for vehicles with electric parking brake for vehicles with electric parking brake	for vehicles with sports brake system for vehicles with sports brake system
for vehicles with increased ground clearance for vehicles with increased ground clearance	for vehicles with sports package for vehicles with sports package
for vehicles without 3rd seating row for vehicles without 3rd seating row	for vehicles with sports suspension for vehicles with sports suspension
for vehicles without AMG sports package for vehicles without AMG sports package	for vehicles with torsion bar suspension for vehicles with torsion bar suspension
for vehicles without ceramic brakes for vehicles without ceramic brakes	France France
for vehicles without electric parking brake for vehicles without electric parking brake	Front Axle Front Axle
for vehicles without M-sport brakes for vehicles without M-sport brakes	Front Axle Left Front Axle Left
for vehicles without Performance brakes for vehicles without Performance brakes	Front Axle Right Front Axle Right
for vehicles without sports brake system for vehicles without sports brake system	Height [mm] Height [mm]
for vehicles without sports package for vehicles without sports package	Height 1 [mm] Height 1 [mm]
for vehicles without sports suspension for vehicles without sports suspension	Height 2 [mm] Height 2 [mm]
	High-carbon High-carbon
	Hub Diameter [mm] Hub Diameter [mm]
	incl. wear warning contact incl. wear warning contact
	inner inner
	Inner diameter [mm] Inner diameter [mm]
	Internal Thread [mm] Internal Thread [mm]
	Internal Thread 1 [mm] Internal Thread 1 [mm]

Technical translations

Technische Übersetzungen - Traducciones tecnicas - Traductions techniques - Traduzioni tecniche

EN		EN	
Internal Thread 2 [mm]	Internal Thread 2 [mm]	not for special-purpose vehicles	not for special-purpose vehicles
Left-/right-hand drive vehicles	Left-/right-hand drive vehicles	not for taxis	not for taxis
Length [mm]	Length [mm]	not for vehicles with reinforced brakes	not for vehicles with reinforced brakes
Length 1 [mm]	Length 1 [mm]	not prepared for wear indicator	not prepared for wear indicator
Length 2 [mm]	Length 2 [mm]	Number of bolts/screws	Number of bolts/screws
Machining	Machining	Number of connectors	Number of connectors
Manual Transmission	Manual Transmission	Number of Doors	Number of Doors
Manufacturer Restriction	Manufacturer Restriction	Number of Holes	Number of Holes
MAPP code available	MAPP code available	Number of wear indicators [per axle]	Number of wear indicators [per axle]
Material	Material	Observe dimensions	Observe dimensions
Minimum thickness [mm]	Minimum thickness [mm]	Operating Mode	Operating Mode
Multilink Axle	Multilink Axle	Outer diameter [mm]	Outer diameter [mm]
No. of holes 2	No. of holes 2	paired article number	paired article number
not for armoured vehicles	not for armoured vehicles	Payload	Payload
not for brake caliper colour	not for brake caliper colour	Piston Diameter [mm]	Piston Diameter [mm]
not for government vehicles	not for government vehicles	PowerDisc	additional article information, Power-Disc
not for increased payload	not for increased payload	prepared for wear indicator	prepared for wear indicator
not for police vehicles	not for police vehicles	Production date from →	Production date from
not for rim size [in]	not for rim size [in]	Produkttyp vorhanden	Produkttyp vorhanden
not for SA code	not for SA code	Reached Quality Gates	Reached Quality Gates









Technical translations

Technische Übersetzungen - Traducciones tecnicas - Traductions techniques - Traduzioni tecniche

EN		EN	
Rear	Rear	Trim Level	Trim Level
Rear Axle	Rear Axle	Turkey	Turkey
Rear Axle Left	Rear Axle Left	Tyres	Tyres
Rear Axle Right	Rear Axle Right	Unreached Quality Gates	Unreached Quality Gates
Red	Red	usage number	usage number
Red/Silver	Red/Silver	Vehicle Equipment	Vehicle Equipment
replacement part	replacement part	Vehicle Identification Number from →	Vehicle Identification Number from
Required quantity	Required quantity	Vehicle Production Country	Vehicle Production Country
Rigid Axle	Rigid Axle	Warning Contact Length [mm]	Warning Contact Length [mm]
Rim Hole Number	Rim Hole Number	Wear Warning Contact	Wear Warning Contact
Rim Size [in]	Rim Size [in]	Wheelbase [mm]	Wheelbase [mm]
Russia-made	Russia	Width [mm]	Width [mm]
Service exchange part	Service exchange part	Width 1 [mm]	Width 1 [mm]
Silver	Silver	Width 2 [mm]	Width 2 [mm]
Solid	Solid	with accessories	with accessories
Spanner size 1 [mm]	Spanner size 1 [mm]	with acoustic wear warning	with acoustic wear warning
Special Purpose Vehicle	Special Purpose Vehicle	with anti-squeak plate	with anti-squeak plate
Spring Type	Spring Type	with bolts/screws	with bolts/screws
Supplementary Article/ Info 2	Supplementary Article/Info 2	with brake caliper screws	with brake caliper screws
Supplementary Article/ Supplementary Info	Supplementary Article/Supplementary Info	with brake pads	with brake pads
Surface	Surface	with holder	with holder
Suspension	Suspension	with hollow screw	with hollow screw
Test Mark	Test Mark		
Thickness [mm]	Thickness [mm]		
Thread Size	Thread Size		
Transmission Type	Transmission Type		

Technical translations

Technische Übersetzungen - Traducciones tecnicas - Traductions techniques - Traduzioni tecniche

EN	DE
without brake fluid reservoir without brake fluid reservoir	 Hauptbremszylinder
without cable without cable	 Bremsschlauch
without hollow screw without hollow screw	 Seilzug, Feststellbremse
without lever without lever	 Bremsbackensatz, Feststellbremse
with seal with seal	 Bremssattel
Yes Yes	 Bremsbelagsatz, Scheibenbremse
→ Construction year to Construction year to	 Bremsscheibe
→ for DAM number up to for DAM number up to	 Radbremszylinder
→ for RPO number (vehicle manufacturing date) up to for RPO number (vehicle manufacturing date) up to	 Raddrehzahlsensor
→ Vehicle Identification Number to Vehicle Identification Number to	+ ABS für Fahrzeuge mit ABS
	+ ESP für Fahrzeuge mit ESP
	14" 14"
	15" 15"
	16" 16"
	17" plus 17" plus
	17" 17"
	18" 18"
	6-Speed Automatic Transmission Getriebeautomatik 6 Gang
	6-Speed Manual Transmission Schaltgetriebe 6 Gang
	- ABS für Fahrzeuge ohne ABS
	Alloyed / High-carbon legiert/hochgekohlt
	Aluminium Aluminium
	Aluminium brake caliper Bremssattel aus Aluminium

Technical translations

Technische Übersetzungen - Traducciones tecnicas - Traductions techniques - Traduzioni tecniche

DE		DE	
Article number of recommended accessories	Artikelnummer des empfohlenen Zubehörs	Centre	mitte
ATE Ceramic	Artikelzusatzbezeichnung, ATE Ceramic	Coated	beschichtet
Automatic Transmission	Automatikgetriebe	Code	Baumuster
Axle	Achse	Comfort Equipment Variant (trim package)	Komfortausstattung
Bolt Hole Circle Ø [mm]	Lochkreis-Ø [mm]	Construction year from →	Baujahr ab
Bore Ø [mm]	Bohrung-Ø [mm]	Country-spec. model	Länderausführung
Brake Caliper Colour	Bremssattelfarbe	Country specific article information	Länderspezifische Artikelinformation
Brake Caliper Type	Bremssattelausführung	Country specific package and status data	Länderspezifische Verpackungs- und Status-Informationen
Brake caliper with adjusting element for electr. hand-brake	Bremssattel mit Stellelement für elektr. Feststellbremse	Diameter [mm]	Durchmesser [mm]
Brake diameter, inside [mm]	Bremstrommeldurchmesser innen [mm]	Disc Brake	Scheibenbremse
Brake Disc Thickness [mm]	Bremsscheibendicke [mm]	Electric	elektrisch
Brake Disc Type	Bremsscheibenart	Engine Code	Motorcode
Brake Size	Bremsengröße	Equipment Code	Ausstattungs-Code
Brake System	Bremssystem	- ESP	für Fahrzeuge ohne ESP
Brake Type	Bremsenart	excl. wear warning contact	exkl. Verschleißwarnkontakt
Braking System	Bremsanlage	External Thread [mm]	Außengewinde [mm]
Cast Aluminium	Aluguss	Fist-type Caliper	Faustsattel
Cast iron brake caliper	Bremssattel aus Gusseisen	Fist-type Caliper (2 pistons)	Faustsattel(2-Kolben)
CB compatible package	SB gerechte Verpackung	Fitting Position	Einbauseite
Centering Diameter [mm]	Zentrierungsdurchmesser [mm]	Flange Hole Diameter [mm]	Flanschlochdurchmesser [mm]
		for armoured vehicles	für gepanzerte Fahrzeuge

Technical translations

Technische Übersetzungen - Traducciones tecnicas - Traductions techniques - Traduzioni tecniche

DE	DE
for brake disc diameter [mm] für Bremsscheibendurchmesser [mm]	for vehicles with disc brakes on the rear axle für Fahrzeuge mit Scheibenbremse an der Hinterachse
for brake disc thickness [mm] für Bremsscheibendicke [mm]	for vehicles with drum brakes on the rear axle für Fahrzeuge mit Trommelbremse an der Hinterachse
for cruise control system für Geschwindigkeitsregelanlage	for vehicles with electric parking brake für Fahrzeuge mit elektrischer Feststellbremse
for dual tyres für Doppelbereifung	for vehicles with increased ground clearance für Fahrzeuge mit erhöhter Bodenfreiheit
for government vehicles für Behördenfahrzeuge	for vehicles without 3rd seating row für Fahrzeuge ohne 3. Sitzreihe
for increased payload für erhöhte Nutzlast	for vehicles without AMG sports package für Fahrzeuge ohne AMG-Sportpaket
for left-hand drive vehicles für Linkslenker	for vehicles without ceramic brakes für Fahrzeuge ohne Keramikbremse
for police vehicles für Polizeifahrzeuge	for vehicles without electric parking brake für Fahrzeuge ohne elektrische Feststellbremse
for PR number für PR-Nummer	for vehicles without M-sport brakes für Fahrzeuge ohne M-Sportbremse
for right-hand drive vehicles für Rechtslenker	for vehicles without Performance brakes für Fahrzeuge ohne Performance Bremse
for RPO number (vehicle manufacturing date) from → für Organisationsnummer ab	for vehicles without sports brake system für Fahrzeuge ohne Sportbremsanlage
for SA code für SA Code	for vehicles without sports package für Fahrzeuge ohne Sportpaket
for single tyres für Einfachbereifung	for vehicles without sports suspension für Fahrzeuge ohne Sportfahrwerk
for taxis für Taxifahrzeuge	
for vehicles with air conditioning für Fahrzeuge mit Klimaanlage	
for vehicles with AMG Sports Package für Fahrzeuge mit AMG-Sportpaket	
for vehicles with autom. distance control für Fahrzeuge mit autom. Distanzregelung	

Technical translations

Technische Übersetzungen - Traducciones tecnicas - Traductions techniques - Traduzioni tecniche

DE		DE	
for vehicles with parking assistant system	für Fahrzeuge mit Parkassistenzsystem	Internal Thread 2 [mm]	Innengewinde 2 [mm]
for vehicles with reinforced brakes	für Fahrzeuge mit verstärkter Bremse	Left-/right-hand drive vehicles	Links-/Rechtslenker
for vehicles with sports brake system	für Fahrzeuge mit Sportbremsanlage	Length [mm]	Länge [mm]
for vehicles with sports package	für Fahrzeuge mit Sportpaket	Length 1 [mm]	Länge 1 [mm]
for vehicles with sports suspension	für Fahrzeuge mit Sportfahrwerk	Length 2 [mm]	Länge 2 [mm]
for vehicles with torsion bar suspension	für Fahrzeuge mit Drehstabfederung	Machining	Bearbeitung
France	Frankreich	Manual Transmission	Schaltgetriebe
Front Axle	Vorderachse	Manufacturer Restriction	Herstellereinschränkung
Front Axle Left	Vorderachse links	MAPP code available	MAPP-Code vorhanden
Front Axle Right	Vorderachse rechts	Material	Material
Height [mm]	Höhe [mm]	Minimum thickness [mm]	Mindestdicke [mm]
Height 1 [mm]	Höhe 1 [mm]	Multilink Axle	Multi-link Achse
Height 2 [mm]	Höhe 2 [mm]	No. of holes 2	Lochanzahl 2
High-carbon	hochgekohlt	not for armoured vehicles	nicht für gepanzerte Fahrzeuge
Hub Diameter [mm]	Nabendurchmesser [mm]	not for brake caliper colour	nicht für Bremssattelfarbe
incl. wear warning contact	inkl. Verschleißwarnkontakt	not for government vehicles	nicht für Behördenfahrzeuge
inner	innen	not for increased payload	nicht für erhöhte Nutzlast
Inner diameter [mm]	Innendurchmesser [mm]	not for police vehicles	nicht für Polizeifahrzeuge
Internal Thread [mm]	Innengewinde [mm]	not for rim size [in]	nicht für Felgenreöße [Zoll]
Internal Thread 1 [mm]	Innengewinde 1 [mm]	not for SA code	nicht für SA Code

Technical translations

Technische Übersetzungen - Traducciones tecnicas - Traductions techniques - Traduzioni tecniche

DE		DE	
not for special-purpose vehicles	nicht für Sonderfahrzeuge	Rear Axle	Hinterachse
not for taxis	nicht für Taxifahrzeuge	Rear Axle Left	Hinterachse links
not for vehicles with reinforced brakes	nicht für Fahrzeuge mit verstärkter Bremse	Rear Axle Right	Hinterachse rechts
not prepared for wear indicator	nicht für Verschleißwarnanzeiger vorbereitet	Red	rot
Number of bolts/screws	Anzahl der Schrauben	Red/Silver	rot/silber
Number of connectors	Anschlussanzahl	replacement part	Austauschteil
Number of Doors	Türenanzahl	Required quantity	benötigte Stückzahl
Number of Holes	Lochanzahl	Rigid Axle	Starrachse
Number of wear indicators [per axle]	Anzahl Verschleißanzeiger [pro Achse]	Rim Hole Number	Felge Lochzahl
Observe dimensions	Abmessungen beachten	Rim Size [in]	Felgengröße [Zoll]
Operating Mode	Betriebsart	Russia-made	Russland
Outer diameter [mm]	Außendurchmesser [mm]	Service exchange part	Austauschteil
paired article number	paarige Artikelnummer	Silver	silber
Payload	Nutzlast	Solid	Voll
Piston Diameter [mm]	Kolbendurchmesser [mm]	Spanner size 1 [mm]	Schlüsselweite 1 [mm]
PowerDisc	Artikelzusatzbezeichnung, PowerDisc	Special Purpose Vehicle	Sondereinsatz-Fzg
prepared for wear indicator	für Verschleißwarnanzeiger vorbereitet	Spring Type	Federungsart
Production date from →	Produktionsdatum ab	Supplementary Article/ Info 2	Ergänzungsartikel/Ergänzende Info 2
Produkttyp vorhanden	Produkttyp vorhanden	Supplementary Article/ Supplementary Info	Ergänzungsartikel/Ergänzende Info
Reached Quality Gates	Erfüllte Qualitätsstufen	Surface	Oberfläche
Rear	hinten	Suspension	Fahrwerk
		Test Mark	Prüfzeichen
		Thickness [mm]	Dicke/Stärke [mm]
		Thread Size	Gewindemaß
		Transmission Type	Getriebeart
		Trim Level	Ausstattungsvariante



Technical translations

Technische Übersetzungen - Traducciones tecnicas - Traductions techniques - Traduzioni tecniche

DE		DE	
Turkey	Türkei	without cable	ohne Kabel
Tyres	Bereifung	without hollow screw	ohne Hohlschraube
Unreached Quality Gates	Nicht erfüllte Qualitätsstufen	without lever	ohne Hebel
usage number	Gebrauchsnummer	with seal	mit Dichtung
Vehicle Equipment	Fahrzeugausstattung	Yes	Ja
Vehicle Identification Number from	Fahrgestellnummer ab	→ Construction year to	Baujahr bis
→		→ for DAM number up to	für DAM-Nummer bis
Vehicle Production Country	Fahrzeugproduktionsland	→ for RPO number (vehicle manufacturing date) up to	für Organisationsnummer bis
Warning Contact Length [mm]	Warnkontaktlänge [mm]	→ Vehicle Identification Number to	Fahrgestellnummer bis
Wear Warning Contact	Verschleißwarnkontakt		
Wheelbase [mm]	Radstand [mm]		
Width [mm]	Breite [mm]		
Width 1 [mm]	Breite 1 [mm]		
Width 2 [mm]	Breite 2 [mm]		
with accessories	mit Zubehör		
with acoustic wear warning	mit akustischer Verschleißwarnung		
with anti-squeak plate	mit Anti-Quietsch-Blech		
with bolts/screws	mit Schrauben		
with brake caliper screws	mit Bremssattelschrauben		
with brake pads	mit Bremsbelägen		
with holder	mit Halter		
with hollow screw	mit Hohlschraube		
without brake fluid reservoir	ohne Bremsflüssigkeitsbehälter		

Technical translations

Technische Übersetzungen - Traducciones técnicas - Traductions techniques - Traduzioni tecniche

ES		ES	
	Cilindro principal de freno	Article number of recommended accessories	Nº art. de accesorio recomendado
	Tubo flexible de frenos	ATE Ceramic	Denominación adicional del artículo, ATE Ceramic
	Cable de accionamiento, freno de estacionamiento	Automatic Transmission	Transmisión automática
	Juego de zapatas de frenos, freno de estacionamiento	Axle	Eje
	Pinza de freno	Bolt Hole Circle Ø [mm]	corona de agujeros - Ø [mm]
	Juego de pastillas de freno	Bore Ø [mm]	Taladro Ø [mm]
	Disco de freno	Brake Caliper Colour	Color pinza freno
	Cilindro de freno de rueda	Brake Caliper Type	Tipo de pinza de freno
	Sensor de velocidad de la rueda	Brake caliper with adjusting element for electr. hand-brake	Pinza del freno con accionador con freno de detención electr
+ ABS	para vehículos con ABS	Brake diameter, inside [mm]	Diámetro interior de tambor de freno [mm]
+ ESP	para vehículos con ESP	Brake Disc Thickness [mm]	Espesor de disco de frenos [mm]
14"	14"	Brake Disc Type	Tipo de disco de frenos
15"	15"	Brake Size	Tamaño freno
16"	16"	Brake System	Sistema de frenos
17" plus	17" plus	Brake Type	Tipo de freno
17"	17"	Braking System	Frenos
18"	18"	Cast Aluminium	Fundición de aluminio
6-Speed Automatic Transmission	Automático, 6 vel.	Cast iron brake caliper	Pinza de frenos de hierro fundido
6-Speed Manual Transmission	Caja de cambios manual, 6 marchas	CB compatible package	Embalaje apto para autoservicio
- ABS	para vehículos sin ABS	Centering Diameter [mm]	Diámetro de centrado [mm]
Alloyed / High-carbon	aleado/alt. carburado		
Aluminium	Aluminio		
Aluminium brake caliper	Pinza de frenos de aluminio		

Technical translations

Technische Übersetzungen - Traducciones técnicas - Traductions techniques - Traduzioni tecniche

ES		ES	
Centre	centro	for brake disc diameter [mm]	para diámetro disco de freno [mm]
Coated	revestido	for brake disc thickness [mm]	para espesor de disco [mm]
Code	Tipo	for cruise control system	para instalación reguladora de velocidad
Comfort Equipment Variant (trim package)	Equipamiento de confort	for dual tyres	para neumáticos gemelos
Construction year from →	año construcción desde	for government vehicles	para vehículos admon. pública
Country-spec. model	Modelo por país	for increased payload	para carga útil aumentada
Country specific article information	Información específica del país sobre el artículo	for left-hand drive vehicles	para vehic. dirección izquierda
Country specific package and status data	Información específica del país sobre el embalaje y sobre el estado	for police vehicles	para vehículo de policía
Diameter [mm]	Diámetro [mm]	for PR number	Número de PR
Disc Brake	Discos	for right-hand drive vehicles	para vehíc. dirección a la derecha
Electric	eléctrico	for RPO number (vehicle manufacturing date) from →	para números de organización desde
Engine Code	Código de motor	for SA code	para código SA
Equipment Code	Código de equipamiento	for single tyres	para neumáticos sencillos
- ESP	para vehículos sin ESP	for taxis	para taxis
excl. wear warning contact	excl. contacto de avisador de desgaste	for vehicles with air conditioning	para vehículos con climatizador
External Thread [mm]	Rosca exterior [mm]	for vehicles with AMG Sports Package	para vehículos con paquete sport AMG
Fist-type Caliper	Montura de puño	for vehicles with autom. distance control	para vehículos con regulación automática de distancia
Fist-type Caliper (2 pistons)	Montura de puño (2 émbolos)		
Fitting Position	Lado de montaje		
Flange Hole Diameter [mm]	Diám. taladro brida [mm]		
for armoured vehicles	para vehículos blindados		

Technical translations

Technische Übersetzungen - Traducciones técnicas - Traductions techniques - Traduzioni tecniche

ES	ES
for vehicles with disc brakes on the rear axle para vehículos con freno de disco en eje trasero	for vehicles with parking assistant system para vehículos con auxiliar de aparcamiento
for vehicles with drum brakes on the rear axle para vehículos con freno de tambor en eje trasero	for vehicles with reinforced brakes para vehículos con freno reforzado
for vehicles with electric parking brake para vehículos con freno de estacionamiento electrónico	for vehicles with sports brake system para vehículos con sistema de frenos deportivos
for vehicles with increased ground clearance para vehículos con altura libre aumentada	for vehicles with sports package para vehículos con paquete sport
for vehicles without 3rd seating row para vehículos sin 3 hileras de asientos	for vehicles with sports suspension para vehículos con chasis deportivo
for vehicles without AMG sports package para vehículos sin paquete deportivo AMG	for vehicles with torsion bar suspension para veh. con barra de torsión
for vehicles without ceramic brakes para vehículos sin frenos de cerámica	France Francia
for vehicles without electric parking brake para vehículos sin freno de estacionamiento electrónico	Front Axle Eje delantero
for vehicles without M-sport brakes Para vehículos sin frenos deportivos M	Front Axle Left Eje delantero, izquierda
for vehicles without Performance brakes para vehículos sin frenos alto rendimiento	Front Axle Right Eje delantero, derecha
for vehicles without sports brake system para vehículos sin sistema de frenos deportivos	Height [mm] Altura [mm]
for vehicles without sports package para vehículos sin paquete sport	Height 1 [mm] Altura 1 [mm]
for vehicles without sports suspension para vehículos sin chasis deportivo	Height 2 [mm] Altura 2 [mm]
	High-carbon altamente carbonizado
	Hub Diameter [mm] Diámetro cubo[mm]
	incl. wear warning contact con contacto avisador de desgaste
	inner interior
	Inner diameter [mm] Diámetro interior [mm]
	Internal Thread [mm] Rosca interior [mm]
	Internal Thread 1 [mm] Rosca interior 1 [mm]

Technical translations

Technische Übersetzungen - Traducciones técnicas - Traductions techniques - Traduzioni tecniche

ES		ES	
Internal Thread 2 [mm]	Rosca interior 2 [mm]	not for special-purpose vehicles	no para veh. especiales
Left-/right-hand drive vehicles	Vehículo con dirección a la izquierda / derecha	not for taxis	no para taxis
Length [mm]	Longitud [mm]	not for vehicles with reinforced brakes	no para vehículos con frenos reforzados
Length 1 [mm]	Longitud 1 [mm]	not prepared for wear indicator	no preparado para indicador de desgaste
Length 2 [mm]	Longitud 2 [mm]	Number of bolts/screws	cantidad de tornillos
Machining	Procesamiento	Number of connectors	Número de conexiones
Manual Transmission	Caja de cambios manual	Number of Doors	Número de puertas
Manufacturer Restriction	Restricción de fabricante	Number of Holes	Número de orificios
MAPP code available	Code MAPP disponible	Number of wear indicators [per axle]	cantidad indicadores de desgaste [por eje]
Material	Material	Observe dimensions	Observar dimensiones
Minimum thickness [mm]	Espesor mínimo [mm]	Operating Mode	Tipo de servicio
Multilink Axle	Eje multilink	Outer diameter [mm]	Diámetro exterior [mm]
No. of holes 2	Cantidad taladros 2	paired article number	Referencia artículo par
not for armoured vehicles	no para vehículos blindados	Payload	Carga útil
not for brake caliper colour	no para color pinza freno	Piston Diameter [mm]	Diámetro del pistón [mm]
not for government vehicles	no para veh. admon. pública	PowerDisc	Denominación adicional del artículo, PowerDisc
not for increased payload	no para carga útil aumentada	prepared for wear indicator	preparado para indicador desgaste
not for police vehicles	no para veh.policía	Production date from →	fecha de producción desde
not for rim size [in]	no para dimensión de llantas	Produkttyp vorhanden	Produkttyp vorhanden
not for SA code	no para código SA	Reached Quality Gates	Erfüllte Qualitätsstufen









Technical translations

Technische Übersetzungen - Traducciones técnicas - Traductions techniques - Traduzioni tecniche

ES		ES	
Rear	posterior	Trim Level	Variante de equipamiento
Rear Axle	Eje trasero	Turkey	Turquía
Rear Axle Left	Eje trasero izquierda	Tyres	Neumáticos
Rear Axle Right	Eje trasero, derecha	Unreached Quality Gates	Nicht erfüllte Qualitätsstufen
Red	rojo	usage number	Número de uso
Red/Silver	rojo/plata	Vehicle Equipment	Equipamiento de vehículo
replacement part	Recambio	Vehicle Identification Number from	nº de chasis desde
Required quantity	Número de piezas necesarias	→	
Rigid Axle	Eje rígido	Vehicle Production Country	País producción vehículo
Rim Hole Number	Llanta, nº de taladros	Warning Contact Length [mm]	Longitud contacto de aviso [mm]
Rim Size [in]	Tamaño de llanta [in]	Wear Warning Contact	Contacto avisador de desgaste
Russia-made	Rusia	Wheelbase [mm]	Distancia entre ejes [mm]
Service exchange part	Pieza de intercambio	Width [mm]	Ancho [mm]
Silver	plateado	Width 1 [mm]	Ancho 1 [mm]
Solid	Macizo	Width 2 [mm]	Ancho 2 [mm]
Spanner size 1 [mm]	Ancho de llave 1 [mm]	with accessories	con accesorios
Special Purpose Vehicle	Vehículo especial	with acoustic wear warning	con avisador acústico de desgaste
Spring Type	Tipo de suspensión	with anti-squeak plate	Chapa antichirridos
Supplementary Article/ Info 2	Artículo complementario / información complementaria 2	with bolts/screws	con tornillos
Supplementary Article/ Supplementary Info	Artículo complementario/Información complementaria	with brake caliper screws	con tornillos pinza freno
Surface	Superficie	with brake pads	sin forro de frenos
Suspension	Suspensión	with holder	con soporte
Test Mark	Homologación	with hollow screw	con tornillo hueco
Thickness [mm]	Espesor [mm]		
Thread Size	Medida de rosca		
Transmission Type	Clase de caja de cambios		

Technical translations

Technische Übersetzungen - Traducciones técnicas - Traductions techniques - Traduzioni tecniche

ES	FR
without brake fluid reservoir sin depósito líquido frenos	 Maître-cylindre de frein
without cable sin cable	 Flexible de frein
without hollow screw sin tornillo hueco	 Tirette à câble, frein de stationnement
without lever sin palanca	 Jeu de mâchoires de frein, frein de stationnement
with seal con junta	 Étrier de frein
Yes sí	 Kit de plaquettes de frein, frein à disque
→ Construction year to año construcción hasta	 Disque de frein
→ for DAM number up to para número DAM hasta	 Cilindre de roue
→ for RPO number (vehicle manufacturing date) up to para n.º de org. hasta	 Capteur de vitesse de roue
→ Vehicle Identification Number to nº de chasis hasta	+ ABS pour véhicules avec système antiblo-cage
	+ ESP pour véhicules avec ESP
	14" 14"
	15" 15"
	16" 16"
	17" plus 17" plus
	17" 17"
	18" 18"
	6-Speed Automatic Transmission Boîte automatique à 6 vitesses
	6-Speed Manual Transmission Boîte de vitesses manuelle à 6 vitesses
	- ABS pour véhicules sans système antiblo-cage
	Alloyed / High-carbon allié/carbonisé
	Aluminium Aluminium
	Aluminium brake caliper Étrier de frein en aluminium

Technical translations

Technische Übersetzungen - Traducciones técnicas - Traductions techniques - Traduzioni tecniche

FR		FR	
Article number of recommended accessories	Référence de l'accessoire recommandé	Centre	centre
ATE Ceramic	Designation d'article complémentaire, ATE Ceramic	Coated	revêtu
Automatic Transmission	Boîte automatique	Code	Modèle
Axle	Essieu	Comfort Equipment Variant (trim package)	Équipement de confort
Bolt Hole Circle Ø [mm]	Cercle de perçage -Ø [mm]	Construction year from →	Année à partir de
Bore Ø [mm]	Alésage-Ø [mm]	Country-spec. model	Type de pays
Brake Caliper Colour	Couleur de l'étrier	Country specific article information	Informations articles spécifiques aux pays
Brake Caliper Type	Type d'étrier de frein	Country specific package and status data	Informations d'emballage et d'état spécifiques aux pays
Brake caliper with adjusting element for electr. hand-brake	Étrier de frein + élément d'ajustage pr frein de stationnemt	Diameter [mm]	Diamètre [mm]
Brake diameter, inside [mm]	Diamètre intérieur du tambour de frein [mm]	Disc Brake	Frein à disque
Brake Disc Thickness [mm]	Épaisseur du disque de frein [mm]	Electric	électrique
Brake Disc Type	Type de disque de frein	Engine Code	Code moteur
Brake Size	Dimension des freins	Equipment Code	Code d'équipement
Brake System	Système de freinage	- ESP	pour véhicules sans ESP
Brake Type	Type de freinage	excl. wear warning contact	contact de signal d'usure exclu
Braking System	Dispositif de freinage	External Thread [mm]	Filetage extérieur [mm]
Cast Aluminium	Fonte d'aluminium	Fist-type Caliper	Étrier flottant
Cast iron brake caliper	Étrier de frein en fonte	Fist-type Caliper (2 pistons)	Étrier flottant (2 pistons)
CB compatible package	Emballage LS	Fitting Position	Côté d'assemblage
Centering Diameter [mm]	Diamètre du centrage [mm]	Flange Hole Diameter [mm]	Diamètre du trou de bride [mm]
		for armoured vehicles	pour véhicules blindés

Technical translations

Technische Übersetzungen - Traducciones técnicas - Traductions techniques - Traduzioni tecniche

FR	FR
for brake disc diameter [mm] pour diamètre du disque de frein [mm]	for vehicles with disc brakes on the rear axle pour véhicules avec frein à disques à l'essieu arrière
for brake disc thickness [mm] pour épaisseur de disque de frein [mm]	for vehicles with drum brakes on the rear axle pour véhicules avec frein à tambour à l'essieu arrière
for cruise control system pour régulateur de vitesse	for vehicles with electric parking brake pour véhicules avec frein d'arrêt électrique
for dual tyres pour pneus doubles	for vehicles with increased ground clearance pour véhicules avec garde au sol augmentée
for government vehicles pour véhicules d'administration	for vehicles without 3rd seating row pour véhicules sans 3ième rangée de sièges
for increased payload pour charge utile surélevée	for vehicles without AMG sports package pour véhicules sans paquet-sport AMG
for left-hand drive vehicles pour véhicules avec direction à gauche	for vehicles without ceramic brakes pour véhicules sans frein en céramique
for police vehicles pour voitures de police	for vehicles without electric parking brake pour véhicules sans frein d'arrêt électrique
for PR number pour numéro PR	for vehicles without M-sport brakes pour véhicules sans système de freinage sport M
for right-hand drive vehicles pour véhicules avec direction à droite	for vehicles without Performance brakes pour véhicules sans frein Performance
for RPO number (vehicle manufacturing date) from → pour n° OPR(date de fabrication du véhicule) à partir de	for vehicles without sports brake system pour véhicules sans système de freinage sport
for SA code pour SA code	for vehicles without sports package pour véhicules sans équipement sport
for single tyres pour pneus simples	for vehicles without sports suspension pour véhicules sans châssis sportif
for taxis pour taxis	
for vehicles with air conditioning pour véhicules avec système de climatisation	
for vehicles with AMG Sports Package pour véhicules avec équipement-sport AMG	
for vehicles with autom. distance control pour véhicules avec régulation de distance autom.	

Technical translations

Technische Übersetzungen - Traducciones tecnicas - Traductions techniques - Traduzioni tecniche

FR		FR	
for vehicles with parking assistant system	pour véhicules avec assistance par-tronic	Internal Thread 2 [mm]	Taraudage 2 [mm]
for vehicles with reinforced brakes	pour véhicules avec frein assisté	Left-/right-hand drive vehicles	Véhicule avec direction à gauche ou à droite
for vehicles with sports brake system	pour véhicules avec système de freinage sport	Length [mm]	Longueur [mm]
for vehicles with sports package	pour véhicules avec équipement sport	Length 1 [mm]	Longueur 1 [mm]
for vehicles with sports suspension	pour véhicules avec châssis sportif	Length 2 [mm]	Longueur 2 [mm]
for vehicles with torsion bar suspension	pour véhicules avec suspension à barres de torsion	Machining	Traitement
France	France	Manual Transmission	boîte de vitesses manuelle
Front Axle	Essieu avant	Manufacturer Restriction	Montage d'origine
Front Axle Left	Essieu avant gauche	MAPP code available	MAPP-Code existant
Front Axle Right	Essieu avant droit	Material	Matériel
Height [mm]	Hauteur [mm]	Minimum thickness [mm]	Épaisseur minimum [mm]
Height 1 [mm]	Hauteur 1 [mm]	Multilink Axle	Essieu multilink
Height 2 [mm]	Hauteur 2 [mm]	No. of holes 2	Nombre de trous 2
High-carbon	à haute teneur en carbone	not for armoured vehicles	pas pour véhicules blindés
Hub Diameter [mm]	Diamètre du moyeu [mm]	not for brake caliper colour	pas pour couleur de l'étrier-frein
incl. wear warning contact	contact de signal d'usure inclu	not for government vehicles	pas pour véhicules de l'administration
inner	intérieur	not for increased payload	non pour charge utile surélevée
Inner diameter [mm]	Diamètre intérieur [mm]	not for police vehicles	pas pour voitures de police
Internal Thread [mm]	Taraudage [mm]	not for rim size [in]	pas pour dimension de jante [pouce]
Internal Thread 1 [mm]	Taraudage 1 [mm]	not for SA code	pas pour SA code

Technical translations

Technische Übersetzungen - Traducciones técnicas - Traductions techniques - Traduzioni tecniche

FR		FR	
not for special-purpose vehicles	pas pour véhicules spéciaux	Rear	arrière
not for taxis	pas pour taxis	Rear Axle	Essieu arrière
not for vehicles with reinforced brakes	pas pour véhicules avec frein assisté	Rear Axle Left	Essieu arrière gauche
not prepared for wear indicator	non préparé pour indicateur d'usure	Rear Axle Right	Essieu arrière droit
Number of bolts/screws	Nombre de vis	Red	rouge
Number of connectors	Nombre de connexions	Red/Silver	rouge/argenté
Number of Doors	Nombre de portes	replacement part	Pièce de rechange
Number of Holes	Nombre de trous	Required quantity	Nombre de pièces nécessaires
Number of wear indicators [per axle]	Nombre d'indicateurs d'usure [par essieu]	Rigid Axle	Essieu rigide
Observe dimensions	Respecter les dimensions	Rim Hole Number	Jante, nombre de trous
Operating Mode	Type de fonctionnement	Rim Size [in]	Dimension de la jante [pouces]
Outer diameter [mm]	Diamètre extérieur [mm]	Russia-made	Russie
paired article number	Numéro d'article en paire	Service exchange part	Echange standard
Payload	Charge utile	Silver	argent
Piston Diameter [mm]	Diamètre du piston [mm]	Solid	plein
PowerDisc	Designation d'article complémentaire, PowerDisc	Spanner size 1 [mm]	Largeur de clé 1 [mm]
prepared for wear indicator	préparé pour indicateur d'usure	Special Purpose Vehicle	Véhicule à usage spécial
Production date from →	Date de production à partir de	Spring Type	Type de suspension
Produkttyp vorhanden	Produkttyp vorhanden	Supplementary Article/ Info 2	Article complémentaire / Info complémentaire 2
Reached Quality Gates	Erfüllte Qualitätsstufen	Supplementary Article/ Supplementary Info	Article complémentaire/Info complémentaire
		Surface	Surface
		Suspension	Châssis
		Test Mark	Marque de conformité
		Thickness [mm]	Épaisseur [mm]
		Thread Size	Filetage
		Transmission Type	Type d'entraînement



Technical translations

Technische Übersetzungen - Traducciones técnicas - Traductions techniques - Traduzioni tecniche

FR		FR	
Trim Level	Variante d'équipement	without brake fluid reservoir	sans réservoir du liquide de frein
Turkey	Turquie	without cable	sans câble
Tyres	Pneus	without hollow screw	sans vis creuse
Unreached Quality Gates	Nicht erfüllte Qualitätsstufen	without lever	sans levier
usage number	Numéro d'utilisation	with seal	avec joint d'étanchéité
Vehicle Equipment	Équipement véhicule	Yes	Oui
Vehicle Identification Number from	N° de châssis à partir de	→ Construction year to	Année jusqu'à
→		→ for DAM number up to	pour numéro DAM jusqu'à
Vehicle Production Country	Pays constructeur du véhicule	→ for RPO number (vehicle manufacturing date) up to	pour numéro OPR (date de fabrication du véhicule) jusqu'à
Warning Contact Length [mm]	Longueur de contacts d'avertissement [mm]	→ Vehicle Identification Number to	N° de châssis jusqu'à
Wear Warning Contact	Indicateur d'usure		
Wheelbase [mm]	Empattement [mm]		
Width [mm]	Largeur [mm]		
Width 1 [mm]	Largeur 1 [mm]		
Width 2 [mm]	Largeur 2 [mm]		
with accessories	avec accessoires		
with acoustic wear warning	avec indicateur d'usure		
with anti-squeak plate	avec tôle anti-bruit		
with bolts/screws	avec vis/boulons		
with brake caliper screws	avec vis d'étrier de frein		
with brake pads	avec plaquettes de freins		
with holder	avec support		
with hollow screw	avec vis creuse		

Technical translations

Technische Übersetzungen - Traducciones tecnicas - Traductions techniques - Traduzioni tecniche

IT		IT	
	Cilindro maestro del freno	Article number of recommended accessories	N° articolo accessorio consigliato
	Flessibile del freno	ATE Ceramic	Denominazione aggiuntiva dell'articolo, ATE Ceramic
	Cavo comando, Freno stazionamento	Automatic Transmission	Trasmissione automatica
	Kit ganasce, Freno stazionamento	Axle	Assale
	Pinza freno	Bolt Hole Circle Ø [mm]	Cerchio foro-Ø [mm]
	Kit pastiglie freno, Freno a disco	Bore Ø [mm]	Alesaggio-Ø [mm]
	Discofreno	Brake Caliper Colour	Colore pinza freno
	Cilindretto freno	Brake Caliper Type	Tipo pinza freno
	Sensore velocità ruote	Brake caliper with adjusting element for electr. hand-brake	Pinza freno con regolatore per freno stazionamento elettrico
+ ABS	per veicoli con ABS	Brake diameter, inside [mm]	Diametro tamburo del freno interno[mm]
+ ESP	per veicoli con ESP	Brake Disc Thickness [mm]	Spessore disco freno [mm]
14"	14"	Brake Disc Type	Tipo disco freno
15"	15"	Brake Size	Misura freno
16"	16"	Brake System	Sistema frenante
17" plus	17" plus	Brake Type	Tipo freno
17"	17"	Braking System	Impianto frenante
18"	18"	Cast Aluminium	Alluminio pressofuso
6-Speed Automatic Transmission	Cambio automatico a 6 marce	Cast iron brake caliper	Pinza freno in ghisa
6-Speed Manual Transmission	Cambio manuale a 6 marce	CB compatible package	Imballaggio self-service
- ABS	per veicoli senza ABS	Centering Diameter [mm]	Diametro centraggio [mm]
Alloyed / High-carbon	legato /ad alto tenore di carbonio		
Aluminium	Alluminio		
Aluminium brake caliper	Pinza freno in alluminio		

Technical translations

Technische Übersetzungen - Traducciones tecnicas - Traductions techniques - Traduzioni tecniche

IT		IT	
Centre	centro	for brake disc diameter [mm]	per diametro disco freno [mm]
Coated	rivestito	for brake disc thickness [mm]	per spessore disco freno [mm]
Code	Modello	for cruise control system	per impianto regolazione velocità
Comfort Equipment Variant (trim package)	Equipaggiamento comfort	for dual tyres	per pneumatici gemellati
Construction year from →	Anno da	for government vehicles	per veicoli dell'amministrazione pubblica
Country-spec. model	Modello p. paesi	for increased payload	per elevata portata utile
Country specific article information	Informazioni sull'articolo specifiche per i diversi Paesi	for left-hand drive vehicles	per veicolo con guida a Sx
Country specific package and status data	Informazioni di imballaggio e di stato specifiche per i diversi Paesi	for police vehicles	per veicoli della polizia
Diameter [mm]	Diametro [mm]	for PR number	per N° PR
Disc Brake	Freno a disco	for right-hand drive vehicles	per veicolo con guida a Dx
Electric	elettrico	for RPO number (vehicle manufacturing date) from →	per numero organizzazione da
Engine Code	Codice motore	for SA code	per codice SA
Equipment Code	Codice dotazione	for single tyres	per pneumatici singoli
- ESP	per veicoli senza ESP	for taxis	per taxi
excl. wear warning contact	senza contatto segnalazione usura	for vehicles with air conditioning	per veicoli con aria condizionata
External Thread [mm]	Filetto esterno [mm]	for vehicles with AMG Sports Package	per veicoli con pacchetto sportivo AMG
Fist-type Caliper	Pinza a pugno	for vehicles with autom. distance control	per veicoli con regolatore automatico distanza
Fist-type Caliper (2 pistons)	Pinza a pugno (2 pistoni)		
Fitting Position	Lato montaggio		
Flange Hole Diameter [mm]	Diametro foro flangia [mm]		
for armoured vehicles	per veicoli corazzati		

Technical translations

Technische Übersetzungen - Traducciones técnicas - Traductions techniques - Traduzioni tecniche

IT	IT
for vehicles with disc brakes on the rear axle per veicoli con freni a disco ad assale posteriore	for vehicles with parking assistant system per veicoli con sistema assistenza parcheggio
for vehicles with drum brakes on the rear axle per veicoli con freni a tamburo ad assale posteriore	for vehicles with reinforced brakes per veicoli con freno rinforzato
for vehicles with electric parking brake per veicoli con freno stazionamento elettrico	for vehicles with sports brake system per veicoli con impianto frenante sportivo
for vehicles with increased ground clearance per veicoli con altezza da terra maggiorata	for vehicles with sports package per veicoli con pacchetto sportivo
for vehicles without 3rd seating row per veicoli senza 3ª fila sedili	for vehicles with sports suspension per veicoli con autotelaio sportivo
for vehicles without AMG sports package per veicoli senza pacchetto sportivo AMG	for vehicles with torsion bar suspension per veicoli con sospensione a barra di torsione
for vehicles without ceramic brakes per veicoli senza freni in ceramica	France Francia
for vehicles without electric parking brake per veicoli senza freno stazionamento elettrico	Front Axle Assale anteriore
for vehicles without M-sport brakes per veicoli senza freni sportivi M	Front Axle Left Assale anteriore Sx
for vehicles without Performance brakes per veicoli senza freno Performance	Front Axle Right Assale anteriore Dx
for vehicles without sports brake system per veicoli senza impianti frenante sportivo	Height [mm] Altezza [mm]
for vehicles without sports package per veicoli senza pacchetto sportivo	Height 1 [mm] Altezza 1 [mm]
for vehicles without sports suspension per veicoli senza autotelaio sportivo	Height 2 [mm] Altezza 2 [mm]
	High-carbon ad alto tenore di carbonio
	Hub Diameter [mm] Diametro mozzo [mm]
	incl. wear warning contact Con contatto segnalazione usura
	inner interno
	Inner diameter [mm] Diametro interno [mm]
	Internal Thread [mm] Filettatura interna [mm]
	Internal Thread 1 [mm] Filettatura interna 1 [mm]

Technical translations

Technische Übersetzungen - Traducciones tecnicas - Traductions techniques - Traduzioni tecniche

IT		IT	
Internal Thread 2 [mm]	Filettatura interna 2 [mm]	not for special-purpose vehicles	Non per veicoli speciali
Left-/right-hand drive vehicles	Veicolo con guida a Sx/Dx	not for taxis	Non per taxi
Length [mm]	Lunghezza [mm]	not for vehicles with reinforced brakes	Non per veicoli con freno rinforzato
Length 1 [mm]	Lunghezza 1 [mm]	not prepared for wear indicator	Non predisposto per contatto segnalazione usura
Length 2 [mm]	Lunghezza 2 [mm]	Number of bolts/screws	N° viti/bulloni
Machining	Lavorazione/Trattamento	Number of connectors	N° raccordi
Manual Transmission	Cambio manuale	Number of Doors	N° portiere
Manufacturer Restriction	Limitazione costruttore	Number of Holes	N° fori
MAPP code available	MAPP-Code disponibile	Number of wear indicators [per axle]	N° indicatori usura [per asse]
Material	Materiale	Observe dimensions	Osservare le misure
Minimum thickness [mm]	Spessore min. [mm]	Operating Mode	Tipo funzionamento
Multilink Axle	Assale multilink	Outer diameter [mm]	Diametro esterno [mm]
No. of holes 2	N° fori 2	paired article number	N° articolo appaiato
not for armoured vehicles	Non per veicoli corazzati	Payload	Portata utile
not for brake caliper colour	non per colore pinza freno	Piston Diameter [mm]	Diametro pistone [mm]
not for government vehicles	Non per veicoli dell'amministrazione pubbl.	PowerDisc	Denominazione aggiuntiva dell'articolo, PowerDisc
not for increased payload	Non per elevata portata utile	prepared for wear indicator	Predisposto per contatto segnalazione usura
not for police vehicles	Non per mezzi della polizia	Production date from →	Data di produzione da
not for rim size [in]	non per misura cerchione [pollici]	Produkttyp vorhanden	Produkttyp vorhanden
not for SA code	non per codice SA	Reached Quality Gates	Erfüllte Qualitätsstufen

Technical translations

Technische Übersetzungen - Traducciones tecnicas - Traductions techniques - Traduzioni tecniche

IT		IT	
Rear	posteriore	Trim Level	Variante di dotazione
Rear Axle	Assale posteriore	Turkey	Turchia
Rear Axle Left	Assale posteriore Sx	Tyres	Pneumatici
Rear Axle Right	Assale posteriore Dx	Unreached Quality Gates	Nicht erfüllte Qualitätsstufen
Red	rosso	usage number	Codice d'uso
Red/Silver	rosso/argento	Vehicle Equipment	Equipaggiamento veicolo
replacement part	Ricambio di rotazione	Vehicle Identification Number from →	N° telaio da
Required quantity	N° pezzi occorrenti	Vehicle Production Country	Paese produzione veicolo
Rigid Axle	Assale rigido	Warning Contact Length [mm]	Lunghezza contatti di segnalazione [mm]
Rim Hole Number	Cerchione, N° fori	Wear Warning Contact	Contatto avvisatore usura
Rim Size [in]	Misura cerchione [pollici]	Wheelbase [mm]	Passo ruote [mm]
Russia-made	Russia	Width [mm]	Larghezza [mm]
Service exchange part	Ricambio di rotazione	Width 1 [mm]	Larghezza 1 [mm]
Silver	argento	Width 2 [mm]	Larghezza 2 [mm]
Solid	Pieno	with accessories	con accessori
Spanner size 1 [mm]	Apertura chiave 1 [mm]	with acoustic wear warning	con segnalatore acustico usura
Special Purpose Vehicle	Autoveicolo usi speciali	with anti-squeak plate	con lamierino anticigolio
Spring Type	Tipo sospensione	with bolts/screws	con bulloni/viti
Supplementary Article/ Info 2	Articolo complementare/Info integrativa 2	with brake caliper screws	con bulloni pinza freno
Supplementary Article/ Supplementary Info	Articolo complementare/Info integrativa	with brake pads	con materiale d'attrito freno
Surface	Superficie	with holder	con supporto
Suspension	Autotelaio	with hollow screw	con vite cava
Test Mark	Marchio controllo		
Thickness [mm]	Spessore [mm]		
Thread Size	Dimensioni filettatura		
Transmission Type	Modalità di trasmissione		

Technical translations

Technische Übersetzungen - Traducciones tecnicas - Traductions techniques - Traduzioni tecniche

IT	
without brake fluid reservoir	senza serbatoio liquido freni
without cable	senza cavo
without hollow screw	senza vite cava
without lever	senza leva
with seal	con guarnizione
Yes	Sì
→ Construction year to	Anno fino a
→ for DAM number up to	per numero DAM fino a
→ for RPO number (vehicle manufacturing date) up to	per numero organizzazione fino a
→ Vehicle Identification Number to	N° telaio fino a

ATE – A Trademark of the
Continental Corporation

**Continental Aftermarket & Services
GmbH**

Sodener Straße 9
D-65824 Schwalbach
Tel. +49 (0) 6196 87 0
Fax +49 (0) 6196 865 71

www.ate.de

**Continental Automotive Trading
Italia S.r.l.**

Via Matteotti, 62
I-20092 Cinisello Balsamo (MI)
Tel. +39 02 35680 1
Fax +39 02 35680 325
E-Mail: supporto@continental-corporation.com

www.ate-freni.it

Continental Automotive France SAS

1 rue de Clairefontaine
F-78120 Rambouillet
Tél. +33 (0)1 34 57 40 19
Fax +33 (0)1 34 57 40 72

www.ate-freinage.fr

Continental Automotive Spain, S.A.

C/ Sepúlveda, 11
E-28108 Alcobendas (Madrid) Phone
+34 (0) 657 21 21
Fax +34 (0)91 657 21 49

www.frenos-ate.es