

ATE New Parts ATE Neuteile

07/2022



Brakethrough Technology



Erstklassig First-class

Besser ist besser

Wenn es um Qualität geht, genügt uns ein „sehr gut“ noch lange nicht. Wir erfüllen hohe Ansprüche an das Qualitätsmanagement und die europäische Sicherheitsnorm ECE-R90 wird von ATE sogar übertroffen. Zudem führen wir zahlreiche zusätzliche Tests durch, unter anderem zu Verschleiß und Wärmeleistung.

Auch Nachhaltigkeit ist uns wichtig: Wir stellen die Mischungen für ATE Bremsbeläge auf kupferfreie Materialien um und setzen bei ATE Ceramic auf geringen Abrieb. Nutzen ausschließlich umweltfreundliches Material für die Beschichtung von Bremscheiben. Und bereiten Produkte wie Bremsattel wieder auf.

Better is better

When it comes to quality, “very good” is simply not good enough for us. We meet high standards of quality management – and ATE even exceeds the European safety standard ECE-R90. We also perform many additional tests, including wear and thermal performance.

Sustainability is also important to us: we convert the compounds for ATE brake pads to copperfree materials and opt for low abrasion with ATE Ceramic. We only use environmentally friendly material for the coating of brake discs – and we remanufacture products like brake callipers.

Höchste Qualität für optimale Leistung.



NEU: SUPER DOT 5.1

Neue Premium-Flüssigkeit ATE SUPER DOT 5.1 mit bester Funktionalität bei heißen wie kalten Einsatzbedingungen: 5°C höherer Nassiedepunkt und höheres Wechselintervall als ATE SL.6 bei gleich guter Viskosität, ideal für Fahrzeuge mit modernen Fahrerassistenzsystemen wie ESP®, ABS und ASR.

Große Auswahl für alle Einsatzgebiete

- | ATE SL als bewährter DOT 4 Typ, ATE TYP 200 für Rennsportbegeisterte und ATE DOT 3 G für Oldtimer und Fahrzeuge, wo die Verwendung einer DOT 3-Flüssigkeit vom Fahrzeughersteller vorgeschrieben ist
- | ATE SL.6 ist optimal für ESP®, ABS und ASR: dünnflüssig auch bei niedrigen Temperaturen, schnelle Reaktionszeit
- | Siedepunkte und Viskosität übertreffen gesetzliche und technische Anforderungen
- | Schutz vor Korrosion durch hochwertige Additive

Die Eigenschaften von ATE Bremsflüssigkeiten

| | Siedepunkt | Nassiedepunkt | Viskosität bei -40°C | Wechselintervall |
|---|------------|---------------|-------------------------------|------------------|
| ATE SUPER DOT 5.1 | min. 265°C | min. 180°C | max. 750 mm ² /s | bis 3 Jahre |
| ATE TYP 200 DOT 4 Racing-Qualität | min. 280°C | min. 198°C | max. 1.400 mm ² /s | bis 3 Jahre |
| ATE SL.6 DOT 4 Ideal für ESP®, ABS, ASR | min. 265°C | min. 175°C | max. 700 mm ² /s | bis 2 Jahre |
| ATE SL DOT 4 | min. 260°C | min. 165°C | max. 1.400 mm ² /s | bis 1 Jahr |
| ATE G DOT 3 | min. 245°C | min. 150°C | max. 1.500 mm ² /s | bis 1 Jahr |

Zur Erhaltung der Funktionssicherheit der Bremsanlage muss Bremsflüssigkeit entsprechend der vom Fahrzeughersteller vorgegebenen Qualität und in den angegebenen Wechselintervallen ausgetauscht werden.

Servicegeräte

Natürlich bieten wir auch Geräte für Tests, Entlüftung und Entsorgung von Bremsflüssigkeiten an. Sie arbeiten exakt und zuverlässig, sind leicht zu bedienen und technologisch auf dem neuesten Stand.

Erfahren Sie mehr über ATE Bremsflüssigkeiten auf www.ate.de/bremsfluessigkeit sowie über unsere Servicegeräte auf www.ate-info.de



| Typ | ATE Sachnummer | EAN-Nr. 4006633 | Gebinde | Paletteneinheit |
|---|------------------------------|-----------------|---------|---------------------------|
| SUPER DOT 5.1 SAE-Spezifikation, J1704-FMVSS 116/DOT 5.1 ISO Klasse 5-1 – niedrigviskos | 706602 03.9901-6602.2 | 45757 6 | 1 l | 600 Kannen ² |
| | 706603 03.9901-6603.2 | 45759 0 | 5 l | 400 Kannen ³ |
| | 706611 03.9901-6611.2 | 45761 3 | 20 l | 36 Kannen |
| TYP 200 SAE-Spezifikation, J1704-FMVSS 116/DOT 4 | 706202 03.9901-6202.2 | 10825 6 | 1 l | 600 Kannen ² |
| | 706203 03.9901-6203.2 | 12166 8 | 5 l | 400 Kannen ³ |
| | 706220 03.9901-6220.2 | 12780 6 | 30 l | 22 Kannen |
| SL.6 SAE-Spezifikation, J1704-FMVSS 116/DOT 4 ISO-Klasse 6 – niedrigviskos | 706402 03.9901-6402.2 | 20746 1 | 1 l | 600 Kannen ² |
| | 706403 03.9901-6403.2 | 20748 5 | 5 l | 400 Kannen ³ |
| | 706411 03.9901-6411.2 | 20750 8 | 20 l | 36 Kannen |
| | 706420 03.9901-6420.2 | 23120 6 | 30 l | 22 Kannen |
| | 706414 03.9901-6414.2 | 23005 6 | 50 l | 12 Kannen |
| | 706405 03.9901-6405.2 | 23121 3 | 200 l | 1 Stück |
| SL SAE-Spezifikation, J1704-FMVSS 116/DOT 4 | 705801 03.9901-5801.2 | 49001 6 | 1/2 l | 1.200 Kannen ¹ |
| | 705802 03.9901-5802.2 | 49002 3 | 1 l | 600 Kannen ² |
| | 705803 03.9901-5803.2 | 49003 0 | 5 l | 400 Kannen ³ |
| | 705811 03.9901-5811.2 | 29907 7 | 20 l | 12 Kannen |
| | 705820 03.9901-5820.2 | 10824 9 | 30 l | 22 Kannen |
| | 705814 03.9901-5814.2 | 10366 4 | 50 l | 12 Kannen |
| | 705805 03.9901-5805.2 | 49005 4 | 200 l | 1 Stück |
| G SAE-Spezifikation, J1703-FMVSS 116/DOT 3 | 705302 03.9901-5302.2 | 10199 8 | 1 l | 600 Kannen ² |
| | 705303 03.9901-5303.2 | 10201 8 | 5 l | 400 Kannen ³ |

Abweichende Artikelnummern für Lieferländer außerhalb Deutschlands möglich.

Paletteneinheit:

¹ 20 Kannen je Karton

² 10 Kannen je Karton

³ 4 Kannen je Karton

Top quality for optimum performance.



NEW: SUPER DOT 5.1

The new premium ATE SUPER DOT 5.1 brake fluid with optimum performance in both hot and cold conditions: 5°C higher wet boiling point than ATE SL.6, same excellent viscosity, longer change interval, ideal for vehicles with advanced driver assistance systems like ESP®, ABS and ASR.

Wide selection for all applications

- | ATE SL as a proven DOT 4 grade, ATE TYPE 200 for racing enthusiasts and ATE DOT 3 G for classic cars and vehicles for which the manufacturer specifies a DOT 3 brake fluid
- | ATE SL.6 is optimal for ESP®, ABS and ASR: low viscosity even at low temperatures, with a fast reaction time
- | Boiling points and viscosities are better than in statutory and technical regulations
- | Protection from corrosion by high-grade additives

Properties of ATE brake fluids

| | Boiling point | Wet boiling point | Viscosity at -40°C | Change interval |
|---|----------------------|----------------------|-------------------------------|-----------------|
| ATE SUPER DOT 5.1 | min. 265 °C / 509 °F | min. 180 °C / 356 °F | max. 750 mm ² /s | up to 3 years |
| ATE TYPE 200 DOT 4 Racing quality | min. 280 °C / 536 °F | min. 198 °C / 388 °F | max. 1,400 mm ² /s | up to 3 years |
| ATE SL.6 DOT 4 Ideal for ESP®, ABS, ASR | min. 265 °C / 509 °F | min. 175 °C / 347 °F | max. 700 mm ² /s | up to 2 years |
| ATE SL DOT 4 | min. 260 °C / 500 °F | min. 165 °C / 329 °F | max. 1,400 mm ² /s | up to 1 year |
| ATE G/ATE Blue DOT 3 | min. 245 °C / 473 °F | min. 150 °C / 302 °F | max. 1,500 mm ² /s | up to 1 year |

To maintain the operational reliability and safety of the brake system, you must change the brake fluid in accordance with the vehicle manufacturer's recommendations on quality and at the specified change intervals.

Service units

Of course we also offer devices for testing, bleeding and disposing of brake fluids. The devices work accurately and reliably, are easy to use and their technology is state-of-the-art.



To learn more about ATE brake fluids go to www.ate.de/bremsfluessigkeit. Information on our service units is available at www.ate-info.de

| Type | ATE item code | Language variations | Container | Pallet unit |
|---|-----------------------|---|-----------|-------------------------|
| SUPER DOT 5.1 SAE specification, J1704-FMVSS 116/DOT 5.1 ISO Class 5-1 – low viscosity | 706602 03.9901-6602.2 | DE, EN, ES, PT, CN, FR, IT, AR, SE, NL, JP, TH, GR | 1 L | 600 cans ² |
| | 706612 03.9901-6612.2 | PL, RU, CZ, SK, SLO, HU, BG, KA, HR, SR, RO | 1 L | 600 cans ² |
| | 706603 03.9901-6603.2 | DE, EN, ES, PT, CN, FR, IT, AR, SE, NL, JP, TH, GR, PL, RU, CZ, SK, SLO, HU, BG, KA, HR, SR, RO | 5 L | 400 cans ³ |
| | 706611 03.9901-6611.2 | DE, EN, ES, PT, CN, FR, IT, AR, SE, NL, JP, TH, GR, PL, RU, CZ, SK, SLO, HU, BG, KA, HR, SR, RO | 20 L | 36 cans |
| TYP 200 SAE specification, J1704-FMVSS 116/DOT 4 | 706202 03.9901-6202.2 | DE, EN, ES, PT, CN, FR, IT, AR, SE, NL, JP, TH, GR | 1 L | 600 cans ² |
| | 706212 03.9901-6212.2 | PL, RU, CZ, SK, SLO, HU, BG, KA, HR, SR, RO | 1 L | 600 cans ² |
| | 706203 03.9901-6203.2 | DE, EN, PL, ES, CN, FR, IT, RO, AR, SE, RU, HR, SR, CZ, SK, SLO, GR, HU, JP, TH, BG, NL, PT, KA, DK, FI, SQ, TR, LV, NO, LT, MS, HY | 5 L | 400 cans ³ |
| | 706220 03.9901-6220.2 | DE, EN, PL, ES, CN, FR, IT, RO, AR, SE, RU, HR, SR, CZ, SK, SLO, GR, HU, JP, TH, BG, NL, PT, KA, DK, FI, SQ, TR | 30 L | 22 cans |
| SL.6 SAE specification, J1704-FMVSS 116/DOT 4 ISO Class 6 – low viscosity | 706402 03.9901-6402.2 | DE, EN, ES, PT, CN, FR, IT, AR, SE, NL, JP, TH, GR | 1 L | 600 cans ² |
| | 706432 03.9901-6432.2 | PL, RU, CZ, SK, SLO, HU, BG, KA, HR, SR, RO | 1 L | 600 cans ² |
| | 706403 03.9901-6403.2 | DE, EN, PL, ES, CN, FR, IT, RO, AR, SE, RU, HR, SR, CZ, SK, SLO, GR, HU, JP, TH, BG, NL, PT, KA, DK, FI, SQ, TR, LV, NO, LT, MS, HY | 5 L | 400 cans ³ |
| | 706411 03.9901-6411.2 | DE, EN, PL, ES, CN, FR, IT, RO, AR, SE, RU, HR, SR, CZ, SK, SLO, GR, HU, JP, TH, BG, NL, PT, KA, DK, FI, SQ, TR, LV | 20 L | 36 cans |
| | 706420 03.9901-6420.2 | DE, EN, PL, ES, CN, FR, IT, RO, AR, SE, RU, HR, SR, CZ, SK, SLO, GR, HU, JP, TH, BG, NL, PT, KA, DK, FI, SQ, TR | 30 L | 22 cans |
| | 706414 03.9901-6414.2 | DE, EN, PL, ES, CN, FR, IT, RO, AR, SE, RU, HR, SR, CZ, SK, SLO, GR, HU, JP, TH, BG, NL, PT, KA, DK, FI, SQ, TR | 50 L | 12 cans |
| | 706405 03.9901-6405.2 | DE, EN, PL, ES, CN, FR, IT, RO, AR, SE, RU, HR, SR, CZ, SK, SLO, GR, HU, JP, TH, BG, NL, PT, KA, DK, FI, SQ, TR | 200 L | 1 item |
| SL SAE specification, J1704-FMVSS 116/DOT 4 | 705801 03.9901-5801.2 | DE, EN, ES, AR, TH, CN | 1/2 L | 1,200 cans ¹ |
| | 705831 03.9901-5831.2 | PL, RO, RU, HR, SLO, KA | 1/2 L | 1,200 cans ² |
| | 705802 03.9901-5802.2 | DE, EN, ES, PT, CN, FR, IT, AR, SE, NL, JP, TH, GR | 1 L | 600 cans ² |
| | 705832 03.9901-5832.2 | PL, RU, CZ, SK, SLO, HU, BG, KA, HR, SR, RO | 1 L | 600 cans ² |
| | 705803 03.9901-5803.2 | DE, EN, PL, ES, CN, FR, IT, RO, AR, SE, RU, HR, SR, CZ, SK, SLO, GR, HU, JP, TH, BG, NL, PT, KA, DK, FI, SQ, TR, LV, NO, LT, MS, HY | 5 L | 400 cans ³ |
| | 705811 03.9901-5811.2 | DE, EN, PL, ES, CN, FR, IT, RO, AR, SE, RU, HR, SR, CZ, SK, SLO, GR, HU, JP, TH, BG, NL, PT, KA, DK, FI, SQ, TR, LV | 20 L | 12 cans |
| | 705820 03.9901-5820.2 | DE, EN, PL, ES, CN, FR, IT, RO, AR, SE, RU, HR, SR, CZ, SK, SLO, GR, HU, JP, TH, BG, NL, PT, KA, DK, FI, SQ, TR | 30 L | 22 cans |
| | 705814 03.9901-5814.2 | DE, EN, PL, ES, CN, FR, IT, RO, AR, SE, RU, HR, SR, CZ, SK, SLO, GR, HU, JP, TH, BG, NL, PT, KA, DK, FI, SQ, TR | 50 L | 12 cans |
| | 705805 03.9901-5805.2 | DE, EN, PL, ES, CN, FR, IT, RO, AR, SE, RU, HR, SR, CZ, SK, SLO, GR, HU, JP, TH, BG, NL, PT, KA, DK, FI, SQ, TR | 200 L | 1 item |
| G SAE specification, J1703-FMVSS 116/DOT 3 | 705302 03.9901-5302.2 | - | 1 L | 600 cans ² |
| | 705303 03.9901-5303.2 | - | 5 L | 400 cans ³ |
| BLUE SAE specification, J1703-FMVSS 116/DOT 3 | 700301 03.9901-0301.2 | - | 1/2 L | 1,200 cans ² |
| | 700302 03.9901-0302.2 | - | 1 L | 600 cans ² |

Item codes may be different for countries of delivery other than Germany.

Pallet unit: ¹20 cans per box, ²10 cans per box, ³4 cans per box

EN Table of contents

| |
|--------------------------|
| Index of vehicles |
| Product details |
| Applications of vehicles |
| Technical translations |

| | |
|-----|--------------------------|
| 8 | Herstellerverzeichnis |
| 12 | Produktdetails |
| 35 | Fahrzeugverwendungen |
| 219 | Technische Übersetzungen |

DE Inhaltsverzeichnis

ES Índice

| | | |
|-----|--------------------------|-----|
| 8 | Índice de vehículos | 8 |
| 12 | Descripción del producto | 12 |
| 35 | Aplicaciones | 35 |
| 219 | Traducciones técnicas | 219 |

FR Table des matières

| |
|-------------------------|
| Liste des véhicules |
| Présentation du produit |
| Applications |
| Traductions techniques |

| | |
|-----|--------------------------|
| 8 | Indice autovetture |
| 12 | Panoramica prodotti |
| 35 | Applicazioni autoveicoli |
| 219 | Traduzioni tecniche |

IT Sommario

| |
|-----|
| 8 |
| 12 |
| 35 |
| 219 |



- EN** Index of vehicles
- DE** Herstellerverzeichnis
- ES** Índice de vehículos
- FR** Liste des véhicules
- IT** Indice autovettura

07/2022

| | | | | | |
|---|-----------|-------------------------------------|-----------|--|-----------|
| ALFA ROMEO | 36 | CITROËN | 46 | MAZDA | 75 |
| 159 (939_) | 36 | C5 AIRCROSS (A_) | 59 | 3 (BM, BN) | 75 |
| 159 Sportwagon (939_) | 36 | C5 I (DC_) | 58 | 3 Hatchback Van (BM) | 75 |
| BRERA (939_) | 36 | C5 II (RC_) | 58 | 3 Saloon (BM_, BN_) | 76 |
| GIULIETTA (940_) | 36 | C5 III Break (RW_) | 58 | CX-3 (DK) | 76 |
| GIULIETTA Hatchback Van (940_) | 36 | C5 X (ND_, NC_) | 58 | | |
| SPIDER (939_) | 36 | C-ELYSEE (DD_) | 60 | | |
| | | DS3 (SA_) | 60 | | |
| | | DS3 Convertible | 60 | | |
| AUDI | 36 | GRAND C4 SPACETOURER (3A_, 3E_) | 60 | MERCEDES-BENZ | 76 |
| A1 (8X1, 8XK) | 36 | GRAND C4 SPACETOURER Van (3A_, 3E_) | 61 | A-CLASS (W177) | 76 |
| A1 Sportback (8XA, 8XF) | 36 | JUMPY Bus (V_) | 62 | A-CLASS Saloon (V177) | 76 |
| A3 (8P1) | 36 | JUMPY Platform/Chassis (V_) | 62 | B-CLASS Sports Tourer (W247) | 77 |
| A3 (8V1, 8VK) | 37 | JUMPY Van (V_) | 62 | C-CLASS (W205) | 77 |
| A3 Convertible (8P7) | 37 | SPACETOURER Bus (V_) | 62 | C-CLASS Convertible (A205) | 77 |
| A3 Convertible (8V7, 8VE) | 38 | XSARA (N1) | 63 | C-CLASS Coupe (C205) | 78 |
| A3 Limousine (8VS, 8VM) | 38 | XSARA Break (N2) | 63 | C-CLASS T-Model (S205) | 78 |
| A3 Limousine (8YS) | 39 | XSARA Coupe (N0) | 63 | CLA (C118) | 79 |
| A3 Sportback (8PA) | 39 | XSARA Estate Van | 63 | CLA Coupe (C117) | 79 |
| A3 Sportback (8VA, 8VF) | 39 | XSARA Hatchback Van (N3_) | 63 | CLA Shooting Brake (X117) | 79 |
| A3 Sportback (8YA) | 40 | XSARA PICASSO (N68) | 64 | CLA Shooting Brake (X118) | 79 |
| A4 Allroad B9 (8WH, 8WJ) | 40 | | | CLS (C218) | 79 |
| A4 B9 (8W2, 8WC) | 40 | | | CLS (C257) | 80 |
| A4 B9 Avant (8W5, 8WD) | 41 | CUPRA | 64 | CLS Shooting Brake (X218) | 80 |
| A5 (F53, F5P) | 41 | FORMENTOR (KM7) | 64 | E-CLASS (W212) | 80 |
| A5 Convertible (F57, F5E) | 42 | LEON (KL1) | 65 | E-CLASS (W213) | 80 |
| A5 Sportback (F5A, F5F) | 42 | LEON Sportstourer (KL8) | 65 | E-CLASS All-Terrain (S213) | 81 |
| Q2 (GAB, GAG) | 43 | | | E-CLASS Convertible (A238) | 81 |
| Q3 (8UB, 8UG) | 43 | | | E-CLASS Coupe (C238) | 81 |
| Q3 (F3B) | 44 | DS | 65 | E-CLASS T-Model (S212) | 82 |
| Q3 Sportback (F3N) | 44 | DS 3 (SA_) | 65 | E-CLASS T-Model (S213) | 82 |
| TT (8J3) | 44 | DS 3 Convertible (SB_) | 65 | EQV (W447) | 82 |
| TT (FV3, FVP) | 44 | DS 3 CROSSBACK (UR_, UC_, UJ_) | 65 | eVITO Tourer (W447) | 82 |
| TT Roadster (8J9) | 44 | DS 4 II (F_, FB_, F3_) | 65 | eVITO Van (W447) | 82 |
| TT Roadster (FV9, FVR) | 44 | DS 7 Crossback (J_) | 66 | GLA (H247) | 83 |
| | | DS 9 (X2_) | 67 | GLA-CLASS (X156) | 83 |
| | | | | GLB (X247) | 83 |
| BMW | 45 | | | MARCO POLO Camper (W447) | 83 |
| X5 (E70) | 45 | | | SPRINTER 3,5-t Bus (B906) | 83 |
| X5 (F15, F85) | 45 | FIAT | 67 | SPRINTER 3,5-t Platform/Chassis (B906) | 83 |
| X6 (E71, E72) | 45 | 500 (312_) | 67 | SPRINTER 3,5-t Van (B906) | 84 |
| | | 500 C (312_) | 68 | SPRINTER 3-t Bus (B906) | 84 |
| | | DOBLO Bus (263_) | 68 | SPRINTER 3-t Platform/Chassis (B906) | 84 |
| CHEVROLET | 45 | DOBLO Cargo (263_) | 68 | SPRINTER 3-t Van (B906) | 84 |
| CRUZE (J300) | 45 | DOBLO Platform/Chassis (263_) | 68 | SPRINTER 4,6-t Platform/Chassis (B906) | 85 |
| CRUZE Hatchback (J305) | 46 | | | SPRINTER 4,6-t Van (B906) | 85 |
| CRUZE Station Wagon (J308) | 46 | FORD | 68 | SPRINTER 5-t Bus (B906) | 85 |
| ORLANDO (J309) | 46 | KA | 68 | SPRINTER 5-t Platform/Chassis (B906) | 85 |
| | | KA (RU8) | 68 | SPRINTER 5-t Van (B906) | 85 |
| | | | | V-CLASS (W447) | 86 |
| CITROËN | 46 | | | VIANO (W639) | 86 |
| AMI (9A_) | 46 | HYUNDAI | 68 | VITO / MIXTO Van (W639) | 86 |
| BERLINGO / BERLINGO FIRST Box Body/MPV (M_) | 46 | GRAND SANTA FÉ | 68 | VITO Bus (W639) | 87 |
| BERLINGO / BERLINGO FIRST MPV (MF_, GJK_, GFK_) | 47 | KONA (OS, OSE, OSI) | 69 | VITO Mixto (Double Cabin) (W447) | 87 |
| BERLINGO (ER_, EC_) | 47 | KONA SUV Van (OS, OSE, OSI) | 69 | VITO Tourer (W447) | 87 |
| BERLINGO Box Body/MPV (K9) | 48 | SANTA FÉ II (CM) | 69 | VITO Van (W447) | 88 |
| C2 (JM_) | 49 | SANTA FÉ III (DM, DMA) | 69 | | |
| C2 ENTERPRISE (JG_) | 49 | SANTA FÉ III SUV Van (DM) | 70 | NISSAN | 88 |
| C3 AIRCROSS II (2R_, 2C_) | 50 | SANTA FÉ II SUV Van (CM) | 69 | CABSTAR (F24M, F24W) | 88 |
| C3 AIRCROSS II Van (2C_, 2R_) | 51 | TUCSON (TL, TLE) | 70 | NT400 CABSTAR (F24M) | 88 |
| C3 I (FC_, FN_) | 49 | TUCSON SUV Van (TLE) | 70 | X-TRAIL II (T31) | 88 |
| C3 II (SC_) | 50 | | | X-TRAIL VAN (T31) | 88 |
| C3 II Hatchback Van (SC_) | 50 | JAGUAR | 70 | | |
| C3 III (SX) | 50 | F-PACE (X761) | 70 | OPEL | 88 |
| C3 III Van (SX_, SY_) | 50 | XE (X760) | 71 | ADAM (M13) | 88 |
| C3 PICASSO (SH_) | 51 | XF II (X260) | 71 | ASTRA J (P10) | 89 |
| C3 Pluriel (HB_) | 51 | XF SPORTBRAKE (X260) | 72 | ASTRA J Estate Van (P10) | 89 |
| C4 CACTUS | 52 | | | ASTRA J GTC | 89 |
| C4 CACTUS Van (0B_, 0P_) | 52 | | | ASTRA J Hatchback Van (P10) | 89 |
| C4 Coupe (LA_) | 52 | KIA | 73 | ASTRA J Saloon | 89 |
| C4 GRAND PICASSO II (DA_, DE_) | 53 | SORENTO II (XM) | 73 | ASTRA J Sports Tourer (P10) | 90 |
| C4 I (LC_) | 51 | SORENTO II SUV Van (XM) | 74 | ASTRA L | 90 |
| C4 II (NC_) | 51 | SPORTAGE II (JE_, KM) | 74 | ASTRA L Sports Tourer | 91 |
| C4 II Hatchback Van (NC_) | 52 | SPORTAGE III (SL) | 74 | COMBO Box Body/MPV (K9) | 92 |
| C4 III (BA_, BB_, BC_) | 52 | SPORTAGE II Van (KM_) | 74 | COMBO E Tour / Life (K9) | 93 |
| C4 PICASSO II | 54 | SPORTAGE IV (QL, QLE) | 74 | CORSA D (S07) | 93 |
| C4 PICASSO II Van (DD_) | 55 | SPORTAGE IV VAN (QL, QLE) | 75 | CORSA D Hatchback Van (S07) | 94 |
| C4 SPACETOURER (3D_) | 56 | | | CORSA E (X15) | 94 |
| C4 SPACETOURER Van (3D_) | 57 | | | CORSA E Hatchback Van (X15) | 94 |

VW 146

| | |
|---|-----|
| PASSAT B8 Variant (3G5, CB5) | 179 |
| PASSAT CC B6 (357) | 179 |
| POLO VI (AW1, BZ1, AE1) | 179 |
| SCIROCCO III (137, 138) | 179 |
| SCIROCCO Van (137) | 180 |
| SHARAN (7N1, 7N2) | 180 |
| SHARAN VAN (7N1, 7N2) | 180 |
| TAOS (CL1, CQ1) | 180 |
| TIGUAN (5N_) | 180 |
| TIGUAN (AD1, AX1) | 181 |
| TIGUAN ALLSPACE (BW2, BJ2) | 181 |
| TIGUAN SUV Van (AD1) | 181 |
| TIGUAN VAN (5N_) | 181 |
| TOUAREG (7LA, 7L6, 7L7) | 182 |
| TOURAN (1T1, 1T2) | 184 |
| TOURAN (1T3) | 184 |
| TOURAN (5T1) | 184 |
| TOURAN VAN (1T1, 1T2) | 184 |
| TOURAN VAN (1T3) | 185 |
| TOURAN VAN (5T1) | 185 |
| TRANSPORTER IV Bus (70B, 70C, 7DB, 7DK, 70J, 70K, 7DC, 7DJ) | 185 |
| TRANSPORTER IV Platform/Chassis (70E, 70L, 70M, 7DE, 7DL, 7D) | 185 |
| TRANSPORTER IV Van (70A, 70H, 7DA, 7DH) | 185 |
| TRANSPORTER V Bus (7HB, 7HJ, 7EB, 7EJ) | 186 |
| TRANSPORTER VI / CARAVELLE VI Bus (SGB, SGJ, SHB, SHJ) | 213 |
| TRANSPORTER VI Platform/Chassis (SFD, SFE, SFL, SFZ, SJD, SJ) | 214 |
| TRANSPORTER VI Van (SGA, SGH, SHA, SHH) | 216 |
| TRANSPORTER V Platform/Chassis (7JD, 7JE, 7JL, 7JY, 7JZ, 7FD) | 195 |
| TRANSPORTER V Van (7HA, 7HH, 7EA, 7EH) | 204 |
| T-ROC (A11, D11) | 217 |
| T-ROC Convertible (AC7, AC8) | 218 |
| UP! (121, 122, BL1, BL2, BL3, 123) | 218 |



- EN** Product details
- DE** Produktdetails
- ES** Descripción del producto
- FR** Présentation du produit
- IT** Panoramica prodotti

07/2022

11.8116-0126.2 390608

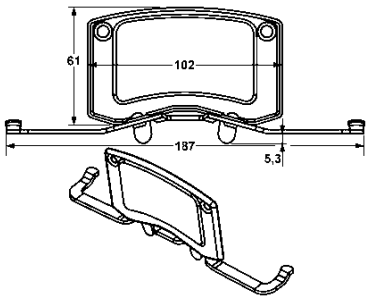

Spring, brake caliper

Brake System: ATE

VW

11.8116-0237.1 390509

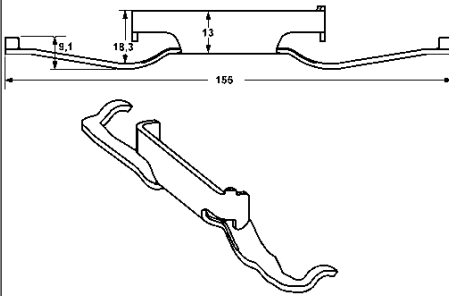

Spring, brake caliper

Brake System: ATE

ALFA ROMEO, CITROËN, FIAT, OPEL, PEUGEOT, VAUXHALL, VW

13.0460-0527.2 610527

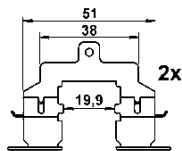
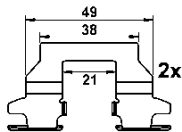

Accessory Kit, disc brake pad

NISSAN, RENAULT

13.0460-0529.2

610529

Accessory Kit, disc brake pad

TESLA

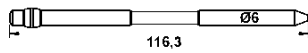
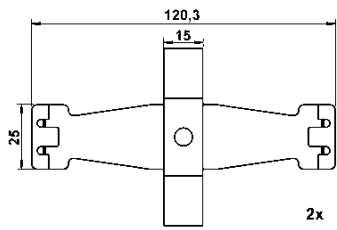

13.0460-0530.2

610530

Accessory Kit, disc brake pad

HYUNDAI, KIA

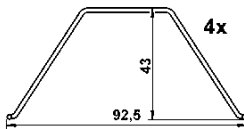
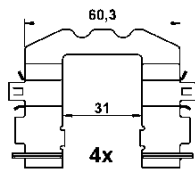

13.0460-0531.2

610531

Accessory Kit, disc brake pad

MAZDA

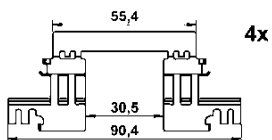

13.0460-2882.2

602882



Brake Pad Set, disc brake

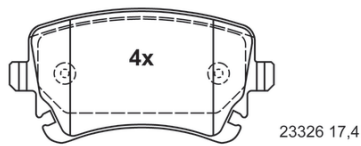

116,1 x 59,0 x 17,4

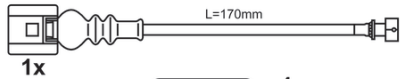

1x

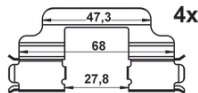

4x



4x

M8x1

Thickness [mm] 17.4

Supplementary Article/Info 2: with brake caliper screws

Warning Contact Length [mm]: 170

Brake System: Lucas / TRW

Test Mark: E1 90R-02A0498/0489 / E9 90R-02A1163/0715

Supplementary Article/Supplementary Info: with accessories

Observe dimensions

Wear Warning Contact: incl. wear warning contact

Height [mm] 59

Part number of recommended accessories: 13.0460-0023.2

Width [mm] 116.1

Number of bolts/screws: 4

MAPP code available

VW

13.0460-3870.2

603870



Brake Pad Set, disc brake

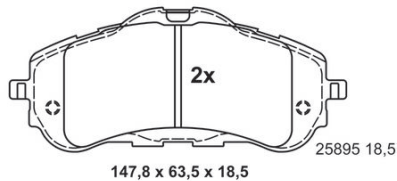

147,8 x 63,5 x 18,5

25895 18,5

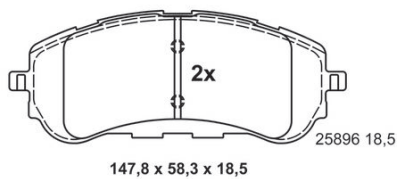

147,8 x 58,3 x 18,5

25896 18,5

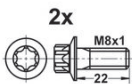

2x



M8x1



8x



8x

Thickness [mm] 18.5

Supplementary Article/Info 2: with brake caliper screws

Height 1 [mm]: 58.3

Brake System: Bosch

Test Mark: E1 90R-02A0213/0097

Supplementary Article/Supplementary Info: with accessories

Wear Warning Contact: not prepared for wear indicator / excl. wear warning contact

Width [mm] 147.8

Number of bolts/screws: 2

Height 2 [mm]: 63.5

MAPP code available

CITROËN, OPEL, PEUGEOT, VAUXHALL

13.0460-3871.2

603871



Brake Pad Set, disc brake

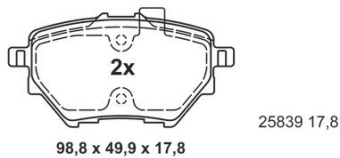

98,8 x 49,9 x 17,8

25839 17,8

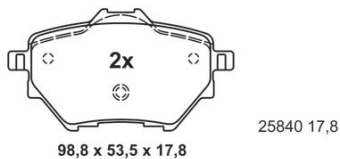

98,8 x 53,5 x 17,8

25840 17,8

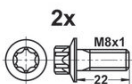

2x



M8x1



8x



8x

Thickness [mm] 17.8

Supplementary Article/Info 2: with brake caliper screws

Height 1 [mm]: 49.9

Brake System: Bosch

Test Mark: E1 90R-02A0215/0150

Supplementary Article/Supplementary Info: with accessories

Wear Warning Contact: not prepared for wear indicator / excl. wear warning contact

Width [mm] 98.8

Number of bolts/screws: 2

Height 2 [mm]: 53.5

MAPP code available

CITROËN, DS, OPEL, PEUGEOT, TOYOTA, VAUXHALL

13.0460-3872.2

603872

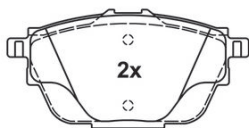

25827 17,7

105,8 x 51,9 x 17,7



25828 17,7

105,8 x 55,4 x 17,7

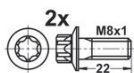

Brake Pad Set, disc brake

Thickness [mm] 17.7

Supplementary Article/Info 2: with brake caliper screws

Height 1 [mm]: 51.9

Brake System: Bosch

Test Mark: E1 90R-02A0215/0135

Supplementary Article/Supplementary Info: with accessories

Wear Warning Contact: not prepared for wear indicator / excl. wear warning contact

Width [mm] 105.8

Number of bolts/screws: 2

Height 2 [mm]: 55.4

MAPP code available

CITROËN, DS, OPEL, PEUGEOT, VAUXHALL

13.0460-3876.2

603876

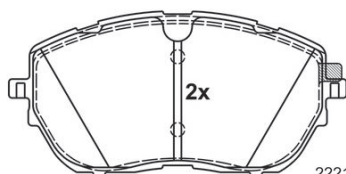

22218 18,3

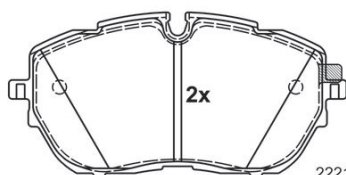

22219 18,3

148,3 x 72,6 x 18,3

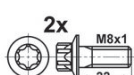

Brake Pad Set, disc brake

Thickness [mm] 18.3

Supplementary Article/Info 2: with brake caliper screws

Brake System: Bosch

Test Mark: E9 90R-02A1162/4418

Supplementary Article/Supplementary Info: with accessories

Wear Warning Contact: prepared for wear indicator / excl. wear warning contact

Height [mm] 72.6

Width [mm] 148.3

Number of bolts/screws: 2

MAPP code available

CITROËN, DS, OPEL, PEUGEOT, VAUXHALL

13.0460-4705.2

604705

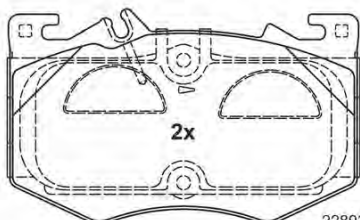

22893 17,0

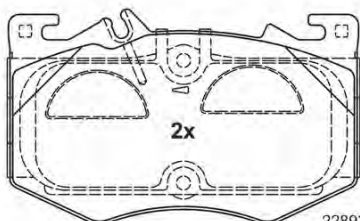

22893 17,0

154,6 x 94,7 x 17,0



Brake Pad Set, disc brake

Thickness [mm] 17

Brake System: Brembo

Test Mark: E1 90R-02A0334/0717

Wear Warning Contact: prepared for wear indicator / excl. wear warning contact

Height [mm] 92.4

Width [mm] 154.6

MAPP code available

MERCEDES-BENZ

13.0460-4863.2

604863

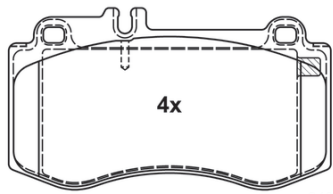

24976 17,5

141,5 x 79,8 x 17,5



Brake Pad Set, disc brake

Thickness [mm] 17.5

Brake System: Brembo

Test Mark: E1 90R-011134/1518

Wear Warning Contact: prepared for wear indicator / excl. wear warning contact

Height [mm] 79.8

Width [mm] 141.5

MAPP code available

MERCEDES-BENZ

13.0460-7236.2

607236

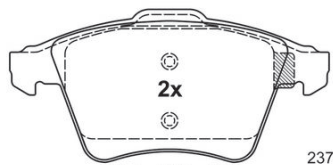

23749 18,7

156,2 x 74,8 x 18,7

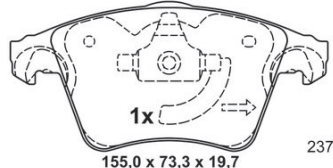

23747 19,7

155,0 x 73,3 x 19,7

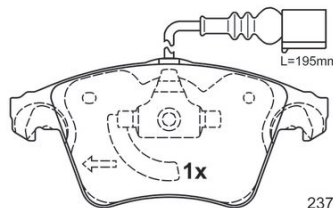

23746 19,7

155,0 x 73,3 x 19,7



Brake Pad Set, disc brake

Warning Contact Length [mm]: 195

Height 1 [mm]: 73.3

Brake System: ATE

Width 2 [mm]: 156.2

Width 1 [mm]: 155

Test Mark: E1 90R-01770/688

Thickness 2 [mm] 18.7

Thickness 1 [mm] 19.7

Wear Warning Contact: incl. wear warning contact

Height 2 [mm]: 74.8

MAPP code available

Number of wear indicators [per axle]: 1

VW

13.0460-7286.2

607286

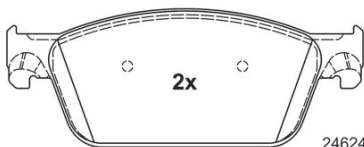

24624 18,2

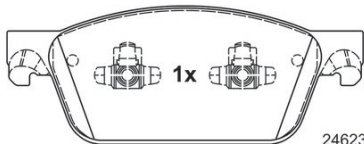

24623 18,2

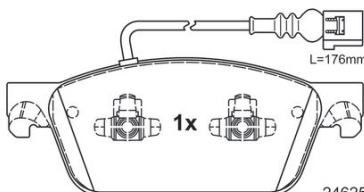

24625 18,2

193,1 x 75,0 x 18,2



Brake Pad Set, disc brake

Thickness [mm] 18.2

Warning Contact Length [mm]: 176

Brake System: ATE

Test Mark: E1 90R-02A0037/0058

Wear Warning Contact: incl. wear warning contact

Height [mm] 75

Width [mm] 193.1

MAPP code available

Number of wear indicators [per axle]: 1

VW

13.0470-2634.2

LD2634

ATE Ceramic

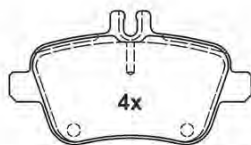

24848 18,2

106,1 x 59,1 x 18,2

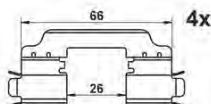

Brake Pad Set, disc brake

Thickness [mm] 18.2

Supplementary Article/Info 2: with brake caliper screws

Brake System: Lucas / TRW

Test Mark: E1 90R-02A0258/0034

Supplementary Article/Supplementary Info: with accessories

Wear Warning Contact: prepared for wear indicator / excl. wear warning contact

Height [mm] 59.1

Width [mm] 106.1

Number of bolts/screws: 4

MERCEDES-BENZ

13.0470-2785.2

LD2785

ATE Ceramic

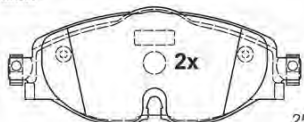

25683 20,4

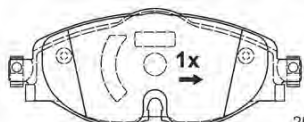

25684 20,4

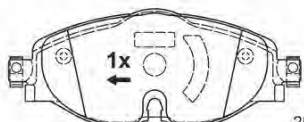

25684 20,4

160,0 x 64,5 x 20,4

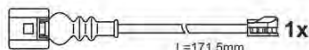

Brake Pad Set, disc brake

Thickness [mm] 20.4

Supplementary Article/Info 2: with brake caliper screws

Warning Contact Length [mm]: 171.5

Brake System: Lucas / TRW

Test Mark: E1 90R-02A0258/0139

Wear Warning Contact: prepared for wear indicator / incl. wear warning contact

Height [mm] 64.5

Width [mm] 160

Number of bolts/screws: 4

MAPP code available

Number of wear indicators [per axle]: 1

AUDI, CUPRA, SEAT, SKODA, VW

13.0470-3870.2

LD3870

ATE Ceramic

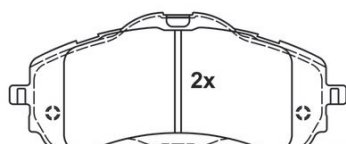

25895 18,5

147,8 x 63,5 x 18,5

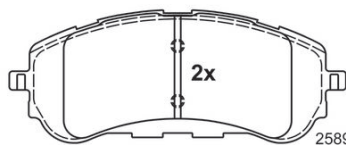

25896 18,5

147,8 x 58,3 x 18,5

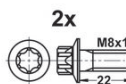

Brake Pad Set, disc brake

Thickness [mm] 18.5

Supplementary Article/Info 2: with brake caliper screws

Height 1 [mm]: 58.3

Brake System: Bosch

Test Mark: E9 90R-02A1242/4536

Supplementary Article/Supplementary Info: with accessories

Wear Warning Contact: not prepared for wear indicator / excl. wear warning contact

Width [mm] 147.8

Number of bolts/screws: 2

Height 2 [mm]: 63.5

MAPP code available

CITROËN, OPEL, PEUGEOT, VAUXHALL

13.0470-3871.2

LD3871

ATE Ceramic

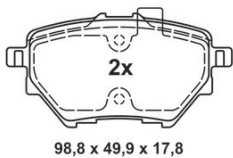

25839 17,8



25840 17,8

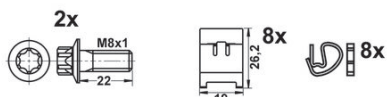

Brake Pad Set, disc brake

Thickness [mm] 17.8

Supplementary Article/Info 2: with brake caliper screws

Height 1 [mm]: 49.9

Brake System: Bosch

Test Mark: E1 90R-02A0153/0108

Supplementary Article/Supplementary Info: with accessories

Wear Warning Contact: not prepared for wear indicator / excl. wear warning contact

Width [mm] 98.8

Number of bolts/screws: 2

Height 2 [mm]: 53.5

MAPP code available

CITROËN, DS, OPEL, PEUGEOT, TOYOTA, VAUXHALL

13.0470-3872.2

LD3872

ATE Ceramic

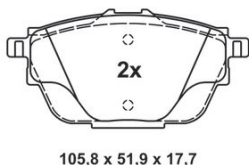

25827 17,7



25828 17,7



Brake Pad Set, disc brake

Thickness [mm] 17.7

Supplementary Article/Info 2: with brake caliper screws

Height 1 [mm]: 51.9

Brake System: Bosch

Test Mark: E1 90R-02A0153/0107

Supplementary Article/Supplementary Info: with accessories

Wear Warning Contact: not prepared for wear indicator / excl. wear warning contact

Width [mm] 105.8

Number of bolts/screws: 2

Height 2 [mm]: 55.4

MAPP code available

CITROËN, DS, OPEL, PEUGEOT, VAUXHALL

13.0470-5633.2

LD5633

ATE Ceramic

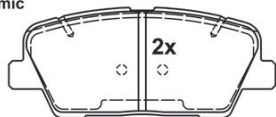

25520 15,8

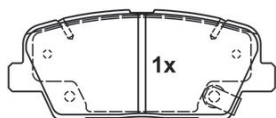

25521 15,8

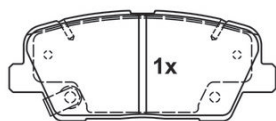

25522 15,8

117,0 x 48,4 x 15,8

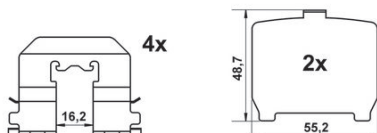

Brake Pad Set, disc brake

Thickness [mm] 15.8

Supplementary Article/Info 2: with anti-squeak plate

Brake System: Akebono

Test Mark: E9 90R-02A1242/3896

Supplementary Article/Supplementary Info: with accessories

Wear Warning Contact: with acoustic wear warning

Height [mm] 48.4

Width [mm] 117

MAPP code available

HYUNDAI, KIA

24.0111-0193.1

411193



Brake Disc

- Inner diameter [mm]: 168.5
- Minimum thickness [mm] 9.3
- Supplementary Article/Info 2: with bolts/screws
- Brake Disc Thickness [mm] 11
- Test Mark: E1 90R-02C0165/0360
- Surface Coated
- Centering Diameter [mm]: 67
- Number of Holes: 5
- Bore Ø [mm] 15.2
- Bolt Hole Circle Ø [mm]: 112
- Height [mm] 43
- MAPP code available
- Brake Disc Type: Solid
- Outer diameter [mm]: 276

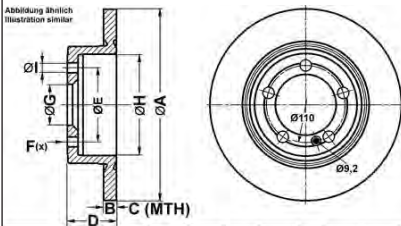

| | A | B | C | D | E | F(x) | G | H | I |
|--|-------|------|-----|------|-------|------|------|-------|------|
| | 276,0 | 11,0 | 9,3 | 43,0 | 112,0 | 5 | 67,0 | 168,5 | 15,2 |

MERCEDES-BENZ

24.0112-0211.1

412211



Brake Disc

- Inner diameter [mm]: 133
- Minimum thickness [mm] 10
- Supplementary Article/Info 2: with bolts/screws
- Brake Disc Thickness [mm] 12
- Test Mark: E1 90R-02C0165/0618
- Surface Coated
- Centering Diameter [mm]: 71.1
- Number of Holes: 5
- Bore Ø [mm] 13.2
- Bolt Hole Circle Ø [mm]: 108
- Height [mm] 35
- MAPP code available
- Brake Disc Type: Solid
- Outer diameter [mm]: 268

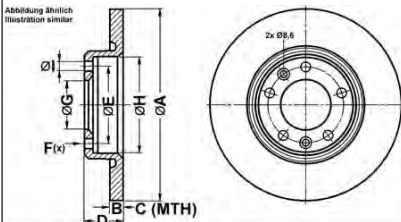

| | A | B | C | D | E | F(x) | G | H | I |
|--|-------|------|------|------|-------|------|------|-------|------|
| | 268,0 | 12,0 | 10,0 | 35,0 | 108,0 | 5 | 71,1 | 133,0 | 13,2 |

CITROËN, DS, OPEL, PEUGEOT, VAUXHALL

24.0112-0212.1

412212

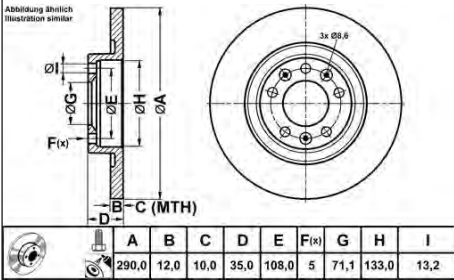

Brake Disc

- Inner diameter [mm]: 133
- Minimum thickness [mm] 10
- Supplementary Article/Info 2: with bolts/screws
- Brake Disc Thickness [mm] 12
- Test Mark: E1 90R-02C0165/0619
- Surface Coated
- Centering Diameter [mm]: 71.1
- Number of Holes: 5
- Bore Ø [mm] 13.2
- Bolt Hole Circle Ø [mm]: 108
- Height [mm] 35
- MAPP code available
- Brake Disc Type: Solid
- Outer diameter [mm]: 290
- CITROËN, DS, OPEL, PEUGEOT, TOYOTA, VAUXHALL**

24.0122-0194.1

422194

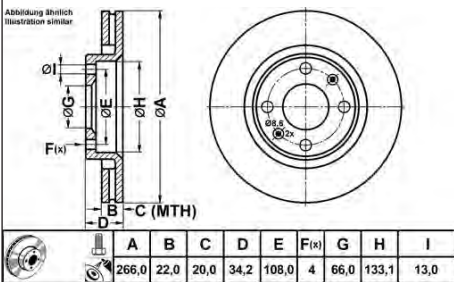

Brake Disc

- Inner diameter [mm]: 133.1
- Minimum thickness [mm] 20
- Supplementary Article/Info 2: with bolts/screws
- Brake Disc Thickness [mm] 22
- Test Mark: E1 90R-02C0118/0490
- Surface Coated
- Centering Diameter [mm]: 66
- Number of Holes: 4
- Bore Ø [mm] 13
- Bolt Hole Circle Ø [mm]: 108
- Height [mm] 34.2
- MAPP code available
- Brake Disc Type: Vented
- Outer diameter [mm]: 266
- CITROËN, DS, OPEL, PEUGEOT, VAUXHALL**

24.0122-0211.1

422211



Brake Disc

- Inner diameter [mm]: 154.6
- Minimum thickness [mm] 19.5
- Machining: High-carbon
- Supplementary Article/Info 2: with bolts/screws
- Brake Disc Thickness [mm] 21.9
- Test Mark: E1 90R-02C0118/0060
- Surface Coated
- Centering Diameter [mm]: 76
- Number of Holes: 5
- Bore Ø [mm] 16.6
- Bolt Hole Circle Ø [mm]: 120
- Height [mm] 44.4
- MAPP code available
- Brake Disc Type: Vented
- Outer diameter [mm]: 294
- VW**

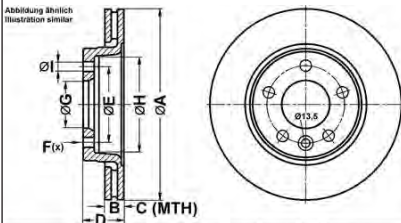

| | A | B | C | D | E | F(x) | G | H | I |
|--|-------|------|------|------|-------|------|------|-------|------|
| | 294,0 | 21,9 | 19,5 | 44,4 | 120,0 | 5 | 76,0 | 154,6 | 16,6 |

24.0126-0183.1

426183



Brake Disc

- Inner diameter [mm]: 134
- Minimum thickness [mm] 24
- Machining: Alloyed / High-carbon
- Supplementary Article/Info 2: with bolts/screws
- Brake Disc Thickness [mm] 26
- Test Mark: E1 90R-02C0115/1109
- Surface Coated
- Centering Diameter [mm]: 71
- Number of Holes: 5
- Bore Ø [mm] 13.3
- Bolt Hole Circle Ø [mm]: 108
- Height [mm] 48
- MAPP code available
- Brake Disc Type: Vented
- Outer diameter [mm]: 283
- CITROËN, OPEL, PEUGEOT, VAUXHALL**

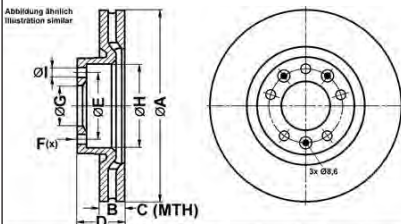

| | A | B | C | D | E | F(x) | G | H | I |
|--|-------|------|------|------|-------|------|------|-------|------|
| | 283,0 | 26,0 | 24,0 | 48,0 | 108,0 | 5 | 71,0 | 134,0 | 13,3 |

24.0128-0269.1

428269

**Brake Disc**

Inner diameter [mm]: 133.2

Minimum thickness [mm] 26

Machining: High-carbon

Supplementary Article/Info 2: with bolts/screws

Brake Disc Thickness [mm] 28

Test Mark: E1 90R-02C0115/0883

Surface Coated

Centering Diameter [mm]: 71

Number of Holes: 5

Bore Ø [mm] 13.2

Bolt Hole Circle Ø [mm]: 108

Height [mm] 48

MAPP code available

Brake Disc Type: Vented

Outer diameter [mm]: 304

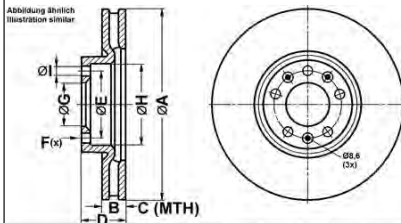
CITROËN, DS, OPEL, PEUGEOT, VAUXHALL

| | A | B | C | D | E | F(x) | G | H | I |
|--|-------|------|------|------|-------|------|------|-------|------|
| | 304,0 | 28,0 | 26,0 | 48,0 | 108,0 | 5 | 71,0 | 133,2 | 13,2 |

24.0130-0114.1

430114

**Brake Disc**

Inner diameter [mm]: 154.6

Minimum thickness [mm] 25.5

Machining: High-carbon

Brake Disc Thickness [mm] 29.5

Test Mark: E1 90R-02C0115/0880

Surface Coated

Centering Diameter [mm]: 76

Number of Holes: 5

Bore Ø [mm] 16.6

Bolt Hole Circle Ø [mm]: 120

Height [mm] 55.6

MAPP code available

Brake Disc Type: Vented

Outer diameter [mm]: 308

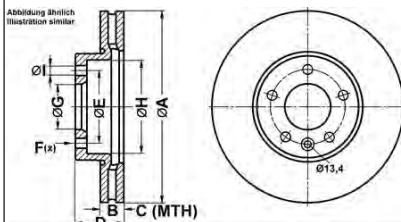
VW

| | A | B | C | D | E | F(x) | G | H | I |
|--|-------|------|------|------|-------|------|------|-------|------|
| | 308,0 | 29,5 | 25,5 | 55,6 | 120,0 | 5 | 76,0 | 154,6 | 16,6 |

24.0130-0241.1

430241

**Brake Disc**

Inner diameter [mm]: 138

Minimum thickness [mm] 28

Machining: Alloyed / High-carbon

Supplementary Article/Info 2: with bolts/screws

Brake Disc Thickness [mm] 30

Test Mark: E1 90R-02C0115/1107

Surface Coated

Centering Diameter [mm]: 71.1

Number of Holes: 5

Bore Ø [mm] 13.2

Bolt Hole Circle Ø [mm]: 108

Height [mm] 48

MAPP code available

Brake Disc Type: Vented

Outer diameter [mm]: 330

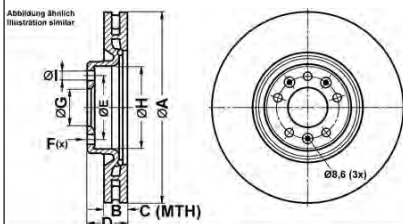
CITROËN, DS, OPEL, PEUGEOT, VAUXHALL

| | A | B | C | D | E | F(x) | G | H | I |
|--|-------|------|------|------|-------|------|------|-------|------|
| | 330,0 | 30,0 | 28,0 | 48,0 | 108,0 | 5 | 71,1 | 138,0 | 13,2 |

24.0133-0100.1

433100

**Brake Disc**

Inner diameter [mm]: 154.8

Minimum thickness [mm] 29.5

Machining: High-carbon

Supplementary Article/Info 2: with bolts/screws

Brake Disc Thickness [mm] 32.6

Test Mark: E1 90R-02C0115/0414

Surface Coated

Centering Diameter [mm]: 76

Number of Holes: 5

Bore Ø [mm] 16.6

Bolt Hole Circle Ø [mm]: 120

Height [mm] 55.6

MAPP code available

Brake Disc Type: Vented

Outer diameter [mm]: 340

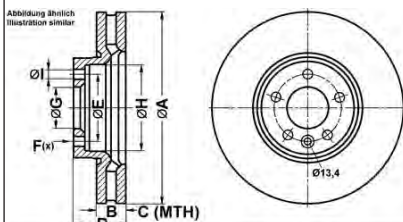
VW

| | A | B | C | D | E | F(x) | G | H | I |
|--|-------|------|------|------|-------|------|------|-------|------|
| | 340,0 | 32,6 | 29,5 | 55,6 | 120,0 | 5 | 76,0 | 154,8 | 16,6 |

24.0710-2031.3

360551

**Wheel Speed Sensor**

MAPP code available

Length [mm]: 661

RENAULT

24.0711-5271.3

360301



Wheel Speed Sensor

Supplementary Article/Info 2: without cable

MAPP code available

AUDI, PORSCHE, SEAT, SKODA, VW

24.0711-5272.3

360302



Wheel Speed Sensor

Supplementary Article/Info 2: without cable

MAPP code available

AUDI, PORSCHE, SEAT, SKODA, VW

24.0711-5473.3

360452



Wheel Speed Sensor

Supplementary Article/Info 2: without cable

MAPP code available

POLESTAR, VOLVO

24.3367-0441.5

241373



Brake Caliper

Brake System: ATE

Supplementary Article/Supplementary Info: without holder

Piston Diameter [mm]: 36

Paired article numbers: 24.3367-0442.5

MAPP code available

Brake Caliper Type: Fist-type Caliper

MAZDA

24.3367-0442.5

241374



Brake Caliper

Brake System: ATE

Supplementary Article/Supplementary Info: without holder

Piston Diameter [mm]: 36

Paired article numbers: 24.3367-0441.5

MAPP code available

Brake Caliper Type: Fist-type Caliper

MAZDA

24.3414-1711.5**240852****Brake Caliper**

Brake System: Lucas / TRW

Supplementary Article/Supplementary Info: without holder

Service exchange part

Piston Diameter [mm]: 41

Paired article numbers: 24.3414-1712.5

MAPP code available

Brake Caliper Type: Fist-type Caliper

VW**24.3414-1712.5****240853****Brake Caliper**

Brake System: Lucas / TRW

Supplementary Article/Supplementary Info: without holder

Service exchange part

Piston Diameter [mm]: 41

Paired article numbers: 24.3414-1711.5

MAPP code available

Brake Caliper Type: Fist-type Caliper

VW**24.3441-9933.5****241141****Brake Caliper**

Brake System: ATE

Supplementary Article/Supplementary Info: without holder

Service exchange part

Piston Diameter [mm]: 44

Paired article numbers: 24.3441-9934.5

MAPP code available

Brake Caliper Type: Fist-type Caliper (2 pistons)

VW**24.3441-9934.5****241142****Brake Caliper**

Brake System: ATE

Supplementary Article/Supplementary Info: without holder

Service exchange part

Piston Diameter [mm]: 44

Paired article numbers: 24.3441-9933.5

MAPP code available

Brake Caliper Type: Fist-type Caliper (2 pistons)

VW

24.3481-9962.5

241460



Brake Caliper

Brake System: ATE

Supplementary Article/Supplementary Info: without holder

Service exchange part

Piston Diameter [mm]: 48

Paired article numbers: 24.3481-9961.5

MAPP code available

Brake Caliper Type: Fist-type Caliper (2 pistons)

NISSAN

24.3601-9947.5

240597



Brake Caliper

Brake System: ATE

Supplementary Article/Supplementary Info: without holder

Service exchange part

Piston Diameter [mm]: 60

Paired article numbers: 24.3601-9948.5

Brake Caliper Type: Fist-type Caliper

VW

24.3601-9948.5

240598



Brake Caliper

Brake System: ATE

Supplementary Article/Supplementary Info: without holder

Service exchange part

Piston Diameter [mm]: 60

Paired article numbers: 24.3601-9947.5

Brake Caliper Type: Fist-type Caliper

VW

24.3727-0184.2

580184

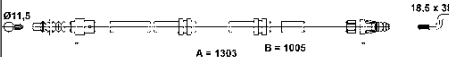

Cable Pull, parking brake

MAPP code available

Length [mm]: 1,303

VW

24.3727-0472.2

580472

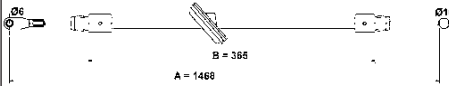

Cable Pull, parking brake

MAPP code available

Length [mm]: 1,468

MERCEDES-BENZ

24.3727-0671.2

580671

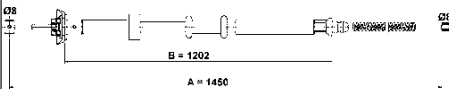

Cable Pull, parking brake

MAPP code available

Length [mm]: 1,450

FIAT, FORD

24.3727-3409.2

583409



Cable Pull, parking brake

MAPP code available

Length [mm]: 1,570

VW

24.3727-3502.2

583502

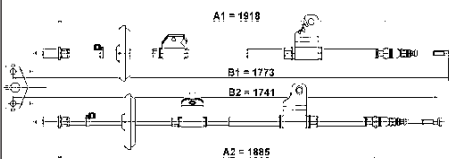

Cable Pull, parking brake

Length 2 [mm]: 1,918

Length [mm]: 1,885

OPEL, VAUXHALL

24.5103-0405.3

331647



Brake Hose

External Thread [mm]: M10x1

Internal Thread [mm]: M10x1

MAPP code available

Length [mm]: 425

OPEL, VAUXHALL

24.5103-0446.3**331630****Brake Hose**

External Thread [mm]: M10x1

Internal Thread [mm]: M10x1

MAPP code available

Length [mm]: 470

RENAULT**24.5103-0456.3****331631****Brake Hose**

External Thread [mm]: M10x1

Internal Thread [mm]: M10x1

Length [mm]: 456

MAPP code available

Spanner size 2 [mm]: 15.5

Spanner size 1 [mm]: 14

MERCEDES-BENZ**24.5104-0471.3****331642****Brake Hose**

External Thread [mm]: M10x1

Internal Thread [mm]: M10x1

Length [mm]: 470

MAPP code available

Spanner size 2 [mm]: 17

Spanner size 1 [mm]: 14

MERCEDES-BENZ**24.5112-0463.3****331643****Brake Hose**

External Thread [mm]: M10x1

Internal Thread [mm]: M10x1

Length [mm]: 485

MAPP code available

Spanner size 2 [mm]: 17

Spanner size 1 [mm]: 14

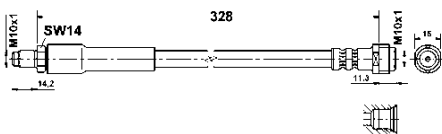
OPEL, VAUXHALL**24.5123-0328.3****330910****Brake Hose**

External Thread [mm]: M10x1

Internal Thread [mm]: M10x1

Length [mm]: 328

MAPP code available

Spanner size 2 [mm]: 15

Spanner size 1 [mm]: 14

MERCEDES-BENZ

24.5140-0194.3 331383

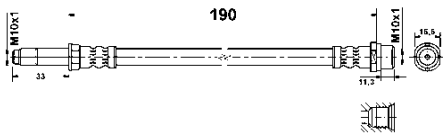

 **Brake Hose**

- External Thread [mm]: M10x1
- Internal Thread [mm]: M10x1
- Length [mm]: 190
- MAPP code available
- Spanner size 2 [mm]: 17
- Spanner size 1 [mm]: 15
- VW**

24.5140-0498.3 330912

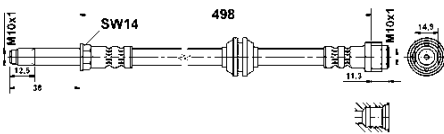

 **Brake Hose**

- External Thread [mm]: M10x1
- Internal Thread [mm]: M10x1
- Length [mm]: 498
- MAPP code available
- Spanner size 2 [mm]: 15
- Spanner size 1 [mm]: 14
- MERCEDES-BENZ**

24.5140-0514.3 331290

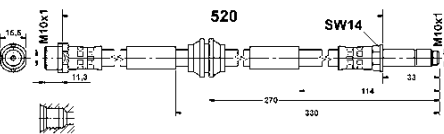

 **Brake Hose**

- External Thread [mm]: M10x1
- Internal Thread [mm]: M10x1
- Length [mm]: 520
- MAPP code available
- Spanner size 2 [mm]: 15.5
- Spanner size 1 [mm]: 14
- VW**

24.5141-0638.3 331629

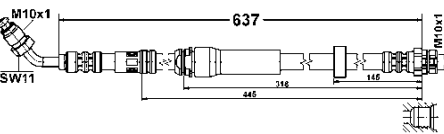

 **Brake Hose**

- External Thread [mm]: M10x1
- Internal Thread [mm]: M10x1
- Length [mm]: 637
- MAPP code available
- Spanner size 2 [mm]: 17
- Spanner size 1 [mm]: 11
- AUDI**

24.5176-0401.3 331649



 **Brake Hose**

- Flange Hole Diameter [mm]: 10
- Internal Thread [mm]: M10x1
- Supplementary Article/Info 2: with hollow screw
- Thread Size: M10x1,5
- Length [mm]: 410
- MAPP code available
- CHEVROLET, OPEL, VAUXHALL**

24.5176-0402.3

331633



Brake Hose

Flange Hole Diameter [mm]: 10
Internal Thread [mm]: M10x1
Supplementary Article/Info 2: with hollow screw
Thread Size: M10x1,5
Length [mm]: 410
MAPP code available

CHEVROLET, OPEL, VAUXHALL

24.5176-0425.3

331644



Brake Hose

Flange Hole Diameter [mm]: 10
Internal Thread [mm]: M10x1
Overall Length [mm]: 435
Supplementary Article/Info 2: with hollow screw
Thread Size: M10x1,5
Length [mm]: 425
MAPP code available

OPEL, VAUXHALL

24.5201-0210.3

331634



Brake Hose

Internal Thread 1 [mm]: M10x1
MAPP code available
Internal Thread 2 [mm]: M10x1
Length [mm]: 205
Spanner size 1 [mm]: 17

BMW

24.5237-0250.3

330880

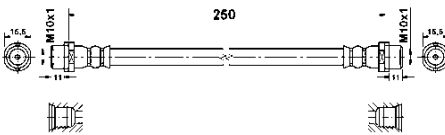

Brake Hose

Internal Thread 2 [mm]: M10x1
Internal Thread 1 [mm]: M10x1
Length [mm]: 250
MAPP code available
Spanner size 1 [mm]: 15.5

VW

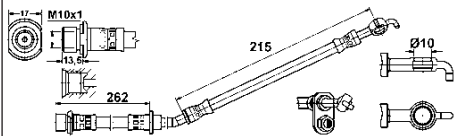
24.5265-0499.3**331550****Brake Hose**

Flange Hole Diameter [mm]: 10

Internal Thread [mm]: M10x1

Supplementary Article/Info 2: without hollow screw

Length 2 [mm]: 215

Length 1 [mm]: 262

Length [mm]: 498

MAPP code available

Spanner size 1 [mm]: 17

TOYOTA**24.6240-7001.5****241315****Brake Caliper**

Brake System: ATE

Supplementary Article/Supplementary Info: with electric motor / without holder

Service exchange part

Piston Diameter [mm]: 40

Paired article numbers: 24.6240-7002.5

MAPP code available

Brake Caliper Type: Fist-type Caliper

Brake Caliper Type: Brake caliper with adjusting element for electr. handbrake

JAGUAR**24.6240-7002.5****241316****Brake Caliper**

Brake System: ATE

Supplementary Article/Supplementary Info: with electric motor / without holder

Service exchange part

Piston Diameter [mm]: 40

Paired article numbers: 24.6240-7001.5

MAPP code available

Brake Caliper Type: Fist-type Caliper

Brake Caliper Type: Brake caliper with adjusting element for electr. handbrake

JAGUAR**24.8190-0829.2****620829****Warning Contact, brake pad wear**

Brake Type: Disc Brake

Length [mm]: 160

VW

24.8190-0831.2

620831



Warning Contact, brake pad wear

Brake Type: Disc Brake

Length [mm]: 231

VW

83.6113-0552.3

330864

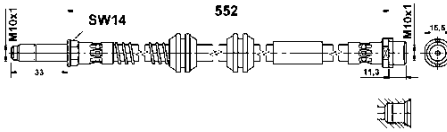

 **Brake Hose**

External Thread [mm]: M10x1

Internal Thread [mm]: M10x1

Length [mm]: 552

MAPP code available

Spanner size 2 [mm]: 15.5

Spanner size 1 [mm]: 14

VW



EN Applications of vehicles



DE Fahrzeugverwendungen





ES Aplicaciones



FR Applications





IT Applicazioni autoveicoli





07/2022



| | | | | | | |
|---|-----------|-------------|---|---|----------------|--------------------------|
| | | kW | | | | |
| ALFA ROMEO - 159 (939_) 06/05→12/12 | | | | | | |
| Spring, brake caliper | | | | | | |
| 1.8 MPI | 103 | 06/05→11/11 | → Construction year to: 10/11; | 2 | 11.8116-0237.1 | 390509 Brake System: ATE |
| 1.9 JTS | 118 | 09/05→11/11 | Required quantity: 2 | | | |
| 2.2 JTS | 136 | 09/05→11/11 | | | | |
| ALFA ROMEO - 159 Sportwagon (939_) 06/05→12/12 | | | | | | |
| Spring, brake caliper | | | | | | |
| 1.8 MPI | 103 | 06/05→11/11 | → Construction year to: 10/11; | 2 | 11.8116-0237.1 | 390509 Brake System: ATE |
| 1.9 JTS | 118 | 03/06→11/11 | Required quantity: 2 | | | |
| 2.2 JTS | 136 | 03/06→11/11 | | | | |
| ALFA ROMEO - BRERA (939_) 01/06→05/11 | | | | | | |
| Spring, brake caliper | | | | | | |
| 2.2 JTS | 136 | 01/06→05/11 | Suspension: for vehicles without sports suspension; Required quantity: 2 | 2 | 11.8116-0237.1 | 390509 Brake System: ATE |
| ALFA ROMEO - GIULIETTA (940_) 04/10→12/20 | | | | | | |
| Spring, brake caliper | | | | | | |
| 1.4 TB | 110 - 125 | 04/10→10/18 | Required quantity: 2; | 2 | 11.8116-0237.1 | 390509 Brake System: ATE |
| 2.0 JTDM | 100 - 129 | 04/10→12/20 | Fitting Position: Front Axle | | | |
| ALFA ROMEO - GIULIETTA Hatchback Van (940_) 04/11→12/20 | | | | | | |
| Spring, brake caliper | | | | | | |
| 2.0 JTDM | 103 - 129 | 04/11→12/20 | Required quantity: 2; | 2 | 11.8116-0237.1 | 390509 Brake System: ATE |
| ALFA ROMEO - SPIDER (939_) 03/06→03/11 | | | | | | |
| Spring, brake caliper | | | | | | |
| 2.2 JTS | 136 | 03/06→03/11 | Construction year from: 04/06 → → Construction year to: 02/08; Required quantity: 2 | 2 | 11.8116-0237.1 | 390509 Brake System: ATE |
| AUDI - A1 (8X1, 8XK) 05/10→10/18 | | | | | | |
|  Wheel Speed Sensor | | | | | | |
| 1.0 TFSI | 60 - 70 | 03/15→10/18 | for PR number: 0N0; | | 24.0711-5271.3 | 360301 |
| 1.2 TFSI | 63 | 05/10→04/15 | Fitting Position: Rear Axle Left | | | |
| 1.4 TDI | 66 | 11/14→10/18 | | | | |
| 1.4 TFSI | 90 - 136 | 05/10→10/18 | | | | |
| 1.4 TSI | 110 | 11/14→10/18 | | | | |
| 1.6 TDI | 66 - 85 | 05/10→10/18 | | | | |
| 1.8 TFSI | 141 | 02/15→10/18 | | | | |
| 2.0 TDI | 100 - 105 | 09/11→04/15 | | | | |
| S1 quattro | 170 | 03/14→10/18 | | | | |
| 2.0 TFSI quattro | 188 | 03/12→11/12 | Construction year from: 10/12 →; for PR number: 0N0; Fitting Position: Rear Axle Left | | 24.0711-5271.3 | 360301 |
| AUDI - A1 Sportback (8XA, 8XF) 09/11→10/18 | | | | | | |
|  Wheel Speed Sensor | | | | | | |
| 1.0 TFSI | 60 - 70 | 03/15→10/18 | for PR number: 0N0; | | 24.0711-5271.3 | 360301 |
| 1.2 TFSI | 63 | 01/12→04/15 | Fitting Position: Rear Axle Left | | | |
| 1.4 TDI | 66 | 11/14→10/18 | | | | |
| 1.4 TFSI | 90 - 136 | 11/11→10/18 | | | | |
| 1.4 TSI | 110 | 11/14→10/18 | | | | |
| 1.6 TDI | 66 - 85 | 11/11→10/18 | | | | |
| 1.8 TFSI | 141 | 02/15→10/18 | | | | |
| 2.0 TDI | 100 - 105 | 09/11→04/15 | | | | |
| S1 quattro | 170 | 03/14→10/18 | | | | |
| AUDI - A3 (8P1) 05/03→12/13 | | | | | | |
|  Wheel Speed Sensor | | | | | | |
| 1.2 TSI | 77 | 04/10→08/12 | Fitting Position: Front Axle Left | | 24.0711-5271.3 | 360301 |
| 1.4 TFSI | 92 | 09/07→08/12 | Fitting Position: Front Axle Right | | 24.0711-5272.3 | 360302 |
| 1.6 | 75 | 05/03→08/12 | | | | |
| 1.6 E-Power | 75 | 01/11→08/12 | | | | |
| 1.6 FSI | 85 | 08/03→09/07 | | | | |
| → | | | | | | |



| | kW | | | |
|---|---------------------|--|---|---|
| AUDI - A3 (8P1) 05/03→12/13 | | | | |
|  Wheel Speed Sensor | | | | |
| 1.6 TDI | 66 - 05/09→08/12 | | Fitting Position: Front Axle Left | 24.0711-5271.3 360301 |
| 2.0 FSI | 77 110 05/03→06/08 | | Fitting Position: Front Axle Right | 24.0711-5272.3 360302 |
| 2.0 TDI | 100 - 05/03→08/12 | | | |
| 2.0 TDI 16V | 125 103 05/03→08/12 | | | |
| 2.0 TFSI | 147 09/04→08/12 | | | |
| 1.8 T | 110 08/06→08/12 | | Construction year from: 01/07 →; | 24.0711-5271.3 360301 |
| 1.8 TFSI | 118 11/06→08/12 | | Fitting Position: Front Axle Left | |
| | | | Construction year from: 01/07 →; | 24.0711-5272.3 360302 |
| | | | Fitting Position: Front Axle Right | |
| 1.8 TFSI quattro | 118 07/08→08/12 | | Fitting Position: Front Axle Left | 24.0711-5271.3 360301 |
| 2.0 TDI 16V quattro | 103 08/04→08/12 | | Fitting Position: Front Axle Right | 24.0711-5272.3 360302 |
| 2.0 TDI quattro | 100 - 05/03→08/12 | | Fitting Position: Rear Axle Left | 24.0711-5271.3 360301 |
| | 125 | | Fitting Position: Rear Axle Right | 24.0711-5272.3 360302 |
| 2.0 TFSI quattro | 147 09/04→08/12 | | Fitting Position: Rear Axle Right | 24.0711-5272.3 360302 |
| 3.2 V6 quattro | 184 07/03→05/09 | | | |
| S3 quattro | 195 11/06→08/12 | | | |
| 1.9 TDI | 77 05/03→05/10 | | Construction year from: 06/03 →; | 24.0711-5271.3 360301 |
| | | | Fitting Position: Front Axle Left | |
| | | | Construction year from: 06/03 →; | 24.0711-5272.3 360302 |
| | | | Fitting Position: Front Axle Right | |
| S3 quattro | 188 02/07→08/12 | | Construction year from: 07/08 →; | 24.0711-5271.3 360301 |
| | | | Fitting Position: Front Axle Left | |
| | | | Construction year from: 07/08 →; | 24.0711-5272.3 360302 |
| | | | Fitting Position: Front Axle Right | |
| | | | Construction year from: 07/08 →; | 24.0711-5271.3 360301 |
| | | | Fitting Position: Rear Axle Left | |
| | | | Construction year from: 07/08 →; | 24.0711-5272.3 360302 |
| | | | Fitting Position: Rear Axle Right | |
| AUDI - A3 (8V1, 8VK) 04/12→10/20 | | | | |
|  Brake Pad Set, disc brake | | | | |
| 1.0 TFSI | 85 07/16→12/17 | | for PR number: 1ZA / 1ZD / 1ZE / 1ZP; | 13.0470-2785.2 LD2785 Brake System: Lucas / TRW 25683 20,4 Wear Warning Contact: prepared for wear indicator / incl. wear warning contact Ceramic |
| 1.2 TFSI | 77 - 02/13→08/16 | | Fitting Position: Front Axle | |
| | 81 | | | |
| 1.4 TFSI | 90 - 04/12→08/16 | | | |
| | 103 | | | |
| 1.4 TSI | 110 05/14→12/17 | | | |
| 1.5 TFSI | 110 05/17→12/17 | | | |
| 1.6 TDI | 77 - 10/12→10/20 | | | |
| | 85 | | | |
| 1.8 TFSI | 132 04/12→08/16 | | | |
| 1.8 TFSI quattro | 132 08/12→08/16 | | | |
| 2.0 TDI | 81 - 04/12→10/20 | | | |
| | 135 | | | |
| 2.0 TDI quattro | 110 - 10/12→12/17 | | | |
| | 135 | | | |
| 2.0 TFSI | 140 05/16→12/17 | | | |
| 2.0 TFSI quattro | 140 05/16→12/17 | | | |
| S3 quattro | 206 - 11/12→12/17 | | | |
| | 221 | | | |
|  Wheel Speed Sensor | | | | |
| 1.8 TFSI quattro | 132 08/12→08/16 | | Vehicle Equipment: for vehicles without parking assistant system; | 24.0711-5271.3 360301 |
| 2.0 TDI quattro | 110 - 10/12→12/17 | | Fitting Position: Rear Axle Left | |
| | 135 | | | |
| 2.0 TFSI quattro | 140 05/16→12/17 | | Comfort Package: not for cruise control system; Fitting Position: Rear Axle Left | 24.0711-5271.3 360301 |
| S3 quattro | 206 - 11/12→12/17 | | Vehicle Equipment: for vehicles without parking assistant system; | 24.0711-5272.3 360302 |
| | 228 | | Fitting Position: Rear Axle Right | |
| | | | Comfort Package: not for cruise control system; Fitting Position: Rear Axle Right | 24.0711-5272.3 360302 |
| AUDI - A3 Convertible (8P7) 04/08→05/13 | | | | |
|  Wheel Speed Sensor | | | | |
| 1.2 TFSI | 77 03/10→05/13 | | Fitting Position: Front Axle Left | 24.0711-5271.3 360301 |
| 1.4 TFSI | 92 02/11→05/13 | | Fitting Position: Front Axle Right | 24.0711-5272.3 360302 |
| 1.6 | 75 09/08→05/10 | | | |
| 1.6 TDI | 77 05/09→05/13 | | | |
| 1.8 TFSI | 118 04/08→05/13 | | | |
| 1.9 TDI | 77 04/08→10/09 | | | |
| 2.0 TDI | 100 - 04/08→05/13 | | | |
| | 103 | | | |
| 2.0 TFSI | 147 04/08→05/13 | | | |



| | kW | | | |
|--|--------------------------|--|------------------------------|---|
| AUDI - A3 Convertible (8V7, 8VE) 10/13→ | | | | |
|  Brake Pad Set, disc brake | | | | |
| 1.4 TFSI | 85 - 10/13→ 103 | for PR number: 1ZA / 1ZD / 1ZE / 1ZP; Fitting Position: Front Axle | 13.0470-2785.2 LD2785 | Brake System: Lucas / TRW 25683 20,4 Wear Warning Contact: prepared for wear indicator / incl. wear warning contact Ceramic |
| 1.4 TSI | 110 05/14→10/20 | | | |
| 1.5 TFSI | 110 05/17→10/18 | | | |
| 1.6 TDI | 81 - 02/14→10/20 85 | | | |
| 1.8 TFSI | 125 - 10/13→10/20 132 | | | |
| 1.8 TFSI quattro | 132 03/14→ | | | |
| 2.0 TDI | 100 - 10/13→ 135 | | | |
| 2.0 TDI quattro | 110 - 03/14→10/20 135 | | | |
| 2.0 TFSI | 140 05/16→10/20 | | | |
| 2.0 TFSI quattro | 140 - 05/14→10/20 162 | | | |
| 35 TFSI | 110 10/18→10/20 | | | |
| 40 TFSI | 140 11/18→10/20 | | | |
| 40 TFSI quattro | 140 11/18→10/20 | | | |
| S3 quattro | 210 - 03/14→ 221 | | | |
|  Wheel Speed Sensor | | | | |
| 1.8 TFSI quattro | 132 03/14→ | Vehicle Equipment: for vehicles without parking assistant system; | 24.0711-5271.3 360301 | |
| 2.0 TDI quattro | 110 - 03/14→10/20 135 | Fitting Position: Rear Axle Left | | |
| 2.0 TFSI quattro | 140 - 05/14→10/20 162 | Comfort Package: not for cruise control system; Fitting Position: Rear Axle Left | 24.0711-5271.3 360301 | |
| S3 quattro | 213 - 04/14→10/20 228 | Vehicle Equipment: for vehicles without parking assistant system; | 24.0711-5272.3 360302 | |
| | | Fitting Position: Rear Axle Right | | |
| | | Comfort Package: not for cruise control system; Fitting Position: Rear Axle Right | 24.0711-5272.3 360302 | |
| S3 quattro | 210 03/14→ | Construction year from: 04/14 →; Vehicle Equipment: for vehicles without parking assistant system; | 24.0711-5271.3 360301 | |
| | | Fitting Position: Rear Axle Left | | |
| | | Construction year from: 04/14 →; Comfort Package: not for cruise control system; Fitting Position: Rear Axle Left | 24.0711-5271.3 360301 | |
| | | Construction year from: 04/14 →; Vehicle Equipment: for vehicles without parking assistant system; | 24.0711-5272.3 360302 | |
| | | Fitting Position: Rear Axle Right | | |
| | | Construction year from: 04/14 →; Comfort Package: not for cruise control system; Fitting Position: Rear Axle Right | 24.0711-5272.3 360302 | |
| AUDI - A3 Limousine (8VS, 8VM) 05/13→ | | | | |
|  Brake Pad Set, disc brake | | | | |
| 1.0 TFSI | 85 07/16→10/20 | for PR number: 1ZA / 1ZD / 1ZE / 1ZP; | 13.0470-2785.2 LD2785 | Brake System: Lucas / TRW 25683 20,4 Wear Warning Contact: prepared for wear indicator / incl. wear warning contact Ceramic |
| 1.2 TFSI | 77 - 10/13→ 81 | Fitting Position: Front Axle | | |
| 1.4 TFSI | 90 - 05/13→ 103 | | | |
| 1.4 TSI | 110 05/14→10/20 | | | |
| 1.5 TFSI | 110 05/17→10/18 | | | |
| 1.6 TDI | 77 - 09/13→ 85 | | | |
| 1.6 TDI quattro | 81 05/15→ | | | |
| 1.8 TFSI | 125 - 05/13→ 132 | | | |
| 1.8 TFSI quattro | 132 11/13→ | | | |
| 2.0 TDI | 81 - 05/13→ 135 | | | |
| 2.0 TDI quattro | 110 - 10/13→10/20 135 | | | |
| 2.0 TFSI | 140 - 11/15→10/20 162 | | | |
| 2.0 TFSI quattro | 140 05/16→10/20 | | | |
| 30 TDI | 85 07/18→10/20 | | | |
| 30 TFSI | 85 07/18→10/20 | | | |
| 35 TDI | 110 07/18→10/20 | | | |
| 35 TFSI | 110 10/18→10/20 | | | |
| 40 TDI quattro | 135 07/18→07/19 | | | |
| 40 TFSI | 140 07/18→10/20 | | | |
| 40 TFSI quattro | 140 07/18→10/20 | | | |
| S3 quattro | 206 - 10/13→ 221 | | | |
| → | | | | |







| | kW | | | |
|--|---------------------|--|--|---|
| AUDI - A3 Limousine (8VS, 8VM) 05/13→ | | | | |
|  Wheel Speed Sensor | | | | |
| 1.6 TDI quattro | 81 05/15→ | Vehicle Equipment: for vehicles without parking assistant system; Fitting Position: Rear Axle Left | | 24.0711-5271.3 360301 |
| 1.8 TFSI quattro | 132 11/13→ | | | |
| 2.0 TDI quattro | 110 - 10/13→10/20 | Comfort Package: not for cruise control system; Fitting Position: Rear Axle Left | | 24.0711-5271.3 360301 |
| | 135 | | | |
| 2.0 TFSI quattro | 140 05/16→10/20 | Vehicle Equipment: for vehicles without parking assistant system; Fitting Position: Rear Axle Right | | 24.0711-5272.3 360302 |
| S3 quattro | 206 - 10/13→ 228 | | | |
| | | Comfort Package: not for cruise control system; Fitting Position: Rear Axle Right | | 24.0711-5272.3 360302 |
| AUDI - A3 Limousine (8YS) 03/20→ | | | | |
|  Brake Pad Set, disc brake | | | | |
| 30 TDI | 85 06/20→ | for PR number: 1ZK / 1ZL; Fitting Position: Front Axle | | 13.0470-2785.2 LD2785 Brake System: Lucas / TRW 25683 20,4 Wear Warning Contact: prepared for wear indicator / incl. wear warning contact Ceramic |
| 30 TFSI | 81 06/20→ | | | |
| 30 TFSI Mild Hybrid | 81 06/20→ | | | |
| 35 TDI | 110 04/20→ | | | |
| 35 TFSI | 110 04/20→ | | | |
| 35 TFSI Mild Hybrid | 110 04/20→ | | | |
| 40 TDI quattro | 147 12/20→ | | | |
| 40 TFSI quattro | 140 07/21→ | | | |
| AUDI - A3 Sportback (8PA) 09/04→12/15 | | | | |
|  Wheel Speed Sensor | | | | |
| 1.2 TSI | 77 04/10→03/13 | Fitting Position: Front Axle Left | | 24.0711-5271.3 360301 |
| 1.4 TFSI | 92 09/07→03/13 | Fitting Position: Front Axle Right | | 24.0711-5272.3 360302 |
| 1.6 | 75 09/04→03/13 | | | |
| 1.6 E-Power | 75 01/11→03/13 | | | |
| 1.6 FSI | 85 09/04→09/07 | | | |
| 1.6 TDI | 66 - 05/09→03/13 | | | |
| | 77 | | | |
| 1.9 TDI | 77 09/04→05/10 | | | |
| 2.0 FSI | 110 09/04→06/08 | | | |
| 2.0 TDI | 100 - 09/04→03/13 | | | |
| | 125 | | | |
| 2.0 TDI 16V | 103 09/04→03/13 | | | |
| 2.0 TFSI | 147 09/04→03/13 | | | 24.0711-5271.3 360301 |
| 1.8 TFSI | 118 11/06→03/13 | Construction year from: 01/07 →; Fitting Position: Front Axle Left | | 24.0711-5272.3 360302 |
| | | Construction year from: 01/07 →; Fitting Position: Front Axle Right | | 24.0711-5271.3 360301 |
| 1.8 TFSI quattro | 118 07/08→03/13 | Fitting Position: Front Axle Left | | 24.0711-5272.3 360302 |
| 2.0 TDI 16V quattro | 103 11/05→03/13 | Fitting Position: Front Axle Right | | 24.0711-5271.3 360301 |
| 2.0 TDI quattro | 103 - 01/06→03/13 | Fitting Position: Rear Axle Left | | 24.0711-5272.3 360302 |
| | 125 | Fitting Position: Rear Axle Right | | 24.0711-5271.3 360301 |
| 2.0 TFSI quattro | 147 09/04→03/13 | | | 24.0711-5272.3 360302 |
| 3.2 V6 quattro | 184 09/04→05/09 | | | |
| S3 quattro | 188 - 06/08→03/13 | | | |
| | 195 | | | |
| RS3 quattro | 250 01/11→12/12 | Construction year from: 04/11 →; Fitting Position: Front Axle Left | | 24.0711-5271.3 360301 |
| | | Construction year from: 04/11 →; Fitting Position: Front Axle Right | | 24.0711-5272.3 360302 |
| | | Construction year from: 04/11 →; Fitting Position: Rear Axle Left | | 24.0711-5271.3 360301 |
| | | Construction year from: 04/11 →; Fitting Position: Rear Axle Right | | 24.0711-5272.3 360302 |
| AUDI - A3 Sportback (8VA, 8VF) 09/12→ | | | | |
|  Brake Pad Set, disc brake | | | | |
| 1.0 TFSI | 85 07/16→10/20 | for PR number: 1ZA / 1ZD / 1ZE / 1ZP; Fitting Position: Front Axle | | 13.0470-2785.2 LD2785 Brake System: Lucas / TRW 25683 20,4 Wear Warning Contact: prepared for wear indicator / incl. wear warning contact Ceramic |
| 1.2 TFSI | 77 - 05/13→ | | | |
| | 81 | | | |
| 1.4 TFSI | 90 - 09/12→ | | | |
| | 103 | | | |
| 1.4 TFSI e-tron | 110 - 05/14→10/20 | | | |
| | 150 | | | |
| 1.4 TFSI g-tron | 81 11/13→10/20 | | | |
| 1.4 TSI | 110 05/14→10/20 | | | |
| 1.5 TFSI | 110 05/17→10/18 | | | |
| 1.6 TDI | 77 - 10/12→ | | | |
| | 85 | | | |
| 1.6 TDI quattro | 81 05/15→08/16 | | | |
| 1.8 TFSI | 132 09/12→ | | | |
| 1.8 TFSI quattro | 132 05/13→ | | | |
| 2.0 TDI | 81 - 09/12→10/20 | | | |
| | 135 | | | |
| → | | | | |





| | kW | | | |
|--|--------------------------|--|------------------------------|---|
| AUDI - A3 Sportback (8VA, 8VF) 09/12→ | | | | |
|  Brake Pad Set, disc brake | | | | |
| 2.0 TDI quattro | 110 - 02/13→10/20 135 | for PR number: 1ZA / 1ZD / 1ZE / 1ZP; Fitting Position: Front Axle | 13.0470-2785.2 LD2785 | Brake System: Lucas / TRW 25683 20,4 Wear Warning Contact: prepared for wear indicator / incl. wear warning contact Ceramic |
| 2.0 TFSI | 140 05/16→10/20 | | | |
| 2.0 TFSI quattro | 140 05/16→10/20 | | | |
| 30 g-tron | 96 11/18→10/20 | | | |
| 30 TDI | 85 07/18→10/20 | | | |
| 30 TFSI | 85 07/18→10/20 | | | |
| 35 TDI | 110 07/18→10/20 | | | |
| 35 TFSI | 110 10/18→10/20 | | | |
| 40 TDI quattro | 135 07/18→10/20 | | | |
| 40 TFSI | 140 07/18→10/20 | | | |
| 40 TFSI quattro | 140 07/18→10/20 | | | |
| S3 quattro | 206 - 11/12→ 221 | | | |
|  Wheel Speed Sensor | | | | |
| 1.6 TDI quattro | 81 05/15→08/16 | Vehicle Equipment: for vehicles without parking assistant system; | 24.0711-5271.3 360301 | |
| 1.8 TFSI quattro | 132 05/13→ | | | |
| 2.0 TDI quattro | 110 - 02/13→10/20 135 | Fitting Position: Rear Axle Left | | |
| 2.0 TFSI quattro | 140 05/16→10/20 | Comfort Package: not for cruise control system; Fitting Position: Rear Axle Left | 24.0711-5271.3 360301 | |
| RS3 quattro | 270 - 03/15→ 294 | Vehicle Equipment: for vehicles without parking assistant system; | 24.0711-5272.3 360302 | |
| S3 quattro | 206 - 11/12→ 228 | Fitting Position: Rear Axle Right | | |
| | | Comfort Package: not for cruise control system; Fitting Position: Rear Axle Right | 24.0711-5272.3 360302 | |
| AUDI - A3 Sportback (8YA) 11/19→ | | | | |
|  Brake Pad Set, disc brake | | | | |
| 30 g-tron | 96 07/20→ | for PR number: 1ZK / 1ZL; Fitting Position: Front Axle | 13.0470-2785.2 LD2785 | Brake System: Lucas / TRW 25683 20,4 Wear Warning Contact: prepared for wear indicator / incl. wear warning contact Ceramic |
| 30 TDI | 85 11/19→ | | | |
| 30 TFSI | 81 06/20→ | | | |
| 30 TFSI Mild Hybrid | 81 06/20→ | | | |
| 35 TDI | 110 11/19→ | | | |
| 35 TFSI | 110 11/19→ | | | |
| 35 TFSI Mild Hybrid | 110 04/20→ | | | |
| 40 TDI quattro | 147 12/20→ | | | |
| 40 TFSIe | 110 06/20→ | | | |
| 40 TFSI quattro | 140 07/21→ | | | |
| 45 TFSIe | 110 07/21→ | | | |
| AUDI - A4 Allroad B9 (8WH, 8WJ) 01/16→ | | | | |
|  Brake Hose | | | | |
| 2.0 TDI quattro | 100 - 01/16→ 140 | for PR number: 1LA / 1LB; Fitting Position: Front Axle Right | 24.5141-0638.3 331629 | Length [mm]: 637 |
| 2.0 TFSI Mild Hybrid quattro | 185 11/18→10/19 | | | |
| 2.0 TFSI quattro | 183 - 01/16→ 185 | | | |
| 3.0 TDI quattro | 160 - 01/16→10/19 210 | | | |
| 40 TDI Mild Hybrid quattro | 150 09/20→ | | | |
| 40 TDI quattro | 140 01/20→ | | | |
| 45 TDI quattro | 170 07/18→ | | | |
| 45 TFSI Mild Hybrid quattro | 180 - 07/18→ 195 | | | |
| 50 TDI Mild Hybrid quattro | 210 08/20→ | | | |
| 50 TDI quattro | 210 11/19→ | | | |
| AUDI - A4 B9 (8W2, 8WC) 05/15→ | | | | |
|  Brake Hose | | | | |
| 1.4 TFSI | 110 08/15→11/19 | for PR number: 1LA / 1LB; Fitting Position: Front Axle Right | 24.5141-0638.3 331629 | Length [mm]: 637 |
| 2.0 TDI | 90 - 05/15→ 140 | | | |
| 2.0 TDI quattro | 110 - 09/15→11/19 140 | | | |
| 2.0 TFSI | 140 - 05/15→ 185 | | | |
| 2.0 TFSI Mild Hybrid | 185 05/17→11/19 | | | |
| 2.0 TFSI Mild Hybrid quattro | 185 05/17→11/19 | | | |
| 2.0 TFSI quattro | 183 - 05/15→ 185 | | | |
| 3.0 TDI | 160 09/15→08/18 | | | |
| 3.0 TDI quattro | 160 - 05/15→08/18 200 | | | |
| 30 TDI | 90 05/16→11/19 | | | |





| | kW | | | |
|---|-------------------|---|------------------------------|------------------|
| AUDI - A4 B9 (8W2, 8WC) 05/15→ | | | | |
|  Brake Hose | | | | |
| 30 TDI Mild Hybrid | 100 07/19→ | for PR number: 1LA / 1LB; Fitting Position: Front Axle Right | 24.5141-0638.3 331629 | Length [mm]: 637 |
| 35 TDI | 110 08/15→11/19 | | | |
| 35 TDI Mild Hybrid | 120 03/19→ | | | |
| 35 TFSI Mild Hybrid | 110 12/18→11/19 | | | |
| 40 TDI | 140 05/15→11/19 | | | |
| 40 TDI Mild Hybrid | 150 09/20→ | | | |
| 40 TDI Mild Hybrid quattro | 150 05/20→ | | | |
| 40 TDI quattro | 140 09/15→11/19 | | | |
| 40 TFSI Mild Hybrid | 140 - 05/17→ | | | |
| | 150 | | | |
| 40 TFSI Mild Hybrid quattro | 150 06/20→ | | | |
| 45 TDI quattro | 170 07/18→11/19 | | | |
| 45 TFSI Mild Hybrid | 180 07/18→11/19 | | | |
| 45 TFSI Mild Hybrid quattro | 180 - 07/18→ | | | |
| | 195 | | | |
| 50 TDI Mild Hybrid quattro | 210 08/20→ | | | |
| 50 TDI quattro | 210 07/18→11/19 | | | |
| S4 quattro | 260 05/16→11/19 | | | |
| S4 TDI Mild Hybrid quattro | 251 - 05/19→ | | | |
| | 255 | | | |
| AUDI - A4 B9 Avant (8W5, 8WD) 08/15→ | | | | |
|  Brake Hose | | | | |
| 1.4 TFSI | 110 02/16→10/19 | for PR number: 1LA / 1LB; Fitting Position: Front Axle Right | 24.5141-0638.3 331629 | Length [mm]: 637 |
| 2.0 TDI | 90 - 08/15→10/19 | | | |
| | 140 | | | |
| 2.0 TDI quattro | 110 - 10/15→10/19 | | | |
| | 140 | | | |
| 2.0 TFSI | 140 - 08/15→ | | | |
| | 185 | | | |
| 2.0 TFSI g-tron | 125 11/16→10/19 | | | |
| 2.0 TFSI Mild Hybrid | 185 05/17→10/19 | | | |
| 2.0 TFSI Mild Hybrid quattro | 185 11/18→ | | | |
| 2.0 TFSI quattro | 183 - 08/15→10/19 | | | |
| | 185 | | | |
| 3.0 TDI | 160 10/15→08/18 | | | |
| 3.0 TDI quattro | 160 - 08/15→08/18 | | | |
| | 200 | | | |
| 30 TDI | 90 10/18→10/19 | | | |
| 30 TDI Mild Hybrid | 100 07/19→ | | | |
| 35 TDI | 110 10/18→10/19 | | | |
| 35 TDI Mild Hybrid | 120 07/19→ | | | |
| 35 TFSI Mild Hybrid | 110 12/18→10/19 | | | |
| 40 TDI | 140 10/18→05/19 | | | |
| 40 TDI Mild Hybrid quattro | 150 05/20→ | | | |
| 40 TDI quattro | 140 10/18→09/20 | | | |
| 40 TFSI g-tron | 125 11/16→10/19 | | | |
| 40 TFSI Mild Hybrid | 140 - 05/17→ | | | |
| | 150 | | | |
| 40 TFSI Mild Hybrid quattro | 150 06/20→ | | | |
| 45 TDI quattro | 170 07/18→10/19 | | | |
| 45 TFSI Mild Hybrid | 180 07/18→10/19 | | | |
| 45 TFSI Mild Hybrid quattro | 180 - 07/18→ | | | |
| | 195 | | | |
| 50 TDI Mild Hybrid quattro | 210 08/20→ | | | |
| 50 TDI quattro | 210 07/18→10/19 | | | |
| S4 quattro | 260 05/16→10/19 | | | |
| S4 TDI Mild Hybrid quattro | 251 - 05/19→ | | | |
| | 255 | | | |
| AUDI - A5 (F53, F5P) 06/16→ | | | | |
|  Brake Hose | | | | |
| 1.4 TFSI | 110 11/16→02/20 | for PR number: 1LA / 1LB; Fitting Position: Front Axle Right | 24.5141-0638.3 331629 | Length [mm]: 637 |
| 2.0 TDI | 110 - 07/16→ | | | |
| | 140 | | | |
| 2.0 TDI quattro | 140 10/16→ | | | |
| 2.0 TFSI | 140 - 09/16→ | | | |
| | 185 | | | |
| 2.0 TFSI Mild Hybrid | 185 05/17→02/20 | | | |
| 2.0 TFSI Mild Hybrid quattro | 185 05/17→02/20 | | | |
| 2.0 TFSI quattro | 183 - 06/16→ | | | |
| | 185 | | | |
| 3.0 TDI | 160 11/16→08/18 | | | |
| → | | | | |



| | kW | | | |
|---|--------------------------|---|------------------------------|------------------|
| AUDI - A5 (F53, F5P) 06/16→ | | | | |
|  Brake Hose | | | | |
| 3.0 TDI quattro | 160 - 07/16→02/20 210 | for PR number: 1LA / 1LB; Fitting Position: Front Axle Right | 24.5141-0638.3 331629 | Length [mm]: 637 |
| 30 TDI Mild Hybrid | 100 10/19→ | | | |
| 35 TDI | 110 - 05/17→ 120 | | | |
| 35 TFSI | 110 03/20→ | | | |
| 35 TFSI Mild Hybrid | 110 02/19→02/20 | | | |
| 40 TDI | 140 06/16→02/20 | | | |
| 40 TDI Mild Hybrid | 150 09/20→ | | | |
| 40 TDI Mild Hybrid quattro | 150 09/20→ | | | |
| 40 TDI quattro | 140 10/16→02/20 | | | |
| 40 TFSI Mild Hybrid | 140 - 05/17→ 150 | | | |
| 40 TFSI Mild Hybrid quattro | 150 07/20→ | | | |
| 45 TDI quattro | 170 07/18→02/20 | | | |
| 45 TFSI Mild Hybrid | 180 07/18→02/20 | | | |
| 45 TFSI Mild Hybrid quattro | 180 - 07/18→ 195 | | | |
| 50 TDI Mild Hybrid quattro | 210 08/20→ | | | |
| 50 TDI quattro | 210 01/17→02/20 | | | |
| RS5 quattro | 331 04/17→ | | | |
| S5 quattro | 260 07/16→ | | | |
| S5 TDI Mild Hybrid quattro | 251 - 12/18→ 255 | | | |
| AUDI - A5 Convertible (F57, F5E) 11/16→ | | | | |
|  Brake Hose | | | | |
| 2.0 TDI | 110 - 11/16→12/19 140 | for PR number: 1LA / 1LB; Fitting Position: Front Axle Right | 24.5141-0638.3 331629 | Length [mm]: 637 |
| 2.0 TDI quattro | 140 03/17→ | | | |
| 2.0 TFSI | 140 - 03/17→12/19 185 | | | |
| 2.0 TFSI Mild Hybrid | 185 05/17→12/19 | | | |
| 2.0 TFSI Mild Hybrid quattro | 185 05/17→12/19 | | | |
| 2.0 TFSI quattro | 185 11/16→12/19 | | | |
| 3.0 TDI | 160 03/17→08/18 | | | |
| 3.0 TDI quattro | 160 - 11/16→12/19 210 | | | |
| 30 TDI MILD HYBRID | 100 07/18→12/19 | | | |
| 35 TDI | 120 10/19→ | | | |
| 35 TFSI Mild Hybrid | 110 06/20→ | | | |
| 40 TDI | 140 11/16→12/19 | | | |
| 40 TDI Mild Hybrid | 150 09/20→ | | | |
| 40 TDI Mild Hybrid quattro | 150 09/20→ | | | |
| 40 TDI quattro | 140 03/17→12/19 | | | |
| 40 TFSI Mild Hybrid | 140 - 05/17→ 150 | | | |
| 40 TFSI Mild Hybrid quattro | 150 06/20→ | | | |
| 45 TFSI Mild Hybrid | 180 07/18→12/19 | | | |
| 45 TFSI Mild Hybrid quattro | 180 - 07/18→ 195 | | | |
| 50 TDI quattro | 210 11/16→12/19 | | | |
| S5 quattro | 260 03/17→ | | | |
| AUDI - A5 Sportback (F5A, F5F) 06/16→ | | | | |
|  Brake Hose | | | | |
| 1.4 TFSI | 110 01/17→02/20 | for PR number: 1LA / 1LB; Fitting Position: Front Axle Right | 24.5141-0638.3 331629 | Length [mm]: 637 |
| 2.0 TDI | 100 - 09/16→ 140 | | | |
| 2.0 TDI quattro | 110 - 10/16→ 140 | | | |
| 2.0 TFSI | 140 - 11/16→ 185 | | | |
| 2.0 TFSI g-tron | 125 02/17→02/20 | | | |
| 2.0 TFSI Mild Hybrid | 185 05/17→02/20 | | | |
| 2.0 TFSI Mild Hybrid quattro | 185 05/17→02/20 | | | |
| 2.0 TFSI quattro | 183 - 09/16→ 185 | | | |
| 3.0 TDI | 160 03/17→08/18 | | | |
| 3.0 TDI quattro | 160 - 09/16→ 210 | | | |
| 30 TDI Mild Hybrid | 100 10/19→ | | | |
| 35 TDI | 110 - 01/17→ 120 | | | |
| → | | | | |



| | kW | | | |
|--|-------|-------------|---|---|
| AUDI - A5 Sportback (F5A, F5F) 06/16→ | | | | |
|  Brake Hose | | | | |
| 35 TFSI Mild Hybrid | 110 | 08/18→02/20 | for PR number: 1LA / 1LB; Fitting Position: Front Axle Right | 24.5141-0638.3 331629 Length [mm]: 637 |
| 40 TDI | 140 | 09/16→02/20 | | |
| 40 TDI Mild Hybrid | 150 | 09/20→ | | |
| 40 TDI Mild Hybrid quattro | 150 | 09/20→ | | |
| 40 TDI quattro | 140 | 08/16→02/20 | | |
| 40 TFSI g-tron | 125 | 02/17→ | | |
| 40 TFSI Mild Hybrid | 140 - | 05/17→ | | |
| | 150 | | | |
| 40 TFSI Mild Hybrid quattro | 150 | 06/20→ | | |
| 45 TDI quattro | 170 | 07/18→02/20 | | |
| 45 TFSI Mild Hybrid | 180 | 07/18→02/20 | | |
| 45 TFSI Mild Hybrid quattro | 180 - | 02/19→ | | |
| | 195 | | | |
| 50 TDI Mild Hybrid quattro | 210 | 08/20→ | | |
| 50 TDI quattro | 210 | 01/17→02/20 | | |
| RS5 quattro | 331 | 06/18→ | | |
| S5 quattro | 260 | 09/16→ | | |
| S5 TDI Mild Hybrid quattro | 251 - | 12/18→ | | |
| | 255 | | | |
| AUDI - Q2 (GAB, GAG) 06/16→ | | | | |
|  Brake Pad Set, disc brake | | | | |
| 1.0 TFSI | 85 | 10/16→10/20 | for PR number: 1ZA / 1ZB / 1ZD / 1ZE / 1ZJ / 1ZK / 1ZU; Fitting Position: Front Axle | 13.0470-2785.2 LD2785 Brake System: Lucas / TRW 25683 20,4 Wear Warning Contact: prepared for wear indicator / incl. wear warning contact Ceramic |
| 1.4 TFSI | 110 | 06/16→08/18 | | |
| 1.6 TDI | 85 | 06/16→10/18 | | |
| 2.0 TDI | 110 | 09/16→ | | |
| 2.0 TDI quattro | 110 - | 07/16→ | | |
| | 140 | | | |
| 2.0 TFSI quattro | 140 | 05/17→ | | |
| 30 TDI | 85 | 07/18→ | | |
| 30 TFSI | 81 - | 07/18→ | | |
| | 85 | | | |
| 35 TDI | 110 | 09/16→ | | |
| 35 TDI quattro | 110 | 09/18→ | | |
| 35 TFSI | 110 | 07/18→ | | |
| 40 TFSI quattro | 140 | 09/18→ | | |
| SQ2 TFSI quattro | 221 | 08/18→ | | |
| AUDI - Q3 (8UB, 8UG) 06/11→12/18 | | | | |
|  Wheel Speed Sensor | | | | |
| 1.4 TFSI | 92 | 07/16→10/18 | Fitting Position: Front Axle Left | 24.0711-5271.3 360301 |
| 1.4 TFSI Flex | 110 | 02/16→10/18 | Fitting Position: Front Axle Right | 24.0711-5272.3 360302 |
| 1.4 TSI | 110 | 10/13→10/18 | | |
| 2.0 TDI | 88 - | 06/11→10/18 | | |
| | 135 | | | |
| 2.0 TDI quattro | 103 - | 06/11→10/18 | | |
| | 130 | | | |
| 2.0 TFSI | 132 | 05/15→10/18 | | |
| 2.0 TFSI quattro | 125 - | 06/11→10/18 | | |
| | 155 | | | |
| 2.0 TDI quattro | 110 - | 11/14→10/18 | Fitting Position: Front Axle Left | 24.0711-5271.3 360301 |
| | 135 | | Fitting Position: Front Axle Right | 24.0711-5272.3 360302 |
| 2.0 TFSI quattro | 132 - | 11/14→10/18 | for PR number: 7X0 / 7X1 / 7X4 / 7X8; Fitting Position: Rear Axle Left | 24.0711-5271.3 360301 |
| | 162 | | for PR number: 7X0 / 7X1 / 7X4 / 7X8; Fitting Position: Rear Axle Right | 24.0711-5272.3 360302 |
| RS 2.5 quattro | 228 | 10/13→10/18 | Fitting Position: Front Axle Left | 24.0711-5271.3 360301 |
| RS performance 2.5 quattro | 270 | 01/15→10/18 | Fitting Position: Front Axle Right | 24.0711-5272.3 360302 |
| | | | Fitting Position: Rear Axle Left | 24.0711-5271.3 360301 |
| | | | Fitting Position: Rear Axle Right | 24.0711-5272.3 360302 |
| RS 2.5 quattro | 250 | 05/13→10/18 | Construction year from: 03/15 →; Fitting Position: Front Axle Left | 24.0711-5271.3 360301 |
| | | | Construction year from: 03/15 →; Fitting Position: Front Axle Right | 24.0711-5272.3 360302 |
| | | | Construction year from: 03/15 →; Fitting Position: Rear Axle Left | 24.0711-5271.3 360301 |
| | | | Construction year from: 03/15 →; Fitting Position: Rear Axle Right | 24.0711-5272.3 360302 |





| | kW | | | |
|--|-------------------|--|------------------------------|---|
| AUDI - Q3 (F3B) 07/18→ | | | | |
|  Brake Pad Set, disc brake | | | | |
| 35 TDI | 110 09/18→ | for PR number: 1ZA / 1ZD / 1ZK / 1ZL; Fitting Position: Front Axle | 13.0470-2785.2 LD2785 | Brake System: Lucas / TRW 25683 20,4 Wear Warning Contact: prepared for wear indicator / incl. wear warning contact Ceramic |
| 35 TDI quattro | 110 09/18→ | | | |
| 35 TFSI | 110 08/18→ | | | |
| 35 TFSI Mild Hybrid | 110 11/19→ | | | |
| 40 TDI quattro | 140 - 10/18→ | | | |
| | 147 | | | |
| 40 TFSI quattro | 140 07/18→ | | | |
| 45 TFSI | 180 01/21→ | | | |
| 45 TFSI e | 110 11/20→ | | | |
| 45 TFSI quattro | 169 07/18→ | | | |
| AUDI - Q3 Sportback (F3N) 06/19→ | | | | |
|  Brake Pad Set, disc brake | | | | |
| 35 TDI | 110 11/19→ | for PR number: 1ZA / 1ZD / 1ZK / 1ZL; Fitting Position: Front Axle | 13.0470-2785.2 LD2785 | Brake System: Lucas / TRW 25683 20,4 Wear Warning Contact: prepared for wear indicator / incl. wear warning contact Ceramic |
| 35 TDI quattro | 110 09/19→ | | | |
| 35 TFSI | 110 09/19→ | | | |
| 35 TFSI Mild Hybrid | 110 11/19→ | | | |
| 40 TDI quattro | 140 - 07/19→ | | | |
| | 147 | | | |
| 40 TFSI quattro | 140 11/19→ | | | |
| 45 TFSI | 180 01/21→ | | | |
| 45 TFSI e | 110 11/20→ | | | |
| 45 TFSI quattro | 169 06/19→ | | | |
| AUDI - TT (8J3) 07/06→01/15 | | | | |
|  Wheel Speed Sensor | | | | |
| 1.8 TFSI | 118 06/08→06/14 | Fitting Position: Front Axle Left | 24.0711-5271.3 360301 | |
| 2.0 TFSI | 147 - 08/06→06/14 | Fitting Position: Front Axle Right | 24.0711-5272.3 360302 | |
| | 155 | | | |
| 2.0 TDI quattro | 125 06/08→06/14 | Fitting Position: Front Axle Left | 24.0711-5271.3 360301 | |
| 2.0 TFSI quattro | 147 - 06/08→06/14 | Fitting Position: Front Axle Right | 24.0711-5272.3 360302 | |
| | 155 | | | |
| 2.0 TTS quattro | 195 - 05/08→06/14 | Fitting Position: Rear Axle Left | 24.0711-5271.3 360301 | |
| | 200 | Fitting Position: Rear Axle Right | 24.0711-5272.3 360302 | |
| 2.5 RS quattro | 250 - 07/09→06/14 | | | |
| | 265 | | | |
| 3.2 V6 quattro | 184 08/06→06/10 | | | |
| AUDI - TT (FV3, FVP) 07/14→ | | | | |
|  Brake Pad Set, disc brake | | | | |
| 1.8 TFSI | 132 07/15→08/18 | for PR number: 1LJ / 1LP / 1ZD / 1ZF / 1ZL / 1ZT / 1ZV / 1ZW; Fitting Position: Front Axle | 13.0470-2785.2 LD2785 | Brake System: Lucas / TRW 25683 20,4 Wear Warning Contact: prepared for wear indicator / incl. wear warning contact Ceramic |
| 2.0 TDI | 135 07/14→ | | | |
| 2.0 TDI quattro | 135 01/17→ | | | |
| 2.0 TFSI | 169 07/14→ | | | |
| 2.0 TFSI quattro | 162 - 07/14→ | | | |
| | 169 | | | |
| 2.0 TTS quattro | 210 - 02/15→ | | | |
| | 225 | | | |
| 40 TFSI | 145 07/18→ | | | |
| 45 TFSI | 180 07/18→ | | | |
| 45 TFSI quattro | 180 07/18→ | | | |
| AUDI - TT Roadster (8J9) 03/07→06/14 | | | | |
|  Wheel Speed Sensor | | | | |
| 1.8 TFSI | 118 06/08→06/14 | Fitting Position: Front Axle Left | 24.0711-5271.3 360301 | |
| 2.0 TFSI | 147 - 03/07→06/14 | Fitting Position: Front Axle Right | 24.0711-5272.3 360302 | |
| | 155 | | | |
| 2.0 TDI quattro | 125 06/08→06/14 | Fitting Position: Front Axle Left | 24.0711-5271.3 360301 | |
| 2.0 TFSI quattro | 147 - 06/08→06/14 | Fitting Position: Front Axle Right | 24.0711-5272.3 360302 | |
| | 155 | | | |
| 2.0 TTS quattro | 195 - 05/08→06/14 | Fitting Position: Rear Axle Left | 24.0711-5271.3 360301 | |
| | 200 | Fitting Position: Rear Axle Right | 24.0711-5272.3 360302 | |
| 2.5 RS quattro | 250 - 07/09→06/14 | | | |
| | 265 | | | |
| 3.2 V6 quattro | 184 03/07→06/10 | | | |
| AUDI - TT Roadster (FV9, FVR) 11/14→ | | | | |
|  Brake Pad Set, disc brake | | | | |
| 1.8 TFSI | 132 07/15→08/18 | for PR number: 1LJ / 1LP / 1ZD / 1ZF / 1ZL / 1ZT / 1ZV / 1ZW; Fitting Position: Front Axle | 13.0470-2785.2 LD2785 | Brake System: Lucas / TRW 25683 20,4 Wear Warning Contact: prepared for wear indicator / incl. wear warning contact Ceramic |
| 2.0 TDI | 135 11/14→ | | | |
| 2.0 TDI quattro | 135 01/17→ | | | |
| 2.0 TFSI | 169 11/14→ | | | |
| 2.0 TFSI quattro | 162 - 11/14→ | | | |
| | 169 | | | |
| 2.0 TTS quattro | 210 - 02/15→ | | | |
| | 225 | | | |
| 40 TFSI | 145 07/18→ | | | |
| → | | | | |







| | kW | | | | |
|--|-------|-------------|---|-----------------------|--|
| AUDI - TT Roadster (FV9, FVR) 11/14→ | | | | | |
|  Brake Pad Set, disc brake | | | | | |
| 45 TFSI | 180 | 07/18→ | for PR number: 1LJ / 1LP / 1ZD / 1ZF / 1ZL / 1ZT / 1ZV / 1ZW; | 13.0470-2785.2 | LD2785 Brake System: Lucas / TRW 25683 20,4 |
| 45 TFSI quattro | 180 | 07/18→ | Fitting Position: Front Axle | | Wear Warning Contact: prepared for wear indicator / incl. wear warning contact Ceramic |
| BMW - X5 (E70) 02/06→07/13 | | | | | |
|  Brake Hose | | | | | |
| 3.0 3.0d | 155 | 02/07→09/08 | Construction year from: 05/07 →; | 24.5201-0210.3 | 331634 Length [mm]: 205 |
| 3.0 d | 173 | 12/06→09/08 | Fitting Position: Rear Axle Left | | |
| 4.8 i xDrive | 261 | 10/06→09/08 | | | |
| 3.0 sd | 210 | 10/07→09/08 | Fitting Position: Rear Axle Left | 24.5201-0210.3 | 331634 Length [mm]: 205 |
| 3.0 si | 200 | 10/06→09/08 | | | |
| M | 408 | 07/09→07/13 | | | |
| xDrive 30 d | 155 - | 10/08→07/13 | | | |
| | 173 | | | | |
| xDrive 30 i | 172 - | 02/07→12/12 | | | |
| | 200 | | | | |
| xDrive 35 d | 210 | 10/08→07/13 | | | |
| xDrive 35 i | 225 - | 04/10→07/13 | | | |
| | 235 | | | | |
| xDrive 40 d | 225 | 09/10→06/13 | | | |
| xDrive 40 i | 225 | 01/12→06/13 | | | |
| xDrive 48 i | 261 | 10/08→03/10 | | | |
| xDrive 50 i | 300 | 04/10→07/13 | | | |
| M 50 d | 280 | 08/11→06/13 | Construction year from: 06/12 →; | 24.5201-0210.3 | 331634 Length [mm]: 205 |
| | | | Fitting Position: Rear Axle Left | | |
| xDrive 30 d | 180 | 04/10→07/13 | Construction year from: 09/10 →; | 24.5201-0210.3 | 331634 Length [mm]: 205 |
| | | | Fitting Position: Rear Axle Left | | |
| BMW - X5 (F15, F85) 08/13→07/18 | | | | | |
|  Brake Hose | | | | | |
| xDrive 28 i | 180 | 06/15→07/18 | Fitting Position: Rear Axle Left | 24.5201-0210.3 | 331634 Length [mm]: 205 |
| xDrive 40e | 155 - | 08/15→07/18 | | | |
| | 230 | | | | |
| BMW - X6 (E71, E72) 06/07→07/14 | | | | | |
|  Brake Hose | | | | | |
| ActiveHybrid | 357 | 01/09→10/11 | Construction year from: 10/10 →; | 24.5201-0210.3 | 331634 Length [mm]: 205 |
| ActiveHybrid xDrive | 300 | 01/09→10/11 | Fitting Position: Rear Axle Left | | |
| xDrive 40 d | 225 | 07/09→06/14 | | | |
| M | 408 | 07/09→07/14 | Construction year from: 09/09 →; | 24.5201-0210.3 | 331634 Length [mm]: 205 |
| | | | Fitting Position: Rear Axle Left | | |
| M 50 d | 280 | 08/11→06/14 | Construction year from: 06/12 →; | 24.5201-0210.3 | 331634 Length [mm]: 205 |
| | | | Fitting Position: Rear Axle Left | | |
| xDrive 30 d | 155 | 04/10→07/14 | Fitting Position: Rear Axle Left | 24.5201-0210.3 | 331634 Length [mm]: 205 |
| xDrive 35 i | 235 | 07/09→06/14 | | | |
| xDrive 30 d | 173 | 04/08→03/10 | Construction year from: 09/08 →; | 24.5201-0210.3 | 331634 Length [mm]: 205 |
| xDrive 35 d | 210 | 01/08→03/10 | Fitting Position: Rear Axle Left | | |
| xDrive 35 i | 224 - | 06/07→07/14 | | | |
| | 240 | | | | |
| xDrive 50 i | 300 - | 10/07→07/14 | | | |
| | 330 | | | | |
| xDrive 30 d | 180 | 04/10→07/14 | Construction year from: 09/10 →; | 24.5201-0210.3 | 331634 Length [mm]: 205 |
| | | | Fitting Position: Rear Axle Left | | |
| CHEVROLET - CRUZE (J300) 05/09→ | | | | | |
|  Brake Hose | | | | | |
| 1.4 | 74 | 07/13→ | Fitting Position: Front Axle Right | 24.5176-0401.3 | 331649 Length [mm]: 410 |
| 1.6 | 86 | 12/12→ | Fitting Position: Front Axle Left | 24.5176-0402.3 | 331633 Length [mm]: 410 |
| 1.7 TD | 81 | 11/13→ | | | |
| 2.0 CDI | 110 | 09/13→ | | | |
| 1.4 | 103 | 09/10→ | Construction year from: 08/12 →; | 24.5176-0401.3 | 331649 Length [mm]: 410 |
| 1.6 | 80 - | 05/09→ | Fitting Position: Front Axle Right | | |
| | 91 | | | | |
| 1.7 D | 96 | 01/12→ | Construction year from: 08/12 →; | 24.5176-0402.3 | 331633 Length [mm]: 410 |
| 1.8 | 103 - | 05/09→ | Fitting Position: Front Axle Left | | |
| | 104 | | | | |
| 1.8 LPG | 104 | 06/11→ | | | |
| 2.0 CDI | 110 - | 05/09→ | | | |
| | 120 | | | | |
| 2.0 VCDi | 122 | 03/12→11/18 | | | |





| | kW | | | | |
|---|-----------|-------------|--|------------------------------|---|
| CHEVROLET - CRUZE Hatchback (J305) 12/10→ | | | | | |
|  Brake Hose | | | | | |
| 1.4 | 74 | 07/13→12/15 | Fitting Position: Front Axle Right | 24.5176-0401.3 331649 | Length [mm]: 410 |
| 1.6 | 83 - 86 | 12/12→ | Fitting Position: Front Axle Left | 24.5176-0402.3 331633 | Length [mm]: 410 |
| 1.7 TD | 81 | 08/13→12/15 | | | |
| 1.4 | 103 | 06/12→ | Construction year from: 08/12 →; | 24.5176-0401.3 331649 | Length [mm]: 410 |
| 1.6 | 80 - 91 | 06/11→ | Fitting Position: Front Axle Right | | |
| 1.7 D | 96 | 01/12→12/15 | Construction year from: 08/12 →; | 24.5176-0402.3 331633 | Length [mm]: 410 |
| 1.8 | 103 - 104 | 06/11→ | Fitting Position: Front Axle Left | | |
| 1.8 LPG | 104 | 06/11→12/15 | | | |
| 2.0 CDI | 120 | 06/11→ | | | |
| CHEVROLET - CRUZE Station Wagon (J308) 08/12→ | | | | | |
|  Brake Hose | | | | | |
| 1.4 | 74 - 103 | 08/12→ | Fitting Position: Front Axle Right | 24.5176-0401.3 331649 | Length [mm]: 410 |
| 1.6 | 86 - 91 | 08/12→12/15 | Fitting Position: Front Axle Left | 24.5176-0402.3 331633 | Length [mm]: 410 |
| 1.7 TD | 81 - 96 | 08/12→ | | | |
| 1.8 | 104 | 08/12→ | | | |
| 2.0 TD | 120 | 08/12→ | | | |
| CHEVROLET - ORLANDO (J309) 12/10→ | | | | | |
|  Brake Hose | | | | | |
| 1.4 | 103 | 06/12→ | Fitting Position: Front Axle Right | 24.5176-0401.3 331649 | Length [mm]: 410 |
| | | | Fitting Position: Front Axle Left | 24.5176-0402.3 331633 | Length [mm]: 410 |
| CITROËN - AMI (9A_) 04/20→ | | | | | |
|  Brake Disc | | | | | |
| Electric | 6 | 04/20→ | Fitting Position: Front Axle | 24.0122-0194.1 422194 | Outer diameter [mm]: 266 Brake Disc Thickness [mm] 22 Minimum thickness [mm] 20 Brake Disc Type: Vented Supplementary Article/Info 2: with bolts/screws |
| CITROËN - BERLINGO / BERLINGO FIRST Box Body/MPV (M_) 07/96→12/11 | | | | | |
|  Brake Disc | | | | | |
| 1.1 i | 44 | 07/96→03/08 | for RPO number (vehicle manufacturing date) from: 09128 →; | 24.0122-0194.1 422194 | Outer diameter [mm]: 266 Brake Disc Thickness [mm] 22 Minimum thickness [mm] 20 Brake Disc Type: Vented Supplementary Article/Info 2: with bolts/screws |
| 1.4 BiFuel | 55 | 07/96→10/02 | Fitting Position: Front Axle | | |
| | | | for RPO number (vehicle manufacturing date) from: 09429 →; | 24.0122-0194.1 422194 | Outer diameter [mm]: 266 Brake Disc Thickness [mm] 22 Minimum thickness [mm] 20 Brake Disc Type: Vented Supplementary Article/Info 2: with bolts/screws |
| | | | Fitting Position: Front Axle | | |
| 1.4 bivalent | 48 | 11/02→12/11 | → Construction year to: 03/08; | 24.0122-0194.1 422194 | Outer diameter [mm]: 266 Brake Disc Thickness [mm] 22 Minimum thickness [mm] 20 Brake Disc Type: Vented Supplementary Article/Info 2: with bolts/screws |
| 1.6 HDI 75 | 55 | 07/05→12/11 | Fitting Position: Front Axle | | |
| 1.6 HDI 90 | 66 | 07/05→12/11 | | | |
| 1.4 i | 55 | 07/96→12/11 | for RPO number (vehicle manufacturing date) from: 09128 →; | 24.0122-0194.1 422194 | Outer diameter [mm]: 266 Brake Disc Thickness [mm] 22 Minimum thickness [mm] 20 Brake Disc Type: Vented Supplementary Article/Info 2: with bolts/screws |
| | | | → Construction year to: 03/08; | | |
| | | | Fitting Position: Front Axle | | |
| | | | for RPO number (vehicle manufacturing date) from: 09429 →; | 24.0122-0194.1 422194 | Outer diameter [mm]: 266 Brake Disc Thickness [mm] 22 Minimum thickness [mm] 20 Brake Disc Type: Vented Supplementary Article/Info 2: with bolts/screws |
| | | | → Construction year to: 03/08; | | |
| | | | Fitting Position: Front Axle | | |
| → | | | | | |







| | | kW | | | | | | | |
|---|--|---|--|-------------------------|--|---|--|--|--|
| CITROËN - BERLINGO / BERLINGO FIRST Box Body/MPV (M_) 07/96→12/11 | | | | | | | | | |
|  Brake Disc | | | | | | | | | |
| 1.4 i bivalent 1.6 HDI 92 | 55 04/03→10/05 68 11/09→12/10 | Fitting Position: Front Axle | | 24.0122-0194.1 422194 | | Outer diameter [mm]: 266 Brake Disc Thickness [mm] 22 Minimum thickness [mm] 20 Brake Disc Type: Vented Supplementary Article/Info 2: with bolts/screws | | | |
| 1.6 16V 1.8 D 1.8 i 1.9 D 1.9 D 70 4WD 2.0 HDI 90 4WD | 80 - 10/00→03/08 81 43 07/96→10/02 66 05/98→10/02 51 07/96→12/03 51 07/98→03/06 66 11/00→10/05 | for RPO number (vehicle manufacturing date) from: 09128 →; Fitting Position: Front Axle | | 24.0122-0194.1 422194 | | Outer diameter [mm]: 266 Brake Disc Thickness [mm] 22 Minimum thickness [mm] 20 Brake Disc Type: Vented Supplementary Article/Info 2: with bolts/screws | | | |
| 1.9 D 70 2.0 HDI 90 | 51 04/99→12/11 66 12/99→12/11 | for RPO number (vehicle manufacturing date) from: 09128 →; → Construction year to: 03/08; Fitting Position: Front Axle | | 24.0122-0194.1 422194 | | Outer diameter [mm]: 266 Brake Disc Thickness [mm] 22 Minimum thickness [mm] 20 Brake Disc Type: Vented Supplementary Article/Info 2: with bolts/screws | | | |
| CITROËN - BERLINGO / BERLINGO FIRST MPV (MF_, GJK_, GFK_) 07/96→12/11 | | | | | | | | | |
|  Brake Disc | | | | | | | | | |
| 1.1 i 1.4 i | 44 07/96→05/08 55 07/96→12/11 | for RPO number (vehicle manufacturing date) from: 09128 →; → Construction year to: 03/08; Fitting Position: Front Axle | | 24.0122-0194.1 422194 | | Outer diameter [mm]: 266 Brake Disc Thickness [mm] 22 Minimum thickness [mm] 20 Brake Disc Type: Vented Supplementary Article/Info 2: with bolts/screws | | | |
| | | for RPO number (vehicle manufacturing date) from: 09429 →; → Construction year to: 03/08; Fitting Position: Front Axle | | 24.0122-0194.1 422194 | | Outer diameter [mm]: 266 Brake Disc Thickness [mm] 22 Minimum thickness [mm] 20 Brake Disc Type: Vented Supplementary Article/Info 2: with bolts/screws | | | |
| 1.4 1.6 HDI 92 | 53 11/02→10/05 68 11/09→12/10 | Fitting Position: Front Axle | | 24.0122-0194.1 422194 | | Outer diameter [mm]: 266 Brake Disc Thickness [mm] 22 Minimum thickness [mm] 20 Brake Disc Type: Vented Supplementary Article/Info 2: with bolts/screws | | | |
| 1.4 bivalent 1.4 i bivalent 1.6 HDI 75 | 48 11/02→12/11 55 04/03→10/08 55 07/05→12/11 | → Construction year to: 03/08; Fitting Position: Front Axle | | 24.0122-0194.1 422194 | | Outer diameter [mm]: 266 Brake Disc Thickness [mm] 22 Minimum thickness [mm] 20 Brake Disc Type: Vented Supplementary Article/Info 2: with bolts/screws | | | |
| 1.6 16V | 80 - 10/00→12/11 81 | for RPO number (vehicle manufacturing date) from: 09128 →; → Construction year to: 03/08; - ESP; Fitting Position: Front Axle | | 24.0122-0194.1 422194 | | Outer diameter [mm]: 266 Brake Disc Thickness [mm] 22 Minimum thickness [mm] 20 Brake Disc Type: Vented Supplementary Article/Info 2: with bolts/screws | | | |
| 1.6 HDI 90 | 66 07/05→05/08 | → Construction year to: 03/08; - ESP; Fitting Position: Front Axle | | 24.0122-0194.1 422194 | | Outer diameter [mm]: 266 Brake Disc Thickness [mm] 22 Minimum thickness [mm] 20 Brake Disc Type: Vented Supplementary Article/Info 2: with bolts/screws | | | |
| 1.8 D 1.8 i 1.8 i 4WD 1.9 D 1.9 D 4WD | 43 07/98→10/02 66 05/97→10/02 66 04/97→10/01 50 - 07/96→10/05 51 51 07/98→10/05 | for RPO number (vehicle manufacturing date) from: 09128 →; Fitting Position: Front Axle | | 24.0122-0194.1 422194 | | Outer diameter [mm]: 266 Brake Disc Thickness [mm] 22 Minimum thickness [mm] 20 Brake Disc Type: Vented Supplementary Article/Info 2: with bolts/screws | | | |
| 2.0 HDi 4x4 2.0 HDI 90 | 66 11/02→10/05 66 12/99→10/05 | for RPO number (vehicle manufacturing date) from: 09128 →; - ESP; Fitting Position: Front Axle | | 24.0122-0194.1 422194 | | Outer diameter [mm]: 266 Brake Disc Thickness [mm] 22 Minimum thickness [mm] 20 Brake Disc Type: Vented Supplementary Article/Info 2: with bolts/screws | | | |
| CITROËN - BERLINGO (ER_, EC_) 06/18→ | | | | | | | | | |
| Spring, brake caliper | | | | | | | | | |
| 1.2 PureTech 110 1.2 PureTech 130 1.5 BlueHDI 100 1.5 BlueHDI 130 1.5 BlueHDI 75 → | 81 06/18→ 96 07/19→ 75 06/18→ 96 06/18→ 56 06/18→ | Required quantity: 2; for brake disc diameter [mm]: 283; Fitting Position: Front Axle | | 2 11.8116-0237.1 390509 | | Brake System: ATE | | | |



| | | | | | |
|--|------------|---|---|------------------------------|--|
| | kW | | | | |
| CITROËN - BERLINGO (ER_, EC_) 06/18→ | | | | | |
| Spring, brake caliper | | | | | |
| e-Berlingo | 100 07/21→ | Required quantity: 2; for brake disc diameter [mm]: 283; Fitting Position: Front Axle | 2 | 11.8116-0237.1 390509 | Brake System: ATE |
|  Brake Pad Set, disc brake | | | | | |
| 1.2 PureTech 110 | 81 06/18→ | for brake disc diameter [mm]: 283; Fitting Position: Front Axle | | 13.0460-3870.2 603870 | Brake System: Bosch 25895 18,5 Wear Warning Contact: not prepared for wear indicator / excl. wear warning contact Supplementary Article/Supplementary Info: with accessories |
| 1.2 PureTech 130 | 96 07/19→ | | | | |
| 1.5 BlueHDi 100 | 75 06/18→ | | | | |
| 1.5 BlueHDi 130 | 96 06/18→ | | | | |
| 1.5 BlueHDi 75 | 56 06/18→ | | | | |
| e-Berlingo | 100 07/21→ | | | 13.0470-3870.2 LD3870 | Brake System: Bosch 25895 18,5 Wear Warning Contact: not prepared for wear indicator / excl. wear warning contact Supplementary Article/Supplementary Info: with accessories Ceramic |
| | | Vehicle Equipment: for vehicles with electric parking brake; Fitting Position: Rear Axle | | 13.0460-3871.2 603871 | Brake System: Bosch 25839 17,8 Wear Warning Contact: not prepared for wear indicator / excl. wear warning contact Supplementary Article/Supplementary Info: with accessories |
| | | | | 13.0470-3871.2 LD3871 | Brake System: Bosch 25839 17,8 Wear Warning Contact: not prepared for wear indicator / excl. wear warning contact Supplementary Article/Supplementary Info: with accessories Ceramic |
|  Brake Disc | | | | | |
| 1.2 PureTech 110 | 81 06/18→ | Brake System: Bosch; Fitting Position: Front Axle | | 24.0126-0183.1 426183 | Outer diameter [mm]: 283 Brake Disc Thickness [mm] 26 Minimum thickness [mm] 24 Brake Disc Type: Vented Supplementary Article/Info 2: with bolts/screws |
| 1.2 PureTech 130 | 96 07/19→ | | | | |
| 1.5 BlueHDi 100 | 75 06/18→ | | | | |
| 1.5 BlueHDi 130 | 96 06/18→ | | | | |
| 1.5 BlueHDi 75 | 56 06/18→ | | | | |
| e-Berlingo | 100 07/21→ | | | | |
| | | Fitting Position: Front Axle | | 24.0128-0269.1 428269 | Outer diameter [mm]: 304 Brake Disc Thickness [mm] 28 Minimum thickness [mm] 26 Brake Disc Type: Vented Supplementary Article/Info 2: with bolts/screws |
| | | Fitting Position: Rear Axle | | 24.0112-0211.1 412211 | Outer diameter [mm]: 268 Brake Disc Thickness [mm] 12 Minimum thickness [mm] 10 Brake Disc Type: Solid Supplementary Article/Info 2: with bolts/screws |
| CITROËN - BERLINGO Box Body/MPV (K9) 06/18→ | | | | | |
| Spring, brake caliper | | | | | |
| 1.5 BlueHDi 100 | 75 06/18→ | Required quantity: 2; for brake disc diameter [mm]: 283; Fitting Position: Front Axle | 2 | 11.8116-0237.1 390509 | Brake System: ATE |
| 1.5 BlueHDi 130 | 96 06/18→ | | | | |
| 1.5 BlueHDi 130 4x4 | 96 06/18→ | | | | |
| 1.5 BlueHDi 75 | 55 10/19→ | | | | |
| 1.6 BlueHDi 100 | 73 06/18→ | | | | |
| 1.6 BlueHDi 75 | 55 06/18→ | | | | |
| e-Berlingo | 100 07/21→ | | | | |
| PureTech 110 | 81 06/18→ | | | | |
| PureTech 130 | 96 10/19→ | | | | |
| | | | | | |
|  Brake Pad Set, disc brake | | | | | |
| 1.5 BlueHDi 100 | 75 06/18→ | for brake disc diameter [mm]: 283; Fitting Position: Front Axle | | 13.0460-3870.2 603870 | Brake System: Bosch 25895 18,5 Wear Warning Contact: not prepared for wear indicator / excl. wear warning contact Supplementary Article/Supplementary Info: with accessories |
| 1.5 BlueHDi 130 | 96 06/18→ | | | | |
| 1.5 BlueHDi 130 4x4 | 96 06/18→ | | | | |
| 1.5 BlueHDi 75 | 55 10/19→ | | | | |
| 1.6 BlueHDi 100 | 73 06/18→ | | | | |
| 1.6 BlueHDi 75 | 55 06/18→ | | | | |
| e-Berlingo | 100 07/21→ | | | | |
| PureTech 110 | 81 06/18→ | | | | |
| PureTech 130 | 96 10/19→ | | | | |
| | | | | | |



| | kW | | | | |
|--|--|---|--|--|---|
| CITROËN - BERLINGO Box Body/MPV (K9) 06/18→ | | | | | |
|  Brake Pad Set, disc brake | | | | | |
| 1.5 BlueHDi 100 1.5 BlueHDi 130 1.5 BlueHDi 130 4x4 1.5 BlueHDi 75 1.6 BlueHDi 100 1.6 BlueHDi 75 e-Berlingo PureTech 110 PureTech 130 | 75 06/18→ 96 06/18→ 96 06/18→ 55 10/19→ 73 06/18→ 55 06/18→ 100 07/21→ 81 06/18→ 96 10/19→ | Vehicle Equipment: for vehicles with electric parking brake; Fitting Position: Rear Axle | | 13.0460-3871.2 603871 13.0470-3871.2 LD3871 | Brake System: Bosch 25839 17,8 Wear Warning Contact: not prepared for wear indicator / excl. wear warning contact Supplementary Article/Supplementary Info: with accessories Brake System: Bosch 25839 17,8 Wear Warning Contact: not prepared for wear indicator / excl. wear warning contact Supplementary Article/Supplementary Info: with accessories Ceramic |
|  Brake Disc | | | | | |
| 1.5 BlueHDi 100 1.5 BlueHDi 130 1.5 BlueHDi 130 4x4 1.5 BlueHDi 75 1.6 BlueHDi 100 1.6 BlueHDi 75 e-Berlingo PureTech 110 PureTech 130 | 75 06/18→ 96 06/18→ 96 06/18→ 55 10/19→ 73 06/18→ 55 06/18→ 100 07/21→ 81 06/18→ 96 10/19→ | Brake System: Bosch; Fitting Position: Front Axle | | 24.0126-0183.1 426183 | Outer diameter [mm]: 283 Brake Disc Thickness [mm] 26 Minimum thickness [mm] 24 Brake Disc Type: Vented Supplementary Article/Info 2: with bolts/screws |
| | | Fitting Position: Front Axle | | 24.0128-0269.1 428269 | Outer diameter [mm]: 304 Brake Disc Thickness [mm] 28 Minimum thickness [mm] 26 Brake Disc Type: Vented Supplementary Article/Info 2: with bolts/screws |
| | | Fitting Position: Rear Axle | | 24.0112-0211.1 412211 | Outer diameter [mm]: 268 Brake Disc Thickness [mm] 12 Minimum thickness [mm] 10 Brake Disc Type: Solid Supplementary Article/Info 2: with bolts/screws |
| CITROËN - C2 (JM_) 07/03→09/17 | | | | | |
|  Brake Disc | | | | | |
| 1.4 1.4 16V 1.4 HDi 1.6 HDi 1.6 VTS | 54 - 09/03→12/09 55 65 04/05→12/09 50 - 07/03→12/09 51 80 09/05→12/09 90 10/04→12/09 | Fitting Position: Front Axle | | 24.0122-0194.1 422194 | Outer diameter [mm]: 266 Brake Disc Thickness [mm] 22 Minimum thickness [mm] 20 Brake Disc Type: Vented Supplementary Article/Info 2: with bolts/screws |
| 1.6 | 80 07/03→10/10 | → Construction year to: 12/09; Fitting Position: Front Axle | | 24.0122-0194.1 422194 | Outer diameter [mm]: 266 Brake Disc Thickness [mm] 22 Minimum thickness [mm] 20 Brake Disc Type: Vented Supplementary Article/Info 2: with bolts/screws |
| CITROËN - C2 ENTERPRISE (JG_) 11/03→12/09 | | | | | |
|  Brake Disc | | | | | |
| 1.4 HDi | 50 - 11/03→12/09 51 | Fitting Position: Front Axle | | 24.0122-0194.1 422194 | Outer diameter [mm]: 266 Brake Disc Thickness [mm] 22 Minimum thickness [mm] 20 Brake Disc Type: Vented Supplementary Article/Info 2: with bolts/screws |
| CITROËN - C3 I (FC_, FN_) 02/02→ | | | | | |
|  Brake Disc | | | | | |
| 1.4 16V 1.4 16V HDi 1.6 16V HDi | 65 12/03→ 66 02/02→ 66 - 09/05→ 80 | → Construction year to: 08/09; Fitting Position: Front Axle | | 24.0122-0194.1 422194 | Outer diameter [mm]: 266 Brake Disc Thickness [mm] 22 Minimum thickness [mm] 20 Brake Disc Type: Vented Supplementary Article/Info 2: with bolts/screws |
| 1.6 16V | 80 02/02→08/10 | → Construction year to: 08/09; Transmission Type: Manual Transmission; Fitting Position: Front Axle | | 24.0122-0194.1 422194 | Outer diameter [mm]: 266 Brake Disc Thickness [mm] 22 Minimum thickness [mm] 20 Brake Disc Type: Vented Supplementary Article/Info 2: with bolts/screws |
| → | | | | | |



| | kW | | | | |
|---|--|---|--|------------------------------|---|
| CITROËN - C3 I (FC_, FN_) 02/02→ | | | | | |
|  Brake Disc | | | | | |
| 1.6 16V | 81 | 05/03→09/05 | Transmission Type: Manual Transmission; Fitting Position: Front Axle | 24.0122-0194.1 422194 | Outer diameter [mm]: 266 Brake Disc Thickness [mm] 22 Minimum thickness [mm] 20 Brake Disc Type: Vented Supplementary Article/Info 2: with bolts/screws |
| CITROËN - C3 II (SC_) 09/09→ | | | | | |
|  Brake Disc | | | | | |
| 1.0 VTi 68 1.2 VTi 82 | 50 60 | 08/12→ 06/12→09/16 | Construction year from: 10/12 →; Fitting Position: Front Axle | 24.0122-0194.1 422194 | Outer diameter [mm]: 266 Brake Disc Thickness [mm] 22 Minimum thickness [mm] 20 Brake Disc Type: Vented Supplementary Article/Info 2: with bolts/screws |
| 1.1 BiFuel 1.1 i 1.2 THP 110 1.4 1.4 HDi 70 1.4 LPG 1.4 VTi 1.4 VTi 95 1.6 BlueHDi 100 1.6 BlueHDi 75 1.6 HDi 1.6 HDi 90 1.6 VTi 120 | 44 44 81 54 50 54 - 72 70 73 55 68 66 88 | 11/10→ 09/09→01/13 10/14→ 11/09→09/16 11/09→ 07/10→ 11/09→ 11/09→ 07/14→ 04/15→ 11/09→09/16 11/09→ 11/09→ | Fitting Position: Front Axle | 24.0122-0194.1 422194 | Outer diameter [mm]: 266 Brake Disc Thickness [mm] 22 Minimum thickness [mm] 20 Brake Disc Type: Vented Supplementary Article/Info 2: with bolts/screws |
| CITROËN - C3 II Hatchback Van (SC_) 06/10→ | | | | | |
|  Brake Disc | | | | | |
| 1.4 HDi 1.6 BlueHDi | 50 55 | 06/10→09/16 03/15→09/16 | Fitting Position: Front Axle | 24.0122-0194.1 422194 | Outer diameter [mm]: 266 Brake Disc Thickness [mm] 22 Minimum thickness [mm] 20 Brake Disc Type: Vented Supplementary Article/Info 2: with bolts/screws |
| CITROËN - C3 III (SX) 07/16→ | | | | | |
|  Brake Disc | | | | | |
| 1.2 PureTech 82 1.2 PureTech 82 LPG 1.2 THP 110 1.2 VTi 68 1.2 VTi 82 1.2 VTi 82 LPG 1.5 BlueHDi 100 1.6 BlueHDi 100 1.6 BlueHDi 75 1.6 VTi | 61 61 81 50 60 60 75 73 55 85 | 05/18→ 05/18→ 07/16→ 07/16→ 07/16→ 07/16→ 05/18→ 07/16→ 07/16→ 02/17→ | Fitting Position: Front Axle | 24.0122-0194.1 422194 | Outer diameter [mm]: 266 Brake Disc Thickness [mm] 22 Minimum thickness [mm] 20 Brake Disc Type: Vented Supplementary Article/Info 2: with bolts/screws |
| CITROËN - C3 III Van (SX_, SY_) 07/16→ | | | | | |
|  Brake Disc | | | | | |
| BlueHDi 100 BlueHDi 75 PureTech 110 PureTech 82 | 73 - 75 55 81 61 | 03/19→ 03/19→ 03/19→ 03/19→ | Fitting Position: Front Axle | 24.0122-0194.1 422194 | Outer diameter [mm]: 266 Brake Disc Thickness [mm] 22 Minimum thickness [mm] 20 Brake Disc Type: Vented Supplementary Article/Info 2: with bolts/screws |
| CITROËN - C3 AIRCROSS II (2R_, 2C_) 06/17→ | | | | | |
|  Brake Disc | | | | | |
| 1.2 PureTech 110 1.2 PureTech 130 1.2 PureTech 82 1.5 BlueHDi 100 1.5 BlueHDi 110 1.5 BlueHDi 120 1.6 BlueHDi 100 1.6 BlueHDi 115 1.6 BlueHDi 120 1.6 HDi 92 | 81 96 60 73 - 81 88 73 85 88 68 | 06/17→ 07/17→ 06/17→ 08/18→ 10/20→ 08/18→ 07/17→ 06/17→ 07/17→ 10/17→ | Fitting Position: Front Axle | 24.0122-0194.1 422194 | Outer diameter [mm]: 266 Brake Disc Thickness [mm] 22 Minimum thickness [mm] 20 Brake Disc Type: Vented Supplementary Article/Info 2: with bolts/screws |

| | kW | | | | |
|---|--|--|------------------------------|---|--|
| CITROËN - C3 AIRCROSS II Van (2C_, 2R_) 06/17→ | | | | | |
|  Brake Disc | | | | | |
| 1.5 BlueHDI 100 1.5 BlueHDI 120 1.6 BlueHDI 100 PureTech 82 | 73 05/19→ 88 05/19→ 73 05/19→ 60 - 05/19→ 81 | Fitting Position: Front Axle | 24.0122-0194.1 422194 | Outer diameter [mm]: 266 Brake Disc Thickness [mm] 22 Minimum thickness [mm] 20 Brake Disc Type: Vented Supplementary Article/Info 2: with bolts/screws | |
| CITROËN - C3 PICASSO (SH_) 02/09→ | | | | | |
|  Brake Disc | | | | | |
| 1.2 THP 110 1.4 VTi 95 1.4 VTi 95 LPG 1.6 BlueHDI 100 1.6 HDi 1.6 HDi 110 1.6 HDi 115 1.6 HDi 90 1.6 VTi 120 1.6 VTi | 81 01/15→ 70 02/09→ 70 01/12→ 73 01/15→ 66 - 02/09→ 80 82 05/10→ 84 01/13→ 68 07/10→ 88 02/09→ 84 07/09→ | Fitting Position: Front Axle Construction year from: 10/16 →; Fitting Position: Front Axle | 24.0122-0194.1 422194 | Outer diameter [mm]: 266 Brake Disc Thickness [mm] 22 Minimum thickness [mm] 20 Brake Disc Type: Vented Supplementary Article/Info 2: with bolts/screws | |
| CITROËN - C3 Pluriel (HB_) 05/03→ | | | | | |
|  Brake Disc | | | | | |
| 1.4 1.4 HDi 1.6 | 54 - 05/03→ 55 50 04/04→ 80 05/03→ | → Construction year to: 07/10; Fitting Position: Front Axle | 24.0122-0194.1 422194 | Outer diameter [mm]: 266 Brake Disc Thickness [mm] 22 Minimum thickness [mm] 20 Brake Disc Type: Vented Supplementary Article/Info 2: with bolts/screws | |
| CITROËN - C4 I (LC_) 11/04→11/14 | | | | | |
|  Brake Disc | | | | | |
| 1.4 16V 1.6 HDi | 65 11/04→07/11 66 11/04→07/11 | - ESP; Fitting Position: Front Axle | 24.0122-0194.1 422194 | Outer diameter [mm]: 266 Brake Disc Thickness [mm] 22 Minimum thickness [mm] 20 Brake Disc Type: Vented Supplementary Article/Info 2: with bolts/screws | |
| | | for RPO number (vehicle manufacturing date) from: 10551 →; + ESP; Fitting Position: Front Axle | 24.0122-0194.1 422194 | Outer diameter [mm]: 266 Brake Disc Thickness [mm] 22 Minimum thickness [mm] 20 Brake Disc Type: Vented Supplementary Article/Info 2: with bolts/screws | |
| 1.6 16V 1.6 16V Bio-Flex | 80 11/04→07/11 80 09/07→07/08 | for RPO number (vehicle manufacturing date) from: 10551 →; + ESP; Transmission Type: Manual Transmission; Fitting Position: Front Axle | 24.0122-0194.1 422194 | Outer diameter [mm]: 266 Brake Disc Thickness [mm] 22 Minimum thickness [mm] 20 Brake Disc Type: Vented Supplementary Article/Info 2: with bolts/screws | |
| | | - ESP; Fitting Position: Front Axle | 24.0122-0194.1 422194 | Outer diameter [mm]: 266 Brake Disc Thickness [mm] 22 Minimum thickness [mm] 20 Brake Disc Type: Vented Supplementary Article/Info 2: with bolts/screws | |
| 1.6 VTi 120 | 88 07/08→07/11 | Transmission Type: Manual Transmission; Fitting Position: Front Axle | 24.0122-0194.1 422194 | Outer diameter [mm]: 266 Brake Disc Thickness [mm] 22 Minimum thickness [mm] 20 Brake Disc Type: Vented Supplementary Article/Info 2: with bolts/screws | |
| CITROËN - C4 II (NC_) 02/09→ | | | | | |
|  Brake Disc | | | | | |
| 1.2 THP 110 1.4 VTi 95 | 81 02/15→12/17 70 11/09→ | Fitting Position: Front Axle | 24.0122-0194.1 422194 | Outer diameter [mm]: 266 Brake Disc Thickness [mm] 22 Minimum thickness [mm] 20 Brake Disc Type: Vented Supplementary Article/Info 2: with bolts/screws | |





| | | | | | |
|--|--|---|------------------------------|---|--|
| | kW | | | | |
| CITROËN - C4 II (NC_) 02/09→ | | | | | |
|  Brake Disc | | | | | |
| 1.6 HDi 90 | 68 11/09→ | Vehicle Equipment: for vehicles without electric parking brake; Fitting Position: Front Axle | 24.0122-0194.1 422194 | Outer diameter [mm]: 266 Brake Disc Thickness [mm] 22 Minimum thickness [mm] 20 Brake Disc Type: Vented Supplementary Article/Info 2: with bolts/screws | |
| CITROËN - C4 II Hatchback Van (NC_) 11/09→ | | | | | |
|  Brake Disc | | | | | |
| 1.6 HDi | 68 06/10→ | Vehicle Equipment: for vehicles without electric parking brake; Fitting Position: Front Axle | 24.0122-0194.1 422194 | Outer diameter [mm]: 266 Brake Disc Thickness [mm] 22 Minimum thickness [mm] 20 Brake Disc Type: Vented Supplementary Article/Info 2: with bolts/screws | |
| CITROËN - C4 III (BA_, BB_, BC_) 10/20→ | | | | | |
|  Brake Pad Set, disc brake | | | | | |
| e-C4 | 100 10/20→ | Fitting Position: Rear Axle | 13.0460-3871.2 603871 | Brake System: Bosch 25839 17,8 Wear Warning Contact: not prepared for wear indicator / excl. wear warning contact Supplementary Article/Supplementary Info: with accessories | |
| | | | 13.0470-3871.2 LD3871 | Brake System: Bosch 25839 17,8 Wear Warning Contact: not prepared for wear indicator / excl. wear warning contact Supplementary Article/Supplementary Info: with accessories Ceramic | |
| CITROËN - C4 CACTUS 09/14→ | | | | | |
|  Brake Disc | | | | | |
| 1.2 PureTech 130 1.2 THP 110 1.2 VTi 75 / PureTech 75 1.2 VTi 82 1.5 BlueHDi 100 1.5 BlueHDi 120 1.6 BlueHDi 100 1.6 HDi 90 | 96 11/17→ 81 09/14→ 55 09/14→ 60 09/14→ 73 - 06/18→ 75 88 09/18→ 73 09/14→ 68 09/14→ | Fitting Position: Front Axle | 24.0122-0194.1 422194 | Outer diameter [mm]: 266 Brake Disc Thickness [mm] 22 Minimum thickness [mm] 20 Brake Disc Type: Vented Supplementary Article/Info 2: with bolts/screws | |
| CITROËN - C4 CACTUS Van (0B_, 0P_) 09/14→ | | | | | |
|  Brake Disc | | | | | |
| BlueHDi 100 PureTech 110 PureTech 130 PureTech 82 | 73 05/19→ 81 05/19→ 96 05/19→ 60 05/19→ | Fitting Position: Front Axle | 24.0122-0194.1 422194 | Outer diameter [mm]: 266 Brake Disc Thickness [mm] 22 Minimum thickness [mm] 20 Brake Disc Type: Vented Supplementary Article/Info 2: with bolts/screws | |
| CITROËN - C4 Coupe (LA_) 11/04→12/13 | | | | | |
|  Brake Disc | | | | | |
| 1.4 16V 1.6 HDi | 65 11/04→07/11 66 11/04→07/11 | → Construction year to: 07/10; - ESP; Fitting Position: Front Axle | 24.0122-0194.1 422194 | Outer diameter [mm]: 266 Brake Disc Thickness [mm] 22 Minimum thickness [mm] 20 Brake Disc Type: Vented Supplementary Article/Info 2: with bolts/screws | |
| | | for RPO number (vehicle manufacturing date) from: 10551 →; → Construction year to: 07/10; + ESP; Fitting Position: Front Axle | 24.0122-0194.1 422194 | Outer diameter [mm]: 266 Brake Disc Thickness [mm] 22 Minimum thickness [mm] 20 Brake Disc Type: Vented Supplementary Article/Info 2: with bolts/screws | |
| 1.6 16V | 80 11/04→07/11 | → Construction year to: 07/10; - ESP; Transmission Type: Manual Transmission; Fitting Position: Front Axle | 24.0122-0194.1 422194 | Outer diameter [mm]: 266 Brake Disc Thickness [mm] 22 Minimum thickness [mm] 20 Brake Disc Type: Vented Supplementary Article/Info 2: with bolts/screws | |
| → | | | | | |





| | | kW | | | | | |
|--|---|--|---|----------------|----------------|---|-------------------|
| CITROËN - C4 Coupe (LA_) 11/04→12/13 | | | | | | | |
|  Brake Disc | | | | | | | |
| 1.6 16V | 80 | 11/04→07/11 | for RPO number (vehicle manufacturing date) from: 10551 →; → Construction year to: 07/10; + ESP; Transmission Type: Manual Transmission; Fitting Position: Front Axle | 24.0122-0194.1 | 422194 | Outer diameter [mm]: 266 Brake Disc Thickness [mm] 22 Minimum thickness [mm] 20 Brake Disc Type: Vented Supplementary Article/Info 2: with bolts/screws | |
| 1.6 VTi 120 | 88 | 07/08→07/11 | → Construction year to: 07/10; Transmission Type: Manual Transmission; Fitting Position: Front Axle | 24.0122-0194.1 | 422194 | Outer diameter [mm]: 266 Brake Disc Thickness [mm] 22 Minimum thickness [mm] 20 Brake Disc Type: Vented Supplementary Article/Info 2: with bolts/screws | |
| CITROËN - C4 GRAND PICASSO II (DA_, DE_) 06/13→ | | | | | | | |
| Spring, brake caliper | | | | | | | |
| 1.2 THP 130 1.6 BlueHDi 100 1.6 BlueHDi 120 1.6 HDi / BlueHDi 115 1.6 HDi 90 1.6 THP 150 1.6 THP 155 1.6 THP 165 1.6 VTi 120 2.0 BlueHDi 135 2.0 BlueHDi 150 | 96 73 88 85 68 110 115 121 88 100 110 | 04/14→ 01/15→ 07/14→ 09/13→ 09/13→ 09/14→ 09/13→ 07/14→ 09/13→ 09/13→ 06/13→ | for brake disc diameter [mm]: 283; Required quantity: 2; Fitting Position: Front Axle | 2 | 11.8116-0237.1 | 390509 | Brake System: ATE |
|  Brake Pad Set, disc brake | | | | | | | |
| 1.2 THP 130 1.6 BlueHDi 100 1.6 BlueHDi 120 1.6 HDi / BlueHDi 115 1.6 HDi 90 1.6 THP 150 1.6 THP 155 1.6 THP 165 1.6 VTi 120 2.0 BlueHDi 135 2.0 BlueHDi 150 | 96 73 88 85 68 110 115 121 88 100 110 | 04/14→ 01/15→ 07/14→ 09/13→ 09/13→ 09/14→ 09/13→ 07/14→ 09/13→ 09/13→ 06/13→ | for brake disc diameter [mm]: 268; Fitting Position: Rear Axle | 13.0460-3871.2 | 603871 | Brake System: Bosch 25839 17,8 Wear Warning Contact: not prepared for wear indicator / excl. wear warning contact Supplementary Article/Supplementary Info: with accessories | |
| | | | for brake disc diameter [mm]: 290; Fitting Position: Rear Axle | 13.0460-3872.2 | 603872 | Brake System: Bosch 25827 17,7 Wear Warning Contact: not prepared for wear indicator / excl. wear warning contact Supplementary Article/Supplementary Info: with accessories | |
| | | | | 13.0470-3871.2 | LD3871 | Brake System: Bosch 25839 17,8 Wear Warning Contact: not prepared for wear indicator / excl. wear warning contact Supplementary Article/Supplementary Info: with accessories Ceramic | |
| | | | | 13.0470-3872.2 | LD3872 | Brake System: Bosch 25827 17,7 Wear Warning Contact: not prepared for wear indicator / excl. wear warning contact Supplementary Article/Supplementary Info: with accessories Ceramic | |
|  Brake Disc | | | | | | | |
| 1.2 THP 130 1.6 BlueHDi 100 1.6 BlueHDi 120 1.6 HDi / BlueHDi 115 1.6 HDi 90 1.6 THP 150 1.6 THP 155 1.6 THP 165 1.6 VTi 120 2.0 BlueHDi 135 2.0 BlueHDi 150 | 96 73 88 85 68 110 115 121 88 100 110 | 04/14→ 01/15→ 07/14→ 09/13→ 09/13→ 09/14→ 09/13→ 07/14→ 09/13→ 09/13→ 06/13→ | Fitting Position: Front Axle | 24.0126-0183.1 | 426183 | Outer diameter [mm]: 283 Brake Disc Thickness [mm] 26 Minimum thickness [mm] 24 Brake Disc Type: Vented Supplementary Article/Info 2: with bolts/screws | |
| | | | Fitting Position: Rear Axle | 24.0128-0269.1 | 428269 | Outer diameter [mm]: 304 Brake Disc Thickness [mm] 28 Minimum thickness [mm] 26 Brake Disc Type: Vented Supplementary Article/Info 2: with bolts/screws | |
| | | | | 24.0112-0211.1 | 412211 | Outer diameter [mm]: 268 Brake Disc Thickness [mm] 12 Minimum thickness [mm] 10 Brake Disc Type: Solid Supplementary Article/Info 2: with bolts/screws | |



| | | kW | | | | | |
|--|------------|---|--|--------------------------------|--|---|--|
| CITROËN - C4 GRAND PICASSO II (DA_, DE_) 06/13→ | | | | | | | |
|  Brake Disc | | | | | | | |
| 1.2 THP 130 | 96 04/14→ | Fitting Position: Rear Axle | | 24.0112-0212.1 412212 | | Outer diameter [mm]: 290 Brake Disc Thickness [mm] 12 Minimum thickness [mm] 10 Brake Disc Type: Solid Supplementary Article/Info 2: with bolts/screws | |
| 1.6 BlueHDi 100 | 73 01/15→ | | | | | | |
| 1.6 BlueHDi 120 | 88 07/14→ | | | | | | |
| 1.6 HDi / BlueHDi 115 | 85 09/13→ | | | | | | |
| 1.6 HDi 90 | 68 09/13→ | | | | | | |
| 1.6 THP 150 | 110 09/14→ | | | | | | |
| 1.6 THP 155 | 115 09/13→ | | | | | | |
| 1.6 THP 165 | 121 07/14→ | | | | | | |
| 1.6 VTi 120 | 88 09/13→ | | | | | | |
| 2.0 BlueHDi 135 | 100 09/13→ | | | | | | |
| 2.0 BlueHDi 150 | 110 06/13→ | | | | | | |
| CITROËN - C4 PICASSO II 01/13→ | | | | | | | |
| Spring, brake caliper | | | | | | | |
| 1.2 THP 110 | 81 04/16→ | for brake disc diameter [mm]: 283; Required quantity: 2; | | 2 11.8116-0237.1 390509 | | Brake System: ATE | |
| 1.2 THP 130 | 96 04/14→ | Fitting Position: Front Axle | | | | | |
| 1.6 BlueHDi 100 | 73 12/14→ | | | | | | |
| 1.6 BlueHDi 120 | 88 07/14→ | | | | | | |
| 1.6 HDi / BlueHDi 115 | 85 02/13→ | | | | | | |
| 1.6 HDi 90 | 68 02/13→ | | | | | | |
| 1.6 THP 150 | 110 09/14→ | | | | | | |
| 1.6 THP 155 | 115 02/13→ | | | | | | |
| 1.6 THP 165 | 121 07/14→ | | | | | | |
| 1.6 VTi 120 | 88 02/13→ | | | | | | |
| 2.0 BlueHDi 135 | 100 09/13→ | | | | | | |
| 2.0 BlueHDi 150 | 110 09/13→ | | | | | | |
|  Brake Pad Set, disc brake | | | | | | | |
| 1.2 THP 110 | 81 04/16→ | for brake disc diameter [mm]: 268; Fitting Position: Rear Axle | | 13.0460-3871.2 603871 | | Brake System: Bosch 25839 17,8 Wear Warning Contact: not prepared for wear indicator / excl. wear warning contact Supplementary Article/Supplementary Info: with accessories | |
| 1.2 THP 130 | 96 04/14→ | | | | | | |
| 1.6 BlueHDi 100 | 73 12/14→ | | | | | | |
| 1.6 BlueHDi 120 | 88 07/14→ | | | | | | |
| 1.6 THP 150 | 110 09/14→ | | | | | | |
| 1.6 THP 165 | 121 07/14→ | | | | | | |
| 1.6 VTi 120 | 88 02/13→ | | | | | | |
| 2.0 BlueHDi 135 | 100 09/13→ | | | | | | |
| 2.0 BlueHDi 150 | 110 09/13→ | | | | | | |
| | | for brake disc diameter [mm]: 290; Fitting Position: Rear Axle | | 13.0460-3872.2 603872 | | Brake System: Bosch 25827 17,7 Wear Warning Contact: not prepared for wear indicator / excl. wear warning contact Supplementary Article/Supplementary Info: with accessories | |
| | | | | 13.0470-3871.2 LD3871 | | Brake System: Bosch 25839 17,8 Wear Warning Contact: not prepared for wear indicator / excl. wear warning contact Supplementary Article/Supplementary Info: with accessories Ceramic | |
| 1.6 HDi / BlueHDi 115 | 85 02/13→ | Construction year from: 06/13 →; | | 13.0460-3871.2 603871 | | Brake System: Bosch 25839 17,8 Wear Warning Contact: not prepared for wear indicator / excl. wear warning contact Supplementary Article/Supplementary Info: with accessories | |
| 1.6 HDi 90 | 68 02/13→ | for brake disc diameter [mm]: 268; Fitting Position: Rear Axle | | | | | |
| 1.6 THP 155 | 115 02/13→ | | | | | | |
| | | for brake disc diameter [mm]: 290; Fitting Position: Rear Axle | | 13.0460-3872.2 603872 | | Brake System: Bosch 25827 17,7 Wear Warning Contact: not prepared for wear indicator / excl. wear warning contact Supplementary Article/Supplementary Info: with accessories | |
| → | | | | | | | |





| | | | | | |
|---|---|---|--|--------------------------------|---|
| | kW | | | | |
| CITROËN - C4 PICASSO II 01/13→ | | | | | |
|  Brake Pad Set, disc brake | | | | | |
| 1.6 HDi / BlueHDi 115 1.6 HDi 90 1.6 THP 155 | 85 02/13→ 68 02/13→ 115 02/13→ | for brake disc diameter [mm]: 290; Fitting Position: Rear Axle | | 13.0470-3872.2 LD3872 | Brake System: Bosch 25827 17,7 Wear Warning Contact: not prepared for wear indicator / excl. wear warning contact Supplementary Article/Supplementary Info: with accessories Ceramic |
|  Brake Disc | | | | | |
| 1.2 THP 110 1.2 THP 130 1.6 BlueHDi 100 1.6 BlueHDi 120 1.6 THP 150 1.6 THP 165 1.6 VTi 120 2.0 BlueHDi 135 2.0 BlueHDi 150 | 81 04/16→ 96 04/14→ 73 12/14→ 88 07/14→ 110 09/14→ 121 07/14→ 88 02/13→ 100 09/13→ 110 09/13→ | Fitting Position: Front Axle | | 24.0126-0183.1 426183 | Outer diameter [mm]: 283 Brake Disc Thickness [mm] 26 Minimum thickness [mm] 24 Brake Disc Type: Vented Supplementary Article/Info 2: with bolts/screws |
| | | Fitting Position: Rear Axle | | 24.0128-0269.1 428269 | Outer diameter [mm]: 304 Brake Disc Thickness [mm] 28 Minimum thickness [mm] 26 Brake Disc Type: Vented Supplementary Article/Info 2: with bolts/screws |
| | | | | 24.0112-0211.1 412211 | Outer diameter [mm]: 268 Brake Disc Thickness [mm] 12 Minimum thickness [mm] 10 Brake Disc Type: Solid Supplementary Article/Info 2: with bolts/screws |
| | | | | 24.0112-0212.1 412212 | Outer diameter [mm]: 290 Brake Disc Thickness [mm] 12 Minimum thickness [mm] 10 Brake Disc Type: Solid Supplementary Article/Info 2: with bolts/screws |
| 1.6 HDi / BlueHDi 115 1.6 HDi 90 1.6 THP 155 | 85 02/13→ 68 02/13→ 115 02/13→ | Construction year from: 06/13 →; Fitting Position: Front Axle | | 24.0126-0183.1 426183 | Outer diameter [mm]: 283 Brake Disc Thickness [mm] 26 Minimum thickness [mm] 24 Brake Disc Type: Vented Supplementary Article/Info 2: with bolts/screws |
| | | | | 24.0128-0269.1 428269 | Outer diameter [mm]: 304 Brake Disc Thickness [mm] 28 Minimum thickness [mm] 26 Brake Disc Type: Vented Supplementary Article/Info 2: with bolts/screws |
| | | Construction year from: 06/13 →; Fitting Position: Rear Axle | | 24.0112-0211.1 412211 | Outer diameter [mm]: 268 Brake Disc Thickness [mm] 12 Minimum thickness [mm] 10 Brake Disc Type: Solid Supplementary Article/Info 2: with bolts/screws |
| | | | | 24.0112-0212.1 412212 | Outer diameter [mm]: 290 Brake Disc Thickness [mm] 12 Minimum thickness [mm] 10 Brake Disc Type: Solid Supplementary Article/Info 2: with bolts/screws |
| CITROËN - C4 PICASSO II Van (DD_) 01/13→ | | | | | |
| Spring, brake caliper | | | | | |
| BlueHDi 150 e-HDi HDi / e-HDi THP 155 VTi 120 | 110 09/13→ 85 02/13→ 68 02/13→ 115 02/13→ 88 02/13→ | for brake disc diameter [mm]: 283; Required quantity: 2; Fitting Position: Front Axle | | 2 11.8116-0237.1 390509 | Brake System: ATE |
|  Brake Pad Set, disc brake | | | | | |
| BlueHDi 150 e-HDi HDi / e-HDi THP 155 VTi 120 | 110 09/13→ 85 02/13→ 68 02/13→ 115 02/13→ 88 02/13→ | for brake disc diameter [mm]: 268; Fitting Position: Rear Axle | | 13.0460-3871.2 603871 | Brake System: Bosch 25839 17,8 Wear Warning Contact: not prepared for wear indicator / excl. wear warning contact Supplementary Article/Supplementary Info: with accessories |
| → | | | | | |



| | | | | | |
|--|---|---|--|--|---|
| | | | | | |
| | kW | | | | |
| CITROËN - C4 PICASSO II Van (DD_) 01/13→ | | | | | |
| Brake Pad Set, disc brake | | | | | |
| BlueHDi 150 e-HDi HDi / e-HDi THP 155 VTi 120 | 110 09/13→ 85 02/13→ 68 02/13→ 115 02/13→ 88 02/13→ | for brake disc diameter [mm]: 268; Fitting Position: Rear Axle | | 13.0470-3871.2 LD3871 | Brake System: Bosch 25839 17,8 Wear Warning Contact: not prepared for wear indicator / excl. wear warning contact Supplementary Article/Supplementary Info: with accessories Ceramic |
| | | for brake disc diameter [mm]: 290; Fitting Position: Rear Axle | | 13.0460-3872.2 603872 13.0470-3872.2 LD3872 | Brake System: Bosch 25827 17,7 Wear Warning Contact: not prepared for wear indicator / excl. wear warning contact Supplementary Article/Supplementary Info: with accessories Brake System: Bosch 25827 17,7 Wear Warning Contact: not prepared for wear indicator / excl. wear warning contact Supplementary Article/Supplementary Info: with accessories Ceramic |
| Brake Disc | | | | | |
| BlueHDi 150 e-HDi HDi / e-HDi THP 155 VTi 120 | 110 09/13→ 85 02/13→ 68 02/13→ 115 02/13→ 88 02/13→ | Fitting Position: Front Axle | | 24.0126-0183.1 426183 24.0128-0269.1 428269 | Outer diameter [mm]: 283 Brake Disc Thickness [mm] 26 Minimum thickness [mm] 24 Brake Disc Type: Vented Supplementary Article/Info 2: with bolts/screws Outer diameter [mm]: 304 Brake Disc Thickness [mm] 28 Minimum thickness [mm] 26 Brake Disc Type: Vented Supplementary Article/Info 2: with bolts/screws |
| | | Fitting Position: Rear Axle | | 24.0112-0211.1 412211 24.0112-0212.1 412212 | Outer diameter [mm]: 268 Brake Disc Thickness [mm] 12 Minimum thickness [mm] 10 Brake Disc Type: Solid Supplementary Article/Info 2: with bolts/screws Outer diameter [mm]: 290 Brake Disc Thickness [mm] 12 Minimum thickness [mm] 10 Brake Disc Type: Solid Supplementary Article/Info 2: with bolts/screws |
| CITROËN - C4 SPACETOURER (3D_) 04/18→ | | | | | |
| Spring, brake caliper | | | | | |
| 1.2 PureTech 110 1.2 PureTech 130 1.5 BlueHDi 130 1.6 BlueHDi 100 1.6 BlueHDi 120 1.6 THP 165 2.0 BlueHDi 150 2.0 BlueHDi 160 | 81 04/18→ 96 04/18→ 96 05/18→ 73 04/18→ 88 04/18→ 121 04/18→ 110 04/18→ 120 04/18→ | Required quantity: 2; for brake disc diameter [mm]: 283; Fitting Position: Front Axle | | 2 11.8116-0237.1 390509 | Brake System: ATE |
| Brake Pad Set, disc brake | | | | | |
| 1.2 PureTech 110 1.2 PureTech 130 1.5 BlueHDi 130 1.6 BlueHDi 100 1.6 BlueHDi 120 1.6 THP 165 2.0 BlueHDi 150 2.0 BlueHDi 160 | 81 04/18→ 96 04/18→ 96 05/18→ 73 04/18→ 88 04/18→ 121 04/18→ 110 04/18→ 120 04/18→ | for brake disc diameter [mm]: 268; Fitting Position: Rear Axle | | 13.0460-3871.2 603871 13.0470-3871.2 LD3871 | Brake System: Bosch 25839 17,8 Wear Warning Contact: not prepared for wear indicator / excl. wear warning contact Supplementary Article/Supplementary Info: with accessories Brake System: Bosch 25839 17,8 Wear Warning Contact: not prepared for wear indicator / excl. wear warning contact Supplementary Article/Supplementary Info: with accessories Ceramic |
| | | for brake disc diameter [mm]: 290; Fitting Position: Rear Axle | | 13.0460-3872.2 603872 | Brake System: Bosch 25827 17,7 Wear Warning Contact: not prepared for wear indicator / excl. wear warning contact Supplementary Article/Supplementary Info: with accessories |





| | | | | | |
|--|------------|---|---|------------------------------|---|
| | kW | | | | |
| CITROËN - C4 SPACETOURER (3D_) 04/18→ | | | | | |
|  Brake Pad Set, disc brake | | | | | |
| 1.2 PureTech 110 | 81 04/18→ | | for brake disc diameter [mm]: 290; Fitting Position: Rear Axle | 13.0470-3872.2 LD3872 | Brake System: Bosch 25827 17,7 Wear Warning Contact: not prepared for wear indicator / excl. wear warning contact Supplementary Article/Supplementary Info: with accessories Ceramic |
| 1.2 PureTech 130 | 96 04/18→ | | | | |
| 1.5 BlueHDi 130 | 96 05/18→ | | | | |
| 1.6 BlueHDi 100 | 73 04/18→ | | | | |
| 1.6 BlueHDi 120 | 88 04/18→ | | | | |
| 1.6 THP 165 | 121 04/18→ | | | | |
| 2.0 BlueHDi 150 | 110 04/18→ | | | | |
| 2.0 BlueHDi 160 | 120 04/18→ | | | | |
|  Brake Disc | | | | | |
| 1.2 PureTech 110 | 81 04/18→ | → for RPO number (vehicle manufacturing date) up to: 15741; Fitting Position: Front Axle | | 24.0126-0183.1 426183 | Outer diameter [mm]: 283 Brake Disc Thickness [mm] 26 Minimum thickness [mm] 24 Brake Disc Type: Vented Supplementary Article/Info 2: with bolts/screws |
| 1.2 PureTech 130 | 96 04/18→ | | | | |
| 1.5 BlueHDi 130 | 96 05/18→ | | | | |
| 1.6 BlueHDi 100 | 73 04/18→ | | | | |
| 1.6 BlueHDi 120 | 88 04/18→ | | | | |
| 1.6 THP 165 | 121 04/18→ | | | | |
| 2.0 BlueHDi 150 | 110 04/18→ | | | | |
| 2.0 BlueHDi 160 | 120 04/18→ | | | | |
| | | Fitting Position: Front Axle | | 24.0128-0269.1 428269 | Outer diameter [mm]: 304 Brake Disc Thickness [mm] 28 Minimum thickness [mm] 26 Brake Disc Type: Vented Supplementary Article/Info 2: with bolts/screws |
| | | Fitting Position: Rear Axle | | 24.0112-0211.1 412211 | Outer diameter [mm]: 268 Brake Disc Thickness [mm] 12 Minimum thickness [mm] 10 Brake Disc Type: Solid Supplementary Article/Info 2: with bolts/screws |
| | | | | 24.0112-0212.1 412212 | Outer diameter [mm]: 290 Brake Disc Thickness [mm] 12 Minimum thickness [mm] 10 Brake Disc Type: Solid Supplementary Article/Info 2: with bolts/screws |
| CITROËN - C4 SPACETOURER Van (3D_) 04/18→ | | | | | |
| Spring, brake caliper | | | | | |
| BlueHDi 120 | 88 05/19→ | Required quantity: 2; for brake disc diameter [mm]: 283; Fitting Position: Front Axle | 2 | 11.8116-0237.1 390509 | Brake System: ATE |
| BlueHDi 130 | 96 05/19→ | | | | |
| PureTech 130 | 96 05/19→ | | | | |
|  Brake Pad Set, disc brake | | | | | |
| BlueHDi 120 | 88 05/19→ | for brake disc diameter [mm]: 268; Fitting Position: Rear Axle | | 13.0460-3871.2 603871 | Brake System: Bosch 25839 17,8 Wear Warning Contact: not prepared for wear indicator / excl. wear warning contact Supplementary Article/Supplementary Info: with accessories |
| BlueHDi 130 | 96 05/19→ | | | | |
| PureTech 130 | 96 05/19→ | | | | |
| | | | | 13.0470-3871.2 LD3871 | Brake System: Bosch 25839 17,8 Wear Warning Contact: not prepared for wear indicator / excl. wear warning contact Supplementary Article/Supplementary Info: with accessories Ceramic |
| | | for brake disc diameter [mm]: 290; Fitting Position: Rear Axle | | 13.0460-3872.2 603872 | Brake System: Bosch 25827 17,7 Wear Warning Contact: not prepared for wear indicator / excl. wear warning contact Supplementary Article/Supplementary Info: with accessories |
| | | | | 13.0470-3872.2 LD3872 | Brake System: Bosch 25827 17,7 Wear Warning Contact: not prepared for wear indicator / excl. wear warning contact Supplementary Article/Supplementary Info: with accessories Ceramic |
|  Brake Disc | | | | | |
| BlueHDi 120 | 88 05/19→ | Fitting Position: Front Axle | | 24.0126-0183.1 426183 | Outer diameter [mm]: 283 Brake Disc Thickness [mm] 26 Minimum thickness [mm] 24 Brake Disc Type: Vented Supplementary Article/Info 2: with bolts/screws |
| BlueHDi 130 | 96 05/19→ | | | | |
| PureTech 130 | 96 05/19→ | | | | |
| → | | | | | |





| | kW | | | | |
|--|-------------------------------------|--|--|--|---|
| CITROËN - C4 SPACETOURER Van (3D_) 04/18→ | | | | | |
|  Brake Disc | | | | | |
| BlueHDi 120 BlueHDi 130 PureTech 130 | 88 05/19→ 96 05/19→ 96 05/19→ | | Fitting Position: Front Axle | 24.0128-0269.1 428269 | Outer diameter [mm]: 304 Brake Disc Thickness [mm] 28 Minimum thickness [mm] 26 Brake Disc Type: Vented Supplementary Article/Info 2: with bolts/screws |
| | | | Fitting Position: Rear Axle | 24.0112-0211.1 412211 24.0112-0212.1 412212 | Outer diameter [mm]: 268 Brake Disc Thickness [mm] 12 Minimum thickness [mm] 10 Brake Disc Type: Solid Supplementary Article/Info 2: with bolts/screws Outer diameter [mm]: 290 Brake Disc Thickness [mm] 12 Minimum thickness [mm] 10 Brake Disc Type: Solid Supplementary Article/Info 2: with bolts/screws |
| CITROËN - C5 I (DC_) 03/01→03/05 | | | | | |
|  Brake Disc | | | | | |
| 1.8 16V | 85 03/01→08/04 | | Fitting Position: Front Axle | 24.0122-0194.1 422194 | Outer diameter [mm]: 266 Brake Disc Thickness [mm] 22 Minimum thickness [mm] 20 Brake Disc Type: Vented Supplementary Article/Info 2: with bolts/screws |
| CITROËN - C5 II (RC_) 08/04→09/08 | | | | | |
|  Brake Disc | | | | | |
| 1.8 16V | 85 - 09/04→01/08 92 | | Fitting Position: Front Axle | 24.0122-0194.1 422194 | Outer diameter [mm]: 266 Brake Disc Thickness [mm] 22 Minimum thickness [mm] 20 Brake Disc Type: Vented Supplementary Article/Info 2: with bolts/screws |
| CITROËN - C5 III Break (RW_) 02/08→ | | | | | |
|  Brake Disc | | | | | |
| 2.0 HDi 165 | 120 04/09→ | | Fitting Position: Front Axle | 24.0128-0269.1 428269 | Outer diameter [mm]: 304 Brake Disc Thickness [mm] 28 Minimum thickness [mm] 26 Brake Disc Type: Vented Supplementary Article/Info 2: with bolts/screws |
| CITROËN - C5 X (ND_, NC_) 09/21→ | | | | | |
|  Brake Pad Set, disc brake | | | | | |
| Hybrid 225 | 132 - 09/21→ 165 | | for brake disc diameter [mm]: 330; Fitting Position: Front Axle | 13.0460-3876.2 603876 | Brake System: Bosch 22218 18,3 Wear Warning Contact: prepared for wear indicator / excl. wear warning contact Supplementary Article/Supplementary Info: with accessories |
| | | | Fitting Position: Rear Axle | 13.0460-3872.2 603872 13.0470-3872.2 LD3872 | Brake System: Bosch 25827 17,7 Wear Warning Contact: not prepared for wear indicator / excl. wear warning contact Supplementary Article/Supplementary Info: with accessories Brake System: Bosch 25827 17,7 Wear Warning Contact: not prepared for wear indicator / excl. wear warning contact Supplementary Article/Supplementary Info: with accessories Ceramic |
| PureTech 130 PureTech 180 | 96 09/21→ 133 09/21→ | | for brake disc diameter [mm]: 330; Fitting Position: Front Axle | 13.0460-3876.2 603876 | Brake System: Bosch 22218 18,3 Wear Warning Contact: prepared for wear indicator / excl. wear warning contact Supplementary Article/Supplementary Info: with accessories |
| → | | | | | |



| | | kW | | | | | |
|--|---|--|--|------------------------------|--|------------------------------|--|
| CITROËN - C5 X (ND_, NC_) 09/21→ | | | | | | | |
|  Brake Disc | | | | | | | |
| Hybrid 225 | 132 - 09/21→ 165 | Fitting Position: Front Axle | | 24.0128-0269.1 428269 | Outer diameter [mm]: 304 Brake Disc Thickness [mm] 28 Minimum thickness [mm] 26 Brake Disc Type: Vented Supplementary Article/Info 2: with bolts/screws | 24.0130-0241.1 430241 | Outer diameter [mm]: 330 Brake Disc Thickness [mm] 30 Minimum thickness [mm] 28 Brake Disc Type: Vented Supplementary Article/Info 2: with bolts/screws |
| | | Fitting Position: Rear Axle | | | | | |
| PureTech 130 PureTech 180 | 96 09/21→ 133 09/21→ | Fitting Position: Front Axle | | 24.0128-0269.1 428269 | Outer diameter [mm]: 304 Brake Disc Thickness [mm] 28 Minimum thickness [mm] 26 Brake Disc Type: Vented Supplementary Article/Info 2: with bolts/screws | 24.0130-0241.1 430241 | Outer diameter [mm]: 330 Brake Disc Thickness [mm] 30 Minimum thickness [mm] 28 Brake Disc Type: Vented Supplementary Article/Info 2: with bolts/screws |
| CITROËN - C5 AIRCROSS (A_) 11/18→ | | | | | | | |
|  Brake Pad Set, disc brake | | | | | | | |
| 1.2 PureTech 130 1.5 BlueHDi 130 1.6 Hybrid 225 1.6 PureTech 180 1.6 THP 150 1.6 THP 165 2.0 BlueHDi 180 | 96 11/18→ 96 11/18→ 133 - 04/20→ 165 133 11/18→ 110 09/19→ 121 05/19→ 130 11/18→ | for brake disc diameter [mm]: 330; Fitting Position: Front Axle | | 13.0460-3876.2 603876 | Brake System: Bosch 22218 18,3 Wear Warning Contact: prepared for wear indicator / excl. wear warning contact Supplementary Article/Supplementary Info: with accessories | 13.0460-3872.2 603872 | Brake System: Bosch 25827 17,7 Wear Warning Contact: not prepared for wear indicator / excl. wear warning contact Supplementary Article/Supplementary Info: with accessories |
| | | Fitting Position: Rear Axle | | | | | |
|  Brake Disc | | | | | | | |
| 1.2 PureTech 130 1.5 BlueHDi 130 1.6 Hybrid 225 1.6 PureTech 180 1.6 THP 150 1.6 THP 165 2.0 BlueHDi 180 | 96 11/18→ 96 11/18→ 133 - 04/20→ 165 133 11/18→ 110 09/19→ 121 05/19→ 130 11/18→ | Fitting Position: Front Axle | | 24.0128-0269.1 428269 | Outer diameter [mm]: 304 Brake Disc Thickness [mm] 28 Minimum thickness [mm] 26 Brake Disc Type: Vented Supplementary Article/Info 2: with bolts/screws | 24.0130-0241.1 430241 | Outer diameter [mm]: 330 Brake Disc Thickness [mm] 30 Minimum thickness [mm] 28 Brake Disc Type: Vented Supplementary Article/Info 2: with bolts/screws |
| | | Fitting Position: Rear Axle | | | | | |







| | kW | | | | |
|--|---|---|--------------------------------|---|--|
| CITROËN - C-ELYSEE (DD_) 11/12→ | | | | | |
|  Brake Disc | | | | | |
| 1.2 PureTech 82 1.2 VTi 72 1.2 VTi 82 1.5 BlueHDi 100 1.6 BlueHDi 100 1.6 HDi 92 1.6 VTi 115 | 61 02/18→ 53 11/12→01/17 60 12/14→ 75 05/18→ 73 11/14→ 68 11/12→ 85 11/12→ | Fitting Position: Front Axle | 24.0122-0194.1 422194 | Outer diameter [mm]: 266 Brake Disc Thickness [mm] 22 Minimum thickness [mm] 20 Brake Disc Type: Vented Supplementary Article/Info 2: with bolts/screws | |
| CITROËN - DS3 (SA_) 11/09→12/16 | | | | | |
|  Brake Disc | | | | | |
| 1.2 THP 110 1.2 VTi 82 1.4 HDi 70 1.4 VTi 95 1.4 VTi 95 LPG 1.6 BlueHDi 100 1.6 BlueHDi 75 1.6 HDi 110 1.6 HDi 115 1.6 HDi 90 1.6 THP 165 1.6 VTi 120 | 81 10/14→03/15 60 01/13→03/15 50 04/10→07/15 70 04/10→07/15 70 08/12→07/15 73 07/14→07/15 55 03/15→07/15 82 11/09→07/15 84 08/12→07/15 68 11/09→07/15 121 10/14→06/15 88 04/10→07/15 | Fitting Position: Front Axle | 24.0122-0194.1 422194 | Outer diameter [mm]: 266 Brake Disc Thickness [mm] 22 Minimum thickness [mm] 20 Brake Disc Type: Vented Supplementary Article/Info 2: with bolts/screws | |
| 1.4 VTi 98 | 72 11/09→07/15 | Construction year from: 04/10 →; Fitting Position: Front Axle | 24.0122-0194.1 422194 | Outer diameter [mm]: 266 Brake Disc Thickness [mm] 22 Minimum thickness [mm] 20 Brake Disc Type: Vented Supplementary Article/Info 2: with bolts/screws | |
| 1.6 THP160 | 120 01/12→07/15 | Construction year from: 10/14 →; Fitting Position: Front Axle | 24.0122-0194.1 422194 | Outer diameter [mm]: 266 Brake Disc Thickness [mm] 22 Minimum thickness [mm] 20 Brake Disc Type: Vented Supplementary Article/Info 2: with bolts/screws | |
| CITROËN - DS3 Convertible 01/13→07/15 | | | | | |
|  Brake Disc | | | | | |
| 1.2 THP 110 1.6 BlueHDi 100 | 81 10/14→07/15 73 - 07/14→07/15 75 | Fitting Position: Front Axle | 24.0122-0194.1 422194 | Outer diameter [mm]: 266 Brake Disc Thickness [mm] 22 Minimum thickness [mm] 20 Brake Disc Type: Vented Supplementary Article/Info 2: with bolts/screws | |
| 1.6 BlueHDi 115 1.6 THP 165 | 85 10/13→07/15 120 - 10/14→07/15 121 | Construction year from: 03/13 →; Fitting Position: Front Axle | 24.0122-0194.1 422194 | Outer diameter [mm]: 266 Brake Disc Thickness [mm] 22 Minimum thickness [mm] 20 Brake Disc Type: Vented Supplementary Article/Info 2: with bolts/screws | |
| CITROËN - GRAND C4 SPACETOURER (3A_, 3E_) 04/18→ | | | | | |
| Spring, brake caliper | | | | | |
| 1.2 PureTech 130 1.5 BlueHDi 130 1.6 BlueHDi 100 1.6 BlueHDi 120 1.6 HDi 115 1.6 PureTech 180 1.6 THP 165 | 96 04/18→ 96 05/18→ 73 04/18→ 88 04/18→ 85 04/18→ 133 04/18→ 110 - 04/18→ 121 | Required quantity: 2; for brake disc diameter [mm]: 283; Fitting Position: Front Axle | 2 11.8116-0237.1 390509 | Brake System: ATE | |
| 2.0 BlueHDi 150 2.0 BlueHDi 160 | 110 04/18→ 120 04/18→ | | | | |
|  Brake Pad Set, disc brake | | | | | |
| 1.2 PureTech 130 1.5 BlueHDi 130 1.6 BlueHDi 100 1.6 BlueHDi 120 1.6 HDi 115 1.6 PureTech 180 1.6 THP 165 | 96 04/18→ 96 05/18→ 73 04/18→ 88 04/18→ 85 04/18→ 133 04/18→ 110 - 04/18→ 121 | for brake disc diameter [mm]: 268; Fitting Position: Rear Axle | 13.0460-3871.2 603871 | Brake System: Bosch 25839 17,8 Wear Warning Contact: not prepared for wear indicator / excl. wear warning contact Supplementary Article/Supplementary Info: with accessories | |
| 2.0 BlueHDi 150 2.0 BlueHDi 160 | 110 04/18→ 120 04/18→ | | 13.0470-3871.2 LD3871 | Brake System: Bosch 25839 17,8 Wear Warning Contact: not prepared for wear indicator / excl. wear warning contact Supplementary Article/Supplementary Info: with accessories Ceramic | |
| → | | | | | |





| | | kW | | | | | | | | | | | |
|--|---------------------|---|------------------------------|--|-------------------|--|--|---|------------------------------|---|--|--|--|
| CITROËN - GRAND C4 SPACETOURER (3A_, 3E_) 04/18→ | | | | | | | | | | | | | |
|  Brake Pad Set, disc brake | | | | | | | | | | | | | |
| 1.2 PureTech 130 | 96 04/18→ | for brake disc diameter [mm]: 290; Fitting Position: Rear Axle | 13.0460-3872.2 603872 | Brake System: Bosch 25827 17,7 Wear Warning Contact: not prepared for wear indicator / excl. wear warning contact Supplementary Article/Supplementary Info: with accessories | | | | | | | | | |
| 1.5 BlueHDi 130 | 96 05/18→ | | | | | | | | | | | | |
| 1.6 BlueHDi 100 | 73 04/18→ | | | | | | | | | | | | |
| 1.6 BlueHDi 120 | 88 04/18→ | | | | | | | | | | | | |
| 1.6 HDi 115 | 85 04/18→ | | | | | | | | | | | | |
| 1.6 PureTech 180 | 133 04/18→ | | | | | | | | | | | | |
| 1.6 THP 165 | 110 - 04/18→ 121 | | | | | | | | | | | | |
| 2.0 BlueHDi 150 | 110 04/18→ | | | | | | | | | | | | |
| 2.0 BlueHDi 160 | 120 04/18→ | | | | | | | | | | | | |
| | | | | | | | | | 13.0470-3872.2 LD3872 | Brake System: Bosch 25827 17,7 Wear Warning Contact: not prepared for wear indicator / excl. wear warning contact Supplementary Article/Supplementary Info: with accessories Ceramic | | | |
|  Brake Disc | | | | | | | | | | | | | |
| 1.2 PureTech 130 | 96 04/18→ | → for RPO number (vehicle manufacturing date) up to: 15741; Fitting Position: Front Axle | 24.0126-0183.1 426183 | Outer diameter [mm]: 283 Brake Disc Thickness [mm] 26 Minimum thickness [mm] 24 Brake Disc Type: Vented Supplementary Article/Info 2: with bolts/screws | | | | | | | | | |
| 1.5 BlueHDi 130 | 96 05/18→ | | | | | | | | | | | | |
| 1.6 BlueHDi 100 | 73 04/18→ | | | | | | | | | | | | |
| 1.6 BlueHDi 120 | 88 04/18→ | | | | | | | | | | | | |
| 1.6 HDi 115 | 85 04/18→ | | | | | | | | | | | | |
| 1.6 PureTech 180 | 133 04/18→ | | | | | | | | | | | | |
| 1.6 THP 165 | 110 - 04/18→ 121 | | | | | | | | | | | | |
| 2.0 BlueHDi 150 | 110 04/18→ | | | | | | | | | | | | |
| 2.0 BlueHDi 160 | 120 04/18→ | | | | | | | | | | | | |
| | | | | | | | | Fitting Position: Front Axle | 24.0128-0269.1 428269 | Outer diameter [mm]: 304 Brake Disc Thickness [mm] 28 Minimum thickness [mm] 26 Brake Disc Type: Vented Supplementary Article/Info 2: with bolts/screws | | | |
| | | Fitting Position: Rear Axle | 24.0112-0211.1 412211 | Outer diameter [mm]: 268 Brake Disc Thickness [mm] 12 Minimum thickness [mm] 10 Brake Disc Type: Solid Supplementary Article/Info 2: with bolts/screws | | | | | | | | | |
| | | | 24.0112-0212.1 412212 | Outer diameter [mm]: 290 Brake Disc Thickness [mm] 12 Minimum thickness [mm] 10 Brake Disc Type: Solid Supplementary Article/Info 2: with bolts/screws | | | | | | | | | |
| CITROËN - GRAND C4 SPACETOURER Van (3A_, 3E_) 04/18→ | | | | | | | | | | | | | |
| Spring, brake caliper | | | | | | | | | | | | | |
| BlueHDi 130 | 96 05/19→ | Required quantity: 2; for brake disc diameter [mm]: 283; Fitting Position: Front Axle | 2 | 11.8116-0237.1 390509 | Brake System: ATE | | | | | | | | |
| BlueHDi 160 | 120 05/19→ | | | | | | | | | | | | |
| PureTech 130 | 96 05/19→ | | | | | | | | | | | | |
|  Brake Pad Set, disc brake | | | | | | | | | | | | | |
| BlueHDi 130 | 96 05/19→ | for brake disc diameter [mm]: 268; Fitting Position: Rear Axle | 13.0460-3871.2 603871 | Brake System: Bosch 25839 17,8 Wear Warning Contact: not prepared for wear indicator / excl. wear warning contact Supplementary Article/Supplementary Info: with accessories | | | | | | | | | |
| BlueHDi 160 | 120 05/19→ | | | | | | | | | | | | |
| PureTech 130 | 96 05/19→ | | | | | | | | | | | | |
| | | | | | | | | | 13.0470-3871.2 LD3871 | Brake System: Bosch 25839 17,8 Wear Warning Contact: not prepared for wear indicator / excl. wear warning contact Supplementary Article/Supplementary Info: with accessories Ceramic | | | |
| | | | | | | | | for brake disc diameter [mm]: 290; Fitting Position: Rear Axle | 13.0460-3872.2 603872 | Brake System: Bosch 25827 17,7 Wear Warning Contact: not prepared for wear indicator / excl. wear warning contact Supplementary Article/Supplementary Info: with accessories | | | |
| | | | | | | | | | 13.0470-3872.2 LD3872 | Brake System: Bosch 25827 17,7 Wear Warning Contact: not prepared for wear indicator / excl. wear warning contact Supplementary Article/Supplementary Info: with accessories Ceramic | | | |





| | kW | | | | |
|--|---|--|--|--|--|
| CITROËN - GRAND C4 SPACETOURER Van (3A_, 3E_) 04/18→ | | | | | |
|  Brake Disc | | | | | |
| BlueHDi 130 BlueHDi 160 PureTech 130 | 96 05/19→ 120 05/19→ 96 05/19→ | → for RPO number (vehicle manufacturing date) up to: 15741; Fitting Position: Front Axle | 24.0126-0183.1 426183 | Outer diameter [mm]: 283 Brake Disc Thickness [mm] 26 Minimum thickness [mm] 24 Brake Disc Type: Vented Supplementary Article/Info 2: with bolts/screws | |
| | | Fitting Position: Front Axle | 24.0128-0269.1 428269 | Outer diameter [mm]: 304 Brake Disc Thickness [mm] 28 Minimum thickness [mm] 26 Brake Disc Type: Vented Supplementary Article/Info 2: with bolts/screws | |
| | | Fitting Position: Rear Axle | 24.0112-0211.1 412211 24.0112-0212.1 412212 | Outer diameter [mm]: 268 Brake Disc Thickness [mm] 12 Minimum thickness [mm] 10 Brake Disc Type: Solid Supplementary Article/Info 2: with bolts/screws Outer diameter [mm]: 290 Brake Disc Thickness [mm] 12 Minimum thickness [mm] 10 Brake Disc Type: Solid Supplementary Article/Info 2: with bolts/screws | |
| CITROËN - JUMPY Bus (V_) 04/16→ | | | | | |
|  Brake Disc | | | | | |
| 1.5 BlueHDi 100 1.5 BlueHDi 120 1.6 BlueHDi 115 1.6 BlueHDi 95 2.0 BlueHDi 120 2.0 BlueHDi 150 2.0 BlueHDi 180 | 75 06/18→ 88 06/18→ 85 04/16→ 70 04/16→ 90 12/19→ 110 04/16→ 130 04/16→ | Vehicle Equipment: for vehicles without electric parking brake; Fitting Position: Rear Axle | 24.0112-0212.1 412212 | Outer diameter [mm]: 290 Brake Disc Thickness [mm] 12 Minimum thickness [mm] 10 Brake Disc Type: Solid Supplementary Article/Info 2: with bolts/screws | |
| CITROËN - JUMPY Platform/Chassis (V_) 09/16→ | | | | | |
|  Brake Disc | | | | | |
| 1.6 BlueHDi 95 2.0 BlueHDi 120 2.0 BlueHDi 150 | 70 09/16→ 90 09/16→ 110 09/16→ | Vehicle Equipment: for vehicles without electric parking brake; Fitting Position: Rear Axle | 24.0112-0212.1 412212 | Outer diameter [mm]: 290 Brake Disc Thickness [mm] 12 Minimum thickness [mm] 10 Brake Disc Type: Solid Supplementary Article/Info 2: with bolts/screws | |
| CITROËN - JUMPY Van (V_) 04/16→ | | | | | |
|  Brake Disc | | | | | |
| 1.5 BlueHDi 100 1.5 BlueHDi 120 1.6 BlueHDi 115 1.6 BlueHDi 90 1.6 BlueHDi 95 2.0 BlueHDi 120 2.0 BlueHDi 120 4x4 2.0 BlueHDi 145 2.0 BlueHDi 150 2.0 BlueHDi 150 4x4 2.0 BlueHDi 180 E-JUMPY | 75 06/18→ 88 06/18→ 85 04/16→ 66 09/18→ 70 04/16→ 90 04/16→ 90 04/16→ 106 08/21→ 110 04/16→ 110 04/16→ 130 04/16→ 100 09/20→ | Vehicle Equipment: for vehicles without electric parking brake; Fitting Position: Rear Axle | 24.0112-0212.1 412212 | Outer diameter [mm]: 290 Brake Disc Thickness [mm] 12 Minimum thickness [mm] 10 Brake Disc Type: Solid Supplementary Article/Info 2: with bolts/screws | |
| CITROËN - SPACETOURER Bus (V_) 04/16→ | | | | | |
|  Brake Disc | | | | | |
| 1.5 BlueHDi 100 1.5 BlueHDi 120 1.6 BlueHDi 115 1.6 BlueHDi 95 1.6 HDi 90 2.0 BlueHDi 120 2.0 BlueHDi 145 2.0 BlueHDi 150 2.0 BlueHDi 150 4x4 2.0 BlueHDi 180 E-SPACETOURER | 75 06/18→ 88 06/18→ 85 04/16→ 70 04/16→ 66 07/18→ 90 12/19→ 106 09/20→ 110 04/16→ 110 04/16→ 130 04/16→ 100 09/20→ | Vehicle Equipment: for vehicles without electric parking brake; Fitting Position: Rear Axle | 24.0112-0212.1 412212 | Outer diameter [mm]: 290 Brake Disc Thickness [mm] 12 Minimum thickness [mm] 10 Brake Disc Type: Solid Supplementary Article/Info 2: with bolts/screws | |





| | kW | | | | |
|---|--|---|--|------------------------------|---|
| CITROËN - XSARA (N1) 04/97→12/05 | | | | | |
|  Brake Disc | | | | | |
| 1.4 HDi 1.6 16V | 50 01/03→03/05 80 09/00→03/05 | Fitting Position: Front Axle | | 24.0122-0194.1 422194 | Outer diameter [mm]: 266 Brake Disc Thickness [mm] 22 Minimum thickness [mm] 20 Brake Disc Type: Vented Supplementary Article/Info 2: with bolts/screws |
| 1.4 i 1.9 D 2.0 HDi 90 | 55 04/97→03/05 51 07/98→03/05 66 02/99→03/05 | Construction year from: 09/00 →; Fitting Position: Front Axle | | 24.0122-0194.1 422194 | Outer diameter [mm]: 266 Brake Disc Thickness [mm] 22 Minimum thickness [mm] 20 Brake Disc Type: Vented Supplementary Article/Info 2: with bolts/screws |
| 1.9 D | 52 04/00→04/05 | Construction year from: 09/00 → → Construction year to: 03/05; Fitting Position: Front Axle | | 24.0122-0194.1 422194 | Outer diameter [mm]: 266 Brake Disc Thickness [mm] 22 Minimum thickness [mm] 20 Brake Disc Type: Vented Supplementary Article/Info 2: with bolts/screws |
| CITROËN - XSARA Break (N2) 10/97→03/10 | | | | | |
|  Brake Disc | | | | | |
| 1.4 HDi 1.6 16V | 50 01/03→08/05 80 09/00→08/05 | Fitting Position: Front Axle | | 24.0122-0194.1 422194 | Outer diameter [mm]: 266 Brake Disc Thickness [mm] 22 Minimum thickness [mm] 20 Brake Disc Type: Vented Supplementary Article/Info 2: with bolts/screws |
| 1.4 i 1.9 D 2.0 HDI 90 | 55 10/97→08/05 51 07/98→08/05 66 02/99→08/05 | Construction year from: 09/00 →; Fitting Position: Front Axle | | 24.0122-0194.1 422194 | Outer diameter [mm]: 266 Brake Disc Thickness [mm] 22 Minimum thickness [mm] 20 Brake Disc Type: Vented Supplementary Article/Info 2: with bolts/screws |
| CITROËN - XSARA Coupe (N0) 01/98→04/05 | | | | | |
|  Brake Disc | | | | | |
| 1.4 HDi 1.6 16V | 50 01/03→03/05 80 09/00→03/05 | Fitting Position: Front Axle | | 24.0122-0194.1 422194 | Outer diameter [mm]: 266 Brake Disc Thickness [mm] 22 Minimum thickness [mm] 20 Brake Disc Type: Vented Supplementary Article/Info 2: with bolts/screws |
| 1.4 i 1.9 D 2.0 HDI 90 | 55 03/98→03/05 51 02/99→03/05 66 02/99→03/05 | Construction year from: 09/00 →; Fitting Position: Front Axle | | 24.0122-0194.1 422194 | Outer diameter [mm]: 266 Brake Disc Thickness [mm] 22 Minimum thickness [mm] 20 Brake Disc Type: Vented Supplementary Article/Info 2: with bolts/screws |
| CITROËN - XSARA Estate Van 05/98→08/05 | | | | | |
|  Brake Disc | | | | | |
| 1.4 2.0 HDi | 55 09/00→03/05 66 09/00→03/05 | Fitting Position: Front Axle | | 24.0122-0194.1 422194 | Outer diameter [mm]: 266 Brake Disc Thickness [mm] 22 Minimum thickness [mm] 20 Brake Disc Type: Vented Supplementary Article/Info 2: with bolts/screws |
| 1.9 D | 51 06/99→08/05 | Construction year from: 09/00 →; Fitting Position: Front Axle | | 24.0122-0194.1 422194 | Outer diameter [mm]: 266 Brake Disc Thickness [mm] 22 Minimum thickness [mm] 20 Brake Disc Type: Vented Supplementary Article/Info 2: with bolts/screws |
| CITROËN - XSARA Hatchback Van (N3_) 05/98→03/05 | | | | | |
|  Brake Disc | | | | | |
| 1.4 1.9 D | 55 05/98→10/04 51 06/99→03/05 | Construction year from: 09/00 →; Fitting Position: Front Axle | | 24.0122-0194.1 422194 | Outer diameter [mm]: 266 Brake Disc Thickness [mm] 22 Minimum thickness [mm] 20 Brake Disc Type: Vented Supplementary Article/Info 2: with bolts/screws |
| → | | | | | |



| | kW | | | | |
|--|--|---|---|------------------------------|---|
| CITROËN - XSARA Hatchback Van (N3_) 05/98→03/05 | | | | | |
|  Brake Disc | | | | | |
| 2.0 HDi | 66 | 09/00→03/05 | Fitting Position: Front Axle | 24.0122-0194.1 422194 | Outer diameter [mm]: 266 Brake Disc Thickness [mm] 22 Minimum thickness [mm] 20 Brake Disc Type: Vented Supplementary Article/Info 2: with bolts/screws |
| CITROËN - XSARA PICASSO (N68) 09/99→06/12 | | | | | |
|  Brake Disc | | | | | |
| 1.6 | 65 | 12/99→09/01 | Construction year from: 06/00 →; - ESP; Fitting Position: Front Axle | 24.0122-0194.1 422194 | Outer diameter [mm]: 266 Brake Disc Thickness [mm] 22 Minimum thickness [mm] 20 Brake Disc Type: Vented Supplementary Article/Info 2: with bolts/screws |
| 1.6 1.6 16V 1.6 16V LPG 1.6 Chrono 1.8 16V | 67 80 80 74 85 | 06/02→08/05 09/05→12/11 06/04→12/10 04/01→10/04 02/00→08/05 | - ESP; Fitting Position: Front Axle | 24.0122-0194.1 422194 | Outer diameter [mm]: 266 Brake Disc Thickness [mm] 22 Minimum thickness [mm] 20 Brake Disc Type: Vented Supplementary Article/Info 2: with bolts/screws |
| 1.6 | 70 | 12/99→12/10 | Construction year from: 09/00 → → Construction year to: 03/10; - ESP; Fitting Position: Front Axle | 24.0122-0194.1 422194 | Outer diameter [mm]: 266 Brake Disc Thickness [mm] 22 Minimum thickness [mm] 20 Brake Disc Type: Vented Supplementary Article/Info 2: with bolts/screws |
| 1.6 16V | 81 | 06/05→09/06 | Construction year from: 09/05 →; - ESP; Fitting Position: Front Axle | 24.0122-0194.1 422194 | Outer diameter [mm]: 266 Brake Disc Thickness [mm] 22 Minimum thickness [mm] 20 Brake Disc Type: Vented Supplementary Article/Info 2: with bolts/screws |
| 1.6 HDi | 66 - 80 | 05/04→12/11 | → Construction year to: 03/10; - ESP; Fitting Position: Front Axle | 24.0122-0194.1 422194 | Outer diameter [mm]: 266 Brake Disc Thickness [mm] 22 Minimum thickness [mm] 20 Brake Disc Type: Vented Supplementary Article/Info 2: with bolts/screws |
| 2.0 | 88 | 02/04→10/04 | - ESP; Transmission Type: Manual Transmis- sion; Fitting Position: Front Axle | 24.0122-0194.1 422194 | Outer diameter [mm]: 266 Brake Disc Thickness [mm] 22 Minimum thickness [mm] 20 Brake Disc Type: Vented Supplementary Article/Info 2: with bolts/screws |
| 2.0 16V | 100 | 01/03→06/12 | → Construction year to: 03/10; - ESP; Transmission Type: Manual Transmis- sion; Fitting Position: Front Axle | 24.0122-0194.1 422194 | Outer diameter [mm]: 266 Brake Disc Thickness [mm] 22 Minimum thickness [mm] 20 Brake Disc Type: Vented Supplementary Article/Info 2: with bolts/screws |
| 2.0 16V | 101 | 12/99→11/11 | Construction year from: 01/03 → → Construction year to: 03/10; - ESP; Transmission Type: Manual Transmis- sion; Fitting Position: Front Axle | 24.0122-0194.1 422194 | Outer diameter [mm]: 266 Brake Disc Thickness [mm] 22 Minimum thickness [mm] 20 Brake Disc Type: Vented Supplementary Article/Info 2: with bolts/screws |
| 2.0 HDi | 66 | 12/99→12/11 | Construction year from: 06/00 → → Construction year to: 03/10; - ESP; Fitting Position: Front Axle | 24.0122-0194.1 422194 | Outer diameter [mm]: 266 Brake Disc Thickness [mm] 22 Minimum thickness [mm] 20 Brake Disc Type: Vented Supplementary Article/Info 2: with bolts/screws |
| CUPRA - FORMENTOR (KM7) 07/20→ | | | | | |
|  Brake Pad Set, disc brake | | | | | |
| 1.4 e-Hybrid 1.5 TSI 2.0 TDI 2.0 TDI 4Drive 2.0 TSI 2.0 TSI 4Drive VZ 1.4 e-Hybrid | 110 - 150 110 110 110 180 140 180 | 01/21→ 11/20→ 03/21→ 03/21→ 03/21→ 08/20→ 02/21→ | for PR number: 1ZK; Fitting Position: Front Axle | 13.0470-2785.2 LD2785 | Brake System: Lucas / TRW 25683 20,4 Wear Warning Contact: prepared for wear indicator / incl. wear warning contact Ceramic |



| | | | | | |
|--|--------------------------|--|--|------------------------------|--|
| | kW | | | | |
| CUPRA - LEON (KL1) 09/20→ | | | | | |
|  Brake Pad Set, disc brake | | | | | |
| 1.4 e-HYBRID | 110 - 09/20→ 150 | | for PR number: 1ZK; Fitting Position: Front Axle | 13.0470-2785.2 LD2785 | Brake System: Lucas / TRW 25683 20,4 Wear Warning Contact: prepared for wear indicator / incl. wear warning contact Ceramic |
| 2.0 TSI | 180 - 06/21→ 221 | | | | |
| VZ 1.4 e-HYBRID | 180 09/20→ | | | | |
| CUPRA - LEON Sportstourer (KL8) 09/20→ | | | | | |
|  Brake Pad Set, disc brake | | | | | |
| 1.4 e-HYBRID | 110 - 09/20→ 150 | | for PR number: 1ZK; Fitting Position: Front Axle | 13.0470-2785.2 LD2785 | Brake System: Lucas / TRW 25683 20,4 Wear Warning Contact: prepared for wear indicator / incl. wear warning contact Ceramic |
| 2.0 TSI | 180 - 06/21→ 221 | | | | |
| VZ 1.4 e-HYBRID | 180 09/20→ | | | | |
| DS - DS 3 (SA_) 04/15→07/19 | | | | | |
|  Brake Disc | | | | | |
| 1.2 THP 110 / PureTech 110 | 81 04/15→07/19 | | Fitting Position: Front Axle | 24.0122-0194.1 422194 | Outer diameter [mm]: 266 Brake Disc Thickness [mm] 22 Minimum thickness [mm] 20 Brake Disc Type: Vented Supplementary Article/Info 2: with bolts/screws |
| 1.2 THP 130 | 96 09/15→07/19 | | | | |
| 1.2 VTi 82 | 60 04/15→07/19 | | | | |
| 1.4 HDi 70 | 50 07/15→12/16 | | | | |
| 1.6 BlueHDi 100 | 73 04/15→07/19 | | | | |
| 1.6 BlueHDi 116 | 85 07/15→07/19 | | | | |
| 1.6 BlueHDi 120 | 88 07/15→07/19 | | | | |
| 1.6 BlueHDi 75 | 55 07/15→07/19 | | | | |
| 1.6 THP 120 | 110 - 07/15→07/19 120 | | | | |
| 1.6 THP 165 | 121 07/15→07/19 | | | | |
| 1.6 THP 208 | 153 09/15→07/19 | | | | |
| DS - DS 3 Convertible (SB_) 07/15→07/19 | | | | | |
|  Brake Disc | | | | | |
| 1.2 THP 110 | 81 07/15→07/19 | | Fitting Position: Front Axle | 24.0122-0194.1 422194 | Outer diameter [mm]: 266 Brake Disc Thickness [mm] 22 Minimum thickness [mm] 20 Brake Disc Type: Vented Supplementary Article/Info 2: with bolts/screws |
| 1.2 THP 130 | 96 09/15→07/19 | | | | |
| 1.2 VTi 82 | 60 07/15→07/19 | | | | |
| 1.6 BlueHDi 100 | 73 07/15→07/19 | | | | |
| 1.6 BlueHDi 116 | 85 07/15→07/19 | | | | |
| 1.6 BlueHDi 120 | 88 07/15→07/19 | | | | |
| 1.6 THP 120 | 110 - 07/15→07/19 120 | | | | |
| 1.6 THP 165 | 121 07/15→07/19 | | | | |
| 1.6 THP 208 | 153 09/15→07/19 | | | | |
| DS - DS 3 CROSSBACK (UR_, UC_, UJ_) 10/18→ | | | | | |
|  Brake Pad Set, disc brake | | | | | |
| E-TENSE | 100 05/19→ | | Fitting Position: Rear Axle | 13.0460-3871.2 603871 | Brake System: Bosch 25839 17,8 Wear Warning Contact: not prepared for wear indicator / excl. wear warning contact Supplementary Article/Supple- mentary Info: with accessories |
| | | | | 13.0470-3871.2 LD3871 | Brake System: Bosch 25839 17,8 Wear Warning Contact: not prepared for wear indicator / excl. wear warning contact Supplementary Article/Supple- mentary Info: with accessories Ceramic |
| DS - DS 4 II (F_, FB_, F3_) 10/21→ | | | | | |
|  Brake Pad Set, disc brake | | | | | |
| BlueHDi 130 | 96 10/21→ | | for brake disc diameter [mm]: 330; Fitting Position: Front Axle | 13.0460-3876.2 603876 | Brake System: Bosch 22218 18,3 Wear Warning Contact: prepared for wear indicator / excl. wear warning contact Supplementary Article/Supple- mentary Info: with accessories |
| E-TENSE 225 | 133 - 10/21→ 165 | | | | |
| PureTech 130 | 96 10/21→ | | | | |
| PureTech 180 | 133 10/21→ | | | | |
| PureTech 225 | 165 10/21→ | | | | |
| | | | for brake disc diameter [mm]: 268; Fitting Position: Rear Axle | 13.0460-3871.2 603871 | Brake System: Bosch 25839 17,8 Wear Warning Contact: not prepared for wear indicator / excl. wear warning contact Supplementary Article/Supple- mentary Info: with accessories |
| → | | | | | |



| | kW | | | |
|--|--|--|------------------------------|---|
| DS - DS 4 II (F_, FB_, F3_) 10/21→ | | | | |
|  Brake Pad Set, disc brake | | | | |
| BlueHDi 130 E-TENSE 225 | 96 10/21→ 133 - 10/21→ 165 | for brake disc diameter [mm]: 268; Fitting Position: Rear Axle | 13.0470-3871.2 LD3871 | Brake System: Bosch 25839 17,8 Wear Warning Contact: not prepared for wear indicator / excl. wear warning contact Supplementary Article/Supplementary Info: with accessories Ceramic |
| PureTech 130 PureTech 180 PureTech 225 | 96 10/21→ 133 10/21→ 165 10/21→ | | | |
| | | for brake disc diameter [mm]: 290; Fitting Position: Rear Axle | 13.0460-3872.2 603872 | Brake System: Bosch 25827 17,7 Wear Warning Contact: not prepared for wear indicator / excl. wear warning contact Supplementary Article/Supplementary Info: with accessories |
| | | | 13.0470-3872.2 LD3872 | Brake System: Bosch 25827 17,7 Wear Warning Contact: not prepared for wear indicator / excl. wear warning contact Supplementary Article/Supplementary Info: with accessories Ceramic |
|  Brake Disc | | | | |
| BlueHDi 130 E-TENSE 225 | 96 10/21→ 133 - 10/21→ 165 | Fitting Position: Front Axle | 24.0128-0269.1 428269 | Outer diameter [mm]: 304 Brake Disc Thickness [mm] 28 Minimum thickness [mm] 26 Brake Disc Type: Vented Supplementary Article/Info 2: with bolts/screws |
| PureTech 130 PureTech 180 PureTech 225 | 96 10/21→ 133 10/21→ 165 10/21→ | | 24.0130-0241.1 430241 | Outer diameter [mm]: 330 Brake Disc Thickness [mm] 30 Minimum thickness [mm] 28 Brake Disc Type: Vented Supplementary Article/Info 2: with bolts/screws |
| | | Fitting Position: Rear Axle | 24.0112-0211.1 412211 | Outer diameter [mm]: 268 Brake Disc Thickness [mm] 12 Minimum thickness [mm] 10 Brake Disc Type: Solid Supplementary Article/Info 2: with bolts/screws |
| | | | 24.0112-0212.1 412212 | Outer diameter [mm]: 290 Brake Disc Thickness [mm] 12 Minimum thickness [mm] 10 Brake Disc Type: Solid Supplementary Article/Info 2: with bolts/screws |
| DS - DS 7 Crossback (J_) 09/17→ | | | | |
|  Brake Pad Set, disc brake | | | | |
| 1.5 BlueHDi 130 1.6 PureTech 165 1.6 PureTech 180 1.6 PureTech 225 2.0 BlueHDi 180 2.0 HDi 180 | 96 09/17→ 121 07/18→ 133 04/18→ 165 09/17→ 130 09/17→ 132 07/18→ | for brake disc diameter [mm]: 330; Fitting Position: Front Axle | 13.0460-3876.2 603876 | Brake System: Bosch 22218 18,3 Wear Warning Contact: prepared for wear indicator / excl. wear warning contact Supplementary Article/Supplementary Info: with accessories |
| E-TENSE E-TENSE 225 E-TENSE 4x4 PureTech 130 | 133 - 10/19→ 147 133 - 05/21→ 165 147 - 05/19→ 221 96 10/18→ | Fitting Position: Rear Axle | 13.0460-3872.2 603872 | Brake System: Bosch 25827 17,7 Wear Warning Contact: not prepared for wear indicator / excl. wear warning contact Supplementary Article/Supplementary Info: with accessories |
| | | | 13.0470-3872.2 LD3872 | Brake System: Bosch 25827 17,7 Wear Warning Contact: not prepared for wear indicator / excl. wear warning contact Supplementary Article/Supplementary Info: with accessories Ceramic |
|  Brake Disc | | | | |
| 1.5 BlueHDi 130 1.6 PureTech 165 1.6 PureTech 180 1.6 PureTech 225 2.0 BlueHDi 180 2.0 HDi 180 E-TENSE | 96 09/17→ 121 07/18→ 133 04/18→ 165 09/17→ 130 09/17→ 132 07/18→ 133 - 10/19→ 147 | Fitting Position: Front Axle | 24.0128-0269.1 428269 | Outer diameter [mm]: 304 Brake Disc Thickness [mm] 28 Minimum thickness [mm] 26 Brake Disc Type: Vented Supplementary Article/Info 2: with bolts/screws |
| → | | | | |



| | kW | | | | |
|--|---------------------|---|--|------------------------------|---|
| DS - DS 7 Crossback (J_) 09/17→ | | | | | |
|  Brake Disc | | | | | |
| E-TENSE 225 | 133 - 05/21→ 165 | Fitting Position: Front Axle | | 24.0130-0241.1 430241 | Outer diameter [mm]: 330 Brake Disc Thickness [mm] 30 Minimum thickness [mm] 28 Brake Disc Type: Vented Supplementary Article/Info 2: with bolts/screws |
| E-TENSE 4x4 | 147 - 05/19→ 221 | | | | |
| PureTech 130 | 96 10/18→ | | | | |
| | | Fitting Position: Rear Axle | | 24.0112-0212.1 412212 | Outer diameter [mm]: 290 Brake Disc Thickness [mm] 12 Minimum thickness [mm] 10 Brake Disc Type: Solid Supplementary Article/Info 2: with bolts/screws |
| DS - DS 9 (X2_) 09/20→ | | | | | |
|  Brake Pad Set, disc brake | | | | | |
| 1.6 E-TENSE 225 | 133 - 09/20→ 165 | Fitting Position: Front Axle | | 13.0460-3876.2 603876 | Brake System: Bosch 22218 18,3 Wear Warning Contact: prepared for wear indicator / excl. wear warning contact Supplementary Article/Supplementary Info: with accessories |
| E-TENSE 360 4x4 | 147 06/21→ | | | | |
| | | Fitting Position: Rear Axle | | 13.0460-3872.2 603872 | Brake System: Bosch 25827 17,7 Wear Warning Contact: not prepared for wear indicator / excl. wear warning contact Supplementary Article/Supplementary Info: with accessories |
| | | | | 13.0470-3872.2 LD3872 | Brake System: Bosch 25827 17,7 Wear Warning Contact: not prepared for wear indicator / excl. wear warning contact Supplementary Article/Supplementary Info: with accessories Ceramic |
| 1.6 PureTech 225 | 165 09/20→ | Fitting Position: Front Axle | | 13.0460-3876.2 603876 | Brake System: Bosch 22218 18,3 Wear Warning Contact: prepared for wear indicator / excl. wear warning contact Supplementary Article/Supplementary Info: with accessories |
| E-TENSE 360 4x4 | 265 06/21→ | Fitting Position: Front Axle | | 13.0460-3876.2 603876 | Brake System: Bosch 22218 18,3 Wear Warning Contact: prepared for wear indicator / excl. wear warning contact Supplementary Article/Supplementary Info: with accessories |
| | | | | | |
| | | Fitting Position: Rear Axle | | 13.0460-3872.2 603872 | Brake System: Bosch 25827 17,7 Wear Warning Contact: not prepared for wear indicator / excl. wear warning contact Supplementary Article/Supplementary Info: with accessories |
|  Brake Disc | | | | | |
| 1.6 E-TENSE 225 | 133 - 09/20→ 165 | Fitting Position: Front Axle | | 24.0130-0241.1 430241 | Outer diameter [mm]: 330 Brake Disc Thickness [mm] 30 Minimum thickness [mm] 28 Brake Disc Type: Vented Supplementary Article/Info 2: with bolts/screws |
| E-TENSE 360 4x4 | 147 - 06/21→ 265 | | | | |
| | | Fitting Position: Rear Axle | | 24.0112-0212.1 412212 | Outer diameter [mm]: 290 Brake Disc Thickness [mm] 12 Minimum thickness [mm] 10 Brake Disc Type: Solid Supplementary Article/Info 2: with bolts/screws |
| 1.6 PureTech 225 | 165 09/20→ | Fitting Position: Front Axle | | 24.0130-0241.1 430241 | Outer diameter [mm]: 330 Brake Disc Thickness [mm] 30 Minimum thickness [mm] 28 Brake Disc Type: Vented Supplementary Article/Info 2: with bolts/screws |
| FIAT - 500 (312_) 07/07→ | | | | | |
|  Cable Pull, parking brake | | | | | |
| 0.9 | 44 - 07/10→ 63 | Brake Type: Drum Brake; Fitting Position: Right Rear | | 24.3727-0671.2 580671 | Length [mm]: 1,450 |



| | | | | | |
|--|---------------------|---|-------------------------|--|--|
| | kW | | | | |
| FIAT - 500 (312_) 07/07→ | | | | | |
|  Cable Pull, parking brake | | | | | |
| 1.2 | 51 07/07→ | Brake Type: Drum Brake; Fitting Position: Right Rear | 24.3727-0671.2 580671 | Length [mm]: 1,450 | |
| 1.2 LPG | 51 12/10→ | | | | |
| 1.3 D Multijet | 55 - 10/07→ 70 | | | | |
| FIAT - 500 C (312_) 09/09→ | | | | | |
|  Cable Pull, parking brake | | | | | |
| 0.9 | 44 - 09/09→ 63 | Brake Type: Disc Brake; Fitting Position: Right Rear | 24.3727-0671.2 580671 | Length [mm]: 1,450 | |
| 1.2 | 51 09/09→ | | | | |
| 1.3 D Multijet | 55 - 09/09→ 70 | | | | |
| FIAT - DOBLO Bus (263_) 11/09→ | | | | | |
| Spring, brake caliper | | | | | |
| 1.3 D Multijet | 66 - 02/10→ 70 | for brake disc diameter [mm]: 305; Required quantity: 2; Fitting Position: Front Axle | 2 11.8116-0237.1 390509 | Brake System: ATE | |
| 1.4 | 70 - 02/10→ 88 | | | | |
| 1.4 Natural Power | 88 02/10→ | | | | |
| 1.6 D Multijet | 66 - 01/10→ 88 | | | | |
| 2.0 D Multijet | 99 01/10→ | | | | |
| | | | | | |
| FIAT - DOBLO Cargo (263_) 02/10→ | | | | | |
| Spring, brake caliper | | | | | |
| 1.3 D Multijet | 55 - 02/10→ 70 | for brake disc diameter [mm]: 305; Required quantity: 2; Fitting Position: Front Axle | 2 11.8116-0237.1 390509 | Brake System: ATE | |
| 1.4 | 70 - 02/10→ 88 | | | | |
| 1.4 Natural Power | 88 06/10→ | | | | |
| 1.6 D Multijet | 66 - 02/10→ 88 | | | | |
| 2.0 D Multijet | 99 02/10→ | | | | |
| | | | | | |
| FIAT - DOBLO Platform/Chassis (263_) 02/10→ | | | | | |
| Spring, brake caliper | | | | | |
| 1.3 D Multijet | 55 - 02/10→ 70 | for brake disc diameter [mm]: 305; Required quantity: 2; Fitting Position: Front Axle | 2 11.8116-0237.1 390509 | Brake System: ATE | |
| 1.4 | 70 - 04/10→ 88 | | | | |
| 1.4 Natural Power | 88 06/10→ | | | | |
| 1.6 D Multijet | 66 - 02/10→ 88 | | | | |
| 2.0 D Multijet | 99 02/10→ | | | | |
| | | | | | |
| FORD - KA 01/08→ | | | | | |
|  Cable Pull, parking brake | | | | | |
| 1.0 | 46 - 10/08→ 48 | Brake Type: Drum Brake; Fitting Position: Right Rear | 24.3727-0671.2 580671 | Length [mm]: 1,450 | |
| | | | | | |
| FORD - KA (RU8) 10/08→05/16 | | | | | |
|  Cable Pull, parking brake | | | | | |
| 1.2 | 51 10/08→05/16 | Brake Type: Drum Brake; Fitting Position: Right Rear | 24.3727-0671.2 580671 | Length [mm]: 1,450 | |
| 1.3 TDCi | 55 10/08→05/16 | | | | |
| HYUNDAI - GRAND SANTA FÉ 01/13→ | | | | | |
|  Brake Pad Set, disc brake | | | | | |
| 2.2 CRDi All-wheel Drive | 145 06/13→ | Fitting Position: Rear Axle | 13.0470-5633.2 LD5633 | Brake System: Akebono Wear Warning Contact: with acoustic wear warning Supplementary Article/Supple- mentary Info: with accessories Ceramic | |
| 3.0 GDi All-wheel Drive | 183 - 07/13→ 194 | | | | |
| 3.3 | 183 - 01/14→ 199 | | | | |
| 3.3 All-wheel Drive | 199 02/14→ | | | | |
| 3.3 GDi All-wheel Drive | 210 07/13→ | | | | |
| 2.2 CRDi All-wheel Drive | 147 09/13→ | Construction year from: 10/15 →; Fitting Position: Rear Axle | 13.0470-5633.2 LD5633 | Brake System: Akebono Wear Warning Contact: with acoustic wear warning Supplementary Article/Supple- mentary Info: with accessories Ceramic | |

| | kW | | | |
|--|-------------------|---|------------------------------|--|
| HYUNDAI - KONA (OS, OSE, OSI) 06/17→ | | | | |
| Accessory Kit, disc brake pad | | | | |
| 1.0 T-GDi | 88 07/17→ | Fitting Position: Front Axle | 13.0460-0530.2 610530 | |
| 1.0 T-GDi Hybrid 48V | 88 11/20→ | | | |
| 1.6 CRDi | 85 08/18→ | | | |
| 1.6 CRDi e-VGT | 100 07/17→ | | | |
| 1.6 CRDi e-VGT AWD | 100 08/18→ | | | |
| 1.6 CRDi Hybrid 48V | 100 11/20→ | | | |
| 1.6 CRDi Hybrid 48V 4WD | 100 11/20→ | | | |
| 1.6 GDi Hybrid | 77 - 06/19→ | | | |
| | 104 | | | |
| 1.6 T-GDi | 130 - 07/17→ | | | |
| | 146 | | | |
| 1.6 T-GDi 4WD | 130 - 06/17→ | | | |
| | 146 | | | |
| EV | 100 - 04/18→ | | | |
| | 150 | | | |
| HYUNDAI - KONA SUV Van (OS, OSE, OSI) 06/17→ | | | | |
| Accessory Kit, disc brake pad | | | | |
| 1.0 T-GDi | 88 07/17→ | Fitting Position: Front Axle | 13.0460-0530.2 610530 | |
| 1.6 GDi Hybrid | 77 - 06/19→ | | | |
| | 104 | | | |
| EV | 150 04/18→ | | | |
| HYUNDAI - SANTA FÉ II (CM) 01/05→03/15 | | | | |
|  Brake Pad Set, disc brake | | | | |
| 2.0 CRDi | 110 12/10→12/12 | → Construction year to: 08/12; Fitting Position: Rear Axle | 13.0470-5633.2 LD5633 | Brake System: Akebono Wear Warning Contact: with acoustic wear warning Supplementary Article/Supplementary Info: with accessories Ceramic |
| 2.0 CRDi 4x4 | 85 - 03/06→12/12 | Fitting Position: Rear Axle | 13.0470-5633.2 LD5633 | Brake System: Akebono Wear Warning Contact: with acoustic wear warning Supplementary Article/Supplementary Info: with accessories Ceramic |
| | 135 | | | |
| 2.2 CRDi | 145 - 01/09→12/12 | | | |
| | 147 | | | |
| 2.2 CRDi 4x4 | 145 - 01/09→12/12 | | | |
| | 147 | | | |
| 2.4 | 128 11/10→12/12 | | | |
| 2.4 4x4 | 128 07/10→12/12 | | | |
| 3.5 4x4 | 203 - 07/10→12/12 | | | |
| | 210 | | | |
| HYUNDAI - SANTA FÉ II SUV Van (CM) 10/05→03/15 | | | | |
|  Brake Pad Set, disc brake | | | | |
| CRDi | 145 01/09→05/13 | Fitting Position: Rear Axle | 13.0470-5633.2 LD5633 | Brake System: Akebono Wear Warning Contact: with acoustic wear warning Supplementary Article/Supplementary Info: with accessories Ceramic |
| CRDi 4x4 | 145 01/09→05/13 | | | |
| HYUNDAI - SANTA FÉ III (DM, DMA) 09/12→ | | | | |
|  Brake Pad Set, disc brake | | | | |
| 2.0 CRDi | 110 - 09/12→ | Fitting Position: Rear Axle | 13.0470-5633.2 LD5633 | Brake System: Akebono Wear Warning Contact: with acoustic wear warning Supplementary Article/Supplementary Info: with accessories Ceramic |
| | 136 | | | |
| 2.0 CRDi 4WD | 110 - 09/12→ | | | |
| | 136 | | | |
| 2.2 CRDi | 145 - 09/12→ | | | |
| | 147 | | | |
| 2.2 CRDi 4WD | 145 - 09/12→ | | | |
| | 149 | | | |
| 2.2 CRDi AWD | 142 07/18→ | | | |
| 2.4 | 141 09/12→12/15 | | | |
| 2.4 4WD | 141 09/12→ | | | |
| 2.4 CCVT | 126 - 09/12→ | | | |
| | 129 | | | |
| 2.4 CCVT AWD | 126 - 09/12→ | | | |
| | 129 | | | |
| 2.4 GDI | 138 05/15→ | | | |
| 2.4 GDI 4WD | 138 05/15→ | | | |
| 3.0 GDI 4WD | 194 01/13→ | | | |
| 3.3 | 199 03/14→ | | | |
| 3.3 4WD | 199 03/14→ | | | |



| | | | | |
|--|------------------|--|------------------------------|--|
| | kw | | | |
| HYUNDAI - SANTA FÉ III SUV Van (DM) 09/12→ | | | | |
|  Brake Pad Set, disc brake | | | | |
| CRDi 4x4 | 145 05/15→ | Construction year from: 10/15 →; Fitting Position: Rear Axle | 13.0470-5633.2 LD5633 | Brake System: Akebono Wear Warning Contact: with acoustic wear warning Supplementary Article/Supple- mentary Info: with accessories Ceramic |
| HYUNDAI - TUCSON (TL, TLE) 05/15→ | | | | |
| Accessory Kit, disc brake pad | | | | |
| 1.6 CRDi | 85 - 08/18→ | Rim Size [in]: 16; Fitting Position: Front Axle | 13.0460-0530.2 610530 | |
| 1.6 CRDi All-wheel Drive | 85 - 08/18→ | | | |
| 1.6 CRDi All-wheel Drive | 100 | | | |
| 1.6 CRDi hybrid 48V | 85 - 03/19→ | | | |
| 1.6 CRDi hybrid 48V | 100 | | | |
| 1.6 CRDi hybrid 48V All-wheel Drive | 100 03/19→ | | | |
| 2.0 CRDi Hybrid 48V All-wheel Drive | 136 10/18→ | | | |
| 2.4 GDI All-wheel Drive | 135 07/19→09/20 | | | |
| 1.6 GDi | 96 - 06/15→09/20 | Rim Size [in]: 16; → Construction year to: 05/18; Fitting Position: Front Axle | 13.0460-0530.2 610530 | |
| 2.0 | 115 06/15→09/20 | | | |
| 1.6 T-GDi | 130 06/15→09/20 | Vehicle Production Country: Czech Republic; → Construction year to: 05/18; Fitting Position: Front Axle | 13.0460-0530.2 610530 | |
| 1.6 T-GDi All-wheel Drive | 130 06/15→09/20 | | | |
| 2.0 | 114 06/15→09/20 | | | |
| 2.0 All-wheel Drive | 114 06/15→09/20 | | | |
| 2.0 CRDi All-wheel Drive | 136 06/15→09/20 | | | |
| 1.7 CRDi | 85 - 06/15→09/20 | Fitting Position: Front Axle | 13.0460-0530.2 610530 | |
| 2.0 All-wheel Drive | 104 | | | |
| 2.0 All-wheel Drive | 115 06/15→09/20 | | | |
| 2.0 CRDi | 136 06/15→09/20 | | | |
| 2.0 CVVT | 110 06/15→09/20 | | | |
| 2.0 GDi All-wheel Drive | 122 09/15→09/20 | | | |
| 2.0 CRDi | 100 06/15→09/20 | Vehicle Production Country: Czech Republic; Fitting Position: Front Axle | 13.0460-0530.2 610530 | |
| 2.0 CRDi All-wheel Drive | 100 06/15→09/20 | → Construction year to: 05/18; Fitting Position: Front Axle | 13.0460-0530.2 610530 | |
| 2.0 CVVT All-wheel Drive | 110 06/15→09/20 | | | |
| HYUNDAI - TUCSON SUV Van (TLE) 05/15→ | | | | |
| Accessory Kit, disc brake pad | | | | |
| 1.6 CRDi | 100 08/18→ | Rim Size [in]: 16; Fitting Position: Front Axle | 13.0460-0530.2 610530 | |
| 1.6 T-GDi | 130 06/15→ | → Construction year to: 08/15; Fitting Position: Front Axle | 13.0460-0530.2 610530 | |
| JAGUAR - F-PACE (X761) 09/15→ | | | | |
|  Brake Caliper | | | | |
| 2.0 D165 MHEV | 120 10/20→ | not for brake caliper colour: Black; → Vehicle Identification Number to: LA999999; Fitting Position: Rear Axle Left | 24.6240-7001.5 241315 | Brake System: ATE Supplementary Article/Supple- mentary Info: with electric motor / without holder Brake Caliper Type: Fist-type Caliper / Brake caliper with adjusting element for electr. handbrake |
| 2.0 D200 MHEV | 150 10/20→ | | | |
| 2.0 P400e Plug-in Hybrid | 221 - 10/20→ | | | |
| 2.0 SD4 AWD | 297 | | | |
| 2.0 TD4 | 177 02/17→ | | | |
| 2.0 TD4 | 120 - 09/15→ | | | |
| 2.0 TD4 AWD | 132 | | | |
| 2.0 Ti4 | 132 09/15→ | | | |
| 2.0 Ti4 | 177 - 05/16→ | | | |
| 2.0 Ti4 AWD | 184 | not for brake caliper colour: Black; → Vehicle Identification Number to: LA999999; Fitting Position: Rear Axle Right | 24.6240-7002.5 241316 | Brake System: ATE Supplementary Article/Supple- mentary Info: with electric motor / without holder Brake Caliper Type: Fist-type Caliper / Brake caliper with adjusting element for electr. handbrake |
| 3.0 D300 MHEV | 184 - 02/17→ | | | |
| 3.0 D300 MHEV | 221 | | | |
| 3.0 D300 MHEV | 221 10/20→ | | | |
| 3.0 P400 MHEV | 294 10/20→ | | | |
| 3.0 SCV6 AWD | 250 - 09/15→ | | | |
| 3.0 SDV6 AWD | 280 | | | |
| 3.0 SDV6 AWD | 221 09/15→ | | | |





| | kW | | | | |
|--|---------------------|--|--|------------------------------|---|
| JAGUAR - XE (X760) 03/15→ | | | | | |
|  Brake Caliper | | | | | |
| 2.0 | 147 - 03/15→ 177 | Brake Size: 17"; Fitting Position: Rear Axle Left | | 24.6240-7001.5 241315 | Brake System: ATE Supplementary Article/Supplementary Info: with electric motor / without holder Brake Caliper Type: Fist-type Caliper / Brake caliper with adjusting element for electr. handbrake |
| 2.0 D | 120 - 03/15→ 132 | | | | |
| 2.0 D AWD | 132 - 10/15→ 177 | Brake Size: 17"; Fitting Position: Rear Axle Right | | 24.6240-7002.5 241316 | Brake System: ATE Supplementary Article/Supplementary Info: with electric motor / without holder Brake Caliper Type: Fist-type Caliper / Brake caliper with adjusting element for electr. handbrake |
| | | | | | |
| 2.0 | 184 02/17→ | Brake Size: 17"; → Vehicle Identification Number to: LCP99999; Fitting Position: Rear Axle Left | | 24.6240-7001.5 241315 | Brake System: ATE Supplementary Article/Supplementary Info: with electric motor / without holder Brake Caliper Type: Fist-type Caliper / Brake caliper with adjusting element for electr. handbrake |
| 2.0 AWD | 184 02/17→ | | | | |
| | | Brake Size: 17"; → Vehicle Identification Number to: LCP99999; Fitting Position: Rear Axle Right | | 24.6240-7002.5 241316 | Brake System: ATE Supplementary Article/Supplementary Info: with electric motor / without holder Brake Caliper Type: Fist-type Caliper / Brake caliper with adjusting element for electr. handbrake |
| | | | | | |
| 2.0 | 221 06/17→ | not for brake caliper colour: Black; → Vehicle Identification Number to: LCP99999; Fitting Position: Rear Axle Left | | 24.6240-7001.5 241315 | Brake System: ATE Supplementary Article/Supplementary Info: with electric motor / without holder Brake Caliper Type: Fist-type Caliper / Brake caliper with adjusting element for electr. handbrake |
| 2.0 AWD | 221 06/17→ | | | | |
| | | not for brake caliper colour: Black; → Vehicle Identification Number to: LCP99999; Fitting Position: Rear Axle Right | | 24.6240-7002.5 241316 | Brake System: ATE Supplementary Article/Supplementary Info: with electric motor / without holder Brake Caliper Type: Fist-type Caliper / Brake caliper with adjusting element for electr. handbrake |
| | | | | | |
| 3.0 S | 250 - 03/15→ 280 | Fitting Position: Rear Axle Left | | 24.6240-7001.5 241315 | Brake System: ATE Supplementary Article/Supplementary Info: with electric motor / without holder Brake Caliper Type: Fist-type Caliper / Brake caliper with adjusting element for electr. handbrake |
| | | Fitting Position: Rear Axle Right | | 24.6240-7002.5 241316 | Brake System: ATE Supplementary Article/Supplementary Info: with electric motor / without holder Brake Caliper Type: Fist-type Caliper / Brake caliper with adjusting element for electr. handbrake |
| JAGUAR - XF II (X260) 05/15→ | | | | | |
|  Brake Caliper | | | | | |
| 2.0 | 147 - 05/15→ 177 | Fitting Position: Rear Axle Left | | 24.6240-7001.5 241315 | Brake System: ATE Supplementary Article/Supplementary Info: with electric motor / without holder Brake Caliper Type: Fist-type Caliper / Brake caliper with adjusting element for electr. handbrake |
| 2.0 D | 132 - 05/15→ 177 | | | | |
| 2.0 D AWD | 132 - 03/16→ 177 | Fitting Position: Rear Axle Left | | 24.6240-7001.5 241315 | Brake System: ATE Supplementary Article/Supplementary Info: with electric motor / without holder Brake Caliper Type: Fist-type Caliper / Brake caliper with adjusting element for electr. handbrake |
| 3.0 | 250 - 05/15→ 280 | | | | |
| 3.0 AWD | 250 - 07/15→ 280 | | | | |
| → | | | | | |



| | kW | | | |
|--|---------------------|---|------------------------------|---|
| JAGUAR - XF II (X260) 05/15→ | | | | |
|  Brake Caliper | | | | |
| 2.0 | 147 - 05/15→ 177 | Fitting Position: Rear Axle Right | 24.6240-7002.5 241316 | Brake System: ATE Supplementary Article/Supplementary Info: with electric motor / without holder Brake Caliper Type: Fist-type Caliper / Brake caliper with adjusting element for electr. handbrake |
| 2.0 D | 132 - 05/15→ 177 | | | |
| 2.0 D AWD | 132 - 03/16→ 177 | | | |
| 3.0 | 250 - 05/15→ 280 | | | |
| 3.0 AWD | 250 - 07/15→ 280 | | | |
| 2.0 | 184 - 03/17→ 221 | not for brake caliper colour: Black; → Vehicle Identification Number to: LCY99999; | 24.6240-7001.5 241315 | Brake System: ATE Supplementary Article/Supplementary Info: with electric motor / without holder Brake Caliper Type: Fist-type Caliper / Brake caliper with adjusting element for electr. handbrake |
| 2.0 AWD | 184 - 03/17→ 221 | Fitting Position: Rear Axle Left | | |
| | | not for brake caliper colour: Black; → Vehicle Identification Number to: LCY99999; | 24.6240-7002.5 241316 | Brake System: ATE Supplementary Article/Supplementary Info: with electric motor / without holder Brake Caliper Type: Fist-type Caliper / Brake caliper with adjusting element for electr. handbrake |
| | | Fitting Position: Rear Axle Right | | |
| 2.0 D | 120 05/15→ | Brake Size: 17"; Fitting Position: Rear Axle Left | 24.6240-7001.5 241315 | Brake System: ATE Supplementary Article/Supplementary Info: with electric motor / without holder Brake Caliper Type: Fist-type Caliper / Brake caliper with adjusting element for electr. handbrake |
| | | Brake Size: 17"; Fitting Position: Rear Axle Right | | |
| 3.0 D | 221 05/15→ | not for brake caliper colour: Black; Fitting Position: Rear Axle Left | 24.6240-7001.5 241315 | Brake System: ATE Supplementary Article/Supplementary Info: with electric motor / without holder Brake Caliper Type: Fist-type Caliper / Brake caliper with adjusting element for electr. handbrake |
| | | not for brake caliper colour: Black; Fitting Position: Rear Axle Right | | |
| JAGUAR - XF SPORTBRAKE (X260) 07/17→ | | | | |
|  Brake Caliper | | | | |
| 2.0 | 147 07/17→ | Fitting Position: Rear Axle Left | 24.6240-7001.5 241315 | Brake System: ATE Supplementary Article/Supplementary Info: with electric motor / without holder Brake Caliper Type: Fist-type Caliper / Brake caliper with adjusting element for electr. handbrake |
| 2.0 D | 132 07/17→ | | | |
| 2.0 D AWD | 132 - 07/17→ 177 | | | |
| 3.0 | 280 07/17→ | | | |
| 3.0 AWD | 280 07/17→ | | | |
| | | Fitting Position: Rear Axle Right | 24.6240-7002.5 241316 | Brake System: ATE Supplementary Article/Supplementary Info: with electric motor / without holder Brake Caliper Type: Fist-type Caliper / Brake caliper with adjusting element for electr. handbrake |
| | | | | |
| → | | | | |



| | kW | | | |
|--|--|---|------------------------------|---|
| JAGUAR - XF SPORTBRAKE (X260) 07/17→ | | | | |
|  Brake Caliper | | | | |
| 2.0 2.0 AWD | 184 07/17→ 184 - 08/18→ 221 | not for brake caliper colour: Black; → Vehicle Identification Number to: LCY99999; Fitting Position: Rear Axle Left | 24.6240-7001.5 241315 | Brake System: ATE Supplementary Article/Supplementary Info: with electric motor / without holder Brake Caliper Type: Fist-type Caliper / Brake caliper with adjusting element for electr. handbrake |
| | | not for brake caliper colour: Black; → Vehicle Identification Number to: LCY99999; Fitting Position: Rear Axle Right | 24.6240-7002.5 241316 | Brake System: ATE Supplementary Article/Supplementary Info: with electric motor / without holder Brake Caliper Type: Fist-type Caliper / Brake caliper with adjusting element for electr. handbrake |
| 2.0 D | 120 07/17→ | Brake Size: 17"; Fitting Position: Rear Axle Left | 24.6240-7001.5 241315 | Brake System: ATE Supplementary Article/Supplementary Info: with electric motor / without holder Brake Caliper Type: Fist-type Caliper / Brake caliper with adjusting element for electr. handbrake |
| | | Brake Size: 17"; Fitting Position: Rear Axle Right | 24.6240-7002.5 241316 | Brake System: ATE Supplementary Article/Supplementary Info: with electric motor / without holder Brake Caliper Type: Fist-type Caliper / Brake caliper with adjusting element for electr. handbrake |
| 3.0 D | 221 07/17→ | not for brake caliper colour: Black; Fitting Position: Rear Axle Left | 24.6240-7001.5 241315 | Brake System: ATE Supplementary Article/Supplementary Info: with electric motor / without holder Brake Caliper Type: Fist-type Caliper / Brake caliper with adjusting element for electr. handbrake |
| | | not for brake caliper colour: Black; Fitting Position: Rear Axle Right | 24.6240-7002.5 241316 | Brake System: ATE Supplementary Article/Supplementary Info: with electric motor / without holder Brake Caliper Type: Fist-type Caliper / Brake caliper with adjusting element for electr. handbrake |
| KIA - SORENTO II (XM) 09/09→04/16 | | | | |
|  Brake Pad Set, disc brake | | | | |
| 2.0 CRDi 2.0 CRDi 4WD 2.2 CRDi 4WD 2.4 CVVT 2.4 CVVT 4WD 2.4 GDI 2.4 GDI 4WD | 110 11/10→12/15 110 11/10→12/15 145 - 11/09→12/15 147 128 - 11/09→12/15 141 128 - 11/09→12/15 141 141 10/12→12/15 141 10/12→12/15 | → Construction year to: 12/14; Fitting Position: Rear Axle | 13.0470-5633.2 LD5633 | Brake System: Akebono Wear Warning Contact: with acoustic wear warning Supplementary Article/Supplementary Info: with accessories Ceramic |
| 2.2 CRDi 2.4 2.4 AWD 2.4 LPG 2.4 LPG 4WD 3.5 3.5 4WD | 145 - 11/09→12/15 147 130 09/10→12/12 130 09/10→12/12 126 04/10→12/15 126 04/10→12/15 203 - 11/09→12/15 204 203 - 11/09→12/15 206 | Fitting Position: Rear Axle | 13.0470-5633.2 LD5633 | Brake System: Akebono Wear Warning Contact: with acoustic wear warning Supplementary Article/Supplementary Info: with accessories Ceramic |







| | | | | |
|---|---|---|------------------------------|--|
| | kW | | | |
| KIA - SORENTO II SUV Van (XM) 06/09→12/15 | | | | |
|  Brake Pad Set, disc brake | | | | |
| CRDi | 145 11/09→12/15 | Fitting Position: Rear Axle | 13.0470-5633.2 LD5633 | Brake System: Akebono Wear Warning Contact: with acoustic wear warning Supplementary Article/Supplementary Info: with accessories Ceramic |
| CRDi 4WD CVVT CVVT 4WD | 145 11/09→12/15 128 06/09→12/15 128 06/09→12/15 | → Construction year to: 12/14; Fitting Position: Rear Axle | 13.0470-5633.2 LD5633 | Brake System: Akebono Wear Warning Contact: with acoustic wear warning Supplementary Article/Supplementary Info: with accessories Ceramic |
| KIA - SPORTAGE II (JE_, KM) 09/04→ | | | | |
| Accessory Kit, disc brake pad | | | | |
| 2.0 16V 4WD 2.0 CRDi 2.0 CRDi 4WD | 104 09/04→ 100 01/06→05/10 83 - 09/04→ 100 | Construction year from: 01/08 →; Fitting Position: Front Axle | 13.0460-0530.2 610530 | |
| 2.0 i 16V 2.7 V6 4WD | 104 09/04→ 129 09/04→ | | | |
| 2.0 CRDi 2.0 CRDi 4WD | 83 - 02/05→ 103 103 01/06→ | Construction year from: 01/08 → → Construction year to: 05/10; Fitting Position: Front Axle | 13.0460-0530.2 610530 | |
| 2.0 CRDi | 110 09/07→ | → Construction year to: 05/10; Vehicle Production Country: Slovakia; Fitting Position: Front Axle | 13.0460-0530.2 610530 | |
| 2.0 CRDi 4WD | 110 09/08→05/10 | Vehicle Production Country: Slovakia; Fitting Position: Front Axle | 13.0460-0530.2 610530 | |
| KIA - SPORTAGE II VAN (KM_) 09/04→ | | | | |
| Accessory Kit, disc brake pad | | | | |
| 2.0 CRDi 2.0 CRDi 4WD | 110 09/08→05/10 110 09/08→05/10 | Vehicle Production Country: Slovakia; Fitting Position: Front Axle | 13.0460-0530.2 610530 | |
| KIA - SPORTAGE III (SL) 09/09→ | | | | |
| Accessory Kit, disc brake pad | | | | |
| 1.6 GDI 1.7 CRDi 2.0 CRDi | 99 02/11→ 85 12/10→ 100 - 07/10→ 135 | → Construction year to: 12/15; Fitting Position: Front Axle | 13.0460-0530.2 610530 | |
| 2.0 CRDi AWD 2.0 CVVT 2.0 CVVT AWD | 100 - 07/10→ 135 120 - 07/10→ 122 120 - 07/10→ 122 | | | |
| 2.0 CVVT Flex 2.0 GDI | 131 02/12→12/16 122 - 09/13→ 194 | | | |
| 2.0 GDI AWD 2.4 i AWD | 122 02/14→ 130 08/10→ | | | |
| 1.6 LPG 2.0 CVVT 2.0 CVVT AWD | 99 01/14→12/15 110 06/10→12/13 110 06/10→12/13 | Fitting Position: Front Axle | 13.0460-0530.2 610530 | |
| 2.0 CVVT 2.0 CVVT AWD 2.0 CVVT Flex AWD | 110 - 01/14→12/15 113 110 - 01/14→12/15 113 131 01/12→ | Vehicle Production Country: Slovakia; Fitting Position: Front Axle | 13.0460-0530.2 610530 | |
| KIA - SPORTAGE IV (QL, QLE) 09/15→ | | | | |
| Accessory Kit, disc brake pad | | | | |
| 1.6 CRDi 1.6 CRDi AWD 1.6 CRDi Eco-Dynamics + 1.6 CRDi Eco-Dynamics + AWD 1.6 LPG 2.0 CRDi Eco-Dynamics + AWD | 85 - 07/18→ 100 100 07/18→ 85 - 03/19→ 100 100 03/19→ 93 07/20→ 136 06/18→ | Rim Size [in]: 16; Fitting Position: Front Axle | 13.0460-0530.2 610530 | |
| 1.6 GDI 1.6 T-GDI 1.6 TGDI AWD 2.0 AWD → | 97 09/15→ 130 09/15→ 130 09/15→ 110 12/15→ | → Construction year to: 04/18; Rim Size [in]: 16; Fitting Position: Front Axle | 13.0460-0530.2 610530 | |





| | | | | | |
|--|-------------------------|--|---|--|---|
| | kW | | | | |
| KIA - SPORTAGE IV (QL, QLE) 09/15→ | | | | | |
| Accessory Kit, disc brake pad | | | | | |
| 2.0 CRDi AWD | 100 - 09/15→ 136 | | → Construction year to: 04/18; Rim Size [in]: 16; Fitting Position: Front Axle | | 13.0460-0530.2 610530 |
| 1.7 CRDi | 85 - 09/15→ 104 | | → Construction year to: 04/18; Fitting Position: Front Axle | | 13.0460-0530.2 610530 |
| 2.0 | 114 - 12/15→ 115 | | | | |
| 2.0 Alcohol | 114 12/15→ | | | | |
| 2.0 CRDi | 100 09/15→ | | | | |
| 2.0 | 110 12/15→ | | Fitting Position: Front Axle | | 13.0460-0530.2 610530 |
| 2.4 GDI | 135 05/16→ | | | | |
| 2.4 GDI AWD | 135 09/15→ | | | | |
| 2.0 AWD | 114 12/15→ | | Vehicle Production Country: Slovakia; → Construction year to: 04/18; Rim Size [in]: 16; Fitting Position: Front Axle | | 13.0460-0530.2 610530 |
| 2.0 CRDi | 136 09/15→ | | Vehicle Production Country: Slovakia; → Construction year to: 04/18; Fitting Position: Front Axle | | 13.0460-0530.2 610530 |
| 2.0 CRDi AWD | 131 - 09/15→ 134 | | | | |
| KIA - SPORTAGE IV VAN (QL, QLE) 09/15→ | | | | | |
| Accessory Kit, disc brake pad | | | | | |
| 1.6 CRDi Eco-Dynamics + | 100 03/19→ | | Rim Size [in]: 16; Fitting Position: Front Axle | | 13.0460-0530.2 610530 |
| 1.6 CRDi Eco-Dynamics + All-wheel Drive | 100 03/19→ | | | | |
| 1.6 T-GDI | 130 05/18→ | | → Construction year to: 05/18; Rim Size [in]: 16; Fitting Position: Front Axle | | 13.0460-0530.2 610530 |
| MAZDA - 3 (BM, BN) 07/13→ | | | | | |
|  Brake Caliper | | | | | |
| 1.5 | 74 - 09/13→05/19 88 | | Vehicle Equipment: for vehicles without electric parking brake; Fitting Position: Rear Axle Left | | 24.3367-0441.5 241373 Brake System: ATE Supplementary Article/Supple- mentary Info: without holder Brake Caliper Type: Fist-type Caliper |
| 1.5 D | 77 02/16→05/19 | | | | |
| 1.6 | 77 09/13→05/19 | | | | |
| 2.0 | 88 - 07/13→05/19 121 | | | | |
| 2.2 D | 110 09/13→05/19 | | Vehicle Equipment: for vehicles without electric parking brake; Fitting Position: Rear Axle Right | | 24.3367-0442.5 241374 Brake System: ATE Supplementary Article/Supple- mentary Info: without holder Brake Caliper Type: Fist-type Caliper |
| Accessory Kit, disc brake pad | | | | | |
| 1.5 | 74 - 09/13→05/19 88 | | Fitting Position: Front Axle | | 13.0460-0531.2 610531 |
| 1.5 D | 77 02/16→05/19 | | | | |
| 1.6 | 77 09/13→05/19 | | | | |
| 2.0 | 88 - 07/13→05/19 121 | | | | |
| 2.2 D | 110 09/13→05/19 | | | | |
| MAZDA - 3 Hatchback Van (BM) 04/15→05/16 | | | | | |
|  Brake Caliper | | | | | |
| 1.5 | 74 04/15→05/16 | | Vehicle Equipment: for vehicles without electric parking brake; Fitting Position: Rear Axle Left | | 24.3367-0441.5 241373 Brake System: ATE Supplementary Article/Supple- mentary Info: without holder Brake Caliper Type: Fist-type Caliper |
| 2.0 | 88 - 04/15→05/16 121 | | | | |
| 2.2 D | 110 04/15→05/16 | | Vehicle Equipment: for vehicles without electric parking brake; Fitting Position: Rear Axle Right | | 24.3367-0442.5 241374 Brake System: ATE Supplementary Article/Supple- mentary Info: without holder Brake Caliper Type: Fist-type Caliper |
| Accessory Kit, disc brake pad | | | | | |
| 1.5 | 74 04/15→05/16 | | Fitting Position: Front Axle | | 13.0460-0531.2 610531 |
| 2.0 | 88 - 04/15→05/16 121 | | | | |
| 2.2 D | 110 04/15→05/16 | | | | |





| | | | | | |
|--|-------------------------|--|--|------------------------------|---|
| | kW | | | | |
| MAZDA - 3 Saloon (BM_, BN_) 09/13→12/19 | | | | | |
|  Brake Caliper | | | | | |
| 1.5 | 74 - 10/13→05/19 88 | Vehicle Equipment: for vehicles without electric parking brake; Fitting Position: Rear Axle Left | | 24.3367-0441.5 241373 | Brake System: ATE Supplementary Article/Supplementary Info: without holder Brake Caliper Type: Fist-type Caliper |
| 1.5 D | 77 06/16→05/19 | | | | |
| 1.6 | 77 09/13→05/19 | | | | |
| 2.0 | 88 - 09/13→05/19 121 | | | | |
| 2.2 D | 110 09/13→05/19 | Vehicle Equipment: for vehicles without electric parking brake; Fitting Position: Rear Axle Right | | 24.3367-0442.5 241374 | Brake System: ATE Supplementary Article/Supplementary Info: without holder Brake Caliper Type: Fist-type Caliper |
| Accessory Kit, disc brake pad | | | | | |
| 1.5 | 74 - 10/13→05/19 88 | Fitting Position: Front Axle | | 13.0460-0531.2 610531 | |
| 1.5 D | 77 06/16→05/19 | | | | |
| 1.6 | 77 09/13→05/19 | | | | |
| 2.0 | 88 - 09/13→05/19 121 | | | | |
| 2.2 D | 110 09/13→05/19 | | | | |
| MAZDA - CX-3 (DK) 01/15→ | | | | | |
| Accessory Kit, disc brake pad | | | | | |
| 1.5 SKYACTIV-D | 77 02/15→01/18 | Fitting Position: Front Axle | | 13.0460-0531.2 610531 | |
| 1.5 SKYACTIV-D AWD | 77 02/15→01/18 | | | | |
| 1.8 SKYACTIV-D | 85 02/18→ | | | | |
| 1.8 SKYACTIV-D AWD | 85 02/18→ | | | | |
| 2.0 SKYACTIV-G | 88 - 05/15→ 110 | | | | |
| 2.0 SKYACTIV-G AWD | 109 - 05/15→ 110 | | | | |
| MERCEDES-BENZ - A-CLASS (W177) 03/18→ | | | | | |
|  Brake Pad Set, disc brake | | | | | |
| AMG A 35 4-matic | 225 09/18→ | not for SA code: U29; Fitting Position: Front Axle | | 13.0460-4705.2 604705 | Brake System: Brembo Wear Warning Contact: prepared for wear indicator / excl. wear warning contact |
| AMG A 45 4-matic+ | 285 07/19→ | Brake Caliper Colour: Grey; not for SA code: U29; | | 13.0460-4705.2 604705 | Brake System: Brembo Wear Warning Contact: prepared for wear indicator / excl. wear warning contact |
| AMG A 45 S 4-matic+ | 310 07/19→ | Fitting Position: Front Axle | | | |
|  Brake Disc | | | | | |
| A 160 | 80 06/18→ | Braking System: for vehicles without sports brake system; Fitting Position: Rear Axle | | 24.0111-0193.1 411193 | Outer diameter [mm]: 276 Brake Disc Thickness [mm] 11 Minimum thickness [mm] 9.3 Brake Disc Type: Solid Supplementary Article/Info 2: with bolts/screws |
| A 160 d | 70 05/19→ | | | | |
| A 180 | 100 06/18→ | | | | |
| A 180 d | 85 03/18→ | | | | |
| A 200 d | 110 11/18→ | | | | |
| A 200 | 110 - 03/18→ 120 | Vehicle Equipment: for vehicles without AMG sports package; Braking System: for vehicles without sports brake system; | | 24.0111-0193.1 411193 | Outer diameter [mm]: 276 Brake Disc Thickness [mm] 11 Minimum thickness [mm] 9.3 Brake Disc Type: Solid Supplementary Article/Info 2: with bolts/screws |
| A 200 4-matic | 120 10/20→ | Fitting Position: Rear Axle | | | |
| A 200 d 4-matic | 110 10/19→ | | | | |
| A 220 d | 140 11/18→ | | | | |
| MERCEDES-BENZ - A-CLASS Saloon (V177) 09/18→ | | | | | |
|  Brake Pad Set, disc brake | | | | | |
| AMG A 35 4-matic | 225 03/19→ | not for SA code: U29; Fitting Position: Front Axle | | 13.0460-4705.2 604705 | Brake System: Brembo Wear Warning Contact: prepared for wear indicator / excl. wear warning contact |
|  Brake Disc | | | | | |
| A 160 d | 70 10/19→ | Braking System: for vehicles without sports brake system; Fitting Position: Rear Axle | | 24.0111-0193.1 411193 | Outer diameter [mm]: 276 Brake Disc Thickness [mm] 11 Minimum thickness [mm] 9.3 Brake Disc Type: Solid Supplementary Article/Info 2: with bolts/screws |
| A 180 | 100 04/19→ | | | | |
| A 180 d | 85 09/18→ | | | | |
| A 200 | 110 - 09/18→ 120 | | | | |
| A 200 d | 110 08/19→ | | | | |







| | kW | | | | |
|--|---|--|--|--------------------------------|---|
| MERCEDES-BENZ - B-CLASS Sports Tourer (W247) 12/18→ | | | | | |
|  Brake Disc | | | | | |
| B 160 B 160 d B 180 B 180 d B 200 d | 80 04/19→ 70 05/19→ 100 12/18→ 85 12/18→ 110 12/18→ | Braking System: for vehicles without sports brake system; Fitting Position: Rear Axle | | 24.0111-0193.1 411193 | Outer diameter [mm]: 276 Brake Disc Thickness [mm] 11 Minimum thickness [mm] 9.3 Brake Disc Type: Solid Supplementary Article/Info 2: with bolts/screws |
| B 180 d | 85 10/20→ | Braking System: for vehicles without sports brake system; Special Purpose Vehicle: not for government vehicles; Fitting Position: Rear Axle | | 24.0111-0193.1 411193 | Outer diameter [mm]: 276 Brake Disc Thickness [mm] 11 Minimum thickness [mm] 9.3 Brake Disc Type: Solid Supplementary Article/Info 2: with bolts/screws |
| MERCEDES-BENZ - C-CLASS (W205) 07/13→ | | | | | |
|  Brake Hose | | | | | |
| C 160 C 180 C 180 BlueTEC / d C 200 4-matic C 200 BlueTEC / d C 200 d C 220 BlueTEC / d C 220 d 4-matic C 250 C 250 BlueTEC / d C 250 BlueTEC / d 4-matic C 300 C 300 BlueTEC Hybrid / h C 350 e C 400 4-matic | 95 04/15→ 110 - 03/14→ 115 85 05/14→05/18 135 04/15→08/18 100 05/14→05/18 100 10/15→05/18 120 - 02/14→05/18 125 125 04/15→05/18 155 03/14→05/18 150 02/14→05/18 150 02/14→05/18 180 09/15→08/18 150 05/14→05/18 155 - 02/15→08/18 205 245 10/14→ | Required quantity: 2; for vehicles with Airmatic DC; Fitting Position: Front Axle | | 2 24.5104-0471.3 331642 | Length [mm]: 470 |
| C 160 C 180 C 180 d C 200 C 200 d C 200 EQ Boost C 220 d C 300 C 300 d C 300 de C 300 e C 300 EQ Boost | 95 06/19→ 115 06/19→ 90 05/18→ 150 08/19→ 110 - 05/18→ 118 135 04/18→ 143 05/18→ 183 - 05/18→ 190 180 06/18→ 143 - 05/19→ 225 155 - 07/19→ 235 190 05/19→ | for vehicles with Airmatic DC; Suspension: for vehicles with electronic suspension control; Required quantity: 2; Fitting Position: Front Axle | | 2 24.5104-0471.3 331642 | Length [mm]: 470 |
| C 200 | 135 12/13→08/18 | Construction year from: 02/14 →; Required quantity: 2; for vehicles with Airmatic DC; Fitting Position: Front Axle | | 2 24.5104-0471.3 331642 | Length [mm]: 470 |
| C 200 4-matic C 200 EQ Boost 4-matic C 220 d 4-matic C 300 4-matic C 300 d 4-matic C 300 e 4-matic C 300 EQ Boost 4-matic | 150 08/19→ 135 04/18→ 143 05/18→ 180 - 12/13→ 190 180 06/18→ 155 - 07/19→ 235 190 05/19→ | Required quantity: 2; Fitting Position: Front Axle | | 2 24.5104-0471.3 331642 | Length [mm]: 470 |
| MERCEDES-BENZ - C-CLASS Convertible (A205) 06/16→ | | | | | |
|  Brake Hose | | | | | |
| C 180 C 200 C 200 4-matic C 220 d C 250 C 250 d C 300 | 115 06/16→ 135 06/16→05/18 135 06/16→05/18 120 - 06/16→05/18 125 155 06/16→05/18 150 06/16→05/18 180 06/16→05/18 | Required quantity: 2; for vehicles with Airmatic DC; Fitting Position: Front Axle | | 2 24.5104-0471.3 331642 | Length [mm]: 470 |
| C 180 C 200 C 200 d C 200 EQ Boost C 220 d | 115 06/19→ 150 08/19→ 118 07/18→ 135 05/18→ 143 04/18→ | for vehicles with Airmatic DC; Suspension: for vehicles with electronic suspension control; Required quantity: 2; Fitting Position: Front Axle | | 2 24.5104-0471.3 331642 | Length [mm]: 470 |







| | kW | | | | |
|---|--|---|---|-----------------------|------------------|
| MERCEDES-BENZ - C-CLASS Convertible (A205) 06/16→ | | | | | |
|  Brake Hose | | | | | |
| C 300 C 300 d C 300 EQ Boost | 190 05/18→ 180 07/18→ 190 05/19→ | for vehicles with Airmatic DC; Suspension: for vehicles with electronic suspension control; Required quantity: 2; Fitting Position: Front Axle | 2 | 24.5104-0471.3 331642 | Length [mm]: 470 |
| C 200 EQ Boost 4-matic C 220 d 4-matic C 300 EQ Boost 4-matic C 400 4-matic | 135 05/18→ 125 - 06/16→ 143 190 05/19→ 245 06/16→ | Required quantity: 2; Fitting Position: Front Axle | 2 | 24.5104-0471.3 331642 | Length [mm]: 470 |
| MERCEDES-BENZ - C-CLASS Coupe (C205) 10/15→ | | | | | |
|  Brake Hose | | | | | |
| C 180 C 200 C 220 d C 250 C 250 d C 300 | 110 - 10/15→ 115 135 10/15→05/18 120 - 10/15→05/18 125 155 10/15→05/18 150 10/15→05/18 180 10/15→12/18 | Required quantity: 2; for vehicles with Airmatic DC; Fitting Position: Front Axle | 2 | 24.5104-0471.3 331642 | Length [mm]: 470 |
| C 180 C 200 d C 200 EQ Boost C 220 d C 300 C 300 d C 300 EQ Boost | 115 06/19→ 118 07/18→ 135 05/18→ 143 04/18→ 190 05/18→ 180 07/18→ 190 05/19→ | for vehicles with Airmatic DC; Suspension: for vehicles with electronic suspension control; Required quantity: 2; Fitting Position: Front Axle | 2 | 24.5104-0471.3 331642 | Length [mm]: 470 |
| C 200 4-matic C 200 EQ Boost 4-matic C 220 d 4-matic C 250 d 4-matic C 300 4-matic C 300 d 4-matic C 300 EQ Boost 4-matic C 400 4-matic | 135 04/16→05/18 135 05/18→ 125 - 04/16→ 143 150 04/16→05/18 190 05/18→ 180 07/18→ 190 05/19→ 245 04/16→ | Required quantity: 2; Fitting Position: Front Axle | 2 | 24.5104-0471.3 331642 | Length [mm]: 470 |
| MERCEDES-BENZ - C-CLASS T-Model (S205) 09/14→ | | | | | |
|  Brake Hose | | | | | |
| C 160 C 180 C 180 BlueTEC / d C 200 C 200 BlueTEC / d C 200 d C 220 BlueTEC / d C 250 C 250 BlueTEC / d C 300 C 300 BlueTEC Hybrid / h C 350 e C 400 4-matic | 95 04/15→ 115 09/14→ 85 09/14→05/18 135 09/14→05/18 100 09/14→05/18 100 10/15→05/18 120 - 09/14→05/18 125 155 09/14→05/18 150 09/14→05/18 180 09/15→05/18 150 10/14→05/18 155 - 02/15→05/18 205 245 10/14→ | Required quantity: 2; for vehicles with Airmatic DC; Fitting Position: Front Axle | 2 | 24.5104-0471.3 331642 | Length [mm]: 470 |
| C 160 C 180 C 180 d C 200 d C 200 EQ Boost C 220 d C 300 C 300 d C 300 de C 300 e C 300 EQ Boost | 95 06/19→ 115 06/19→ 90 05/18→ 110 - 05/18→ 118 135 04/18→ 143 04/18→ 190 05/18→ 180 06/18→ 143 - 05/19→ 225 155 - 07/19→ 235 190 05/19→ | for vehicles with Airmatic DC; Suspension: for vehicles with electronic suspension control; Required quantity: 2; Fitting Position: Front Axle | 2 | 24.5104-0471.3 331642 | Length [mm]: 470 |
| C 200 4-matic C 200 EQ Boost 4-matic C 220 d 4-matic C 250 BlueTEC / d 4- matic C 300 4-matic C 300 d 4-matic C 300 EQ Boost 4-matic | 135 04/15→05/18 135 04/18→ 125 - 04/15→ 143 150 10/14→05/18 190 05/18→ 180 06/18→ 190 05/19→ | Required quantity: 2; Fitting Position: Front Axle | 2 | 24.5104-0471.3 331642 | Length [mm]: 470 |





| | | | | | |
|--|---|---|------------------------------|---|--|
| | kW | | | | |
| MERCEDES-BENZ - CLA (C118) 03/19→ | | | | | |
|  Brake Pad Set, disc brake | | | | | |
| AMG CLA 35 4-matic | 225 04/19→ | not for SA code: U29; Fitting Position: Front Axle | 13.0460-4705.2 604705 | Brake System: Brembo Wear Warning Contact: prepared for wear indicator / excl. wear warning contact | |
| AMG CLA 45 4-matic+ AMG CLA 45 S 4-matic+ | 285 07/19→ 310 07/19→ | Brake Caliper Colour: Grey; not for SA code: U29; Fitting Position: Front Axle | 13.0460-4705.2 604705 | Brake System: Brembo Wear Warning Contact: prepared for wear indicator / excl. wear warning contact | |
|  Brake Disc | | | | | |
| CLA 180 CLA 180 d | 100 03/19→ 85 03/19→ | Braking System: for vehicles without sports brake system; Fitting Position: Rear Axle | 24.0111-0193.1 411193 | Outer diameter [mm]: 276 Brake Disc Thickness [mm] 11 Minimum thickness [mm] 9.3 Brake Disc Type: Solid Supplementary Article/Info 2: with bolts/screws | |
| MERCEDES-BENZ - CLA Coupe (C117) 01/13→03/19 | | | | | |
|  Brake Pad Set, disc brake | | | | | |
| CLA 220 4-matic | 135 04/16→03/19 | Vehicle Equipment: for vehicles with sports package / for vehicles with AMG Sports Package; Fitting Position: Rear Axle | 13.0470-2634.2 LD2634 | Brake System: Lucas / TRW Wear Warning Contact: prepared for wear indicator / excl. wear warning contact Supplementary Article/Supplementary Info: with accessories Ceramic | |
| CLA 250 4-matic | 155 - 07/13→03/19 160 | Fitting Position: Rear Axle | 13.0470-2634.2 LD2634 | Brake System: Lucas / TRW Wear Warning Contact: prepared for wear indicator / excl. wear warning contact Supplementary Article/Supplementary Info: with accessories Ceramic | |
| MERCEDES-BENZ - CLA Shooting Brake (X117) 01/15→03/19 | | | | | |
|  Brake Pad Set, disc brake | | | | | |
| CLA 220 4-matic CLA 220 d 4-matic CLA 250 4-matic | 135 04/16→03/19 125 07/18→03/19 155 - 01/15→03/19 160 | Fitting Position: Rear Axle | 13.0470-2634.2 LD2634 | Brake System: Lucas / TRW Wear Warning Contact: prepared for wear indicator / excl. wear warning contact Supplementary Article/Supplementary Info: with accessories Ceramic | |
| MERCEDES-BENZ - CLA Shooting Brake (X118) 06/19→ | | | | | |
|  Brake Pad Set, disc brake | | | | | |
| AMG CLA 35 4-matic | 225 06/19→ | not for SA code: U29; Fitting Position: Front Axle | 13.0460-4705.2 604705 | Brake System: Brembo Wear Warning Contact: prepared for wear indicator / excl. wear warning contact | |
| AMG CLA 45 4-matic+ AMG CLA 45 S 4-matic+ | 285 07/19→ 310 07/19→ | Brake Caliper Colour: Grey; not for SA code: U29; Fitting Position: Front Axle | 13.0460-4705.2 604705 | Brake System: Brembo Wear Warning Contact: prepared for wear indicator / excl. wear warning contact | |
| MERCEDES-BENZ - CLS (C218) 01/11→12/17 | | | | | |
|  Brake Pad Set, disc brake | | | | | |
| CLS 350 CLS 350 BlueTEC / d CLS 350 BlueTEC / d 4-matic CLS 350 CDI / d CLS 350 CDI / d 4-matic CLS 350 d 4-matic | 225 01/11→08/14 185 - 02/13→12/17 190 185 02/13→12/17 195 01/11→08/14 195 09/11→08/14 190 04/15→12/17 | Vehicle Equipment: for vehicles with sports package / for vehicles with AMG Sports Package; Fitting Position: Front Axle | 13.0460-4863.2 604863 | Brake System: Brembo 24976 17,5 Wear Warning Contact: prepared for wear indicator / excl. wear warning contact | |
| CLS 400 CLS 400 4-matic | 245 05/14→12/17 245 05/14→12/17 | Fitting Position: Front Axle | 13.0460-4863.2 604863 | Brake System: Brembo 24976 17,5 Wear Warning Contact: prepared for wear indicator / excl. wear warning contact | |







| | kW | | | | |
|--|--------------------------|---|------------------------------|--|------------------|
| MERCEDES-BENZ - CLS (C257) 12/17→ | | | | | |
|  Brake Hose | | | | | |
| AMG CLS 53 EQ Boost 4-matic+ | 320 05/18→ | Required quantity: 2; Fitting Position: Front Axle | 2 | 24.5104-0471.3 331642 | Length [mm]: 470 |
| CLS 300 d 4-matic | 195 04/21→ | | | | |
| CLS 350 d 4-matic | 183 - 12/17→ 210 | | | | |
| CLS 350 EQ Boost 4-matic | 220 08/18→ | | | | |
| CLS 400 d 4-matic | 243 - 12/17→ 250 | | | | |
| CLS 450 EQ Boost 4-matic | 270 12/17→ | | | | |
| CLS 220 d | 143 06/18→ | for vehicles with Airmatic DC; | 2 | 24.5104-0471.3 331642 | Length [mm]: 470 |
| CLS 300 d | 180 04/18→ | Suspension: for vehicles with electronic | | | |
| CLS 350 d | 210 08/18→ | suspension control; Required quantity: 2; | | | |
| CLS 350 EQ Boost | 220 08/18→ | Fitting Position: Front Axle | | | |
| MERCEDES-BENZ - CLS Shooting Brake (X218) 10/12→12/17 | | | | | |
|  Brake Pad Set, disc brake | | | | | |
| CLS 350 | 225 10/12→08/14 | Vehicle Equipment: for vehicles with | 13.0460-4863.2 604863 | Brake System: Brembo 24976 | |
| CLS 350 BlueTEC / d | 185 - 05/14→12/17 190 | sports package; Fitting Position: Front Axle | | 17,5 Wear Warning Contact: prepared | |
| CLS 350 BlueTEC / d 4-matic | 185 05/14→12/17 | | | for wear indicator / excl. wear | |
| CLS 350 CDI / d | 195 10/12→08/14 | | | warning contact | |
| CLS 350 CDI / d 4-matic | 195 10/12→08/14 | | | | |
| CLS 350 d 4-matic | 190 04/15→12/17 | | | | |
| CLS 400 | 245 05/14→12/17 | Fitting Position: Front Axle | 13.0460-4863.2 604863 | Brake System: Brembo 24976 | |
| CLS 400 4-matic | 245 05/14→12/17 | | | 17,5 Wear Warning Contact: prepared | |
| | | | | for wear indicator / excl. wear | |
| | | | | warning contact | |
| MERCEDES-BENZ - E-CLASS (W212) 01/09→12/16 | | | | | |
|  Brake Pad Set, disc brake | | | | | |
| E 350 BlueTEC | 185 - 01/13→12/15 190 | Vehicle Equipment: for vehicles with | 13.0460-4863.2 604863 | Brake System: Brembo 24976 | |
| E 350 BlueTEC 4-matic | 185 - 01/13→12/15 190 | sports package / for vehicles with AMG | | 17,5 Wear Warning Contact: prepared | |
| E 350 CDI | 195 03/11→12/15 | Sports Package; Fitting Position: Front Axle | | for wear indicator / excl. wear | |
| E 400 | 245 01/13→12/16 | Fitting Position: Front Axle | 13.0460-4863.2 604863 | Brake System: Brembo 24976 | |
| E 400 4-matic | 245 01/13→12/16 | | | 17,5 Wear Warning Contact: prepared | |
| E 500 | 285 01/09→12/11 | | | for wear indicator / excl. wear | |
| E 500 4-matic | 285 01/09→12/11 | | | warning contact | |
| MERCEDES-BENZ - E-CLASS (W213) 01/16→ | | | | | |
|  Brake Hose | | | | | |
| 2.0 E 220 d | 147 02/22→ | for vehicles with Airmatic DC; | 2 | 24.5104-0471.3 331642 | Length [mm]: 470 |
| E 200 | 145 10/18→ | Suspension: for vehicles with electronic | | | |
| E 200 d | 118 11/18→ | suspension control; Required quantity: 2; | | | |
| E 200 EQ Boost | 145 06/19→ | Fitting Position: Front Axle | | | |
| E 300 | 190 04/19→ | | | | |
| E 300 d | 180 12/17→ | | | | |
| E 300 de | 143 - 10/18→ 225 | | | | |
| E 300 e | 155 - 11/18→ 235 | | | | |
| E 300 EQ Boost | 190 06/19→ | | | | |
| E 350 d | 210 08/18→ | | | | |
| E 350 EQ Boost | 220 08/18→ | | | | |
| E 400 d | 250 12/18→ | | | | |
| 2.0 E 220 d 4-matic | 147 02/22→ | Required quantity: 2; | 2 | 24.5104-0471.3 331642 | Length [mm]: 470 |
| E 200 4-matic | 135 07/16→ | Fitting Position: Front Axle | | | |
| E 200 EQ Boost 4-matic | 145 06/19→ | | | | |
| E 220 d 4-matic | 120 - 10/16→ 143 | | | | |
| E 300 4-matic | 180 09/16→ | | | | |
| E 300 d 4-matic | 195 01/21→ | | | | |
| E 300 de 4-matic | 143 - 06/20→ 225 | | | | |
| E 300 e 4-matic | 155 - 07/20→ 235 | | | | |
| E 350 d 4-matic | 190 06/17→05/18 | | | | |
| E 400 4-matic | 245 07/16→ | | | | |
| E 400 d 4-matic | 243 - 04/18→ 250 | | | | |
| E 450 4-matic | 270 08/18→ | | | | |
| E 450 EQ Boost 4-matic | 270 07/20→ | | | | |
| → | | | | | |





| | kW | | | | |
|---|-----------------|--|---|---|--|
| MERCEDES-BENZ - E-CLASS (W213) 01/16→ | | | | | |
|  Brake Hose | | | | | |
| AMG E 43 4-matic | 295 07/16→ | | Required quantity: 2; for vehicles without Airmatic DC; | 2 | 24.5104-0471.3 331642 Length [mm]: 470 |
| AMG E 63 4-matic+ | 420 01/17→ | | Fitting Position: Front Axle | | |
| AMG E 63 S 4-matic+ | 450 01/17→ | | | | |
| AMG E 53 EQ Boost 4-matic+ | 320 04/18→ | | for vehicles without Airmatic DC; Suspension: for vehicles with electronic suspension control; Required quantity: 2; | 2 | 24.5104-0471.3 331642 Length [mm]: 470 |
| E 180 | 115 01/17→ | | Required quantity: 2; | 2 | 24.5104-0471.3 331642 Length [mm]: 470 |
| E 200 | 135 01/16→ | | for vehicles with Airmatic DC; | | |
| E 200 d | 110 07/16→ | | Fitting Position: Front Axle | | |
| E 220 d | 120 - 01/16→ | | | | |
| | 143 | | | | |
| E 250 | 155 07/16→ | | | | |
| E 300 | 180 - 07/16→ | | | | |
| | 190 | | | | |
| E 350 d | 190 01/16→05/18 | | | | |
| E 350 e | 155 - 07/16→ | | | | |
| | 235 | | | | |
| E 400 4-matic | 245 06/16→ | | Construction year from: 07/16 →; | 2 | 24.5104-0471.3 331642 Length [mm]: 470 |
| | | | Required quantity: 2; | | |
| | | | Fitting Position: Front Axle | | |
| MERCEDES-BENZ - E-CLASS All-Terrain (S213) 01/17→ | | | | | |
|  Brake Hose | | | | | |
| E 200 EQ Boost | 145 08/20→ | | Required quantity: 2; | 2 | 24.5104-0471.3 331642 Length [mm]: 470 |
| E 220 d 4-matic | 143 01/17→ | | Fitting Position: Front Axle | | |
| E 350 d 4-matic | 190 06/17→ | | | | |
| E 400 d 4-matic | 243 - 08/18→ | | | | |
| | 250 | | | | |
| E 450 EQ Boost | 270 08/20→ | | | | |
| MERCEDES-BENZ - E-CLASS Convertible (A238) 06/17→ | | | | | |
|  Brake Hose | | | | | |
| AMG E53 EQ Boost 4-matic+ | 320 05/18→ | | for vehicles without Airmatic DC; | 2 | 24.5104-0471.3 331642 Length [mm]: 470 |
| | | | Required quantity: 2; | | |
| | | | Fitting Position: Front Axle | | |
| E 200 | 135 06/17→ | | for vehicles with Airmatic DC; | 2 | 24.5104-0471.3 331642 Length [mm]: 470 |
| E 200 EQ Boost | 145 06/19→ | | Suspension: for vehicles with electronic suspension control; Required quantity: 2; | | |
| E 300 | 190 03/19→ | | Fitting Position: Front Axle | | |
| E 300 d | 180 05/18→ | | | | |
| E 300 EQ Boost | 190 06/19→ | | | | |
| E 350 d | 210 11/18→ | | | | |
| E 350 EQ Boost | 220 10/17→ | | | | |
| E 450 | 270 07/20→ | | | | |
| E 200 4-matic | 135 10/17→ | | Required quantity: 2; | 2 | 24.5104-0471.3 331642 Length [mm]: 470 |
| E 200 EQ Boost 4-matic | 145 06/19→ | | Fitting Position: Front Axle | | |
| E 220 d 4-matic | 143 10/17→ | | | | |
| E 300 d 4-matic | 195 04/21→ | | | | |
| E 350 d 4-matic | 190 06/17→ | | | | |
| E 400 d 4-matic | 243 - 08/18→ | | | | |
| | 250 | | | | |
| E 450 4-matic | 270 08/18→ | | | | |
| E 450 EQ Boost 4-matic | 270 07/20→ | | | | |
| E 220 d | 120 - 06/17→ | | Required quantity: 2; | 2 | 24.5104-0471.3 331642 Length [mm]: 470 |
| | 143 | | for vehicles with Airmatic DC; | | |
| E 300 | 180 06/17→ | | Fitting Position: Front Axle | | |
| MERCEDES-BENZ - E-CLASS Coupe (C238) 12/16→ | | | | | |
|  Brake Hose | | | | | |
| AMG E 53 EQ Boost 4-matic+ | 320 05/18→ | | for vehicles without Airmatic DC; | 2 | 24.5104-0471.3 331642 Length [mm]: 470 |
| | | | Required quantity: 2; | | |
| | | | Fitting Position: Front Axle | | |
| E 200 | 135 12/16→ | | Required quantity: 2; | 2 | 24.5104-0471.3 331642 Length [mm]: 470 |
| E 220 d | 143 12/16→ | | for vehicles with Airmatic DC; | | |
| E 300 | 180 12/16→ | | Fitting Position: Front Axle | | |
| E 200 4-matic | 135 06/17→ | | Required quantity: 2; | 2 | 24.5104-0471.3 331642 Length [mm]: 470 |
| E 200 EQ Boost 4-matic | 145 06/19→ | | Fitting Position: Front Axle | | |
| E 220 d 4-matic | 143 03/17→ | | | | |
| E 300 d 4-matic | 195 01/21→ | | | | |
| E 350 d 4-matic | 190 06/17→ | | | | |
| E 400 4-matic | 245 12/16→ | | | | |
| E 400 d 4-matic | 243 - 08/18→ | | | | |
| | 250 | | | | |
| E 450 4-matic | 270 08/18→ | | | | |
| E 450 EQ Boost 4-matic | 270 07/20→ | | | | |
| E 200 EQ Boost | 145 06/19→ | | for vehicles with Airmatic DC; | 2 | 24.5104-0471.3 331642 Length [mm]: 470 |
| E 220 d | 120 12/16→ | | Suspension: for vehicles with electronic | | |
| E 300 | 190 08/18→ | | | | |
| → | | | | | |





| | kW | | | | |
|--|--------------------------|---|---|--------------------------------|--|
| MERCEDES-BENZ - E-CLASS Coupe (C238) 12/16→ | | | | | |
|  Brake Hose | | | | | |
| E 300 d | 180 05/18→ | | suspension control; Required quantity: 2; | | |
| E 300 EQ Boost | 190 06/19→ | | Fitting Position: Front Axle | | |
| E 350 d | 210 11/18→ | | | | |
| E 350 EQ Boost | 220 10/17→ | | | | |
| E 450 | 270 07/20→ | | | | |
| MERCEDES-BENZ - E-CLASS T-Model (S212) 08/09→12/16 | | | | | |
|  Brake Pad Set, disc brake | | | | | |
| E 350 BlueTEC | 185 - 11/12→12/16 190 | Vehicle Equipment: for vehicles with sports package / for vehicles with AMG Sports Package; | | 13.0460-4863.2 604863 | Brake System: Brembo 24976 17,5 |
| E 350 BlueTEC 4-matic | 185 - 11/12→12/16 190 | Fitting Position: Front Axle | | | Wear Warning Contact: prepared for wear indicator / excl. wear warning contact |
| E 350 CDI | 195 07/11→12/13 | Vehicle Equipment: for vehicles with AMG Sports Package / for vehicles with sports package; | | 13.0460-4863.2 604863 | Brake System: Brembo 24976 17,5 |
| E 350 CDI 4-matic | 195 07/11→12/13 | Fitting Position: Front Axle | | | Wear Warning Contact: prepared for wear indicator / excl. wear warning contact |
| E 400 | 245 01/13→12/16 | Fitting Position: Front Axle | | 13.0460-4863.2 604863 | Brake System: Brembo 24976 17,5 |
| E 400 4-matic | 245 01/13→12/16 | | | | Wear Warning Contact: prepared for wear indicator / excl. wear warning contact |
| E 500 | 285 11/09→12/11 | | | | |
| MERCEDES-BENZ - E-CLASS T-Model (S213) 07/16→ | | | | | |
|  Brake Hose | | | | | |
| AMG E 43 4-matic | 295 10/16→ | Required quantity: 2; | | 2 24.5104-0471.3 331642 | Length [mm]: 470 |
| AMG E 53 EQ Boost 4-matic+ | 320 04/18→ | for vehicles without Airmatic DC; | | | |
| AMG E 63 4-matic+ | 420 05/17→ | Fitting Position: Front Axle | | | |
| AMG E 63 S 4-matic+ | 450 05/17→ | | | | |
| E 200 | 135 07/16→ | Required quantity: 2; | | 2 24.5104-0471.3 331642 | Length [mm]: 470 |
| E 200 d | 110 10/16→ | for vehicles with Airmatic DC; | | | |
| E 220 d | 120 - 07/16→ 143 | Fitting Position: Front Axle | | | |
| E 250 | 155 07/16→ | | | | |
| E 350 d | 190 10/16→ | | | | |
| E 200 4-matic | 135 01/17→ | Required quantity: 2; | | 2 24.5104-0471.3 331642 | Length [mm]: 470 |
| E 200 EQ Boost 4-matic | 145 06/19→ | Fitting Position: Front Axle | | | |
| E 220 d 4-matic | 143 01/17→ | | | | |
| E 300 d 4-matic | 195 01/21→ | | | | |
| E 300 de 4-matic | 143 - 08/20→ 225 | | | | |
| E 350 d 4-matic | 190 06/17→ | | | | |
| E 400 4-matic | 245 10/16→ | | | | |
| E 400 d 4-matic | 243 - 04/18→ 250 | | | | |
| E 450 4-matic | 270 08/18→ | | | | |
| E 450 EQ Boost | 270 08/20→ | | | | |
| E 200 d | 118 11/18→ | for vehicles with Airmatic DC; | | 2 24.5104-0471.3 331642 | Length [mm]: 470 |
| E 200 EQ Boost | 145 06/19→ | Suspension: for vehicles with electronic suspension control; Required quantity: 2; | | | |
| E 220 d | 143 - 09/20→ 147 | Fitting Position: Front Axle | | | |
| E 300 d | 180 12/17→ | | | | |
| E 300 de | 143 - 10/18→ 225 | | | | |
| E 300 e | 155 - 06/20→ 235 | | | | |
| E 300 EQ Boost | 190 06/19→ | | | | |
| E 350 d | 210 08/18→ | | | | |
| E 400 d | 250 02/19→ | | | | |
| MERCEDES-BENZ - EQV (W447) 06/20→ | | | | | |
|  Brake Hose | | | | | |
| EQV 250 | 150 11/21→ | Required quantity: 2; | | 2 24.5103-0456.3 331631 | Length [mm]: 456 |
| EQV 300 | 150 06/20→ | Fitting Position: Rear Axle | | | |
| MERCEDES-BENZ - eVITO Tourer (W447) 04/19→ | | | | | |
|  Brake Hose | | | | | |
| Electric | 85 - 04/19→ 150 | Required quantity: 2; | | 2 24.5103-0456.3 331631 | Length [mm]: 456 |
| | | Fitting Position: Rear Axle | | | |
| MERCEDES-BENZ - eVITO Van (W447) 03/19→ | | | | | |
|  Brake Hose | | | | | |
| Electric | 85 03/19→ | Required quantity: 2; | | 2 24.5103-0456.3 331631 | Length [mm]: 456 |
| | | Fitting Position: Rear Axle | | | |





| | | | | | |
|--|--|--|--|--------------------------------|--|
| | kW | | | | |
| MERCEDES-BENZ - GLA (H247) 02/20→ | | | | | |
|  Brake Pad Set, disc brake | | | | | |
| AMG GLA 35 4-matic | 225 06/20→ | | not for SA code: U29; Fitting Position: Front Axle | 13.0460-4705.2 604705 | Brake System: Brembo Wear Warning Contact: prepared for wear indicator / excl. wear warning contact |
| AMG GLA 45 4-matic+ AMG GLA 45 S 4-matic+ | 285 06/20→ 310 06/20→ | | Brake Caliper Colour: Grey; not for SA code: U29; Fitting Position: Front Axle | 13.0460-4705.2 604705 | Brake System: Brembo Wear Warning Contact: prepared for wear indicator / excl. wear warning contact |
| MERCEDES-BENZ - GLA-CLASS (X156) 12/13→ | | | | | |
|  Brake Pad Set, disc brake | | | | | |
| GLA 220 4-matic GLA 250 4-matic | 135 01/17→ 155 12/13→ | | Fitting Position: Rear Axle | 13.0470-2634.2 LD2634 | Brake System: Lucas / TRW Wear Warning Contact: prepared for wear indicator / excl. wear warning contact Supplementary Article/Supplementary Info: with accessories Ceramic |
| MERCEDES-BENZ - GLB (X247) 07/19→ | | | | | |
|  Brake Pad Set, disc brake | | | | | |
| AMG GLB 35 4-matic | 225 08/19→ | | not for SA code: U29; Fitting Position: Front Axle | 13.0460-4705.2 604705 | Brake System: Brembo Wear Warning Contact: prepared for wear indicator / excl. wear warning contact |
| MERCEDES-BENZ - MARCO POLO Camper (W447) 03/15→ | | | | | |
|  Brake Hose | | | | | |
| 160 CDI 170 CDI 180 CDI 200 CDI 200 CDI 4-matic 220 CDI 220 CDI 4-matic 250 CDI 250 CDI 4-matic 300 CDI 300 CDI 4-matic | 65 03/15→ 75 06/20→ 84 03/15→ 100 03/15→ 100 03/15→ 120 03/15→ 120 03/15→ 140 03/15→ 140 03/15→ 174 - 03/19→ 176 174 - 03/19→ 176 | | Required quantity: 2; Fitting Position: Rear Axle | 2 24.5103-0456.3 331631 | Length [mm]: 456 |
| MERCEDES-BENZ - SPRINTER 3,5-t Bus (B906) 06/06→ | | | | | |
|  Cable Pull, parking brake | | | | | |
| 309 CDI 310 CDI 311 CDI 311 CDI 4x4 313 CDI 313 CDI 4x4 314 CDI 314 CDI 4x4 315 CDI 315 CDI 4x4 316 316 CDI 316 CDI 4x4 316 LGT 316 NGT 318 CDI 318 CDI 4x4 319 CDI / BlueTEC 319 CDI / BlueTEC 4x4 324 | 65 04/12→ 70 03/09→12/13 80 - 06/06→ 84 80 02/08→12/09 95 08/11→05/16 95 08/11→05/16 105 05/16→ 105 05/16→ 110 06/06→ 110 02/08→12/09 115 09/08→ 120 08/11→ 120 08/11→ 115 09/08→ 115 03/09→ 135 02/08→12/09 135 02/08→12/09 140 03/09→ 140 03/09→ 190 06/06→12/13 | | Required quantity: 1; Wheelbase [mm]: 3,250; Vehicle Equipment: for vehicles without fold-down handbrake lever; Fitting Position: Front | 1 24.3727-0472.2 580472 | Length [mm]: 1,468 |
| MERCEDES-BENZ - SPRINTER 3,5-t Platform/Chassis (B906) 06/06→ | | | | | |
|  Cable Pull, parking brake | | | | | |
| 309 CDI 310 CDI 311 CDI 311 CDI 4x4 313 CDI 313 CDI 4x4 314 CDI → | 65 06/06→12/09 70 03/09→05/16 80 - 06/06→ 84 80 02/08→12/09 95 06/06→05/16 95 06/06→05/16 105 05/16→ | | Required quantity: 1; Wheelbase [mm]: 3,250; Vehicle Equipment: for vehicles without fold-down handbrake lever; Fitting Position: Front | 1 24.3727-0472.2 580472 | Length [mm]: 1,468 |





| | kW | | | | | | |
|--|-----------------|---|---|---|---|---|---|
| MERCEDES-BENZ - SPRINTER 3,5-t Platform/Chassis (B906) 06/06→ | | | | | | | |
|  Cable Pull, parking brake | | | | | | | |
| 314 CDI 4x4 | 105 05/16→ | Required quantity: 1; Wheelbase [mm]: 3,250; Vehicle Equipment: for vehicles without fold-down handbrake lever; Fitting Position: Front | 1 | 24.3727-0472.2 580472 Length [mm]: 1,468 | | | |
| 315 CDI | 110 06/06→12/09 | | | | | | |
| 315 CDI 4x4 | 110 02/08→12/09 | | | | | | |
| 316 | 115 09/08→ | | | | | | |
| 316 CDI | 120 03/09→ | | | | | | |
| 316 CDI 4x4 | 120 03/09→ | | | | | | |
| 316 LGT | 115 09/08→ | | | | | | |
| 316 NGT | 115 09/08→ | | | | | | |
| 318 CDI | 135 06/06→12/09 | | | | | | |
| 318 CDI 4x4 | 135 02/08→12/09 | | | | | | |
| 319 CDI / BlueTEC | 140 03/09→ | | | | | | |
| 319 CDI / BlueTEC 4x4 | 140 05/11→ | | | | | | |
| 324 | 190 06/06→12/13 | | | | | | |
| MERCEDES-BENZ - SPRINTER 3,5-t Van (B906) 06/06→ | | | | | | | |
|  Cable Pull, parking brake | | | | | | | |
| 309 CDI | 65 06/06→12/09 | Required quantity: 1; Wheelbase [mm]: 3,250; Vehicle Equipment: for vehicles without fold-down handbrake lever; Fitting Position: Front | 1 | 24.3727-0472.2 580472 Length [mm]: 1,468 | | | |
| 310 CDI | 70 03/09→ | | | | | | |
| 311 CDI | 80 - 06/06→ | | | | | | |
| | 84 | | | | | | |
| 311 CDI 4x4 | 80 02/08→12/09 | | | | | | |
| 313 CDI | 95 06/06→ | | | | | | |
| 313 CDI 4x4 | 95 05/09→ | | | | | | |
| 314 CDI | 105 05/16→ | | | | | | |
| 314 CDI 4x4 | 105 05/16→ | | | | | | |
| 315 CDI | 110 06/06→ | | | | | | |
| 315 CDI 4x4 | 110 02/08→12/09 | | | | | | |
| 316 | 115 09/08→ | | | | | | |
| 316 CDI | 120 03/09→ | | | | | | |
| 316 CDI 4x4 | 120 03/09→ | | | | | | |
| 316 LGT | 115 09/08→ | | | | | | |
| 316 NGT | 115 09/08→ | | | | | | |
| 318 CDI | 135 06/06→12/09 | | | | | | |
| 318 CDI 4x4 | 135 02/08→12/09 | | | | | | |
| 319 CDI / BlueTEC | 140 03/09→ | | | | | | |
| 319 CDI / BlueTEC 4x4 | 140 03/09→ | | | | | | |
| 324 | 190 06/06→12/13 | | | | | | |
| MERCEDES-BENZ - SPRINTER 3-t Bus (B906) 06/06→ | | | | | | | |
|  Cable Pull, parking brake | | | | | | | |
| 209 CDI | 65 04/12→ | Required quantity: 1; Wheelbase [mm]: 3,250; Vehicle Equipment: for vehicles without fold-down handbrake lever; Fitting Position: Front | 1 | 24.3727-0472.2 580472 Length [mm]: 1,468 | | | |
| 210 CDI | 70 03/09→12/13 | | | | | | |
| 211 CDI | 80 - 06/06→ | | | | | | |
| | 84 | | | | | | |
| 213 CDI | 95 06/06→05/16 | | | | | | |
| 214 CDI | 105 04/16→ | | | | | | |
| 215 CDI | 110 06/06→12/09 | | | | | | |
| 216 | 115 09/08→ | | | | | | |
| 216 CDI | 120 06/06→ | | | | | | |
| 218 CDI | 135 04/12→ | | | | | | |
| 224 | 190 06/06→12/13 | | | | | | |
| MERCEDES-BENZ - SPRINTER 3-t Platform/Chassis (B906) 06/06→ | | | | | | | |
|  Cable Pull, parking brake | | | | | | | |
| 209 CDI | 65 06/06→12/09 | | | | Required quantity: 1; Wheelbase [mm]: 3,250; Vehicle Equipment: for vehicles without fold-down handbrake lever; Fitting Position: Front | 1 | 24.3727-0472.2 580472 Length [mm]: 1,468 |
| 210 CDI | 70 03/09→05/16 | | | | | | |
| 211 CDI | 80 - 06/06→ | | | | | | |
| | 84 | | | | | | |
| 213 CDI | 95 06/06→05/16 | | | | | | |
| 214 CDI | 105 04/16→ | | | | | | |
| 215 CDI | 110 06/06→12/09 | | | | | | |
| 216 | 115 09/08→05/16 | | | | | | |
| 216 CDI | 120 03/09→ | | | | | | |
| 218 CDI | 135 06/06→12/09 | | | | | | |
| 219 CDI / BlueTEC | 140 03/09→05/16 | | | | | | |
| 224 | 190 06/06→12/13 | | | | | | |
| MERCEDES-BENZ - SPRINTER 3-t Van (B906) 06/06→ | | | | | | | |
|  Cable Pull, parking brake | | | | | | | |
| 209 CDI | 65 06/06→12/09 | Required quantity: 1; Wheelbase [mm]: 3,250; Vehicle Equipment: for vehicles without fold-down handbrake lever; Fitting Position: Front | 1 | 24.3727-0472.2 580472 Length [mm]: 1,468 | | | |
| 210 CDI | 70 03/09→ | | | | | | |
| 211 CDI | 80 - 06/06→ | | | | | | |
| | 84 | | | | | | |
| 213 CDI | 95 06/06→ | | | | | | |
| 214 CDI | 105 04/16→ | | | | | | |
| 215 CDI | 110 06/06→12/09 | | | | | | |
| 216 | 115 09/08→ | | | | | | |
| 216 CDI | 120 03/09→ | | | | | | |
| 218 CDI | 135 06/06→12/09 | | | | | | |
| → | | | | | | | |



| | | | | | | |
|---|---|--|---|------------------------------|--------------------|--|
| | | | | | | |
| MERCEDES-BENZ - SPRINTER 3-t Van (B906) 06/06→ | | | | | | |
|  Cable Pull, parking brake | | | | | | |
| 219 CDI / BlueTEC 224 | 140 03/09→ 190 06/06→ | Required quantity: 1; Wheelbase [mm]: 3,250; Vehicle Equipment: for vehicles without fold-down handbrake lever; Fitting Position: Front | 1 | 24.3727-0472.2 580472 | Length [mm]: 1,468 | |
| MERCEDES-BENZ - SPRINTER 4,6-t Platform/Chassis (B906) 06/06→ | | | | | | |
|  Cable Pull, parking brake | | | | | | |
| 411 CDI 413 CDI 414 CDI 415 CDI 416 CDI 418 CDI 419 CDI 424 | 80 - 06/09→ 84 95 03/09→ 105 05/16→ 110 06/06→ 120 03/09→ 135 06/06→12/09 140 03/09→ 190 06/06→12/13 | Required quantity: 1; Wheelbase [mm]: 3,250; Vehicle Equipment: for vehicles without fold-down handbrake lever; Fitting Position: Front | 1 | 24.3727-0472.2 580472 | Length [mm]: 1,468 | |
| MERCEDES-BENZ - SPRINTER 4,6-t Van (B906) 06/06→ | | | | | | |
|  Cable Pull, parking brake | | | | | | |
| 411 CDI 413 CDI 414 CDI 414 CDI 4x4 415 CDI 416 CDI 416 CDI 4x4 418 CDI 419 CDI 424 | 80 - 06/09→ 84 95 06/06→05/16 105 05/16→ 110 06/09→12/09 120 03/09→ 120 11/13→ 135 06/09→05/16 140 03/09→ 190 06/06→12/13 | Required quantity: 1; Wheelbase [mm]: 3,250; Vehicle Equipment: for vehicles without fold-down handbrake lever; Fitting Position: Front | 1 | 24.3727-0472.2 580472 | Length [mm]: 1,468 | |
| MERCEDES-BENZ - SPRINTER 5-t Bus (B906) 06/06→ | | | | | | |
|  Cable Pull, parking brake | | | | | | |
| 513 CDI 515 CDI 516 CDI 519 CDI | 95 03/09→ 110 06/06→ 120 03/09→ 140 03/09→ | Required quantity: 1; Wheelbase [mm]: 3,250; Vehicle Equipment: for vehicles without fold-down handbrake lever; Fitting Position: Front | 1 | 24.3727-0472.2 580472 | Length [mm]: 1,468 | |
| MERCEDES-BENZ - SPRINTER 5-t Platform/Chassis (B906) 06/06→ | | | | | | |
|  Cable Pull, parking brake | | | | | | |
| 509 CDI 510 CDI 511 CDI 511 CDI 4x4 513 CDI 513 CDI 4x4 514 CDI 514 CDI 4x4 515 CDI 515 CDI 4x4 516 516 CDI 516 CDI 4x4 516 NGT 518 CDI 518 CDI 4x4 519 CDI / BlueTEC 519 CDI / BlueTEC 4x4 524 | 65 06/06→12/09 70 03/09→05/16 80 - 06/06→ 84 80 06/06→12/09 95 06/06→05/16 95 05/11→05/16 105 05/16→ 105 05/16→ 110 06/06→ 110 06/06→12/09 115 09/08→ 120 03/09→ 120 05/11→ 115 09/08→ 135 06/06→12/09 135 06/06→12/09 140 03/09→ 140 03/09→ 190 06/06→12/13 | Required quantity: 1; Wheelbase [mm]: 3,250; Vehicle Equipment: for vehicles without fold-down handbrake lever; Fitting Position: Front | 1 | 24.3727-0472.2 580472 | Length [mm]: 1,468 | |
| MERCEDES-BENZ - SPRINTER 5-t Van (B906) 06/06→ | | | | | | |
|  Cable Pull, parking brake | | | | | | |
| 509 CDI 510 CDI 511 CDI 511 CDI 4x4 513 CDI 513 CDI 4x4 514 CDI 514 CDI 4x4 515 CDI 515 CDI 4x4 516 → | 65 06/06→12/09 70 03/09→05/16 80 - 06/06→ 84 80 06/06→12/09 95 06/06→ 95 06/06→ 105 05/16→ 105 05/16→ 110 06/06→ 110 06/06→12/09 115 03/09→ | Required quantity: 1; Wheelbase [mm]: 3,250; Vehicle Equipment: for vehicles without fold-down handbrake lever; Fitting Position: Front | 1 | 24.3727-0472.2 580472 | Length [mm]: 1,468 | |



| | | | | | |
|--|-------------------|---|---|----------------|---------------------------|
| | kW | | | | |
| MERCEDES-BENZ - SPRINTER 5-t Van (B906) 06/06→ | | | | | |
|  Cable Pull, parking brake | | | | | |
| 516 CDI | 120 03/09→ | Required quantity: 1; Wheelbase [mm]: 3,250; Vehicle Equipment: for vehicles without fold-down handbrake lever; Fitting Position: Front | 1 | 24.3727-0472.2 | 580472 Length [mm]: 1,468 |
| 516 CDI 4x4 | 120 06/06→ | | | | |
| 516 NGT | 115 03/09→ | | | | |
| 518 CDI | 135 06/06→12/09 | | | | |
| 518 CDI 4x4 | 135 06/06→12/09 | | | | |
| 519 CDI / BlueTEC | 140 03/09→ | | | | |
| 519 CDI / BlueTEC 4x4 | 140 03/09→ | | | | |
| 524 | 190 06/06→12/13 | | | | |
| MERCEDES-BENZ - V-CLASS (W447) 03/14→ | | | | | |
|  Brake Hose | | | | | |
| V 200 CDI / d | 100 03/14→ | Required quantity: 2; Fitting Position: Rear Axle | 2 | 24.5103-0456.3 | 331631 Length [mm]: 456 |
| V 200 CDI / d 4-matic | 100 04/15→ | | | | |
| V 220 CDI / d | 120 03/14→ | | | | |
| V 220 CDI / d 4-matic | 120 03/19→ | | | | |
| V 250 | 155 03/14→ | | | | |
| V 250 BlueTEC / d | 140 03/14→ | | | | |
| V 250 BlueTEC / d 4-matic | 140 12/14→ | | | | |
| V 250 CDI / d | 140 03/19→ | | | | |
| V 250 CDI / d 4-matic | 140 03/19→ | | | | |
| V 300 CDI / d | 174 - 03/19→ | | | | |
| | 176 | | | | |
| V 300 CDI / d 4-matic | 174 - 03/19→ | | | | |
| | 176 | | | | |
| V 220 CDI / d 4-matic | 120 03/15→ | Construction year from: 04/15 →; | 2 | 24.5103-0456.3 | 331631 Length [mm]: 456 |
| | | Required quantity: 2; Fitting Position: Rear Axle | | | |
| MERCEDES-BENZ - VIANO (W639) 09/03→ | | | | | |
|  Brake Hose | | | | | |
| 3.2 | 140 - 09/03→ | - ESP; Required quantity: 2; Fitting Position: Front Axle | 2 | 24.5140-0498.3 | 330912 Length [mm]: 498 |
| | 160 | | | | |
| 3.5 | 190 09/07→ | + ESP; → Construction year to: 08/10; Fitting Position: Front Axle | | 24.5140-0498.3 | 330912 Length [mm]: 498 |
| 3.7 | 170 06/04→ | | | | |
| CDI 2.0 | 80 - 09/03→ | | | | |
| | 85 | → Construction year to: 02/14; Required quantity: 2; Fitting Position: Rear Axle | 2 | 24.5123-0328.3 | 330910 Length [mm]: 328 |
| CDI 2.0 4-matic | 80 - 07/05→ | | | | |
| | 85 | | | | |
| CDI 2.2 | 100 - 09/03→ | | | | |
| | 120 | | | | |
| CDI 2.2 4-matic | 100 - 07/05→ | | | | |
| | 120 | | | | |
| CDI 3.0 | 150 - 03/06→ | | | | |
| | 165 | | | | |
| 3.7 | 165 06/04→07/07 | - ESP; Required quantity: 2; Fitting Position: Front Axle | 2 | 24.5140-0498.3 | 330912 Length [mm]: 498 |
| | | + ESP; Fitting Position: Front Axle | | | |
| | | Required quantity: 2; Fitting Position: Rear Axle | | | |
| | | | 2 | 24.5123-0328.3 | 330910 Length [mm]: 328 |
| CDI 2.2 | 70 - 09/10→ | - ESP; Required quantity: 2; Fitting Position: Front Axle | 2 | 24.5140-0498.3 | 330912 Length [mm]: 498 |
| | 110 | | | | |
| | | → Construction year to: 02/14; Required quantity: 2; Fitting Position: Rear Axle | 2 | 24.5123-0328.3 | 330910 Length [mm]: 328 |
| | | | | | |
| MERCEDES-BENZ - VITO / MIXTO Van (W639) 08/03→ | | | | | |
|  Brake Hose | | | | | |
| 109 CDI | 65 - 09/03→ | - ESP; Required quantity: 2; Fitting Position: Front Axle | 2 | 24.5140-0498.3 | 330912 Length [mm]: 498 |
| | 70 | | | | |
| 111 CDI | 80 - 09/03→ | + ESP; → Construction year to: 08/10; Fitting Position: Front Axle | | 24.5140-0498.3 | 330912 Length [mm]: 498 |
| | 85 | | | | |
| 111 CDI 4x4 | 80 09/07→ | | | | |
| 115 CDI | 110 09/03→ | → Construction year to: 02/14; Required quantity: 2; Fitting Position: Rear Axle | 2 | 24.5123-0328.3 | 330910 Length [mm]: 328 |
| 115 CDI 4x4 | 110 07/06→ | | | | |
| 119 | 140 09/03→ | | | | |
| 120 CDI | 150 07/06→ | | | | |
| 122 | 160 09/03→ | | | | |
| 126 | 190 09/07→ | | | | |
| | | | | | |
| 110 CDI | 70 09/10→ | - ESP; Required quantity: 2; Fitting Position: Front Axle | 2 | 24.5140-0498.3 | 330912 Length [mm]: 498 |
| 113 CDI | 100 09/10→ | | | | |
| 113 CDI 4x4 | 100 09/10→ | → Construction year to: 02/14; Required quantity: 2; Fitting Position: Rear Axle | 2 | 24.5123-0328.3 | 330910 Length [mm]: 328 |
| 116 CDI | 120 09/10→ | | | | |
| 116 CDI 4x4 | 120 09/10→ | | | | |
| 122 CDI | 165 09/10→ | | | | |
| E-CELL | 60 03/12→ | | | | |
| 123 | 165 - 06/04→07/08 | - ESP; Required quantity: 2; Fitting Position: Front Axle | 2 | 24.5140-0498.3 | 330912 Length [mm]: 498 |
| | 170 | | | | |



| | | | | | |
|---|--------------------------|--|--|---|---|
| | kW | | | | |
| MERCEDES-BENZ - VITO / MIXTO Van (W639) 08/03→ | | | | | |
|  Brake Hose | | | | | |
| 123 | 165 - 06/04→07/08 170 | + ESP; Fitting Position: Front Axle | | 2 | 24.5140-0498.3 330912 Length [mm]: 498 |
| | | Required quantity: 2; Fitting Position: Rear Axle | | 2 | 24.5123-0328.3 330910 Length [mm]: 328 |
| MERCEDES-BENZ - VITO Bus (W639) 09/03→ | | | | | |
|  Brake Hose | | | | | |
| 109 CDI | 65 - 09/03→ 70 | - ESP; Required quantity: 2; Fitting Position: Front Axle | | 2 | 24.5140-0498.3 330912 Length [mm]: 498 |
| 109 CDI 4x4 | 70 09/07→08/14 | + ESP; → Construction year to: 08/10; | | | 24.5140-0498.3 330912 Length [mm]: 498 |
| 111 CDI | 80 - 09/03→ 85 | Fitting Position: Front Axle | | | |
| 111 CDI 4x4 | 80 09/07→08/14 | → Construction year to: 02/14; | | 2 | 24.5123-0328.3 330910 Length [mm]: 328 |
| 115 CDI | 110 09/03→ | Required quantity: 2; | | | |
| 115 CDI 4x4 | 110 09/07→08/14 | Fitting Position: Rear Axle | | | |
| 119 | 140 09/03→ | | | | |
| 120 CDI | 150 07/06→ | | | | |
| 122 | 160 09/03→ | | | | |
| 126 | 190 09/07→ | | | | |
| 110 CDI | 70 09/10→08/14 | - ESP; Required quantity: 2; | | 2 | 24.5140-0498.3 330912 Length [mm]: 498 |
| 113 CDI | 100 09/10→ | Fitting Position: Front Axle | | | |
| 113 CDI 4x4 | 100 09/10→08/14 | → Construction year to: 02/14; | | 2 | 24.5123-0328.3 330910 Length [mm]: 328 |
| 116 CDI | 120 09/10→ | Required quantity: 2; | | | |
| 116 CDI 4x4 | 120 09/10→08/14 | Fitting Position: Rear Axle | | | |
| 122 CDI | 165 09/10→ | | | | |
| E-CELL | 60 03/12→ | | | | |
| 123 | 165 - 06/04→07/08 170 | - ESP; Required quantity: 2; Fitting Position: Front Axle | | 2 | 24.5140-0498.3 330912 Length [mm]: 498 |
| | | + ESP; Fitting Position: Front Axle | | | 24.5140-0498.3 330912 Length [mm]: 498 |
| | | Required quantity: 2; Fitting Position: Rear Axle | | 2 | 24.5123-0328.3 330910 Length [mm]: 328 |
| MERCEDES-BENZ - VITO Mixto (Double Cabin) (W447) 10/14→ | | | | | |
|  Brake Hose | | | | | |
| 109 CDI | 65 10/14→ | Required quantity: 2; | | 2 | 24.5103-0456.3 331631 Length [mm]: 456 |
| 110 CDI | 75 09/19→ | Fitting Position: Rear Axle | | | |
| 111 CDI | 84 10/14→ | | | | |
| 114 CDI | 100 10/14→ | | | | |
| 114 CDI 4-matic | 100 07/15→ | | | | |
| 116 CDI | 120 10/14→ | | | | |
| 116 CDI 4-matic | 120 07/15→ | | | | |
| 119 BlueTEC | 140 10/14→ | | | | |
| 119 BlueTEC 4-matic | 140 12/14→ | | | | |
| 119 CDI | 140 03/19→ | | | | |
| 119 CDI 4-matic | 140 03/19→ | | | | |
| 124 CDI | 174 - 04/20→ 176 | | | | |
| 124 CDI 4-matic | 174 - 04/20→ 176 | | | | |
| MERCEDES-BENZ - VITO Tourer (W447) 10/14→ | | | | | |
|  Brake Hose | | | | | |
| 109 CDI / 109 BlueTEC | 65 10/14→ | Required quantity: 2; | | 2 | 24.5103-0456.3 331631 Length [mm]: 456 |
| 110 CDI | 75 09/19→ | Fitting Position: Rear Axle | | | |
| 111 CDI / 111 BlueTEC | 84 10/14→ | | | | |
| 114 CDI / 114 BlueTEC | 100 10/14→ | | | | |
| 114 CDI / 114 BlueTEC 4-matic | 100 07/15→ | | | | |
| 114 CDI | 100 03/19→ | | | | |
| 114 CDI 4-matic | 100 03/19→ | | | | |
| 116 CDI / 116 BlueTEC | 120 10/14→ | | | | |
| 116 CDI / 116 BlueTEC 4-matic | 120 07/15→ | | | | |
| 116 CDI | 120 03/19→ | | | | |
| 116 CDI 4-matic | 120 03/19→ | | | | |
| 119 CDI / 119 BlueTEC | 140 10/14→ | | | | |
| 119 CDI / 119 BlueTEC 4-matic | 140 12/14→ | | | | |
| 119 CDI | 140 03/19→ | | | | |
| 119 CDI 4-matic | 140 03/19→ | | | | |
| 124 CDI | 174 - 04/20→ 176 | | | | |
| 124 CDI 4-matic | 174 - 04/20→ 176 | | | | |
| 2.0 | 155 01/16→ | | | | |





| | kW | | | | | | | | |
|---|-------------------|---|---|------------------------------|--|---|--|------------------------------|--|
| MERCEDES-BENZ - VITO Van (W447) 10/14→ | | | | | | | | | |
|  Brake Hose | | | | | | | | | |
| 109 CDI | 65 10/14→ | Required quantity: 2; Fitting Position: Rear Axle | 2 | 24.5103-0456.3 331631 | Length [mm]: 456 | | | | |
| 110 CDI | 75 09/19→ | | | | | | | | |
| 111 CDI | 84 10/14→ | | | | | | | | |
| 114 CDI | 100 10/14→ | | | | | | | | |
| 114 CDI 4x4 | 100 07/15→ | | | | | | | | |
| 116 CDI | 120 10/14→ | | | | | | | | |
| 116 CDI 4x4 | 120 07/15→ | | | | | | | | |
| 119 CDI / BlueTEC | 140 10/14→ | | | | | | | | |
| 119 CDI / BlueTEC 4x4 | 140 07/15→ | | | | | | | | |
| 119 CDI | 140 04/20→ | | | | | | | | |
| 119 CDI 4x4 | 140 04/20→ | | | | | | | | |
| 2.0 | 155 09/15→ | | | | | | | | |
| NISSAN - CABSTAR (F24M, F24W) 09/06→12/13 | | | | | | | | | |
|  Brake Caliper | | | | | | | | | |
| 32.11 DCI | 81 09/06→12/13 | Fitting Position: Front Axle Right | | 24.3481-9962.5 241460 | Brake System: ATE Supplementary Article/Supplementary Info: without holder Brake Caliper Type: Fist-type Caliper (2 pistons) | | | | |
| 35.11 DCI 2.5 | 81 09/06→12/13 | | | | | | | | |
| 28.11 DCI | 81 09/06→12/13 | | | | | | | | |
| 32.12 DCI | 90 09/06→12/13 | | | | | | | | |
| 34.12 DCI | 90 09/06→12/13 | | | | | | | | |
| 28.12 DCI | 90 09/06→12/13 | | | | | | | | |
| 35.12 DCI 2.5 | 90 09/06→12/13 | | | | | | | | |
| 34.110 DCI 2.5 | 82 01/07→04/12 | | | | | | | | |
| 35.14 DCI | 100 09/06→12/13 | | | | | | | | |
| 45.14 DCI 2.5 | 100 09/06→12/13 | | | | | | | | |
| 45.13 DCI 2.5 | 96 09/06→12/12 | | | | | Gross vehicle weight [kg]: 3,500; Fitting Position: Front Axle Right | | 24.3481-9962.5 241460 | Brake System: ATE Supplementary Article/Supplementary Info: without holder Brake Caliper Type: Fist-type Caliper (2 pistons) |
| 35.13 DCI | 96 09/06→12/12 | | | | | | | | |
| 35.14 DCI 3.0 | 101 09/06→12/13 | | | | | | | | |
| 35.15 DCI | 110 09/06→12/13 | | | | | | | | |
| 45.15 DCI 3.0 | 110 09/06→12/13 | | | | | | | | |
| | | | | | | | | | |
| NISSAN - NT400 CABSTAR (F24M) 08/09→ | | | | | | | | | |
|  Brake Caliper | | | | | | | | | |
| 28.12 | 90 01/14→ | Fitting Position: Front Axle Right | | 24.3481-9962.5 241460 | Brake System: ATE Supplementary Article/Supplementary Info: without holder Brake Caliper Type: Fist-type Caliper (2 pistons) | | | | |
| 32.12 | 90 01/14→ | | | | | | | | |
| 35.12 | 90 01/14→ | | | | | | | | |
| 35.13 | 96 09/16→ | Gross vehicle weight [kg]: 3,500; Fitting Position: Front Axle Right | | 24.3481-9962.5 241460 | Brake System: ATE Supplementary Article/Supplementary Info: without holder Brake Caliper Type: Fist-type Caliper (2 pistons) | | | | |
| 45.14 | 100 01/14→ | | | | | | | | |
| 35.14 | 100 01/14→ | | | | | | | | |
| 45.15 | 107 - 01/14→ | | | | | | | | |
| | 110 | | | | | | | | |
| 35.15 | 107 - 01/14→ | | | | | | | | |
| | 110 | | | | | | | | |
| NISSAN - X-TRAIL II (T31) 03/07→12/18 | | | | | | | | | |
| Accessory Kit, disc brake pad | | | | | | | | | |
| 2.0 | 102 06/08→02/14 | Fitting Position: Rear Axle | | 13.0460-0527.2 610527 | | | | | |
| 2.0 4x4 | 101 - 06/07→11/13 | | | | | | | | |
| | 104 | | | | | | | | |
| 2.0 dCi | 110 06/07→11/13 | | | | | | | | |
| 2.0 dCi 4x4 | 110 - 06/07→11/13 | | | | | | | | |
| | 130 | | | | | | | | |
| 2.0 FWD | 103 - 03/07→11/13 | | | | | | | | |
| | 104 | | | | | | | | |
| 2.5 4x4 | 124 - 06/07→07/14 | | | | | | | | |
| | 132 | | | | | | | | |
| NISSAN - X-TRAIL VAN (T31) 03/07→02/14 | | | | | | | | | |
| Accessory Kit, disc brake pad | | | | | | | | | |
| dCi | 110 01/11→02/14 | | | | | Fitting Position: Rear Axle | | 13.0460-0527.2 610527 | |
| dCi 4x4 | 110 - 01/13→02/14 | | | | | | | | |
| | 127 | | | | | | | | |
| OPEL - ADAM (M13) 10/12→02/19 | | | | | | | | | |
|  Brake Hose | | | | | | | | | |
| 1.0 | 66 - 07/14→11/18 | Required quantity: 2; Fitting Position: Front Axle | 2 | 24.5103-0405.3 331647 | Length [mm]: 425 | | | | |
| | 85 | | | | | | | | |
| 1.2 | 51 10/12→02/19 | | | | | | | | |
| 1.4 | 64 - 10/12→02/19 | | | | | | | | |
| | 74 | | | | | | | | |
| 1.4 LPG | 64 07/13→11/18 | | | | | | | | |
| 1.4 S | 110 11/14→01/19 | | | | | | | | |







| | kW | | | |
|---|---|--|------------------------------|------------------|
| OPEL - ASTRA J (P10) 09/09→10/15 | | | | |
|  Brake Hose | | | | |
| 1.3 CDTI 1.4 | 70 12/09→10/15 64 - 12/09→10/15 | Vehicle Identification Number from: A8068772 →; Number of Doors: 5; Fitting Position: Front Axle Right | 24.5176-0401.3 331649 | Length [mm]: 410 |
| 1.4 LPG 1.4 Turbo | 103 01/12→10/15 88 - 12/09→10/15 | Vehicle Identification Number from: A8068772 →; Number of Doors: 5; Fitting Position: Front Axle Left | 24.5176-0402.3 331633 | Length [mm]: 410 |
| 1.6 1.6 SIDI 1.6 Turbo 1.6 Turbo 4x4 1.7 CDTI | 85 12/09→10/15 125 12/12→10/15 132 12/09→10/15 132 12/09→10/15 81 - 09/09→10/15 | | | |
| 2.0 BiTurbo CDTI 2.0 CDTI | 96 143 09/12→10/15 96 - 09/09→10/15 | | | |
| 1.6 CDTi | 81 02/14→10/15 | Number of Doors: 5; Fitting Position: Front Axle Right | 24.5176-0401.3 331649 | Length [mm]: 410 |
| | | Number of Doors: 5; Fitting Position: Front Axle Left | 24.5176-0402.3 331633 | Length [mm]: 410 |
| 1.6 CDTi | 100 11/13→10/15 | Construction year from: 01/14 →; Number of Doors: 5; Fitting Position: Front Axle Right | 24.5176-0401.3 331649 | Length [mm]: 410 |
| | | Construction year from: 01/14 →; Number of Doors: 5; Fitting Position: Front Axle Left | 24.5176-0402.3 331633 | Length [mm]: 410 |
| OPEL - ASTRA J Estate Van (P10) 09/09→10/15 | | | | |
|  Brake Hose | | | | |
| 1.3 CDTi 1.6 CDTi 1.7 CDTi 2.0 CDTi | 70 10/12→10/15 81 01/14→10/15 96 10/12→10/15 121 10/12→10/15 | Vehicle Identification Number from: A8068772 →; Fitting Position: Front Axle Right | 24.5176-0401.3 331649 | Length [mm]: 410 |
| | | Vehicle Identification Number from: A8068772 →; Fitting Position: Front Axle Left | 24.5176-0402.3 331633 | Length [mm]: 410 |
| OPEL - ASTRA J GTC 10/11→ | | | | |
|  Brake Hose | | | | |
| 1.4 1.6 1.6 SIDI 1.7 CDTI | 74 - 10/11→ 103 132 10/11→ 125 12/12→ | Vehicle Identification Number from: A8068772 →; Number of Doors: 5; Fitting Position: Front Axle Right | 24.5176-0401.3 331649 | Length [mm]: 410 |
| 2.0 BiTurbo CDTI 2.0 CDTI | 81 - 10/11→10/15 96 143 10/12→10/15 96 - 10/11→10/15 | Vehicle Identification Number from: A8068772 →; Number of Doors: 5; Fitting Position: Front Axle Left | 24.5176-0402.3 331633 | Length [mm]: 410 |
| 1.6 CDTI | 81 - 07/14→ 100 | Number of Doors: 5; Fitting Position: Front Axle Right | 24.5176-0401.3 331649 | Length [mm]: 410 |
| | | Number of Doors: 5; Fitting Position: Front Axle Left | 24.5176-0402.3 331633 | Length [mm]: 410 |
| OPEL - ASTRA J Hatchback Van (P10) 09/09→10/15 | | | | |
|  Brake Hose | | | | |
| 1.3 CDTi 1.6 CDTi 1.7 CDTi | 70 05/13→10/15 81 01/14→10/15 81 05/13→10/15 | Vehicle Identification Number from: A8068772 →; Fitting Position: Front Axle Right | 24.5176-0401.3 331649 | Length [mm]: 410 |
| | | Vehicle Identification Number from: A8068772 →; Fitting Position: Front Axle Left | 24.5176-0402.3 331633 | Length [mm]: 410 |
| OPEL - ASTRA J Saloon 06/12→ | | | | |
|  Brake Hose | | | | |
| 1.3 CDTI 1.4 | 70 06/12→10/15 64 - 06/12→10/15 | Vehicle Identification Number from: A8068772 →; Number of Doors: 5; Fitting Position: Front Axle Right | 24.5176-0401.3 331649 | Length [mm]: 410 |
| 1.4 LPG 1.4 Turbo | 74 103 07/14→ 88 - 06/12→ | Vehicle Identification Number from: A8068772 →; Number of Doors: 5; Fitting Position: Front Axle Left | 24.5176-0402.3 331633 | Length [mm]: 410 |
| 1.6 1.6 SIDI 1.6 Turbo 1.7 CDTI | 103 85 06/12→ 125 06/12→10/15 132 06/12→ 74 - 06/12→10/15 | | | |
| 1.6 CDTi | 96 81 - 01/14→ 100 | Number of Doors: 5; Fitting Position: Front Axle Right | 24.5176-0401.3 331649 | Length [mm]: 410 |
| | | Number of Doors: 5; Fitting Position: Front Axle Left | 24.5176-0402.3 331633 | Length [mm]: 410 |



| | kW | | | | |
|--|--|---|--|------------------------------|---|
| OPEL - ASTRA J Sports Tourer (P10) 10/10→10/15 | | | | | |
|  Brake Hose | | | | | |
| 1.3 CDTI 1.4 | 70 10/10→10/14 64 - 10/10→10/15 74 | Vehicle Identification Number from: A8068772 →; Fitting Position: Front Axle Right | | 24.5176-0401.3 331649 | Length [mm]: 410 |
| 1.4 LPG 1.4 Turbo | 103 12/11→10/15 88 - 10/10→10/15 103 | Vehicle Identification Number from: A8068772 →; Fitting Position: Front Axle Left | | 24.5176-0402.3 331633 | Length [mm]: 410 |
| 1.6 1.6 SIDI 1.6 Turbo 1.7 CDTI | 85 10/10→10/15 125 12/12→10/15 132 10/10→10/15 74 - 10/10→10/15 96 | | | | |
| 2.0 BiTurbo CDTI 2.0 CDTI | 143 09/12→10/15 96 - 10/10→10/15 121 | | | | |
| 1.6 CDTi | 81 02/14→10/15 | Fitting Position: Front Axle Right | | 24.5176-0401.3 331649 | Length [mm]: 410 |
| | | Fitting Position: Front Axle Left | | 24.5176-0402.3 331633 | Length [mm]: 410 |
| 1.6 CDTi | 100 11/13→10/15 | Construction year from: 01/14 →; Fitting Position: Front Axle Right | | 24.5176-0401.3 331649 | Length [mm]: 410 |
| | | Construction year from: 01/14 →; Fitting Position: Front Axle Left | | 24.5176-0402.3 331633 | Length [mm]: 410 |
| OPEL - ASTRA L 10/21→ | | | | | |
|  Brake Pad Set, disc brake | | | | | |
| 1.2 1.5 Turbo D 1.6 Plug-In-Hybrid | 74 - 10/21→ 96 96 10/21→ 110 - 10/21→ 133 | for brake disc diameter [mm]: 283; Fitting Position: Front Axle | | 13.0460-3870.2 603870 | Brake System: Bosch 25895 18,5 Wear Warning Contact: not prepared for wear indicator / excl. wear warning contact Supplementary Article/Supplementary Info: with accessories |
| | | | | 13.0470-3870.2 LD3870 | Brake System: Bosch 25895 18,5 Wear Warning Contact: not prepared for wear indicator / excl. wear warning contact Supplementary Article/Supplementary Info: with accessories Ceramic |
| | | for brake disc diameter [mm]: 330; Fitting Position: Front Axle | | 13.0460-3876.2 603876 | Brake System: Bosch 22218 18,3 Wear Warning Contact: prepared for wear indicator / excl. wear warning contact Supplementary Article/Supplementary Info: with accessories |
| | | for brake disc diameter [mm]: 268; Fitting Position: Rear Axle | | 13.0460-3871.2 603871 | Brake System: Bosch 25839 17,8 Wear Warning Contact: not prepared for wear indicator / excl. wear warning contact Supplementary Article/Supplementary Info: with accessories |
| | | | | 13.0470-3871.2 LD3871 | Brake System: Bosch 25839 17,8 Wear Warning Contact: not prepared for wear indicator / excl. wear warning contact Supplementary Article/Supplementary Info: with accessories Ceramic |
| | | for brake disc diameter [mm]: 290; Fitting Position: Rear Axle | | 13.0460-3872.2 603872 | Brake System: Bosch 25827 17,7 Wear Warning Contact: not prepared for wear indicator / excl. wear warning contact Supplementary Article/Supplementary Info: with accessories |
| | | | | 13.0470-3872.2 LD3872 | Brake System: Bosch 25827 17,7 Wear Warning Contact: not prepared for wear indicator / excl. wear warning contact Supplementary Article/Supplementary Info: with accessories Ceramic |
|  Brake Disc | | | | | |
| 1.2 1.5 Turbo D 1.6 Plug-In-Hybrid | 74 - 10/21→ 96 96 10/21→ 110 - 10/21→ 133 | Fitting Position: Front Axle | | 24.0126-0183.1 426183 | Outer diameter [mm]: 283 Brake Disc Thickness [mm] 26 Minimum thickness [mm] 24 Brake Disc Type: Vented Supplementary Article/Info 2: with bolts/screws |
| → | | | | | |

| | kW | | | | |
|--|--|--|--|------------------------------|---|
| OPEL - ASTRA L 10/21→ | | | | | |
|  Brake Disc | | | | | |
| 1.2 1.5 Turbo D 1.6 Plug-In-Hybrid | 74 - 10/21→ 96 96 10/21→ 110 - 10/21→ 133 | Fitting Position: Front Axle | | 24.0128-0269.1 428269 | Outer diameter [mm]: 304 Brake Disc Thickness [mm] 28 Minimum thickness [mm] 26 Brake Disc Type: Vented Supplementary Article/Info 2: with bolts/screws |
| | | Fitting Position: Rear Axle | | 24.0130-0241.1 430241 | Outer diameter [mm]: 330 Brake Disc Thickness [mm] 30 Minimum thickness [mm] 28 Brake Disc Type: Vented Supplementary Article/Info 2: with bolts/screws |
| | | | | 24.0112-0211.1 412211 | Outer diameter [mm]: 268 Brake Disc Thickness [mm] 12 Minimum thickness [mm] 10 Brake Disc Type: Solid Supplementary Article/Info 2: with bolts/screws |
| | | | | 24.0112-0212.1 412212 | Outer diameter [mm]: 290 Brake Disc Thickness [mm] 12 Minimum thickness [mm] 10 Brake Disc Type: Solid Supplementary Article/Info 2: with bolts/screws |
| OPEL - ASTRA L Sports Tourer 10/21→ | | | | | |
|  Brake Pad Set, disc brake | | | | | |
| 1.2 1.5 CDTi 1.6 Plug-In Hybrid 1.6 Plug-In Hybrid combined power | 81 - 10/21→ 96 96 10/21→ 110 10/21→ 133 10/21→ | for brake disc diameter [mm]: 283; Fitting Position: Front Axle | | 13.0460-3870.2 603870 | Brake System: Bosch 25895 18,5 Wear Warning Contact: not prepared for wear indicator / excl. wear warning contact Supplementary Article/Supplementary Info: with accessories |
| | | | | 13.0470-3870.2 LD3870 | Brake System: Bosch 25895 18,5 Wear Warning Contact: not prepared for wear indicator / excl. wear warning contact Supplementary Article/Supplementary Info: with accessories Ceramic |
| | | for brake disc diameter [mm]: 330; Fitting Position: Front Axle | | 13.0460-3876.2 603876 | Brake System: Bosch 22218 18,3 Wear Warning Contact: prepared for wear indicator / excl. wear warning contact Supplementary Article/Supplementary Info: with accessories |
| | | for brake disc diameter [mm]: 268; Fitting Position: Rear Axle | | 13.0460-3871.2 603871 | Brake System: Bosch 25839 17,8 Wear Warning Contact: not prepared for wear indicator / excl. wear warning contact Supplementary Article/Supplementary Info: with accessories |
| | | | | 13.0470-3871.2 LD3871 | Brake System: Bosch 25839 17,8 Wear Warning Contact: not prepared for wear indicator / excl. wear warning contact Supplementary Article/Supplementary Info: with accessories Ceramic |
| | | for brake disc diameter [mm]: 290; Fitting Position: Rear Axle | | 13.0460-3872.2 603872 | Brake System: Bosch 25827 17,7 Wear Warning Contact: not prepared for wear indicator / excl. wear warning contact Supplementary Article/Supplementary Info: with accessories |
| | | | | 13.0470-3872.2 LD3872 | Brake System: Bosch 25827 17,7 Wear Warning Contact: not prepared for wear indicator / excl. wear warning contact Supplementary Article/Supplementary Info: with accessories Ceramic |
| → | | | | | |



| | kW | | | | |
|--|-------------------|---|------------------------------|---|---|
| OPEL - ASTRA L Sports Tourer 10/21→ | | | | | |
|  Brake Disc | | | | | |
| 1.2 | 81 - 10/21→ 96 | Fitting Position: Front Axle | 24.0126-0183.1 426183 | Outer diameter [mm]: 283 Brake Disc Thickness [mm] 26 Minimum thickness [mm] 24 Brake Disc Type: Vented Supplementary Article/Info 2: with bolts/screws | |
| 1.5 CDTi | 96 10/21→ | | | 24.0128-0269.1 428269 | Outer diameter [mm]: 304 Brake Disc Thickness [mm] 28 Minimum thickness [mm] 26 Brake Disc Type: Vented Supplementary Article/Info 2: with bolts/screws |
| 1.6 Plug-In Hybrid | 110 10/21→ | | | 24.0130-0241.1 430241 | Outer diameter [mm]: 330 Brake Disc Thickness [mm] 30 Minimum thickness [mm] 28 Brake Disc Type: Vented Supplementary Article/Info 2: with bolts/screws |
| 1.6 Plug-In Hybrid combined power | 133 10/21→ | | | | |
| | | Fitting Position: Rear Axle | 24.0112-0211.1 412211 | Outer diameter [mm]: 268 Brake Disc Thickness [mm] 12 Minimum thickness [mm] 10 Brake Disc Type: Solid Supplementary Article/Info 2: with bolts/screws | |
| | | | 24.0112-0212.1 412212 | Outer diameter [mm]: 290 Brake Disc Thickness [mm] 12 Minimum thickness [mm] 10 Brake Disc Type: Solid Supplementary Article/Info 2: with bolts/screws | |
| OPEL - COMBO Box Body/MPV (K9) 06/18→ | | | | | |
| Spring, brake caliper | | | | | |
| 1.2 | 81 - 02/19→ 96 | for brake disc diameter [mm]: 283; Fitting Position: Front Axle | 11.8116-0237.1 390509 | Brake System: ATE | |
| 1.5 D | 56 - 08/18→ 96 | | | | |
| 1.5 D 4x4 | 96 08/18→ | | | | |
| 1.6 D | 55 - 06/18→ 73 | | | | |
| Combo-e | 100 07/21→ | | | | |
| | | | | | |
|  Brake Pad Set, disc brake | | | | | |
| 1.2 | 81 - 02/19→ 96 | for brake disc diameter [mm]: 283; Fitting Position: Front Axle | 13.0460-3870.2 603870 | Brake System: Bosch 25895 18,5 Wear Warning Contact: not prepared for wear indicator / excl. wear warning contact Supplementary Article/Supplementary Info: with accessories | |
| 1.5 D | 56 - 08/18→ 96 | | | | |
| 1.5 D 4x4 | 96 08/18→ | | | | |
| 1.6 D | 55 - 06/18→ 73 | | | | |
| Combo-e | 100 07/21→ | | | | |
| | | Vehicle Equipment: for vehicles with electric parking brake; Fitting Position: Rear Axle | 13.0460-3871.2 603871 | Brake System: Bosch 25839 17,8 Wear Warning Contact: not prepared for wear indicator / excl. wear warning contact Supplementary Article/Supplementary Info: with accessories | |
| | | | 13.0470-3870.2 LD3870 | Brake System: Bosch 25895 18,5 Wear Warning Contact: not prepared for wear indicator / excl. wear warning contact Supplementary Article/Supplementary Info: with accessories Ceramic | |
| | | | 13.0470-3871.2 LD3871 | Brake System: Bosch 25839 17,8 Wear Warning Contact: not prepared for wear indicator / excl. wear warning contact Supplementary Article/Supplementary Info: with accessories Ceramic | |
|  Brake Disc | | | | | |
| 1.2 | 81 - 02/19→ 96 | Brake System: Bosch; Fitting Position: Front Axle | 24.0126-0183.1 426183 | Outer diameter [mm]: 283 Brake Disc Thickness [mm] 26 Minimum thickness [mm] 24 Brake Disc Type: Vented Supplementary Article/Info 2: with bolts/screws | |
| 1.5 D | 56 - 08/18→ 96 | | | | |
| 1.5 D 4x4 | 96 08/18→ | | | | |
| 1.6 D | 55 - 06/18→ 73 | | | | |
| → | | | | | |





| | kW | | | | |
|--|-------------------|--|---|--------------------------------|---|
| OPEL - COMBO Box Body/MPV (K9) 06/18→ | | | | | |
|  Brake Disc | | | | | |
| Combo-e | 100 07/21→ | | Fitting Position: Front Axle | 24.0128-0269.1 428269 | Outer diameter [mm]: 304 Brake Disc Thickness [mm] 28 Minimum thickness [mm] 26 Brake Disc Type: Vented Supplementary Article/Info 2: with bolts/screws |
| | | | Fitting Position: Rear Axle | 24.0112-0211.1 412211 | Outer diameter [mm]: 268 Brake Disc Thickness [mm] 12 Minimum thickness [mm] 10 Brake Disc Type: Solid Supplementary Article/Info 2: with bolts/screws |
| OPEL - COMBO E Tour / Life (K9) 06/18→ | | | | | |
| Spring, brake caliper | | | | | |
| 1.2 | 81 - 06/18→ 96 | | for brake disc diameter [mm]: 283; Fitting Position: Front Axle | 11.8116-0237.1 390509 | Brake System: ATE |
| 1.5 | 56 - 06/18→ 96 | | | | |
| Combo-e | 100 06/21→ | | | | |
|  Brake Pad Set, disc brake | | | | | |
| 1.2 | 81 - 06/18→ 96 | | for brake disc diameter [mm]: 283; Fitting Position: Front Axle | 13.0460-3870.2 603870 | Brake System: Bosch 25895 18,5 Wear Warning Contact: not prepared for wear indicator / excl. wear warning contact Supplementary Article/Supplementary Info: with accessories |
| 1.5 | 56 - 06/18→ 96 | | | 13.0470-3870.2 LD3870 | Brake System: Bosch 25895 18,5 Wear Warning Contact: not prepared for wear indicator / excl. wear warning contact Supplementary Article/Supplementary Info: with accessories Ceramic |
| Combo-e | 100 06/21→ | | | | |
| | | | Vehicle Equipment: for vehicles with electric parking brake; Fitting Position: Rear Axle | 13.0460-3871.2 603871 | Brake System: Bosch 25839 17,8 Wear Warning Contact: not prepared for wear indicator / excl. wear warning contact Supplementary Article/Supplementary Info: with accessories |
| | | | | 13.0470-3871.2 LD3871 | Brake System: Bosch 25839 17,8 Wear Warning Contact: not prepared for wear indicator / excl. wear warning contact Supplementary Article/Supplementary Info: with accessories Ceramic |
|  Brake Disc | | | | | |
| 1.2 | 81 - 06/18→ 96 | | Brake System: Bosch; Fitting Position: Front Axle | 24.0126-0183.1 426183 | Outer diameter [mm]: 283 Brake Disc Thickness [mm] 26 Minimum thickness [mm] 24 Brake Disc Type: Vented Supplementary Article/Info 2: with bolts/screws |
| 1.5 | 56 - 06/18→ 96 | | | | |
| Combo-e | 100 06/21→ | | | | |
| | | | Fitting Position: Front Axle | 24.0128-0269.1 428269 | Outer diameter [mm]: 304 Brake Disc Thickness [mm] 28 Minimum thickness [mm] 26 Brake Disc Type: Vented Supplementary Article/Info 2: with bolts/screws |
| | | | Fitting Position: Rear Axle | 24.0112-0211.1 412211 | Outer diameter [mm]: 268 Brake Disc Thickness [mm] 12 Minimum thickness [mm] 10 Brake Disc Type: Solid Supplementary Article/Info 2: with bolts/screws |
| OPEL - CORSA D (S07) 07/06→08/14 | | | | | |
|  Brake Hose | | | | | |
| 1.4 | 88 07/12→08/14 | | Required quantity: 2; Fitting Position: Front Axle | 2 24.5176-0425.3 331644 | Length [mm]: 425 |







| | | | | | |
|--|--------------------|---|---|------------------------------|---|
| | kW | | | | |
| OPEL - CORSA D Hatchback Van (S07) 07/06→08/14 | | | | | |
|  Brake Hose | | | | | |
| 1.4 | 88 07/12→08/14 | Required quantity: 2; Fitting Position: Front Axle | 2 | 24.5176-0425.3 331644 | Length [mm]: 425 |
| OPEL - CORSA E (X15) 09/14→ | | | | | |
|  Brake Hose | | | | | |
| 1.0 | 66 - 09/14→ 85 | Required quantity: 2; for brake disc diameter [mm]: 284; Fitting Position: Front Axle | 2 | 24.5103-0405.3 331647 | Length [mm]: 425 |
| 1.2 | 51 09/14→ | | | | |
| 1.3 CDTI | 55 - 09/14→ 70 | Required quantity: 2; for brake disc diameter [mm]: 330; Fitting Position: Front Axle | 2 | 24.5112-0463.3 331643 | Length [mm]: 485 |
| 1.4 | 55 - 09/14→ 66 | | | | |
| 1.4 LPG | 64 - 03/15→ 66 | for brake disc diameter [mm]: 308; Required quantity: 2; Fitting Position: Front Axle | 2 | 24.5176-0425.3 331644 | Length [mm]: 425 |
| 1.4 Turbo | 74 - 09/14→ 110 | | | | |
| 1.6 Turbo | 152 03/15→ | Required quantity: 2; for brake disc diameter [mm]: 330; Fitting Position: Front Axle | 2 | 24.5112-0463.3 331643 | Length [mm]: 485 |
| OPEL - CORSA E Hatchback Van (X15) 09/14→ | | | | | |
|  Brake Hose | | | | | |
| 1.2 | 51 01/15→ | Required quantity: 2; for brake disc diameter [mm]: 284; Fitting Position: Front Axle | 2 | 24.5103-0405.3 331647 | Length [mm]: 425 |
| 1.3 CDTI | 55 - 09/14→ 70 | | | | |
| 1.4 | 55 - 09/14→ 66 | Required quantity: 2; for brake disc diameter [mm]: 330; Fitting Position: Front Axle | 2 | 24.5112-0463.3 331643 | Length [mm]: 485 |
| | | for brake disc diameter [mm]: 308; Required quantity: 2; Fitting Position: Front Axle | 2 | 24.5176-0425.3 331644 | Length [mm]: 425 |
| OPEL - CORSA F 07/19→ | | | | | |
|  Brake Pad Set, disc brake | | | | | |
| CORSA-e | 100 07/19→ | Fitting Position: Rear Axle | | 13.0460-3871.2 603871 | Brake System: Bosch 25839 17,8 Wear Warning Contact: not prepared for wear indicator / excl. wear warning contact Supplementary Article/Supplementary Info: with accessories |
| | | | | 13.0470-3871.2 LD3871 | Brake System: Bosch 25839 17,8 Wear Warning Contact: not prepared for wear indicator / excl. wear warning contact Supplementary Article/Supplementary Info: with accessories Ceramic |
|  Brake Disc | | | | | |
| 1.2 | 55 - 07/19→ 96 | Fitting Position: Front Axle | | 24.0122-0194.1 422194 | Outer diameter [mm]: 266 Brake Disc Thickness [mm] 22 Minimum thickness [mm] 20 Brake Disc Type: Vented Supplementary Article/Info 2: with bolts/screws |
| 1.5 | 75 07/19→ | | | | |
| CORSA-e | 100 07/19→ | | | | |
| OPEL - CORSA F Hatchback Van 07/19→ | | | | | |
|  Brake Disc | | | | | |
| 1.2 | 55 07/19→ | Fitting Position: Front Axle | | 24.0122-0194.1 422194 | Outer diameter [mm]: 266 Brake Disc Thickness [mm] 22 Minimum thickness [mm] 20 Brake Disc Type: Vented Supplementary Article/Info 2: with bolts/screws |
| 1.5 | 75 07/19→ | | | | |
| OPEL - CROSSLAND X / CROSSLAND (P17, P2QO) 03/17→ | | | | | |
|  Brake Disc | | | | | |
| 1.2 | 60 - 03/17→ 96 | Brake Size: 14"; Fitting Position: Front Axle | | 24.0122-0194.1 422194 | Outer diameter [mm]: 266 Brake Disc Thickness [mm] 22 Minimum thickness [mm] 20 Brake Disc Type: Vented Supplementary Article/Info 2: with bolts/screws |
| 1.2 LPG | 60 10/17→ | | | | |
| 1.5 | 81 10/20→ | | | | |
| 1.5 Turbo D | 75 - 06/18→ 88 | | | | |
| 1.6 Turbo D | 73 - 03/17→ 88 | | | | |



| | | kW | | | | |
|--|---------------------|----|---|------------------------------|--|--|
| OPEL - CROSSLAND X Van 03/17→ | | | | | | |
|  Brake Disc | | | | | | |
| 1.2 | 61 - 07/19→ | | Brake Size: 14"; Fitting Position: Front Axle | 24.0122-0194.1 422194 | Outer diameter [mm]: 266 Brake Disc Thickness [mm] 22 Minimum thickness [mm] 20 Brake Disc Type: Vented Supplementary Article/Info 2: with bolts/screws | |
| 1.5 | 81 75 06/18→ | | | | | |
| OPEL - GRANDLAND / GRANDLAND X (A18, P1UO) 06/17→ | | | | | | |
|  Brake Pad Set, disc brake | | | | | | |
| 1.2 | 96 06/17→ | | for brake disc diameter [mm]: 330; Fitting Position: Front Axle | 13.0460-3876.2 603876 | Brake System: Bosch 22218 18,3 Wear Warning Contact: prepared for wear indicator / excl. wear warning contact Supplementary Article/Supplementary Info: with accessories | |
| 1.5 Turbo D | 75 - 04/18→ 96 | | | | | |
| 1.6 Turbo | 110 - 09/18→ 133 | | for brake disc diameter [mm]: 268; for POC: 1F*; Fitting Position: Rear Axle | 13.0460-3871.2 603871 | Brake System: Bosch 25839 17,8 Wear Warning Contact: not prepared for wear indicator / excl. wear warning contact Supplementary Article/Supplementary Info: with accessories | |
| 1.6 Turbo D | 88 06/17→ | | | | | |
| 2.0 D | 130 11/17→ | | | | | |
| | | | for brake disc diameter [mm]: 290; for POC: 1G*; Fitting Position: Rear Axle | 13.0460-3872.2 603872 | Brake System: Bosch 25827 17,7 Wear Warning Contact: not prepared for wear indicator / excl. wear warning contact Supplementary Article/Supplementary Info: with accessories | |
| | | | | | | |
| | | | for brake disc diameter [mm]: 268; Fitting Position: Rear Axle | 13.0460-3871.2 603871 | Brake System: Bosch 25839 17,8 Wear Warning Contact: not prepared for wear indicator / excl. wear warning contact Supplementary Article/Supplementary Info: with accessories | |
| | | | | | | |
| | | | for brake disc diameter [mm]: 290; Fitting Position: Rear Axle | 13.0460-3872.2 603872 | Brake System: Bosch 25827 17,7 Wear Warning Contact: not prepared for wear indicator / excl. wear warning contact Supplementary Article/Supplementary Info: with accessories | |
| | | | | | | |
| | | | | | | |
| 1.6 Turbo Hybrid | 133 - 12/19→ 165 | | for brake disc diameter [mm]: 330; Fitting Position: Front Axle | 13.0460-3876.2 603876 | Brake System: Bosch 22218 18,3 Wear Warning Contact: prepared for wear indicator / excl. wear warning contact Supplementary Article/Supplementary Info: with accessories | |
| 1.6 Turbo Hybrid4 | 147 - 06/19→ 221 | | | | | |
| | | | for brake disc diameter [mm]: 268; Fitting Position: Rear Axle | 13.0460-3871.2 603871 | Brake System: Bosch 25839 17,8 Wear Warning Contact: not prepared for wear indicator / excl. wear warning contact Supplementary Article/Supplementary Info: with accessories | |
| | | | | | | |
| | | | | | | |
| | | | for brake disc diameter [mm]: 290; Fitting Position: Rear Axle | 13.0460-3872.2 603872 | Brake System: Bosch 25827 17,7 Wear Warning Contact: not prepared for wear indicator / excl. wear warning contact Supplementary Article/Supplementary Info: with accessories | |
| | | | | | | |
| | | | for brake disc diameter [mm]: 290; Fitting Position: Rear Axle | 13.0460-3872.2 603872 | Brake System: Bosch 25827 17,7 Wear Warning Contact: not prepared for wear indicator / excl. wear warning contact Supplementary Article/Supplementary Info: with accessories | |
| | | | | | | |
| | | | | | | |







→



| | | kW | | | | | |
|--|--------------|---|--|------------------------------|---|--|--|
| OPEL - GRANDLAND / GRANDLAND X (A18, P1UO) 06/17→ | | | | | | | |
|  Brake Disc | | | | | | | |
| 1.2 | 96 06/17→ | Fitting Position: Front Axle | | 24.0128-0269.1 428269 | Outer diameter [mm]: 304 Brake Disc Thickness [mm] 28 Minimum thickness [mm] 26 Brake Disc Type: Vented Supplementary Article/Info 2: with bolts/screws | | |
| 1.5 Turbo D | 75 - 04/18→ | | | | | | |
| | 96 | | | | | | |
| 1.6 Turbo | 110 - 09/18→ | | | | | | |
| 1.6 Turbo D | 88 06/17→ | | | | | | |
| 2.0 D | 130 11/17→ | | | 24.0130-0241.1 430241 | Outer diameter [mm]: 330 Brake Disc Thickness [mm] 30 Minimum thickness [mm] 28 Brake Disc Type: Vented Supplementary Article/Info 2: with bolts/screws | | |
| | | for POC: 1F*; Fitting Position: Rear Axle | | 24.0112-0211.1 412211 | Outer diameter [mm]: 268 Brake Disc Thickness [mm] 12 Minimum thickness [mm] 10 Brake Disc Type: Solid Supplementary Article/Info 2: with bolts/screws | | |
| | | for POC: 1G*; Fitting Position: Rear Axle | | 24.0112-0212.1 412212 | Outer diameter [mm]: 290 Brake Disc Thickness [mm] 12 Minimum thickness [mm] 10 Brake Disc Type: Solid Supplementary Article/Info 2: with bolts/screws | | |
| 1.6 Turbo Hybrid | 133 - 12/19→ | Fitting Position: Front Axle | | 24.0128-0269.1 428269 | Outer diameter [mm]: 304 Brake Disc Thickness [mm] 28 Minimum thickness [mm] 26 Brake Disc Type: Vented Supplementary Article/Info 2: with bolts/screws | | |
| 1.6 Turbo Hybrid4 | 147 - 06/19→ | | | | | | |
| | 165 | | | 24.0130-0241.1 430241 | Outer diameter [mm]: 330 Brake Disc Thickness [mm] 30 Minimum thickness [mm] 28 Brake Disc Type: Vented Supplementary Article/Info 2: with bolts/screws | | |
| | 221 | Fitting Position: Rear Axle | | 24.0112-0211.1 412211 | Outer diameter [mm]: 268 Brake Disc Thickness [mm] 12 Minimum thickness [mm] 10 Brake Disc Type: Solid Supplementary Article/Info 2: with bolts/screws | | |
| | | | | 24.0112-0212.1 412212 | Outer diameter [mm]: 290 Brake Disc Thickness [mm] 12 Minimum thickness [mm] 10 Brake Disc Type: Solid Supplementary Article/Info 2: with bolts/screws | | |
| OPEL - GRANDLAND X Van 06/17→ | | | | | | | |
|  Brake Pad Set, disc brake | | | | | | | |
| 1.2 | 96 04/18→ | for brake disc diameter [mm]: 330; Fitting Position: Front Axle | | 13.0460-3876.2 603876 | Brake System: Bosch 22218 18,3 Wear Warning Contact: prepared for wear indicator / excl. wear warning contact Supplementary Article/Supplementary Info: with accessories | | |
| 1.5 | 96 04/18→ | | | | | | |
| 2.0 CDTI | 130 11/17→ | | | | | | |
| | | for brake disc diameter [mm]: 268; for POC: 1F*; Fitting Position: Rear Axle | | 13.0460-3871.2 603871 | Brake System: Bosch 25839 17,8 Wear Warning Contact: not prepared for wear indicator / excl. wear warning contact Supplementary Article/Supplementary Info: with accessories | | |
| | | | | 13.0470-3871.2 LD3871 | Brake System: Bosch 25839 17,8 Wear Warning Contact: not prepared for wear indicator / excl. wear warning contact Supplementary Article/Supplementary Info: with accessories Ceramic | | |
| | | for brake disc diameter [mm]: 290; for POC: 1G*; Fitting Position: Rear Axle | | 13.0460-3872.2 603872 | Brake System: Bosch 25827 17,7 Wear Warning Contact: not prepared for wear indicator / excl. wear warning contact Supplementary Article/Supplementary Info: with accessories | | |
| → | | | | | | | |





| | kW | | | | |
|--|---|--|--|--------------------------------|---|
| OPEL - GRANDLAND X Van 06/17→ | | | | | |
|  Brake Pad Set, disc brake | | | | | |
| 1.2 1.5 2.0 CDTI | 96 04/18→ 96 04/18→ 130 11/17→ | for brake disc diameter [mm]: 290; for POC: 1G*; Fitting Position: Rear Axle | | 13.0470-3872.2 LD3872 | Brake System: Bosch 25827 17,7 Wear Warning Contact: not prepared for wear indicator / excl. wear warning contact Supplementary Article/Supplementary Info: with accessories Ceramic |
|  Brake Disc | | | | | |
| 1.2 1.5 2.0 CDTI | 96 04/18→ 96 04/18→ 130 11/17→ | Fitting Position: Front Axle | | 24.0128-0269.1 428269 | Outer diameter [mm]: 304 Brake Disc Thickness [mm] 28 Minimum thickness [mm] 26 Brake Disc Type: Vented Supplementary Article/Info 2: with bolts/screws |
| | | | | 24.0130-0241.1 430241 | Outer diameter [mm]: 330 Brake Disc Thickness [mm] 30 Minimum thickness [mm] 28 Brake Disc Type: Vented Supplementary Article/Info 2: with bolts/screws |
| | | for POC: 1F*; Fitting Position: Rear Axle | | 24.0112-0211.1 412211 | Outer diameter [mm]: 268 Brake Disc Thickness [mm] 12 Minimum thickness [mm] 10 Brake Disc Type: Solid Supplementary Article/Info 2: with bolts/screws |
| | | for POC: 1G*; Fitting Position: Rear Axle | | 24.0112-0212.1 412212 | Outer diameter [mm]: 290 Brake Disc Thickness [mm] 12 Minimum thickness [mm] 10 Brake Disc Type: Solid Supplementary Article/Info 2: with bolts/screws |
| OPEL - MOKKA 06/20→ | | | | | |
|  Brake Pad Set, disc brake | | | | | |
| MOKKA-e | 100 06/20→ | Vehicle Equipment: for vehicles with electric parking brake; Fitting Position: Rear Axle | | 13.0460-3871.2 603871 | Brake System: Bosch 25839 17,8 Wear Warning Contact: not prepared for wear indicator / excl. wear warning contact Supplementary Article/Supplementary Info: with accessories |
| | | | | 13.0470-3871.2 LD3871 | Brake System: Bosch 25839 17,8 Wear Warning Contact: not prepared for wear indicator / excl. wear warning contact Supplementary Article/Supplementary Info: with accessories Ceramic |
| OPEL - MOKKA / MOKKA X (J13) 06/12→ | | | | | |
|  Cable Pull, parking brake | | | | | |
| 1.4 1.4 4x4 1.6 CDTI 1.6 CDTI 4x4 | 88 06/18→ 112 06/16→ 81 - 01/15→ 100 81 - 01/15→ 100 | Required quantity: 1; Brake Type: Disc Brake; Fitting Position: Rear | | 1 24.3727-3502.2 583502 | Length [mm]: 1,885 Length 2 [mm]: 1,918 |
| 1.4 1.4 4x4 1.4 LPG 1.6 1.7 CDTI 1.7 CDTI 4x4 1.8 1.8 4x4 | 103 04/13→ 103 06/12→ 103 04/13→ 85 06/12→ 96 06/12→ 96 06/12→ 103 01/13→ 103 01/13→ | Construction year from: 12/13 →; Required quantity: 1; Brake Type: Disc Brake; Fitting Position: Rear | | 1 24.3727-3502.2 583502 | Length [mm]: 1,885 Length 2 [mm]: 1,918 |
| OPEL - MOKKA X VAN (J13) 06/12→ | | | | | |
|  Cable Pull, parking brake | | | | | |
| 1.6 CDTi | 100 03/18→ | Required quantity: 1; Brake Type: Disc Brake; Fitting Position: Rear | | 1 24.3727-3502.2 583502 | Length [mm]: 1,885 Length 2 [mm]: 1,918 |



| | | | | | |
|---|--|--|------------------------------|---|--|
| | kW | | | | |
| OPEL - ROCKS-E 10/21→ | | | | | |
|  Brake Disc | | | | | |
| Electric | 6 10/21→ | Fitting Position: Front Axle | 24.0122-0194.1 422194 | Outer diameter [mm]: 266 Brake Disc Thickness [mm] 22 Minimum thickness [mm] 20 Brake Disc Type: Vented Supplementary Article/Info 2: with bolts/screws | |
| OPEL - VIVARO C Bus (K0) 03/19→ | | | | | |
|  Brake Disc | | | | | |
| 1.5 2.0 VIVARO-E | 75 - 03/19→ 88 90 - 03/19→ 110 100 09/20→ | Vehicle Equipment: for vehicles without electric parking brake; Fitting Position: Rear Axle | 24.0112-0212.1 412212 | Outer diameter [mm]: 290 Brake Disc Thickness [mm] 12 Minimum thickness [mm] 10 Brake Disc Type: Solid Supplementary Article/Info 2: with bolts/screws | |
| OPEL - VIVARO C Platform Cabin (K0) 03/19→ | | | | | |
|  Brake Disc | | | | | |
| 2.0 VIVARO-E | 90 - 03/19→ 110 100 09/20→ | Vehicle Equipment: for vehicles without electric parking brake; Fitting Position: Rear Axle | 24.0112-0212.1 412212 | Outer diameter [mm]: 290 Brake Disc Thickness [mm] 12 Minimum thickness [mm] 10 Brake Disc Type: Solid Supplementary Article/Info 2: with bolts/screws | |
| OPEL - VIVARO C Van (K0) 03/19→ | | | | | |
|  Brake Disc | | | | | |
| 1.5 1.5 4x4 2.0 2.0 4x4 VIVARO-E | 75 - 03/19→ 88 88 03/19→ 90 - 03/19→ 130 110 03/19→ 100 09/20→ | Vehicle Equipment: for vehicles without electric parking brake; Fitting Position: Rear Axle | 24.0112-0212.1 412212 | Outer diameter [mm]: 290 Brake Disc Thickness [mm] 12 Minimum thickness [mm] 10 Brake Disc Type: Solid Supplementary Article/Info 2: with bolts/screws | |
| OPEL - ZAFIRA LIFE Bus (K0) 03/19→ | | | | | |
|  Brake Disc | | | | | |
| 1.5 2.0 2.0 4x4 E LIFE | 75 - 03/19→ 88 90 - 03/19→ 130 110 03/19→ 100 09/20→ | Vehicle Equipment: for vehicles without electric parking brake; Fitting Position: Rear Axle | 24.0112-0212.1 412212 | Outer diameter [mm]: 290 Brake Disc Thickness [mm] 12 Minimum thickness [mm] 10 Brake Disc Type: Solid Supplementary Article/Info 2: with bolts/screws | |
| PEUGEOT - 206 CC (2D) 09/00→12/08 | | | | | |
|  Brake Disc | | | | | |
| 1.6 1.6 16V 2.0 S16 | 81 09/01→12/08 80 09/00→12/07 100 09/00→12/07 | for RPO number (vehicle manufacturing date) from: 09079 →; → Construction year to: 01/07; Fitting Position: Front Axle | 24.0122-0194.1 422194 | Outer diameter [mm]: 266 Brake Disc Thickness [mm] 22 Minimum thickness [mm] 20 Brake Disc Type: Vented Supplementary Article/Info 2: with bolts/screws | |
| 1.6 HDi 110 | 80 04/05→02/07 | → Construction year to: 01/07; Fitting Position: Front Axle | 24.0122-0194.1 422194 | Outer diameter [mm]: 266 Brake Disc Thickness [mm] 22 Minimum thickness [mm] 20 Brake Disc Type: Vented Supplementary Article/Info 2: with bolts/screws | |
| PEUGEOT - 206 Hatchback (2A/C) 08/98→12/12 | | | | | |
|  Brake Disc | | | | | |
| 1.4 16V 1.6 HDi 110 | 65 10/03→02/08 80 05/04→02/07 | Fitting Position: Front Axle | 24.0122-0194.1 422194 | Outer diameter [mm]: 266 Brake Disc Thickness [mm] 22 Minimum thickness [mm] 20 Brake Disc Type: Vented Supplementary Article/Info 2: with bolts/screws | |
| 1.6 1.6 16V 1.6 Flex 2.0 S16 | 81 05/05→07/08 79 06/01→04/09 83 05/05→07/08 100 06/99→12/07 | for RPO number (vehicle manufacturing date) from: 09079 →; Fitting Position: Front Axle | 24.0122-0194.1 422194 | Outer diameter [mm]: 266 Brake Disc Thickness [mm] 22 Minimum thickness [mm] 20 Brake Disc Type: Vented Supplementary Article/Info 2: with bolts/screws | |
| → | | | | | |



| | kW | | | | |
|---|--|--|------------------------------|---|--|
| PEUGEOT - 206 Hatchback (2A/C) 08/98→12/12 | | | | | |
|  Brake Disc | | | | | |
| 1.6 16V 1.6 BiFuel 2.0 HDi 90 | 80 07/00→04/09 80 07/00→04/09 66 12/99→09/09 | for RPO number (vehicle manufacturing date) from: 09079 →; → Construction year to: 02/09; Fitting Position: Front Axle | 24.0122-0194.1 422194 | Outer diameter [mm]: 266 Brake Disc Thickness [mm] 22 Minimum thickness [mm] 20 Brake Disc Type: Vented Supplementary Article/Info 2: with bolts/screws | |
| PEUGEOT - 206 Saloon 03/07→ | | | | | |
|  Brake Disc | | | | | |
| 1.6 16V | 80 03/07→ | for RPO number (vehicle manufacturing date) from: 09079 →; → Construction year to: 02/09; Fitting Position: Front Axle | 24.0122-0194.1 422194 | Outer diameter [mm]: 266 Brake Disc Thickness [mm] 22 Minimum thickness [mm] 20 Brake Disc Type: Vented Supplementary Article/Info 2: with bolts/screws | |
| PEUGEOT - 206 SW (2E/K) 07/02→ | | | | | |
|  Brake Disc | | | | | |
| 1.4 16V 1.6 1.6 16V 1.6 HDi 110 | 65 10/03→ 81 05/05→07/08 80 07/02→ 80 05/04→ | → Construction year to: 05/07; Fitting Position: Front Axle | 24.0122-0194.1 422194 | Outer diameter [mm]: 266 Brake Disc Thickness [mm] 22 Minimum thickness [mm] 20 Brake Disc Type: Vented Supplementary Article/Info 2: with bolts/screws | |
| 1.6 Flex 1.6 LPG 2.0 16V 2.0 HDi | 81 - 05/05→07/08 83 80 07/02→02/07 100 07/02→02/07 66 07/02→02/07 | Fitting Position: Front Axle | 24.0122-0194.1 422194 | Outer diameter [mm]: 266 Brake Disc Thickness [mm] 22 Minimum thickness [mm] 20 Brake Disc Type: Vented Supplementary Article/Info 2: with bolts/screws | |
| PEUGEOT - 207 (WA_, WC_) 02/06→12/15 | | | | | |
|  Brake Disc | | | | | |
| 1.4 1.4 16V 1.4 Bioflex 1.4 HDi 1.6 HDi | 53 - 02/06→12/15 55 65 02/06→10/13 60 08/08→12/14 50 - 02/06→12/15 52 66 - 02/06→10/13 68 | → Construction year to: 06/12; Fitting Position: Front Axle | 24.0122-0194.1 422194 | Outer diameter [mm]: 266 Brake Disc Thickness [mm] 22 Minimum thickness [mm] 20 Brake Disc Type: Vented Supplementary Article/Info 2: with bolts/screws | |
| 1.4 BiFuel 2.0 HDi | 54 08/07→12/13 66 10/08→12/12 | Fitting Position: Front Axle | 24.0122-0194.1 422194 | Outer diameter [mm]: 266 Brake Disc Thickness [mm] 22 Minimum thickness [mm] 20 Brake Disc Type: Vented Supplementary Article/Info 2: with bolts/screws | |
| PEUGEOT - 207 Hatchback Van (WA_, WC_) 04/06→ | | | | | |
|  Brake Disc | | | | | |
| 1.4 | 54 06/07→10/08 | Fitting Position: Front Axle | 24.0122-0194.1 422194 | Outer diameter [mm]: 266 Brake Disc Thickness [mm] 22 Minimum thickness [mm] 20 Brake Disc Type: Vented Supplementary Article/Info 2: with bolts/screws | |
| 1.4 HDi 1.6 HDi | 50 04/07→ 66 - 04/07→03/13 68 | → Construction year to: 06/12; Fitting Position: Front Axle | 24.0122-0194.1 422194 | Outer diameter [mm]: 266 Brake Disc Thickness [mm] 22 Minimum thickness [mm] 20 Brake Disc Type: Vented Supplementary Article/Info 2: with bolts/screws | |
| PEUGEOT - 207 Saloon 12/07→12/14 | | | | | |
|  Brake Disc | | | | | |
| 1.4 1.4 Flex | 54 - 12/07→12/12 55 60 11/08→12/14 | → Construction year to: 06/12; Fitting Position: Front Axle | 24.0122-0194.1 422194 | Outer diameter [mm]: 266 Brake Disc Thickness [mm] 22 Minimum thickness [mm] 20 Brake Disc Type: Vented Supplementary Article/Info 2: with bolts/screws | |
| → | | | | | |



| | | | | |
|--|---|------------------------------|--|---|
| | kW | | | |
| PEUGEOT - 207 Saloon 12/07→12/14 | | | | |
|  Brake Disc | | | | |
| 2.0 HDi | 66 12/07→12/12 | Fitting Position: Front Axle | 24.0122-0194.1 422194 | Outer diameter [mm]: 266 Brake Disc Thickness [mm] 22 Minimum thickness [mm] 20 Brake Disc Type: Vented Supplementary Article/Info 2: with bolts/screws |
| PEUGEOT - 207 SW (WK_) 02/07→12/13 | | | | |
|  Brake Disc | | | | |
| 1.4 1.4 Flex 1.4 LPG 1.6 HDi 2.0 HDi | 54 06/07→12/12 59 08/08→01/13 54 08/07→12/12 66 06/07→12/12 66 10/08→12/12 | Fitting Position: Front Axle | 24.0122-0194.1 422194 | Outer diameter [mm]: 266 Brake Disc Thickness [mm] 22 Minimum thickness [mm] 20 Brake Disc Type: Vented Supplementary Article/Info 2: with bolts/screws |
| PEUGEOT - 208 I (CA_, CC_) 03/12→ | | | | |
|  Brake Disc | | | | |
| 1.0 1.2 GPL 1.2 PureTech 82 1.2 THP 110 1.2 VTi 68 / PureTech 68 1.2 VTi 82 1.4 GPL 1.4 HDi 1.4 VTi 1.5 BlueHDi 100 1.6 1.6 BlueHDi 100 1.6 BlueHDi 120 1.6 e-HDi 1.6 HDi 1.6 HDi / BlueHDi 75 1.6 THP 165 | 50 03/12→ 60 06/15→ 61 03/18→ 81 01/13→ 50 08/16→ 60 03/12→ 70 10/13→ 50 03/12→ 70 03/12→ 75 05/18→ 85 - 03/12→ 115 73 01/15→ 88 11/13→ 82 07/15→ 68 - 03/12→ 85 55 01/13→ 121 03/15→ | Fitting Position: Front Axle | 24.0122-0194.1 422194 | Outer diameter [mm]: 266 Brake Disc Thickness [mm] 22 Minimum thickness [mm] 20 Brake Disc Type: Vented Supplementary Article/Info 2: with bolts/screws |
| PEUGEOT - 208 II (UB_, UP_, UW_, UJ_) 06/19→ | | | | |
|  Brake Pad Set, disc brake | | | | |
| e-208 | 100 06/19→ | Fitting Position: Rear Axle | 13.0460-3871.2 603871 13.0470-3871.2 LD3871 | Brake System: Bosch 25839 17,8 Wear Warning Contact: not prepared for wear indicator / excl. wear warning contact Supplementary Article/Supplementary Info: with accessories Brake System: Bosch 25839 17,8 Wear Warning Contact: not prepared for wear indicator / excl. wear warning contact Supplementary Article/Supplementary Info: with accessories Ceramic |
|  Brake Disc | | | | |
| 1.2 PureTech 100 1.2 PureTech 130 1.2 PureTech 75 1.2 VTi 82 1.5 BlueHDi 100 1.5 BlueHDi 130 1.6 HDi 90 1.6 VTi 115 e-208 | 74 06/19→ 96 06/19→ 55 06/19→ 60 06/19→ 75 06/19→ 96 09/19→ 68 10/19→ 85 11/19→ 100 06/19→ | Fitting Position: Front Axle | 24.0122-0194.1 422194 | Outer diameter [mm]: 266 Brake Disc Thickness [mm] 22 Minimum thickness [mm] 20 Brake Disc Type: Vented Supplementary Article/Info 2: with bolts/screws |
| PEUGEOT - 208 Hatchback Van (CR_) 10/12→ | | | | |
|  Brake Disc | | | | |
| 1.2 VTi 68 / PureTech 68 1.2 VTi 82 / PureTech 82 1.4 HDi 68 1.5 BlueHDi 100 1.6 Blue HDi 100 1.6 BlueHDi 75 1.6 HDi 92 | 50 06/15→ 60 06/15→ 50 10/12→ 75 05/18→ 73 06/15→ 55 04/15→ 68 03/14→ | Fitting Position: Front Axle | 24.0122-0194.1 422194 | Outer diameter [mm]: 266 Brake Disc Thickness [mm] 22 Minimum thickness [mm] 20 Brake Disc Type: Vented Supplementary Article/Info 2: with bolts/screws |



| | kW | | | | |
|---|----|-------------|---|------------------------------|---|
| PEUGEOT - 301 11/12→ | | | | | |
|  Brake Disc | | | | | |
| 1.2 PureTech 82 | 61 | 02/18→ | Fitting Position: Front Axle | 24.0122-0194.1 422194 | Outer diameter [mm]: 266 Brake Disc Thickness [mm] 22 Minimum thickness [mm] 20 Brake Disc Type: Vented Supplementary Article/Info 2: with bolts/screws |
| 1.2 VTi 72 | 53 | 11/12→ | | | |
| 1.2 VTi 82 | 60 | 12/14→ | | | |
| 1.5 BlueHDI 100 | 75 | 05/18→ | | | |
| 1.6 BlueHDI 100 | 73 | 04/14→ | | | |
| 1.6 HDi 90 | 68 | 11/12→ | | | |
| 1.6 LPG | 85 | 07/14→ | | | |
| 1.6 VTi 115 | 85 | 11/12→10/17 | | | |
| PEUGEOT - 307 (3A/C) 08/00→12/12 | | | | | |
|  Brake Disc | | | | | |
| 1.4 | 55 | 08/00→09/03 | Fitting Position: Front Axle | 24.0122-0194.1 422194 | Outer diameter [mm]: 266 Brake Disc Thickness [mm] 22 Minimum thickness [mm] 20 Brake Disc Type: Vented Supplementary Article/Info 2: with bolts/screws |
| 1.4 HDi | 50 | 10/01→06/05 | | | |
| 1.4 16V | 65 | 11/03→07/07 | - ESP; Fitting Position: Front Axle | 24.0122-0194.1 422194 | Outer diameter [mm]: 266 Brake Disc Thickness [mm] 22 Minimum thickness [mm] 20 Brake Disc Type: Vented Supplementary Article/Info 2: with bolts/screws |
| | | | for RPO number (vehicle manufacturing date) from: 10551 →; + ESP; Fitting Position: Front Axle | 24.0122-0194.1 422194 | Outer diameter [mm]: 266 Brake Disc Thickness [mm] 22 Minimum thickness [mm] 20 Brake Disc Type: Vented Supplementary Article/Info 2: with bolts/screws |
| 1.6 | 81 | 07/06→04/12 | → Construction year to: 07/07; + ESP; Transmission Type: Manual Transmission; Fitting Position: Front Axle | 24.0122-0194.1 422194 | Outer diameter [mm]: 266 Brake Disc Thickness [mm] 22 Minimum thickness [mm] 20 Brake Disc Type: Vented Supplementary Article/Info 2: with bolts/screws |
| 1.6 16V | 80 | 08/00→11/07 | → Construction year to: 07/07; Transmission Type: Manual Transmission; - ESP; Fitting Position: Front Axle | 24.0122-0194.1 422194 | Outer diameter [mm]: 266 Brake Disc Thickness [mm] 22 Minimum thickness [mm] 20 Brake Disc Type: Vented Supplementary Article/Info 2: with bolts/screws |
| | | | for RPO number (vehicle manufacturing date) from: 10551 →; + ESP; → Construction year to: 07/07; Transmission Type: Manual Transmission; Fitting Position: Front Axle | 24.0122-0194.1 422194 | Outer diameter [mm]: 266 Brake Disc Thickness [mm] 22 Minimum thickness [mm] 20 Brake Disc Type: Vented Supplementary Article/Info 2: with bolts/screws |
| 1.6 Flex | 83 | 07/06→12/12 | + ESP; Transmission Type: Manual Transmission; Fitting Position: Front Axle | 24.0122-0194.1 422194 | Outer diameter [mm]: 266 Brake Disc Thickness [mm] 22 Minimum thickness [mm] 20 Brake Disc Type: Vented Supplementary Article/Info 2: with bolts/screws |
| 1.6 HDi | 66 | 04/05→03/09 | → Construction year to: 07/07; - ESP; Fitting Position: Front Axle | 24.0122-0194.1 422194 | Outer diameter [mm]: 266 Brake Disc Thickness [mm] 22 Minimum thickness [mm] 20 Brake Disc Type: Vented Supplementary Article/Info 2: with bolts/screws |
| | | | for RPO number (vehicle manufacturing date) from: 10551 →; → Construction year to: 07/07; + ESP; Fitting Position: Front Axle | 24.0122-0194.1 422194 | Outer diameter [mm]: 266 Brake Disc Thickness [mm] 22 Minimum thickness [mm] 20 Brake Disc Type: Vented Supplementary Article/Info 2: with bolts/screws |
| 2.0 HDi 90 | 66 | 08/00→03/07 | for RPO number (vehicle manufacturing date) from: 09520 →; - ESP; Fitting Position: Front Axle | 24.0122-0194.1 422194 | Outer diameter [mm]: 266 Brake Disc Thickness [mm] 22 Minimum thickness [mm] 20 Brake Disc Type: Vented Supplementary Article/Info 2: with bolts/screws |

| | kW | | | | |
|---|--|--|--|---|--|
| PEUGEOT - 307 Break (3E) 03/02→12/09 | | | | | |
|  Brake Disc | | | | | |
| 1.4 1.4 16V | 55 04/02→09/03 65 11/03→07/07 | - ESP; Fitting Position: Front Axle | 24.0122-0194.1 422194 | Outer diameter [mm]: 266 Brake Disc Thickness [mm] 22 Minimum thickness [mm] 20 Brake Disc Type: Vented Supplementary Article/Info 2: with bolts/screws | |
| | | for RPO number (vehicle manufacturing date) from: 10551 →; + ESP; Fitting Position: Front Axle | 24.0122-0194.1 422194 | Outer diameter [mm]: 266 Brake Disc Thickness [mm] 22 Minimum thickness [mm] 20 Brake Disc Type: Vented Supplementary Article/Info 2: with bolts/screws | |
| 1.4 HDi | 50 03/02→06/05 | Fitting Position: Front Axle | 24.0122-0194.1 422194 | Outer diameter [mm]: 266 Brake Disc Thickness [mm] 22 Minimum thickness [mm] 20 Brake Disc Type: Vented Supplementary Article/Info 2: with bolts/screws | |
| PEUGEOT - 307 Saloon 01/01→12/12 | | | | | |
|  Brake Disc | | | | | |
| 1.6 | 81 08/06→12/12 | + ESP; Transmission Type: Manual Transmission; Fitting Position: Front Axle | 24.0122-0194.1 422194 | Outer diameter [mm]: 266 Brake Disc Thickness [mm] 22 Minimum thickness [mm] 20 Brake Disc Type: Vented Supplementary Article/Info 2: with bolts/screws | |
| PEUGEOT - 307 SW (3H) 03/02→12/09 | | | | | |
|  Brake Disc | | | | | |
| 1.4 1.4 16V | 55 04/02→09/03 65 11/03→07/07 | - ESP; Fitting Position: Front Axle | 24.0122-0194.1 422194 | Outer diameter [mm]: 266 Brake Disc Thickness [mm] 22 Minimum thickness [mm] 20 Brake Disc Type: Vented Supplementary Article/Info 2: with bolts/screws | |
| | | for RPO number (vehicle manufacturing date) from: 10551 →; + ESP; Fitting Position: Front Axle | 24.0122-0194.1 422194 | Outer diameter [mm]: 266 Brake Disc Thickness [mm] 22 Minimum thickness [mm] 20 Brake Disc Type: Vented Supplementary Article/Info 2: with bolts/screws | |
| PEUGEOT - 307 SW Estate Van (3E_, 3H_) 04/02→12/09 | | | | | |
|  Brake Disc | | | | | |
| 1.4 HDi | 51 04/02→06/05 | Fitting Position: Front Axle | 24.0122-0194.1 422194 | Outer diameter [mm]: 266 Brake Disc Thickness [mm] 22 Minimum thickness [mm] 20 Brake Disc Type: Vented Supplementary Article/Info 2: with bolts/screws | |
| PEUGEOT - 308 II (LB_, LP_, LW_, LH_, L3_) 09/13→06/21 | | | | | |
|  Brake Pad Set, disc brake | | | | | |
| 1.2 THP 110 1.2 THP 130 1.2 VTi 72 1.5 BlueHDi 100 1.5 BlueHDi 130 1.6 BlueHDi 120 1.6 GT 205 1.6 GTi 1.6 HDi 1.6 HDi / BlueHDi 115 1.6 HDi 100 1.6 THP 1.6 THP 125 1.6 THP 150 1.6 THP 163 1.6 VTi 115 2.0 BlueHDi 150 2.0 GT BlueHDi 180 | 81 11/13→06/21 96 11/13→06/21 60 09/13→06/21 75 05/18→06/21 96 06/17→06/21 88 11/13→06/21 151 06/14→06/21 184 - 06/15→06/21 200 68 09/13→06/21 85 09/13→06/21 73 04/14→06/21 115 09/13→06/21 92 09/13→06/21 110 03/14→06/21 120 06/14→06/21 85 05/15→06/21 110 11/13→06/21 133 06/14→06/21 | for brake disc diameter [mm]: 283; Fitting Position: Front Axle | 13.0460-3870.2 603870 13.0470-3870.2 LD3870 | Brake System: Bosch 25895 18,5 Wear Warning Contact: not prepared for wear indicator / excl. wear warning contact Supplementary Article/Supplementary Info: with accessories Brake System: Bosch 25895 18,5 Wear Warning Contact: not prepared for wear indicator / excl. wear warning contact Supplementary Article/Supplementary Info: with accessories Ceramic | |
| | | for brake disc diameter [mm]: 330; Fitting Position: Front Axle | 13.0460-3876.2 603876 | Brake System: Bosch 22218 18,3 Wear Warning Contact: prepared for wear indicator / excl. wear warning contact Supplementary Article/Supplementary Info: with accessories | |
| → | | | | | |

| | kW | | | | | | | |
|--|-----------|-------------|---|------------------------------|---|---|------------------------------|--|
| PEUGEOT - 308 II (LB_, LP_, LW_, LH_, L3_) 09/13→06/21 | | | | | | | | |
|  Brake Pad Set, disc brake | | | | | | | | |
| 1.2 THP 110 | 81 | 11/13→06/21 | for brake disc diameter [mm]: 268; Vehicle Equipment: for vehicles with electric parking brake; Fitting Position: Rear Axle | 13.0460-3871.2 603871 | Brake System: Bosch 25839 17,8 Wear Warning Contact: not prepared for wear indicator / excl. wear warning contact Supplementary Article/Supplementary Info: with accessories | | | |
| 1.2 THP 130 | 96 | 11/13→06/21 | | | | | | |
| 1.2 VTi 72 | 60 | 09/13→06/21 | | | | | | |
| 1.5 BlueHDi 100 | 75 | 05/18→06/21 | | | | | | |
| 1.5 BlueHDi 130 | 96 | 06/17→06/21 | | | | | | |
| 1.6 BlueHDi 120 | 88 | 11/13→06/21 | | | | | | |
| 1.6 GT 205 | 151 | 06/14→06/21 | | | | | | |
| 1.6 GTi | 184 - 200 | 06/15→06/21 | | | | | | |
| 1.6 HDi | 68 | 09/13→06/21 | | | | | | |
| 1.6 HDi / BlueHDi 115 | 85 | 09/13→06/21 | | | | | | |
| 1.6 HDi 100 | 73 | 04/14→06/21 | | | | | | |
| 1.6 THP | 115 | 09/13→06/21 | | | | | | |
| 1.6 THP 125 | 92 | 09/13→06/21 | | | | | | |
| 1.6 THP 150 | 110 | 03/14→06/21 | | | | | | |
| 1.6 THP 163 | 120 | 06/14→06/21 | for brake disc diameter [mm]: 290; Fitting Position: Rear Axle | 13.0460-3872.2 603872 | Brake System: Bosch 25827 17,7 Wear Warning Contact: not prepared for wear indicator / excl. wear warning contact Supplementary Article/Supplementary Info: with accessories | | | |
| 1.6 VTi 115 | 85 | 05/15→06/21 | | | | | | |
| 2.0 BlueHDi 150 | 110 | 11/13→06/21 | | | | | | |
| 2.0 GT BlueHDi 180 | 133 | 06/14→06/21 | | | | | | |
| 1.6 GTi PureTech 263 | 193 | 07/18→06/21 | | | | for brake disc diameter [mm]: 283; Fitting Position: Front Axle | 13.0460-3870.2 603870 | Brake System: Bosch 25895 18,5 Wear Warning Contact: not prepared for wear indicator / excl. wear warning contact Supplementary Article/Supplementary Info: with accessories |
| 1.6 PureTech 225 | 165 | 01/18→06/21 | | | | | | |
| 1.6 THP | 112 | 09/13→06/21 | | | | | | |
| 2.0 GT BlueHDi 180 | 130 - 132 | 06/17→06/21 | | | | | | |
| | | | | | | for brake disc diameter [mm]: 330; Fitting Position: Front Axle | 13.0460-3876.2 603876 | Brake System: Bosch 22218 18,3 Wear Warning Contact: prepared for wear indicator / excl. wear warning contact Supplementary Article/Supplementary Info: with accessories |
| | | | | | | for brake disc diameter [mm]: 268; Vehicle Equipment: for vehicles with electric parking brake; Fitting Position: Rear Axle | 13.0460-3871.2 603871 | Brake System: Bosch 25839 17,8 Wear Warning Contact: not prepared for wear indicator / excl. wear warning contact Supplementary Article/Supplementary Info: with accessories |
| | | | for brake disc diameter [mm]: 290; Vehicle Equipment: for vehicles with electric parking brake; Fitting Position: Rear Axle | 13.0460-3872.2 603872 | Brake System: Bosch 25827 17,7 Wear Warning Contact: not prepared for wear indicator / excl. wear warning contact Supplementary Article/Supplementary Info: with accessories | | | |
| | | | | 13.0470-3871.2 LD3871 | Brake System: Bosch 25839 17,8 Wear Warning Contact: not prepared for wear indicator / excl. wear warning contact Supplementary Article/Supplementary Info: with accessories Ceramic | | | |
| | | | | 13.0470-3872.2 LD3872 | Brake System: Bosch 25827 17,7 Wear Warning Contact: not prepared for wear indicator / excl. wear warning contact Supplementary Article/Supplementary Info: with accessories Ceramic | | | |
|  Brake Disc | | | | | | | | |
| 1.2 THP 110 | 81 | 11/13→06/21 | Fitting Position: Front Axle | 24.0126-0183.1 426183 | Outer diameter [mm]: 283 Brake Disc Thickness [mm] 26 Minimum thickness [mm] 24 Brake Disc Type: Vented Supplementary Article/Info 2: with bolts/screws | | | |
| 1.2 THP 130 | 96 | 11/13→06/21 | | | | | | |
| 1.2 VTi 72 | 60 | 09/13→06/21 | | | | | | |
| 1.5 BlueHDi 100 | 75 | 05/18→06/21 | | | | | | |
| 1.5 BlueHDi 130 | 96 | 06/17→06/21 | | | | | | |
| 1.6 BlueHDi 120 | 88 | 11/13→06/21 | | | | | | |



| | | kW | | | | | |
|--|-------------------|--|------------------------------|---|--|--|--|
| PEUGEOT - 308 II (LB_, LP_, LW_, LH_, L3_) 09/13→06/21 | | | | | | | |
|  Brake Disc | | | | | | | |
| 1.6 GT 205 | 151 06/14→06/21 | Fitting Position: Front Axle | 24.0128-0269.1 428269 | Outer diameter [mm]: 304 Brake Disc Thickness [mm] 28 Minimum thickness [mm] 26 Brake Disc Type: Vented Supplementary Article/Info 2: with bolts/screws | | | |
| 1.6 GTi | 184 08/15→06/21 | | | | | | |
| 1.6 GTi PureTech 263 | 193 07/18→06/21 | | | | | | |
| 1.6 HDi | 68 09/13→06/21 | | | | | | |
| 1.6 HDi / BlueHDi 115 | 85 09/13→06/21 | | | | | | |
| 1.6 HDi 100 | 73 04/14→06/21 | | | | | | |
| 1.6 PureTech 225 | 165 01/18→06/21 | | | | | | |
| 1.6 THP | 112 - 09/13→06/21 | | | | | | |
| | 115 | | | | | | |
| 1.6 THP 125 | 92 09/13→06/21 | | | | | | |
| 1.6 THP 150 | 110 03/14→06/21 | | | | | | |
| 1.6 THP 163 | 120 06/14→06/21 | | | | | | |
| 1.6 VTi 115 | 85 05/15→06/21 | | | | | | |
| 2.0 BlueHDi 150 | 110 11/13→06/21 | | | | | | |
| 2.0 GT BlueHDi 180 | 130 - 06/14→06/21 | | | | | | |
| | 133 | Fitting Position: Rear Axle | 24.0112-0211.1 412211 | Outer diameter [mm]: 268 Brake Disc Thickness [mm] 12 Minimum thickness [mm] 10 Brake Disc Type: Solid Supplementary Article/Info 2: with bolts/screws | | | |
| | | | 24.0112-0212.1 412212 | Outer diameter [mm]: 290 Brake Disc Thickness [mm] 12 Minimum thickness [mm] 10 Brake Disc Type: Solid Supplementary Article/Info 2: with bolts/screws | | | |
| 1.6 GTi | 200 06/15→06/21 | for PR number: 283; Fitting Position: Front Axle | 24.0126-0183.1 426183 | Outer diameter [mm]: 283 Brake Disc Thickness [mm] 26 Minimum thickness [mm] 24 Brake Disc Type: Vented Supplementary Article/Info 2: with bolts/screws | | | |
| | | Fitting Position: Front Axle | 24.0128-0269.1 428269 | Outer diameter [mm]: 304 Brake Disc Thickness [mm] 28 Minimum thickness [mm] 26 Brake Disc Type: Vented Supplementary Article/Info 2: with bolts/screws | | | |
| | | | 24.0130-0241.1 430241 | Outer diameter [mm]: 330 Brake Disc Thickness [mm] 30 Minimum thickness [mm] 28 Brake Disc Type: Vented Supplementary Article/Info 2: with bolts/screws | | | |
| | | Fitting Position: Rear Axle | 24.0112-0211.1 412211 | Outer diameter [mm]: 268 Brake Disc Thickness [mm] 12 Minimum thickness [mm] 10 Brake Disc Type: Solid Supplementary Article/Info 2: with bolts/screws | | | |
| | | | 24.0112-0212.1 412212 | Outer diameter [mm]: 290 Brake Disc Thickness [mm] 12 Minimum thickness [mm] 10 Brake Disc Type: Solid Supplementary Article/Info 2: with bolts/screws | | | |
| PEUGEOT - 308 III (FB_, FH_, FP_, F3_) 07/21→ | | | | | | | |
|  Brake Pad Set, disc brake | | | | | | | |
| BlueHDi 130 | 96 07/21→ | for brake disc diameter [mm]: 283; Fitting Position: Front Axle | 13.0460-3870.2 603870 | Brake System: Bosch 25895 18,5 Wear Warning Contact: not prepared for wear indicator / excl. wear warning contact Supplementary Article/Supplementary Info: with accessories | | | |
| Hybrid 180 | 110 - 07/21→ | | | | | | |
| | 133 | | | | | | |
| Hybrid 225 | 132 - 07/21→ | | | | | | |
| | 165 | | | | | | |
| PureTech 110 | 81 07/21→ | | | | | | |
| PureTech 130 | 96 07/21→ | | 13.0470-3870.2 LD3870 | Brake System: Bosch 25895 18,5 Wear Warning Contact: not prepared for wear indicator / excl. wear warning contact Supplementary Article/Supplementary Info: with accessories Ceramic | | | |
| | | for brake disc diameter [mm]: 330; Fitting Position: Front Axle | 13.0460-3876.2 603876 | Brake System: Bosch 22218 18,3 Wear Warning Contact: prepared for wear indicator / excl. wear warning contact Supplementary Article/Supplementary Info: with accessories | | | |
| → | | | | | | | |

| | kW | | | |
|--|---|--|--|---|
| PEUGEOT - 308 III (FB_, FH_, FP_, F3_) 07/21→ | | | | |
|  Brake Pad Set, disc brake | | | | |
| BlueHDi 130 Hybrid 180 Hybrid 225 PureTech 110 PureTech 130 | 96 07/21→ 110 - 07/21→ 133 132 - 07/21→ 165 81 07/21→ 96 07/21→ | for brake disc diameter [mm]: 268; Fitting Position: Rear Axle | 13.0460-3871.2 603871 13.0470-3871.2 LD3871 | Brake System: Bosch 25839 17,8 Wear Warning Contact: not prepared for wear indicator / excl. wear warning contact Supplementary Article/Supplementary Info: with accessories Brake System: Bosch 25839 17,8 Wear Warning Contact: not prepared for wear indicator / excl. wear warning contact Supplementary Article/Supplementary Info: with accessories Ceramic |
| | | for brake disc diameter [mm]: 290; Fitting Position: Rear Axle | 13.0460-3872.2 603872 13.0470-3872.2 LD3872 | Brake System: Bosch 25827 17,7 Wear Warning Contact: not prepared for wear indicator / excl. wear warning contact Supplementary Article/Supplementary Info: with accessories Brake System: Bosch 25827 17,7 Wear Warning Contact: not prepared for wear indicator / excl. wear warning contact Supplementary Article/Supplementary Info: with accessories Ceramic |
|  Brake Disc | | | | |
| BlueHDi 130 Hybrid 180 Hybrid 225 PureTech 110 PureTech 130 | 96 07/21→ 110 - 07/21→ 133 132 - 07/21→ 165 81 07/21→ 96 07/21→ | Fitting Position: Front Axle | 24.0126-0183.1 426183 24.0128-0269.1 428269 24.0130-0241.1 430241 | Outer diameter [mm]: 283 Brake Disc Thickness [mm] 26 Minimum thickness [mm] 24 Brake Disc Type: Vented Supplementary Article/Info 2: with bolts/screws Outer diameter [mm]: 304 Brake Disc Thickness [mm] 28 Minimum thickness [mm] 26 Brake Disc Type: Vented Supplementary Article/Info 2: with bolts/screws Outer diameter [mm]: 330 Brake Disc Thickness [mm] 30 Minimum thickness [mm] 28 Brake Disc Type: Vented Supplementary Article/Info 2: with bolts/screws |
| | | Fitting Position: Rear Axle | 24.0112-0211.1 412211 24.0112-0212.1 412212 | Outer diameter [mm]: 268 Brake Disc Thickness [mm] 12 Minimum thickness [mm] 10 Brake Disc Type: Solid Supplementary Article/Info 2: with bolts/screws Outer diameter [mm]: 290 Brake Disc Thickness [mm] 12 Minimum thickness [mm] 10 Brake Disc Type: Solid Supplementary Article/Info 2: with bolts/screws |
| PEUGEOT - 308 Hatchback Van (LB_) 03/15→ | | | | |
|  Brake Pad Set, disc brake | | | | |
| 1.5 BlueHDi 130 1.6 BlueHDi 120 1.6 e-HDi 115 | 96 06/17→06/21 88 03/15→06/21 85 03/15→06/21 | for brake disc diameter [mm]: 283; Fitting Position: Front Axle | 13.0460-3870.2 603870 13.0470-3870.2 LD3870 | Brake System: Bosch 25895 18,5 Wear Warning Contact: not prepared for wear indicator / excl. wear warning contact Supplementary Article/Supplementary Info: with accessories Brake System: Bosch 25895 18,5 Wear Warning Contact: not prepared for wear indicator / excl. wear warning contact Supplementary Article/Supplementary Info: with accessories Ceramic |
| → | | | | |



| | kW | | | | |
|--|--|---|--|--|---|
| PEUGEOT - 308 Hatchback Van (LB_) 03/15→ | | | | | |
|  Brake Pad Set, disc brake | | | | | |
| 1.5 BlueHDi 130 1.6 BlueHDi 120 1.6 e-HDi 115 | 96 06/17→06/21 88 03/15→06/21 85 03/15→06/21 | for brake disc diameter [mm]: 330; Fitting Position: Front Axle | | 13.0460-3876.2 603876 | Brake System: Bosch 22218 18,3 Wear Warning Contact: prepared for wear indicator / excl. wear warning contact Supplementary Article/Supplementary Info: with accessories |
| | | for brake disc diameter [mm]: 268; Vehicle Equipment: for vehicles with electric parking brake; Fitting Position: Rear Axle | | 13.0460-3871.2 603871 13.0470-3871.2 LD3871 | Brake System: Bosch 25839 17,8 Wear Warning Contact: not prepared for wear indicator / excl. wear warning contact Supplementary Article/Supplementary Info: with accessories Brake System: Bosch 25839 17,8 Wear Warning Contact: not prepared for wear indicator / excl. wear warning contact Supplementary Article/Supplementary Info: with accessories Ceramic |
| | | for brake disc diameter [mm]: 290; Fitting Position: Rear Axle | | 13.0460-3872.2 603872 13.0470-3872.2 LD3872 | Brake System: Bosch 25827 17,7 Wear Warning Contact: not prepared for wear indicator / excl. wear warning contact Supplementary Article/Supplementary Info: with accessories Brake System: Bosch 25827 17,7 Wear Warning Contact: not prepared for wear indicator / excl. wear warning contact Supplementary Article/Supplementary Info: with accessories Ceramic |
|  Brake Disc | | | | | |
| 1.5 BlueHDi 130 1.6 BlueHDi 120 1.6 e-HDi 115 | 96 06/17→06/21 88 03/15→06/21 85 03/15→06/21 | Fitting Position: Front Axle | | 24.0126-0183.1 426183 24.0128-0269.1 428269 24.0130-0241.1 430241 | Outer diameter [mm]: 283 Brake Disc Thickness [mm] 26 Minimum thickness [mm] 24 Brake Disc Type: Vented Supplementary Article/Info 2: with bolts/screws Outer diameter [mm]: 304 Brake Disc Thickness [mm] 28 Minimum thickness [mm] 26 Brake Disc Type: Vented Supplementary Article/Info 2: with bolts/screws Outer diameter [mm]: 330 Brake Disc Thickness [mm] 30 Minimum thickness [mm] 28 Brake Disc Type: Vented Supplementary Article/Info 2: with bolts/screws |
| | | Fitting Position: Rear Axle | | 24.0112-0211.1 412211 24.0112-0212.1 412212 | Outer diameter [mm]: 268 Brake Disc Thickness [mm] 12 Minimum thickness [mm] 10 Brake Disc Type: Solid Supplementary Article/Info 2: with bolts/screws Outer diameter [mm]: 290 Brake Disc Thickness [mm] 12 Minimum thickness [mm] 10 Brake Disc Type: Solid Supplementary Article/Info 2: with bolts/screws |
| PEUGEOT - 308 SW II (LC_, LJ_, LR_, LX_, L4_) 03/14→06/21 | | | | | |
|  Brake Pad Set, disc brake | | | | | |
| 1.2 THP 110 | 81 03/14→06/21 | Construction year from: 08/14 →; for brake disc diameter [mm]: 283; Fitting Position: Front Axle | | 13.0460-3870.2 603870 | Brake System: Bosch 25895 18,5 Wear Warning Contact: not prepared for wear indicator / excl. wear warning contact Supplementary Article/Supplementary Info: with accessories |
| → | | | | | |



| | kW | | | | | |
|---|--|------------------------------------|--|--|---|---|
| PEUGEOT - 308 SW II (LC_, LJ_, LR_, LX_, L4_) 03/14→06/21 | | | | | | |
|  Brake Pad Set, disc brake | | | | | | |
| 1.2 THP 110 | 81 03/14→06/21 | Construction year from: 08/14 →; | for brake disc diameter [mm]: 283; | Fitting Position: Front Axle | 13.0470-3870.2 LD3870 Brake System: Bosch 25895 18,5 Wear Warning Contact: not prepared for wear indicator / excl. wear warning contact Supplementary Article/Supplementary Info: with accessories Ceramic | |
| | | | for brake disc diameter [mm]: 330; | Fitting Position: Front Axle | 13.0460-3876.2 603876 Brake System: Bosch 22218 18,3 Wear Warning Contact: prepared for wear indicator / excl. wear warning contact Supplementary Article/Supplementary Info: with accessories | |
| | | Construction year from: 08/14 →; | for brake disc diameter [mm]: 268; | Vehicle Equipment: for vehicles with electric parking brake; | Fitting Position: Rear Axle | 13.0460-3871.2 603871 Brake System: Bosch 25839 17,8 Wear Warning Contact: not prepared for wear indicator / excl. wear warning contact Supplementary Article/Supplementary Info: with accessories 13.0470-3871.2 LD3871 Brake System: Bosch 25839 17,8 Wear Warning Contact: not prepared for wear indicator / excl. wear warning contact Supplementary Article/Supplementary Info: with accessories Ceramic |
| | | Construction year from: 08/14 →; | for brake disc diameter [mm]: 290; | Fitting Position: Rear Axle | 13.0460-3872.2 603872 Brake System: Bosch 25827 17,7 Wear Warning Contact: not prepared for wear indicator / excl. wear warning contact Supplementary Article/Supplementary Info: with accessories 13.0470-3872.2 LD3872 Brake System: Bosch 25827 17,7 Wear Warning Contact: not prepared for wear indicator / excl. wear warning contact Supplementary Article/Supplementary Info: with accessories Ceramic | |
| 1.2 THP 130 1.5 BlueHDi 100 1.5 BlueHDi 130 1.6 BlueHDi 100 1.6 BlueHDi 120 1.6 GT 205 1.6 HDi / BlueHDi 115 1.6 HDi 92 1.6 THP 125 1.6 THP 150 1.6 THP 155 1.6 VTi 2.0 BlueHDi 150 2.0 GT BlueHDi 180 2.0 GT HDi 180 / BlueHDi 180 | 96 03/14→06/21 75 04/18→06/21 96 06/17→06/21 73 04/14→06/21 88 03/14→06/21 151 02/15→06/21 85 03/14→06/21 68 03/14→06/21 92 03/14→06/21 110 03/14→06/21 115 03/14→06/21 85 03/14→06/21 110 03/14→06/21 132 06/17→06/21 133 06/14→06/21 | for brake disc diameter [mm]: 283; | Fitting Position: Front Axle | | 13.0460-3870.2 603870 Brake System: Bosch 25895 18,5 Wear Warning Contact: not prepared for wear indicator / excl. wear warning contact Supplementary Article/Supplementary Info: with accessories 13.0470-3870.2 LD3870 Brake System: Bosch 25895 18,5 Wear Warning Contact: not prepared for wear indicator / excl. wear warning contact Supplementary Article/Supplementary Info: with accessories Ceramic | |
| | | for brake disc diameter [mm]: 330; | Fitting Position: Front Axle | | 13.0460-3876.2 603876 Brake System: Bosch 22218 18,3 Wear Warning Contact: prepared for wear indicator / excl. wear warning contact Supplementary Article/Supplementary Info: with accessories | |
| | | for brake disc diameter [mm]: 268; | Vehicle Equipment: for vehicles with electric parking brake; | Fitting Position: Rear Axle | 13.0460-3871.2 603871 Brake System: Bosch 25839 17,8 Wear Warning Contact: not prepared for wear indicator / excl. wear warning contact Supplementary Article/Supplementary Info: with accessories 13.0470-3871.2 LD3871 Brake System: Bosch 25839 17,8 Wear Warning Contact: not prepared for wear indicator / excl. wear warning contact Supplementary Article/Supplementary Info: with accessories Ceramic | |
| | | for brake disc diameter [mm]: 290; | Fitting Position: Rear Axle | | 13.0460-3872.2 603872 Brake System: Bosch 25827 17,7 Wear Warning Contact: not prepared for wear indicator / excl. wear warning contact Supplementary Article/Supplementary Info: with accessories | |





→



| | | kW | | | | | |
|--|-----------------|--|--|------------------------------|--|--|--|
| PEUGEOT - 308 SW II (LC_, LJ_, LR_, LX_, L4_) 03/14→06/21 | | | | | | | |
|  Brake Pad Set, disc brake | | | | | | | |
| 1.2 THP 130 | 96 03/14→06/21 | for brake disc diameter [mm]: 290; | | 13.0470-3872.2 LD3872 | Brake System: Bosch 25827 17,7 | | |
| 1.5 BlueHDi 100 | 75 04/18→06/21 | Fitting Position: Rear Axle | | | Wear Warning Contact: not prepared for wear indicator / excl. wear warning contact | | |
| 1.5 BlueHDi 130 | 96 06/17→06/21 | | | | Supplementary Article/Supplementary Info: with accessories | | |
| 1.6 BlueHDi 100 | 73 04/14→06/21 | | | | Ceramic | | |
| 1.6 BlueHDi 120 | 88 03/14→06/21 | | | | | | |
| 1.6 GT 205 | 151 02/15→06/21 | | | | | | |
| 1.6 HDi / BlueHDi 115 | 85 03/14→06/21 | | | | | | |
| 1.6 HDi 92 | 68 03/14→06/21 | | | | | | |
| 1.6 THP 125 | 92 03/14→06/21 | | | | | | |
| 1.6 THP 150 | 110 03/14→06/21 | | | | | | |
| 1.6 THP 155 | 115 03/14→06/21 | | | | | | |
| 1.6 VTi | 85 03/14→06/21 | | | | | | |
| 2.0 BlueHDi 150 | 110 03/14→06/21 | | | | | | |
| 2.0 GT BlueHDi 180 | 132 06/17→06/21 | | | | | | |
| 2.0 GT HDi 180 / BlueHDi 180 | 133 06/14→06/21 | | | | | | |
| 1.6 PureTech 225 | 165 01/18→06/21 | for brake disc diameter [mm]: 283; | | 13.0460-3870.2 603870 | Brake System: Bosch 25895 18,5 | | |
| 2.0 GT BlueHDi 180 | 130 06/17→06/21 | Fitting Position: Front Axle | | | Wear Warning Contact: not prepared for wear indicator / excl. wear warning contact | | |
| | | | | 13.0470-3870.2 LD3870 | Supplementary Article/Supplementary Info: with accessories | | |
| | | | | | Brake System: Bosch 25895 18,5 | | |
| | | | | | Wear Warning Contact: not prepared for wear indicator / excl. wear warning contact | | |
| | | | | | Supplementary Article/Supplementary Info: with accessories | | |
| | | for brake disc diameter [mm]: 330; | | 13.0460-3876.2 603876 | Brake System: Bosch 22218 18,3 | | |
| | | Fitting Position: Front Axle | | | Wear Warning Contact: prepared for wear indicator / excl. wear warning contact | | |
| | | | | | Supplementary Article/Supplementary Info: with accessories | | |
| | | for brake disc diameter [mm]: 268; | | 13.0460-3871.2 603871 | Brake System: Bosch 25839 17,8 | | |
| | | Vehicle Equipment: for vehicles with electric parking brake; | | | Wear Warning Contact: not prepared for wear indicator / excl. wear warning contact | | |
| | | Fitting Position: Rear Axle | | | Supplementary Article/Supplementary Info: with accessories | | |
| | | | | 13.0470-3871.2 LD3871 | Brake System: Bosch 25839 17,8 | | |
| | | | | | Wear Warning Contact: not prepared for wear indicator / excl. wear warning contact | | |
| | | | | | Supplementary Article/Supplementary Info: with accessories | | |
| | | for brake disc diameter [mm]: 290; | | 13.0460-3872.2 603872 | Brake System: Bosch 25827 17,7 | | |
| | | Vehicle Equipment: for vehicles with electric parking brake; | | | Wear Warning Contact: not prepared for wear indicator / excl. wear warning contact | | |
| | | Fitting Position: Rear Axle | | | Supplementary Article/Supplementary Info: with accessories | | |
| | | | | 13.0470-3872.2 LD3872 | Brake System: Bosch 25827 17,7 | | |
| | | | | | Wear Warning Contact: not prepared for wear indicator / excl. wear warning contact | | |
| | | | | | Supplementary Article/Supplementary Info: with accessories | | |
| | | | | | Ceramic | | |
|  Brake Disc | | | | | | | |
| 1.2 THP 110 | 81 03/14→06/21 | Construction year from: 08/14 →; | | 24.0126-0183.1 426183 | Outer diameter [mm]: 283 | | |
| | | Fitting Position: Front Axle | | | Brake Disc Thickness [mm] 26 | | |
| | | | | | Minimum thickness [mm] 24 | | |
| | | | | | Brake Disc Type: Vented | | |
| | | | | | Supplementary Article/Info 2: with bolts/screws | | |
| | | | | 24.0128-0269.1 428269 | Outer diameter [mm]: 304 | | |
| | | | | | Brake Disc Thickness [mm] 28 | | |
| | | | | | Minimum thickness [mm] 26 | | |
| | | | | | Brake Disc Type: Vented | | |
| | | | | | Supplementary Article/Info 2: with bolts/screws | | |

| | kW | | | | | | |
|---|---|----------------------------------|------------------------------|----------------------------------|---|------------------------------|---|
| PEUGEOT - 308 SW II (LC_, LJ_, LR_, LX_, L4_) 03/14→06/21 | | | | | | | |
|  Brake Disc | | | | | | | |
| 1.2 THP 110 | 81 03/14→06/21 | Construction year from: 08/14 →; | Fitting Position: Front Axle | 24.0130-0241.1 430241 | Outer diameter [mm]: 330 Brake Disc Thickness [mm] 30 Minimum thickness [mm] 28 Brake Disc Type: Vented Supplementary Article/Info 2: with bolts/screws | | |
| | | Construction year from: 08/14 →; | Fitting Position: Rear Axle | 24.0112-0211.1 412211 | Outer diameter [mm]: 268 Brake Disc Thickness [mm] 12 Minimum thickness [mm] 10 Brake Disc Type: Solid Supplementary Article/Info 2: with bolts/screws | | |
| | | | Fitting Position: Rear Axle | 24.0112-0212.1 412212 | Outer diameter [mm]: 290 Brake Disc Thickness [mm] 12 Minimum thickness [mm] 10 Brake Disc Type: Solid Supplementary Article/Info 2: with bolts/screws | | |
| 1.2 THP 130 1.5 BlueHDi 100 1.5 BlueHDi 130 1.6 BlueHDi 100 1.6 BlueHDi 120 1.6 GT 205 1.6 HDi / BlueHDi 115 1.6 HDi 92 1.6 PureTech 225 1.6 THP 125 1.6 THP 150 1.6 THP 155 1.6 VTi 2.0 BlueHDi 150 2.0 GT BlueHDi 180 | 96 03/14→06/21 75 04/18→06/21 96 06/17→06/21 73 04/14→06/21 88 03/14→06/21 151 02/15→06/21 85 03/14→06/21 68 03/14→06/21 165 01/18→06/21 92 03/14→06/21 110 03/14→06/21 115 03/14→06/21 85 03/14→06/21 110 03/14→06/21 130 - 06/17→06/21 132 | Fitting Position: Front Axle | | 24.0126-0183.1 426183 | Outer diameter [mm]: 283 Brake Disc Thickness [mm] 26 Minimum thickness [mm] 24 Brake Disc Type: Vented Supplementary Article/Info 2: with bolts/screws | | |
| | | Fitting Position: Rear Axle | | 24.0128-0269.1 428269 | Outer diameter [mm]: 304 Brake Disc Thickness [mm] 28 Minimum thickness [mm] 26 Brake Disc Type: Vented Supplementary Article/Info 2: with bolts/screws | | |
| | | Fitting Position: Rear Axle | | 24.0130-0241.1 430241 | Outer diameter [mm]: 330 Brake Disc Thickness [mm] 30 Minimum thickness [mm] 28 Brake Disc Type: Vented Supplementary Article/Info 2: with bolts/screws | | |
| | | Fitting Position: Rear Axle | | 24.0112-0211.1 412211 | Outer diameter [mm]: 268 Brake Disc Thickness [mm] 12 Minimum thickness [mm] 10 Brake Disc Type: Solid Supplementary Article/Info 2: with bolts/screws | | |
| | | Fitting Position: Rear Axle | | 24.0112-0212.1 412212 | Outer diameter [mm]: 290 Brake Disc Thickness [mm] 12 Minimum thickness [mm] 10 Brake Disc Type: Solid Supplementary Article/Info 2: with bolts/screws | | |
| | | 2.0 GT HDi 180 / BlueHDi 180 | 133 06/14→06/21 | Fitting Position: Front Axle | | 24.0126-0183.1 426183 | Outer diameter [mm]: 283 Brake Disc Thickness [mm] 26 Minimum thickness [mm] 24 Brake Disc Type: Vented Supplementary Article/Info 2: with bolts/screws |
| | | | | Fitting Position: Rear Axle | | 24.0128-0269.1 428269 | Outer diameter [mm]: 304 Brake Disc Thickness [mm] 28 Minimum thickness [mm] 26 Brake Disc Type: Vented Supplementary Article/Info 2: with bolts/screws |
| | | | | Fitting Position: Rear Axle | | 24.0130-0241.1 430241 | Outer diameter [mm]: 330 Brake Disc Thickness [mm] 30 Minimum thickness [mm] 28 Brake Disc Type: Vented Supplementary Article/Info 2: with bolts/screws |
| | | | | Construction year from: 09/14 →; | Fitting Position: Rear Axle | 24.0112-0211.1 412211 | Outer diameter [mm]: 268 Brake Disc Thickness [mm] 12 Minimum thickness [mm] 10 Brake Disc Type: Solid Supplementary Article/Info 2: with bolts/screws |
| | | | | | Fitting Position: Rear Axle | 24.0112-0212.1 412212 | Outer diameter [mm]: 290 Brake Disc Thickness [mm] 12 Minimum thickness [mm] 10 Brake Disc Type: Solid Supplementary Article/Info 2: with bolts/screws |



| | | kW | | | | | |
|--|----------------------------------|---|--|------------------------------|---|--|--|
| PEUGEOT - 308 SW II Estate Van (LC_) 04/14→ | | | | | | | |
|  Brake Pad Set, disc brake | | | | | | | |
| 1.5 BlueHDi 130 1.6 BlueHDi | 96 06/17→06/21 73 04/14→06/21 | for brake disc diameter [mm]: 283; Fitting Position: Front Axle | | 13.0460-3870.2 603870 | Brake System: Bosch 25895 18,5 Wear Warning Contact: not prepared for wear indicator / excl. wear warning contact Supplementary Article/Supplementary Info: with accessories | | |
| | | | | 13.0470-3870.2 LD3870 | Brake System: Bosch 25895 18,5 Wear Warning Contact: not prepared for wear indicator / excl. wear warning contact Supplementary Article/Supplementary Info: with accessories Ceramic | | |
| | | for brake disc diameter [mm]: 330; Fitting Position: Front Axle | | 13.0460-3876.2 603876 | Brake System: Bosch 22218 18,3 Wear Warning Contact: prepared for wear indicator / excl. wear warning contact Supplementary Article/Supplementary Info: with accessories | | |
| | | for brake disc diameter [mm]: 268; Vehicle Equipment: for vehicles with electric parking brake; Fitting Position: Rear Axle | | 13.0460-3871.2 603871 | Brake System: Bosch 25839 17,8 Wear Warning Contact: not prepared for wear indicator / excl. wear warning contact Supplementary Article/Supplementary Info: with accessories | | |
| | | | | 13.0470-3871.2 LD3871 | Brake System: Bosch 25839 17,8 Wear Warning Contact: not prepared for wear indicator / excl. wear warning contact Supplementary Article/Supplementary Info: with accessories Ceramic | | |
| | | for brake disc diameter [mm]: 290; Fitting Position: Rear Axle | | 13.0460-3872.2 603872 | Brake System: Bosch 25827 17,7 Wear Warning Contact: not prepared for wear indicator / excl. wear warning contact Supplementary Article/Supplementary Info: with accessories | | |
| | | | | 13.0470-3872.2 LD3872 | Brake System: Bosch 25827 17,7 Wear Warning Contact: not prepared for wear indicator / excl. wear warning contact Supplementary Article/Supplementary Info: with accessories Ceramic | | |
|  Brake Disc | | | | | | | |
| 1.5 BlueHDi 130 1.6 BlueHDi | 96 06/17→06/21 73 04/14→06/21 | Fitting Position: Front Axle | | 24.0126-0183.1 426183 | Outer diameter [mm]: 283 Brake Disc Thickness [mm] 26 Minimum thickness [mm] 24 Brake Disc Type: Vented Supplementary Article/Info 2: with bolts/screws | | |
| | | | | 24.0128-0269.1 428269 | Outer diameter [mm]: 304 Brake Disc Thickness [mm] 28 Minimum thickness [mm] 26 Brake Disc Type: Vented Supplementary Article/Info 2: with bolts/screws | | |
| | | | | 24.0130-0241.1 430241 | Outer diameter [mm]: 330 Brake Disc Thickness [mm] 30 Minimum thickness [mm] 28 Brake Disc Type: Vented Supplementary Article/Info 2: with bolts/screws | | |
| | | Fitting Position: Rear Axle | | 24.0112-0211.1 412211 | Outer diameter [mm]: 268 Brake Disc Thickness [mm] 12 Minimum thickness [mm] 10 Brake Disc Type: Solid Supplementary Article/Info 2: with bolts/screws | | |
| | | | | 24.0112-0212.1 412212 | Outer diameter [mm]: 290 Brake Disc Thickness [mm] 12 Minimum thickness [mm] 10 Brake Disc Type: Solid Supplementary Article/Info 2: with bolts/screws | | |



| | | kW | | | | | |
|--|--------------|--|------------------------------|---|--|--|--|
| PEUGEOT - 308 SW III (FC_, FJ_, FR_, F4_) 07/21→ | | | | | | | |
|  Brake Pad Set, disc brake | | | | | | | |
| BlueHDi 130 | 96 07/21→ | for brake disc diameter [mm]: 283; Fitting Position: Front Axle | 13.0460-3870.2 603870 | Brake System: Bosch 25895 18,5 Wear Warning Contact: not prepared for wear indicator / excl. wear warning contact Supplementary Article/Supplementary Info: with accessories | | | |
| Hybrid 180 | 110 - 07/21→ | | | | | | |
| | 133 | | | | | | |
| Hybrid 225 | 132 - 07/21→ | | | | | | |
| | 165 | for brake disc diameter [mm]: 330; Fitting Position: Front Axle | 13.0470-3870.2 LD3870 | Brake System: Bosch 25895 18,5 Wear Warning Contact: not prepared for wear indicator / excl. wear warning contact Supplementary Article/Supplementary Info: with accessories Ceramic | | | |
| PureTech 110 | 81 07/21→ | | | | | | |
| PureTech 130 | 96 07/21→ | | | | | | |
| | | | | | | | |
| | | for brake disc diameter [mm]: 268; Fitting Position: Rear Axle | 13.0460-3876.2 603876 | Brake System: Bosch 22218 18,3 Wear Warning Contact: prepared for wear indicator / excl. wear warning contact Supplementary Article/Supplementary Info: with accessories | | | |
| | | | | | | | |
| | | | | | | | |
| | | | | | | | |
| | | for brake disc diameter [mm]: 268; Fitting Position: Rear Axle | 13.0460-3871.2 603871 | Brake System: Bosch 25839 17,8 Wear Warning Contact: not prepared for wear indicator / excl. wear warning contact Supplementary Article/Supplementary Info: with accessories | | | |
| | | | | | | | |
| | | | | | | | |
| | | | | | | | |
| | | for brake disc diameter [mm]: 290; Fitting Position: Rear Axle | 13.0460-3872.2 603872 | Brake System: Bosch 25827 17,7 Wear Warning Contact: not prepared for wear indicator / excl. wear warning contact Supplementary Article/Supplementary Info: with accessories | | | |
| | | | | | | | |
| | | | | | | | |
| | | | | | | | |
| | | for brake disc diameter [mm]: 290; Fitting Position: Rear Axle | 13.0470-3872.2 LD3872 | Brake System: Bosch 25827 17,7 Wear Warning Contact: not prepared for wear indicator / excl. wear warning contact Supplementary Article/Supplementary Info: with accessories Ceramic | | | |
| | | | | | | | |
| | | | | | | | |
| | | | | | | | |
|  Brake Disc | | | | | | | |
| BlueHDi 130 | 96 07/21→ | Fitting Position: Front Axle | 24.0126-0183.1 426183 | Outer diameter [mm]: 283 Brake Disc Thickness [mm] 26 Minimum thickness [mm] 24 Brake Disc Type: Vented Supplementary Article/Info 2: with bolts/screws | | | |
| Hybrid 180 | 110 - 07/21→ | | | | | | |
| | 133 | | | | | | |
| Hybrid 225 | 132 - 07/21→ | | | | | | |
| | 165 | Fitting Position: Front Axle | 24.0128-0269.1 428269 | Outer diameter [mm]: 304 Brake Disc Thickness [mm] 28 Minimum thickness [mm] 26 Brake Disc Type: Vented Supplementary Article/Info 2: with bolts/screws | | | |
| PureTech 110 | 81 07/21→ | | | | | | |
| PureTech 130 | 96 07/21→ | | | | | | |
| | | | | | | | |
| | | Fitting Position: Front Axle | 24.0130-0241.1 430241 | Outer diameter [mm]: 330 Brake Disc Thickness [mm] 30 Minimum thickness [mm] 28 Brake Disc Type: Vented Supplementary Article/Info 2: with bolts/screws | | | |
| | | | | | | | |
| | | | | | | | |
| | | | | | | | |
| | | Fitting Position: Rear Axle | 24.0112-0211.1 412211 | Outer diameter [mm]: 268 Brake Disc Thickness [mm] 12 Minimum thickness [mm] 10 Brake Disc Type: Solid Supplementary Article/Info 2: with bolts/screws | | | |
| | | | | | | | |
| | | | | | | | |
| | | | | | | | |
| | | Fitting Position: Rear Axle | 24.0112-0212.1 412212 | Outer diameter [mm]: 290 Brake Disc Thickness [mm] 12 Minimum thickness [mm] 10 Brake Disc Type: Solid Supplementary Article/Info 2: with bolts/screws | | | |
| | | | | | | | |
| | | | | | | | |
| | | | | | | | |







| | kW | | | | |
|--|-----------|-------------|--|------------------------------|---|
| PEUGEOT - 407 (6D_) 02/04→12/11 | | | | | |
|  Brake Disc | | | | | |
| 2.0 HDi | 120 | 06/09→12/10 | Fitting Position: Front Axle | 24.0128-0269.1 428269 | Outer diameter [mm]: 304 Brake Disc Thickness [mm] 28 Minimum thickness [mm] 26 Brake Disc Type: Vented Supplementary Article/Info 2: with bolts/screws |
| PEUGEOT - 407 SW (6E_) 05/04→12/11 | | | | | |
|  Brake Disc | | | | | |
| 2.0 HDi | 120 | 06/09→12/10 | Fitting Position: Front Axle | 24.0128-0269.1 428269 | Outer diameter [mm]: 304 Brake Disc Thickness [mm] 28 Minimum thickness [mm] 26 Brake Disc Type: Vented Supplementary Article/Info 2: with bolts/screws |
| PEUGEOT - 407 SW Estate Van (6E_) 08/04→12/10 | | | | | |
|  Brake Disc | | | | | |
| 2.0 HDi | 120 | 06/09→12/10 | Fitting Position: Front Axle | 24.0128-0269.1 428269 | Outer diameter [mm]: 304 Brake Disc Thickness [mm] 28 Minimum thickness [mm] 26 Brake Disc Type: Vented Supplementary Article/Info 2: with bolts/screws |
| PEUGEOT - 508 I (8D_) 11/10→12/18 | | | | | |
|  Brake Disc | | | | | |
| 1.6 BlueHDi 120 | 88 | 03/14→12/18 | Fitting Position: Front Axle | 24.0128-0269.1 428269 | Outer diameter [mm]: 304 Brake Disc Thickness [mm] 28 Minimum thickness [mm] 26 Brake Disc Type: Vented Supplementary Article/Info 2: with bolts/screws |
| 1.6 HDi | 82 - 85 | 11/10→12/18 | | | |
| 1.6 THP | 110 - 121 | 11/10→12/18 | | | |
| 1.6 VTi | 85 - 88 | 11/10→12/18 | | | |
| 2.0 BlueHDi 150 | 110 | 04/14→12/18 | | | |
| 2.0 BlueHDi 180 | 133 | 04/14→12/18 | | | |
| 2.0 HDi | 100 - 120 | 11/10→12/18 | | | |
| 2.0 HDi Hybrid4 AWC | 120 | 11/10→12/18 | | | |
| 2.2 HDi | 150 | 11/10→12/18 | | | |
| 2.0 HDi Hybrid4 AWC | 147 | 11/10→12/18 | | | |
| PEUGEOT - 508 II (FB_, FH_, F3_) 09/18→ | | | | | |
|  Brake Pad Set, disc brake | | | | | |
| 1.5 BlueHDi 130 | 96 | 10/18→ | for brake disc diameter [mm]: 330; Fitting Position: Front Axle | 13.0460-3876.2 603876 | Brake System: Bosch 22218 18,3 Wear Warning Contact: prepared for wear indicator / excl. wear warning contact Supplementary Article/Supplementary Info: with accessories |
| 1.6 PureTech 180 | 133 | 10/18→ | | | |
| 1.6 PureTech 225 | 165 | 10/18→ | | | |
| 1.6 THP 150 | 110 | 09/18→ | | | |
| 1.6 THP 165 | 121 | 09/18→ | | | |
| 2.0 BlueHDi 160 | 120 | 10/18→ | | | |
| 2.0 BlueHDi 180 | 130 | 10/18→ | | | |
| PureTech 130 | 96 | 06/20→ | for brake disc diameter [mm]: 268; Fitting Position: Rear Axle | 13.0460-3871.2 603871 | Brake System: Bosch 25839 17,8 Wear Warning Contact: not prepared for wear indicator / excl. wear warning contact Supplementary Article/Supplementary Info: with accessories |
| | | | for brake disc diameter [mm]: 290; Fitting Position: Rear Axle | 13.0470-3871.2 LD3871 | Brake System: Bosch 25839 17,8 Wear Warning Contact: not prepared for wear indicator / excl. wear warning contact Supplementary Article/Supplementary Info: with accessories Ceramic |
| | | | | 13.0460-3872.2 603872 | Brake System: Bosch 25827 17,7 Wear Warning Contact: not prepared for wear indicator / excl. wear warning contact Supplementary Article/Supplementary Info: with accessories |



| | kW | | | |
|---|--|--|--|---|
| PEUGEOT - 508 II (FB_, FH_, F3_) 09/18→ | | | | |
|  Brake Pad Set, disc brake | | | | |
| 1.5 BlueHDI 130 1.6 PureTech 180 1.6 PureTech 225 1.6 THP 150 1.6 THP 165 2.0 BlueHDI 160 2.0 BlueHDI 180 PureTech 130 | 96 10/18→ 133 10/18→ 165 10/18→ 110 09/18→ 121 09/18→ 120 10/18→ 130 10/18→ 96 06/20→ | for brake disc diameter [mm]: 290; Fitting Position: Rear Axle | 13.0470-3872.2 LD3872 | Brake System: Bosch 25827 17,7 Wear Warning Contact: not prepared for wear indicator / excl. wear warning contact Supplementary Article/Supplementary Info: with accessories Ceramic |
| Hybrid 225 | 133 - 08/19→ 165 | for brake disc diameter [mm]: 330; Fitting Position: Front Axle | 13.0460-3876.2 603876 | Brake System: Bosch 22218 18,3 Wear Warning Contact: prepared for wear indicator / excl. wear warning contact Supplementary Article/Supplementary Info: with accessories |
| | | Fitting Position: Rear Axle | 13.0460-3872.2 603872 13.0470-3872.2 LD3872 | Brake System: Bosch 25827 17,7 Wear Warning Contact: not prepared for wear indicator / excl. wear warning contact Supplementary Article/Supplementary Info: with accessories Brake System: Bosch 25827 17,7 Wear Warning Contact: not prepared for wear indicator / excl. wear warning contact Supplementary Article/Supplementary Info: with accessories Ceramic |
| PSE Hybrid4 360 | 147 01/21→ | Fitting Position: Rear Axle | 13.0460-3872.2 603872 13.0470-3872.2 LD3872 | Brake System: Bosch 25827 17,7 Wear Warning Contact: not prepared for wear indicator / excl. wear warning contact Supplementary Article/Supplementary Info: with accessories Brake System: Bosch 25827 17,7 Wear Warning Contact: not prepared for wear indicator / excl. wear warning contact Supplementary Article/Supplementary Info: with accessories Ceramic |
| PSE Hybrid4 360 | 265 01/21→ | Fitting Position: Rear Axle | 13.0460-3872.2 603872 | Brake System: Bosch 25827 17,7 Wear Warning Contact: not prepared for wear indicator / excl. wear warning contact Supplementary Article/Supplementary Info: with accessories |
|  Brake Disc | | | | |
| 1.5 BlueHDI 130 1.6 PureTech 180 1.6 PureTech 225 1.6 THP 150 1.6 THP 165 2.0 BlueHDI 160 2.0 BlueHDI 180 PureTech 130 | 96 10/18→ 133 10/18→ 165 10/18→ 110 09/18→ 121 09/18→ 120 10/18→ 130 10/18→ 96 06/20→ | Fitting Position: Front Axle | 24.0128-0269.1 428269 24.0130-0241.1 430241 | Outer diameter [mm]: 304 Brake Disc Thickness [mm] 28 Minimum thickness [mm] 26 Brake Disc Type: Vented Supplementary Article/Info 2: with bolts/screws Outer diameter [mm]: 330 Brake Disc Thickness [mm] 30 Minimum thickness [mm] 28 Brake Disc Type: Vented Supplementary Article/Info 2: with bolts/screws |
| | | Fitting Position: Rear Axle | 24.0112-0211.1 412211 24.0112-0212.1 412212 | Outer diameter [mm]: 268 Brake Disc Thickness [mm] 12 Minimum thickness [mm] 10 Brake Disc Type: Solid Supplementary Article/Info 2: with bolts/screws Outer diameter [mm]: 290 Brake Disc Thickness [mm] 12 Minimum thickness [mm] 10 Brake Disc Type: Solid Supplementary Article/Info 2: with bolts/screws |
| | | Hybrid 225 | 133 - 08/19→ 165 | Fitting Position: Front Axle |





→







| | kW | | | | |
|--|---------------------|--|--|------------------------------|---|
| PEUGEOT - 508 II (FB_, FH_, F3_) 09/18→ | | | | | |
|  Brake Disc | | | | | |
| Hybrid 225 | 133 - 08/19→ 165 | Fitting Position: Front Axle | | 24.0130-0241.1 430241 | Outer diameter [mm]: 330 Brake Disc Thickness [mm] 30 Minimum thickness [mm] 28 Brake Disc Type: Vented Supplementary Article/Info 2: with bolts/screws |
| | | Fitting Position: Rear Axle | | | 24.0112-0212.1 412212 |
| PSE Hybrid4 360 | 147 - 01/21→ 265 | Fitting Position: Rear Axle | | 24.0112-0212.1 412212 | Outer diameter [mm]: 290 Brake Disc Thickness [mm] 12 Minimum thickness [mm] 10 Brake Disc Type: Solid Supplementary Article/Info 2: with bolts/screws |
| PEUGEOT - 508 SW I (8E_) 11/10→12/18 | | | | | |
|  Brake Disc | | | | | |
| 1.6 | 121 02/12→12/18 | Fitting Position: Front Axle | | 24.0128-0269.1 428269 | Outer diameter [mm]: 304 Brake Disc Thickness [mm] 28 Minimum thickness [mm] 26 Brake Disc Type: Vented Supplementary Article/Info 2: with bolts/screws |
| 1.6 BlueHDi 120 | 88 03/14→12/18 | | | | |
| 1.6 HDi | 82 - 11/10→12/18 | | | | |
| | 85 | | | | |
| 1.6 THP | 110 - 11/10→12/18 | | | | |
| | 115 | | | | |
| 1.6 VTi | 85 - 11/10→12/18 | | | | |
| | 88 | | | | |
| 2.0 BlueHDi 150 | 110 04/14→12/18 | | | | |
| 2.0 BlueHDi 180 | 133 04/14→12/18 | | | | |
| 2.0 HDi | 100 - 11/10→12/18 | | | | |
| | 120 | | | | |
| 2.0 HDi 180 RXH | 133 10/14→12/18 | | | | |
| 2.0 HDi RXH Hybrid4 | 120 11/10→12/18 | | | | |
| 2.2 HDi | 150 11/10→12/18 | | | | |
| PEUGEOT - 508 SW II (FC_, FJ_, F4_) 09/18→ | | | | | |
|  Brake Pad Set, disc brake | | | | | |
| 1.5 BlueHDi 130 | 96 09/18→ | for brake disc diameter [mm]: 330; Fitting Position: Front Axle | | 13.0460-3876.2 603876 | Brake System: Bosch 22218 18,3 Wear Warning Contact: prepared for wear indicator / excl. wear warning contact Supplementary Article/Supplementary Info: with accessories |
| 1.6 PureTech 180 | 133 09/18→ | | | | |
| 1.6 PureTech 225 | 165 09/18→ | | | | |
| 1.6 THP 165 | 121 09/18→ | | | | |
| 2.0 BlueHDi 160 | 120 09/18→ | | | | |
| 2.0 BlueHDi 180 | 130 09/18→ | | | | |
| PureTech 130 | 96 06/20→ | | | | |
| | | for brake disc diameter [mm]: 268; Fitting Position: Rear Axle | | 13.0460-3871.2 603871 | Brake System: Bosch 25839 17,8 Wear Warning Contact: not prepared for wear indicator / excl. wear warning contact Supplementary Article/Supplementary Info: with accessories |
| | | for brake disc diameter [mm]: 290; Fitting Position: Rear Axle | | 13.0470-3871.2 LD3871 | Brake System: Bosch 25839 17,8 Wear Warning Contact: not prepared for wear indicator / excl. wear warning contact Supplementary Article/Supplementary Info: with accessories Ceramic |
| | | for brake disc diameter [mm]: 290; Fitting Position: Rear Axle | | 13.0460-3872.2 603872 | Brake System: Bosch 25827 17,7 Wear Warning Contact: not prepared for wear indicator / excl. wear warning contact Supplementary Article/Supplementary Info: with accessories |
| | | for brake disc diameter [mm]: 290; Fitting Position: Rear Axle | | 13.0470-3872.2 LD3872 | Brake System: Bosch 25827 17,7 Wear Warning Contact: not prepared for wear indicator / excl. wear warning contact Supplementary Article/Supplementary Info: with accessories Ceramic |
| Hybrid 224 | 133 - 08/19→ 165 | for brake disc diameter [mm]: 330; Fitting Position: Front Axle | | 13.0460-3876.2 603876 | Brake System: Bosch 22218 18,3 Wear Warning Contact: prepared for wear indicator / excl. wear warning contact Supplementary Article/Supplementary Info: with accessories |
| → | | | | | |



| | kW | | | |
|--|--|------------------------------|------------------------------|---|
| PEUGEOT - 508 SW II (FC_, FJ_, F4_) 09/18→ | | | | |
|  Brake Pad Set, disc brake | | | | |
| Hybrid 224 | 133 - 08/19→ 165 | Fitting Position: Rear Axle | 13.0460-3872.2 603872 | Brake System: Bosch 25827 17,7 Wear Warning Contact: not prepared for wear indicator / excl. wear warning contact Supplementary Article/Supplementary Info: with accessories |
| | | | 13.0470-3872.2 LD3872 | Brake System: Bosch 25827 17,7 Wear Warning Contact: not prepared for wear indicator / excl. wear warning contact Supplementary Article/Supplementary Info: with accessories Ceramic |
| PSE Hybrid4 360 | 147 01/21→ | Fitting Position: Rear Axle | 13.0460-3872.2 603872 | Brake System: Bosch 25827 17,7 Wear Warning Contact: not prepared for wear indicator / excl. wear warning contact Supplementary Article/Supplementary Info: with accessories |
| | | | 13.0470-3872.2 LD3872 | Brake System: Bosch 25827 17,7 Wear Warning Contact: not prepared for wear indicator / excl. wear warning contact Supplementary Article/Supplementary Info: with accessories Ceramic |
| PSE Hybrid4 360 | 265 01/21→ | Fitting Position: Rear Axle | 13.0460-3872.2 603872 | Brake System: Bosch 25827 17,7 Wear Warning Contact: not prepared for wear indicator / excl. wear warning contact Supplementary Article/Supplementary Info: with accessories |
|  Brake Disc | | | | |
| 1.5 BlueHDi 130 1.6 PureTech 180 1.6 PureTech 225 1.6 THP 165 2.0 BlueHDi 160 2.0 BlueHDi 180 PureTech 130 | 96 09/18→ 133 09/18→ 165 09/18→ 121 09/18→ 120 09/18→ 130 09/18→ 96 06/20→ | Fitting Position: Front Axle | 24.0128-0269.1 428269 | Outer diameter [mm]: 304 Brake Disc Thickness [mm] 28 Minimum thickness [mm] 26 Brake Disc Type: Vented Supplementary Article/Info 2: with bolts/screws |
| | | | 24.0130-0241.1 430241 | Outer diameter [mm]: 330 Brake Disc Thickness [mm] 30 Minimum thickness [mm] 28 Brake Disc Type: Vented Supplementary Article/Info 2: with bolts/screws |
| | | Fitting Position: Rear Axle | 24.0112-0211.1 412211 | Outer diameter [mm]: 268 Brake Disc Thickness [mm] 12 Minimum thickness [mm] 10 Brake Disc Type: Solid Supplementary Article/Info 2: with bolts/screws |
| | | | 24.0112-0212.1 412212 | Outer diameter [mm]: 290 Brake Disc Thickness [mm] 12 Minimum thickness [mm] 10 Brake Disc Type: Solid Supplementary Article/Info 2: with bolts/screws |
| Hybrid 224 | 133 - 08/19→ 165 | Fitting Position: Front Axle | 24.0128-0269.1 428269 | Outer diameter [mm]: 304 Brake Disc Thickness [mm] 28 Minimum thickness [mm] 26 Brake Disc Type: Vented Supplementary Article/Info 2: with bolts/screws |
| | | | 24.0130-0241.1 430241 | Outer diameter [mm]: 330 Brake Disc Thickness [mm] 30 Minimum thickness [mm] 28 Brake Disc Type: Vented Supplementary Article/Info 2: with bolts/screws |
| | | Fitting Position: Rear Axle | 24.0112-0212.1 412212 | Outer diameter [mm]: 290 Brake Disc Thickness [mm] 12 Minimum thickness [mm] 10 Brake Disc Type: Solid Supplementary Article/Info 2: with bolts/screws |
| → | | | | |



| | kW | | | | |
|---|---|--|--|--|---|
| PEUGEOT - 508 SW II (FC_, FJ_, F4_) 09/18→ | | | | | |
|  Brake Disc | | | | | |
| PSE Hybrid4 360 | 147 - 01/21→ 265 | | Fitting Position: Rear Axle | 24.0112-0212.1 412212 | Outer diameter [mm]: 290 Brake Disc Thickness [mm] 12 Minimum thickness [mm] 10 Brake Disc Type: Solid Supplementary Article/Info 2: with bolts/screws |
| PEUGEOT - 508 SW Estate Van (8E_) 11/11→ | | | | | |
|  Brake Disc | | | | | |
| 1.6 HDi 2.0 HDi 2.2 HDi | 84 03/13→12/18 103 - 03/13→12/18 120 150 11/11→ | | Fitting Position: Front Axle | 24.0128-0269.1 428269 | Outer diameter [mm]: 304 Brake Disc Thickness [mm] 28 Minimum thickness [mm] 26 Brake Disc Type: Vented Supplementary Article/Info 2: with bolts/screws |
| PEUGEOT - 1007 (KM_) 04/05→ | | | | | |
|  Brake Disc | | | | | |
| 1.4 1.4 16V 1.4 HDi 1.6 16V | 54 04/05→ 65 10/05→ 50 04/05→ 80 04/05→ | | → Construction year to: 02/11; Fitting Position: Front Axle | 24.0122-0194.1 422194 | Outer diameter [mm]: 266 Brake Disc Thickness [mm] 22 Minimum thickness [mm] 20 Brake Disc Type: Vented Supplementary Article/Info 2: with bolts/screws |
| PEUGEOT - 2008 I (CU_) 03/13→ | | | | | |
|  Brake Disc | | | | | |
| 1.2 PureTech 82 1.2 THP 110 / PureTech 110 1.2 THP 130 / PureTech 130 1.2 VTi 1.4 HDi 1.5 BlueHDi 100 1.5 BlueHDi 120 1.6 BlueHDi 1.6 BlueHDi 100 1.6 BlueHDi 120 1.6 BlueHDi 75 1.6 HDi 1.6 THP 165 1.6 VTi | 61 01/18→12/19 81 01/15→ 96 01/15→ 60 03/13→12/18 50 06/13→ 75 05/18→ 88 05/18→ 85 07/14→ 73 01/15→ 88 07/14→ 55 01/15→ 68 - 03/13→ 84 121 02/16→ 85 - 03/13→ 88 | | Fitting Position: Front Axle | 24.0122-0194.1 422194 | Outer diameter [mm]: 266 Brake Disc Thickness [mm] 22 Minimum thickness [mm] 20 Brake Disc Type: Vented Supplementary Article/Info 2: with bolts/screws |
| PEUGEOT - 2008 I Van (CU_) 03/13→ | | | | | |
|  Brake Disc | | | | | |
| BlueHDi 100 BlueHDi 120 PureTech 130 | 75 05/18→ 88 05/18→ 96 01/18→ | | Fitting Position: Front Axle | 24.0122-0194.1 422194 | Outer diameter [mm]: 266 Brake Disc Thickness [mm] 22 Minimum thickness [mm] 20 Brake Disc Type: Vented Supplementary Article/Info 2: with bolts/screws |
| PEUGEOT - 2008 II (UD_, US_, UY_, UK_) 08/19→ | | | | | |
|  Brake Pad Set, disc brake | | | | | |
| e-2008 | 100 09/19→ | | Fitting Position: Rear Axle | 13.0460-3871.2 603871 13.0470-3871.2 LD3871 | Brake System: Bosch 25839 17,8 Wear Warning Contact: not prepared for wear indicator / excl. wear warning contact Supplementary Article/Supplementary Info: with accessories Brake System: Bosch 25839 17,8 Wear Warning Contact: not prepared for wear indicator / excl. wear warning contact Supplementary Article/Supplementary Info: with accessories Ceramic |





| | | kW | | | | | |
|--|-----------------|--|------------------------------|--|--|--|--|
| PEUGEOT - 3008 SUV (MC_, MR_, MJ_, M4_) 05/16→ | | | | | | | |
|  Brake Pad Set, disc brake | | | | | | | |
| 1.2 THP/ PureTech 130 | 96 05/16→ | for brake disc diameter [mm]: 330; Fitting Position: Front Axle | 13.0460-3876.2 603876 | Brake System: Bosch 22218 18,3 Wear Warning Contact: prepared for wear indicator / excl. wear warning contact Supplementary Article/Supplementary Info: with accessories | | | |
| 1.5 BlueHDi 130 | 96 02/18→ | | | | | | |
| 1.6 BlueHDi 100 | 73 11/16→ | | | | | | |
| 1.6 BlueHDi 115 | 85 11/16→12/19 | | | | | | |
| 1.6 BlueHDi 120 | 88 05/16→ | | | | | | |
| 1.6 PureTech 180 | 133 07/18→ | | | | | | |
| 1.6 THP 150 | 110 11/17→ | | | | | | |
| 1.6 THP 165 | 121 05/16→ | | | | | | |
| 2.0 BlueHDi 136 | 100 11/16→ | | | | | | |
| 2.0 BlueHDi 150 | 110 05/16→09/20 | | | | | | |
| 2.0 BlueHDi 180 | 130 - 05/16→ | for brake disc diameter [mm]: 268; Fitting Position: Rear Axle | 13.0460-3871.2 603871 | Brake System: Bosch 25839 17,8 Wear Warning Contact: not prepared for wear indicator / excl. wear warning contact Supplementary Article/Supplementary Info: with accessories | | | |
| Hybrid | 133 - 10/19→ | | | | | | |
| | 165 | | | | | | |
| Hybrid4 | 147 - 10/19→ | | | | | | |
| | 220 | | | | | | |
| | | | | | | | |
| | | | | | | | |
| | | | | | | | |
| | | | | | | | |
| | | | | | | | |
| | | for brake disc diameter [mm]: 290; Fitting Position: Rear Axle | 13.0460-3872.2 603872 | Brake System: Bosch 25827 17,7 Wear Warning Contact: not prepared for wear indicator / excl. wear warning contact Supplementary Article/Supplementary Info: with accessories | | | |
| | | | | | | | |
| | | | | | | | |
| | | | | | | | |
| | | | | | | | |
| | | | | | | | |
| | | | | | | | |
| | | | | | | | |
| | | | | | | | |
| | | | | | | | |
|  Brake Disc | | | | | | | |
| 1.2 THP/ PureTech 130 | 96 05/16→ | Fitting Position: Front Axle | 24.0128-0269.1 428269 | Outer diameter [mm]: 304 Brake Disc Thickness [mm] 28 Minimum thickness [mm] 26 Brake Disc Type: Vented Supplementary Article/Info 2: with bolts/screws | | | |
| 1.5 BlueHDi 130 | 96 02/18→ | | | | | | |
| 1.6 BlueHDi 100 | 73 11/16→ | | | | | | |
| 1.6 BlueHDi 115 | 85 11/16→12/19 | | | | | | |
| 1.6 BlueHDi 120 | 88 05/16→ | | | | | | |
| 1.6 PureTech 180 | 133 07/18→ | | | | | | |
| 1.6 THP 150 | 110 11/17→ | | | | | | |
| 1.6 THP 165 | 121 05/16→ | | | | | | |
| 2.0 BlueHDi 136 | 100 11/16→ | | | | | | |
| 2.0 BlueHDi 150 | 110 05/16→09/20 | | | | | | |
| 2.0 BlueHDi 180 | 130 - 05/16→ | Fitting Position: Rear Axle | 24.0130-0241.1 430241 | Outer diameter [mm]: 330 Brake Disc Thickness [mm] 30 Minimum thickness [mm] 28 Brake Disc Type: Vented Supplementary Article/Info 2: with bolts/screws | | | |
| Hybrid | 133 - 10/19→ | | | | | | |
| | 165 | | | | | | |
| Hybrid4 | 147 - 10/19→ | | | | | | |
| | 220 | | | | | | |
| | | | | | | | |
| | | | | | | | |
| | | | | | | | |
| | | | | | | | |
| | | | | | | | |
| | | Fitting Position: Rear Axle | 24.0112-0211.1 412211 | Outer diameter [mm]: 268 Brake Disc Thickness [mm] 12 Minimum thickness [mm] 10 Brake Disc Type: Solid Supplementary Article/Info 2: with bolts/screws | | | |
| | | | | | | | |
| | | | | | | | |
| | | | | | | | |
| | | | | | | | |
| | | | | | | | |
| | | | | | | | |
| | | | | | | | |
| | | | | | | | |
| | | | | | | | |
| | | Fitting Position: Rear Axle | 24.0112-0212.1 412212 | Outer diameter [mm]: 290 Brake Disc Thickness [mm] 12 Minimum thickness [mm] 10 Brake Disc Type: Solid Supplementary Article/Info 2: with bolts/screws | | | |
| | | | | | | | |
| | | | | | | | |
| | | | | | | | |
| | | | | | | | |
| | | | | | | | |
| | | | | | | | |
| | | | | | | | |
| | | | | | | | |
| | | | | | | | |
| PEUGEOT - 3008 Van (MR_, MC_, MJ_) 05/16→ | | | | | | | |
|  Brake Pad Set, disc brake | | | | | | | |
| BlueHDi 130 | 96 02/18→ | for brake disc diameter [mm]: 330; Fitting Position: Front Axle | 13.0460-3876.2 603876 | Brake System: Bosch 22218 18,3 Wear Warning Contact: prepared for wear indicator / excl. wear warning contact Supplementary Article/Supplementary Info: with accessories | | | |
| BlueHDi 180 | 130 01/18→ | | | | | | |
| PureTech 130 | 96 05/16→ | | | | | | |
| | | for brake disc diameter [mm]: 268; Fitting Position: Rear Axle | 13.0460-3871.2 603871 | Brake System: Bosch 25839 17,8 Wear Warning Contact: not prepared for wear indicator / excl. wear warning contact Supplementary Article/Supplementary Info: with accessories | | | |
| | | | | | | | |
| → | | | | | | | |







| | kW | | | |
|--|---|---|--|---|
| PEUGEOT - 3008 Van (MR_, MC_, MJ_) 05/16→ | | | | |
|  Brake Pad Set, disc brake | | | | |
| BlueHDi 130 BlueHDi 180 PureTech 130 | 96 02/18→ 130 01/18→ 96 05/16→ | for brake disc diameter [mm]: 268; Fitting Position: Rear Axle | 13.0470-3871.2 LD3871 | Brake System: Bosch 25839 17,8 Wear Warning Contact: not prepared for wear indicator / excl. wear warning contact Supplementary Article/Supplementary Info: with accessories Ceramic |
| | | for brake disc diameter [mm]: 290; Fitting Position: Rear Axle | 13.0460-3872.2 603872 13.0470-3872.2 LD3872 | Brake System: Bosch 25827 17,7 Wear Warning Contact: not prepared for wear indicator / excl. wear warning contact Supplementary Article/Supplementary Info: with accessories Brake System: Bosch 25827 17,7 Wear Warning Contact: not prepared for wear indicator / excl. wear warning contact Supplementary Article/Supplementary Info: with accessories Ceramic |
|  Brake Disc | | | | |
| BlueHDi 130 BlueHDi 180 PureTech 130 | 96 02/18→ 130 01/18→ 96 05/16→ | Fitting Position: Front Axle | 24.0128-0269.1 428269 24.0130-0241.1 430241 | Outer diameter [mm]: 304 Brake Disc Thickness [mm] 28 Minimum thickness [mm] 26 Brake Disc Type: Vented Supplementary Article/Info 2: with bolts/screws Outer diameter [mm]: 330 Brake Disc Thickness [mm] 30 Minimum thickness [mm] 28 Brake Disc Type: Vented Supplementary Article/Info 2: with bolts/screws |
| | | Fitting Position: Rear Axle | 24.0112-0211.1 412211 24.0112-0212.1 412212 | Outer diameter [mm]: 268 Brake Disc Thickness [mm] 12 Minimum thickness [mm] 10 Brake Disc Type: Solid Supplementary Article/Info 2: with bolts/screws Outer diameter [mm]: 290 Brake Disc Thickness [mm] 12 Minimum thickness [mm] 10 Brake Disc Type: Solid Supplementary Article/Info 2: with bolts/screws |
| PEUGEOT - 5008 II (MC_, MJ_, MR_, M4_) 12/16→ | | | | |
|  Brake Pad Set, disc brake | | | | |
| 1.2 1.5 BlueHDi 130 1.6 1.6 BlueHDi 100 1.6 BlueHDi 115 1.6 BlueHDi 120 1.6 PureTech 180 1.6 THP 165 2.0 BlueHDi 136 2.0 BlueHDi 150 2.0 BlueHDi 180 | 96 12/16→ 96 02/18→ 110 07/18→ 73 12/16→ 85 12/16→11/19 88 12/16→ 133 07/18→ 121 12/16→ 100 12/16→ 110 12/16→ 130 - 12/16→ 133 | Fitting Position: Rear Axle | 13.0460-3872.2 603872 13.0470-3872.2 LD3872 | Brake System: Bosch 25827 17,7 Wear Warning Contact: not prepared for wear indicator / excl. wear warning contact Supplementary Article/Supplementary Info: with accessories Brake System: Bosch 25827 17,7 Wear Warning Contact: not prepared for wear indicator / excl. wear warning contact Supplementary Article/Supplementary Info: with accessories Ceramic |
|  Brake Disc | | | | |
| 1.2 1.5 BlueHDi 130 1.6 1.6 BlueHDi 100 1.6 BlueHDi 115 1.6 BlueHDi 120 1.6 PureTech 180 1.6 THP 165 2.0 BlueHDi 136 2.0 BlueHDi 150 2.0 BlueHDi 180 | 96 12/16→ 96 02/18→ 110 07/18→ 73 12/16→ 85 12/16→11/19 88 12/16→ 133 07/18→ 121 12/16→ 100 12/16→ 110 12/16→ 130 - 12/16→ 133 | Fitting Position: Front Axle | 24.0128-0269.1 428269 | Outer diameter [mm]: 304 Brake Disc Thickness [mm] 28 Minimum thickness [mm] 26 Brake Disc Type: Vented Supplementary Article/Info 2: with bolts/screws |
| | | Fitting Position: Rear Axle | 24.0112-0212.1 412212 | Outer diameter [mm]: 290 Brake Disc Thickness [mm] 12 Minimum thickness [mm] 10 Brake Disc Type: Solid Supplementary Article/Info 2: with bolts/screws |







| | | | | | |
|---|--|--|------------------------------|---|--|
| | kW | | | | |
| PEUGEOT - 5008 II Van (MC_, MJ_) 12/16→ | | | | | |
|  Brake Pad Set, disc brake | | | | | |
| BlueHDi 130 BlueHDi 180 | 96 06/18→ 130 01/18→ | Fitting Position: Rear Axle | 13.0460-3872.2 603872 | Brake System: Bosch 25827 17,7 Wear Warning Contact: not prepared for wear indicator / excl. wear warning contact Supplementary Article/Supplementary Info: with accessories | |
| | | | 13.0470-3872.2 LD3872 | Brake System: Bosch 25827 17,7 Wear Warning Contact: not prepared for wear indicator / excl. wear warning contact Supplementary Article/Supplementary Info: with accessories Ceramic | |
|  Brake Disc | | | | | |
| BlueHDi 130 BlueHDi 180 | 96 06/18→ 130 01/18→ | Fitting Position: Front Axle | 24.0128-0269.1 428269 | Outer diameter [mm]: 304 Brake Disc Thickness [mm] 28 Minimum thickness [mm] 26 Brake Disc Type: Vented Supplementary Article/Info 2: with bolts/screws | |
| | | Fitting Position: Rear Axle | 24.0112-0212.1 412212 | Outer diameter [mm]: 290 Brake Disc Thickness [mm] 12 Minimum thickness [mm] 10 Brake Disc Type: Solid Supplementary Article/Info 2: with bolts/screws | |
| PEUGEOT - EXPERT Bus (V_) 04/16→ | | | | | |
|  Brake Disc | | | | | |
| 1.5 BlueHDi 100 1.5 BlueHDi 120 1.6 BlueHDi 115 1.6 BlueHDi 95 2.0 BlueHDi 120 2.0 BlueHDi 145 2.0 BlueHDi 150 2.0 BlueHDi 180 E-EXPERT | 75 06/18→ 88 06/18→ 85 04/16→ 70 04/16→ 90 09/19→ 106 07/21→ 110 04/16→ 130 04/16→ 100 09/20→ | Vehicle Equipment: for vehicles without electric parking brake; Fitting Position: Rear Axle | 24.0112-0212.1 412212 | Outer diameter [mm]: 290 Brake Disc Thickness [mm] 12 Minimum thickness [mm] 10 Brake Disc Type: Solid Supplementary Article/Info 2: with bolts/screws | |
| PEUGEOT - EXPERT Platform/Chassis (V_) 09/16→ | | | | | |
|  Brake Disc | | | | | |
| 1.6 BlueHDi 95 2.0 BlueHDi 120 2.0 BlueHDi 150 E-EXPERT | 70 09/16→ 90 09/16→ 110 09/16→ 100 09/20→ | Vehicle Equipment: for vehicles without electric parking brake; Fitting Position: Rear Axle | 24.0112-0212.1 412212 | Outer diameter [mm]: 290 Brake Disc Thickness [mm] 12 Minimum thickness [mm] 10 Brake Disc Type: Solid Supplementary Article/Info 2: with bolts/screws | |
| PEUGEOT - EXPERT Van (V_) 04/16→ | | | | | |
|  Brake Disc | | | | | |
| 1.5 BlueHDi 100 1.5 BlueHDi 120 1.6 BlueHDi 115 1.6 BlueHDi 95 2.0 BlueHDi 120 2.0 BlueHDi 120 4x4 2.0 BlueHDi 145 2.0 BlueHDi 150 2.0 BlueHDi 150 4x4 2.0 BlueHDi 180 E-EXPERT | 75 06/18→ 88 06/18→ 85 04/16→ 70 04/16→ 90 04/16→ 90 04/16→ 106 08/21→ 110 04/16→ 110 04/16→ 130 04/16→ 100 09/20→ | Vehicle Equipment: for vehicles without electric parking brake; Fitting Position: Rear Axle | 24.0112-0212.1 412212 | Outer diameter [mm]: 290 Brake Disc Thickness [mm] 12 Minimum thickness [mm] 10 Brake Disc Type: Solid Supplementary Article/Info 2: with bolts/screws | |
| PEUGEOT - PARTNER Box Body/MPV (5_, G_) 06/96→ | | | | | |
|  Brake Disc | | | | | |
| 1.1 | 44 06/96→09/05 | Construction year from: 10/02 →; Fitting Position: Front Axle | 24.0122-0194.1 422194 | Outer diameter [mm]: 266 Brake Disc Thickness [mm] 22 Minimum thickness [mm] 20 Brake Disc Type: Vented Supplementary Article/Info 2: with bolts/screws | |
| → | | | | | |







| | kW | | | | |
|---|--|---|--|--|---|
| PEUGEOT - PARTNER Box Body/MPV (5_, G_) 06/96→ | | | | | |
|  Brake Disc | | | | | |
| 1.4 1.4 BiFuel 1.6 1.6 Bioflex 1.6 HDi 75 1.6 HDi 92 | 48 - 11/02→12/10 54 55 04/03→10/06 80 09/00→10/02 80 09/00→10/02 55 08/05→07/08 68 11/09→12/10 | Fitting Position: Front Axle | | 24.0122-0194.1 422194 | Outer diameter [mm]: 266 Brake Disc Thickness [mm] 22 Minimum thickness [mm] 20 Brake Disc Type: Vented Supplementary Article/Info 2: with bolts/screws |
| 1.4 | 55 06/96→12/15 | Construction year from: 10/02 → → Construction year to: 03/08; Fitting Position: Front Axle | | 24.0122-0194.1 422194 | Outer diameter [mm]: 266 Brake Disc Thickness [mm] 22 Minimum thickness [mm] 20 Brake Disc Type: Vented Supplementary Article/Info 2: with bolts/screws |
| 1.6 HDi 90 | 66 08/05→12/15 | → Construction year to: 03/08; Fitting Position: Front Axle | | 24.0122-0194.1 422194 | Outer diameter [mm]: 266 Brake Disc Thickness [mm] 22 Minimum thickness [mm] 20 Brake Disc Type: Vented Supplementary Article/Info 2: with bolts/screws |
| 1.8 D 1.9 D 1.9 D 4x4 | 43 - 06/96→12/02 44 50 - 06/96→12/02 51 51 04/04→07/11 | for RPO number (vehicle manufacturing date) from: 09128 →; Fitting Position: Front Axle | | 24.0122-0194.1 422194 | Outer diameter [mm]: 266 Brake Disc Thickness [mm] 22 Minimum thickness [mm] 20 Brake Disc Type: Vented Supplementary Article/Info 2: with bolts/screws |
| 1.9 D | 51 06/96→12/15 | for RPO number (vehicle manufacturing date) from: 09128 →; → Construction year to: 03/08; Fitting Position: Front Axle | | 24.0122-0194.1 422194 | Outer diameter [mm]: 266 Brake Disc Thickness [mm] 22 Minimum thickness [mm] 20 Brake Disc Type: Vented Supplementary Article/Info 2: with bolts/screws |
| 2.0 HDi | 66 04/00→07/08 | for RPO number (vehicle manufacturing date) from: 09128 →; → Construction year to: 03/08; - ESP; Fitting Position: Front Axle | | 24.0122-0194.1 422194 | Outer diameter [mm]: 266 Brake Disc Thickness [mm] 22 Minimum thickness [mm] 20 Brake Disc Type: Vented Supplementary Article/Info 2: with bolts/screws |
| 2.0 HDi 4x4 | 66 04/04→08/05 | for RPO number (vehicle manufacturing date) from: 09128 →; - ESP; Fitting Position: Front Axle | | 24.0122-0194.1 422194 | Outer diameter [mm]: 266 Brake Disc Thickness [mm] 22 Minimum thickness [mm] 20 Brake Disc Type: Vented Supplementary Article/Info 2: with bolts/screws |
| Electric | 25 06/96→12/02 | Construction year from: 01/98 →; Fitting Position: Front Axle | | 24.0122-0194.1 422194 | Outer diameter [mm]: 266 Brake Disc Thickness [mm] 22 Minimum thickness [mm] 20 Brake Disc Type: Vented Supplementary Article/Info 2: with bolts/screws |
| PEUGEOT - PARTNER Box Body/MPV (K9) 09/18→ | | | | | |
| Spring, brake caliper | | | | | |
| 1.2 PureTech 110 1.2 PureTech 130 1.5 BlueHDi 100 1.5 BlueHDi 130 1.5 BlueHDi 130 4x4 1.5 BlueHDi 75 1.6 BlueHDi 100 1.6 BlueHDi 75 e-Partner | 81 07/19→ 96 07/19→ 75 07/19→ 96 09/18→ 96 09/18→ 55 07/19→ 73 09/18→ 55 09/18→ 100 07/21→ | Required quantity: 2; for brake disc diameter [mm]: 283; Fitting Position: Front Axle | | 2 11.8116-0237.1 390509 | Brake System: ATE |
|  Brake Pad Set, disc brake | | | | | |
| 1.2 PureTech 110 1.2 PureTech 130 1.5 BlueHDi 100 1.5 BlueHDi 130 1.5 BlueHDi 130 4x4 1.5 BlueHDi 75 1.6 BlueHDi 100 1.6 BlueHDi 75 e-Partner | 81 07/19→ 96 07/19→ 75 07/19→ 96 09/18→ 96 09/18→ 55 07/19→ 73 09/18→ 55 09/18→ 100 07/21→ | for brake disc diameter [mm]: 283; Fitting Position: Front Axle | | 13.0460-3870.2 603870 13.0470-3870.2 LD3870 | Brake System: Bosch 25895 18,5 Wear Warning Contact: not prepared for wear indicator / excl. wear warning contact Supplementary Article/Supplementary Info: with accessories Brake System: Bosch 25895 18,5 Wear Warning Contact: not prepared for wear indicator / excl. wear warning contact Supplementary Article/Supplementary Info: with accessories Ceramic |
| → | | | | | |





| | kW | | | | | |
|---|--|--|--|---|--|--|
| PEUGEOT - PARTNER Box Body/MPV (K9) 09/18→ | | | | | | |
|  Brake Pad Set, disc brake | | | | | | |
| 1.2 PureTech 110 1.2 PureTech 130 1.5 BlueHDi 100 1.5 BlueHDi 130 1.5 BlueHDi 130 4x4 1.5 BlueHDi 75 1.6 BlueHDi 100 1.6 BlueHDi 75 e-Partner | 81 07/19→ 96 07/19→ 75 07/19→ 96 09/18→ 96 09/18→ 55 07/19→ 73 09/18→ 55 09/18→ 100 07/21→ | Vehicle Equipment: for vehicles with electric parking brake; Fitting Position: Rear Axle | 13.0460-3871.2 603871 13.0470-3871.2 LD3871 | Brake System: Bosch 25839 17,8 Wear Warning Contact: not prepared for wear indicator / excl. wear warning contact Supplementary Article/Supplementary Info: with accessories Brake System: Bosch 25839 17,8 Wear Warning Contact: not prepared for wear indicator / excl. wear warning contact Supplementary Article/Supplementary Info: with accessories Ceramic | | |
|  Brake Disc | | | | | | |
| 1.2 PureTech 110 1.2 PureTech 130 1.5 BlueHDi 100 1.5 BlueHDi 130 1.5 BlueHDi 130 4x4 1.5 BlueHDi 75 1.6 BlueHDi 100 1.6 BlueHDi 75 e-Partner | 81 07/19→ 96 07/19→ 75 07/19→ 96 09/18→ 96 09/18→ 55 07/19→ 73 09/18→ 55 09/18→ 100 07/21→ | Brake System: Bosch; Fitting Position: Front Axle | 24.0126-0183.1 426183 | Outer diameter [mm]: 283 Brake Disc Thickness [mm] 26 Minimum thickness [mm] 24 Brake Disc Type: Vented Supplementary Article/Info 2: with bolts/screws | | |
| | | Fitting Position: Front Axle | 24.0128-0269.1 428269 | Outer diameter [mm]: 304 Brake Disc Thickness [mm] 28 Minimum thickness [mm] 26 Brake Disc Type: Vented Supplementary Article/Info 2: with bolts/screws | | |
| | | Fitting Position: Rear Axle | 24.0112-0211.1 412211 | Outer diameter [mm]: 268 Brake Disc Thickness [mm] 12 Minimum thickness [mm] 10 Brake Disc Type: Solid Supplementary Article/Info 2: with bolts/screws | | |
| PEUGEOT - PARTNER MPV (5_, G_) 05/96→12/15 | | | | | | |
|  Brake Disc | | | | | | |
| 1.1 | 44 06/96→10/02 | Construction year from: 10/02 →; Fitting Position: Front Axle | 24.0122-0194.1 422194 | Outer diameter [mm]: 266 Brake Disc Thickness [mm] 22 Minimum thickness [mm] 20 Brake Disc Type: Vented Supplementary Article/Info 2: with bolts/screws | | |
| 1.4 1.6 HDi 92 1.9 D 4x4 | 54 11/02→10/06 68 11/09→12/10 51 04/04→08/05 | Fitting Position: Front Axle | 24.0122-0194.1 422194 | Outer diameter [mm]: 266 Brake Disc Thickness [mm] 22 Minimum thickness [mm] 20 Brake Disc Type: Vented Supplementary Article/Info 2: with bolts/screws | | |
| 1.4 1.9 D | 55 06/96→12/15 51 01/99→07/08 | for RPO number (vehicle manufacturing date) from: 09128 →; → Construction year to: 03/08; Fitting Position: Front Axle | 24.0122-0194.1 422194 | Outer diameter [mm]: 266 Brake Disc Thickness [mm] 22 Minimum thickness [mm] 20 Brake Disc Type: Vented Supplementary Article/Info 2: with bolts/screws | | |
| 1.6 16V 1.6 Flexfuel 2.0 HDi 4x4 | 80 07/01→03/08 80 09/00→10/02 66 04/04→08/05 | for RPO number (vehicle manufacturing date) from: 09128 →; - ESP; Fitting Position: Front Axle | 24.0122-0194.1 422194 | Outer diameter [mm]: 266 Brake Disc Thickness [mm] 22 Minimum thickness [mm] 20 Brake Disc Type: Vented Supplementary Article/Info 2: with bolts/screws | | |
| 1.6 HDi 75 | 55 08/05→07/08 | → Construction year to: 03/08; - ESP; Fitting Position: Front Axle | 24.0122-0194.1 422194 | Outer diameter [mm]: 266 Brake Disc Thickness [mm] 22 Minimum thickness [mm] 20 Brake Disc Type: Vented Supplementary Article/Info 2: with bolts/screws | | |
| 1.6 HDi 90 | 66 08/05→12/15 | Construction year from: 02/06 → → Construction year to: 03/08; - ESP; Fitting Position: Front Axle | 24.0122-0194.1 422194 | Outer diameter [mm]: 266 Brake Disc Thickness [mm] 22 Minimum thickness [mm] 20 Brake Disc Type: Vented Supplementary Article/Info 2: with bolts/screws | | |
| 1.8 1.9 D | 66 05/97→12/02 50 - 05/96→12/02 51 | for RPO number (vehicle manufacturing date) from: 09128 →; Fitting Position: Front Axle | 24.0122-0194.1 422194 | Outer diameter [mm]: 266 Brake Disc Thickness [mm] 22 Minimum thickness [mm] 20 Brake Disc Type: Vented Supplementary Article/Info 2: with bolts/screws | | |





| | | | | | | |
|--|--|---|---|--|---|--|
| | kW | | | | | |
| PEUGEOT - PARTNER MPV (5_, G_) 05/96→12/15 | | | | | | |
|  Brake Disc | | | | | | |
| 2.0 HDi | 66 02/00→07/08 | for RPO number (vehicle manufacturing date) from: 09128 →; → Construction year to: 03/08; - ESP; Fitting Position: Front Axle | | 24.0122-0194.1 422194 | Outer diameter [mm]: 266 Brake Disc Thickness [mm] 22 Minimum thickness [mm] 20 Brake Disc Type: Vented Supplementary Article/Info 2: with bolts/screws | |
| PEUGEOT - PARTNER ORIGIN Box Body/MPV (G_) 07/08→12/15 | | | | | | |
|  Brake Disc | | | | | | |
| 1.4 1.6 1.6 HDi 75 1.6 HDi 90 1.9 D Electric | 55 08/08→12/15 81 09/11→12/15 55 08/08→12/15 66 08/08→12/15 51 08/08→12/15 42 01/11→12/12 | Fitting Position: Front Axle | | 24.0122-0194.1 422194 | Outer diameter [mm]: 266 Brake Disc Thickness [mm] 22 Minimum thickness [mm] 20 Brake Disc Type: Vented Supplementary Article/Info 2: with bolts/screws | |
| PEUGEOT - PARTNER ORIGIN MPV (G_) 07/08→12/13 | | | | | | |
|  Brake Disc | | | | | | |
| 1.4 1.6 16V 1.6 HDi 75 1.9 D | 55 07/08→12/13 81 09/11→12/13 55 08/08→12/13 51 08/08→12/13 | Fitting Position: Front Axle | | 24.0122-0194.1 422194 | Outer diameter [mm]: 266 Brake Disc Thickness [mm] 22 Minimum thickness [mm] 20 Brake Disc Type: Vented Supplementary Article/Info 2: with bolts/screws | |
| PEUGEOT - PARTNER Platform/Chassis (5_, G_) 03/97→07/08 | | | | | | |
|  Brake Disc | | | | | | |
| 1.6 1.6 HDi 75 | 80 09/00→05/08 55 02/06→07/08 | Fitting Position: Front Axle | | 24.0122-0194.1 422194 | Outer diameter [mm]: 266 Brake Disc Thickness [mm] 22 Minimum thickness [mm] 20 Brake Disc Type: Vented Supplementary Article/Info 2: with bolts/screws | |
| 1.9 D | 51 01/99→07/08 | for RPO number (vehicle manufacturing date) from: 09128 →; → Construction year to: 03/08; Fitting Position: Front Axle | | 24.0122-0194.1 422194 | Outer diameter [mm]: 266 Brake Disc Thickness [mm] 22 Minimum thickness [mm] 20 Brake Disc Type: Vented Supplementary Article/Info 2: with bolts/screws | |
| 2.0 HDi | 66 11/02→07/08 | for RPO number (vehicle manufacturing date) from: 09128 →; → Construction year to: 03/08; - ESP; Fitting Position: Front Axle | | 24.0122-0194.1 422194 | Outer diameter [mm]: 266 Brake Disc Thickness [mm] 22 Minimum thickness [mm] 20 Brake Disc Type: Vented Supplementary Article/Info 2: with bolts/screws | |
| PEUGEOT - RIFTER 09/18→ | | | | | | |
| Spring, brake caliper | | | | | | |
| 1.2 PureTech 110 1.2 PureTech 130 1.5 BlueHDi 100 1.5 BlueHDi 130 1.5 BlueHDi 75 1.6 BlueHDi 100 1.6 HDi 75 / BlueHDi 75 1.6 HDi 92 e-Rifter | 81 09/18→ 96 07/19→ 75 09/18→ 96 09/18→ 55 09/18→ 73 09/18→ 55 09/18→ 68 09/18→ 100 07/21→ | for brake disc diameter [mm]: 283; Required quantity: 2; Fitting Position: Front Axle | 2 | 11.8116-0237.1 390509 | Brake System: ATE | |
|  Brake Pad Set, disc brake | | | | | | |
| 1.2 PureTech 110 1.2 PureTech 130 1.5 BlueHDi 100 1.5 BlueHDi 130 1.5 BlueHDi 75 1.6 BlueHDi 100 1.6 HDi 75 / BlueHDi 75 1.6 HDi 92 e-Rifter | 81 09/18→ 96 07/19→ 75 09/18→ 96 09/18→ 55 09/18→ 73 09/18→ 55 09/18→ 68 09/18→ 100 07/21→ | for brake disc diameter [mm]: 283; Fitting Position: Front Axle | | 13.0460-3870.2 603870 13.0470-3870.2 LD3870 | Brake System: Bosch 25895 18,5 Wear Warning Contact: not prepared for wear indicator / excl. wear warning contact Supplementary Article/Supplementary Info: with accessories Brake System: Bosch 25895 18,5 Wear Warning Contact: not prepared for wear indicator / excl. wear warning contact Supplementary Article/Supplementary Info: with accessories Ceramic | |
| → | | | | | | |





| | kW | | | | |
|---|---|--|---|--|---|
| PEUGEOT - RIFTER 09/18→ | | | | | |
|  Brake Pad Set, disc brake | | | | | |
| 1.2 PureTech 110 1.2 PureTech 130 1.5 BlueHDi 100 1.5 BlueHDi 130 1.5 BlueHDi 75 1.6 BlueHDi 100 1.6 HDi 75 / BlueHDi 75 1.6 HDi 92 e-Rifter | 81 09/18→ 96 07/19→ 75 09/18→ 96 09/18→ 55 09/18→ 73 09/18→ 55 09/18→ 68 09/18→ 100 07/21→ | Vehicle Equipment: for vehicles with electric parking brake; Fitting Position: Rear Axle | | 13.0460-3871.2 603871 13.0470-3871.2 LD3871 | Brake System: Bosch 25839 17,8 Wear Warning Contact: not prepared for wear indicator / excl. wear warning contact Supplementary Article/Supplementary Info: with accessories Brake System: Bosch 25839 17,8 Wear Warning Contact: not prepared for wear indicator / excl. wear warning contact Supplementary Article/Supplementary Info: with accessories Ceramic |
|  Brake Disc | | | | | |
| 1.2 PureTech 110 1.2 PureTech 130 1.5 BlueHDi 100 1.5 BlueHDi 130 1.5 BlueHDi 75 1.6 BlueHDi 100 1.6 HDi 75 / BlueHDi 75 1.6 HDi 92 e-Rifter | 81 09/18→ 96 07/19→ 75 09/18→ 96 09/18→ 55 09/18→ 73 09/18→ 55 09/18→ 68 09/18→ 100 07/21→ | Brake System: Bosch; Fitting Position: Front Axle | | 24.0126-0183.1 426183 | Outer diameter [mm]: 283 Brake Disc Thickness [mm] 26 Minimum thickness [mm] 24 Brake Disc Type: Vented Supplementary Article/Info 2: with bolts/screws |
| | | Fitting Position: Front Axle | | 24.0128-0269.1 428269 | Outer diameter [mm]: 304 Brake Disc Thickness [mm] 28 Minimum thickness [mm] 26 Brake Disc Type: Vented Supplementary Article/Info 2: with bolts/screws |
| | | Fitting Position: Rear Axle | | 24.0112-0211.1 412211 | Outer diameter [mm]: 268 Brake Disc Thickness [mm] 12 Minimum thickness [mm] 10 Brake Disc Type: Solid Supplementary Article/Info 2: with bolts/screws |
| PEUGEOT - TRAVELLER Bus (V_) 04/16→ | | | | | |
|  Brake Disc | | | | | |
| 1.5 BlueHDi 100 1.5 BlueHDi 120 1.6 BlueHDi 115 1.6 BlueHDi 95 2.0 BlueHDi 120 2.0 BlueHDi 145 2.0 BlueHDi 150 2.0 BlueHDi 150 4x4 2.0 BlueHDi 180 E-TRAVELLER | 75 06/18→ 88 06/18→ 85 04/16→ 70 04/16→ 90 09/19→ 106 09/20→ 110 04/16→ 110 04/16→ 130 04/16→ 100 09/20→ | Vehicle Equipment: for vehicles without electric parking brake; Fitting Position: Rear Axle | | 24.0112-0212.1 412212 | Outer diameter [mm]: 290 Brake Disc Thickness [mm] 12 Minimum thickness [mm] 10 Brake Disc Type: Solid Supplementary Article/Info 2: with bolts/screws |
| POLESTAR - POLESTAR 1 (P) 03/18→ | | | | | |
|  Wheel Speed Sensor | | | | | |
| PHEV AWD | 227 - 03/18→ 448 | → Vehicle Identification Number to: 147; Required quantity: 2; Fitting Position: Front Axle | 2 | 24.0711-5473.3 360452 | |
| PORSCHE - CARRERA GT (980) 07/03→12/06 | | | | | |
|  Wheel Speed Sensor | | | | | |
| 5.7 | 450 07/03→12/06 | Fitting Position: Front Axle Left | | 24.0711-5271.3 360301 | |
| | | Fitting Position: Front Axle Right | | 24.0711-5272.3 360302 | |
| | | Fitting Position: Rear Axle Left | | 24.0711-5271.3 360301 | |
| | | Fitting Position: Rear Axle Right | | 24.0711-5272.3 360302 | |
| RENAULT - CAPTUR I (J5_, H5_) 06/13→ | | | | | |
|  Brake Hose | | | | | |
| 0.9 TCe 90 1.2 T 1.2 TCe 120 1.5 dCi 1.5 dCi 110 1.5 dCi 90 1.2 TCe 1.3 TCe 130 1.3 TCe 150 1.6 | 66 06/13→ 83 - 06/13→ 85 87 - 06/13→ 88 63 06/13→ 81 01/15→ 66 06/13→ 97 02/18→ 96 03/18→ 110 03/18→ 84 02/18→ | Required quantity: 2; Construction year from: 06/17 →; Fitting Position: Front Axle Required quantity: 2; Fitting Position: Front Axle | 2 | 24.5103-0446.3 331630 | Length [mm]: 470 Length [mm]: 470 |





| | kW | | | | |
|---|-----|-------------|--|--------------------------------|------------------|
| RENAULT - CLIO III (BR0/1, CR0/1) 01/05→12/14 | | | | | |
|  Wheel Speed Sensor | | | | | |
| 1.2 | 57 | 10/05→12/12 | - ESP; Fitting Position: Rear Axle Right | 24.0710-2031.3 360551 | Length [mm]: 661 |
| 1.2 16V | 43 | 06/05→12/14 | | | |
| | 74 | | | | |
| 1.2 16V Hi-Flex | 55 | 07/08→12/14 | | | |
| 1.2 Ethanol | 55 | 07/08→12/12 | | | |
| 1.4 16V | 72 | 06/05→12/12 | | | |
| 1.5 dCi | 47 | 05/05→12/14 | | | |
| | 78 | | | | |
| 1.6 | 79 | 09/05→12/10 | | | |
| 1.6 16V | 65 | 06/05→12/14 | | | |
| | 82 | | | | |
| 1.6 16V GT | 94 | 06/09→12/14 | | | |
| RENAULT - CLIO III Grandtour (KR0/1_) 11/07→ | | | | | |
|  Wheel Speed Sensor | | | | | |
| 1.2 16V | 58 | 11/07→12/14 | + ESP; Fitting Position: Rear Axle Right | 24.0710-2031.3 360551 | Length [mm]: 661 |
| | 76 | | | | |
| 1.5 dCi | 48 | 11/07→12/12 | | | |
| | 76 | | | | |
| 1.2 16V | 55 | 02/08→12/14 | Fitting Position: Rear Axle Right | 24.0710-2031.3 360551 | Length [mm]: 661 |
| 1.2 16V Hi-Flex | 55 | 11/07→12/14 | | | |
| | 58 | | | | |
| 1.4 16V | 72 | 11/07→12/12 | | | |
| 1.5 dCi | 78 | 02/08→12/12 | | | |
| 1.6 16V | 80 | 11/07→12/12 | | | |
| | 94 | | | | |
| RENAULT - CLIO III Hatchback Van (SB_, SR_) 06/05→ | | | | | |
|  Wheel Speed Sensor | | | | | |
| 1.2 | 55 | 11/05→12/14 | - ESP; Fitting Position: Rear Axle Right | 24.0710-2031.3 360551 | Length [mm]: 661 |
| | 74 | | | | |
| 1.5 dCi | 50 | 06/05→12/14 | | | |
| | 78 | | | | |
| 1.2 Hi-Flex | 58 | 11/07→12/09 | Fitting Position: Rear Axle Right | 24.0710-2031.3 360551 | Length [mm]: 661 |
| RENAULT - CLIO IV (BH_) 11/12→ | | | | | |
|  Brake Hose | | | | | |
| 0.9 TCe 75 | 56 | 05/18→ | Required quantity: 2; | 2 24.5103-0446.3 331630 | Length [mm]: 470 |
| 0.9 TCe 90 | 66 | 11/12→ | Fitting Position: Front Axle | | |
| 0.9 TCe 90 LPG | 66 | 06/16→ | | | |
| 1.2 16V | 54 | 11/12→ | | | |
| | 55 | | | | |
| 1.2 LPG | 53 | 01/14→ | | | |
| 1.2 LPG 16V | 54 | 11/12→06/15 | | | |
| 1.2 TCe 120 | 87 | 03/13→ | | | |
| | 88 | | | | |
| 1.5 dCi 110 | 81 | 06/16→ | | | |
| 1.5 dCi 75 | 55 | 11/12→ | | | |
| 1.5 dCi 90 | 66 | 11/12→ | | | |
| 1.6 RS | 147 | 03/13→ | | | |
| 1.6 RS Trophy | 162 | 03/15→ | | | |
| 1.5 dCi | 62 | 11/12→ | Required quantity: 2; | 2 24.5103-0446.3 331630 | Length [mm]: 470 |
| | 63 | | → Construction year to: 11/16; | | |
| | | | Fitting Position: Front Axle | | |
| RENAULT - CLIO IV Estate Van (KH_) 01/13→ | | | | | |
|  Brake Hose | | | | | |
| 0.9 TCe 90 | 66 | 01/14→ | Required quantity: 2; | 2 24.5103-0446.3 331630 | Length [mm]: 470 |
| 1.5 dCi 75 | 55 | 01/14→ | Fitting Position: Front Axle | | |
| 1.5 dCi 90 | 66 | 01/14→ | | | |
| RENAULT - CLIO IV Grandtour (KH_) 11/12→ | | | | | |
|  Brake Hose | | | | | |
| 0.9 TCe 90 | 66 | 01/13→ | Required quantity: 2; | 2 24.5103-0446.3 331630 | Length [mm]: 470 |
| 1.2 16V | 54 | 01/13→ | Fitting Position: Front Axle | | |
| 1.2 TCe 120 | 87 | 03/13→ | | | |
| | 88 | | | | |
| 1.5 dCi 110 | 81 | 06/16→ | | | |
| 1.5 dCi 75 | 55 | 01/13→ | | | |
| 1.5 dCi 90 | 66 | 11/12→ | | | |
| RENAULT - CLIO IV Hatchback Van (BH_) 01/14→ | | | | | |
|  Brake Hose | | | | | |
| 0.9 TCe 90 | 66 | 01/14→ | Required quantity: 2; | 2 24.5103-0446.3 331630 | Length [mm]: 470 |
| 0.9 TCe 90 LPG | 66 | 08/15→ | Fitting Position: Front Axle | | |
| → | | | | | |



| | | | | | |
|---|---------------------|---|---|------------------------------|------------------|
| | kW | | | | |
| RENAULT - CLIO IV Hatchback Van (BH_) 01/14→ | | | | | |
|  Brake Hose | | | | | |
| 1.2 16V | 54 - 01/14→ 55 | Required quantity: 2; Fitting Position: Front Axle | 2 | 24.5103-0446.3 331630 | Length [mm]: 470 |
| 1.2 16V LPG | 53 01/14→ | | | | |
| 1.5 dCi 75 | 55 01/14→ | | | | |
| 1.5 dCi 90 | 66 01/14→ | | | | |
| RENAULT - KOLEOS I (HY_) 09/08→ | | | | | |
| Accessory Kit, disc brake pad | | | | | |
| 2.0 | 103 08/13→ | Fitting Position: Rear Axle | | 13.0460-0527.2 610527 | |
| 2.0 dCi | 110 - 09/08→ 127 | | | | |
| 2.0 dCi 4x4 | 110 - 09/08→ 130 | | | | |
| 2.5 | 126 09/08→ | | | | |
| 2.5 4x4 | 126 09/08→ | | | | |
| RENAULT - MODUS / GRAND MODUS (F/JP0_) 09/04→ | | | | | |
|  Wheel Speed Sensor | | | | | |
| 1.2 | 48 - 12/04→ 76 | - ESP; Fitting Position: Rear Axle Right | | 24.0710-2031.3 360551 | Length [mm]: 661 |
| 1.2 16V | 74 05/07→ | | | | |
| 1.2 16V Hi-Flex | 55 10/08→ | | | | |
| 1.2 GPL | 55 05/08→12/12 | | | | |
| 1.4 | 72 12/04→ | | | | |
| 1.5 dCi | 50 - 09/04→ 78 | | | | |
| 1.5 dCi 75 | 55 10/10→ | | | | |
| 1.5 dCi 90 | 65 10/10→ | | | | |
| 1.6 | 65 - 12/04→ 82 | | | | |
| RENAULT - ZOE (BFM_) 06/12→ | | | | | |
|  Brake Hose | | | | | |
| ZOE | 65 - 06/12→ 68 | → Construction year to: 11/16; Required quantity: 2; Fitting Position: Front Axle | 2 | 24.5103-0446.3 331630 | Length [mm]: 470 |
| SEAT - ALHAMBRA (710, 711) 06/10→ | | | | | |
|  Wheel Speed Sensor | | | | | |
| 1.4 TSI | 110 06/10→ | Fitting Position: Front Axle Left | | 24.0711-5271.3 360301 | |
| 1.8 TSI | 118 11/12→04/15 | | | | |
| 2.0 TDI | 85 - 06/10→ 135 | Fitting Position: Front Axle Right | | 24.0711-5272.3 360302 | |
| 2.0 TDi 4Drive | 130 11/18→ | | | | |
| 2.0 TDI 4Drive | 110 - 05/15→ 135 | | | | |
| 2.0 TFSI | 147 11/10→05/12 | | | | |
| 2.0 TSI | 162 05/15→ | | | | |
| 2.0 TDI 4Drive | 103 05/11→04/15 | Fitting Position: Front Axle Left | | 24.0711-5271.3 360301 | |
| | | Fitting Position: Front Axle Right | | 24.0711-5272.3 360302 | |
| | | for PR number: 7X0 / 7X2 / 7Y0 / 7Y4; Fitting Position: Rear Axle Left | | 24.0711-5271.3 360301 | |
| | | for PR number: 7X0 / 7X2 / 7Y0 / 7Y4; Fitting Position: Rear Axle Right | | 24.0711-5272.3 360302 | |
| SEAT - ALHAMBRA VAN (711) 06/10→ | | | | | |
|  Wheel Speed Sensor | | | | | |
| TDI | 110 - 05/15→ 135 | Fitting Position: Front Axle Left | | 24.0711-5271.3 360301 | |
| TDI 4Drive | 110 05/15→ | Fitting Position: Front Axle Right | | 24.0711-5272.3 360302 | |
| TSi | 110 05/15→ | | | | |
| SEAT - ALTEA (5P1) 03/04→ | | | | | |
|  Wheel Speed Sensor | | | | | |
| 1.2 TSI | 77 04/10→ | Fitting Position: Front Axle Left | | 24.0711-5271.3 360301 | |
| 1.4 16V | 63 05/06→ | | | | |
| 1.4 TSI | 92 11/07→ | Fitting Position: Front Axle Right | | 24.0711-5272.3 360302 | |
| 1.6 | 75 03/04→ | for PR number: 1X1; | | 24.0711-5271.3 360301 | |
| 1.6 LPG | 75 09/09→ | Fitting Position: Rear Axle Left | | | |
| 1.6 TDI | 66 - 10/09→ 77 | for PR number: 1X1; Fitting Position: Rear Axle Right | | 24.0711-5272.3 360302 | |
| 1.8 TFSI | 118 01/07→ | | | | |
| 1.9 TDI | 66 - 04/04→ 77 | | | | |
| 2.0 FSI | 110 05/04→03/09 | | | | |
| → | | | | | |



| | kW | | | | |
|--|--------------------------|--|--|-----------------------|--|
| SEAT - ALTEA (5P1) 03/04→ | | | | | |
|  Wheel Speed Sensor | | | | | |
| 2.0 TDI | 100 - 03/04→ 125 | | Fitting Position: Front Axle Left | 24.0711-5271.3 | 360301 |
| 2.0 TDI 16V | 103 03/04→ | | Fitting Position: Front Axle Right | 24.0711-5272.3 | 360302 |
| 2.0 TDI 16V 4WD | 103 10/10→ | | for PR number: 1X1; | 24.0711-5271.3 | 360301 |
| 2.0 TFSI | 147 04/06→05/09 | | Fitting Position: Rear Axle Left | 24.0711-5272.3 | 360302 |
| | | | for PR number: 1X1; | 24.0711-5272.3 | 360302 |
| | | | Fitting Position: Rear Axle Right | | |
| 1.6 Multifuel | 75 11/10→05/11 | | Fitting Position: Front Axle Left | 24.0711-5271.3 | 360301 |
| | | | Fitting Position: Front Axle Right | 24.0711-5272.3 | 360302 |
| SEAT - ALTEA XL (5P5, 5P8) 10/06→ | | | | | |
|  Wheel Speed Sensor | | | | | |
| 1.2 TSI | 77 04/10→ | | Fitting Position: Front Axle Left | 24.0711-5271.3 | 360301 |
| 1.4 TSI | 92 11/07→ | | Fitting Position: Front Axle Right | 24.0711-5272.3 | 360302 |
| 1.6 | 75 10/06→ | | | | |
| 1.6 LPG | 75 09/09→ | | | | |
| 1.6 Multifuel | 75 10/06→11/10 | | | | |
| 1.6 TDI | 66 - 10/09→ 77 | | | | |
| 1.8 TFSI | 118 01/07→ | | | | |
| 1.9 TDI | 66 - 10/06→12/10 77 | | | | |
| 1.9 TDI 4x4 | 77 06/09→12/10 | | | | |
| 2.0 FSI | 110 10/06→03/09 | | | | |
| 2.0 TDI | 100 - 10/06→ 125 | | | | |
| 2.0 TDI 16V | 103 10/06→ | | | | |
| 2.0 TFSI | 147 10/06→05/09 | | | | |
| 1.4 16V | 63 10/06→ | | Construction year from: 05/08 →; | 24.0711-5271.3 | 360301 |
| | | | Fitting Position: Front Axle Left | 24.0711-5272.3 | 360302 |
| | | | Construction year from: 05/08 →; | 24.0711-5272.3 | 360302 |
| | | | Fitting Position: Front Axle Right | | |
| 2.0 TDI 16V 4x4 | 103 10/10→ | | Fitting Position: Front Axle Left | 24.0711-5271.3 | 360301 |
| 2.0 TDI 4x4 | 103 - 06/07→ 125 | | Fitting Position: Front Axle Right | 24.0711-5272.3 | 360302 |
| 2.0 TFSI | 155 05/09→ | | Fitting Position: Rear Axle Left | 24.0711-5271.3 | 360301 |
| 2.0 TFSI 4x4 | 147 - 06/07→ 155 | | Fitting Position: Rear Axle Right | 24.0711-5272.3 | 360302 |
| SEAT - ATECA (KH7, KHP) 04/16→ | | | | | |
|  Brake Pad Set, disc brake | | | | | |
| 1.0 TSI | 81 - 05/16→ 85 | | for PR number: 1ZA / 1ZE / 1ZJ; Fitting Position: Front Axle | 13.0470-2785.2 | LD2785 Brake System: Lucas / TRW 25683 20,4 Wear Warning Contact: prepared for wear indicator / incl. wear warning contact Ceramic |
| 1.4 TSI | 110 06/16→ | | | | |
| 1.4 TSI 4Drive | 110 06/16→ | | | | |
| 1.5 TSI | 110 07/18→ | | | | |
| 1.5 TSI 4Drive | 110 07/18→ | | | | |
| 1.6 TDI | 85 04/16→07/18 | | | | |
| 2.0 TDI | 81 - 04/16→ 110 | | | | |
| 2.0 TDI 4Drive | 110 - 04/16→ 140 | | | | |
| 2.0 TSI 4Drive | 140 05/17→ | | | | |
| SEAT - LEON (1P1) 05/05→12/13 | | | | | |
|  Wheel Speed Sensor | | | | | |
| 1.2 TSI | 77 02/10→12/12 | | → Construction year to: 10/12; | 24.0711-5271.3 | 360301 |
| 1.4 16V | 63 06/06→12/12 | | Fitting Position: Front Axle Left | 24.0711-5272.3 | 360302 |
| 1.4 TSI | 92 11/07→12/12 | | → Construction year to: 10/12; | 24.0711-5272.3 | 360302 |
| 1.6 LPG | 75 12/09→12/12 | | Fitting Position: Front Axle Right | | |
| 1.6 MultiFuel | 75 07/05→08/13 | | | | |
| 1.6 TDI | 66 - 02/10→12/12 77 | | | | |
| 1.8 TSI | 118 06/07→12/12 | | | | |
| 2.0 Cupra R | 195 09/09→12/12 | | | | |
| 2.0 TDI | 125 05/06→12/12 | | | | |
| 2.0 TFSI | 155 06/09→12/12 | | | | |
| 1.6 | 75 07/05→12/12 | | Construction year from: 08/05 → → | 24.0711-5271.3 | 360301 |
| 2.0 TDI 16V | 103 07/05→12/12 | | Construction year to: 10/12; Fitting Position: Front Axle Left | 24.0711-5272.3 | 360302 |
| | | | Construction year from: 08/05 → → | 24.0711-5272.3 | 360302 |
| | | | Construction year to: 10/12; Fitting Position: Front Axle Right | | |
| 1.9 TDI | 66 06/07→12/10 | | Fitting Position: Front Axle Left | 24.0711-5271.3 | 360301 |
| 2.0 TDI | 103 10/05→10/10 | | Fitting Position: Front Axle Right | 24.0711-5272.3 | 360302 |
| 2.0 TFSI | 136 - 09/05→05/11 177 | | | | |
| → | | | | | |





| | kW | | | | |
|--|-----------|-------------|---|------------------------------|---|
| SEAT - LEON (1P1) 05/05→12/13 | | | | | |
|  Wheel Speed Sensor | | | | | |
| 1.9 TDI | 77 | 07/05→12/10 | Construction year from: 08/05 →; | | 24.0711-5271.3 360301 |
| 2.0 FSI | 110 | 07/05→05/10 | Fitting Position: Front Axle Left | | |
| 2.0 TDI | 100 | 07/05→05/10 | Construction year from: 08/05 →; | | 24.0711-5272.3 360302 |
| 2.0 TFSI | 147 | 05/05→03/09 | Fitting Position: Front Axle Right | | |
| SEAT - LEON (5F1) 09/12→05/21 | | | | | |
|  Brake Pad Set, disc brake | | | | | |
| 1.0 TSi | 63 | 09/18→08/20 | for PR number: 1ZA / 1ZE; | 13.0470-2785.2 LD2785 | Brake System: Lucas / TRW 25683 20,4 Wear Warning Contact: prepared for wear indicator / incl. wear warning contact Ceramic |
| 1.0 TSi | 85 | 05/15→08/20 | Fitting Position: Front Axle | | |
| 1.2 TSi | 63 - 81 | 12/12→08/20 | | | |
| 1.4 TGI | 81 | 02/13→08/18 | | | |
| 1.4 TSi | 90 - 110 | 09/12→08/20 | | | |
| 1.5 TGi | 96 | 10/18→08/20 | | | |
| 1.5 TSi | 96 - 110 | 09/18→08/20 | | | |
| 1.6 TDI | 66 - 85 | 09/12→08/20 | | | |
| 1.8 TSi | 132 | 02/13→08/18 | | | |
| 2.0 Cupra | 195 - 221 | 10/13→08/20 | | | |
| 2.0 TDI | 81 - 135 | 09/12→08/20 | | | |
| 2.0 TSi | 140 | 09/18→08/20 | | | |
| SEAT - LEON (KL1) 11/19→ | | | | | |
|  Brake Pad Set, disc brake | | | | | |
| 1.0 TSi | 66 - 81 | 03/20→ | for PR number: 1ZK; | 13.0470-2785.2 LD2785 | Brake System: Lucas / TRW 25683 20,4 Wear Warning Contact: prepared for wear indicator / incl. wear warning contact Ceramic |
| 1.0 TSi Mild Hybrid | 81 | 08/20→ | Fitting Position: Front Axle | | |
| 1.4 TSi e-Hybrid | 110 - 150 | 05/20→ | | | |
| 1.5 eTSI | 110 | 11/19→ | | | |
| 1.5 TGI CNG | 96 | 08/20→ | | | |
| 1.5 TSi | 96 - 110 | 11/19→ | | | |
| 2.0 TDI | 85 - 110 | 11/19→ | | | |
| 2.0 TFSI | 140 | 03/21→ | | | |
| SEAT - LEON Hatchback Van (5F1) 09/12→08/20 | | | | | |
|  Brake Pad Set, disc brake | | | | | |
| 1.0 TSi | 85 | 05/15→08/20 | for PR number: 1ZA / 1ZE; | 13.0470-2785.2 LD2785 | Brake System: Lucas / TRW 25683 20,4 Wear Warning Contact: prepared for wear indicator / incl. wear warning contact Ceramic |
| 1.2 TSi | 81 | 04/14→08/18 | Fitting Position: Front Axle | | |
| 1.4 TSi | 90 - 110 | 09/12→08/20 | | | |
| 1.6 TDI | 66 - 85 | 09/12→08/20 | | | |
| 1.8 TFSI | 132 | 02/13→08/18 | | | |
| 2.0 Cupra | 213 - 221 | 09/15→08/18 | | | |
| 2.0 TDI | 110 - 135 | 10/12→08/18 | | | |
| 1.2 TSi | 63 | 01/13→08/18 | Construction year from: 04/14 →; | 13.0470-2785.2 LD2785 | Brake System: Lucas / TRW 25683 20,4 Wear Warning Contact: prepared for wear indicator / incl. wear warning contact Ceramic |
| | | | for PR number: 1ZA / 1ZE; Fitting Position: Front Axle | | |
| SEAT - LEON SC (5F5) 01/13→12/18 | | | | | |
|  Brake Pad Set, disc brake | | | | | |
| 1.0 TSi | 85 | 05/15→08/18 | for PR number: 1ZA / 1ZE; | 13.0470-2785.2 LD2785 | Brake System: Lucas / TRW 25683 20,4 Wear Warning Contact: prepared for wear indicator / incl. wear warning contact Ceramic |
| 1.2 TSi | 63 - 81 | 01/13→08/18 | Fitting Position: Front Axle | | |
| 1.4 TSi | 90 - 110 | 02/13→08/18 | | | |
| 1.6 TDI | 66 - 85 | 02/13→08/18 | | | |
| 1.8 TSi | 132 | 02/13→08/18 | | | |
| 2.0 Cupra | 195 - 221 | 10/13→08/18 | | | |
| 2.0 TDI | 81 - 135 | 02/13→08/18 | | | |





| | kW | | | |
|--|--------------------------|--|------------------------------|---|
| SEAT - LEON Sportstourer (KL8) 03/20→ | | | | |
|  Brake Pad Set, disc brake | | | | |
| 1.0 TSI | 66 - 03/20→ 81 | for PR number: 1ZK; Fitting Position: Front Axle | 13.0470-2785.2 LD2785 | Brake System: Lucas / TRW 25683 20,4 Wear Warning Contact: prepared for wear indicator / incl. wear warning contact Ceramic |
| 1.0 TSI Mild Hybrid | 81 08/20→ | | | |
| 1.4 TSI e-Hybrid | 110 - 05/20→ 150 | | | |
| 1.5 eTSI | 110 03/20→ | | | |
| 1.5 TGI | 96 05/21→ | | | |
| 1.5 TSI | 96 - 03/20→ 110 | | | |
| 2.0 TDI | 85 - 04/20→ 110 | | | |
| 2.0 TDI 4Drive | 110 11/20→ | | | |
| 2.0 TFSI | 140 03/21→ | | | |
| SEAT - LEON ST (5F8) 09/12→08/20 | | | | |
|  Brake Pad Set, disc brake | | | | |
| 1.0 TSi | 63 09/18→08/20 | for PR number: 1ZA / 1ZE; Fitting Position: Front Axle | 13.0470-2785.2 LD2785 | Brake System: Lucas / TRW 25683 20,4 Wear Warning Contact: prepared for wear indicator / incl. wear warning contact Ceramic |
| 1.0 TSI | 85 05/15→08/20 | | | |
| 1.2 TSI | 63 - 08/13→08/20 81 | | | |
| 1.4 TGI | 81 10/13→08/18 | | | |
| 1.4 TSI | 90 - 09/12→08/20 110 | | | |
| 1.5 TGI | 96 10/18→08/20 | | | |
| 1.5 TSI | 96 - 09/18→08/20 110 | | | |
| 1.6 TDI | 66 - 09/13→08/20 85 | | | |
| 1.6 TDI 4Drive | 77 - 04/14→08/20 85 | | | |
| 1.8 TSI | 132 10/13→08/18 | | | |
| 1.8 TSI 4Drive | 132 11/14→08/18 | | | |
| 2.0 Cupra | 195 - 10/13→08/20 221 | | | |
| 2.0 Cupra 4Drive | 221 11/16→08/20 | | | |
| 2.0 TDI | 81 - 02/13→08/20 135 | | | |
| 2.0 TDI 4Drive | 110 - 04/14→08/18 135 | | | |
| 2.0 TSI | 140 07/18→08/20 | | | |
| 2.0 TSI 4Drive | 140 09/18→08/20 | | | |
|  Wheel Speed Sensor | | | | |
| 1.6 TDI 4Drive | 77 - 04/14→08/20 85 | Vehicle Equipment: for vehicles without autom. distance control; Fitting Position: Rear Axle Left | 24.0711-5271.3 360301 | |
| 1.8 TSI 4Drive | 132 11/14→08/18 | | | |
| 2.0 Cupra 4Drive | 221 11/16→08/20 | | | |
| 2.0 TDI 4Drive | 110 - 04/14→08/18 135 | Vehicle Equipment: for vehicles without autom. distance control; Fitting Position: Rear Axle Right | 24.0711-5272.3 360302 | |
| 2.0 TSI 4Drive | 140 09/18→08/20 | | | |
| SEAT - LEON ST Estate Van (5F8) 01/13→08/20 | | | | |
|  Brake Pad Set, disc brake | | | | |
| 1.0 TSI | 85 05/15→08/20 | for PR number: 1ZA / 1ZE; Fitting Position: Front Axle | 13.0470-2785.2 LD2785 | Brake System: Lucas / TRW 25683 20,4 Wear Warning Contact: prepared for wear indicator / incl. wear warning contact Ceramic |
| 1.2 TSI | 63 - 01/13→08/18 81 | | | |
| 1.4 TSI | 110 05/14→08/20 | | | |
| 1.6 TDI | 81 - 09/13→08/20 85 | | | |
| 1.8 TFSI | 132 10/13→08/18 | | | |
| 2.0 Cupra | 206 - 10/13→08/20 221 | | | |
| 2.0 Cupra 4Drive | 221 11/16→08/18 | | | |
| 2.0 TDI | 110 - 04/13→08/18 135 | | | |
| 2.0 TDI 4Drive | 110 09/14→08/18 | | | |
| 2.0 TDI 4Drive | 135 10/14→08/18 | Construction year from: 11/14 →; for PR number: 1ZA / 1ZE; Fitting Position: Front Axle | 13.0470-2785.2 LD2785 | Brake System: Lucas / TRW 25683 20,4 Wear Warning Contact: prepared for wear indicator / incl. wear warning contact Ceramic |
|  Wheel Speed Sensor | | | | |
| 2.0 Cupra 4Drive | 221 11/16→08/18 | Vehicle Equipment: for vehicles without autom. distance control; Fitting Position: Rear Axle Left | 24.0711-5271.3 360301 | |
| 2.0 TDI 4Drive | 110 - 09/14→08/18 135 | Vehicle Equipment: for vehicles without autom. distance control; Fitting Position: Rear Axle Right | 24.0711-5272.3 360302 | |





| | | | | | | |
|--|-------|-------------|---|------------------------------|---|--|
| | | | | | | |
| SEAT - TARRACO (KN2) 09/18→ | | | | | | |
|  Brake Pad Set, disc brake | | | | | | |
| 1.4 e-HYBRID | 180 | 02/21→ | for PR number: 1ZK; Fitting Position: Front Axle | 13.0470-2785.2 LD2785 | Brake System: Lucas / TRW 25683 20,4 Wear Warning Contact: prepared for wear indicator / incl. wear warning contact Ceramic | |
| 1.4 TSI Plug in Hybrid | 110 | 02/21→ | | | | |
| 1.5 TSI ACT | 110 | 09/18→ | | | | |
| 2.0 TDI | 110 | 09/18→ | | | | |
| 2.0 TDI 4Drive | 110 - | 09/18→ | | | | |
| | 147 | | | | | |
| 2.0 TFSI 4Drive | 180 | 01/21→ | | | | |
| 2.0 TSI 4Drive | 140 | 11/18→ | | | | |
| SEAT - TOLEDO III (5P2) 04/04→05/09 | | | | | | |
|  Wheel Speed Sensor | | | | | | |
| 1.4 16V | 63 | 05/06→05/09 | → Construction year to: 03/09; Fitting Position: Front Axle Left | 24.0711-5271.3 360301 | | |
| 1.4 TSI | 92 | 11/07→05/09 | | | | |
| 1.6 | 75 | 10/04→05/09 | → Construction year to: 03/09; Fitting Position: Front Axle Right | 24.0711-5272.3 360302 | | |
| 1.8 TFSI | 118 | 01/07→05/09 | | | | |
| 1.9 TDI | 77 | 10/04→05/09 | | | | |
| 2.0 FSI | 110 | 10/04→05/09 | | | | |
| 2.0 TDI | 103 - | 11/05→05/09 | | | | |
| | 125 | | | | | |
| 2.0 TFSI | 147 | 11/05→05/09 | | | | |
| 2.0 TDI | 100 | 09/04→05/09 | Construction year from: 10/04 → → Construction year to: 03/09; Fitting Position: Front Axle Left | 24.0711-5271.3 360301 | | |
| 2.0 TDI 16V | 103 | 04/04→05/09 | | | | |
| | | | Construction year from: 10/04 → → Construction year to: 03/09; Fitting Position: Front Axle Right | 24.0711-5272.3 360302 | | |
| | | | | | | |
| SKODA - KAROQ (NU7, ND7) 07/17→ | | | | | | |
|  Brake Pad Set, disc brake | | | | | | |
| 1.0 TSI | 81 - | 07/17→ | for PR number: 1ZE / 9U1; Fitting Position: Front Axle | 13.0470-2785.2 LD2785 | Brake System: Lucas / TRW 25683 20,4 Wear Warning Contact: prepared for wear indicator / incl. wear warning contact Ceramic | |
| | 85 | | | | | |
| 1.4 TSI | 110 | 07/17→ | | | | |
| 1.5 TSI | 110 | 07/17→ | | | | |
| 1.5 TSI 4x4 | 110 | 07/17→ | | | | |
| 1.6 SRE | 81 | 07/17→ | for PR number: 1ZA / 1ZK; Fitting Position: Front Axle | 13.0470-2785.2 LD2785 | Brake System: Lucas / TRW 25683 20,4 Wear Warning Contact: prepared for wear indicator / incl. wear warning contact Ceramic | |
| 1.6 TDI | 85 | 07/17→ | | | | |
| 2.0 TDI | 85 - | 07/17→ | | | | |
| | 110 | | | | | |
| 2.0 TDI 4x4 | 85 - | 07/17→ | | | | |
| | 140 | | | | | |
| 2.0 TSI 4x4 | 140 | 04/19→ | | | | |
| SKODA - KODIAQ (NS7, NV7, NS6) 10/16→ | | | | | | |
|  Brake Pad Set, disc brake | | | | | | |
| 1.4 TSI | 92 - | 10/16→ | for PR number: 1ZA / 1ZK; Fitting Position: Front Axle | 13.0470-2785.2 LD2785 | Brake System: Lucas / TRW 25683 20,4 Wear Warning Contact: prepared for wear indicator / incl. wear warning contact Ceramic | |
| | 110 | | | | | |
| 1.4 TSI 4x4 | 110 | 10/16→ | | | | |
| 1.5 TSI | 110 | 07/18→ | | | | |
| 1.5 TSI 4x4 | 110 | 07/18→ | | | | |
| 2.0 RS 4x4 | 180 | 06/21→ | | | | |
| 2.0 RS Bi-TDI 4x4 | 176 | 11/18→ | | | | |
| 2.0 TDI | 110 | 10/16→ | | | | |
| 2.0 TDI 4x4 | 110 - | 10/16→ | | | | |
| | 147 | | | | | |
| 2.0 TSI 4x4 | 132 - | 10/16→ | | | | |
| | 140 | | | | | |
| SKODA - OCTAVIA II (1Z3) 02/04→06/13 | | | | | | |
|  Wheel Speed Sensor | | | | | | |
| 1.2 TSI | 77 | 02/10→06/13 | → Construction year to: 01/13; Fitting Position: Front Axle Left | 24.0711-5271.3 360301 | | |
| 1.4 | 59 | 06/04→04/13 | | | | |
| 1.4 TSI | 90 | 11/08→06/13 | → Construction year to: 01/13; Fitting Position: Front Axle Right | 24.0711-5272.3 360302 | | |
| 1.6 | 75 | 06/04→06/13 | | | | |
| 1.6 TDI | 77 | 06/09→04/13 | | | | |
| 1.8 TSI | 112 - | 06/07→06/13 | | | | |
| | 118 | | | | | |
| 2.0 TDI | 81 | 03/10→06/13 | | | | |
| 2.0 TFSI | 147 | 10/05→02/13 | | | | |
| 1.4 | 55 | 05/04→05/06 | Construction year from: 06/04 →; Fitting Position: Front Axle Left | 24.0711-5271.3 360301 | | |
| 1.6 FSI | 85 | 02/04→10/08 | | | | |
| 2.0 TDI | 100 | 02/04→05/10 | Construction year from: 06/04 →; Fitting Position: Front Axle Right | 24.0711-5272.3 360302 | | |
| | | | | | | |
| 1.6 LPG | 75 | 08/09→11/12 | Construction year from: 09/09 →; Fitting Position: Front Axle Left | 24.0711-5271.3 360301 | | |
| | | | | | | |
| | | | Construction year from: 09/09 →; Fitting Position: Front Axle Right | 24.0711-5272.3 360302 | | |
| | | | | | | |
| → | | | | | | |







| | kw | | | |
|--|-----------|-------------|---|--|
| SKODA - OCTAVIA II (1Z3) 02/04→06/13 | | | | |
|  Wheel Speed Sensor | | | | |
| 1.6 MultiFuel | 75 | 01/08→06/13 | Construction year from: 09/09 → → Construction year to: 01/13; Fitting Position: Front Axle Left | 24.0711-5271.3 360301 |
| | | | Construction year from: 09/09 → → Construction year to: 01/13; Fitting Position: Front Axle Right | 24.0711-5272.3 360302 |
| 1.9 TDI | 77 | 06/04→12/10 | Fitting Position: Front Axle Left | 24.0711-5271.3 360301 |
| 2.0 FSI | 110 | 11/04→10/08 | Fitting Position: Front Axle Right | 24.0711-5272.3 360302 |
| 2.0 TDI | 103 | 11/05→05/10 | | |
| 2.0 TDI RS | 125 | 04/06→02/13 | | |
| 2.0 TDI 16V | 103 | 02/04→04/13 | Construction year from: 06/04 → → Construction year to: 01/13; Fitting Position: Front Axle Left | 24.0711-5271.3 360301 |
| | | | Construction year from: 06/04 → → Construction year to: 01/13; Fitting Position: Front Axle Right | 24.0711-5272.3 360302 |
| SKODA - OCTAVIA II Combi (1Z5) 02/04→06/13 | | | | |
|  Wheel Speed Sensor | | | | |
| 1.2 TSI | 77 | 02/10→04/13 | → Construction year to: 01/13; Fitting Position: Front Axle Left | 24.0711-5271.3 360301 |
| 1.4 | 59 | 05/06→06/13 | | |
| 1.4 TSI | 90 | 11/08→06/13 | → Construction year to: 01/13; Fitting Position: Front Axle Right | 24.0711-5272.3 360302 |
| 1.6 | 75 | 09/04→06/13 | | |
| 1.6 TDI | 77 | 06/09→04/13 | | |
| 1.8 TSI | 112 - 118 | 06/07→06/13 | | |
| 2.0 TDI | 81 | 03/10→06/13 | | |
| 2.0 TFSI | 147 | 10/05→02/13 | | |
| 1.4 | 55 | 05/04→05/06 | Construction year from: 06/04 → ; Fitting Position: Front Axle Left | 24.0711-5271.3 360301 |
| 1.6 FSI | 85 | 02/04→10/08 | | |
| 2.0 TDI 16V | 100 | 02/04→05/10 | Construction year from: 06/04 → ; Fitting Position: Front Axle Right | 24.0711-5272.3 360302 |
| 1.6 LPG | 75 | 08/09→11/12 | Construction year from: 09/09 → ; Fitting Position: Front Axle Left | 24.0711-5271.3 360301 |
| | | | Construction year from: 09/09 → ; Fitting Position: Front Axle Right | 24.0711-5272.3 360302 |
| 1.6 MultiFuel | 75 | 01/08→06/13 | Construction year from: 09/09 → → Construction year to: 01/13; Fitting Position: Front Axle Left | 24.0711-5271.3 360301 |
| | | | Construction year from: 09/09 → → Construction year to: 01/13; Fitting Position: Front Axle Right | 24.0711-5272.3 360302 |
| 1.6 TDI 4x4 | 77 | 06/09→02/13 | → Construction year to: 01/13; Fitting Position: Front Axle Left | 24.0711-5271.3 360301 |
| 1.8 TSI 4x4 | 112 - 118 | 11/08→02/13 | | |
| 2.0 TDI 16V 4x4 | 103 | 05/10→02/13 | → Construction year to: 01/13; Fitting Position: Front Axle Right | 24.0711-5272.3 360302 |
| 2.0 TDI 4x4 | 81 | 05/11→02/13 | → Construction year to: 01/13; Fitting Position: Rear Axle Left | 24.0711-5271.3 360301 |
| | | | → Construction year to: 01/13; Fitting Position: Rear Axle Right | 24.0711-5272.3 360302 |
| 1.9 TDI | 77 | 09/04→12/10 | Fitting Position: Front Axle Left | 24.0711-5271.3 360301 |
| 2.0 FSI | 110 | 11/04→10/08 | Fitting Position: Front Axle Right | 24.0711-5272.3 360302 |
| 2.0 TDI | 103 | 11/05→05/10 | | |
| 2.0 TDI RS | 125 | 04/06→02/13 | | |
| 1.9 TDI 4x4 | 77 | 11/04→12/10 | Fitting Position: Front Axle Left | 24.0711-5271.3 360301 |
| 2.0 FSI 4x4 | 110 | 11/04→04/09 | Fitting Position: Front Axle Right | 24.0711-5272.3 360302 |
| 2.0 TDI 4x4 | 103 | 07/06→05/10 | Fitting Position: Rear Axle Left | 24.0711-5271.3 360301 |
| | | | Fitting Position: Rear Axle Right | 24.0711-5272.3 360302 |
| 2.0 TDI 16V | 103 | 02/04→05/13 | Construction year from: 06/04 → → Construction year to: 01/13; Fitting Position: Front Axle Left | 24.0711-5271.3 360301 |
| | | | Construction year from: 06/04 → → Construction year to: 01/13; Fitting Position: Front Axle Right | 24.0711-5272.3 360302 |
| SKODA - OCTAVIA III (5E3, NL3, NR3) 11/12→03/21 | | | | |
|  Brake Pad Set, disc brake | | | | |
| 1.0 TSI | 85 | 05/16→10/20 | for PR number: 1ZK / 1ZJ / 1ZU; Fitting Position: Front Axle | 13.0470-2785.2 LD2785 Brake System: Lucas / TRW 25683 20,4 Wear Warning Contact: prepared for wear indicator / incl. wear warning contact Ceramic |
| 1.2 TSI | 81 | 05/15→02/17 | | |
| 1.4 TSI | 103 | 11/12→02/17 | | |
| 1.4 TSI G-TEC | 81 | 11/13→02/17 | | |
| 1.5 TSI | 110 | 02/17→10/20 | | |
| 1.6 | 81 | 01/14→10/20 | | |
| 1.6 TDI | 81 - 85 | 05/13→10/20 | | |
| → | | | | |







| | kW | | | |
|--|--------------------------|---|------------------------------|---|
| SKODA - OCTAVIA III (5E3, NL3, NR3) 11/12→03/21 | | | | |
|  Brake Pad Set, disc brake | | | | |
| 1.6 TDI 4x4 | 77 - 05/13→10/20 85 | for PR number: 1ZK / 1ZJ / 1ZU; Fitting Position: Front Axle | 13.0470-2785.2 LD2785 | Brake System: Lucas / TRW 25683 20,4 Wear Warning Contact: prepared for wear indicator / incl. wear warning contact Ceramic |
| 1.8 TSI | 132 11/12→10/20 | | | |
| 1.8 TSI 4x4 | 132 05/14→10/20 | | | |
| 2.0 TDI | 105 11/12→02/17 | | | |
| 2.0 TDI / TDI RS 4x4 | 135 05/13→10/20 | | | |
| 2.0 TDI 4x4 | 110 05/13→10/20 | | | |
| 2.0 TDI RS | 135 05/13→10/20 | | | |
| 2.0 TSI | 140 02/17→10/20 | | | |
| 2.0 TSI 4x4 | 140 02/19→10/20 | | | |
| 2.0 TSI RS | 162 - 05/13→10/20 180 | | | |
| 1.2 TSI | 63 - 11/12→02/17 77 | Construction year from: 02/13 →; for PR number: 1ZK / 1ZJ / 1ZU; Fitting Position: Front Axle | 13.0470-2785.2 LD2785 | Brake System: Lucas / TRW 25683 20,4 Wear Warning Contact: prepared for wear indicator / incl. wear warning contact Ceramic |
| 1.6 TDI | 66 - 11/12→10/20 77 | | | |
| 2.0 TDI | 110 11/12→10/20 | | | |
| 1.4 TSI | 110 08/14→10/20 | Construction year from: 05/15 →; for PR number: 1ZK / 1ZJ / 1ZU; Fitting Position: Front Axle | 13.0470-2785.2 LD2785 | Brake System: Lucas / TRW 25683 20,4 Wear Warning Contact: prepared for wear indicator / incl. wear warning contact Ceramic |
| SKODA - OCTAVIA III Combi (5E5, 5E6) 11/12→10/20 | | | | |
|  Brake Pad Set, disc brake | | | | |
| 1.0 TSI | 85 05/16→10/20 | for PR number: 1ZK / 1ZJ / 1ZU; Fitting Position: Front Axle | 13.0470-2785.2 LD2785 | Brake System: Lucas / TRW 25683 20,4 Wear Warning Contact: prepared for wear indicator / incl. wear warning contact Ceramic |
| 1.2 TSI | 81 05/15→02/17 | | | |
| 1.4 TSI | 103 11/12→02/17 | | | |
| 1.4 TSI G-TEC | 81 11/12→02/17 | | | |
| 1.5 TSI | 110 02/17→10/20 | | | |
| 1.5 TSI G-TEC | 96 01/19→10/20 | | | |
| 1.6 | 81 01/14→02/17 | | | |
| 1.6 TDI | 81 - 05/13→10/20 85 | | | |
| 1.6 TDI 4x4 | 77 - 11/12→10/20 85 | | | |
| 1.8 TSI | 132 11/12→10/20 | | | |
| 1.8 TSI 4x4 | 132 11/12→02/17 | | | |
| 2.0 TDI | 105 11/12→02/17 | | | |
| 2.0 TDI / TDI RS 4x4 | 135 05/13→10/20 | | | |
| 2.0 TDI 4x4 | 110 11/12→10/20 | | | |
| 2.0 TDI RS | 135 05/13→10/20 | | | |
| 2.0 TSI | 140 02/17→10/20 | | | |
| 2.0 TSI 4x4 | 140 02/19→10/20 | | | |
| 2.0 TSI RS | 169 - 05/15→10/20 180 | | | |
| 1.2 TSI | 63 - 11/12→02/17 77 | Construction year from: 02/13 →; for PR number: 1ZK / 1ZJ / 1ZU; Fitting Position: Front Axle | 13.0470-2785.2 LD2785 | Brake System: Lucas / TRW 25683 20,4 Wear Warning Contact: prepared for wear indicator / incl. wear warning contact Ceramic |
| 1.6 TDI | 66 - 11/12→10/20 77 | | | |
| 2.0 TDI | 110 11/12→10/20 | | | |
| 1.4 TSI | 110 08/14→10/20 | Construction year from: 05/15 →; for PR number: 1ZK / 1ZJ / 1ZU; Fitting Position: Front Axle | 13.0470-2785.2 LD2785 | Brake System: Lucas / TRW 25683 20,4 Wear Warning Contact: prepared for wear indicator / incl. wear warning contact Ceramic |
| 2.0 TSI RS | 162 11/12→02/17 | Construction year from: 05/13 →; for PR number: 1ZK / 1ZJ / 1ZU; Fitting Position: Front Axle | 13.0470-2785.2 LD2785 | Brake System: Lucas / TRW 25683 20,4 Wear Warning Contact: prepared for wear indicator / incl. wear warning contact Ceramic |
| SKODA - OCTAVIA IV (NX3, NN3) 01/20→ | | | | |
|  Brake Pad Set, disc brake | | | | |
| 1.0 TSI | 81 06/20→ | for PR number: 1ZU; Fitting Position: Front Axle | 13.0470-2785.2 LD2785 | Brake System: Lucas / TRW 25683 20,4 Wear Warning Contact: prepared for wear indicator / incl. wear warning contact Ceramic |
| 1.0 TSI e-TEC | 81 06/20→ | | | |
| 1.4 TSI IV | 110 - 06/20→ 150 | | | |
| 1.4 TSI RS IV | 110 - 06/20→ 180 | | | |
| 1.5 TSI | 110 01/20→ | | | |
| 1.5 TSI e-TEC | 110 11/20→ | | | |
| 1.5 TSI G-TEC | 96 06/20→ | | | |
| 1.6 SRE | 81 07/20→ | | | |
| 2.0 TDI | 85 - 01/20→ 110 | | | |
| 2.0 TDI 4x4 | 110 09/20→ | | | |
| 2.0 TDI RS | 147 07/20→ | | | |
| 2.0 TDI RS 4x4 | 147 07/20→ | | | |
| → | | | | |





| | | | | | |
|---|---|--|--|--|---|
| | kw | | | | |
| SKODA - OCTAVIA IV (NX3, NN3) 01/20→ | | | | | |
|  Brake Pad Set, disc brake | | | | | |
| 2.0 TSI 4x4 2.0 TSI RS | 140 07/20→ 180 03/20→ | | for PR number: 1ZU; Fitting Position: Front Axle | 13.0470-2785.2 LD2785 | Brake System: Lucas / TRW 25683 20,4 Wear Warning Contact: prepared for wear indicator / incl. wear warning contact Ceramic |
| SKODA - OCTAVIA IV Combi (NX5) 11/19→ | | | | | |
|  Brake Pad Set, disc brake | | | | | |
| 1.0 TSI 1.0 TSI e-TEC 1.4 TSI iV 1.4 TSI RS iV 1.5 TSI 1.5 TSI e-TEC 1.5 TSI G-TEC 2.0 TDI 2.0 TDI 4x4 2.0 TDI RS 2.0 TDI RS 4x4 2.0 TSI 4x4 2.0 TSI RS | 81 06/20→ 81 06/20→ 110 - 06/20→ 150 110 - 06/20→ 180 110 11/19→ 110 11/20→ 96 06/20→ 85 - 11/19→ 110 110 09/20→ 147 07/20→ 147 07/20→ 140 09/20→ 180 03/20→ | | for PR number: 1ZU; Fitting Position: Front Axle | 13.0470-2785.2 LD2785 | Brake System: Lucas / TRW 25683 20,4 Wear Warning Contact: prepared for wear indicator / incl. wear warning contact Ceramic |
| SKODA - SUPERB II (3T4) 03/08→05/15 | | | | | |
|  Wheel Speed Sensor | | | | | |
| 1.4 TSI 1.8 TSI 2.0 TDI | 92 07/08→05/15 118 03/08→05/15 125 07/08→05/15 | | Construction year from: 08/08 → → Construction year to: 02/15; Fitting Position: Front Axle Left | 24.0711-5271.3 360301 | |
| | | | Construction year from: 08/08 → → Construction year to: 02/15; Fitting Position: Front Axle Right | 24.0711-5272.3 360302 | |
| 1.6 TDI 1.8 TSI 2.0 TDI 16V 2.0 TFSI | 77 09/10→05/15 112 03/09→05/15 103 01/09→05/15 147 05/10→05/15 | | → Construction year to: 02/15; Fitting Position: Front Axle Left → Construction year to: 02/15; Fitting Position: Front Axle Right | 24.0711-5271.3 360301 24.0711-5272.3 360302 | |
| 1.8 TSI 4x4 2.0 TDI 16V 4x4 3.6 FSI 4x4 | 112 - 11/08→05/15 118 103 11/10→05/15 191 11/08→05/15 | | → Construction year to: 02/15; Fitting Position: Front Axle Left → Construction year to: 02/15; Fitting Position: Front Axle Right → Construction year to: 02/15; Fitting Position: Rear Axle Left → Construction year to: 02/15; Fitting Position: Rear Axle Right | 24.0711-5271.3 360301 24.0711-5272.3 360302 24.0711-5271.3 360301 24.0711-5272.3 360302 | |
| 1.9 TDI 2.0 TDI | 77 03/08→11/10 103 03/08→05/10 | | Construction year from: 08/08 → ; Fitting Position: Front Axle Left Construction year from: 08/08 → ; Fitting Position: Front Axle Right | 24.0711-5271.3 360301 24.0711-5272.3 360302 | |
| 2.0 TDI 4x4 | 125 09/08→05/15 | | Construction year from: 10/08 → → Construction year to: 02/15; Fitting Position: Front Axle Left Construction year from: 10/08 → → Construction year to: 02/15; Fitting Position: Front Axle Right Construction year from: 10/08 → → Construction year to: 02/15; Fitting Position: Rear Axle Left Construction year from: 10/08 → → Construction year to: 02/15; Fitting Position: Rear Axle Right | 24.0711-5271.3 360301 24.0711-5272.3 360302 24.0711-5271.3 360301 24.0711-5272.3 360302 | |
| SKODA - SUPERB II Estate (3T5) 10/09→05/15 | | | | | |
|  Wheel Speed Sensor | | | | | |
| 1.4 TSI 1.8 TSI | 92 10/09→05/15 112 - 10/09→05/15 118 | | Construction year from: 11/09 → → Construction year to: 02/15; Fitting Position: Front Axle Left | 24.0711-5271.3 360301 | |
| 2.0 TDI 2.0 TDI 16V | 125 10/09→05/15 103 10/09→05/15 | | Construction year from: 11/09 → → Construction year to: 02/15; Fitting Position: Front Axle Right | 24.0711-5272.3 360302 | |
| 1.6 TDI 2.0 TFSI | 77 09/10→05/15 147 05/10→05/15 | | → Construction year to: 02/15; Fitting Position: Front Axle Left → Construction year to: 02/15; Fitting Position: Front Axle Right | 24.0711-5271.3 360301 24.0711-5272.3 360302 | |
| → | | | | | |



| | kW | | | |
|--|--------------------------|---|--|---|
| SKODA - SUPERB II Estate (3T5) 10/09→05/15 | | | | |
|  Wheel Speed Sensor | | | | |
| 1.8 TSI 4x4 | 112 - 10/09→05/15 118 | Construction year from: 11/09 → → Construction year to: 02/15; Fitting Position: Front Axle Left | | 24.0711-5271.3 360301 |
| 2.0 TDI 4x4 | 125 10/09→05/15 | | | |
| 3.6 V6 4x4 | 191 10/09→05/15 | Construction year from: 11/09 → → Construction year to: 02/15; Fitting Position: Front Axle Right | | 24.0711-5272.3 360302 |
| | | Construction year from: 11/09 → → Construction year to: 02/15; Fitting Position: Rear Axle Left | | 24.0711-5271.3 360301 |
| | | Construction year from: 11/09 → → Construction year to: 02/15; Fitting Position: Rear Axle Right | | 24.0711-5272.3 360302 |
| 1.9 TDI | 77 10/09→11/10 | Fitting Position: Front Axle Left | | 24.0711-5271.3 360301 |
| | | Fitting Position: Front Axle Right | | 24.0711-5272.3 360302 |
| 2.0 TDI | 103 10/09→03/10 | Construction year from: 11/09 → →; Fitting Position: Front Axle Left | | 24.0711-5271.3 360301 |
| | | Construction year from: 11/09 → →; Fitting Position: Front Axle Right | | 24.0711-5272.3 360302 |
| 2.0 TDI 16V 4x4 | 103 11/10→05/15 | → Construction year to: 02/15; Fitting Position: Front Axle Left | | 24.0711-5271.3 360301 |
| | | → Construction year to: 02/15; Fitting Position: Front Axle Right | | 24.0711-5272.3 360302 |
| | | → Construction year to: 02/15; Fitting Position: Rear Axle Left | | 24.0711-5271.3 360301 |
| | | → Construction year to: 02/15; Fitting Position: Rear Axle Right | | 24.0711-5272.3 360302 |
| SKODA - SUPERB III (3V3) 03/15→ | | | | |
|  Brake Pad Set, disc brake | | | | |
| 1.4 TSI | 92 - 03/15→ 110 | for PR number: 1ZA / 1ZK; Fitting Position: Front Axle | | 13.0470-2785.2 LD2785 Brake System: Lucas / TRW 25683 20,4 Wear Warning Contact: prepared for wear indicator / incl. wear warning contact Ceramic |
| 1.4 TSI 4x4 | 110 03/15→ | | | |
| 1.4 TSI IV | 115 - 08/19→ 160 | | | |
| 1.5 TSI | 110 02/17→ | | | |
| 1.6 TDI | 88 03/15→ | | | |
| 1.8 TSI | 132 03/15→ | | | |
| 2.0 TDI | 90 - 03/15→ 147 | | | |
| 2.0 TDI 4x4 | 110 - 03/15→ 147 | | | |
| 2.0 TSI | 140 - 03/15→ 162 | | | |
| 2.0 TSI 4x4 | 200 - 03/15→ 206 | | | |
|  Wheel Speed Sensor | | | | |
| 1.4 TSI 4x4 | 110 03/15→ | Vehicle Equipment: for vehicles without parking assistant system; Fitting Position: Rear Axle Left | | 24.0711-5271.3 360301 |
| 2.0 TDI 4x4 | 110 - 03/15→ 147 | | | |
| 2.0 TSI 4x4 | 200 - 03/15→ 206 | Comfort Package: not for cruise control system; Fitting Position: Rear Axle Left | | 24.0711-5271.3 360301 |
| | | Vehicle Equipment: for vehicles without parking assistant system; Fitting Position: Rear Axle Right | | 24.0711-5272.3 360302 |
| | | Comfort Package: not for cruise control system; Fitting Position: Rear Axle Right | | 24.0711-5272.3 360302 |
| SKODA - SUPERB III Estate (3V5) 03/15→ | | | | |
|  Brake Pad Set, disc brake | | | | |
| 1.4 TSI | 92 - 03/15→ 110 | for PR number: 1ZA / 1ZK; Fitting Position: Front Axle | | 13.0470-2785.2 LD2785 Brake System: Lucas / TRW 25683 20,4 Wear Warning Contact: prepared for wear indicator / incl. wear warning contact Ceramic |
| 1.4 TSI 4x4 | 110 03/15→ | | | |
| 1.4 TSI IV | 115 - 08/19→ 160 | | | |
| 1.5 TSi | 110 02/17→ | | | |
| 1.6 TDI | 88 03/15→ | | | |
| 1.8 TSI | 132 03/15→ | | | |
| 2.0 TDI | 90 - 03/15→ 147 | | | |
| 2.0 TDI 4x4 | 110 - 03/15→ 147 | | | |
| 2.0 TSI | 140 - 03/15→ 162 | | | |
| 2.0 TSI 4x4 | 200 - 03/15→ 206 | | | |
| → | | | | |



| | kW | | | | |
|--|-------------------|--|---|------------------------------|---|
| SKODA - SUPERB III Estate (3V5) 03/15→ | | | | | |
|  Wheel Speed Sensor | | | | | |
| 1.4 TSI 4x4 | 110 03/15→ | | Vehicle Equipment: for vehicles without parking assistant system; | 24.0711-5271.3 360301 | |
| 2.0 TDI 4x4 | 110 - 03/15→ | | Fitting Position: Rear Axle Left | | |
| | 147 | | | | |
| 2.0 TSI 4x4 | 200 - 03/15→ | | Comfort Package: not for cruise control system; Fitting Position: Rear Axle Left | 24.0711-5271.3 360301 | |
| | 206 | | | | |
| | | | Vehicle Equipment: for vehicles without parking assistant system; | 24.0711-5272.3 360302 | |
| | | | Fitting Position: Rear Axle Right | | |
| | | | Comfort Package: not for cruise control system; Fitting Position: Rear Axle Right | 24.0711-5272.3 360302 | |
| SKODA - YETI (5L) 05/09→12/17 | | | | | |
|  Wheel Speed Sensor | | | | | |
| 1.2 TSI | 77 - 09/09→12/17 | | Fitting Position: Front Axle Left | 24.0711-5271.3 360301 | |
| | 81 | | | | |
| 1.4 TSI | 90 - 06/10→12/17 | | Fitting Position: Front Axle Right | 24.0711-5272.3 360302 | |
| | 92 | | | | |
| 1.6 | 81 04/14→12/17 | | | | |
| 1.6 TDI | 77 11/10→05/15 | | | | |
| 2.0 TDI | 81 - 11/09→12/17 | | | | |
| | 110 | | | | |
| 1.4 TSI 4x4 | 110 05/15→12/17 | | Fitting Position: Front Axle Left | 24.0711-5271.3 360301 | |
| 1.8 TSI 4x4 | 112 - 05/09→12/17 | | Fitting Position: Front Axle Right | 24.0711-5272.3 360302 | |
| | 118 | | | | |
| 2.0 TDI 4x4 | 81 - 05/09→12/17 | | for PR number: 1X1; | 24.0711-5271.3 360301 | |
| | 125 | | Fitting Position: Rear Axle Left | | |
| | | | for PR number: 1X1; | 24.0711-5272.3 360302 | |
| | | | Fitting Position: Rear Axle Right | | |
| TESLA - MODEL 3 (5YJ3) 01/17→ | | | | | |
| Accessory Kit, disc brake pad | | | | | |
| EV | 175 - 01/17→ | | Fitting Position: Front Axle | 13.0460-0529.2 610529 | |
| | 239 | | | | |
| EV AWD | 350 - 02/19→ | | | | |
| | 361 | | | | |
| TESLA - MODEL Y (5YJY) 03/19→ | | | | | |
| Accessory Kit, disc brake pad | | | | | |
| EV | 220 07/21→ | | Fitting Position: Front Axle | 13.0460-0529.2 610529 | |
| TOYOTA - COROLLA Saloon (_E16_) 05/12→ | | | | | |
|  Brake Hose | | | | | |
| 1.5 | 80 05/12→ | | Fitting Position: Front Axle Left | 24.5265-0499.3 331550 | Length [mm]: 498 Length 1 [mm]: 262 Length 2 [mm]: 215 |
| TOYOTA - PROACE Bus (MDZ_) 02/16→ | | | | | |
|  Brake Disc | | | | | |
| 1.5 D4d | 75 - 08/18→ | | Fitting Position: Rear Axle | 24.0112-0212.1 412212 | Outer diameter [mm]: 290 Brake Disc Thickness [mm] 12 Minimum thickness [mm] 10 Brake Disc Type: Solid Supplementary Article/Info 2: with bolts/screws |
| | 88 | | | | |
| 1.6 D4d | 70 - 02/16→ | | | | |
| | 85 | | | | |
| 2.0 D4d | 90 - 02/16→ | | | | |
| | 130 | | | | |
| 2.0 D4d 4x4 | 110 04/18→ | | | | |
| Electric | 100 01/21→ | | | | |
| TOYOTA - PROACE CITY Box Body/MPV 10/19→ | | | | | |
|  Brake Pad Set, disc brake | | | | | |
| 1.2 VVT-i 110 | 81 10/19→ | | Vehicle Equipment: for vehicles with electric parking brake; | 13.0460-3871.2 603871 | Brake System: Bosch 25839 17,8 Wear Warning Contact: not prepared for wear indicator / excl. wear warning contact Supplementary Article/Supplementary Info: with accessories |
| 1.2 VVT-i 130 | 96 10/19→ | | Fitting Position: Rear Axle | | |
| 1.5 D-4D 100 | 75 10/19→ | | | | |
| 1.5 D-4D 130 | 96 10/19→ | | | | |
| 1.5 D-4D 75 | 55 10/19→ | | | | |
| Electric | 100 07/21→ | | | 13.0470-3871.2 LD3871 | Brake System: Bosch 25839 17,8 Wear Warning Contact: not prepared for wear indicator / excl. wear warning contact Supplementary Article/Supplementary Info: with accessories Ceramic |





| | kW | | | | |
|--|--|--|--|---|--|
| TOYOTA - PROACE CITY VERSO MPV 10/19→ | | | | | |
|  Brake Pad Set, disc brake | | | | | |
| 1.2 VVT-i 110 1.2 VVT-i 130 1.5 D-4D 100 1.5 D-4D 130 Electric | 81 10/19→ 96 10/19→ 75 10/19→ 96 10/19→ 100 07/21→ | Vehicle Equipment: for vehicles with electric parking brake; Fitting Position: Rear Axle | 13.0460-3871.2 603871 13.0470-3871.2 LD3871 | Brake System: Bosch 25839 17,8 Wear Warning Contact: not prepared for wear indicator / excl. wear warning contact Supplementary Article/Supplementary Info: with accessories Brake System: Bosch 25839 17,8 Wear Warning Contact: not prepared for wear indicator / excl. wear warning contact Supplementary Article/Supplementary Info: with accessories Ceramic | |
| TOYOTA - PROACE Platform/Chassis (MDZ_) 02/16→ | | | | | |
|  Brake Disc | | | | | |
| 1.6 D4d 2.0 D4d | 70 02/16→ 90 - 02/16→ 110 | Fitting Position: Rear Axle | 24.0112-0212.1 412212 | Outer diameter [mm]: 290 Brake Disc Thickness [mm] 12 Minimum thickness [mm] 10 Brake Disc Type: Solid Supplementary Article/Info 2: with bolts/screws | |
| TOYOTA - PROACE Van (MDZ_) 02/16→ | | | | | |
|  Brake Disc | | | | | |
| 1.5 D4d 1.6 D4d 2.0 D4d 2.0 D4d 4x4 Electric | 75 - 05/19→ 88 70 - 02/16→ 85 90 - 02/16→ 130 110 04/18→ 100 09/20→ | Fitting Position: Rear Axle | 24.0112-0212.1 412212 | Outer diameter [mm]: 290 Brake Disc Thickness [mm] 12 Minimum thickness [mm] 10 Brake Disc Type: Solid Supplementary Article/Info 2: with bolts/screws | |
| 2.0 D4d | 106 08/21→ | Vehicle Equipment: for vehicles without electric parking brake; Fitting Position: Rear Axle | 24.0112-0212.1 412212 | Outer diameter [mm]: 290 Brake Disc Thickness [mm] 12 Minimum thickness [mm] 10 Brake Disc Type: Solid Supplementary Article/Info 2: with bolts/screws | |
| TOYOTA - PROACE VERSO Bus (MPY_) 02/16→ | | | | | |
|  Brake Disc | | | | | |
| 1.5 D4d 1.6 D4d 2.0 D4d 2.0 D4d 4x4 Electric | 75 - 06/18→ 88 70 - 02/16→ 85 90 - 02/16→ 130 110 04/18→ 100 01/21→ | Fitting Position: Rear Axle | 24.0112-0212.1 412212 | Outer diameter [mm]: 290 Brake Disc Thickness [mm] 12 Minimum thickness [mm] 10 Brake Disc Type: Solid Supplementary Article/Info 2: with bolts/screws | |
| TOYOTA - URBAN CRUISER (_P1_) 07/07→03/16 | | | | | |
|  Brake Hose | | | | | |
| 1.33 | 73 01/09→03/16 | Construction year from: 04/10 →; Fitting Position: Front Axle Left | 24.5265-0499.3 331550 | Length [mm]: 498 Length 1 [mm]: 262 Length 2 [mm]: 215 | |
| TOYOTA - VERSO S (_P12_) 11/10→10/16 | | | | | |
|  Brake Hose | | | | | |
| 1.33 | 70 11/10→10/16 | Construction year from: 12/11 →; Fitting Position: Front Axle Left | 24.5265-0499.3 331550 | Length [mm]: 498 Length 1 [mm]: 262 Length 2 [mm]: 215 | |
| TOYOTA - YARIS / VIOS Saloon (_P9_) 08/05→12/13 | | | | | |
|  Brake Hose | | | | | |
| 1.0 1.3 1.3 4WD | 52 09/05→10/13 63 - 09/05→10/13 64 64 09/05→04/13 | Construction year from: 12/11 → → Construction year to: 12/12; Fitting Position: Front Axle Left | 24.5265-0499.3 331550 | Length [mm]: 498 Length 1 [mm]: 262 Length 2 [mm]: 215 | |







| | kW | | | | |
|---|-------------------|--|-------------------------|--|--|
| TOYOTA - YARIS (_P13_) 12/10→ | | | | | |
|  Brake Hose | | | | | |
| 1.0 | 51 12/10→ | Vehicle Production Country: Japan; Fitting Position: Front Axle Left | 24.5265-0499.3 331550 | Length [mm]: 498 Length 1 [mm]: 262 Length 2 [mm]: 215 | |
| 1.3 | 63 - 12/10→ | | | | |
| 1.3 4WD | 70 12/10→ | | | | |
| 1.5 | 80 12/10→ | | | | |
| TOYOTA - YARIS Hatchback Van (_P13_) 10/12→ | | | | | |
|  Brake Hose | | | | | |
| 1.0 VVTi | 51 07/14→ | Vehicle Production Country: Japan; Fitting Position: Front Axle Left | 24.5265-0499.3 331550 | Length [mm]: 498 Length 1 [mm]: 262 Length 2 [mm]: 215 | |
| 1.3 VVTi | 73 10/12→ | | | | |
| VAUXHALL - ADAM (M13) 10/12→04/19 | | | | | |
|  Brake Hose | | | | | |
| 1.0 | 85 07/14→11/18 | Required quantity: 2; Fitting Position: Front Axle | 2 24.5103-0405.3 331647 | Length [mm]: 425 | |
| 1.2 | 51 10/12→04/19 | | | | |
| 1.4 | 64 - 10/12→02/19 | | | | |
| | 74 | | | | |
| 1.4 S | 110 11/14→01/19 | | | | |
| VAUXHALL - ASTRA Mk VI (J) (P10) 12/09→10/15 | | | | | |
|  Brake Hose | | | | | |
| 1.3 CDTi | 70 12/09→10/15 | Vehicle Identification Number from: A8068772 →; Number of Doors: 5; Fitting Position: Front Axle Right | 24.5176-0401.3 331649 | Length [mm]: 410 | |
| 1.4 | 64 - 12/09→10/15 | | | | |
| 1.4 Turbo | 88 - 12/09→10/15 | Vehicle Identification Number from: A8068772 →; Number of Doors: 5; Fitting Position: Front Axle Left | 24.5176-0402.3 331633 | Length [mm]: 410 | |
| | 103 | | | | |
| 1.6 | 85 12/09→10/15 | | | | |
| 1.6 Turbo | 132 12/09→10/15 | | | | |
| 1.7 CDTi | 81 - 12/09→10/15 | | | | |
| | 96 | | | | |
| 1.7 CDTi | 74 10/10→10/15 | | | | |
| 2.0 BiTurbo CDTi | 143 12/12→10/15 | | | | |
| 2.0 CDTi | 118 - 12/09→10/15 | | | | |
| | 121 | | | | |
| 1.6 CDTi | 81 11/13→10/15 | Construction year from: 02/14 →; Number of Doors: 5; Fitting Position: Front Axle Right | 24.5176-0401.3 331649 | Length [mm]: 410 | |
| | | Construction year from: 02/14 →; Number of Doors: 5; Fitting Position: Front Axle Left | 24.5176-0402.3 331633 | Length [mm]: 410 | |
| 1.6 CDTi | 100 11/13→10/15 | Construction year from: 01/14 →; Number of Doors: 5; Fitting Position: Front Axle Right | 24.5176-0401.3 331649 | Length [mm]: 410 | |
| | | Construction year from: 01/14 →; Number of Doors: 5; Fitting Position: Front Axle Left | 24.5176-0402.3 331633 | Length [mm]: 410 | |
| VAUXHALL - ASTRA Mk VI (J) Estate (P10) 10/10→10/15 | | | | | |
|  Brake Hose | | | | | |
| 1.3 CDTi | 70 10/10→10/15 | Vehicle Identification Number from: A8068772 →; Fitting Position: Front Axle Right | 24.5176-0401.3 331649 | Length [mm]: 410 | |
| 1.4 | 64 - 10/10→10/15 | | | | |
| 1.4 Turbo | 103 10/10→10/15 | Vehicle Identification Number from: A8068772 →; Fitting Position: Front Axle Left | 24.5176-0402.3 331633 | Length [mm]: 410 | |
| 1.6 | 85 10/10→10/15 | | | | |
| 1.6 Turbo | 132 10/10→10/15 | | | | |
| 1.7 CDTi | 81 - 10/10→10/15 | | | | |
| | 96 | | | | |
| 2.0 BiTurbo CDTi | 143 12/12→10/15 | | | | |
| 2.0 CDTi | 118 - 10/10→10/15 | | | | |
| | 121 | | | | |
| 1.6 CDTi | 81 01/14→10/15 | Construction year from: 02/14 →; Fitting Position: Front Axle Right | 24.5176-0401.3 331649 | Length [mm]: 410 | |
| | | Construction year from: 02/14 →; Fitting Position: Front Axle Left | 24.5176-0402.3 331633 | Length [mm]: 410 | |
| 1.6 CDTi | 100 01/14→10/15 | Fitting Position: Front Axle Right | 24.5176-0401.3 331649 | Length [mm]: 410 | |
| | | Fitting Position: Front Axle Left | 24.5176-0402.3 331633 | Length [mm]: 410 | |
| VAUXHALL - ASTRA Mk VI (J) GTC (P10) 10/11→10/15 | | | | | |
|  Brake Hose | | | | | |
| 1.4 | 74 - 10/11→10/15 | Vehicle Identification Number from: A8068772 →; Number of Doors: 5; Fitting Position: Front Axle Right | 24.5176-0401.3 331649 | Length [mm]: 410 | |
| | 103 | | | | |
| 1.6 | 132 10/11→10/15 | | | | |
| 1.7 CDTi | 81 - 10/11→10/15 | | | | |
| | 96 | | | | |
| → | | | | | |



| | kW | | | | |
|--|---|--|--|------------------------------|---|
| VAUXHALL - ASTRA Mk VI (J) GTC (P10) 10/11→10/15 | | | | | |
|  Brake Hose | | | | | |
| 2.0 BiTurbo CDTI 2.0 CDTI | 143 12/12→10/15 121 10/11→10/15 | Vehicle Identification Number from: A8068772 →; Number of Doors: 5; Fitting Position: Front Axle Left | | 24.5176-0402.3 331633 | Length [mm]: 410 |
| 1.6 CDTI | 81 - 07/14→10/15 100 | Number of Doors: 5; Fitting Position: Front Axle Right | | 24.5176-0401.3 331649 | Length [mm]: 410 |
| | | Number of Doors: 5; Fitting Position: Front Axle Left | | 24.5176-0402.3 331633 | Length [mm]: 410 |
| VAUXHALL - ASTRA Mk VI (J) Saloon (P10) 06/12→10/15 | | | | | |
|  Brake Hose | | | | | |
| 1.3 CDTI 1.4 1.4 Turbo | 70 06/12→10/15 74 06/12→10/15 103 06/12→10/15 | Vehicle Identification Number from: A8068772 →; Number of Doors: 5; Fitting Position: Front Axle Right | | 24.5176-0401.3 331649 | Length [mm]: 410 |
| 1.6 1.6 Turbo 1.7 CDTI | 85 06/12→10/15 132 06/12→10/15 81 - 06/12→10/15 96 | Vehicle Identification Number from: A8068772 →; Number of Doors: 5; Fitting Position: Front Axle Left | | 24.5176-0402.3 331633 | Length [mm]: 410 |
| VAUXHALL - ASTRA Mk VIII (L) 10/21→ | | | | | |
|  Brake Pad Set, disc brake | | | | | |
| 1.2 1.5 Turbo D 1.6 Plug-In-Hybrid | 81 - 10/21→ 96 96 10/21→ 110 - 10/21→ 133 | for brake disc diameter [mm]: 283; Fitting Position: Front Axle | | 13.0460-3870.2 603870 | Brake System: Bosch 25895 18,5 Wear Warning Contact: not prepared for wear indicator / excl. wear warning contact Supplementary Article/Supplementary Info: with accessories |
| | | | | 13.0470-3870.2 LD3870 | Brake System: Bosch 25895 18,5 Wear Warning Contact: not prepared for wear indicator / excl. wear warning contact Supplementary Article/Supplementary Info: with accessories Ceramic |
| | | for brake disc diameter [mm]: 330; Fitting Position: Front Axle | | 13.0460-3876.2 603876 | Brake System: Bosch 22218 18,3 Wear Warning Contact: prepared for wear indicator / excl. wear warning contact Supplementary Article/Supplementary Info: with accessories |
| | | for brake disc diameter [mm]: 268; Fitting Position: Rear Axle | | 13.0460-3871.2 603871 | Brake System: Bosch 25839 17,8 Wear Warning Contact: not prepared for wear indicator / excl. wear warning contact Supplementary Article/Supplementary Info: with accessories |
| | | | | 13.0470-3871.2 LD3871 | Brake System: Bosch 25839 17,8 Wear Warning Contact: not prepared for wear indicator / excl. wear warning contact Supplementary Article/Supplementary Info: with accessories Ceramic |
| | | for brake disc diameter [mm]: 290; Fitting Position: Rear Axle | | 13.0460-3872.2 603872 | Brake System: Bosch 25827 17,7 Wear Warning Contact: not prepared for wear indicator / excl. wear warning contact Supplementary Article/Supplementary Info: with accessories |
| | | | | 13.0470-3872.2 LD3872 | Brake System: Bosch 25827 17,7 Wear Warning Contact: not prepared for wear indicator / excl. wear warning contact Supplementary Article/Supplementary Info: with accessories Ceramic |
|  Brake Disc | | | | | |
| 1.2 1.5 Turbo D 1.6 Plug-In-Hybrid | 81 - 10/21→ 96 96 10/21→ 110 - 10/21→ 133 | Fitting Position: Front Axle | | 24.0126-0183.1 426183 | Outer diameter [mm]: 283 Brake Disc Thickness [mm] 26 Minimum thickness [mm] 24 Brake Disc Type: Vented Supplementary Article/Info 2: with bolts/screws |
| → | | | | | |





| | kW | | | |
|--|---|--|--|---|
| VAUXHALL - ASTRA Mk VIII (L) 10/21→ | | | | |
|  Brake Disc | | | | |
| 1.2 1.5 Turbo D 1.6 Plug-In-Hybrid | 81 - 10/21→ 96 96 10/21→ 110 - 10/21→ 133 | Fitting Position: Front Axle | | 24.0128-0269.1 428269 Outer diameter [mm]: 304 Brake Disc Thickness [mm] 28 Minimum thickness [mm] 26 Brake Disc Type: Vented Supplementary Article/Info 2: with bolts/screws 24.0130-0241.1 430241 Outer diameter [mm]: 330 Brake Disc Thickness [mm] 30 Minimum thickness [mm] 28 Brake Disc Type: Vented Supplementary Article/Info 2: with bolts/screws |
| | | Fitting Position: Rear Axle | | 24.0112-0211.1 412211 Outer diameter [mm]: 268 Brake Disc Thickness [mm] 12 Minimum thickness [mm] 10 Brake Disc Type: Solid Supplementary Article/Info 2: with bolts/screws 24.0112-0212.1 412212 Outer diameter [mm]: 290 Brake Disc Thickness [mm] 12 Minimum thickness [mm] 10 Brake Disc Type: Solid Supplementary Article/Info 2: with bolts/screws |
| VAUXHALL - ASTRA Mk VIII (L) Sports Tourer 10/21→ | | | | |
|  Brake Pad Set, disc brake | | | | |
| 1.2 1.5 Turbo D 1.6 Plug-In-Hybrid | 81 - 10/21→ 96 96 10/21→ 110 - 10/21→ 133 | for brake disc diameter [mm]: 283; Fitting Position: Front Axle | | 13.0460-3870.2 603870 Brake System: Bosch 25895 18,5 Wear Warning Contact: not prepared for wear indicator / excl. wear warning contact Supplementary Article/Supplementary Info: with accessories 13.0470-3870.2 LD3870 Brake System: Bosch 25895 18,5 Wear Warning Contact: not prepared for wear indicator / excl. wear warning contact Supplementary Article/Supplementary Info: with accessories Ceramic |
| | | for brake disc diameter [mm]: 330; Fitting Position: Front Axle | | 13.0460-3876.2 603876 Brake System: Bosch 22218 18,3 Wear Warning Contact: prepared for wear indicator / excl. wear warning contact Supplementary Article/Supplementary Info: with accessories |
| | | for brake disc diameter [mm]: 268; Fitting Position: Rear Axle | | 13.0460-3871.2 603871 Brake System: Bosch 25839 17,8 Wear Warning Contact: not prepared for wear indicator / excl. wear warning contact Supplementary Article/Supplementary Info: with accessories 13.0470-3871.2 LD3871 Brake System: Bosch 25839 17,8 Wear Warning Contact: not prepared for wear indicator / excl. wear warning contact Supplementary Article/Supplementary Info: with accessories Ceramic |
| | | for brake disc diameter [mm]: 290; Fitting Position: Rear Axle | | 13.0460-3872.2 603872 Brake System: Bosch 25827 17,7 Wear Warning Contact: not prepared for wear indicator / excl. wear warning contact Supplementary Article/Supplementary Info: with accessories 13.0470-3872.2 LD3872 Brake System: Bosch 25827 17,7 Wear Warning Contact: not prepared for wear indicator / excl. wear warning contact Supplementary Article/Supplementary Info: with accessories Ceramic |
| → | | | | |





| | | kW | | | | | |
|--|---------------------|---|--|------------------------------|---|--|--|
| VAUXHALL - ASTRA Mk VIII (L) Sports Tourer 10/21→ | | | | | | | |
|  Brake Disc | | | | | | | |
| 1.2 | 81 - 10/21→ | Fitting Position: Front Axle | | 24.0126-0183.1 426183 | Outer diameter [mm]: 283 Brake Disc Thickness [mm] 26 Minimum thickness [mm] 24 Brake Disc Type: Vented Supplementary Article/Info 2: with bolts/screws | | |
| 1.5 Turbo D | 96 10/21→ | | | | | | |
| 1.6 Plug-In-Hybrid | 110 - 10/21→ 133 | | | | | | |
| | | Fitting Position: Rear Axle | | 24.0112-0211.1 412211 | Outer diameter [mm]: 268 Brake Disc Thickness [mm] 12 Minimum thickness [mm] 10 Brake Disc Type: Solid Supplementary Article/Info 2: with bolts/screws | | |
| | | | | 24.0112-0212.1 412212 | Outer diameter [mm]: 290 Brake Disc Thickness [mm] 12 Minimum thickness [mm] 10 Brake Disc Type: Solid Supplementary Article/Info 2: with bolts/screws | | |
| VAUXHALL - COMBO Mk IV (E) Box Body/MPV (K9) 06/18→ | | | | | | | |
| Spring, brake caliper | | | | | | | |
| 1.2 | 81 02/19→ | for brake disc diameter [mm]: 283; Fitting Position: Front Axle | | 11.8116-0237.1 390509 | Brake System: ATE | | |
| 1.5 D | 56 - 08/18→ 96 | | | | | | |
| 1.5 D 4x4 | 96 08/18→ | | | | | | |
| 1.6 D | 55 - 06/18→ 73 | | | | | | |
| Combo-e | 100 07/21→ | | | | | | |
|  Brake Pad Set, disc brake | | | | | | | |
| 1.2 | 81 02/19→ | for brake disc diameter [mm]: 283; Fitting Position: Front Axle | | 13.0460-3870.2 603870 | Brake System: Bosch 25895 18,5 Wear Warning Contact: not prepared for wear indicator / excl. wear warning contact Supplementary Article/Supplementary Info: with accessories | | |
| 1.5 D | 56 - 08/18→ 96 | | | | | | |
| 1.5 D 4x4 | 96 08/18→ | | | | | | |
| 1.6 D | 55 - 06/18→ 73 | | | | | | |
| Combo-e | 100 07/21→ | | | | | | |
| | | Vehicle Equipment: for vehicles with electric parking brake; Fitting Position: Rear Axle | | 13.0460-3871.2 603871 | Brake System: Bosch 25839 17,8 Wear Warning Contact: not prepared for wear indicator / excl. wear warning contact Supplementary Article/Supplementary Info: with accessories | | |
| | | | | 13.0470-3871.2 LD3870 | Brake System: Bosch 25895 18,5 Wear Warning Contact: not prepared for wear indicator / excl. wear warning contact Supplementary Article/Supplementary Info: with accessories Ceramic | | |
| | | | | 13.0470-3871.2 LD3871 | Brake System: Bosch 25839 17,8 Wear Warning Contact: not prepared for wear indicator / excl. wear warning contact Supplementary Article/Supplementary Info: with accessories Ceramic | | |
|  Brake Disc | | | | | | | |
| 1.2 | 81 02/19→ | Brake System: Bosch; Fitting Position: Front Axle | | 24.0126-0183.1 426183 | Outer diameter [mm]: 283 Brake Disc Thickness [mm] 26 Minimum thickness [mm] 24 Brake Disc Type: Vented Supplementary Article/Info 2: with bolts/screws | | |
| 1.5 D | 56 - 08/18→ 96 | | | | | | |
| 1.5 D 4x4 | 96 08/18→ | | | | | | |
| 1.6 D | 55 - 06/18→ 73 | | | | | | |
| Combo-e | 100 07/21→ | | | | | | |
| → | | | | | | | |



| | kW | | | | |
|--|-------------------|--|---|--------------------------------|---|
| VAUXHALL - COMBO Mk IV (E) Box Body/MPV (K9) 06/18→ | | | | | |
|  Brake Disc | | | | | |
| 1.2 | 81 02/19→ | | Fitting Position: Front Axle | 24.0128-0269.1 428269 | Outer diameter [mm]: 304 Brake Disc Thickness [mm] 28 Minimum thickness [mm] 26 Brake Disc Type: Vented Supplementary Article/Info 2: with bolts/screws |
| 1.5 D | 56 - 08/18→ 96 | | | | |
| 1.5 D 4x4 | 96 08/18→ | | | | |
| 1.6 D | 55 - 06/18→ 73 | | | | |
| Combo-e | 100 07/21→ | | | | |
| | | | Fitting Position: Rear Axle | 24.0112-0211.1 412211 | Outer diameter [mm]: 268 Brake Disc Thickness [mm] 12 Minimum thickness [mm] 10 Brake Disc Type: Solid Supplementary Article/Info 2: with bolts/screws |
| | | | | | |
| VAUXHALL - COMBO Mk IV (E) Life (K9) 06/18→ | | | | | |
| Spring, brake caliper | | | | | |
| 1.2 | 81 - 06/18→ 96 | | for brake disc diameter [mm]: 283; Fitting Position: Front Axle | 11.8116-0237.1 390509 | Brake System: ATE |
| 1.5 | 75 - 06/18→ 96 | | | | |
| Combo-e | 100 06/21→ | | | | |
|  Brake Pad Set, disc brake | | | | | |
| 1.2 | 81 - 06/18→ 96 | | for brake disc diameter [mm]: 283; Fitting Position: Front Axle | 13.0460-3870.2 603870 | Brake System: Bosch 25895 18,5 Wear Warning Contact: not prepared for wear indicator / excl. wear warning contact Supplementary Article/Supplementary Info: with accessories |
| 1.5 | 75 - 06/18→ 96 | | | | |
| Combo-e | 100 06/21→ | | | 13.0470-3870.2 LD3870 | Brake System: Bosch 25895 18,5 Wear Warning Contact: not prepared for wear indicator / excl. wear warning contact Supplementary Article/Supplementary Info: with accessories Ceramic |
| | | | Vehicle Equipment: for vehicles with electric parking brake; Fitting Position: Rear Axle | | |
| | | | | 13.0460-3871.2 603871 | Brake System: Bosch 25839 17,8 Wear Warning Contact: not prepared for wear indicator / excl. wear warning contact Supplementary Article/Supplementary Info: with accessories |
| | | | | | |
| | | | | 13.0470-3871.2 LD3871 | Brake System: Bosch 25839 17,8 Wear Warning Contact: not prepared for wear indicator / excl. wear warning contact Supplementary Article/Supplementary Info: with accessories Ceramic |
| | | | | | |
|  Brake Disc | | | | | |
| 1.2 | 81 - 06/18→ 96 | | Brake System: Bosch; Fitting Position: Front Axle | 24.0126-0183.1 426183 | Outer diameter [mm]: 283 Brake Disc Thickness [mm] 26 Minimum thickness [mm] 24 Brake Disc Type: Vented Supplementary Article/Info 2: with bolts/screws |
| 1.5 | 75 - 06/18→ 96 | | | | |
| Combo-e | 100 06/21→ | | | | |
| | | | Fitting Position: Front Axle | 24.0128-0269.1 428269 | Outer diameter [mm]: 304 Brake Disc Thickness [mm] 28 Minimum thickness [mm] 26 Brake Disc Type: Vented Supplementary Article/Info 2: with bolts/screws |
| | | | | | |
| | | | Fitting Position: Rear Axle | 24.0112-0211.1 412211 | Outer diameter [mm]: 268 Brake Disc Thickness [mm] 12 Minimum thickness [mm] 10 Brake Disc Type: Solid Supplementary Article/Info 2: with bolts/screws |
| | | | | | |
| VAUXHALL - CORSA Mk III (D) (S07) 07/06→08/14 | | | | | |
|  Brake Hose | | | | | |
| 1.4 | 88 08/12→08/14 | | Required quantity: 2; Fitting Position: Front Axle | 2 24.5176-0425.3 331644 | Length [mm]: 425 |



| | kW | | | | |
|--|--------------------|---|---|------------------------------|---|
| VAUXHALL - CORSA Mk IV (E) (X15) 08/14→ | | | | | |
|  Brake Hose | | | | | |
| 1.0 | 66 - 08/14→ 85 | Required quantity: 2; for brake disc diameter [mm]: 284; Fitting Position: Front Axle | 2 | 24.5103-0405.3 331647 | Length [mm]: 425 |
| 1.2 | 51 08/14→ | Required quantity: 2; for brake disc diameter [mm]: 330; Fitting Position: Front Axle | 2 | 24.5112-0463.3 331643 | Length [mm]: 485 |
| 1.3 CDTi | 55 - 08/14→ 70 | | | | |
| 1.4 | 55 - 08/14→ 110 | Required quantity: 2; Fitting Position: Front Axle | 2 | 24.5176-0425.3 331644 | Length [mm]: 425 |
| 1.6 VXR | 151 04/15→ | Required quantity: 2; for brake disc diameter [mm]: 330; Fitting Position: Front Axle | 2 | 24.5112-0463.3 331643 | Length [mm]: 485 |
| VAUXHALL - CORSA Mk V (F) 07/19→ | | | | | |
|  Brake Pad Set, disc brake | | | | | |
| CORSA-e | 100 07/19→ | Fitting Position: Rear Axle | | 13.0460-3871.2 603871 | Brake System: Bosch 25839 17,8 Wear Warning Contact: not prepared for wear indicator / excl. wear warning contact Supplementary Article/Supplementary Info: with accessories |
| | | | | 13.0470-3871.2 LD3871 | Brake System: Bosch 25839 17,8 Wear Warning Contact: not prepared for wear indicator / excl. wear warning contact Supplementary Article/Supplementary Info: with accessories Ceramic |
|  Brake Disc | | | | | |
| 1.2 | 55 - 07/19→ 96 | Fitting Position: Front Axle | | 24.0122-0194.1 422194 | Outer diameter [mm]: 266 Brake Disc Thickness [mm] 22 Minimum thickness [mm] 20 Brake Disc Type: Vented Supplementary Article/Info 2: with bolts/screws |
| 1.5 | 75 07/19→ | Fitting Position: Front Axle | | | |
| CORSA-e | 100 07/19→ | | | | |
| VAUXHALL - CORSAVAN Mk IV (E) Hatchback Van (X15) 10/14→ | | | | | |
|  Brake Hose | | | | | |
| 1.2 | 51 10/14→ | Required quantity: 2; for brake disc diameter [mm]: 284; Fitting Position: Front Axle | 2 | 24.5103-0405.3 331647 | Length [mm]: 425 |
| 1.3 CDTi | 55 - 10/14→ 70 | Required quantity: 2; for brake disc diameter [mm]: 330; Fitting Position: Front Axle | 2 | 24.5112-0463.3 331643 | Length [mm]: 485 |
| | | | | | |
| | | for brake disc diameter [mm]: 308; Required quantity: 2; Fitting Position: Front Axle | 2 | 24.5176-0425.3 331644 | Length [mm]: 425 |
| VAUXHALL - CROSSLAND X / CROSSLAND (P17) 03/17→ | | | | | |
|  Brake Disc | | | | | |
| 1.2 | 61 - 03/17→ 96 | Brake Size: 14"; Fitting Position: Front Axle | | 24.0122-0194.1 422194 | Outer diameter [mm]: 266 Brake Disc Thickness [mm] 22 Minimum thickness [mm] 20 Brake Disc Type: Vented Supplementary Article/Info 2: with bolts/screws |
| 1.5 Turbo D)) | 81 10/20→ | Fitting Position: Front Axle | | | |
| 1.5 Turbo D | 75 - 06/18→ 88 | | | | |
| 1.6 Turbo D | 73 - 03/17→ 88 | | | | |
| VAUXHALL - GRANDLAND X / GRANDLAND (A18) 06/17→ | | | | | |
|  Brake Pad Set, disc brake | | | | | |
| 1.2 Turbo | 96 06/17→ | for brake disc diameter [mm]: 330; Fitting Position: Front Axle | | 13.0460-3876.2 603876 | Brake System: Bosch 22218 18,3 Wear Warning Contact: prepared for wear indicator / excl. wear warning contact Supplementary Article/Supplementary Info: with accessories |
| 1.5 Turbo D | 96 04/18→ | for brake disc diameter [mm]: 268; for POC: 1F*; Fitting Position: Rear Axle | | 13.0460-3871.2 603871 | Brake System: Bosch 25839 17,8 Wear Warning Contact: not prepared for wear indicator / excl. wear warning contact Supplementary Article/Supplementary Info: with accessories |
| 1.6 Turbo D | 88 06/17→ | | | | |
| 2.0 D | 130 10/17→ | | | | |
| → | | | | | |





| | | kW | | | | | |
|--|---|---|------------------------------|---|--|--|--|
| VAUXHALL - GRANDLAND X / GRANDLAND (A18) 06/17→ | | | | | | | |
|  Brake Pad Set, disc brake | | | | | | | |
| 1.2 Turbo 1.5 Turbo D 1.6 Turbo D 2.0 D | 96 06/17→ 96 04/18→ 88 06/17→ 130 10/17→ | for brake disc diameter [mm]: 268; for POC: 1F*; Fitting Position: Rear Axle | 13.0470-3871.2 LD3871 | Brake System: Bosch 25839 17,8 Wear Warning Contact: not prepared for wear indicator / excl. wear warning contact Supplementary Article/Supplementary Info: with accessories Ceramic | | | |
| | | for brake disc diameter [mm]: 290; for POC: 1G*; Fitting Position: Rear Axle | 13.0460-3872.2 603872 | Brake System: Bosch 25827 17,7 Wear Warning Contact: not prepared for wear indicator / excl. wear warning contact Supplementary Article/Supplementary Info: with accessories | | | |
| | | | 13.0470-3872.2 LD3872 | Brake System: Bosch 25827 17,7 Wear Warning Contact: not prepared for wear indicator / excl. wear warning contact Supplementary Article/Supplementary Info: with accessories Ceramic | | | |
| 1.6 Turbo Hybrid 1.6 Turbo Hybrid4 | 133 - 12/19→ 165 147 - 06/19→ 221 | for brake disc diameter [mm]: 330; Fitting Position: Front Axle | 13.0460-3876.2 603876 | Brake System: Bosch 22218 18,3 Wear Warning Contact: prepared for wear indicator / excl. wear warning contact Supplementary Article/Supplementary Info: with accessories | | | |
| | | for brake disc diameter [mm]: 268; Fitting Position: Rear Axle | 13.0460-3871.2 603871 | Brake System: Bosch 25839 17,8 Wear Warning Contact: not prepared for wear indicator / excl. wear warning contact Supplementary Article/Supplementary Info: with accessories | | | |
| | | | 13.0470-3871.2 LD3871 | Brake System: Bosch 25839 17,8 Wear Warning Contact: not prepared for wear indicator / excl. wear warning contact Supplementary Article/Supplementary Info: with accessories Ceramic | | | |
| | | for brake disc diameter [mm]: 290; Fitting Position: Rear Axle | 13.0460-3872.2 603872 | Brake System: Bosch 25827 17,7 Wear Warning Contact: not prepared for wear indicator / excl. wear warning contact Supplementary Article/Supplementary Info: with accessories | | | |
| | | | 13.0470-3872.2 LD3872 | Brake System: Bosch 25827 17,7 Wear Warning Contact: not prepared for wear indicator / excl. wear warning contact Supplementary Article/Supplementary Info: with accessories Ceramic | | | |
|  Brake Disc | | | | | | | |
| 1.2 Turbo 1.5 Turbo D 1.6 Turbo D 2.0 D | 96 06/17→ 96 04/18→ 88 06/17→ 130 10/17→ | Fitting Position: Front Axle | 24.0128-0269.1 428269 | Outer diameter [mm]: 304 Brake Disc Thickness [mm] 28 Minimum thickness [mm] 26 Brake Disc Type: Vented Supplementary Article/Info 2: with bolts/screws | | | |
| | | | 24.0130-0241.1 430241 | Outer diameter [mm]: 330 Brake Disc Thickness [mm] 30 Minimum thickness [mm] 28 Brake Disc Type: Vented Supplementary Article/Info 2: with bolts/screws | | | |
| | | for POC: 1F*; Fitting Position: Rear Axle | 24.0112-0211.1 412211 | Outer diameter [mm]: 268 Brake Disc Thickness [mm] 12 Minimum thickness [mm] 10 Brake Disc Type: Solid Supplementary Article/Info 2: with bolts/screws | | | |
| | | for POC: 1G*; Fitting Position: Rear Axle | 24.0112-0212.1 412212 | Outer diameter [mm]: 290 Brake Disc Thickness [mm] 12 Minimum thickness [mm] 10 Brake Disc Type: Solid Supplementary Article/Info 2: with bolts/screws | | | |
| → | | | | | | | |



| | kW | | | | |
|--|---------------------|--|--|-------------------------|---|
| VAUXHALL - GRANDLAND X / GRANDLAND (A18) 06/17→ | | | | | |
|  Brake Disc | | | | | |
| 1.6 Turbo Hybrid | 133 - 12/19→ 165 | Fitting Position: Front Axle | | 24.0128-0269.1 428269 | Outer diameter [mm]: 304 Brake Disc Thickness [mm] 28 Minimum thickness [mm] 26 Brake Disc Type: Vented Supplementary Article/Info 2: with bolts/screws |
| 1.6 Turbo Hybrid4 | 147 - 06/19→ 221 | | | | |
| | | Fitting Position: Rear Axle | | 24.0130-0241.1 430241 | Outer diameter [mm]: 330 Brake Disc Thickness [mm] 30 Minimum thickness [mm] 28 Brake Disc Type: Vented Supplementary Article/Info 2: with bolts/screws |
| | | | | | |
| | | | | 24.0112-0211.1 412211 | Outer diameter [mm]: 268 Brake Disc Thickness [mm] 12 Minimum thickness [mm] 10 Brake Disc Type: Solid Supplementary Article/Info 2: with bolts/screws |
| | | | | 24.0112-0212.1 412212 | Outer diameter [mm]: 290 Brake Disc Thickness [mm] 12 Minimum thickness [mm] 10 Brake Disc Type: Solid Supplementary Article/Info 2: with bolts/screws |
| VAUXHALL - MOKKA 06/20→ | | | | | |
|  Brake Pad Set, disc brake | | | | | |
| MOKKA-e | 100 06/20→ | Vehicle Equipment: for vehicles with electric parking brake; Fitting Position: Rear Axle | | 13.0460-3871.2 603871 | Brake System: Bosch 25839 17,8 Wear Warning Contact: not prepared for wear indicator / excl. wear warning contact Supplementary Article/Supplementary Info: with accessories |
| | | | | 13.0470-3871.2 LD3871 | Brake System: Bosch 25839 17,8 Wear Warning Contact: not prepared for wear indicator / excl. wear warning contact Supplementary Article/Supplementary Info: with accessories Ceramic |
| VAUXHALL - MOKKA / MOKKA X (J13) 06/12→ | | | | | |
|  Cable Pull, parking brake | | | | | |
| 1.4 | 103 04/13→ | Construction year from: 12/13 →; Required quantity: 1; Brake Type: Disc Brake; Fitting Position: Rear | | 1 24.3727-3502.2 583502 | Length [mm]: 1,885 Length 2 [mm]: 1,918 |
| 1.4 4x4 | 103 06/12→ | | | | |
| 1.6 | 85 06/12→ | | | | |
| 1.7 CDTi | 96 06/12→ | | | | |
| 1.7 CDTi 4x4 | 96 06/12→ | | | | |
| 1.4 4x4 | 112 06/16→ | Required quantity: 1; Brake Type: Disc Brake; Fitting Position: Rear | | 1 24.3727-3502.2 583502 | Length [mm]: 1,885 Length 2 [mm]: 1,918 |
| 1.6 CDTi | 100 01/15→ | | | | |
| 1.6 CDTi | 81 06/15→ | | | | |
| 1.6 CDTi 4x4 | 100 01/15→ | | | | |
| VAUXHALL - VIVARO C Platform Cabin (K0) 03/19→ | | | | | |
|  Brake Disc | | | | | |
| 2.0 | 90 03/19→ | Vehicle Equipment: for vehicles without electric parking brake; Fitting Position: Rear Axle | | 24.0112-0212.1 412212 | Outer diameter [mm]: 290 Brake Disc Thickness [mm] 12 Minimum thickness [mm] 10 Brake Disc Type: Solid Supplementary Article/Info 2: with bolts/screws |
| VAUXHALL - VIVARO C Van (K0) 03/19→ | | | | | |
|  Brake Disc | | | | | |
| 1.5 | 75 - 03/19→ 88 | Vehicle Equipment: for vehicles without electric parking brake; Fitting Position: Rear Axle | | 24.0112-0212.1 412212 | Outer diameter [mm]: 290 Brake Disc Thickness [mm] 12 Minimum thickness [mm] 10 Brake Disc Type: Solid Supplementary Article/Info 2: with bolts/screws |
| 1.5 4x4 | 88 03/19→ | | | | |
| 2.0 | 90 - 03/19→ 130 | | | | |
| 2.0 4x4 | 110 03/19→ | | | | |
| VIVARO-E | 100 09/20→ | | | | |





| | | | | | | | | | |
|---|---------------------|---|--------------------------------|--|--|--|--------------------------------|--|--|
| | kW | | | | | | | | |
| VAUXHALL - VIVARO LIFE Bus (K0) 03/19→ | | | | | | | | | |
|  Brake Disc | | | | | | | | | |
| 1.5 | 75 03/19→ 88 | Vehicle Equipment: for vehicles without electric parking brake; Fitting Position: Rear Axle | 24.0112-0212.1 412212 | Outer diameter [mm]: 290 Brake Disc Thickness [mm] 12 Minimum thickness [mm] 10 Brake Disc Type: Solid Supplementary Article/Info 2: with bolts/screws | | | | | |
| 2.0 | 106 03/19→ 130 | | | | | | | | |
| 2.0 4x4 | 110 03/19→ | | | | | | | | |
| E LIFE | 100 09/20→ | | | | | | | | |
| VOLVO - S60 III (224) 02/19→ | | | | | | | | | |
|  Wheel Speed Sensor | | | | | | | | | |
| B3 MHEV | 120 03/20→ | for individual equipment ID: FC35; → Vehicle Identification Number to: 52401; Required quantity: 2; Fitting Position: Front Axle | 2 24.0711-5473.3 360452 | | | | | | |
| B4 Mild-Hybrid | 145 03/20→ | | | | | | | | |
| B5 Mild-Hybrid | 184 03/20→ | for individual equipment ID: FC25 / FC70; → Vehicle Identification Number to: 50727; Required quantity: 2; Fitting Position: Front Axle | 2 24.0711-5473.3 360452 | | | | | | |
| B5 Mild-Hybrid AWD | 183 - 03/20→ 184 | | | | | | | | |
| B6 Mild-Hybrid AWD | 220 04/21→ | | | | | | | | |
| T4 | 140 02/19→ | | | | | | | | |
| T4 Polestar | 155 07/19→ | | | | | | | | |
| T5 | 184 02/19→ | | | | | | | | |
| T5 AWD | 183 - 02/19→ 187 | | | | | | | | |
| T5 Polestar | 186 07/19→ | | | | | | | | |
| T5 Polestar AWD | 186 07/19→ | | | | | | | | |
| T6 AWD | 228 05/19→ | | | | | | | | |
| T6 Drive-E Polestar | 233 02/19→ | | | | | | | | |
| AWD | | | | | | | | | |
| T6 Hybrid Polestar AWD | 245 05/19→ | | | | | | | | |
| T6 Polestar AWD | 240 05/19→ | | | | | | | | |
| T6 Twin Engine AWD | 186 02/19→ | | | | | | | | |
| T8 Plug-in Hybrid AWD | 228 - 05/19→ 335 | | | | | | | | |
| T8 Twin Engine AWD | 223 02/19→ | | | | | | | | |
| T8 Twin Engine Polestar | 233 10/19→ | | | | | | | | |
| AWD | | | | | | | | | |
| VOLVO - S90 II (234) 01/16→ | | | | | | | | | |
|  Wheel Speed Sensor | | | | | | | | | |
| 2.0 | 183 03/16→ | | | | | → Vehicle Identification Number to: 83010; Required quantity: 2; Fitting Position: Front Axle | 2 24.0711-5473.3 360452 | | |
| B4 Mild-Hybrid | 145 03/20→ | | | | | | | | |
| B5 Mild-Hybrid | 183 03/20→ 184 | | | | | | | | |
| B5 Mild Hybrid AWD | 173 05/20→ | | | | | | | | |
| D3 | 110 03/16→08/18 | | | | | | | | |
| D4 | 120 - 03/16→ 140 | | | | | | | | |
| D4 AWD | 140 03/16→ | | | | | | | | |
| D4 Drive-E Polestar | 147 03/16→ | | | | | | | | |
| D4 Drive-E Polestar | 147 03/16→ | | | | | | | | |
| AWD | | | | | | | | | |
| D5 AWD | 173 03/16→ | | | | | | | | |
| D5 Polestar AWD | 177 06/19→ | | | | | | | | |
| T4 | 140 10/17→ | | | | | | | | |
| T4 Polestar | 155 06/19→ | | | | | | | | |
| T5 | 184 - 03/16→ 187 | | | | | | | | |
| T5 Drive-E Polestar | 186 - 03/16→ 192 | | | | | | | | |
| T6 AWD | 228 - 03/16→ 235 | | | | | | | | |
| T6 Drive-E Polestar | 240 - 03/16→ 246 | | | | | | | | |
| AWD | | | | | | | | | |
| T8 Plug-in Hybrid AWD | 228 - 10/17→ 335 | | | | | | | | |
| B6 Mild-Hybrid AWD | 220 03/20→ | | | | | Required quantity: 2; → Vehicle Identification Number to: 134375; Fitting Position: Front Axle | 2 24.0711-5473.3 360452 | | |
| T8 Hybrid AWD | 223 04/18→ | | | | | Wheelbase: not for extended wheelbase; → Vehicle Identification Number to: 83010; Required quantity: 2; Fitting Position: Front Axle | 2 24.0711-5473.3 360452 | | |
| T8 Hybrid Polestar AWD | 233 01/19→ | | | | | | | | |
| T8 Plug-in Hybrid Polestar AWD | 246 10/17→ | Wheelbase: for extended wheelbase; → Vehicle Identification Number to: 163513; Required quantity: 2; Fitting Position: Front Axle | 2 24.0711-5473.3 360452 | | | | | | |
| VOLVO - V60 II (225, 227) 02/18→ | | | | | | | | | |
|  Wheel Speed Sensor | | | | | | | | | |
| 2.0 B5 Mild-Hybrid AWD | 183 03/22→ | Required quantity: 2; for individual equipment ID: FC22 / FC25; | 2 24.0711-5473.3 360452 | | | | | | |
| B5 Mild-Hybrid AWD | 184 03/20→ | | | | | | | | |
| D3 AWD | 110 09/18→ | | | | | | | | |







| | kW | | | | | | |
|---|---------------------|--|---|------------------------------|---|---|------------------------------|
| VOLVO - V60 II (225, 227) 02/18→ | | | | | | | |
|  Wheel Speed Sensor | | | | | | | |
| D4 AWD | 140 09/18→ | → Vehicle Identification Number to: 371655; Suspension: for vehicles without increased ground clearance; Fitting Position: Front Axle | 2 | 24.0711-5473.3 360452 | | | |
| D4 Polestar AWD | 147 02/18→12/20 | | | | | | |
| T5 AWD | 184 03/19→ | | | | | | |
| T5 Polestar AWD | 186 07/19→ | | | | | | |
| | | Required quantity: 2; for individual equipment ID: FC21; → Vehicle Identification Number to: 370409; Suspension: for vehicles without increased ground clearance; Fitting Position: Front Axle | 2 | 24.0711-5473.3 360452 | | | |
| | | Required quantity: 2; → Vehicle Identification Number to: 40906; Suspension: for vehicles with increased ground clearance; Fitting Position: Front Axle | 2 | 24.0711-5473.3 360452 | | | |
| 2.0 T4 | 140 05/19→ | Required quantity: 2; for individual equipment ID: FC22 / FC25; → Vehicle Identification Number to: 371655; Fitting Position: Front Axle | 2 | 24.0711-5473.3 360452 | | | |
| 2.0 T6 Drive-E Polestar AWD | 240 02/18→ | | | | | | |
| B3 Mild-Hybrid | 120 03/20→ | | | | | | |
| B4 Mild-Hybrid | 145 03/20→ | | | | | | |
| B4 Mild-Hybrid AWD | 145 10/20→ | Required quantity: 2; for individual equipment ID: FC21; → Vehicle Identification Number to: 370409; Fitting Position: Front Axle | 2 | 24.0711-5473.3 360452 | | | |
| B5 Mild-Hybrid | 184 03/20→ | | | | | | |
| B6 Mild-Hybrid AWD | 220 03/20→ | | | | | | |
| D3 | 110 02/18→ | | | | | | |
| D4 | 140 02/18→ | | | | | | |
| D4 Polestar | 147 02/18→ | | | | | | |
| T4 Polestar | 155 07/19→ | | | | | | |
| T5 | 184 02/18→ | | | | | | |
| T5 Polestar | 186 07/19→ | | | | | | |
| T6 AWD | 228 02/18→ | | | | | | |
| T6 Plug-in Hybrid AWD | 186 03/19→ | | | | | | |
| T8 Plug-in Hybrid AWD | 223 - 02/18→ 335 | | | | | | |
| T8 Plug-in Hybrid Polestar AWD | 233 05/19→ | | | | | | |
| VOLVO - V90 II Estate (235, 236) 03/16→ | | | | | | | |
|  Wheel Speed Sensor | | | | | | | |
| B4 Mild-Hybrid | 145 03/20→ | | | | → Vehicle Identification Number to: 134375; Required quantity: 2; Fitting Position: Front Axle | 2 | 24.0711-5473.3 360452 |
| B5 Mild-Hybrid | 184 - 03/20→ 196 | | | | | | |
| T6 Plug-In Hybrid AWD | 186 04/21→ | | | | | | |
| T6 Plug-in-Hybrid AWD | 250 06/20→ | | | | | | |
| T8 Plug-in-Hybrid AWD | 287 06/20→ | → Vehicle Identification Number to: 109482; Required quantity: 2; Suspension: for vehicles with increased ground clearance; Fitting Position: Front Axle | 2 | 24.0711-5473.3 360452 | | | |
| B5 Mild Hybrid AWD | 173 12/20→ | | | | | | |
| B5 Mild-Hybrid AWD | 184 03/20→ | | | | | | |
| B6 Mild-Hybrid AWD | 220 - 03/20→ 256 | | | | | | |
| D3 | 110 03/16→08/18 | | | | | | |
| D3 AWD | 110 03/16→ | | | | | | |
| D4 | 120 - 03/16→ 140 | | | | | | |
| D4 AWD | 120 - 03/16→ 140 | | | | | | |
| D4 Polestar | 147 10/16→ | | | | | | |
| D5 AWD | 173 03/16→ | | | | | | |
| Polestar AWD | 147 - 10/16→ 176 | | | | | | |
| T4 | 140 10/17→ | | | | | | |
| T4 Polestar | 155 06/19→ | | | | | | |
| T5 | 184 - 03/16→ 187 | | | | | | |
| T5 AWD | 183 - 03/16→ 187 | | | | | | |
| T5 Polestar | 186 06/19→ | | | | | | |
| T5 Polestar AWD | 186 10/17→ | | | | | | |
| T6 AWD | 228 - 03/16→ 235 | | | | | | |
| T6 Polestar AWD | 240 - 10/16→ 246 | | | | | | |
| T8 Hybrid AWD | 223 04/18→ | | | | | | |
| T8 Plug-in-Hybrid AWD | 235 03/16→12/18 | | | | | | |
| T8 Plug-in Hybrid Polestar AWD | 233 - 03/16→ 246 | | | | | | |

| | kW | | | |
|---|-----------|-------------|--|--------------------------------|
| VOLVO - XC60 II (246) 03/17→ | | | | |
|  Wheel Speed Sensor | | | | |
| 2.0 B5 Mild-Hybrid | 183 | 03/22→ | Required quantity: 2; Fitting Position: Front Axle | 2 24.0711-5473.3 360452 |
| 2.0 B5 Mild-Hybrid AWD | 183 | 03/22→ | | |
| B4 Mild-Hybrid | 145 | 05/19→ | | |
| B4 Mild-Hybrid AWD | 145 | 04/19→ | | |
| B4 Plug-In Hybrid | 186 | 01/21→ | | |
| B4 Plug-In Hybrid AWD | 186 - 250 | 01/21→ | | |
| B5 Mild-Hybrid | 184 | 01/20→ | | |
| B5 Mild-Hybrid AWD | 173 - 184 | 04/19→ | | |
| B6 Mild-Hybrid AWD | 220 | 03/20→ | | |
| D3 | 110 | 03/17→ | | |
| D4 | 120 - 140 | 03/17→ | | |
| D4 AWD | 140 | 03/17→ | | |
| D4 Polestar | 147 | 05/20→ | | |
| D4 Polestar AWD | 147 | 01/19→ | | |
| D5 AWD | 173 | 03/17→ | | |
| D5 Polestar AWD | 177 | 10/18→ | | |
| T4 | 140 | 09/18→ | | |
| T4 Polestar | 155 | 07/19→ | | |
| T5 | 184 - 187 | 03/17→ | | |
| T5 AWD | 183 - 187 | 03/17→ | | |
| T5 Polestar | 186 | 05/19→ | | |
| T5 Polestar AWD | 186 - 192 | 03/17→ | | |
| T6 AWD | 228 - 235 | 03/17→ | | |
| T6 Plug-In Hybrid AWD | 186 | 04/21→ | | |
| T6 Polestar AWD | 240 - 246 | 03/17→ | | |
| T8 Hybrid AWD | 223 - 246 | 03/17→ | | |
| T8 Hybrid Polestar AWD | 233 - 246 | 01/19→ | | |
| VOLVO - XC90 II (256) 09/14→ | | | | |
|  Wheel Speed Sensor | | | | |
| 2.0 B5 Mild-Hybrid | 183 - 184 | 01/22→ | → Vehicle Identification Number to: 583304; Required quantity: 2; Fitting Position: Front Axle | 2 24.0711-5473.3 360452 |
| 2.0 B5 Mild-Hybrid AWD | 183 - 184 | 01/20→ | | |
| 2.0 D5 Polestar AWD | 177 | 10/18→ | | |
| 2.0 T5 AWD | 183 - 184 | 02/16→ | | |
| 2.0 T6 AWD | 228 | 10/17→ | | |
| 2.0 T8 Hybrid AWD | 223 | 04/18→ | | |
| 2.0 T8 Hybrid Polestar AWD | 233 | 01/19→ | | |
| B5 Mild-Hybrid AWD | 173 | 04/19→ | | |
| B6 Mild-Hybrid AWD | 220 | 03/20→ | | |
| D4 | 140 | 06/15→12/18 | | |
| D4 AWD | 140 | 10/15→12/18 | | |
| D5 AWD | 165 - 173 | 09/14→12/19 | | |
| D5 DRiVe Polestar AWD | 176 | 03/16→ | | |
| T5 AWD | 187 | 06/15→12/18 | | |
| T5 Drive-E Polestar AWD | 176 - 192 | 10/17→ | | |
| T5 Polestar AWD | 186 | 07/19→ | | |
| T6 AWD | 235 | 09/14→12/18 | | |
| T6 Polestar AWD | 240 - 246 | 01/17→ | | |
| T8 Hybrid AWD | 235 - 298 | 06/15→ | | |
| T8 Plug-in Hybrid AWD | 228 - 335 | 03/22→ | | |
| T8 Plug-in Hybrid Polestar AWD | 246 | 06/15→ | | |
| T8 Twin Engine AWD | 287 | 06/19→ | | |
| VW - AMAROK (2HA, 2HB, S1B, S6B, S7A, S7B) 09/10→ | | | | |
|  Wheel Speed Sensor | | | | |
| 2.0 BiTDI | 120 - 132 | 09/10→ | Fitting Position: Front Axle Right | 24.0711-5271.3 360301 |
| 2.0 BiTDI 4motion | 120 - 132 | 09/10→ | Fitting Position: Front Axle Left | 24.0711-5272.3 360302 |
| 2.0 TDI | 90 - 103 | 09/10→ | | |
| → | | | | |

| | | | | | |
|--|--------------------------|--|--|-----------------------|---|
| | kW | | | | |
| VW - AMAROK (2HA, 2HB, S1B, S6B, S7A, S7B) 09/10→ | | | | | |
|  Wheel Speed Sensor | | | | | |
| 2.0 TDI 4motion | 90 - 09/10→ 103 | | Fitting Position: Front Axle Right | 24.0711-5271.3 | 360301 |
| 2.0 TSI | 118 12/10→10/16 | | Fitting Position: Front Axle Left | 24.0711-5272.3 | 360302 |
| 3.0 TDI | 120 06/16→ | | | | |
| 3.0 TDI 4motion | 150 - 06/16→ 190 | | | | |
| 3.0 TDI 4motion | 120 - 06/16→ 165 | | Construction year from: 09/16 →; Fitting Position: Front Axle Right | 24.0711-5271.3 | 360301 |
| | | | Construction year from: 09/16 →; Fitting Position: Front Axle Left | 24.0711-5272.3 | 360302 |
| VW - AMAROK Platform/Chassis (S1B, S6B, S7B) 09/11→ | | | | | |
|  Wheel Speed Sensor | | | | | |
| 2.0 BiTDI | 132 09/11→07/19 | | Construction year from: 11/11 →; Fitting Position: Front Axle Right | 24.0711-5271.3 | 360301 |
| | | | Construction year from: 11/11 →; Fitting Position: Front Axle Left | 24.0711-5272.3 | 360302 |
| 2.0 BiTDI 4motion | 132 09/11→07/19 | | Fitting Position: Front Axle Right | 24.0711-5271.3 | 360301 |
| 3.0 TDI 4motion | 150 - 06/16→ 190 | | Fitting Position: Front Axle Left | 24.0711-5272.3 | 360302 |
| 2.0 TDI | 90 - 09/11→10/16 103 | | Construction year from: 07/12 →; Fitting Position: Front Axle Right | 24.0711-5271.3 | 360301 |
| | | | Construction year from: 07/12 →; Fitting Position: Front Axle Left | 24.0711-5272.3 | 360302 |
| 2.0 TDI 4motion | 103 09/11→10/16 | | Construction year from: 06/12 →; Fitting Position: Front Axle Right | 24.0711-5271.3 | 360301 |
| | | | Construction year from: 06/12 →; Fitting Position: Front Axle Left | 24.0711-5272.3 | 360302 |
| VW - ARTEON (3H7, 3H8) 03/17→ | | | | | |
|  Brake Pad Set, disc brake | | | | | |
| 1.5 TSI | 110 11/17→07/19 | | for PR number: 1ZA / 1ZD / 1ZK / 1ZL; Fitting Position: Front Axle | 13.0470-2785.2 | LD2785 Brake System: Lucas / TRW 25683 20,4 Wear Warning Contact: prepared for wear indicator / incl. wear warning contact Ceramic |
| 2.0 TDI | 110 - 03/17→ 147 | | | | |
| 2.0 TDI 4motion | 140 - 03/17→ 176 | | | | |
| 2.0 TSI | 140 05/17→ | | | | |
| 2.0 TSI 4motion | 200 - 04/17→ 206 | | | | |
| | | | | | |
| VW - ARTEON SHOOTING BRAKE (3H9) 06/20→ | | | | | |
|  Brake Pad Set, disc brake | | | | | |
| 1.5 TSi | 110 08/20→ | | for PR number: 1ZA / 1ZD / 1ZK / 1ZL; Fitting Position: Front Axle | 13.0470-2785.2 | LD2785 Brake System: Lucas / TRW 25683 20,4 Wear Warning Contact: prepared for wear indicator / incl. wear warning contact Ceramic |
| 2.0 TDI | 110 - 09/20→ 147 | | | | |
| 2.0 TDI 4motion | 140 - 09/20→ 147 | | | | |
| 2.0 TSi | 140 09/20→ | | | | |
| 2.0 TSi 4motion | 200 09/20→ | | | | |
| 2.0 TSi 4motion | 206 06/20→ | | | | |
| VW - BEETLE (5C1, 5C2) 04/11→07/19 | | | | | |
|  Wheel Speed Sensor | | | | | |
| 1.2 TSI | 77 07/11→07/19 | | Fitting Position: Front Axle Left | 24.0711-5271.3 | 360301 |
| 1.2 TSI 16V | 77 12/14→07/19 | | Fitting Position: Front Axle Right | 24.0711-5272.3 | 360302 |
| 1.4 TSI | 110 - 10/11→07/19 118 | | | | |
| 1.6 TDI | 77 10/11→07/16 | | | | |
| 2.0 TDI | 103 04/11→07/16 | | | | |
| 2.0 TFSI | 147 04/11→07/16 | | | | |
| 2.0 TSI | 130 - 12/14→07/19 162 | | | | |
| 2.5 | 125 04/11→07/19 | | | | |
| 2.0 TDI | 81 06/14→09/18 | | Construction year from: 12/14 →; Fitting Position: Front Axle Left | 24.0711-5271.3 | 360301 |
| | | | Construction year from: 12/14 →; Fitting Position: Front Axle Right | 24.0711-5272.3 | 360302 |
| 2.0 TDI | 110 07/14→09/18 | | Construction year from: 09/14 →; Fitting Position: Front Axle Left | 24.0711-5271.3 | 360301 |
| | | | Construction year from: 09/14 →; Fitting Position: Front Axle Right | 24.0711-5272.3 | 360302 |
| 2.0 TSI | 155 12/12→07/19 | | Construction year from: 05/13 →; Fitting Position: Front Axle Left | 24.0711-5271.3 | 360301 |
| | | | Construction year from: 05/13 →; Fitting Position: Front Axle Right | 24.0711-5272.3 | 360302 |

| | kW | | | |
|---|-------|-------------|------------------------------------|------------------------------|
| VW - BEETLE Convertible (5C7, 5C8) 12/11→07/19 | | | | |
|  Wheel Speed Sensor | | | | |
| 1.2 TSI | 77 | 12/11→07/19 | Construction year from: 11/12 →; | 24.0711-5271.3 360301 |
| 1.4 TSI | 118 | 12/11→07/16 | Fitting Position: Front Axle Left | |
| 1.6 TDI | 77 | 12/11→07/16 | Construction year from: 11/12 →; | 24.0711-5272.3 360302 |
| 2.0 TDI | 103 | 04/12→07/16 | Fitting Position: Front Axle Right | |
| 2.0 TFSI | 147 | 12/11→07/16 | | |
| 1.2 TSI 16V | 77 | 12/14→07/19 | Fitting Position: Front Axle Left | 24.0711-5271.3 360301 |
| 1.4 TSI | 110 | 12/14→09/18 | Fitting Position: Front Axle Right | 24.0711-5272.3 360302 |
| 2.0 TDI | 110 | 09/14→09/18 | | |
| 2.0 TSI | 162 | 12/14→09/18 | | |
| 2.0 TDI | 81 | 06/14→09/18 | Construction year from: 12/14 →; | 24.0711-5271.3 360301 |
| | | | Fitting Position: Front Axle Left | |
| | | | Construction year from: 12/14 →; | 24.0711-5272.3 360302 |
| | | | Fitting Position: Front Axle Right | |
| 2.0 TSI | 155 | 12/12→07/19 | Construction year from: 05/13 →; | 24.0711-5271.3 360301 |
| | | | Fitting Position: Front Axle Left | |
| | | | Construction year from: 05/13 →; | 24.0711-5272.3 360302 |
| | | | Fitting Position: Front Axle Right | |
| 2.5 | 125 | 12/11→07/16 | Construction year from: 12/12 →; | 24.0711-5271.3 360301 |
| | | | Fitting Position: Front Axle Left | |
| | | | Construction year from: 12/12 →; | 24.0711-5272.3 360302 |
| | | | Fitting Position: Front Axle Right | |
| VW - CADDY III Box Body/MPV (2KA, 2KH, 2CA, 2CH) 03/04→05/15 | | | | |
|  Wheel Speed Sensor | | | | |
| 1.2 TSI | 63 - | 09/10→05/15 | Fitting Position: Front Axle Left | 24.0711-5271.3 360301 |
| | 77 | | Fitting Position: Front Axle Right | 24.0711-5272.3 360302 |
| 1.4 | 55 - | 03/04→08/10 | | |
| | 59 | | | |
| 1.6 | 75 | 04/04→05/15 | | |
| 1.6 BiFuel | 75 | 05/11→05/15 | | |
| 1.6 TDI | 55 - | 08/10→05/15 | | |
| | 75 | | | |
| 1.9 TDI | 55 - | 04/04→08/10 | | |
| | 77 | | | |
| 2.0 EcoFuel | 80 | 04/06→05/15 | | |
| 2.0 SDI | 51 | 03/04→08/10 | | |
| 2.0 TDI | 62 - | 09/07→05/15 | | |
| | 125 | | | |
| 2.0 TDI 16V | 103 | 11/10→05/15 | | |
| 2.0 TDI 16V 4motion | 103 | 11/10→05/15 | | |
| 1.9 TDI 4motion | 77 | 11/08→08/10 | Fitting Position: Front Axle Left | 24.0711-5271.3 360301 |
| | | | Fitting Position: Front Axle Right | 24.0711-5272.3 360302 |
| | | | Fitting Position: Rear Axle Left | 24.0711-5271.3 360301 |
| | | | Fitting Position: Rear Axle Right | 24.0711-5272.3 360302 |
| 2.0 TDI | 81 | 08/10→05/15 | Construction year from: 10/10 →; | 24.0711-5271.3 360301 |
| | | | Fitting Position: Front Axle Left | |
| | | | Construction year from: 10/10 →; | 24.0711-5272.3 360302 |
| | | | Fitting Position: Front Axle Right | |
| 2.0 TDI 4motion | 62 - | 08/10→05/15 | Fitting Position: Front Axle Left | 24.0711-5271.3 360301 |
| | 81 | | Fitting Position: Front Axle Right | 24.0711-5272.3 360302 |
| | | | → Construction year to: 05/12; | 24.0711-5271.3 360301 |
| | | | Fitting Position: Rear Axle Left | |
| | | | → Construction year to: 05/12; | 24.0711-5272.3 360302 |
| | | | Fitting Position: Rear Axle Right | |
| VW - CADDY III MPV (2KB, 2KJ, 2CB, 2CJ) 03/04→05/15 | | | | |
|  Wheel Speed Sensor | | | | |
| 1.2 TSI | 63 - | 09/10→05/15 | Fitting Position: Front Axle Left | 24.0711-5271.3 360301 |
| | 77 | | Fitting Position: Front Axle Right | 24.0711-5272.3 360302 |
| 1.4 | 55 - | 03/04→08/10 | | |
| | 59 | | | |
| 1.6 | 75 | 04/04→05/15 | | |
| 1.6 BiFuel | 75 | 05/11→05/15 | | |
| 1.6 TDI | 55 - | 08/10→05/15 | | |
| | 75 | | | |
| 1.9 D | 48 | 10/05→06/09 | | |
| 1.9 TDI | 55 - | 04/04→08/10 | | |
| | 77 | | | |
| 2.0 EcoFuel | 80 | 04/06→05/15 | | |
| 2.0 SDI | 51 | 03/04→08/10 | | |
| 2.0 TDI | 103 - | 09/07→05/15 | | |
| | 125 | | | |
| 2.0 TDI 16V | 103 | 11/10→05/15 | | |
| 1.9 TDI 4motion | 77 | 05/08→08/10 | Fitting Position: Front Axle Left | 24.0711-5271.3 360301 |
| | | | Fitting Position: Front Axle Right | 24.0711-5272.3 360302 |
| → | | | | |

| | kW | | | | |
|--|-------|-------------|--|-----------------------|---|
| VW - CADDY III MPV (2KB, 2KJ, 2CB, 2CJ) 03/04→05/15 | | | | | |
|  Wheel Speed Sensor | | | | | |
| 1.9 TDI 4motion | 77 | 05/08→08/10 | Fitting Position: Rear Axle Left | 24.0711-5271.3 | 360301 |
| | | | Fitting Position: Rear Axle Right | 24.0711-5272.3 | 360302 |
| 2.0 TDI | 81 | 08/10→05/15 | Construction year from: 10/10 →; Fitting Position: Front Axle Left | 24.0711-5271.3 | 360301 |
| | | | Construction year from: 10/10 →; Fitting Position: Front Axle Right | 24.0711-5272.3 | 360302 |
| 2.0 TDI 16V 4motion | 103 | 11/10→05/15 | Fitting Position: Front Axle Left | 24.0711-5271.3 | 360301 |
| 2.0 TDI 4motion | 81 | 08/10→05/15 | Fitting Position: Front Axle Right | 24.0711-5272.3 | 360302 |
| | | | → Construction year to: 05/12; Fitting Position: Rear Axle Left | 24.0711-5271.3 | 360301 |
| | | | → Construction year to: 05/12; Fitting Position: Rear Axle Right | 24.0711-5272.3 | 360302 |
| VW - CADDY IV Box Body/MPV (SAA, SAH) 05/15→ | | | | | |
|  Brake Pad Set, disc brake | | | | | |
| 1.0 TSI | 75 | 11/15→09/20 | for PR number: 1ZE; Fitting Position: Front Axle | 13.0470-2785.2 | LD2785 Brake System: Lucas / TRW 25683 20,4 Wear Warning Contact: prepared for wear indicator / incl. wear warning contact Ceramic |
| 1.4 TSI | 92 - | 05/15→09/20 | | | |
| | 96 | | | | |
| 1.6 TDI | 55 - | 05/15→09/20 | | | |
| | 75 | | | | |
| 2.0 TDI | 55 - | 05/15→09/20 | | | |
| | 110 | | | | |
| 2.0 TDI 4motion | 110 | 11/15→09/20 | | | |
| 1.2 TSI | 62 | 06/15→09/20 | for PR number: 1ZA; Fitting Position: Front Axle | 13.0470-2785.2 | LD2785 Brake System: Lucas / TRW 25683 20,4 Wear Warning Contact: prepared for wear indicator / incl. wear warning contact Ceramic |
| 1.4 TGI CNG | 81 | 06/15→09/20 | | | |
| 1.6 | 81 | 11/15→09/20 | | | |
| 2.0 TDI | 75 | 05/15→09/20 | | | |
| 2.0 TDI 4motion | 55 - | 05/15→09/20 | | | |
| | 103 | | | | |
| ABT e-Caddy | 83 | 04/20→ | | | |
|  Wheel Speed Sensor | | | | | |
| 1.0 TSI | 75 | 11/15→09/20 | Fitting Position: Front Axle Left | 24.0711-5271.3 | 360301 |
| 1.2 TSI | 62 | 06/15→09/20 | Fitting Position: Front Axle Right | 24.0711-5272.3 | 360302 |
| 1.4 TGI CNG | 81 | 06/15→09/20 | | | |
| 1.4 TSI | 92 - | 05/15→09/20 | | | |
| | 96 | | | | |
| 1.6 | 81 | 11/15→09/20 | | | |
| 1.6 TDI | 55 - | 05/15→09/20 | | | |
| | 75 | | | | |
| 2.0 TDI | 55 - | 05/15→09/20 | | | |
| | 110 | | | | |
| 2.0 TDI 4motion | 55 - | 05/15→09/20 | | | |
| | 110 | | | | |
| ABT e-Caddy | 83 | 04/20→ | | | |
| VW - CADDY IV MPV (SAB, SAJ) 05/15→ | | | | | |
|  Brake Pad Set, disc brake | | | | | |
| 1.0 TSI | 62 - | 11/15→09/20 | for PR number: 1ZE; Fitting Position: Front Axle | 13.0470-2785.2 | LD2785 Brake System: Lucas / TRW 25683 20,4 Wear Warning Contact: prepared for wear indicator / incl. wear warning contact Ceramic |
| | 75 | | | | |
| 1.2 TSI | 62 | 06/15→09/20 | | | |
| 1.4 TGI CNG | 81 | 06/15→09/20 | | | |
| 1.6 | 81 | 11/15→09/20 | | | |
| 2.0 TDI | 55 - | 05/15→09/20 | | | |
| | 75 | | | | |
| 2.0 TDI 4motion | 90 | 05/15→09/20 | | | |
| 1.4 TSI | 92 - | 05/15→09/20 | for PR number: 1ZA; Fitting Position: Front Axle | 13.0470-2785.2 | LD2785 Brake System: Lucas / TRW 25683 20,4 Wear Warning Contact: prepared for wear indicator / incl. wear warning contact Ceramic |
| | 96 | | | | |
| 1.6 TDI | 55 - | 05/15→09/20 | | | |
| | 75 | | | | |
| 2.0 TDI | 103 - | 05/15→09/20 | | | |
| | 110 | | | | |
| 2.0 TDI 4motion | 81 - | 05/15→09/20 | | | |
| | 110 | | | | |
| ABT e-Caddy | 83 | 04/20→ | | | |
|  Wheel Speed Sensor | | | | | |
| 1.0 TSI | 62 - | 11/15→09/20 | Fitting Position: Front Axle Left | 24.0711-5271.3 | 360301 |
| | 75 | | Fitting Position: Front Axle Right | 24.0711-5272.3 | 360302 |
| 1.2 TSI | 62 | 06/15→09/20 | | | |
| 1.4 TGI CNG | 81 | 06/15→09/20 | | | |
| 1.4 TSI | 92 - | 05/15→09/20 | | | |
| | 96 | | | | |
| 1.6 | 81 | 11/15→09/20 | | | |
| 1.6 TDI | 55 - | 05/15→09/20 | | | |
| | 75 | | | | |
| → | | | | | |

| | | | | | |
|--|-------------------------|---|--|-----------------------|---|
| | kW | | | | |
| VW - CADDY IV MPV (SAB, SAJ) 05/15→ | | | | | |
|  Wheel Speed Sensor | | | | | |
| 2.0 TDI | 55 - 05/15→09/20 110 | Fitting Position: Front Axle Left | | 24.0711-5271.3 | 360301 |
| 2.0 TDI 4motion | 81 - 05/15→09/20 110 | Fitting Position: Front Axle Right | | 24.0711-5272.3 | 360302 |
| ABT e-Caddy | 83 04/20→ | | | | |
| VW - CADDY ALLTRACK Box Body/MPV (SAA) 05/15→ | | | | | |
|  Brake Pad Set, disc brake | | | | | |
| 1.0 TSI | 75 11/15→ | for PR number: 1ZE; Fitting Position: Front Axle | | 13.0470-2785.2 | LD2785 Brake System: Lucas / TRW 25683 20,4 Wear Warning Contact: prepared for wear indicator / incl. wear warning contact Ceramic |
| 1.2 TSI | 62 06/15→ | | | | |
| 1.4 TGI CNG | 81 06/15→ | | | | |
| 1.4 TSI | 92 05/15→ | | | | |
| 1.6 SRE | 81 11/15→09/20 | | | | |
| 1.6 TDI | 55 05/15→11/17 | | | | |
| 2.0 TDI | 55 - 05/15→ 103 | | | | |
| 2.0 TDI 4motion | 81 - 05/15→ 110 | | | | |
| 1.4 TSI | 96 06/19→ | for PR number: 1ZA; Fitting Position: Front Axle | | 13.0470-2785.2 | LD2785 Brake System: Lucas / TRW 25683 20,4 Wear Warning Contact: prepared for wear indicator / incl. wear warning contact Ceramic |
| 1.6 TDI | 75 05/15→ | | | | |
| 2.0 TDI | 110 05/15→ | | | | |
| 2.0 TDI 4motion | 90 05/15→ | | | | |
|  Wheel Speed Sensor | | | | | |
| 1.0 TSI | 75 11/15→ | Fitting Position: Front Axle Left | | 24.0711-5271.3 | 360301 |
| 1.2 TSI | 62 06/15→ | Fitting Position: Front Axle Right | | 24.0711-5272.3 | 360302 |
| 1.4 TGI CNG | 81 06/15→ | | | | |
| 1.4 TSI | 92 - 05/15→ 96 | | | | |
| 1.6 SRE | 81 11/15→09/20 | | | | |
| 1.6 TDI | 55 - 05/15→ 75 | | | | |
| 2.0 TDI | 55 - 05/15→ 110 | | | | |
| 2.0 TDI 4motion | 81 - 05/15→ 110 | | | | |
| VW - CADDY ALLTRACK MPV (SAB) 05/15→ | | | | | |
|  Brake Pad Set, disc brake | | | | | |
| 1.0 TSI | 62 11/18→ | for PR number: 1ZE; Fitting Position: Front Axle | | 13.0470-2785.2 | LD2785 Brake System: Lucas / TRW 25683 20,4 Wear Warning Contact: prepared for wear indicator / incl. wear warning contact Ceramic |
| 1.2 TSI | 62 06/15→ | | | | |
| 1.4 TGI CNG | 81 06/15→ | | | | |
| 1.4 TSI | 92 05/15→ | | | | |
| 1.6 TDI | 55 05/15→11/17 | | | | |
| 2.0 TDI | 55 - 05/15→ 110 | | | | |
| 2.0 TDI 4motion | 81 - 05/15→ 110 | | | | |
| 1.0 TSI | 75 11/15→ | for PR number: 1ZA; Fitting Position: Front Axle | | 13.0470-2785.2 | LD2785 Brake System: Lucas / TRW 25683 20,4 Wear Warning Contact: prepared for wear indicator / incl. wear warning contact Ceramic |
| 1.4 TSI | 96 07/18→ | | | | |
| 1.6 TDI | 75 05/15→ | | | | |
| 2.0 TDI 4motion | 103 05/15→ | | | | |
|  Wheel Speed Sensor | | | | | |
| 1.0 TSI | 62 - 11/15→ 75 | Fitting Position: Front Axle Left | | 24.0711-5271.3 | 360301 |
| 1.2 TSI | 62 06/15→ | Fitting Position: Front Axle Right | | 24.0711-5272.3 | 360302 |
| 1.4 TGI CNG | 81 06/15→ | | | | |
| 1.4 TSI | 92 - 05/15→ 96 | | | | |
| 1.6 TDI | 55 - 05/15→ 75 | | | | |
| 2.0 TDI | 55 - 05/15→ 110 | | | | |
| 2.0 TDI 4motion | 81 - 05/15→ 110 | | | | |
| VW - CADDY Box Body/MPV (6K9, 9E7, 9E9) 09/02→12/09 | | | | | |
|  Wheel Speed Sensor | | | | | |
| 1.9 D | 47 02/98→06/09 | Fitting Position: Front Axle Left | | 24.0711-5271.3 | 360301 |
| | | Fitting Position: Front Axle Right | | 24.0711-5272.3 | 360302 |



| | | kW | | | | | |
|--|------------------|-----|--|---|------------------------------|--|--|
| VW - CALIFORNIA T5 Camper (7EC, 7EF, 7EG, 7HF) 04/03→08/15 | | | | | | | |
|  Brake Caliper | | | | | | | |
| 1.9 TDI | 63 - 05/07→11/09 | 77 | | Vehicle Identification Number from: 7H-A-200001 →; for PR number: 2E4; Fitting Position: Front Axle Left | 24.3441-9933.5 241141 | Brake System: ATE Supplementary Article/Supplementary Info: without holder Brake Caliper Type: Fist-type Caliper (2 pistons) | |
| 2.5 TDi | 120 05/07→11/09 | | | | | | |
| 2.5 TDI | 96 - 05/07→11/09 | 128 | | | | | |
| 2.5 TDI 4motion | 96 - 05/07→11/09 | 128 | | Vehicle Identification Number from: 7H-A-200001 →; for PR number: 2E4; Fitting Position: Front Axle Right | 24.3441-9934.5 241142 | Brake System: ATE Supplementary Article/Supplementary Info: without holder Brake Caliper Type: Fist-type Caliper (2 pistons) | |
| | | | | for PR number: 2E3; Fitting Position: Front Axle Left | 24.3601-9947.5 240597 | Brake System: ATE Supplementary Article/Supplementary Info: without holder Brake Caliper Type: Fist-type Caliper | |
| | | | | for PR number: 2E3; Fitting Position: Front Axle Right | 24.3601-9948.5 240598 | Brake System: ATE Supplementary Article/Supplementary Info: without holder Brake Caliper Type: Fist-type Caliper | |
| | | | | Vehicle Identification Number from: 7H-A-200001 →; Fitting Position: Rear Axle Left | 24.3414-1711.5 240852 | Brake System: Lucas / TRW Supplementary Article/Supplementary Info: without holder Brake Caliper Type: Fist-type Caliper | |
| | | | | for PR number: 0WL / 0WN / 0WM / 0WP / 0WQ; → Vehicle Identification Number to: 7H-5-120000; Fitting Position: Rear Axle Left | 24.3414-1711.5 240852 | Brake System: Lucas / TRW Supplementary Article/Supplementary Info: without holder Brake Caliper Type: Fist-type Caliper | |
| | | | | Vehicle Identification Number from: 7H-8-028000 →; for PR number: 0WR; → Vehicle Identification Number to: 7H-8-200000; Fitting Position: Rear Axle Left | 24.3414-1711.5 240852 | Brake System: Lucas / TRW Supplementary Article/Supplementary Info: without holder Brake Caliper Type: Fist-type Caliper | |
| | | | | Vehicle Identification Number from: 7H-6-000001 →; for PR number: 2E3 / 2E4; → Vehicle Identification Number to: 7H-A-050000; Fitting Position: Rear Axle Left | 24.3414-1711.5 240852 | Brake System: Lucas / TRW Supplementary Article/Supplementary Info: without holder Brake Caliper Type: Fist-type Caliper | |
| | | | | for PR number: 0WL / 0WN / 0WM / 0WP / 0WQ; → Vehicle Identification Number to: 7H-5-120000; Fitting Position: Rear Axle Right | 24.3414-1712.5 240853 | Brake System: Lucas / TRW Supplementary Article/Supplementary Info: without holder Brake Caliper Type: Fist-type Caliper | |
| | | | | Vehicle Identification Number from: 7H-A-200001 →; Fitting Position: Rear Axle Right | 24.3414-1712.5 240853 | Brake System: Lucas / TRW Supplementary Article/Supplementary Info: without holder Brake Caliper Type: Fist-type Caliper | |
| | | | | Vehicle Identification Number from: 7H-8-028000 →; for PR number: 0WR; → Vehicle Identification Number to: 7H-8-200000; Fitting Position: Rear Axle Right | 24.3414-1712.5 240853 | Brake System: Lucas / TRW Supplementary Article/Supplementary Info: without holder Brake Caliper Type: Fist-type Caliper | |
| | | | | Vehicle Identification Number from: 7H-6-000001 →; for PR number: 2E3 / 2E4; → Vehicle Identification Number to: 7H-A-050000; Fitting Position: Rear Axle Right | 24.3414-1712.5 240853 | Brake System: Lucas / TRW Supplementary Article/Supplementary Info: without holder Brake Caliper Type: Fist-type Caliper | |
| 1.9 TDI | 75 05/07→11/09 | | | Vehicle Identification Number from: 7H-A-200001 →; for PR number: 2E4; Fitting Position: Front Axle Left | 24.3441-9933.5 241141 | Brake System: ATE Supplementary Article/Supplementary Info: without holder Brake Caliper Type: Fist-type Caliper (2 pistons) | |
| | | | | Vehicle Identification Number from: 7H-A-200001 →; for PR number: 2E4; Fitting Position: Front Axle Right | 24.3441-9934.5 241142 | Brake System: ATE Supplementary Article/Supplementary Info: without holder Brake Caliper Type: Fist-type Caliper (2 pistons) | |
| | | | | for PR number: 2E3; Fitting Position: Front Axle Left | 24.3601-9947.5 240597 | Brake System: ATE Supplementary Article/Supplementary Info: without holder Brake Caliper Type: Fist-type Caliper | |



→



| | | kW | | | | | |
|--|--------------------------|--|--|-----------------------|---------------|--|--|
| VW - CALIFORNIA T5 Camper (7EC, 7EF, 7EG, 7HF) 04/03→08/15 | | | | | | | |
|  Brake Caliper | | | | | | | |
| 1.9 TDI | 75 05/07→11/09 | for PR number: 2E3; Fitting Position: Front Axle Right | | 24.3601-9948.5 | 240598 | Brake System: ATE Supplementary Article/Supplementary Info: without holder Brake Caliper Type: Fist-type Caliper | |
| | | Vehicle Identification Number from: 7H-A-200001 →; Fitting Position: Rear Axle Left | | 24.3414-1711.5 | 240852 | Brake System: Lucas / TRW Supplementary Article/Supplementary Info: without holder Brake Caliper Type: Fist-type Caliper | |
| | | Vehicle Identification Number from: 7H-6-000001 →; for PR number: 2E3 / 2E4; → Vehicle Identification Number to: 7H-A-050000; Fitting Position: Rear Axle Left | | 24.3414-1711.5 | 240852 | Brake System: Lucas / TRW Supplementary Article/Supplementary Info: without holder Brake Caliper Type: Fist-type Caliper | |
| | | Vehicle Identification Number from: 7H-8-028000 →; for PR number: 0WR; → Vehicle Identification Number to: 7H-8-200000; Fitting Position: Rear Axle Left | | 24.3414-1711.5 | 240852 | Brake System: Lucas / TRW Supplementary Article/Supplementary Info: without holder Brake Caliper Type: Fist-type Caliper | |
| | | Vehicle Identification Number from: 7H-A-200001 →; Fitting Position: Rear Axle Right | | 24.3414-1712.5 | 240853 | Brake System: Lucas / TRW Supplementary Article/Supplementary Info: without holder Brake Caliper Type: Fist-type Caliper | |
| | | Vehicle Identification Number from: 7H-8-028000 →; for PR number: 0WR; → Vehicle Identification Number to: 7H-8-200000; Fitting Position: Rear Axle Right | | 24.3414-1712.5 | 240853 | Brake System: Lucas / TRW Supplementary Article/Supplementary Info: without holder Brake Caliper Type: Fist-type Caliper | |
| | | Vehicle Identification Number from: 7H-6-000001 →; for PR number: 2E3 / 2E4; → Vehicle Identification Number to: 7H-A-050000; Fitting Position: Rear Axle Right | | 24.3414-1712.5 | 240853 | Brake System: Lucas / TRW Supplementary Article/Supplementary Info: without holder Brake Caliper Type: Fist-type Caliper | |
| | | | | | | | |
| 2.0 TDI | 62 - 09/09→08/15 132 | Vehicle Identification Number from: 7H-A-200001 →; for PR number: 2E4; Fitting Position: Front Axle Left | | 24.3441-9933.5 | 241141 | Brake System: ATE Supplementary Article/Supplementary Info: without holder Brake Caliper Type: Fist-type Caliper (2 pistons) | |
| 2.0 TDI 4motion | 103 - 10/09→08/15 132 | Vehicle Identification Number from: 7H-A-200001 →; for PR number: 2E4; Fitting Position: Front Axle Right | | 24.3441-9934.5 | 241142 | Brake System: ATE Supplementary Article/Supplementary Info: without holder Brake Caliper Type: Fist-type Caliper (2 pistons) | |
| | | for PR number: 2E3; Fitting Position: Front Axle Left | | 24.3601-9947.5 | 240597 | Brake System: ATE Supplementary Article/Supplementary Info: without holder Brake Caliper Type: Fist-type Caliper | |
| | | for PR number: 2E3; Fitting Position: Front Axle Right | | 24.3601-9948.5 | 240598 | Brake System: ATE Supplementary Article/Supplementary Info: without holder Brake Caliper Type: Fist-type Caliper | |
| | | Vehicle Identification Number from: 7H-A-200001 →; Fitting Position: Rear Axle Left | | 24.3414-1711.5 | 240852 | Brake System: Lucas / TRW Supplementary Article/Supplementary Info: without holder Brake Caliper Type: Fist-type Caliper | |
| | | Vehicle Identification Number from: 7H-6-000001 →; for PR number: 2E3 / 2E4; → Vehicle Identification Number to: 7H-A-050000; Fitting Position: Rear Axle Left | | 24.3414-1711.5 | 240852 | Brake System: Lucas / TRW Supplementary Article/Supplementary Info: without holder Brake Caliper Type: Fist-type Caliper | |
| | | Vehicle Identification Number from: 7H-A-200001 →; Fitting Position: Rear Axle Right | | 24.3414-1712.5 | 240853 | Brake System: Lucas / TRW Supplementary Article/Supplementary Info: without holder Brake Caliper Type: Fist-type Caliper | |
| | | Vehicle Identification Number from: 7H-6-000001 →; for PR number: 2E3 / 2E4; → Vehicle Identification Number to: 7H-A-050000; Fitting Position: Rear Axle Right | | 24.3414-1712.5 | 240853 | Brake System: Lucas / TRW Supplementary Article/Supplementary Info: without holder Brake Caliper Type: Fist-type Caliper | |
| → | | | | | | | |





| | kW | | | | |
|--|---|--|--------------------------------|--|--|
| VW - CALIFORNIA T5 Camper (7EC, 7EF, 7EG, 7HF) 04/03→08/15 | | | | | |
|  Brake Caliper | | | | | |
| 2.0 TDI 2.0 TSI 2.0 TSI 4motion | 84 05/11→08/15 110 - 05/11→08/15 150 150 07/11→08/15 | for PR number: 2E4; Fitting Position: Front Axle Left | 24.3441-9933.5 241141 | Brake System: ATE Supplementary Article/Supplementary Info: without holder Brake Caliper Type: Fist-type Caliper (2 pistons) | |
| | | for PR number: 2E4; Fitting Position: Front Axle Right | 24.3441-9934.5 241142 | Brake System: ATE Supplementary Article/Supplementary Info: without holder Brake Caliper Type: Fist-type Caliper (2 pistons) | |
| | | for PR number: 2E3; Fitting Position: Front Axle Left | 24.3601-9947.5 240597 | Brake System: ATE Supplementary Article/Supplementary Info: without holder Brake Caliper Type: Fist-type Caliper | |
| | | for PR number: 2E3; Fitting Position: Front Axle Right | 24.3601-9948.5 240598 | Brake System: ATE Supplementary Article/Supplementary Info: without holder Brake Caliper Type: Fist-type Caliper | |
| | | Fitting Position: Rear Axle Left | 24.3414-1711.5 240852 | Brake System: Lucas / TRW Supplementary Article/Supplementary Info: without holder Brake Caliper Type: Fist-type Caliper | |
| | | Fitting Position: Rear Axle Right | 24.3414-1712.5 240853 | Brake System: Lucas / TRW Supplementary Article/Supplementary Info: without holder Brake Caliper Type: Fist-type Caliper | |
| 2.0 TDI 2.0 TDI 4motion | 100 05/10→08/15 100 05/10→08/15 | Vehicle Identification Number from: 7H-A-200001 →; for PR number: 2E4; Fitting Position: Front Axle Left | 24.3441-9933.5 241141 | Brake System: ATE Supplementary Article/Supplementary Info: without holder Brake Caliper Type: Fist-type Caliper (2 pistons) | |
| | | Vehicle Identification Number from: 7H-A-200001 →; for PR number: 2E4; Fitting Position: Front Axle Right | 24.3441-9934.5 241142 | Brake System: ATE Supplementary Article/Supplementary Info: without holder Brake Caliper Type: Fist-type Caliper (2 pistons) | |
| | | for PR number: 2E3; Fitting Position: Front Axle Left | 24.3601-9947.5 240597 | Brake System: ATE Supplementary Article/Supplementary Info: without holder Brake Caliper Type: Fist-type Caliper | |
| | | for PR number: 2E3; Fitting Position: Front Axle Right | 24.3601-9948.5 240598 | Brake System: ATE Supplementary Article/Supplementary Info: without holder Brake Caliper Type: Fist-type Caliper | |
| | | Vehicle Identification Number from: 7H-A-200001 →; Fitting Position: Rear Axle Left | 24.3414-1711.5 240852 | Brake System: Lucas / TRW Supplementary Article/Supplementary Info: without holder Brake Caliper Type: Fist-type Caliper | |
| | | Vehicle Identification Number from: 7H-A-200001 →; Fitting Position: Rear Axle Right | 24.3414-1712.5 240853 | Brake System: Lucas / TRW Supplementary Article/Supplementary Info: without holder Brake Caliper Type: Fist-type Caliper | |
| Spring, brake caliper | | | | | |
| 1.9 TDI 2.0 TDI | 63 - 05/07→11/09 77 62 - 09/09→08/15 | Vehicle Identification Number from: 7H-A-200001 →; for PR number: 2E4; Required quantity: 2 | 2 11.8116-0126.2 390608 | Brake System: ATE | |
| 2.0 TDI 4motion | 103 - 10/09→08/15 132 | → Vehicle Identification Number to: 7H-A-050000; for PR number: 2E4; Required quantity: 2 | 2 11.8116-0237.1 390509 | Brake System: ATE | |
| 2.5 TDi 2.5 TDI | 120 05/07→11/09 96 - 05/07→11/09 128 | for PR number: 2E3; Required quantity: 2 | 2 11.8116-0237.1 390509 | Brake System: ATE | |
| 2.5 TDI 4motion | 96 - 05/07→11/09 128 | | | | |
| 2.0 TDI 2.0 TSI | 84 05/11→08/15 110 - 05/11→08/15 150 | for PR number: 2E4; Required quantity: 2 | 2 11.8116-0126.2 390608 | Brake System: ATE | |
| 2.0 TSI 4motion | 150 07/11→08/15 | for PR number: 2E3; Required quantity: 2 | 2 11.8116-0237.1 390509 | Brake System: ATE | |
| → | | | | | |





| | kW | | | | |
|--|-----|-------------|---|---|---|
| VW - CALIFORNIA T5 Camper (7EC, 7EF, 7EG, 7HF) 04/03→08/15 | | | | | |
| Spring, brake caliper | | | | | |
| 2.0 TDI | 100 | 05/10→08/15 | Vehicle Identification Number from: 7H-A-200001 →; for PR number: 2E4; Required quantity: 2 | 2 | 11.8116-0126.2 390608 Brake System: ATE |
| 2.0 TDI 4motion | 100 | 05/10→08/15 | for PR number: 2E3; Required quantity: 2 | 2 | 11.8116-0237.1 390509 Brake System: ATE |
|  Brake Pad Set, disc brake | | | | | |
| 1.9 TDI | 63 | 05/07→11/09 | for PR number: 2E3; Fitting Position: Front Axle | | 13.0460-7236.2 607236 Brake System: ATE 23746 19,7 Wear Warning Contact: incl. wear warning contact |
| 2.5 TDi | 120 | 05/07→11/09 | | | |
| 2.5 TDI | 96 | 05/07→11/09 | Vehicle Identification Number from: 7H-A-200001 →; for PR number: 2E4; Fitting Position: Front Axle | | 13.0460-7286.2 607286 Brake System: ATE 24623 18,2 Wear Warning Contact: incl. wear warning contact |
| 2.5 TDI 4motion | 96 | 05/07→11/09 | Vehicle Identification Number from: 7H-A-200001 →; Fitting Position: Rear Axle | | 13.0460-2882.2 602882 Brake System: Lucas / TRW 23326 17,4 Wear Warning Contact: incl. wear warning contact Supplementary Article/Supplementary Info: with accessories |
| | | | for PR number: 0WL / 0WN / 0WM / 0WP / 0WQ; → Vehicle Identification Number to: 7H-5-120000; Fitting Position: Rear Axle | | 13.0460-2882.2 602882 Brake System: Lucas / TRW 23326 17,4 Wear Warning Contact: incl. wear warning contact Supplementary Article/Supplementary Info: with accessories |
| | | | Vehicle Identification Number from: 7H-6-000001 →; for PR number: 2E3 / 2E4; → Vehicle Identification Number to: 7H-A-050000; Fitting Position: Rear Axle | | 13.0460-2882.2 602882 Brake System: Lucas / TRW 23326 17,4 Wear Warning Contact: incl. wear warning contact Supplementary Article/Supplementary Info: with accessories |
| | | | Vehicle Identification Number from: 7H-8-028000 →; for PR number: 0WR; → Vehicle Identification Number to: 7H-8-200000; Fitting Position: Rear Axle | | 13.0460-2882.2 602882 Brake System: Lucas / TRW 23326 17,4 Wear Warning Contact: incl. wear warning contact Supplementary Article/Supplementary Info: with accessories |
| 1.9 TDI | 75 | 05/07→11/09 | for PR number: 2E3; Fitting Position: Front Axle | | 13.0460-7236.2 607236 Brake System: ATE 23746 19,7 Wear Warning Contact: incl. wear warning contact |
| | | | Vehicle Identification Number from: 7H-A-200001 →; for PR number: 2E4; Fitting Position: Front Axle | | 13.0460-7286.2 607286 Brake System: ATE 24623 18,2 Wear Warning Contact: incl. wear warning contact |
| | | | Vehicle Identification Number from: 7H-A-200001 →; Fitting Position: Rear Axle | | 13.0460-2882.2 602882 Brake System: Lucas / TRW 23326 17,4 Wear Warning Contact: incl. wear warning contact Supplementary Article/Supplementary Info: with accessories |
| | | | Vehicle Identification Number from: 7H-8-028000 →; for PR number: 0WR; → Vehicle Identification Number to: 7H-8-200000; Fitting Position: Rear Axle | | 13.0460-2882.2 602882 Brake System: Lucas / TRW 23326 17,4 Wear Warning Contact: incl. wear warning contact Supplementary Article/Supplementary Info: with accessories |
| | | | Vehicle Identification Number from: 7H-6-000001 →; for PR number: 2E3 / 2E4; → Vehicle Identification Number to: 7H-A-050000; Fitting Position: Rear Axle | | 13.0460-2882.2 602882 Brake System: Lucas / TRW 23326 17,4 Wear Warning Contact: incl. wear warning contact Supplementary Article/Supplementary Info: with accessories |
| 2.0 TDI | 62 | 09/09→08/15 | for PR number: 2E3; Fitting Position: Front Axle | | 13.0460-7236.2 607236 Brake System: ATE 23746 19,7 Wear Warning Contact: incl. wear warning contact |
| 2.0 TDI 4motion | 103 | 10/09→08/15 | Vehicle Identification Number from: 7H-A-200001 →; for PR number: 2E4; Fitting Position: Front Axle | | 13.0460-7286.2 607286 Brake System: ATE 24623 18,2 Wear Warning Contact: incl. wear warning contact |
| | | | Vehicle Identification Number from: 7H-A-200001 →; Fitting Position: Rear Axle | | 13.0460-2882.2 602882 Brake System: Lucas / TRW 23326 17,4 Wear Warning Contact: incl. wear warning contact Supplementary Article/Supplementary Info: with accessories |
| → | | | | | |





| | kW | | | | |
|--|---|---|------------------------------|---|--|
| VW - CALIFORNIA T5 Camper (7EC, 7EF, 7EG, 7HF) 04/03→08/15 | | | | | |
|  Brake Pad Set, disc brake | | | | | |
| 2.0 TDI 2.0 TDI 4motion | 62 - 09/09→08/15 132 103 - 10/09→08/15 132 | Vehicle Identification Number from: 7H-6-000001 →; for PR number: 2E3 / 2E4; → Vehicle Identification Number to: 7H-A-050000; Fitting Position: Rear Axle | 13.0460-2882.2 602882 | Brake System: Lucas / TRW 23326 17,4 Wear Warning Contact: incl. wear warning contact Supplementary Article/Supplementary Info: with accessories | |
| 2.0 TDI 2.0 TSI 2.0 TSI 4motion | 84 05/11→08/15 110 - 05/11→08/15 150 150 07/11→08/15 | for PR number: 2E3; Fitting Position: Front Axle | 13.0460-7236.2 607236 | Brake System: ATE 23746 19,7 Wear Warning Contact: incl. wear warning contact | |
| | | for PR number: 2E4; Fitting Position: Front Axle | 13.0460-7286.2 607286 | Brake System: ATE 24623 18,2 Wear Warning Contact: incl. wear warning contact | |
| | | Fitting Position: Rear Axle | 13.0460-2882.2 602882 | Brake System: Lucas / TRW 23326 17,4 Wear Warning Contact: incl. wear warning contact Supplementary Article/Supplementary Info: with accessories | |
| 2.0 TDI 2.0 TDI 4motion | 100 05/10→08/15 100 05/10→08/15 | for PR number: 2E3; Fitting Position: Front Axle | 13.0460-7236.2 607236 | Brake System: ATE 23746 19,7 Wear Warning Contact: incl. wear warning contact | |
| | | Vehicle Identification Number from: 7H-A-200001 →; for PR number: 2E4; Fitting Position: Front Axle | 13.0460-7286.2 607286 | Brake System: ATE 24623 18,2 Wear Warning Contact: incl. wear warning contact | |
| | | Vehicle Identification Number from: 7H-A-200001 →; Fitting Position: Rear Axle | 13.0460-2882.2 602882 | Brake System: Lucas / TRW 23326 17,4 Wear Warning Contact: incl. wear warning contact Supplementary Article/Supplementary Info: with accessories | |
|  Brake Disc | | | | | |
| 1.9 TDI 2.5 TDi 2.5 TDI 2.5 TDI 4motion | 63 - 05/07→11/09 77 120 05/07→11/09 96 - 05/07→11/09 128 96 - 05/07→11/09 128 | for PR number: 2E3; Fitting Position: Front Axle | 24.0130-0114.1 430114 | Outer diameter [mm]: 308 Brake Disc Thickness [mm] 29.5 Minimum thickness [mm] 25.5 Brake Disc Type: Vented | |
| | | Vehicle Identification Number from: 7H-A-200001 →; for PR number: 2E4; Fitting Position: Front Axle | 24.0133-0100.1 433100 | Outer diameter [mm]: 340 Brake Disc Thickness [mm] 32.6 Minimum thickness [mm] 29.5 Brake Disc Type: Vented Supplementary Article/Info 2: with bolts/screws | |
| | | Vehicle Identification Number from: 7H-A-200001 →; Fitting Position: Rear Axle | 24.0122-0211.1 422211 | Outer diameter [mm]: 294 Brake Disc Thickness [mm] 21.9 Minimum thickness [mm] 19.5 Brake Disc Type: Vented Supplementary Article/Info 2: with bolts/screws | |
| | | for PR number: 0WL / 0WN / 0WM / 0WP / 0WQ; → Vehicle Identification Number to: 7H-5-120000; Fitting Position: Rear Axle | 24.0122-0211.1 422211 | Outer diameter [mm]: 294 Brake Disc Thickness [mm] 21.9 Minimum thickness [mm] 19.5 Brake Disc Type: Vented Supplementary Article/Info 2: with bolts/screws | |
| | | Vehicle Identification Number from: 7H-8-028000 →; for PR number: 0WR; → Vehicle Identification Number to: 7H-8-200000; Fitting Position: Rear Axle | 24.0122-0211.1 422211 | Outer diameter [mm]: 294 Brake Disc Thickness [mm] 21.9 Minimum thickness [mm] 19.5 Brake Disc Type: Vented Supplementary Article/Info 2: with bolts/screws | |
| | | Vehicle Identification Number from: 7H-6-000001 →; for PR number: 2E3 / 2E4; → Vehicle Identification Number to: 7H-A-050000; Fitting Position: Rear Axle | 24.0122-0211.1 422211 | Outer diameter [mm]: 294 Brake Disc Thickness [mm] 21.9 Minimum thickness [mm] 19.5 Brake Disc Type: Vented Supplementary Article/Info 2: with bolts/screws | |
| 1.9 TDI | 75 05/07→11/09 | for PR number: 2E3; Fitting Position: Front Axle | 24.0130-0114.1 430114 | Outer diameter [mm]: 308 Brake Disc Thickness [mm] 29.5 Minimum thickness [mm] 25.5 Brake Disc Type: Vented | |
| | | Vehicle Identification Number from: 7H-A-200001 →; for PR number: 2E4; Fitting Position: Front Axle | 24.0133-0100.1 433100 | Outer diameter [mm]: 340 Brake Disc Thickness [mm] 32.6 Minimum thickness [mm] 29.5 Brake Disc Type: Vented Supplementary Article/Info 2: with bolts/screws | |



| | | kW | | | | | |
|---|---|---|---|------------------------------|---|--|--|
| VW - CALIFORNIA T5 Camper (7EC, 7EF, 7EG, 7HF) 04/03→08/15 | | | | | | | |
|  Brake Disc | | | | | | | |
| 1.9 TDI | 75 05/07→11/09 | Vehicle Identification Number from: 7H-A-200001 →; Fitting Position: Rear Axle | | 24.0122-0211.1 422211 | Outer diameter [mm]: 294 Brake Disc Thickness [mm] 21.9 Minimum thickness [mm] 19.5 Brake Disc Type: Vented Supplementary Article/Info 2: with bolts/screws | | |
| | | Vehicle Identification Number from: 7H-6-000001 →; for PR number: 2E3 / 2E4; → Vehicle Identification Number to: 7H-A-050000; Fitting Position: Rear Axle | | 24.0122-0211.1 422211 | Outer diameter [mm]: 294 Brake Disc Thickness [mm] 21.9 Minimum thickness [mm] 19.5 Brake Disc Type: Vented Supplementary Article/Info 2: with bolts/screws | | |
| | | Vehicle Identification Number from: 7H-8-028000 →; for PR number: 0WR; → Vehicle Identification Number to: 7H-8-200000; Fitting Position: Rear Axle | | 24.0122-0211.1 422211 | Outer diameter [mm]: 294 Brake Disc Thickness [mm] 21.9 Minimum thickness [mm] 19.5 Brake Disc Type: Vented Supplementary Article/Info 2: with bolts/screws | | |
| 2.0 TDI 2.0 TDI 4motion | 62 - 09/09→08/15 132 103 - 10/09→08/15 132 | for PR number: 2E3; Fitting Position: Front Axle | | 24.0130-0114.1 430114 | Outer diameter [mm]: 308 Brake Disc Thickness [mm] 29.5 Minimum thickness [mm] 25.5 Brake Disc Type: Vented | | |
| | | Vehicle Identification Number from: 7H-A-200001 →; for PR number: 2E4; Fitting Position: Front Axle | | 24.0133-0100.1 433100 | Outer diameter [mm]: 340 Brake Disc Thickness [mm] 32.6 Minimum thickness [mm] 29.5 Brake Disc Type: Vented Supplementary Article/Info 2: with bolts/screws | | |
| | | Vehicle Identification Number from: 7H-A-200001 →; Fitting Position: Rear Axle | | 24.0122-0211.1 422211 | Outer diameter [mm]: 294 Brake Disc Thickness [mm] 21.9 Minimum thickness [mm] 19.5 Brake Disc Type: Vented Supplementary Article/Info 2: with bolts/screws | | |
| | | Vehicle Identification Number from: 7H-6-000001 →; for PR number: 2E3 / 2E4; → Vehicle Identification Number to: 7H-A-050000; Fitting Position: Rear Axle | | 24.0122-0211.1 422211 | Outer diameter [mm]: 294 Brake Disc Thickness [mm] 21.9 Minimum thickness [mm] 19.5 Brake Disc Type: Vented Supplementary Article/Info 2: with bolts/screws | | |
| 2.0 TDI 2.0 TSI 2.0 TSI 4motion | 84 05/11→08/15 110 - 05/11→08/15 150 150 07/11→08/15 | for PR number: 2E3; Fitting Position: Front Axle | | 24.0130-0114.1 430114 | Outer diameter [mm]: 308 Brake Disc Thickness [mm] 29.5 Minimum thickness [mm] 25.5 Brake Disc Type: Vented | | |
| | | for PR number: 2E4; Fitting Position: Front Axle | | 24.0133-0100.1 433100 | Outer diameter [mm]: 340 Brake Disc Thickness [mm] 32.6 Minimum thickness [mm] 29.5 Brake Disc Type: Vented Supplementary Article/Info 2: with bolts/screws | | |
| | | Fitting Position: Rear Axle | | 24.0122-0211.1 422211 | Outer diameter [mm]: 294 Brake Disc Thickness [mm] 21.9 Minimum thickness [mm] 19.5 Brake Disc Type: Vented Supplementary Article/Info 2: with bolts/screws | | |
| 2.0 TDI 2.0 TDI 4motion | 100 05/10→08/15 100 05/10→08/15 | for PR number: 2E3; Fitting Position: Front Axle | | 24.0130-0114.1 430114 | Outer diameter [mm]: 308 Brake Disc Thickness [mm] 29.5 Minimum thickness [mm] 25.5 Brake Disc Type: Vented | | |
| | | Vehicle Identification Number from: 7H-A-200001 →; for PR number: 2E4; Fitting Position: Front Axle | | 24.0133-0100.1 433100 | Outer diameter [mm]: 340 Brake Disc Thickness [mm] 32.6 Minimum thickness [mm] 29.5 Brake Disc Type: Vented Supplementary Article/Info 2: with bolts/screws | | |
| | | Vehicle Identification Number from: 7H-A-200001 →; Fitting Position: Rear Axle | | 24.0122-0211.1 422211 | Outer diameter [mm]: 294 Brake Disc Thickness [mm] 21.9 Minimum thickness [mm] 19.5 Brake Disc Type: Vented Supplementary Article/Info 2: with bolts/screws | | |
|  Brake Hose | | | | | | | |
| 1.9 TDI 2.0 TDI | 63 - 05/07→11/09 77 62 - 09/09→08/15 132 | for PR number: 1BA / 1BB / 1BJ / 1BV / 1MG / 1MK / 1ML / 2MD / 2MF / 2MG / 2ML; Required quantity: 2; Fitting Position: Front Axle | 2 | 24.5140-0514.3 331290 | Length [mm]: 520 | | |





| | kW | | | | |
|--|-------------------|--|---|---|---|
| VW - CALIFORNIA T5 Camper (7EC, 7EF, 7EG, 7HF) 04/03→08/15 | | | | | |
|  Brake Hose | | | | | |
| 2.0 TDI 4motion | 100 - 10/09→08/15 | | for PR number: 0WL / 0WN / 0WM / 0WP / 0WQ; Required quantity: 2; Fitting Position: Front Axle | 2 | 24.5140-0514.3 331290 Length [mm]: 520 |
| 2.5 TDi | 120 05/07→11/09 | | | | |
| 2.5 TDI | 96 - 05/07→11/09 | | for PR number: 1BH / 1BX / 1MR / 2MQ / 2MZ / 2MU / 2MT; Required quantity: 2; Fitting Position: Front Axle | 2 | 83.6113-0552.3 330864 Length [mm]: 552 |
| 2.5 TDI 4motion | 96 - 05/07→11/09 | | | | |
| | 128 | | for PR number: 0WR; Required quantity: 2; Fitting Position: Front Axle | 2 | 83.6113-0552.3 330864 Length [mm]: 552 |
| | | | Braking System: for vehicles with brake-power regulator; Required quantity: 2; Fitting Position: at brake caliper / Rear Axle | 2 | 24.5140-0194.3 331383 Length [mm]: 190 |
| | | | for PR number: 0E1 / 0E2 / 0WL / 0WN / 0WM / 0WP / 0WQ; Required quantity: 2; Fitting Position: Rear Axle | 2 | 24.5140-0194.3 331383 Length [mm]: 190 |
| | | | Required quantity: 2; Fitting Position: Rear Axle | 2 | 24.5237-0250.3 330880 Length [mm]: 250 |
| | | | for PR number: 0WR; Required quantity: 2; Fitting Position: Rear Axle | 2 | 24.5237-0250.3 330880 Length [mm]: 250 |
| 2.0 TDI | 84 05/11→08/15 | | for PR number: 1BA / 1BB / 1BJ / 1BV / 1MG / 1MK / 1ML / 2MD / 2MF / 2MG / 2ML; Required quantity: 2; Fitting Position: Front Axle | 2 | 24.5140-0514.3 331290 Length [mm]: 520 |
| 2.0 TSI | 110 - 05/11→08/15 | | | | |
| | 150 | | | | |
| 2.0 TSI 4motion | 150 07/11→08/15 | | for PR number: 1BH / 1BX / 1MR / 2MQ / 2MZ / 2MU / 2MT; Required quantity: 2; Fitting Position: Front Axle | 2 | 83.6113-0552.3 330864 Length [mm]: 552 |
| | | | Required quantity: 2; Fitting Position: Rear Axle | 2 | 24.5140-0194.3 331383 Length [mm]: 190 |
|  Wheel Speed Sensor | | | | | |
| 1.9 TDI | 63 - 05/07→11/09 | | Fitting Position: Front Axle Left | | 24.0711-5271.3 360301 |
| | 77 | | Fitting Position: Front Axle Right | | 24.0711-5272.3 360302 |
| 2.0 TDI | 62 - 09/09→08/15 | | Fitting Position: Rear Axle Left | | 24.0711-5271.3 360301 |
| 2.0 TDI 4motion | 100 - 10/09→08/15 | | Fitting Position: Rear Axle Right | | 24.0711-5272.3 360302 |
| | 132 | | | | |
| 2.0 TSI | 110 - 05/11→08/15 | | | | |
| | 150 | | | | |
| 2.0 TSI 4motion | 150 07/11→08/15 | | | | |
| 2.5 TDi | 120 05/07→11/09 | | | | |
| 2.5 TDI | 96 - 05/07→11/09 | | | | |
| | 128 | | | | |
| 2.5 TDI 4motion | 96 - 05/07→11/09 | | | | |
| | 128 | | | | |
|  Cable Pull, parking brake | | | | | |
| 1.9 TDI | 63 - 05/07→11/09 | | for PR number: 0E1 / 0E2 / 0WL / 0WN / 0WM / 0WP / 0WQ; Required quantity: 2; Brake Type: Disc Brake; Fitting Position: Rear | 2 | 24.3727-0184.2 580184 Length [mm]: 1,303 |
| | 77 | | | | |
| 2.0 TDI | 62 - 09/09→08/15 | | | | |
| | 132 | | | | |
| 2.5 TDi | 120 05/07→11/09 | | Vehicle Identification Number from: 7H-7-000001 →; | 2 | 24.3727-3409.2 583409 Length [mm]: 1,570 |
| 2.5 TDI | 96 - 05/07→11/09 | | for PR number: 0WR / 0E1; Required quantity: 2; Fitting Position: Rear | | |
| | 128 | | | | |
| 2.0 TDI | 84 05/11→08/15 | | Brake Type: Disc Brake; for PR number: G0C / G0K / G1C; Required quantity: 2; Fitting Position: Rear | 2 | 24.3727-0184.2 580184 Length [mm]: 1,303 |
| 2.0 TSI | 110 - 05/11→08/15 | | | | |
| | 150 | | | | |
| 2.0 TSI 4motion | 150 07/11→08/15 | | | | |
| 2.0 TDI 4motion | 100 - 10/09→08/15 | | Vehicle Identification Number from: 7H-A-200001 →; Brake Type: Disc Brake; for PR number: G0C / G0K / G1C; Required quantity: 2; Fitting Position: Rear | 2 | 24.3727-0184.2 580184 Length [mm]: 1,303 |
| | 132 | | | | |
| 2.5 TDI 4motion | 96 - 05/07→11/09 | | | | |
| | 128 | | Vehicle Identification Number from: 7H-7-000001 →; for PR number: 0WR / 0E1; Required quantity: 2; Fitting Position: Rear | 2 | 24.3727-3409.2 583409 Length [mm]: 1,570 |
| VW - CALIFORNIA T6 Camper (SGC, SGG, SHC) 04/15→ | | | | | |
| Warning Contact, brake pad wear | | | | | |
| 2.0 TDI | 62 - 04/15→ | | Required quantity: 1; Construction year from: 07/19 →; | 1 | 24.8190-0831.2 620831 |
| | 150 | | Fitting Position: Front Axle | | |
| 2.0 TDI 4motion | 103 - 06/15→ | | | | |
| | 150 | | | | |
| → | | | | | |





| | kW | | | |
|---|--------------------------|---|---|-----------------------|
| VW - CALIFORNIA T6 Camper (SGC, SGG, SHC) 04/15→ | | | | |
| Warning Contact, brake pad wear | | | | |
| 2.0 TSI | 110 - 04/15→07/19 150 | Required quantity: 1; Construction year from: 07/19 →; Fitting Position: Rear Axle | 1 | 24.8190-0831.2 620831 |
| 2.0 TSI 4motion | 150 06/15→07/19 | | | |
| 2.0 TDI | 66 - 07/19→ 81 | Required quantity: 1; Fitting Position: Front Axle | 1 | 24.8190-0831.2 620831 |
| | | Required quantity: 1; Fitting Position: Rear Axle | 1 | 24.8190-0831.2 620831 |
|  Wheel Speed Sensor | | | | |
| 2.0 TDI | 62 - 04/15→12/19 132 | Fitting Position: Front Axle Left | | 24.0711-5271.3 360301 |
| 2.0 TDI 4motion | 103 - 06/15→12/19 132 | Fitting Position: Front Axle Right | | 24.0711-5272.3 360302 |
| 2.0 TSI | 110 - 04/15→07/19 150 | | | |
| 2.0 TSI 4motion | 150 06/15→07/19 | | | |
| 2.0 TDI | 66 - 04/15→ 150 | → Construction year to: 07/20; Fitting Position: Front Axle Left | | 24.0711-5271.3 360301 |
| 2.0 TDI 4motion | 110 - 06/15→ 150 | → Construction year to: 07/20; Fitting Position: Front Axle Right | | 24.0711-5272.3 360302 |
| VW - CC B7 (358) 11/11→12/16 | | | | |
|  Wheel Speed Sensor | | | | |
| 1.4 TSI | 110 - 11/11→12/16 118 | Fitting Position: Front Axle Left | | 24.0711-5271.3 360301 |
| 1.4 TSI MultiFuel | 118 11/11→12/16 | Fitting Position: Front Axle Right | | 24.0711-5272.3 360302 |
| 1.8 TSI | 112 - 11/11→12/16 118 | | | |
| 2.0 TDI | 100 - 11/11→12/16 135 | | | |
| 2.0 TDI 4motion | 103 - 11/11→12/16 130 | | | |
| 2.0 TFSI | 147 11/11→12/16 | | | |
| 2.0 TSI | 155 11/11→12/16 | | | |
| 3.6 FSI 4motion | 220 11/11→12/16 | | | |
| VW - CRAFTER Bus (SYI, SYJ) 09/16→ | | | | |
| Warning Contact, brake pad wear | | | | |
| 2.0 TDI | 75 - 09/16→ 103 | Required quantity: 1; for PR number: 1LA / 1LB / 1LC; Fitting Position: Front Axle | 1 | 24.8190-0831.2 620831 |
| 2.0 TDI 4motion | 103 - 03/17→ 130 | | | |
| 2.0 TDI | 130 09/16→ | Required quantity: 1; Construction year from: 07/19 →; Fitting Position: Front Axle | 1 | 24.8190-0831.2 620831 |
| | | Required quantity: 1; Construction year from: 07/19 →; Fitting Position: Rear Axle | 1 | 24.8190-0831.2 620831 |
|  Wheel Speed Sensor | | | | |
| 2.0 TDI | 75 - 09/16→ 130 | → Construction year to: 07/20; Fitting Position: Front Axle Left | | 24.0711-5271.3 360301 |
| 2.0 TDI 4motion | 103 - 03/17→ 130 | → Construction year to: 07/20; Fitting Position: Front Axle Right | | 24.0711-5272.3 360302 |
| VW - CRAFTER Platform/Chassis (SZ_) 11/16→ | | | | |
| Warning Contact, brake pad wear | | | | |
| 2.0 TDI | 75 - 11/16→ 130 | Required quantity: 1; for PR number: 1LA / 1LB / 1LC; Fitting Position: Front Axle | 1 | 24.8190-0831.2 620831 |
| 2.0 TDI 4motion | 103 - 03/17→ 130 | | | |
| 2.0 TDI RWD | 80 - 11/16→ 130 | | | |
|  Wheel Speed Sensor | | | | |
| 2.0 TDI | 75 - 11/16→ 130 | → Construction year to: 07/20; Fitting Position: Front Axle Left | | 24.0711-5271.3 360301 |
| 2.0 TDI 4motion | 103 - 03/17→ 130 | → Construction year to: 07/20; Fitting Position: Front Axle Right | | 24.0711-5272.3 360302 |
| 2.0 TDI RWD | 80 - 11/16→ 130 | | | |







| | kW | | | |
|---|--------------------------|--|---|-----------------------|
| VW - CRAFTER Van (SY_, SX_) 09/16→ | | | | |
| Warning Contact, brake pad wear | | | | |
| 2.0 TDI | 75 - 09/16→ 130 | Required quantity: 1; for PR number: 1LA / 1LB / 1LC; Fitting Position: Front Axle | 1 | 24.8190-0831.2 620831 |
| 2.0 TDI 4motion | 103 - 03/17→ 130 | | | |
| 2.0 TDI RWD | 80 - 05/17→ 130 | | | |
| e-Crafter | 100 07/18→ | Required quantity: 1; Construction year from: 07/19 →; Fitting Position: Front Axle | 1 | 24.8190-0831.2 620831 |
| | | Required quantity: 1; Construction year from: 07/19 →; Fitting Position: Rear Axle | 1 | 24.8190-0831.2 620831 |
|  Wheel Speed Sensor | | | | |
| 2.0 TDI | 75 - 09/16→ 130 | → Construction year to: 07/20; Fitting Position: Front Axle Left | | 24.0711-5271.3 360301 |
| 2.0 TDI 4motion | 103 - 03/17→ 130 | → Construction year to: 07/20; Fitting Position: Front Axle Right | | 24.0711-5272.3 360302 |
| 2.0 TDI RWD | 80 - 05/17→ 130 | | | |
| e-Crafter | 100 07/18→ | | | |
| VW - EOS (1F7, 1F8) 03/06→08/15 | | | | |
|  Wheel Speed Sensor | | | | |
| 1.4 TSI | 90 - 11/07→08/15 118 | Fitting Position: Front Axle Left | | 24.0711-5271.3 360301 |
| 1.6 FSI | 85 06/06→05/08 | Fitting Position: Front Axle Right | | 24.0711-5272.3 360302 |
| 2.0 TDI | 100 - 06/06→08/15 103 | for PR number: 7X0 / 7X1; Fitting Position: Rear Axle Left | | 24.0711-5271.3 360301 |
| 2.0 TDI 16V | 103 05/08→08/15 | for PR number: 7X0 / 7X1; Fitting Position: Rear Axle Right | | 24.0711-5272.3 360302 |
| 2.0 TSI | 155 11/09→08/15 | | | |
| 3.2 V6 | 184 06/06→05/09 | | | |
| 3.6 V6 | 191 05/09→11/10 | | | |
| 2.0 FSI | 110 03/06→05/08 | Construction year from: 05/06 →; Fitting Position: Front Axle Left | | 24.0711-5271.3 360301 |
| 2.0 TFSI | 147 03/06→08/15 | Construction year from: 05/06 →; Fitting Position: Front Axle Right | | 24.0711-5272.3 360302 |
| | | Construction year from: 05/06 →; for PR number: 7X0 / 7X1; Fitting Position: Rear Axle Left | | 24.0711-5271.3 360301 |
| | | Construction year from: 05/06 →; for PR number: 7X0 / 7X1; Fitting Position: Rear Axle Right | | 24.0711-5272.3 360302 |
| VW - GOLF IV (9B3) 03/06→ | | | | |
|  Wheel Speed Sensor | | | | |
| 1.6 | 74 03/07→12/10 | Fitting Position: Front Axle Left | | 24.0711-5271.3 360301 |
| 1.6 Total Flex | 74 - 03/07→06/14 77 | Fitting Position: Front Axle Right | | 24.0711-5272.3 360302 |
| 1.8 GTI | 132 - 01/07→12/10 142 | | | |
| 2.0 | 85 01/07→12/10 | | | |
| VW - GOLF V (1K1) 10/03→07/10 | | | | |
|  Wheel Speed Sensor | | | | |
| 1.4 16V | 55 10/03→05/06 | Fitting Position: Front Axle Left | | 24.0711-5271.3 360301 |
| 1.4 FSI | 66 10/03→07/06 | Fitting Position: Front Axle Right | | 24.0711-5272.3 360302 |
| 1.6 FSI | 85 10/03→07/08 | | | |
| 1.4 16V | 59 05/06→11/08 | → Construction year to: 09/08; Fitting Position: Front Axle Left | | 24.0711-5271.3 360301 |
| 1.4 TSI | 90 - 11/05→11/08 125 | → Construction year to: 09/08; Fitting Position: Front Axle Right | | 24.0711-5272.3 360302 |
| 1.6 | 75 01/04→11/08 | | | |
| 1.6 MultiFuel | 75 10/07→11/08 | | | |
| 1.9 TDI | 66 - 10/03→11/08 77 | | | |
| 2.0 | 85 01/05→11/08 | | | |
| 2.0 FSI | 110 01/04→11/08 | | | |
| 2.0 GTI | 147 - 10/04→02/09 169 | | | |
| 2.0 SDI | 55 01/04→11/08 | | | |
| 2.0 TDI | 100 - 10/03→11/08 125 | | | |
| 2.0 TDI 16V | 103 10/03→11/08 | | | |
| 2.5 | 125 05/07→11/08 | | | |
| 1.9 TDI 4motion | 77 08/04→11/08 | Construction year from: 08/06 → → Construction year to: 09/08; Fitting Position: Front Axle Left | | 24.0711-5271.3 360301 |
| → | | | | |







| | kW | | | |
|---|-----------|-------------|---|------------------------------|
| VW - GOLF V (1K1) 10/03→07/10 | | | | |
|  Wheel Speed Sensor | | | | |
| 1.9 TDI 4motion | 77 | 08/04→11/08 | → Construction year to: 09/08; Fitting Position: Front Axle Left | 24.0711-5271.3 360301 |
| | | | Construction year from: 08/06 → → Construction year to: 09/08; Fitting Position: Front Axle Right | 24.0711-5272.3 360302 |
| | | | → Construction year to: 09/08; Fitting Position: Front Axle Right | 24.0711-5272.3 360302 |
| | | | → Construction year to: 09/08; Fitting Position: Rear Axle Left | 24.0711-5271.3 360301 |
| | | | → Construction year to: 09/08; Fitting Position: Rear Axle Right | 24.0711-5272.3 360302 |
| 2.0 FSI 4motion | 110 | 08/04→11/08 | → Construction year to: 09/08; Fitting Position: Front Axle Left | 24.0711-5271.3 360301 |
| 2.0 TDI 16V 4motion | 103 | 08/04→11/08 | | |
| 2.0 TDI 4motion | 103 | 01/07→11/08 | → Construction year to: 09/08; Fitting Position: Front Axle Right | 24.0711-5272.3 360302 |
| 3.2 R32 4motion | 184 | 11/05→11/08 | | |
| | | | → Construction year to: 09/08; Fitting Position: Rear Axle Left | 24.0711-5271.3 360301 |
| | | | → Construction year to: 09/08; Fitting Position: Rear Axle Right | 24.0711-5272.3 360302 |
| VW - GOLF V Variant (1K5) 01/07→07/09 | | | | |
|  Wheel Speed Sensor | | | | |
| 1.4 | 59 | 06/07→07/09 | → Construction year to: 06/09; Fitting Position: Front Axle Left | 24.0711-5271.3 360301 |
| 1.4 TSI | 90 - 125 | 06/07→07/09 | | |
| | | | → Construction year to: 06/09; Fitting Position: Front Axle Right | 24.0711-5272.3 360302 |
| 1.6 | 75 | 06/07→07/09 | | |
| 1.6 MultiFuel | 75 | 11/07→07/09 | | |
| 1.9 TDI | 77 | 06/07→07/09 | | |
| 1.9 TDI 4motion | 77 | 01/08→07/09 | | |
| 2.0 TDI | 96 - 103 | 06/07→07/09 | | |
| 2.0 TDI 16V | 103 | 06/07→07/09 | | |
| 2.0 TFSI | 147 | 06/07→07/09 | | |
| VW - GOLF VI (5K1) 10/08→12/14 | | | | |
|  Wheel Speed Sensor | | | | |
| 1.2 TSI | 63 | 05/10→11/12 | Fitting Position: Front Axle Left | 24.0711-5271.3 360301 |
| 1.4 | 59 | 10/08→11/12 | | |
| 1.4 TSI | 90 - 118 | 10/08→11/12 | Fitting Position: Front Axle Right | 24.0711-5272.3 360302 |
| | | | | |
| 1.6 | 75 | 10/08→11/12 | | |
| 1.6 BiFuel | 75 | 03/09→11/12 | | |
| 1.6 MultiFuel | 75 | 10/08→11/12 | | |
| 1.6 TDI | 66 - 77 | 02/09→11/12 | | |
| | | | | |
| 1.8 TSI | 118 | 06/09→01/11 | | |
| 2.0 GTI | 147 - 173 | 04/09→11/13 | | |
| | | | | |
| 2.0 TDI | 81 - 125 | 10/08→05/13 | | |
| | | | | |
| 2.5 | 125 | 07/09→05/13 | | |
| 1.2 TSI | 77 | 11/08→11/12 | Construction year from: 05/09 →; Fitting Position: Front Axle Left | 24.0711-5271.3 360301 |
| | | | Construction year from: 05/09 →; Fitting Position: Front Axle Right | 24.0711-5272.3 360302 |
| 2.0 R 4motion | 188 - 199 | 11/09→11/13 | Fitting Position: Front Axle Left | 24.0711-5271.3 360301 |
| | | | Fitting Position: Front Axle Right | 24.0711-5272.3 360302 |
| 2.0 TDI 4motion | 103 | 05/09→11/12 | | |
| 2.0 TFSI 4motion | 191 | 09/11→11/13 | Fitting Position: Rear Axle Left | 24.0711-5271.3 360301 |
| | | | Fitting Position: Rear Axle Right | 24.0711-5272.3 360302 |
| VW - GOLF VI Convertible (517) 03/11→05/16 | | | | |
|  Wheel Speed Sensor | | | | |
| 1.2 TSI | 77 | 03/11→05/16 | Construction year from: 06/11 →; | 24.0711-5271.3 360301 |
| 1.4 TSI | 118 | 03/11→05/16 | Fitting Position: Front Axle Left | |
| 1.6 TDI | 77 | 03/11→05/16 | Construction year from: 06/11 →; | 24.0711-5272.3 360302 |
| | | | Fitting Position: Front Axle Right | |
| 1.2 TSI 16V | 77 | 11/13→05/16 | Fitting Position: Front Axle Left | 24.0711-5271.3 360301 |
| 1.4 TSI | 90 - 110 | 11/11→05/16 | Fitting Position: Front Axle Right | 24.0711-5272.3 360302 |
| | | | | |
| 2.0 GTI | 155 | 05/12→05/16 | | |
| 2.0 R | 195 | 01/13→05/16 | | |
| 2.0 TDI | 81 - 110 | 11/11→05/16 | | |
| | | | | |
| 2.0 TSI | 162 | 11/13→05/16 | | |





| | kW | | | |
|--|-------------------|---|-----------------------|--|
| VW - GOLF VI Van (5K1_) 10/08→11/12 | | | | |
|  Wheel Speed Sensor | | | | |
| 1.2 TSi | 63 05/10→11/12 | Fitting Position: Front Axle Left | 24.0711-5271.3 | 360301 |
| 1.2 TSi BlueMotion | 77 05/09→11/12 | Fitting Position: Front Axle Right | 24.0711-5272.3 | 360302 |
| 1.4 TSi | 118 10/08→11/12 | | | |
| 1.6 TDi | 66 02/09→11/12 | | | |
| 1.6 TDi BlueMotion | 77 05/09→11/12 | | | |
| 2.0 GTi | 155 02/09→11/12 | | | |
| 2.0 TDi | 103 - 09/09→11/12 | | | |
| | 125 | | | |
| TSi | 90 10/08→11/12 | | | |
| 2.0 TSi R 4motion | 199 11/09→11/12 | Fitting Position: Front Axle Left | 24.0711-5271.3 | 360301 |
| | | Fitting Position: Front Axle Right | 24.0711-5272.3 | 360302 |
| | | Fitting Position: Rear Axle Left | 24.0711-5271.3 | 360301 |
| | | Fitting Position: Rear Axle Right | 24.0711-5272.3 | 360302 |
| VW - GOLF VI Variant (AJ5) 07/09→07/14 | | | | |
|  Wheel Speed Sensor | | | | |
| 1.2 TSi | 63 - 07/09→07/13 | Fitting Position: Front Axle Left | 24.0711-5271.3 | 360301 |
| | 77 | Fitting Position: Front Axle Right | 24.0711-5272.3 | 360302 |
| 1.4 | 59 07/09→07/13 | | | |
| 1.4 TSi | 90 - 07/09→07/13 | | | |
| | 118 | | | |
| 1.6 | 75 07/09→07/13 | | | |
| 1.6 BiFuel | 75 07/09→12/10 | | | |
| 1.6 MultiFuel | 75 07/10→07/13 | | | |
| 1.6 TDI | 66 - 07/09→07/13 | | | |
| | 77 | | | |
| 1.6 TDI 4motion | 77 07/09→07/13 | | | |
| 2.0 TDI | 81 - 07/09→07/13 | | | |
| | 103 | | | |
| 2.0 TFSI | 147 07/09→07/13 | | | |
| VW - GOLF VII (5G1, BQ1, BE1, BE2) 08/12→ | | | | |
|  Brake Pad Set, disc brake | | | | |
| 1.0 TSi | 63 - 05/15→ | for PR number: 1ZA / 1ZB / 1ZD / 1ZE / 1ZP / 1LV / 1ZC / 1ZG; | 13.0470-2785.2 | LD2785 Brake System: Lucas / TRW 25683 20,4 |
| 1.2 TSi | 77 - 11/12→ | Fitting Position: Front Axle | | Wear Warning Contact: prepared for wear indicator / incl. wear warning contact Ceramic |
| 1.4 GTE Hybrid | 110 05/14→ | | | |
| 1.4 TSi | 92 - 05/14→ | | | |
| | 110 | | | |
| 1.4 TSi MultiFuel | 90 - 04/13→ | | | |
| | 92 | | | |
| 1.5 TGI | 96 11/18→ | | | |
| 1.5 TSi | 96 - 04/17→ | | | |
| | 110 | | | |
| 1.6 | 81 05/14→07/17 | | | |
| 1.6 TDI | 66 - 04/13→08/20 | | | |
| | 85 | | | |
| 1.6 TDI 4motion | 77 - 11/12→ | | | |
| | 81 | | | |
| 2.0 GTD | 135 04/13→ | | | |
| 2.0 GTI | 155 - 04/13→ | | | |
| | 180 | | | |
| 2.0 GTI Clubsport | 195 02/16→03/17 | | | |
| 2.0 GTI TCR | 213 11/18→ | | | |
| 2.0 R 4motion | 206 - 11/13→ | | | |
| | 221 | | | |
| 2.0 TDI | 81 - 08/12→ | | | |
| | 110 | | | |
| 2.0 TDI 4motion | 110 11/12→08/20 | | | |
| 1.2 TSi | 63 08/12→03/17 | Construction year from: 11/12 →; | 13.0470-2785.2 | LD2785 Brake System: Lucas / TRW 25683 20,4 |
| 1.4 TSi | 103 08/12→03/17 | for PR number: 1ZA / 1ZB / 1ZD / 1ZE / 1ZP / 1LV / 1ZC / 1ZG; | | Wear Warning Contact: prepared for wear indicator / incl. wear warning contact Ceramic |
| 1.6 TDI | 77 08/12→03/17 | Fitting Position: Front Axle | | |
| 1.4 TGI CNG | 81 06/13→ | Construction year from: 08/13 →; | 13.0470-2785.2 | LD2785 Brake System: Lucas / TRW 25683 20,4 |
| | | for PR number: 1ZA / 1ZB / 1ZD / 1ZE / 1ZP / 1LV / 1ZC / 1ZG; | | Wear Warning Contact: prepared for wear indicator / incl. wear warning contact Ceramic |
| | | Fitting Position: Front Axle | | |
| 1.4 TSi | 90 11/12→ | Construction year from: 06/13 →; | 13.0470-2785.2 | LD2785 Brake System: Lucas / TRW 25683 20,4 |
| 1.6 TDI | 81 01/13→ | for PR number: 1ZA / 1ZB / 1ZD / 1ZE / 1ZP / 1LV / 1ZC / 1ZG; | | Wear Warning Contact: prepared for wear indicator / incl. wear warning contact Ceramic |
| | | Fitting Position: Front Axle | | |
| → | | | | |

| | kW | | | | |
|--|--------------------------|---|--|------------------------------|--|
| VW - GOLF VII (5G1, BQ1, BE1, BE2) 08/12→ | | | | | |
|  Brake Pad Set, disc brake | | | | | |
| e-Golf | 85 03/14→02/17 | Construction year from: 08/14 →; for PR number: 1ZE / 1ZP; Fitting Position: Front Axle | | 13.0470-2785.2 LD2785 | Brake System: Lucas / TRW 25683 20,4 Wear Warning Contact: prepared for wear indicator / incl. wear warning contact Ceramic |
| e-Golf | 100 12/16→ | for PR number: 1ZE / 1ZP; Fitting Position: Front Axle | | 13.0470-2785.2 LD2785 | Brake System: Lucas / TRW 25683 20,4 Wear Warning Contact: prepared for wear indicator / incl. wear warning contact Ceramic |
|  Wheel Speed Sensor | | | | | |
| 1.6 TDI 4motion | 77 - 11/12→ 81 | Vehicle Equipment: for vehicles without parking assistant system; Fitting Position: Rear Axle Left | | 24.0711-5271.3 360301 | |
| 2.0 R 360S 4motion | 265 09/16→ | | | | |
| 2.0 R 4motion | 206 - 11/13→ 228 | Comfort Package: not for cruise control system; Fitting Position: Rear Axle Left | | 24.0711-5271.3 360301 | |
| 2.0 TDI 4motion | 110 11/12→08/20 | Vehicle Equipment: for vehicles without parking assistant system; Fitting Position: Rear Axle Right | | 24.0711-5272.3 360302 | |
| | | Comfort Package: not for cruise control system; Fitting Position: Rear Axle Right | | 24.0711-5272.3 360302 | |
| VW - GOLF VII Van (5G1) 08/12→ | | | | | |
|  Brake Pad Set, disc brake | | | | | |
| 1.2 TSi BlueMotion | 63 08/12→ | Construction year from: 11/12 →; for PR number: 1ZA / 1ZB / 1ZD / 1ZE / 1ZP / 1LV / 1ZC / 1ZG; Fitting Position: Front Axle | | 13.0470-2785.2 LD2785 | Brake System: Lucas / TRW 25683 20,4 Wear Warning Contact: prepared for wear indicator / incl. wear warning contact Ceramic |
| 1.4 TSi BlueMotion | 103 08/12→ | | | | |
| 1.6 TDi BlueMotion | 77 08/12→ | | | | |
| 1.2 TSi BlueMotion | 77 11/12→ | for PR number: 1ZA / 1ZB / 1ZD / 1ZE / 1ZP / 1LV / 1ZC / 1ZG; Fitting Position: Front Axle | | 13.0470-2785.2 LD2785 | Brake System: Lucas / TRW 25683 20,4 Wear Warning Contact: prepared for wear indicator / incl. wear warning contact Ceramic |
| 1.4 TSi BlueMotion | 90 05/13→ | | | | |
| 1.6 TDi BlueMotion | 66 - 04/13→ 81 | | | | |
| 2.0 GTD | 135 04/13→ | | | | |
| 2.0 GTI | 162 - 04/13→ 169 | | | | |
| 2.0 TDi BlueMotion | 110 05/13→ | | | | |
| 2.0 TDi BlueMotion 4motion | 110 05/13→ | | | | |
|  Wheel Speed Sensor | | | | | |
| 2.0 TDi BlueMotion 4motion | 110 05/13→ | Vehicle Equipment: for vehicles without parking assistant system; Fitting Position: Rear Axle Left | | 24.0711-5271.3 360301 | |
| | | Comfort Package: not for cruise control system; Fitting Position: Rear Axle Left | | 24.0711-5271.3 360301 | |
| | | Vehicle Equipment: for vehicles without parking assistant system; Fitting Position: Rear Axle Right | | 24.0711-5272.3 360302 | |
| | | Comfort Package: not for cruise control system; Fitting Position: Rear Axle Right | | 24.0711-5272.3 360302 | |
| VW - GOLF VII Variant (BA5, BV5) 04/13→ | | | | | |
|  Brake Pad Set, disc brake | | | | | |
| 1.0 TSI | 63 - 05/15→ 85 | for PR number: 1ZA / 1ZB / 1ZD / 1ZE / 1ZP / 1LV; Fitting Position: Front Axle | | 13.0470-2785.2 LD2785 | Brake System: Lucas / TRW 25683 20,4 Wear Warning Contact: prepared for wear indicator / incl. wear warning contact Ceramic |
| 1.2 TSI | 81 04/14→ | | | | |
| 1.4 TGI CNG | 81 09/13→ | | | | |
| 1.4 TSI | 92 - 05/14→ 110 | | | | |
| 1.4 TSI MultiFuel | 90 - 04/13→03/17 92 | | | | |
| 1.5 TSI | 96 - 04/17→ 110 | | | | |
| 1.6 | 81 05/14→03/17 | | | | |
| 1.6 TDI | 85 11/16→ | | | | |
| 1.8 TSI 4motion | 132 11/16→ | | | | |
| 2.0 GTD | 135 01/15→03/17 | | | | |
| 2.0 R 4motion | 206 - 03/15→07/18 221 | | | | |
| 1.2 TSI | 63 - 05/13→ 77 | Construction year from: 07/13 →; for PR number: 1ZA / 1ZB / 1ZD / 1ZE / 1ZP / 1LV; Fitting Position: Front Axle | | 13.0470-2785.2 LD2785 | Brake System: Lucas / TRW 25683 20,4 Wear Warning Contact: prepared for wear indicator / incl. wear warning contact Ceramic |
| 1.4 TSI | 90 - 05/13→ 103 | | | | |
| 1.6 TDI | 66 - 05/13→03/17 81 | | | | |
| → | | | | | |

| | kW | | | |
|--|------------------------|---|------------------------------|---|
| VW - GOLF VII Variant (BA5, BV5) 04/13→ | | | | |
|  Brake Pad Set, disc brake | | | | |
| 1.6 TDI 4motion | 77 - 05/13→03/17 81 | Construction year from: 07/13 →; for PR number: 1ZA / 1ZB / 1ZD / 1ZE / 1ZP / 1LV; Fitting Position: Front Axle | 13.0470-2785.2 LD2785 | Brake System: Lucas / TRW 25683 20,4 Wear Warning Contact: prepared for wear indicator / incl. wear warning contact Ceramic |
| 2.0 TDI | 81 - 04/13→ 110 | | | |
| 2.0 TDI 4motion | 110 04/13→05/18 | | | |
| 1.5 TGI | 96 12/18→ | for PR number: 1ZA / 1ZB / 1ZD / 1ZE / 1ZP / 1LV / 1ZC / 1ZG; Fitting Position: Front Axle | 13.0470-2785.2 LD2785 | Brake System: Lucas / TRW 25683 20,4 Wear Warning Contact: prepared for wear indicator / incl. wear warning contact Ceramic |
|  Wheel Speed Sensor | | | | |
| 1.6 TDI 4motion | 77 - 05/13→03/17 81 | Construction year from: 07/13 →; Vehicle Equipment: for vehicles without parking assistant system; Fitting Position: Rear Axle Left | 24.0711-5271.3 360301 | |
| 2.0 TDI 4motion | 110 04/13→05/18 | | | |
| | | Construction year from: 07/13 →; Comfort Package: not for cruise control system; Fitting Position: Rear Axle Left | | |
| | | Construction year from: 07/13 →; Vehicle Equipment: for vehicles without parking assistant system; Fitting Position: Rear Axle Right | | |
| | | Construction year from: 07/13 →; Comfort Package: not for cruise control system; Fitting Position: Rear Axle Right | 24.0711-5272.3 360302 | |
| 2.0 R 360S 4motion | 265 09/16→ | Vehicle Equipment: for vehicles without parking assistant system; Fitting Position: Rear Axle Left | 24.0711-5271.3 360301 | |
| 2.0 R 4motion | 206 - 03/15→ 228 | | | |
| | | Comfort Package: not for cruise control system; Fitting Position: Rear Axle Left | | |
| | | Vehicle Equipment: for vehicles without parking assistant system; Fitting Position: Rear Axle Right | | |
| | | Comfort Package: not for cruise control system; Fitting Position: Rear Axle Right | 24.0711-5272.3 360302 | |
| VW - GOLF VIII (CD1) 07/19→ | | | | |
|  Brake Pad Set, disc brake | | | | |
| 1.0 eTSI | 81 06/20→ | for PR number: 1ZE / 1ZJ / 1ZP / 1ZQ; Fitting Position: Front Axle | 13.0470-2785.2 LD2785 | Brake System: Lucas / TRW 25683 20,4 Wear Warning Contact: prepared for wear indicator / incl. wear warning contact Ceramic |
| 1.5 eTSI | 96 - 12/19→ 110 | | | |
| 1.0 TSI | 66 - 02/20→ 81 | for PR number: 1ZK / 1ZU; Fitting Position: Front Axle | 13.0470-2785.2 LD2785 | Brake System: Lucas / TRW 25683 20,4 Wear Warning Contact: prepared for wear indicator / incl. wear warning contact Ceramic |
| 1.4 GTE Plug-in Hybrid | 110 - 07/20→ 180 | | | |
| 1.4 TSI eHybrid | 110 - 07/20→ 150 | | | |
| 1.5 TGI | 96 09/20→ | | | |
| 1.5 TSI | 96 - 07/19→ 110 | | | |
| 2.0 GTI | 180 08/20→ | | | |
| 2.0 GTI Clubsport | 221 10/20→ | | | |
| 2.0 TDI | 85 - 08/19→ 110 | | | |
| 2.0 TDI 4motion | 110 - 09/20→ 147 | | | |
| 2.0 TDI GTD | 147 09/20→ | | | |
| 2.0 TSI | 140 06/21→ | | | |
| 2.0 TSI 4motion | 140 06/21→ | | | |
| VW - GOLF VIII Variant (CG5) 08/20→ | | | | |
|  Brake Pad Set, disc brake | | | | |
| 1.0 eTSI | 81 09/20→ | for PR number: 1ZE / 1ZJ / 1ZP / 1ZQ; Fitting Position: Front Axle | 13.0470-2785.2 LD2785 | Brake System: Lucas / TRW 25683 20,4 Wear Warning Contact: prepared for wear indicator / incl. wear warning contact Ceramic |
| 1.5 eTSI | 96 - 12/20→ 110 | | | |
| 1.0 TSI | 66 - 08/20→ 81 | for PR number: 1ZK / 1ZU; Fitting Position: Front Axle | 13.0470-2785.2 LD2785 | Brake System: Lucas / TRW 25683 20,4 Wear Warning Contact: prepared for wear indicator / incl. wear warning contact Ceramic |
| 1.5 TGI | 96 09/20→ | | | |
| 1.5 TSI | 96 - 08/20→ 110 | | | |
| 2.0 GTI | 180 09/20→ | | | |

| | kW | | | |
|--|-------------------------|---|------------------------------|---|
| VW - GOLF VIII Variant (CG5) 08/20→ | | | | |
|  Brake Pad Set, disc brake | | | | |
| 2.0 TDI | 85 - 08/20→ 110 | for PR number: 1ZK / 1ZU; Fitting Position: Front Axle | 13.0470-2785.2 LD2785 | Brake System: Lucas / TRW 25683 20,4 Wear Warning Contact: prepared for wear indicator / incl. wear warning contact Ceramic |
| 2.0 TDI 4motion | 110 - 09/20→ 147 | | | |
| 2.0 TSI | 140 06/21→ | | | |
| 2.0 TSI 4motion | 140 06/21→ | | | |
| VW - GOLF ALLTRACK VII Variant (BA5, BV5) 12/14→ | | | | |
|  Brake Pad Set, disc brake | | | | |
| 1.6 TDI 4motion | 81 12/14→ | for PR number: 1ZA / 1ZB / 1ZD / 1ZE / 1ZP / 1LV; Fitting Position: Front Axle | 13.0470-2785.2 LD2785 | Brake System: Lucas / TRW 25683 20,4 Wear Warning Contact: prepared for wear indicator / incl. wear warning contact Ceramic |
| 1.8 TSI 4motion | 132 12/14→ | | | |
| 2.0 TDI 4motion | 110 - 12/14→ 135 | | | |
|  Wheel Speed Sensor | | | | |
| 1.6 TDI 4motion | 81 12/14→ | Vehicle Equipment: for vehicles without parking assistant system; Fitting Position: Rear Axle Left | 24.0711-5271.3 360301 | |
| 1.8 TSI 4motion | 132 12/14→ | | | |
| 2.0 TDI 4motion | 110 - 12/14→ 135 | Comfort Package: not for cruise control system; Fitting Position: Rear Axle Left | 24.0711-5271.3 360301 | |
| | | Vehicle Equipment: for vehicles without parking assistant system; Fitting Position: Rear Axle Right | 24.0711-5272.3 360302 | |
| | | Comfort Package: not for cruise control system; Fitting Position: Rear Axle Right | 24.0711-5272.3 360302 | |
| VW - GOLF ALLTRACK VIII (CG5) 11/20→ | | | | |
|  Brake Pad Set, disc brake | | | | |
| 2.0 TDI 4motion | 147 11/20→ | for PR number: 1ZK / 1ZU; Fitting Position: Front Axle | 13.0470-2785.2 LD2785 | Brake System: Lucas / TRW 25683 20,4 Wear Warning Contact: prepared for wear indicator / incl. wear warning contact Ceramic |
| VW - GOLF Hatchback Van (1K1) 07/03→ | | | | |
|  Wheel Speed Sensor | | | | |
| TDI | 77 11/03→02/06 | Fitting Position: Front Axle Left | 24.0711-5271.3 360301 | |
| | | Fitting Position: Front Axle Right | 24.0711-5272.3 360302 | |
| VW - GOLF PLUS V (5M1, 521) 12/04→12/13 | | | | |
|  Wheel Speed Sensor | | | | |
| 1.2 TSI | 63 - 11/09→12/13 77 | Fitting Position: Front Axle Left | 24.0711-5271.3 360301 | |
| 1.4 16V | 55 - 01/05→12/13 59 | Fitting Position: Front Axle Right | 24.0711-5272.3 360302 | |
| 1.4 FSI | 66 07/05→11/06 | | | |
| 1.4 TSI | 90 - 05/06→12/13 125 | | | |
| 1.6 | 75 05/05→12/13 | | | |
| 1.6 BiFuel | 75 05/09→12/13 | | | |
| 1.6 FSI | 85 12/04→05/08 | | | |
| 1.6 MultiFuel | 75 11/07→12/13 | | | |
| 1.6 TDI | 66 - 02/09→12/13 77 | | | |
| 1.9 TDI | 66 - 01/05→01/09 77 | | | |
| 2.0 FSI | 110 05/05→06/08 | | | |
| 2.0 TDI | 81 - 05/05→12/13 103 | | | |
| 2.0 TDI 16V | 103 01/05→12/13 | | | |
| VW - GOLF PLUS Van (521) 01/09→08/14 | | | | |
|  Wheel Speed Sensor | | | | |
| 1.2 TSi | 77 11/09→08/14 | Fitting Position: Front Axle Left | 24.0711-5271.3 360301 | |
| 1.4 TSi | 90 - 01/09→08/14 118 | Fitting Position: Front Axle Right | 24.0711-5272.3 360302 | |
| 1.6 TDi | 66 - 02/09→08/14 77 | | | |
| 2.0 TDi | 103 11/09→08/14 | | | |



| | kW | | | |
|---|-------------------------|---|--------------------------------|---|
| VW - GOLF SPORTSVAN VII (AM1, AN1) 02/14→ | | | | |
|  Brake Pad Set, disc brake | | | | |
| 1.0 TSI | 63 - 05/15→ 85 | for PR number: 1ZA / 1ZE / 1ZP; Fitting Position: Front Axle | 13.0470-2785.2 LD2785 | Brake System: Lucas / TRW 25683 20,4 Wear Warning Contact: prepared for wear indicator / incl. wear warning contact Ceramic |
| 1.2 TSI | 63 - 04/14→ 81 | | | |
| 1.4 TSI | 92 04/14→ | | | |
| 1.4 TSI MultiFuel | 92 04/14→ | | | |
| 1.5 TSI | 96 - 05/17→ 110 | | | |
| 1.6 | 81 05/14→ | | | |
| 1.6 TDI | 66 02/14→ | | | |
| 2.0 TDI | 81 05/14→11/17 | | | |
| 1.4 TSI | 110 02/14→ | Construction year from: 05/14 →; for PR number: 1ZA / 1ZE / 1ZP; Fitting Position: Front Axle | 13.0470-2785.2 LD2785 | Brake System: Lucas / TRW 25683 20,4 Wear Warning Contact: prepared for wear indicator / incl. wear warning contact Ceramic |
| 1.6 TDI | 81 02/14→ | | | |
| 2.0 TDI | 110 02/14→ | | | |
| 1.6 TDI | 85 11/16→ | for PR number: 1ZA / 1ZE; Fitting Position: Front Axle | 13.0470-2785.2 LD2785 | Brake System: Lucas / TRW 25683 20,4 Wear Warning Contact: prepared for wear indicator / incl. wear warning contact Ceramic |
| VW - GOLF VAN VI Variant (AJ5) 07/09→05/14 | | | | |
|  Wheel Speed Sensor | | | | |
| 1.2 TSi | 77 09/09→05/14 | Fitting Position: Front Axle Left | 24.0711-5271.3 360301 | |
| 1.4 TSi | 90 - 07/09→05/14 118 | Fitting Position: Front Axle Right | 24.0711-5272.3 360302 | |
| 1.6 TDi | 66 12/09→10/12 | | | |
| 1.6 TDi BlueMotion | 77 07/09→05/14 | | | |
| 2.0 TDi | 103 07/09→05/14 | | | |
| VW - GOLF VAN VII Variant (BA5) 04/13→03/17 | | | | |
|  Brake Pad Set, disc brake | | | | |
| 1.2 TSi BlueMotion | 63 - 04/13→03/17 77 | for PR number: 1ZA / 1ZB / 1ZD / 1ZE / 1ZP / 1LV / 1ZC / 1ZG; Fitting Position: Front Axle | 13.0470-2785.2 LD2785 | Brake System: Lucas / TRW 25683 20,4 Wear Warning Contact: prepared for wear indicator / incl. wear warning contact Ceramic |
| 1.4 TSi BlueMotion | 90 - 05/13→03/17 103 | | | |
| 1.6 TDi BlueMotion | 66 - 05/13→03/17 81 | | | |
| 1.6 TDi BlueMotion 4motion | 77 05/13→03/17 | | | |
| 2.0 TDi BlueMotion | 110 04/13→03/17 | | | |
| 2.0 TDi BlueMotion 4motion | 110 04/13→03/17 | | | |
|  Wheel Speed Sensor | | | | |
| 1.6 TDi BlueMotion | 81 05/13→03/17 | Vehicle Equipment: for vehicles without parking assistant system; Fitting Position: Rear Axle Left | 24.0711-5271.3 360301 | |
| | | Comfort Package: not for cruise control system; Fitting Position: Rear Axle Left | 24.0711-5271.3 360301 | |
| | | Vehicle Equipment: for vehicles without parking assistant system; Fitting Position: Rear Axle Right | 24.0711-5272.3 360302 | |
| | | Comfort Package: not for cruise control system; Fitting Position: Rear Axle Right | 24.0711-5272.3 360302 | |
| VW - GRAND CALIFORNIA Camper (SCB, SCC) 04/19→ | | | | |
| Warning Contact, brake pad wear | | | | |
| 2.0 TDI | 103 - 04/19→ 130 | Required quantity: 1; for PR number: 1LA / 1LB / 1LC; Fitting Position: Front Axle | 1 24.8190-0831.2 620831 | |
| 2.0 TDI 4motion | 103 - 04/19→ 130 | | | |
|  Wheel Speed Sensor | | | | |
| 2.0 TDI | 103 - 04/19→ 130 | Fitting Position: Front Axle Left | 24.0711-5271.3 360301 | |
| 2.0 TDI 4motion | 103 - 04/19→ 130 | Fitting Position: Front Axle Right | 24.0711-5272.3 360302 | |
| VW - JETTA III (1K2) 09/04→12/13 | | | | |
|  Wheel Speed Sensor | | | | |
| 1.4 TSI | 90 - 07/06→10/10 125 | Fitting Position: Front Axle Left | 24.0711-5271.3 360301 | |
| 1.6 | 75 09/04→10/10 | Fitting Position: Front Axle Right | 24.0711-5272.3 360302 | |
| 1.6 FSI | 85 09/05→10/10 | | | |

| | kW | | | | |
|--|-----------|-------------|--|-----------------------|--|
| VW - JETTA III (1K2) 09/04→12/13 | | | | | |
|  Wheel Speed Sensor | | | | | |
| 1.6 MultiFuel | 75 | 01/08→10/10 | Fitting Position: Front Axle Left | 24.0711-5271.3 | 360301 |
| 1.6 TDI | 66 - 77 | 06/09→10/10 | Fitting Position: Front Axle Right | 24.0711-5272.3 | 360302 |
| 1.9 TDI | 74 - 77 | 08/05→10/10 | | | |
| 2.0 FSI | 110 | 08/05→10/10 | | | |
| 2.0 TDI | 100 - 125 | 09/05→10/10 | | | |
| 2.0 TDI 16V | 103 | 08/05→10/10 | | | |
| 2.0 TFSI | 147 | 10/05→10/10 | | | |
| 2.5 | 125 | 07/08→10/10 | | | |
| 2.5 | 110 | 01/06→10/10 | Construction year from: 07/08 →; Fitting Position: Front Axle Left | 24.0711-5271.3 | 360301 |
| | | | Construction year from: 07/08 →; Fitting Position: Front Axle Right | 24.0711-5272.3 | 360302 |
| VW - JETTA IV (162, 163, AV3, AV2) 01/08→ | | | | | |
|  Wheel Speed Sensor | | | | | |
| 1.2 TSI | 77 | 10/10→12/17 | Construction year from: 04/11 →; Fitting Position: Front Axle Left | 24.0711-5271.3 | 360301 |
| 1.6 TDI | 77 | 04/10→07/15 | | | |
| 2.0 TDI | 103 | 02/11→ | Construction year from: 04/11 →; Fitting Position: Front Axle Right | 24.0711-5272.3 | 360302 |
| 2.0 TFSI | 147 | 12/10→ | | | |
| 2.5 | 125 | 04/10→ | | | |
| 1.2 TSI 16V | 77 | 08/14→12/17 | Fitting Position: Front Axle Left | 24.0711-5271.3 | 360301 |
| 1.4 TSI | 90 - 118 | 04/11→ | Fitting Position: Front Axle Right | 24.0711-5272.3 | 360302 |
| 1.4 TSI Hybrid | 110 | 04/11→ | | | |
| 1.6 | 63 - 81 | 12/11→ | | | |
| 1.6 MPI | 66 | 09/15→04/18 | | | |
| 1.8 TSI | 125 | 07/14→ | | | |
| 2.0 | 85 | 06/10→12/17 | | | |
| 2.0 TDI | 81 - 110 | 10/10→ | | | |
| 2.0 TSI | 155 | 12/12→12/17 | | | |
| VW - JETTA VII Saloon (BU3) 12/17→ | | | | | |
|  Wheel Speed Sensor | | | | | |
| 1.4 TSI | 110 | 12/17→ | Fitting Position: Front Axle Left | 24.0711-5271.3 | 360301 |
| | | | Fitting Position: Front Axle Right | 24.0711-5272.3 | 360302 |
| VW - LOAD UP (121, 122, BL1, BL2) 12/14→ | | | | | |
|  Brake Pad Set, disc brake | | | | | |
| 1.0 | 44 | 12/14→11/19 | for PR number: 1ZE; | 13.0470-2785.2 | LD2785 |
| 1.0 EcoFuel | 50 | 12/14→08/20 | Construction year from: 05/16 →; | | |
| e-Load Up | 60 | 12/14→ | Fitting Position: Front Axle | | Brake System: Lucas / TRW 25683 20,4 Wear Warning Contact: prepared for wear indicator / incl. wear warning contact Ceramic |
| 1.0 BlueMotion | 55 | 05/16→11/19 | for PR number: 1ZE; | 13.0470-2785.2 | LD2785 |
| 1.0 TSi BlueMotion | 66 | 05/16→09/18 | Fitting Position: Front Axle | | Brake System: Lucas / TRW 25683 20,4 Wear Warning Contact: prepared for wear indicator / incl. wear warning contact Ceramic |
| VW - MULTIVAN V (7HM, 7HN, 7HF, 7EF, 7EM, 7EN) 04/03→08/15 | | | | | |
|  Brake Caliper | | | | | |
| 1.9 TDI | 62 - 75 | 01/06→11/09 | Vehicle Identification Number from: 7H-A-200001 →; for PR number: 2E4; Fitting Position: Front Axle Left | 24.3441-9933.5 | 241141 |
| | | | Vehicle Identification Number from: 7H-A-200001 →; for PR number: 2E4; Fitting Position: Front Axle Right | 24.3441-9934.5 | 241142 |
| | | | for PR number: 2E3; Fitting Position: Front Axle Left | 24.3601-9947.5 | 240597 |
| → | | | | | |



| | kW | | | | |
|--|--------------------------|--|------------------------------|--|--|
| VW - MULTIVAN V (7HM, 7HN, 7HF, 7EF, 7EM, 7EN) 04/03→08/15 | | | | | |
|  Brake Caliper | | | | | |
| 1.9 TDI | 62 - 01/06→11/09 75 | for PR number: 2E3; Fitting Position: Front Axle Right | 24.3601-9948.5 240598 | Brake System: ATE Supplementary Article/Supplementary Info: without holder Brake Caliper Type: Fist-type Caliper | |
| | | Vehicle Identification Number from: 7H-A-200001 →; Fitting Position: Rear Axle Left | 24.3414-1711.5 240852 | Brake System: Lucas / TRW Supplementary Article/Supplementary Info: without holder Brake Caliper Type: Fist-type Caliper | |
| | | Vehicle Identification Number from: 7H-6-000001 →; for PR number: 2E3 / 2E4; → Vehicle Identification Number to: 7H-A-050000; Fitting Position: Rear Axle Left | 24.3414-1711.5 240852 | Brake System: Lucas / TRW Supplementary Article/Supplementary Info: without holder Brake Caliper Type: Fist-type Caliper | |
| | | Vehicle Identification Number from: 7H-8-028000 →; for PR number: 0WR; → Vehicle Identification Number to: 7H-8-200000; Fitting Position: Rear Axle Left | 24.3414-1711.5 240852 | Brake System: Lucas / TRW Supplementary Article/Supplementary Info: without holder Brake Caliper Type: Fist-type Caliper | |
| | | Vehicle Identification Number from: 7H-A-200001 →; Fitting Position: Rear Axle Right | 24.3414-1712.5 240853 | Brake System: Lucas / TRW Supplementary Article/Supplementary Info: without holder Brake Caliper Type: Fist-type Caliper | |
| | | Vehicle Identification Number from: 7H-8-028000 →; for PR number: 0WR; → Vehicle Identification Number to: 7H-8-200000; Fitting Position: Rear Axle Right | 24.3414-1712.5 240853 | Brake System: Lucas / TRW Supplementary Article/Supplementary Info: without holder Brake Caliper Type: Fist-type Caliper | |
| | | Vehicle Identification Number from: 7H-6-000001 →; for PR number: 2E3 / 2E4; → Vehicle Identification Number to: 7H-A-050000; Fitting Position: Rear Axle Right | 24.3414-1712.5 240853 | Brake System: Lucas / TRW Supplementary Article/Supplementary Info: without holder Brake Caliper Type: Fist-type Caliper | |
| 1.9 TDI | 63 - 04/03→11/09 77 | Vehicle Identification Number from: 7H-A-200001 →; for PR number: 2E4; Fitting Position: Front Axle Left | 24.3441-9933.5 241141 | Brake System: ATE Supplementary Article/Supplementary Info: without holder Brake Caliper Type: Fist-type Caliper (2 pistons) | |
| 2.0 | 85 11/03→08/15 | | | | |
| 2.5 TDI | 96 - 04/03→11/09 128 | | | | |
| 2.5 TDI 4motion | 96 - 07/04→11/09 128 | Vehicle Identification Number from: 7H-A-200001 →; for PR number: 2E4; Fitting Position: Front Axle Right | 24.3441-9934.5 241142 | Brake System: ATE Supplementary Article/Supplementary Info: without holder Brake Caliper Type: Fist-type Caliper (2 pistons) | |
| 3.2 V6 | 170 - 02/04→12/09 173 | | | | |
| 3.2 V6 4motion | 173 07/04→12/09 | | | | |
| | | for PR number: 2E3; Fitting Position: Front Axle Left | 24.3601-9947.5 240597 | Brake System: ATE Supplementary Article/Supplementary Info: without holder Brake Caliper Type: Fist-type Caliper | |
| | | for PR number: 2E3; Fitting Position: Front Axle Right | 24.3601-9948.5 240598 | Brake System: ATE Supplementary Article/Supplementary Info: without holder Brake Caliper Type: Fist-type Caliper | |
| | | Vehicle Identification Number from: 7H-A-200001 →; Fitting Position: Rear Axle Left | 24.3414-1711.5 240852 | Brake System: Lucas / TRW Supplementary Article/Supplementary Info: without holder Brake Caliper Type: Fist-type Caliper | |
| | | for PR number: 0WL / 0WN / 0WM / 0WP / 0WQ; → Vehicle Identification Number to: 7H-5-120000; Fitting Position: Rear Axle Left | 24.3414-1711.5 240852 | Brake System: Lucas / TRW Supplementary Article/Supplementary Info: without holder Brake Caliper Type: Fist-type Caliper | |
| | | Vehicle Identification Number from: 7H-8-028000 →; for PR number: 0WR; → Vehicle Identification Number to: 7H-8-200000; Fitting Position: Rear Axle Left | 24.3414-1711.5 240852 | Brake System: Lucas / TRW Supplementary Article/Supplementary Info: without holder Brake Caliper Type: Fist-type Caliper | |
| | | Vehicle Identification Number from: 7H-6-000001 →; for PR number: 2E3 / 2E4; → Vehicle Identification Number to: 7H-A-050000; Fitting Position: Rear Axle Left | 24.3414-1711.5 240852 | Brake System: Lucas / TRW Supplementary Article/Supplementary Info: without holder Brake Caliper Type: Fist-type Caliper | |
| → | | | | | |

| | kW | | | | |
|--|-----|-------------|--|------------------------------|--|
| VW - MULTIVAN V (7HM, 7HN, 7HF, 7EF, 7EM, 7EN) 04/03→08/15 | | | | | |
|  Brake Caliper | | | | | |
| 1.9 TDI | 63 | 04/03→11/09 | for PR number: 0WL / 0WN / 0WM / 0WP / 0WQ; → Vehicle Identification Number to: 7H-5-120000; Fitting Position: Rear Axle Right | 24.3414-1712.5 240853 | Brake System: Lucas / TRW Supplementary Article/Supplementary Info: without holder Brake Caliper Type: Fist-type Caliper |
| 2.0 | 85 | 11/03→08/15 | | | |
| 2.5 TDI | 96 | 04/03→11/09 | | | |
| 2.5 TDI 4motion | 96 | 07/04→11/09 | Vehicle Identification Number from: 7H-A-200001 →; Fitting Position: Rear Axle Right | 24.3414-1712.5 240853 | Brake System: Lucas / TRW Supplementary Article/Supplementary Info: without holder Brake Caliper Type: Fist-type Caliper |
| 3.2 V6 | 170 | 02/04→12/09 | | | |
| 3.2 V6 4motion | 173 | 07/04→12/09 | | | |
| | | | Vehicle Identification Number from: 7H-8-028000 →; for PR number: 0WR; → Vehicle Identification Number to: 7H-8-200000; Fitting Position: Rear Axle Right | 24.3414-1712.5 240853 | Brake System: Lucas / TRW Supplementary Article/Supplementary Info: without holder Brake Caliper Type: Fist-type Caliper |
| | | | Vehicle Identification Number from: 7H-6-000001 →; for PR number: 2E3 / 2E4; → Vehicle Identification Number to: 7H-A-050000; Fitting Position: Rear Axle Right | 24.3414-1712.5 240853 | Brake System: Lucas / TRW Supplementary Article/Supplementary Info: without holder Brake Caliper Type: Fist-type Caliper |
| 2.0 BiTDI | 132 | 09/09→08/15 | Vehicle Identification Number from: 7H-A-200001 →; for PR number: 2E4; Fitting Position: Front Axle Left | 24.3441-9933.5 241141 | Brake System: ATE Supplementary Article/Supplementary Info: without holder Brake Caliper Type: Fist-type Caliper (2 pistons) |
| 2.0 BiTDI 4motion | 132 | 09/09→08/15 | | | |
| 2.0 TDI | 62 | 09/09→08/15 | | | |
| 2.0 TDI 4motion | 103 | 09/09→08/15 | | | |
| | | | Vehicle Identification Number from: 7H-A-200001 →; for PR number: 2E4; Fitting Position: Front Axle Right | 24.3441-9934.5 241142 | Brake System: ATE Supplementary Article/Supplementary Info: without holder Brake Caliper Type: Fist-type Caliper (2 pistons) |
| | | | for PR number: 2E3; Fitting Position: Front Axle Left | 24.3601-9947.5 240597 | Brake System: ATE Supplementary Article/Supplementary Info: without holder Brake Caliper Type: Fist-type Caliper |
| | | | for PR number: 2E3; Fitting Position: Front Axle Right | 24.3601-9948.5 240598 | Brake System: ATE Supplementary Article/Supplementary Info: without holder Brake Caliper Type: Fist-type Caliper |
| | | | Vehicle Identification Number from: 7H-A-200001 →; Fitting Position: Rear Axle Left | 24.3414-1711.5 240852 | Brake System: Lucas / TRW Supplementary Article/Supplementary Info: without holder Brake Caliper Type: Fist-type Caliper |
| | | | Vehicle Identification Number from: 7H-6-000001 →; for PR number: 2E3 / 2E4; → Vehicle Identification Number to: 7H-A-050000; Fitting Position: Rear Axle Left | 24.3414-1711.5 240852 | Brake System: Lucas / TRW Supplementary Article/Supplementary Info: without holder Brake Caliper Type: Fist-type Caliper |
| | | | Vehicle Identification Number from: 7H-A-200001 →; Fitting Position: Rear Axle Right | 24.3414-1712.5 240853 | Brake System: Lucas / TRW Supplementary Article/Supplementary Info: without holder Brake Caliper Type: Fist-type Caliper |
| | | | Vehicle Identification Number from: 7H-6-000001 →; for PR number: 2E3 / 2E4; → Vehicle Identification Number to: 7H-A-050000; Fitting Position: Rear Axle Right | 24.3414-1712.5 240853 | Brake System: Lucas / TRW Supplementary Article/Supplementary Info: without holder Brake Caliper Type: Fist-type Caliper |
| 2.0 TDI | 84 | 05/11→08/15 | for PR number: 2E4; Fitting Position: Front Axle Left | 24.3441-9933.5 241141 | Brake System: ATE Supplementary Article/Supplementary Info: without holder Brake Caliper Type: Fist-type Caliper (2 pistons) |
| 2.0 TSI | 110 | 05/11→08/15 | | | |
| 2.0 TSI 4motion | 150 | 07/11→08/15 | | | |
| | | | for PR number: 2E4; Fitting Position: Front Axle Right | 24.3441-9934.5 241142 | Brake System: ATE Supplementary Article/Supplementary Info: without holder Brake Caliper Type: Fist-type Caliper (2 pistons) |
| | | | for PR number: 2E3; Fitting Position: Front Axle Left | 24.3601-9947.5 240597 | Brake System: ATE Supplementary Article/Supplementary Info: without holder Brake Caliper Type: Fist-type Caliper |



→





| | kW | | | | |
|--|---|--|---|------------------------------|--|
| VW - MULTIVAN V (7HM, 7HN, 7HF, 7EF, 7EM, 7EN) 04/03→08/15 | | | | | |
|  Brake Caliper | | | | | |
| 2.0 TDI 2.0 TSI 2.0 TSI 4motion | 84 05/11→08/15 110 - 05/11→08/15 150 150 07/11→08/15 | for PR number: 2E3; Fitting Position: Front Axle Right | | 24.3601-9948.5 240598 | Brake System: ATE Supplementary Article/Supplementary Info: without holder Brake Caliper Type: Fist-type Caliper |
| | | Fitting Position: Rear Axle Left | | 24.3414-1711.5 240852 | Brake System: Lucas / TRW Supplementary Article/Supplementary Info: without holder Brake Caliper Type: Fist-type Caliper |
| | | Fitting Position: Rear Axle Right | | 24.3414-1712.5 240853 | Brake System: Lucas / TRW Supplementary Article/Supplementary Info: without holder Brake Caliper Type: Fist-type Caliper |
| 2.0 TDI 2.0 TDI 4motion | 100 05/10→08/15 100 05/10→08/15 | Vehicle Identification Number from: 7H-A-200001 →; for PR number: 2E4; Fitting Position: Front Axle Left | | 24.3441-9933.5 241141 | Brake System: ATE Supplementary Article/Supplementary Info: without holder Brake Caliper Type: Fist-type Caliper (2 pistons) |
| | | Vehicle Identification Number from: 7H-A-200001 →; for PR number: 2E4; Fitting Position: Front Axle Right | | 24.3441-9934.5 241142 | Brake System: ATE Supplementary Article/Supplementary Info: without holder Brake Caliper Type: Fist-type Caliper (2 pistons) |
| | | for PR number: 2E3; Fitting Position: Front Axle Left | | 24.3601-9947.5 240597 | Brake System: ATE Supplementary Article/Supplementary Info: without holder Brake Caliper Type: Fist-type Caliper |
| | | for PR number: 2E3; Fitting Position: Front Axle Right | | 24.3601-9948.5 240598 | Brake System: ATE Supplementary Article/Supplementary Info: without holder Brake Caliper Type: Fist-type Caliper |
| | | Vehicle Identification Number from: 7H-A-200001 →; Fitting Position: Rear Axle Left | | 24.3414-1711.5 240852 | Brake System: Lucas / TRW Supplementary Article/Supplementary Info: without holder Brake Caliper Type: Fist-type Caliper |
| | | Vehicle Identification Number from: 7H-A-200001 →; Fitting Position: Rear Axle Right | | 24.3414-1712.5 240853 | Brake System: Lucas / TRW Supplementary Article/Supplementary Info: without holder Brake Caliper Type: Fist-type Caliper |
| Spring, brake caliper | | | | | |
| 1.9 TDI 2.0 2.0 BiTDI 2.0 BiTDI 4motion 2.0 TDI | 62 - 04/03→11/09 77 85 11/03→08/15 132 09/09→08/15 132 09/09→08/15 62 - 09/09→08/15 | Vehicle Identification Number from: 7H-A-200001 →; for PR number: 2E4; Required quantity: 2 | 2 | 11.8116-0126.2 390608 | Brake System: ATE |
| 2.0 TDI 4motion 2.5 TDI 2.5 TDI 4motion 3.2 V6 3.2 V6 4motion | 103 103 09/09→08/15 96 - 04/03→11/09 128 96 - 07/04→11/09 128 170 - 02/04→12/09 173 173 07/04→12/09 | → Vehicle Identification Number to: 7H-A-050000; for PR number: 2E4; Required quantity: 2 | 2 | 11.8116-0237.1 390509 | Brake System: ATE |
| | | for PR number: 2E3; Required quantity: 2 | 2 | 11.8116-0237.1 390509 | Brake System: ATE |
| 2.0 TDI 2.0 TSI 2.0 TSI 4motion | 84 05/11→08/15 110 - 05/11→08/15 150 150 07/11→08/15 | for PR number: 2E4; Required quantity: 2 | 2 | 11.8116-0126.2 390608 | Brake System: ATE |
| | | for PR number: 2E3; Required quantity: 2 | 2 | 11.8116-0237.1 390509 | Brake System: ATE |
| 2.0 TDI 2.0 TDI 4motion | 100 05/10→08/15 100 05/10→08/15 | Vehicle Identification Number from: 7H-A-200001 →; for PR number: 2E4; Required quantity: 2 | 2 | 11.8116-0126.2 390608 | Brake System: ATE |
| | | for PR number: 2E3; Required quantity: 2 | 2 | 11.8116-0237.1 390509 | Brake System: ATE |
|  Brake Pad Set, disc brake | | | | | |
| 1.9 TDI | 62 - 01/06→11/09 75 | for PR number: 2E3; Fitting Position: Front Axle | | 13.0460-7236.2 607236 | Brake System: ATE 23746 19,7 Wear Warning Contact: incl. wear warning contact |
| | | Vehicle Identification Number from: 7H-A-200001 →; for PR number: 2E4; Fitting Position: Front Axle | | 13.0460-7286.2 607286 | Brake System: ATE 24623 18,2 Wear Warning Contact: incl. wear warning contact |

| | kW | | | | |
|--|--------------------------|---|------------------------------|--|--|
| VW - MULTIVAN V (7HM, 7HN, 7HF, 7EF, 7EM, 7EN) 04/03→08/15 | | | | | |
|  Brake Pad Set, disc brake | | | | | |
| 1.9 TDI | 62 - 01/06→11/09 75 | Vehicle Identification Number from: 7H-A-200001 →; Fitting Position: Rear Axle | 13.0460-2882.2 602882 | Brake System: Lucas / TRW 23326 17,4 Wear Warning Contact: incl. wear warning contact Supplementary Article/Supplementary Info: with accessories | |
| | | Vehicle Identification Number from: 7H-8-028000 →; for PR number: 0WR; → Vehicle Identification Number to: 7H-8-200000; Fitting Position: Rear Axle | 13.0460-2882.2 602882 | Brake System: Lucas / TRW 23326 17,4 Wear Warning Contact: incl. wear warning contact Supplementary Article/Supplementary Info: with accessories | |
| | | Vehicle Identification Number from: 7H-6-000001 →; for PR number: 2E3 / 2E4; → Vehicle Identification Number to: 7H-A-050000; Fitting Position: Rear Axle | 13.0460-2882.2 602882 | Brake System: Lucas / TRW 23326 17,4 Wear Warning Contact: incl. wear warning contact Supplementary Article/Supplementary Info: with accessories | |
| 1.9 TDI | 63 - 04/03→11/09 77 | for PR number: 2E3; Fitting Position: Front Axle | 13.0460-7236.2 607236 | Brake System: ATE 23746 19,7 Wear Warning Contact: incl. wear warning contact | |
| 2.0 | 85 11/03→08/15 | | | | |
| 2.5 TDI | 96 - 04/03→11/09 128 | Vehicle Identification Number from: 7H-A-200001 →; for PR number: 2E4; Fitting Position: Front Axle | 13.0460-7286.2 607286 | Brake System: ATE 24623 18,2 Wear Warning Contact: incl. wear warning contact | |
| 2.5 TDI 4motion | 96 - 07/04→11/09 128 | | | | |
| 3.2 V6 | 170 - 02/04→12/09 173 | Vehicle Identification Number from: 7H-A-200001 →; Fitting Position: Rear Axle | 13.0460-2882.2 602882 | Brake System: Lucas / TRW 23326 17,4 Wear Warning Contact: incl. wear warning contact Supplementary Article/Supplementary Info: with accessories | |
| 3.2 V6 4motion | 173 07/04→12/09 | | | | |
| | | for PR number: 0WL / 0WN / 0WM / 0WP / 0WQ; → Vehicle Identification Number to: 7H-5-120000; Fitting Position: Rear Axle | 13.0460-2882.2 602882 | Brake System: Lucas / TRW 23326 17,4 Wear Warning Contact: incl. wear warning contact Supplementary Article/Supplementary Info: with accessories | |
| | | Vehicle Identification Number from: 7H-6-000001 →; for PR number: 2E3 / 2E4; → Vehicle Identification Number to: 7H-A-050000; Fitting Position: Rear Axle | 13.0460-2882.2 602882 | Brake System: Lucas / TRW 23326 17,4 Wear Warning Contact: incl. wear warning contact Supplementary Article/Supplementary Info: with accessories | |
| | | Vehicle Identification Number from: 7H-8-028000 →; for PR number: 0WR; → Vehicle Identification Number to: 7H-8-200000; Fitting Position: Rear Axle | 13.0460-2882.2 602882 | Brake System: Lucas / TRW 23326 17,4 Wear Warning Contact: incl. wear warning contact Supplementary Article/Supplementary Info: with accessories | |
| 2.0 BiTDI | 132 09/09→08/15 | for PR number: 2E3; Fitting Position: Front Axle | 13.0460-7236.2 607236 | Brake System: ATE 23746 19,7 Wear Warning Contact: incl. wear warning contact | |
| 2.0 BiTDI 4motion | 132 09/09→08/15 | | | | |
| 2.0 TDI | 62 - 09/09→08/15 103 | Vehicle Identification Number from: 7H-A-200001 →; for PR number: 2E4; Fitting Position: Front Axle | 13.0460-7286.2 607286 | Brake System: ATE 24623 18,2 Wear Warning Contact: incl. wear warning contact | |
| 2.0 TDI 4motion | 103 09/09→08/15 | | | | |
| | | Vehicle Identification Number from: 7H-A-200001 →; Fitting Position: Rear Axle | 13.0460-2882.2 602882 | Brake System: Lucas / TRW 23326 17,4 Wear Warning Contact: incl. wear warning contact Supplementary Article/Supplementary Info: with accessories | |
| | | Vehicle Identification Number from: 7H-6-000001 →; for PR number: 2E3 / 2E4; → Vehicle Identification Number to: 7H-A-050000; Fitting Position: Rear Axle | 13.0460-2882.2 602882 | Brake System: Lucas / TRW 23326 17,4 Wear Warning Contact: incl. wear warning contact Supplementary Article/Supplementary Info: with accessories | |
| 2.0 TDI | 84 05/11→08/15 | for PR number: 2E3; Fitting Position: Front Axle | 13.0460-7236.2 607236 | Brake System: ATE 23746 19,7 Wear Warning Contact: incl. wear warning contact | |
| 2.0 TSI | 110 - 05/11→08/15 150 | | | | |
| 2.0 TSI 4motion | 150 07/11→08/15 | for PR number: 2E4; Fitting Position: Front Axle | 13.0460-7286.2 607286 | Brake System: ATE 24623 18,2 Wear Warning Contact: incl. wear warning contact | |
| → | | | | | |



| | kW | | | | |
|--|---|---|------------------------------|---|--|
| VW - MULTIVAN V (7HM, 7HN, 7HF, 7EF, 7EM, 7EN) 04/03→08/15 | | | | | |
|  Brake Pad Set, disc brake | | | | | |
| 2.0 TDI 2.0 TSI 2.0 TSI 4motion | 84 05/11→08/15 110 - 05/11→08/15 150 150 07/11→08/15 | Fitting Position: Rear Axle | 13.0460-2882.2 602882 | Brake System: Lucas / TRW 23326 17,4 Wear Warning Contact: incl. wear warning contact Supplementary Article/Supplementary Info: with accessories | |
| 2.0 TDI 2.0 TDI 4motion | 100 05/10→08/15 100 05/10→08/15 | for PR number: 2E3; Fitting Position: Front Axle | 13.0460-7236.2 607236 | Brake System: ATE 23746 19,7 Wear Warning Contact: incl. wear warning contact | |
| | | Vehicle Identification Number from: 7H-A-200001 →; for PR number: 2E4; Fitting Position: Front Axle | 13.0460-7286.2 607286 | Brake System: ATE 24623 18,2 Wear Warning Contact: incl. wear warning contact | |
| | | Vehicle Identification Number from: 7H-A-200001 →; Fitting Position: Rear Axle | 13.0460-2882.2 602882 | Brake System: Lucas / TRW 23326 17,4 Wear Warning Contact: incl. wear warning contact Supplementary Article/Supplementary Info: with accessories | |
|  Brake Disc | | | | | |
| 1.9 TDI | 62 - 01/06→11/09 75 | for PR number: 2E3; Fitting Position: Front Axle | 24.0130-0114.1 430114 | Outer diameter [mm]: 308 Brake Disc Thickness [mm] 29.5 Minimum thickness [mm] 25.5 Brake Disc Type: Vented | |
| | | Vehicle Identification Number from: 7H-A-200001 →; for PR number: 2E4; Fitting Position: Front Axle | 24.0133-0100.1 433100 | Outer diameter [mm]: 340 Brake Disc Thickness [mm] 32.6 Minimum thickness [mm] 29.5 Brake Disc Type: Vented Supplementary Article/Info 2: with bolts/screws | |
| | | Vehicle Identification Number from: 7H-A-200001 →; Fitting Position: Rear Axle | 24.0122-0211.1 422211 | Outer diameter [mm]: 294 Brake Disc Thickness [mm] 21.9 Minimum thickness [mm] 19.5 Brake Disc Type: Vented Supplementary Article/Info 2: with bolts/screws | |
| | | Vehicle Identification Number from: 7H-8-028000 →; for PR number: 0WR; → Vehicle Identification Number to: 7H-8-200000; Fitting Position: Rear Axle | 24.0122-0211.1 422211 | Outer diameter [mm]: 294 Brake Disc Thickness [mm] 21.9 Minimum thickness [mm] 19.5 Brake Disc Type: Vented Supplementary Article/Info 2: with bolts/screws | |
| | | Vehicle Identification Number from: 7H-6-000001 →; for PR number: 2E3 / 2E4; → Vehicle Identification Number to: 7H-A-050000; Fitting Position: Rear Axle | 24.0122-0211.1 422211 | Outer diameter [mm]: 294 Brake Disc Thickness [mm] 21.9 Minimum thickness [mm] 19.5 Brake Disc Type: Vented Supplementary Article/Info 2: with bolts/screws | |
| 1.9 TDI 2.0 2.5 TDI 2.5 TDI 4motion 3.2 V6 3.2 V6 4motion | 63 - 04/03→11/09 77 85 11/03→08/15 96 - 04/03→11/09 128 96 - 07/04→11/09 128 170 - 02/04→12/09 173 173 07/04→12/09 | for PR number: 2E3; Fitting Position: Front Axle | 24.0130-0114.1 430114 | Outer diameter [mm]: 308 Brake Disc Thickness [mm] 29.5 Minimum thickness [mm] 25.5 Brake Disc Type: Vented | |
| | | Vehicle Identification Number from: 7H-A-200001 →; for PR number: 2E4; Fitting Position: Front Axle | 24.0133-0100.1 433100 | Outer diameter [mm]: 340 Brake Disc Thickness [mm] 32.6 Minimum thickness [mm] 29.5 Brake Disc Type: Vented Supplementary Article/Info 2: with bolts/screws | |
| | | Vehicle Identification Number from: 7H-A-200001 →; Fitting Position: Rear Axle | 24.0122-0211.1 422211 | Outer diameter [mm]: 294 Brake Disc Thickness [mm] 21.9 Minimum thickness [mm] 19.5 Brake Disc Type: Vented Supplementary Article/Info 2: with bolts/screws | |
| | | for PR number: 0WL / 0WN / 0WM / 0WP / 0WQ; → Vehicle Identification Number to: 7H-5-120000; Fitting Position: Rear Axle | 24.0122-0211.1 422211 | Outer diameter [mm]: 294 Brake Disc Thickness [mm] 21.9 Minimum thickness [mm] 19.5 Brake Disc Type: Vented Supplementary Article/Info 2: with bolts/screws | |
| | | Vehicle Identification Number from: 7H-6-000001 →; for PR number: 2E3 / 2E4; → Vehicle Identification Number to: 7H-A-050000; Fitting Position: Rear Axle | 24.0122-0211.1 422211 | Outer diameter [mm]: 294 Brake Disc Thickness [mm] 21.9 Minimum thickness [mm] 19.5 Brake Disc Type: Vented Supplementary Article/Info 2: with bolts/screws | |







→



| | | kW | | | | | | | |
|---|-------------------|-----|--|---|---|------------------------------|--|---|--|
| VW - MULTIVAN V (7HM, 7HN, 7HF, 7EF, 7EM, 7EN) 04/03→08/15 | | | | | | | | | |
|  Brake Disc | | | | | | | | | |
| 1.9 TDI | 63 - 04/03→11/09 | 77 | | Vehicle Identification Number from: 7H-8-028000 →; for PR number: 0WR; → Vehicle Identification Number to: 7H-8-200000; Fitting Position: Rear Axle | | 24.0122-0211.1 422211 | | Outer diameter [mm]: 294 Brake Disc Thickness [mm] 21.9 Minimum thickness [mm] 19.5 Brake Disc Type: Vented Supplementary Article/Info 2: with bolts/screws | |
| 2.0 | 85 11/03→08/15 | | | | | | | | |
| 2.5 TDI | 96 - 04/03→11/09 | 128 | | | | | | | |
| 2.5 TDI 4motion | 96 - 07/04→11/09 | 128 | | | | | | | |
| 3.2 V6 | 170 - 02/04→12/09 | 173 | | | | | | | |
| 3.2 V6 4motion | 173 07/04→12/09 | | | | | | | | |
| 2.0 BiTDI | 132 09/09→08/15 | | | for PR number: 2E3; Fitting Position: Front Axle | | 24.0130-0114.1 430114 | | Outer diameter [mm]: 308 Brake Disc Thickness [mm] 29.5 Minimum thickness [mm] 25.5 Brake Disc Type: Vented | |
| 2.0 BiTDI 4motion | 132 09/09→08/15 | | | | | | | | |
| 2.0 TDI | 62 - 09/09→08/15 | 103 | | Vehicle Identification Number from: 7H-A-200001 →; for PR number: 2E4; Fitting Position: Front Axle | | 24.0133-0100.1 433100 | | Outer diameter [mm]: 340 Brake Disc Thickness [mm] 32.6 Minimum thickness [mm] 29.5 Brake Disc Type: Vented Supplementary Article/Info 2: with bolts/screws | |
| 2.0 TDI 4motion | 103 09/09→08/15 | | | | | | | | |
| | | | | Vehicle Identification Number from: 7H-A-200001 →; Fitting Position: Rear Axle | | 24.0122-0211.1 422211 | | Outer diameter [mm]: 294 Brake Disc Thickness [mm] 21.9 Minimum thickness [mm] 19.5 Brake Disc Type: Vented Supplementary Article/Info 2: with bolts/screws | |
| | | | | Vehicle Identification Number from: 7H-6-000001 →; for PR number: 2E3 / 2E4; → Vehicle Identification Number to: 7H-A-050000; Fitting Position: Rear Axle | | 24.0122-0211.1 422211 | | Outer diameter [mm]: 294 Brake Disc Thickness [mm] 21.9 Minimum thickness [mm] 19.5 Brake Disc Type: Vented Supplementary Article/Info 2: with bolts/screws | |
| 2.0 TDI | 84 05/11→08/15 | | | for PR number: 2E3; Fitting Position: Front Axle | | 24.0130-0114.1 430114 | | Outer diameter [mm]: 308 Brake Disc Thickness [mm] 29.5 Minimum thickness [mm] 25.5 Brake Disc Type: Vented | |
| 2.0 TSI | 110 - 05/11→08/15 | 150 | | | | | | | |
| 2.0 TSI 4motion | 150 07/11→08/15 | | | | | | | | |
| | | | | for PR number: 2E4; Fitting Position: Front Axle | | 24.0133-0100.1 433100 | | Outer diameter [mm]: 340 Brake Disc Thickness [mm] 32.6 Minimum thickness [mm] 29.5 Brake Disc Type: Vented Supplementary Article/Info 2: with bolts/screws | |
| | | | | Fitting Position: Rear Axle | | 24.0122-0211.1 422211 | | Outer diameter [mm]: 294 Brake Disc Thickness [mm] 21.9 Minimum thickness [mm] 19.5 Brake Disc Type: Vented Supplementary Article/Info 2: with bolts/screws | |
| 2.0 TDI | 100 05/10→08/15 | | | for PR number: 2E3; Fitting Position: Front Axle | | 24.0130-0114.1 430114 | | Outer diameter [mm]: 308 Brake Disc Thickness [mm] 29.5 Minimum thickness [mm] 25.5 Brake Disc Type: Vented | |
| 2.0 TDI 4motion | 100 05/10→08/15 | | | | | | | | |
| | | | | Vehicle Identification Number from: 7H-A-200001 →; for PR number: 2E4; Fitting Position: Front Axle | | 24.0133-0100.1 433100 | | Outer diameter [mm]: 340 Brake Disc Thickness [mm] 32.6 Minimum thickness [mm] 29.5 Brake Disc Type: Vented Supplementary Article/Info 2: with bolts/screws | |
| | | | | Vehicle Identification Number from: 7H-A-200001 →; Fitting Position: Rear Axle | | 24.0122-0211.1 422211 | | Outer diameter [mm]: 294 Brake Disc Thickness [mm] 21.9 Minimum thickness [mm] 19.5 Brake Disc Type: Vented Supplementary Article/Info 2: with bolts/screws | |
|  Brake Hose | | | | | | | | | |
| 1.9 TDI | 62 - 04/03→11/09 | 77 | | for PR number: 1BA / 1BB / 1BJ / 1BV / 1MG / 1MK / 1ML / 2MD / 2MF / 2MG / 2ML; Required quantity: 2; Fitting Position: Front Axle | 2 | 24.5140-0514.3 331290 | | Length [mm]: 520 | |
| 2.0 | 85 11/03→08/15 | | | | | | | | |
| 2.0 BiTDI | 132 09/09→08/15 | | | | | | | | |
| 2.0 BiTDI 4motion | 132 09/09→08/15 | | | for PR number: 0WL / 0WN / 0WM / 0WP / 0WQ; Required quantity: 2; Fitting Position: Front Axle | 2 | 24.5140-0514.3 331290 | | Length [mm]: 520 | |
| 2.0 TDI | 62 - 09/09→08/15 | 103 | | | | | | | |
| 2.0 TDI 4motion | 100 - 09/09→08/15 | 103 | | for PR number: 1BH / 1BX / 1MR / 2MQ / 2MZ / 2MU / 2MT; Required quantity: 2; Fitting Position: Front Axle | 2 | 83.6113-0552.3 330864 | | Length [mm]: 552 | |
| 2.5 TDI | 96 - 04/03→11/09 | 128 | | | | | | | |
| 2.5 TDI 4motion | 96 - 07/04→11/09 | 128 | | | | | | | |
| → | | | | | | | | | |







| | kW | | | | |
|--|-----|-------------|--|---|--|
| VW - MULTIVAN V (7HM, 7HN, 7HF, 7EF, 7EM, 7EN) 04/03→08/15 | | | | | |
|  Brake Hose | | | | | |
| 3.2 V6 | 170 | 02/04→12/09 | for PR number: 0WR; Required quantity: 2; Fitting Position: Front Axle | 2 | 83.6113-0552.3 330864 Length [mm]: 552 |
| 3.2 V6 4motion | 173 | 07/04→12/09 | Braking System: for vehicles with brake-power regulator; Required quantity: 2; Fitting Position: at brake caliper / Rear Axle | 2 | 24.5140-0194.3 331383 Length [mm]: 190 |
| | | | for PR number: 0E1 / 0E2 / 0WL / 0WN / 0WM / 0WP / 0WQ; Required quantity: 2; Fitting Position: Rear Axle | 2 | 24.5140-0194.3 331383 Length [mm]: 190 |
| | | | Required quantity: 2; Fitting Position: Rear Axle | 2 | 24.5237-0250.3 330880 Length [mm]: 250 |
| | | | for PR number: 0WR; Required quantity: 2; Fitting Position: Rear Axle | 2 | 24.5237-0250.3 330880 Length [mm]: 250 |
| 2.0 TDI | 84 | 05/11→08/15 | for PR number: 1BA / 1BB / 1BJ / 1BV / 1MG / 1MK / 1ML / 2MD / 2MF / 2MG / 2ML; Required quantity: 2; Fitting Position: Front Axle | 2 | 24.5140-0514.3 331290 Length [mm]: 520 |
| 2.0 TSI | 110 | 05/11→08/15 | | | |
| 2.0 TSI 4motion | 150 | 07/11→08/15 | for PR number: 1BH / 1BX / 1MR / 2MQ / 2MZ / 2MU / 2MT; Required quantity: 2; Fitting Position: Front Axle | 2 | 83.6113-0552.3 330864 Length [mm]: 552 |
| | | | Required quantity: 2; Fitting Position: Rear Axle | 2 | 24.5140-0194.3 331383 Length [mm]: 190 |
|  Wheel Speed Sensor | | | | | |
| 1.9 TDI | 62 | 04/03→11/09 | Fitting Position: Front Axle Left | | 24.0711-5271.3 360301 |
| | 77 | | Fitting Position: Front Axle Right | | 24.0711-5272.3 360302 |
| 2.0 | 85 | 11/03→08/15 | | | |
| 2.0 BiTDI | 132 | 09/09→08/15 | Fitting Position: Rear Axle Left | | 24.0711-5271.3 360301 |
| 2.0 BiTDI 4motion | 132 | 09/09→08/15 | Fitting Position: Rear Axle Right | | 24.0711-5272.3 360302 |
| 2.0 TDI | 62 | 09/09→08/15 | | | |
| | 103 | | | | |
| 2.0 TDI 4motion | 100 | 09/09→08/15 | | | |
| | 103 | | | | |
| 2.0 TSI | 110 | 05/11→08/15 | | | |
| | 150 | | | | |
| 2.0 TSI 4motion | 150 | 07/11→08/15 | | | |
| 2.5 TDI | 96 | 04/03→11/09 | | | |
| | 128 | | | | |
| 2.5 TDI 4motion | 96 | 07/04→11/09 | | | |
| | 128 | | | | |
| 3.2 V6 | 170 | 02/04→12/09 | | | |
| | 173 | | | | |
| 3.2 V6 4motion | 173 | 07/04→12/09 | | | |
|  Cable Pull, parking brake | | | | | |
| 1.9 TDI | 62 | 04/03→11/09 | for PR number: 0E1 / 0E2 / 0WL / 0WN / 0WM / 0WP / 0WQ; Required quantity: 2; Brake Type: Disc Brake; Fitting Position: Rear | 2 | 24.3727-0184.2 580184 Length [mm]: 1,303 |
| | 77 | | | | |
| 2.0 | 85 | 11/03→08/15 | | | |
| 2.0 BiTDI | 132 | 09/09→08/15 | | | |
| 2.0 TDI | 62 | 09/09→08/15 | Vehicle Identification Number from: 7H-7-000001 →; for PR number: 0WR / 0E1; Required quantity: 2; Fitting Position: Rear | 2 | 24.3727-3409.2 583409 Length [mm]: 1,570 |
| | 103 | | | | |
| 2.5 TDI | 96 | 04/03→11/09 | | | |
| | 128 | | | | |
| 3.2 V6 | 170 | 02/04→12/09 | | | |
| | 173 | | | | |
| 2.0 BiTDI 4motion | 132 | 09/09→08/15 | Vehicle Identification Number from: 7H-A-200001 →; Brake Type: Disc Brake; for PR number: G0C / G0K / G1C; Required quantity: 2; Fitting Position: Rear | 2 | 24.3727-0184.2 580184 Length [mm]: 1,303 |
| 2.0 TDI 4motion | 100 | 09/09→08/15 | | | |
| | 103 | | | | |
| 2.5 TDI 4motion | 96 | 07/04→11/09 | | | |
| | 128 | | | | |
| 3.2 V6 4motion | 173 | 07/04→12/09 | Vehicle Identification Number from: 7H-7-000001 →; for PR number: 0WR / 0E1; Required quantity: 2; Fitting Position: Rear | 2 | 24.3727-3409.2 583409 Length [mm]: 1,570 |
| 2.0 TDI | 84 | 05/11→08/15 | Brake Type: Disc Brake; for PR number: G0C / G0K / G1C; Required quantity: 2; Fitting Position: Rear | 2 | 24.3727-0184.2 580184 Length [mm]: 1,303 |
| 2.0 TSI | 110 | 05/11→08/15 | | | |
| | 150 | | | | |
| 2.0 TSI 4motion | 150 | 07/11→08/15 | | | |
| VW - MULTIVAN VI (SGF, SGM, SGN, SHM, SHN) 04/15→ | | | | | |
|  Brake Caliper | | | | | |
| 2.0 TDI | 62 | 04/15→ | Rim Size [in]: 17; Fitting Position: Front Axle Left | | 24.3441-9933.5 241141 Brake System: ATE Supplementary Article/Supplementary Info: without holder Brake Caliper Type: Fist-type Caliper (2 pistons) |
| | 150 | | | | |
| 2.0 TDI 4motion | 103 | 06/15→ | | | |
| | 150 | | | | |





| | | kW | | | | | | | |
|--|--------------------------|--|---|-----------------------|---------------|--|--|--|--|
| VW - MULTIVAN VI (SGF, SGM, SGN, SHM, SHN) 04/15→ | | | | | | | | | |
|  Brake Caliper | | | | | | | | | |
| 2.0 TSI | 110 - 04/15→07/19 | Rim Size [in]: 17; Fitting Position: Front Axle Right | | 24.3441-9934.5 | 241142 | Brake System: ATE Supplementary Article/Supplementary Info: without holder Brake Caliper Type: Fist-type Caliper (2 pistons) | | | |
| 2.0 TSI 4motion | 150 150 06/15→07/19 | Rim Size [in]: 16; Fitting Position: Front Axle Left | | 24.3601-9947.5 | 240597 | Brake System: ATE Supplementary Article/Supplementary Info: without holder Brake Caliper Type: Fist-type Caliper | | | |
| | | Rim Size [in]: 16; Fitting Position: Front Axle Right | | 24.3601-9948.5 | 240598 | Brake System: ATE Supplementary Article/Supplementary Info: without holder Brake Caliper Type: Fist-type Caliper | | | |
| | | Fitting Position: Rear Axle Left | | 24.3414-1711.5 | 240852 | Brake System: Lucas / TRW Supplementary Article/Supplementary Info: without holder Brake Caliper Type: Fist-type Caliper | | | |
| | | Fitting Position: Rear Axle Right | | 24.3414-1712.5 | 240853 | Brake System: Lucas / TRW Supplementary Article/Supplementary Info: without holder Brake Caliper Type: Fist-type Caliper | | | |
| 2.0 TDI | 81 07/19→ | Fitting Position: Rear Axle Left | | 24.3414-1711.5 | 240852 | Brake System: Lucas / TRW Supplementary Article/Supplementary Info: without holder Brake Caliper Type: Fist-type Caliper | | | |
| | | Fitting Position: Rear Axle Right | | 24.3414-1712.5 | 240853 | Brake System: Lucas / TRW Supplementary Article/Supplementary Info: without holder Brake Caliper Type: Fist-type Caliper | | | |
| 2.0 TDI | 146 11/18→ | Rim Size [in]: 17; for PR number: 2E4; Fitting Position: Front Axle Left | | 24.3441-9933.5 | 241141 | Brake System: ATE Supplementary Article/Supplementary Info: without holder Brake Caliper Type: Fist-type Caliper (2 pistons) | | | |
| | | Rim Size [in]: 17; for PR number: 2E4; Fitting Position: Front Axle Right | | 24.3441-9934.5 | 241142 | Brake System: ATE Supplementary Article/Supplementary Info: without holder Brake Caliper Type: Fist-type Caliper (2 pistons) | | | |
| | | Rim Size [in]: 16; for PR number: 2E3; Fitting Position: Front Axle Left | | 24.3601-9947.5 | 240597 | Brake System: ATE Supplementary Article/Supplementary Info: without holder Brake Caliper Type: Fist-type Caliper | | | |
| | | Rim Size [in]: 16; for PR number: 2E3; Fitting Position: Front Axle Right | | 24.3601-9948.5 | 240598 | Brake System: ATE Supplementary Article/Supplementary Info: without holder Brake Caliper Type: Fist-type Caliper | | | |
| | | Fitting Position: Rear Axle Left | | 24.3414-1711.5 | 240852 | Brake System: Lucas / TRW Supplementary Article/Supplementary Info: without holder Brake Caliper Type: Fist-type Caliper | | | |
| | | Fitting Position: Rear Axle Right | | 24.3414-1712.5 | 240853 | Brake System: Lucas / TRW Supplementary Article/Supplementary Info: without holder Brake Caliper Type: Fist-type Caliper | | | |
| Spring, brake caliper | | | | | | | | | |
| 2.0 TDI | 62 - 04/15→ | Rim Size [in]: 17; Required quantity: 2 | 2 | 11.8116-0126.2 | 390608 | Brake System: ATE | | | |
| 2.0 TDI 4motion | 150 103 - 06/15→ | Rim Size [in]: 16; Required quantity: 2 | 2 | 11.8116-0237.1 | 390509 | Brake System: ATE | | | |
| 2.0 TSI | 150 110 - 04/15→07/19 | | | | | | | | |
| 2.0 TSI 4motion | 150 150 06/15→07/19 | | | | | | | | |
| 2.0 TDI | 146 11/18→ | Rim Size [in]: 17; Required quantity: 2; for PR number: 2E4 | 2 | 11.8116-0126.2 | 390608 | Brake System: ATE | | | |
| | | Rim Size [in]: 16; Required quantity: 2; for PR number: 2E3 | 2 | 11.8116-0237.1 | 390509 | Brake System: ATE | | | |
| → | | | | | | | | | |







| | kW | | | | |
|--|--------------------------|--|------------------------------|---|--|
| VW - MULTIVAN VI (SGF, SGM, SGN, SHM, SHN) 04/15→ | | | | | |
|  Brake Pad Set, disc brake | | | | | |
| 2.0 TDI | 62 - 04/15→ 150 | Rim Size [in]: 16; Fitting Position: Front Axle | 13.0460-7236.2 607236 | Brake System: ATE 23746 19,7 Wear Warning Contact: incl. wear warning contact | |
| 2.0 TDI 4motion | 103 - 06/15→ 150 | | | | |
| 2.0 TSI | 110 - 04/15→07/19 150 | Rim Size [in]: 17; Fitting Position: Front Axle | 13.0460-7286.2 607286 | Brake System: ATE 24623 18,2 Wear Warning Contact: incl. wear warning contact | |
| 2.0 TSI 4motion | 150 06/15→07/19 | Fitting Position: Rear Axle | 13.0460-2882.2 602882 | Brake System: Lucas / TRW 23326 17,4 Wear Warning Contact: incl. wear warning contact Supplementary Article/Supplementary Info: with accessories | |
| 2.0 TDI | 81 07/19→ | for PR number: 0WR; Fitting Position: Rear Axle | 13.0460-2882.2 602882 | Brake System: Lucas / TRW 23326 17,4 Wear Warning Contact: incl. wear warning contact Supplementary Article/Supplementary Info: with accessories | |
| 2.0 TDI | 146 11/18→ | Rim Size [in]: 16; for PR number: 2E3; Fitting Position: Front Axle | 13.0460-7236.2 607236 | Brake System: ATE 23746 19,7 Wear Warning Contact: incl. wear warning contact | |
| | | Rim Size [in]: 17; for PR number: 2E4; Fitting Position: Front Axle | 13.0460-7286.2 607286 | Brake System: ATE 24623 18,2 Wear Warning Contact: incl. wear warning contact | |
| | | Fitting Position: Rear Axle | 13.0460-2882.2 602882 | Brake System: Lucas / TRW 23326 17,4 Wear Warning Contact: incl. wear warning contact Supplementary Article/Supplementary Info: with accessories | |
| Warning Contact, brake pad wear | | | | | |
| 2.0 TDI | 81 07/19→ | Required quantity: 1; Fitting Position: Front Axle | 1 | 24.8190-0829.2 620829 | |
|  Brake Disc | | | | | |
| 2.0 TDI | 62 - 04/15→ 150 | Rim Size [in]: 16; Fitting Position: Front Axle | 24.0130-0114.1 430114 | Outer diameter [mm]: 308 Brake Disc Thickness [mm] 29.5 Minimum thickness [mm] 25.5 Brake Disc Type: Vented | |
| 2.0 TDI 4motion | 103 - 06/15→ 150 | | | | |
| 2.0 TSI | 110 - 04/15→07/19 150 | Rim Size [in]: 17; Fitting Position: Front Axle | 24.0133-0100.1 433100 | Outer diameter [mm]: 340 Brake Disc Thickness [mm] 32.6 Minimum thickness [mm] 29.5 Brake Disc Type: Vented Supplementary Article/Info 2: with bolts/screws | |
| 2.0 TSI 4motion | 150 06/15→07/19 | Fitting Position: Rear Axle | 24.0122-0211.1 422211 | Outer diameter [mm]: 294 Brake Disc Thickness [mm] 21.9 Minimum thickness [mm] 19.5 Brake Disc Type: Vented Supplementary Article/Info 2: with bolts/screws | |
| 2.0 TDI | 81 07/19→ | for PR number: 2E3; Fitting Position: Front Axle | 24.0130-0114.1 430114 | Outer diameter [mm]: 308 Brake Disc Thickness [mm] 29.5 Minimum thickness [mm] 25.5 Brake Disc Type: Vented | |
| | | for PR number: 2E4; Fitting Position: Front Axle | 24.0133-0100.1 433100 | Outer diameter [mm]: 340 Brake Disc Thickness [mm] 32.6 Minimum thickness [mm] 29.5 Brake Disc Type: Vented Supplementary Article/Info 2: with bolts/screws | |
| | | Fitting Position: Rear Axle | 24.0122-0211.1 422211 | Outer diameter [mm]: 294 Brake Disc Thickness [mm] 21.9 Minimum thickness [mm] 19.5 Brake Disc Type: Vented Supplementary Article/Info 2: with bolts/screws | |
| 2.0 TDI | 146 11/18→ | Rim Size [in]: 16; for PR number: 2E3; Fitting Position: Front Axle | 24.0130-0114.1 430114 | Outer diameter [mm]: 308 Brake Disc Thickness [mm] 29.5 Minimum thickness [mm] 25.5 Brake Disc Type: Vented | |
| → | | | | | |





| | kW | | | | |
|--|--------------------------|--|---|--------------------------------|---|
| VW - MULTIVAN VI (SGF, SGM, SGN, SHM, SHN) 04/15→ | | | | | |
|  Brake Disc | | | | | |
| 2.0 TDI | 146 11/18→ | | Rim Size [in]: 17; for PR number: 2E4; Fitting Position: Front Axle | 24.0133-0100.1 433100 | Outer diameter [mm]: 340 Brake Disc Thickness [mm] 32.6 Minimum thickness [mm] 29.5 Brake Disc Type: Vented Supplementary Article/Info 2: with bolts/screws |
| | | | Fitting Position: Rear Axle | 24.0122-0211.1 422211 | Outer diameter [mm]: 294 Brake Disc Thickness [mm] 21.9 Minimum thickness [mm] 19.5 Brake Disc Type: Vented Supplementary Article/Info 2: with bolts/screws |
|  Brake Hose | | | | | |
| 2.0 TDI | 62 - 04/15→ 150 | | Required quantity: 2; Shock Absorber System: Increased shock absorption; for PR number: 1BA / 1BB / 1BC / 1BJ / 1BL / 1BV / 2MD / 2MF / 2MG / 2MH / 2MK / 2ML; Fitting Position: Front Axle | 2 24.5140-0514.3 331290 | Length [mm]: 520 |
| 2.0 TDI 4motion | 103 - 06/15→ 150 | | | | |
| 2.0 TSI | 110 - 04/15→07/19 150 | | | | |
| 2.0 TSI 4motion | 150 06/15→07/19 | | Required quantity: 2; Shock Absorber System: Normal Suspension; for PR number: 1BH / 1BX / 2MQ / 2MR / 2MT / 2MU; Fitting Position: Front Axle | 2 83.6113-0552.3 330864 | Length [mm]: 552 |
| | | | Required quantity: 2; Fitting Position: Rear Axle | 2 24.5237-0250.3 330880 | Length [mm]: 250 |
| 2.0 TDI | 81 07/19→ | | Required quantity: 2; Fitting Position: at brake caliper | 2 24.5140-0194.3 331383 | Length [mm]: 190 |
| | | | Required quantity: 2; Fitting Position: Front Axle | 2 24.5140-0514.3 331290 | Length [mm]: 520 |
| | | | | 83.6113-0552.3 330864 | Length [mm]: 552 |
|  Wheel Speed Sensor | | | | | |
| 2.0 TDI | 62 - 04/15→ 150 | | Fitting Position: Front Axle Left | 24.0711-5271.3 360301 | |
| 2.0 TDI 4motion | 103 - 06/15→ 150 | | Fitting Position: Front Axle Right | 24.0711-5272.3 360302 | |
| | | | Fitting Position: Rear Axle Left | 24.0711-5271.3 360301 | |
| 2.0 TSI | 110 - 04/15→07/19 150 | | Fitting Position: Rear Axle Right | 24.0711-5272.3 360302 | |
| 2.0 TSI 4motion | 150 06/15→07/19 | | | | |
| 2.0 TDI | 81 07/19→ | | Fitting Position: Front Axle Left | 24.0711-5271.3 360301 | |
| | | | Fitting Position: Front Axle Right | 24.0711-5272.3 360302 | |
|  Cable Pull, parking brake | | | | | |
| 2.0 TDI | 62 - 04/15→ 150 | | Required quantity: 2; for PR number: G0C / G0K / G1C; Brake Type: Disc Brake; Fitting Position: Rear | 2 24.3727-0184.2 580184 | Length [mm]: 1,303 |
| 2.0 TDI 4motion | 103 - 06/15→ 150 | | | | |
| 2.0 TSI | 110 - 04/15→07/19 150 | | | | |
| 2.0 TSI 4motion | 150 06/15→07/19 | | | | |
| 2.0 TDI | 81 07/19→ | | Required quantity: 2; Transmission Type: 5-Speed Manual Transmission / 6-Speed Manual Transmission / 7-Speed Automatic Transmission; for PR number: G0C / G0K / G1C; Fitting Position: Rear | 2 24.3727-0184.2 580184 | Length [mm]: 1,303 |
| VW - PASSAT ALLTRACK B7 (365) 01/12→12/14 | | | | | |
|  Wheel Speed Sensor | | | | | |
| 1.8 TSI | 112 - 01/12→12/14 118 | | Fitting Position: Front Axle Left | 24.0711-5271.3 360301 | |
| 2.0 TDI | 103 01/12→12/14 | | Fitting Position: Front Axle Right | 24.0711-5272.3 360302 | |
| 2.0 TDI 4motion | 103 - 01/12→12/14 130 | | | | |
| 2.0 TSI 4motion | 155 01/12→12/14 | | | | |
| VW - PASSAT ALLTRACK B8 Variant (3G5, CB5) 05/15→ | | | | | |
|  Brake Pad Set, disc brake | | | | | |
| 1.4 TSI 4motion | 110 05/15→ | | for PR number: 1ZA / 1ZC / 1ZD / 1ZG / 1ZK / 1ZL; Fitting Position: Front Axle | 13.0470-2785.2 LD2785 | Brake System: Lucas / TRW 25683 20,4 Wear Warning Contact: prepared for wear indicator / incl. wear warning contact Ceramic |
| 2.0 TDI 4motion | 110 - 05/15→ 176 | | | | |
| 2.0 TSI 4motion | 162 - 07/15→ 206 | | | | |



| | kW | | | | | |
|---|-------|-------------|---|------------------------------|------------------------------------|------------------------------|
| VW - PASSAT B6 (3C2) 03/05→12/10 | | | | | | |
|  Wheel Speed Sensor | | | | | | |
| 1.4 TSI | 90 | 05/07→07/10 | Construction year from: 10/07 →; Fitting Position: Front Axle Left | 24.0711-5271.3 360301 | | |
| 1.8 TSI | 118 | 05/07→07/10 | | | | |
| | | | Construction year from: 10/07 →; Fitting Position: Front Axle Right | 24.0711-5272.3 360302 | | |
| 1.4 TSI EcoFuel | 110 | 01/09→07/10 | Fitting Position: Front Axle Left | 24.0711-5271.3 360301 | | |
| 1.6 | 75 | 05/05→07/10 | | | | |
| 1.6 FSI | 85 | 03/05→06/08 | Fitting Position: Front Axle Right | 24.0711-5272.3 360302 | | |
| 1.6 TDI | 77 | 08/09→07/10 | | | | |
| 1.8 TSI | 112 | 11/09→07/10 | | | | |
| 1.9 TDI | 77 | 03/05→07/10 | | | | |
| 2.0 FSI | 110 - | 03/05→07/10 | | | | |
| | 125 | | | | | |
| 2.0 TDI | 81 - | 03/05→07/10 | | | | |
| | 125 | | | | | |
| 2.0 TDI 16V | 103 | 03/05→07/10 | | | | |
| 2.0 TFSI | 147 | 07/05→07/10 | | | | |
| 2.0 BlueTDI | 105 | 01/09→11/10 | → Construction year to: 07/10; Fitting Position: Front Axle Left | 24.0711-5271.3 360301 | | |
| 2.0 TDI | 100 | 03/05→11/10 | → Construction year to: 07/10; Fitting Position: Front Axle Right | 24.0711-5272.3 360302 | | |
| 2.0 FSI 4motion | 110 | 09/05→07/10 | Fitting Position: Front Axle Left | 24.0711-5271.3 360301 | | |
| 2.0 TDI 4motion | 103 - | 03/05→07/10 | Fitting Position: Front Axle Right | 24.0711-5272.3 360302 | | |
| | 125 | | | | | |
| 3.2 FSI 4motion | 184 | 11/05→07/10 | Fitting Position: Rear Axle Left | 24.0711-5271.3 360301 | | |
| 3.6 R36 4motion | 220 | 04/07→07/10 | Fitting Position: Rear Axle Right | 24.0711-5272.3 360302 | | |
| 2.0 TDI 16V 4motion | 103 | 03/05→08/10 | → Construction year to: 07/10; Fitting Position: Front Axle Left | 24.0711-5271.3 360301 | | |
| | | | → Construction year to: 07/10; Fitting Position: Front Axle Right | 24.0711-5272.3 360302 | | |
| | | | → Construction year to: 07/10; Fitting Position: Rear Axle Left | 24.0711-5271.3 360301 | | |
| | | | → Construction year to: 07/10; Fitting Position: Rear Axle Right | 24.0711-5272.3 360302 | | |
| VW - PASSAT B6 Variant (3C5) 08/05→11/11 | | | | | | |
|  Wheel Speed Sensor | | | | | | |
| 1.4 TSI | 90 | 05/07→11/10 | Construction year from: 10/07 → → Construction year to: 07/10; Fitting Position: Front Axle Left | 24.0711-5271.3 360301 | | |
| 1.8 TSI | 118 | 05/07→10/11 | | | | |
| | | | Construction year from: 10/07 → → Construction year to: 07/10; Fitting Position: Front Axle Right | 24.0711-5272.3 360302 | | |
| 1.4 TSI EcoFuel | 110 | 01/09→11/10 | → Construction year to: 07/10; Fitting Position: Front Axle Left | 24.0711-5271.3 360301 | | |
| 1.6 | 75 | 08/05→11/10 | | | | |
| 1.6 TDI | 77 | 08/09→11/10 | → Construction year to: 07/10; Fitting Position: Front Axle Right | 24.0711-5272.3 360302 | | |
| 1.8 TSI | 112 | 11/09→11/10 | | | | |
| 2.0 BlueTDI | 105 | 01/09→11/10 | Fitting Position: Front Axle Right | 24.0711-5272.3 360302 | | |
| 2.0 FSI | 110 | 08/05→11/10 | | | | |
| 2.0 TDI | 81 - | 08/05→11/10 | | | | |
| | 125 | | | | | |
| 2.0 TDI 16V | 103 | 08/05→11/10 | | | | |
| 2.0 TFSI | 147 | 08/05→11/10 | | | | |
| 1.6 FSI | 85 | 08/05→06/08 | | | Fitting Position: Front Axle Left | 24.0711-5271.3 360301 |
| 1.9 TDI | 77 | 08/05→11/10 | | | Fitting Position: Front Axle Right | 24.0711-5272.3 360302 |
| 2.0 TDI | 88 - | 08/05→05/09 | | | | |
| | 120 | | | | | |
| 2.0 FSI 4motion | 110 | 09/05→11/10 | → Construction year to: 07/10; Fitting Position: Front Axle Left | 24.0711-5271.3 360301 | | |
| 2.0 TDI 4motion | 125 | 05/09→11/10 | → Construction year to: 07/10; Fitting Position: Front Axle Right | 24.0711-5272.3 360302 | | |
| 3.2 FSI 4motion | 184 | 11/05→11/10 | | | | |
| 3.6 R36 4motion | 220 | 04/07→11/10 | → Construction year to: 07/10; Fitting Position: Rear Axle Left | 24.0711-5271.3 360301 | | |
| | | | → Construction year to: 07/10; Fitting Position: Rear Axle Right | 24.0711-5272.3 360302 | | |
| 2.0 TDI 16V 4motion | 103 | 08/05→11/10 | Construction year from: 09/05 → → Construction year to: 07/10; Fitting Position: Front Axle Left | 24.0711-5271.3 360301 | | |
| | | | Construction year from: 09/05 → → Construction year to: 07/10; Fitting Position: Front Axle Right | 24.0711-5272.3 360302 | | |
| | | | Construction year from: 09/05 → → Construction year to: 07/10; Fitting Position: Rear Axle Left | 24.0711-5271.3 360301 | | |
| | | | Construction year from: 09/05 → → Construction year to: 07/10; Fitting Position: Rear Axle Right | 24.0711-5272.3 360302 | | |
| → | | | | | | |



| | kW | | | |
|--|-----|-------------|---|--|
| VW - PASSAT B6 Variant (3C5) 08/05→11/11 | | | | |
|  Wheel Speed Sensor | | | | |
| 2.0 TDI 4motion | 103 | 08/05→05/09 | Construction year from: 09/05 →; Fitting Position: Front Axle Left | 24.0711-5271.3 360301 |
| | | | Construction year from: 09/05 →; Fitting Position: Front Axle Right | 24.0711-5272.3 360302 |
| | | | Construction year from: 09/05 →; Fitting Position: Rear Axle Left | 24.0711-5271.3 360301 |
| | | | Construction year from: 09/05 →; Fitting Position: Rear Axle Right | 24.0711-5272.3 360302 |
| VW - PASSAT B7 (362) 08/10→12/15 | | | | |
|  Wheel Speed Sensor | | | | |
| 1.4 TSI | 90 | 08/10→12/14 | → Construction year to: 10/14; Fitting Position: Front Axle Left | 24.0711-5271.3 360301 |
| 1.4 TSI EcoFuel | 110 | 08/10→12/14 | → Construction year to: 10/14; Fitting Position: Front Axle Right | 24.0711-5272.3 360302 |
| 1.4 TSI MultiFuel | 118 | 11/10→12/14 | | |
| 1.6 TDI | 77 | 08/10→12/14 | | |
| 1.8 TSI | 112 | 08/10→12/14 | | |
| | 118 | | | |
| 2.0 TDI | 100 | 08/10→12/14 | | |
| | 130 | | | |
| 2.0 TDI 4motion | 103 | 08/10→12/14 | | |
| | 130 | | | |
| 2.0 TSI | 155 | 11/10→12/14 | | |
| 3.6 FSI 4motion | 220 | 01/11→12/14 | | |
| 2.0 TDI 4motion | 125 | 08/10→01/13 | Fitting Position: Front Axle Left | 24.0711-5271.3 360301 |
| | | | Fitting Position: Front Axle Right | 24.0711-5272.3 360302 |
| VW - PASSAT B7 (A32, A33) 01/11→ | | | | |
|  Wheel Speed Sensor | | | | |
| 2.0 TDI | 103 | 04/11→06/15 | → Construction year to: 10/14; Fitting Position: Front Axle Left | 24.0711-5271.3 360301 |
| 2.5 | 125 | 01/11→ | → Construction year to: 10/14; Fitting Position: Front Axle Right | 24.0711-5272.3 360302 |
| 2.0 TDI | 110 | 06/14→ | Fitting Position: Front Axle Left | 24.0711-5271.3 360301 |
| | | | Fitting Position: Front Axle Right | 24.0711-5272.3 360302 |
| VW - PASSAT B7 Estate Van (365) 08/10→12/14 | | | | |
|  Wheel Speed Sensor | | | | |
| 1.4 TSi BlueMotion | 90 | 08/10→12/14 | → Construction year to: 10/14; Fitting Position: Front Axle Left | 24.0711-5271.3 360301 |
| 1.6 TDi BlueMotion | 77 | 08/10→12/14 | → Construction year to: 10/14; Fitting Position: Front Axle Right | 24.0711-5272.3 360302 |
| 1.8 TFSi | 118 | 08/10→12/14 | | |
| 2.0 TDi BlueMotion | 103 | 08/10→12/14 | | |
| 2.0 TFSi | 155 | 11/10→12/14 | | |
| 3.6 FSi 4motion | 220 | 01/11→12/14 | | |
| 2.0 TDi BlueMotion | 125 | 08/10→12/14 | Fitting Position: Front Axle Left | 24.0711-5271.3 360301 |
| | | | Fitting Position: Front Axle Right | 24.0711-5272.3 360302 |
| VW - PASSAT B7 Variant (365) 08/10→12/15 | | | | |
|  Wheel Speed Sensor | | | | |
| 1.4 TSI | 90 | 08/10→12/14 | → Construction year to: 10/14; Fitting Position: Front Axle Left | 24.0711-5271.3 360301 |
| 1.4 TSI EcoFuel | 110 | 08/10→12/14 | → Construction year to: 10/14; Fitting Position: Front Axle Right | 24.0711-5272.3 360302 |
| 1.4 TSI MultiFuel | 118 | 11/10→12/14 | | |
| 1.6 TDI | 77 | 08/10→12/14 | | |
| 1.8 TSI | 112 | 08/10→12/14 | | |
| | 118 | | | |
| 2.0 TDI | 100 | 08/10→12/14 | | |
| | 130 | | | |
| 2.0 TDI 4motion | 103 | 08/10→12/14 | | |
| | 130 | | | |
| 2.0 TSI | 155 | 11/10→12/15 | | |
| 3.6 FSI 4motion | 220 | 01/11→12/14 | | |
| 2.0 TDI 4motion | 125 | 08/10→01/13 | Fitting Position: Front Axle Left | 24.0711-5271.3 360301 |
| | | | Fitting Position: Front Axle Right | 24.0711-5272.3 360302 |
| VW - PASSAT B8 (3G2, CB2) 08/14→ | | | | |
|  Brake Pad Set, disc brake | | | | |
| 1.4 GTE Hybrid | 115 | 06/15→11/18 | for PR number: 1ZA / 1ZC / 1ZD / 1ZG / 1ZK / 1ZL; Fitting Position: Front Axle | 13.0470-2785.2 LD2785 Brake System: Lucas / TRW 25683 20,4 Wear Warning Contact: prepared for wear indicator / incl. wear warning contact Ceramic |
| 1.4 TSI | 92 | 11/14→ | | |
| | 110 | | | |
| 1.4 TSI 4motion | 110 | 02/15→ | | |
| 1.5 TSI | 110 | 08/18→ | | |
| 1.6 TDI | 88 | 08/14→ | | |
| → | | | | |





| | kW | | | |
|--|-----------|-------------|--|---|
| VW - PASSAT B8 (3G2, CB2) 08/14→ | | | | |
|  Brake Pad Set, disc brake | | | | |
| 1.8 TSI | 132 | 02/15→ | for PR number: 1ZA / 1ZC / 1ZD / 1ZG / 1ZK / 1ZL; Fitting Position: Front Axle | 13.0470-2785.2 LD2785 Brake System: Lucas / TRW 25683 20,4 Wear Warning Contact: prepared for wear indicator / incl. wear warning contact Ceramic |
| 2.0 TDI | 81 - 147 | 11/14→ | | |
| 2.0 TDI 4motion | 110 - 176 | 08/14→ | | |
| 2.0 TSI | 140 - 162 | 02/15→ | | |
| 2.0 TSI 4motion | 200 - 206 | 05/15→ | | |
| | | | | |
| VW - PASSAT B8 Variant (3G5, CB5) 08/14→ | | | | |
|  Brake Pad Set, disc brake | | | | |
| 1.4 GTE Hybrid | 115 | 06/15→ | for PR number: 1ZA / 1ZC / 1ZD / 1ZG / 1ZK / 1ZL; Fitting Position: Front Axle | 13.0470-2785.2 LD2785 Brake System: Lucas / TRW 25683 20,4 Wear Warning Contact: prepared for wear indicator / incl. wear warning contact Ceramic |
| 1.4 TSI | 92 - 110 | 11/14→ | | |
| 1.4 TSI 4motion | 110 | 02/15→ | | |
| 1.5 TSI | 110 | 08/18→ | | |
| 1.6 TDI | 88 | 08/14→ | | |
| 1.8 TSI | 132 | 02/15→ | | |
| 2.0 TDI | 90 - 147 | 11/14→ | | |
| 2.0 TDI 4motion | 110 - 176 | 08/14→ | | |
| 2.0 TSI | 140 - 162 | 08/14→ | | |
| 2.0 TSI 4motion | 200 - 206 | 05/15→ | | |
| | | | | |
| | | | | |
| | | | | |
| | | | | |
| VW - PASSAT CC B6 (357) 02/08→01/12 | | | | |
|  Wheel Speed Sensor | | | | |
| 1.4 TSI MultiFuel | 118 | 01/11→01/12 | → Construction year to: 09/11; Fitting Position: Front Axle Left | 24.0711-5271.3 360301 |
| 1.8 TSI | 118 | 06/08→01/12 | | |
| 2.0 TDI | 103 - 125 | 06/08→01/12 | → Construction year to: 09/11; Fitting Position: Front Axle Right | 24.0711-5272.3 360302 |
| 2.0 TFSI | 147 | 06/08→01/12 | | |
| 2.0 TSI | 155 | 11/10→01/12 | | |
| 1.8 TSI | 112 | 11/08→05/10 | Fitting Position: Front Axle Left | 24.0711-5271.3 360301 |
| 2.0 BlueTDI | 105 | 05/09→11/10 | Fitting Position: Front Axle Right | 24.0711-5272.3 360302 |
| 2.0 TDI | 100 - 120 | 05/08→05/11 | | |
| 2.0 TDI 4motion | 103 - 125 | 08/09→01/12 | → Construction year to: 09/11; Fitting Position: Front Axle Left | 24.0711-5271.3 360301 |
| 3.6 FSI 4motion | 206 | 06/08→01/12 | | |
| | | | → Construction year to: 09/11; Fitting Position: Front Axle Right | 24.0711-5272.3 360302 |
| | | | | |
| | | | → Construction year to: 09/11; Fitting Position: Rear Axle Left | 24.0711-5271.3 360301 |
| | | | | |
| | | | → Construction year to: 09/11; Fitting Position: Rear Axle Right | 24.0711-5272.3 360302 |
| | | | | |
| 3.6 FSI 4motion | 220 | 02/08→12/11 | Fitting Position: Front Axle Left | 24.0711-5271.3 360301 |
| | | | Fitting Position: Front Axle Right | 24.0711-5272.3 360302 |
| | | | Fitting Position: Rear Axle Left | 24.0711-5271.3 360301 |
| | | | Fitting Position: Rear Axle Right | 24.0711-5272.3 360302 |
| VW - POLO VI (AW1, BZ1, AE1) 06/17→ | | | | |
|  Brake Pad Set, disc brake | | | | |
| 1.0 | 48 - 55 | 06/17→08/21 | for PR number: 1ZB / 1ZU; Fitting Position: Front Axle | 13.0470-2785.2 LD2785 Brake System: Lucas / TRW 25683 20,4 Wear Warning Contact: prepared for wear indicator / incl. wear warning contact Ceramic |
| 1.0 MPi | 59 | 09/18→ | | |
| 1.0 TGI | 66 | 09/17→ | | |
| 1.0 TSI | 70 - 85 | 06/17→ | | |
| 1.5 TSI | 110 | 10/18→08/21 | | |
| 1.6 MSi | 81 | 09/17→ | | |
| 1.6 TDI | 59 - 70 | 11/17→02/21 | | |
| 2.0 GTI | 147 | 11/17→ | | |
| GTI | 152 | 04/21→ | | |
| | | | | |
| | | | | |
| | | | | |
| | | | | |
| | | | | |
| VW - SCIROCCO III (137, 138) 05/08→11/17 | | | | |
|  Wheel Speed Sensor | | | | |
| 1.4 TSI | 90 | 08/08→11/17 | Construction year from: 09/08 →; Fitting Position: Front Axle Left | 24.0711-5271.3 360301 |
| | | | | |
| | | | Construction year from: 09/08 →; Fitting Position: Front Axle Right | 24.0711-5272.3 360302 |
| | | | | |
| 1.4 TSI | 92 - 110 | 11/13→11/17 | Fitting Position: Front Axle Left | 24.0711-5271.3 360301 |
| | | | | |



| | kW | | | |
|--|--------------------------|--|--|--|
| VW - SCIROCCO III (137, 138) 05/08→11/17 | | | | |
|  Wheel Speed Sensor | | | | |
| 2.0 R | 188 - 11/09→11/17 195 | Fitting Position: Front Axle Right | | 24.0711-5272.3 360302 |
| 2.0 TDI | 100 - 05/09→11/17 135 | | | |
| 2.0 TSI | 132 - 11/09→11/17 162 | | | |
| 1.4 TSI | 118 05/08→11/17 | Construction year from: 08/08 →; Fitting Position: Front Axle Left | | 24.0711-5271.3 360301 |
| 2.0 TFSI | 147 05/08→11/09 | Construction year from: 08/08 →; Fitting Position: Front Axle Right | | 24.0711-5272.3 360302 |
| 2.0 R | 206 05/14→11/17 | Construction year from: 08/14 →; Fitting Position: Front Axle Left | | 24.0711-5271.3 360301 |
| | | Construction year from: 08/14 →; Fitting Position: Front Axle Right | | 24.0711-5272.3 360302 |
| 2.0 TDI | 103 08/08→11/17 | Construction year from: 10/08 →; Fitting Position: Front Axle Left | | 24.0711-5271.3 360301 |
| | | Construction year from: 10/08 →; Fitting Position: Front Axle Right | | 24.0711-5272.3 360302 |
| VW - SCIROCCO Van (137) 06/08→05/14 | | | | |
|  Wheel Speed Sensor | | | | |
| 1.4 TSi | 90 08/08→05/14 | Construction year from: 09/08 →; Fitting Position: Front Axle Left | | 24.0711-5271.3 360301 |
| | | Construction year from: 09/08 →; Fitting Position: Front Axle Right | | 24.0711-5272.3 360302 |
| 1.4 TSi | 118 06/08→05/14 | Construction year from: 08/08 →; Fitting Position: Front Axle Left | | 24.0711-5271.3 360301 |
| | | Construction year from: 08/08 →; Fitting Position: Front Axle Right | | 24.0711-5272.3 360302 |
| 2.0 TDi | 103 08/08→05/14 | Construction year from: 10/08 →; Fitting Position: Front Axle Left | | 24.0711-5271.3 360301 |
| | | Construction year from: 10/08 →; Fitting Position: Front Axle Right | | 24.0711-5272.3 360302 |
| 2.0 TDi | 125 05/09→05/14 | Fitting Position: Front Axle Left | | 24.0711-5271.3 360301 |
| 2.0 TFSi | 155 11/09→05/14 | Fitting Position: Front Axle Right | | 24.0711-5272.3 360302 |
| VW - SHARAN (7N1, 7N2) 05/10→ | | | | |
|  Wheel Speed Sensor | | | | |
| 1.4 TSI | 110 05/10→ | Construction year from: 07/10 →; Fitting Position: Front Axle Left | | 24.0711-5271.3 360301 |
| 2.0 TDI | 100 - 05/10→ 103 | Construction year from: 07/10 →; Fitting Position: Front Axle Right | | 24.0711-5272.3 360302 |
| 1.4 TSI | 110 05/15→ | Fitting Position: Front Axle Left | | 24.0711-5271.3 360301 |
| 2.0 TDI | 85 - 08/10→ 135 | Fitting Position: Front Axle Right | | 24.0711-5272.3 360302 |
| 2.0 TDI 4motion | 103 - 05/11→ 135 | | | |
| 2.0 TFSI | 147 12/10→11/15 | | | |
| 2.0 TSI | 162 05/15→ | | | |
| VW - SHARAN VAN (7N1, 7N2) 05/10→ | | | | |
|  Wheel Speed Sensor | | | | |
| 1.4 TSI | 110 05/10→11/15 | Construction year from: 07/10 →; Fitting Position: Front Axle Left | | 24.0711-5271.3 360301 |
| 2.0 TDI | 100 - 05/10→11/15 103 | Construction year from: 07/10 →; Fitting Position: Front Axle Right | | 24.0711-5272.3 360302 |
| 2.0 TDI | 85 - 08/10→11/15 125 | Fitting Position: Front Axle Left | | 24.0711-5271.3 360301 |
| 2.0 TSI | 147 12/10→11/15 | Fitting Position: Front Axle Right | | 24.0711-5272.3 360302 |
| VW - TAOS (CL1, CQ1) 07/20→ | | | | |
|  Brake Pad Set, disc brake | | | | |
| 1.4 TSI | 110 10/20→ | for PR number: 1ZJ / 1ZK; Fitting Position: Front Axle | | 13.0470-2785.2 LD2785 Brake System: Lucas / TRW 25683 20,4 Wear Warning Contact: prepared for wear indicator / incl. wear warning contact Ceramic |
| 1.4 TSI 4motion | 110 05/21→ | | | |
| 1.6 MPI | 81 07/21→ | | | |
| VW - TIGUAN (5N_) 09/07→07/18 | | | | |
|  Wheel Speed Sensor | | | | |
| 1.4 TSI | 90 - 05/08→07/18 118 | Fitting Position: Front Axle Left | | 24.0711-5271.3 360301 |
| | | Fitting Position: Front Axle Right | | 24.0711-5272.3 360302 |
| → | | | | |

| | kW | | | | |
|--|-------------------|--|--|-----------------------|---|
| VW - TIGUAN (5N_) 09/07→07/18 | | | | | |
|  Wheel Speed Sensor | | | | | |
| 2.0 TDI | 81 - 03/08→07/18 | | Fitting Position: Front Axle Left | 24.0711-5271.3 | 360301 |
| | 110 | | Fitting Position: Front Axle Right | 24.0711-5272.3 | 360302 |
| 2.0 TFSI | 147 11/07→07/18 | | | | |
| 1.4 TSI 4motion | 110 - 09/07→07/18 | | Fitting Position: Front Axle Left | 24.0711-5271.3 | 360301 |
| | 118 | | Fitting Position: Front Axle Right | 24.0711-5272.3 | 360302 |
| 2.0 TDI 4motion | 100 - 11/07→07/18 | | Fitting Position: Rear Axle Left | 24.0711-5271.3 | 360301 |
| | 135 | | | | |
| 2.0 TFSI 4motion | 125 09/07→07/18 | | Fitting Position: Rear Axle Right | 24.0711-5272.3 | 360302 |
| 2.0 TSI 4motion | 132 - 05/11→07/18 | | | | |
| | 155 | | | | |
| 2.0 TDI 4motion | 103 09/07→07/18 | | Construction year from: 11/07 →; Fitting Position: Front Axle Left | 24.0711-5271.3 | 360301 |
| | | | Construction year from: 11/07 →; Fitting Position: Front Axle Right | 24.0711-5272.3 | 360302 |
| | | | Construction year from: 11/07 →; Fitting Position: Rear Axle Left | 24.0711-5271.3 | 360301 |
| | | | Construction year from: 11/07 →; Fitting Position: Rear Axle Right | 24.0711-5272.3 | 360302 |
| 2.0 TDI 4motion | 125 09/07→07/18 | | Construction year from: 01/08 →; Fitting Position: Front Axle Left | 24.0711-5271.3 | 360301 |
| | | | Construction year from: 01/08 →; Fitting Position: Front Axle Right | 24.0711-5272.3 | 360302 |
| | | | Construction year from: 01/08 →; Fitting Position: Rear Axle Left | 24.0711-5271.3 | 360301 |
| | | | Construction year from: 01/08 →; Fitting Position: Rear Axle Right | 24.0711-5272.3 | 360302 |
| 2.0 TFSI 4motion | 147 09/07→07/18 | | Construction year from: 02/08 →; Fitting Position: Front Axle Left | 24.0711-5271.3 | 360301 |
| | | | Construction year from: 02/08 →; Fitting Position: Front Axle Right | 24.0711-5272.3 | 360302 |
| | | | Construction year from: 02/08 →; Fitting Position: Rear Axle Left | 24.0711-5271.3 | 360301 |
| | | | Construction year from: 02/08 →; Fitting Position: Rear Axle Right | 24.0711-5272.3 | 360302 |
| VW - TIGUAN (AD1, AX1) 01/16→ | | | | | |
|  Brake Pad Set, disc brake | | | | | |
| 1.4 eHybrid | 110 11/20→ | | for PR number: 1ZA / 1ZD; | 13.0470-2785.2 | LD2785 Brake System: Lucas / TRW |
| 1.4 TSI | 92 - 01/16→07/18 | | Fitting Position: Front Axle | | 25683 20,4 |
| | 110 | | | | Wear Warning Contact: prepared |
| 1.4 TSI 4motion | 110 05/16→07/18 | | | | for wear indicator / incl. wear |
| 1.5 TSI | 96 - 07/18→ | | | | warning contact Ceramic |
| | 110 | | | | |
| 1.6 TDI | 85 05/16→06/20 | | | | |
| 2.0 TDI | 81 - 01/16→ | | | | |
| | 110 | | | | |
| 2.0 TDI 4motion | 110 - 01/16→ | | | | |
| | 176 | | | | |
| 2.0 TSI 4motion | 132 - 01/16→ | | | | |
| | 180 | | | | |
| VW - TIGUAN ALLSPACE (BW2, BJ2) 03/17→ | | | | | |
|  Brake Pad Set, disc brake | | | | | |
| 2.0 TDI 4motion | 110 06/17→ | | for PR number: 1ZA / 1ZK; | 13.0470-2785.2 | LD2785 Brake System: Lucas / TRW |
| | | | Fitting Position: Front Axle | | 25683 20,4 |
| | | | | | Wear Warning Contact: prepared |
| | | | | | for wear indicator / incl. wear |
| | | | | | warning contact Ceramic |
| VW - TIGUAN SUV Van (AD1) 07/15→ | | | | | |
|  Brake Pad Set, disc brake | | | | | |
| TDI BlueMotion | 140 01/16→07/20 | | for PR number: 1ZA / 1ZD; | 13.0470-2785.2 | LD2785 Brake System: Lucas / TRW |
| | | | Fitting Position: Front Axle | | 25683 20,4 |
| | | | | | Wear Warning Contact: prepared |
| | | | | | for wear indicator / incl. wear |
| | | | | | warning contact Ceramic |
| VW - TIGUAN VAN (5N_) 09/07→07/18 | | | | | |
|  Wheel Speed Sensor | | | | | |
| 1.4 TSI | 90 - 05/08→07/18 | | Fitting Position: Front Axle Left | 24.0711-5271.3 | 360301 |
| | 118 | | Fitting Position: Front Axle Right | 24.0711-5272.3 | 360302 |
| 2.0 TDI | 81 - 11/09→07/18 | | | | |
| | 103 | | | | |
| 1.4 TSI 4motion | 118 09/12→07/18 | | Fitting Position: Front Axle Left | 24.0711-5271.3 | 360301 |
| | | | Fitting Position: Front Axle Right | 24.0711-5272.3 | 360302 |

| | | kW | | | | | |
|---|-------------------|---|--|---|--|--|--|
| VW - TIGUAN VAN (5N_) 09/07→07/18 | | | | | | | |
|  Wheel Speed Sensor | | | | | | | |
| 2.0 TDI 4motion | 103 - 11/07→07/18 | Fitting Position: Rear Axle Left | | 24.0711-5271.3 360301 | | | |
| | 130 | | | | | | |
| 2.0 TSI 4motion | 125 - 11/09→07/18 | Fitting Position: Rear Axle Right | | 24.0711-5272.3 360302 | | | |
| | 155 | | | | | | |
| VW - TOUAREG (7LA, 7L6, 7L7) 10/02→01/13 | | | | | | | |
|  Brake Caliper | | | | | | | |
| 2.5 R5 TDI | 120 - 01/03→05/10 | for PR number: 1LB; → Construction year to: 03/10; Fitting Position: Front Axle Left | | 24.3601-9947.5 240597 Brake System: ATE Supplementary Article/Supplementary Info: without holder Brake Caliper Type: Fist-type Caliper | | | |
| | 128 | | | | | | |
| 3.0 TDI | 155 04/06→05/10 | for PR number: 1LB; → Construction year to: 03/10; Fitting Position: Front Axle Right | | 24.3601-9948.5 240598 Brake System: ATE Supplementary Article/Supplementary Info: without holder Brake Caliper Type: Fist-type Caliper | | | |
| 3.0 V6 TDI | 165 - 11/04→05/10 | | | | | | |
| | 176 | | | | | | |
| 3.2 V6 | 162 10/02→11/06 | Construction year from: 11/02 →; for PR number: 1LB; → Construction year to: 12/05; Fitting Position: Front Axle Left | | 24.3601-9947.5 240597 Brake System: ATE Supplementary Article/Supplementary Info: without holder Brake Caliper Type: Fist-type Caliper | | | |
| | | Construction year from: 11/02 →; for PR number: 1LB; → Construction year to: 12/05; Fitting Position: Front Axle Right | | | | | |
| 3.2 V6 | 177 11/04→11/06 | for PR number: 1LB; → Construction year to: 12/05; Fitting Position: Front Axle Left | | 24.3601-9947.5 240597 Brake System: ATE Supplementary Article/Supplementary Info: without holder Brake Caliper Type: Fist-type Caliper | | | |
| | | for PR number: 1LB; → Construction year to: 12/05; Fitting Position: Front Axle Right | | | | | |
| 3.6 V6 FSI | 206 10/05→05/10 | Construction year from: 01/06 → → Construction year to: 03/10; for PR number: 1LB; Fitting Position: Front Axle Left | | 24.3601-9947.5 240597 Brake System: ATE Supplementary Article/Supplementary Info: without holder Brake Caliper Type: Fist-type Caliper | | | |
| | | Construction year from: 01/06 → → Construction year to: 03/10; for PR number: 1LB; Fitting Position: Front Axle Right | | | | | |
| 4.2 V8 | 228 12/02→11/06 | for PR number: 1LB; Fitting Position: Front Axle Left | | 24.3601-9947.5 240597 Brake System: ATE Supplementary Article/Supplementary Info: without holder Brake Caliper Type: Fist-type Caliper | | | |
| | | for PR number: 1LB; Fitting Position: Front Axle Right | | | | | |
| 4.2 V8 FSI | 257 06/06→05/10 | Construction year from: 12/06 → → Construction year to: 03/10; for PR number: 1LB; Fitting Position: Front Axle Left | | 24.3601-9947.5 240597 Brake System: ATE Supplementary Article/Supplementary Info: without holder Brake Caliper Type: Fist-type Caliper | | | |
| | | Construction year from: 12/06 → → Construction year to: 03/10; for PR number: 1LB; Fitting Position: Front Axle Right | | | | | |
| 5.0 R50 TDI | 257 08/07→05/10 | Construction year from: 01/08 → → Construction year to: 03/10; for PR number: 1LB; Fitting Position: Front Axle Left | | 24.3601-9947.5 240597 Brake System: ATE Supplementary Article/Supplementary Info: without holder Brake Caliper Type: Fist-type Caliper | | | |
| | | Construction year from: 01/08 → → Construction year to: 03/10; for PR number: 1LB; Fitting Position: Front Axle Right | | | | | |
| → | | | | | | | |

| | kW | | | | |
|--|--------------------------|--|--|-------------------------|--|
| VW - TOUAREG (7LA, 7L6, 7L7) 10/02→01/13 | | | | | |
|  Brake Caliper | | | | | |
| 5.0 V10 TDI | 230 10/02→05/10 | Construction year from: 11/02 →; for PR number: 1LB; → Construction year to: 03/10; Fitting Position: Front Axle Left | | 24.3601-9947.5 240597 | Brake System: ATE Supplementary Article/Supplementary Info: without holder Brake Caliper Type: Fist-type Caliper |
| | | Construction year from: 11/02 →; for PR number: 1LB; → Construction year to: 03/10; Fitting Position: Front Axle Right | | | |
| 6.0 W12 | 331 08/04→05/10 | for PR number: 1LB; → Construction year to: 11/06; Fitting Position: Front Axle Left | | 24.3601-9947.5 240597 | Brake System: ATE Supplementary Article/Supplementary Info: without holder Brake Caliper Type: Fist-type Caliper |
| | | for PR number: 1LB; → Construction year to: 11/06; Fitting Position: Front Axle Right | | | |
| Spring, brake caliper | | | | | |
| 2.5 R5 TDI | 120 - 01/03→05/10 128 | for PR number: 1LB; → Construction year to: 03/10; Required quantity: 2 | | 2 11.8116-0237.1 390509 | Brake System: ATE |
| 3.0 TDI | 155 04/06→05/10 | | | | |
| 3.0 V6 TDI | 165 - 11/04→05/10 176 | | | | |
| 3.2 V6 | 162 10/02→11/06 | Construction year from: 11/02 →; for PR number: 1LB; → Construction year to: 12/05; Required quantity: 2 | | 2 11.8116-0237.1 390509 | Brake System: ATE |
| 3.2 V6 | 177 11/04→11/06 | for PR number: 1LB; → Construction year to: 12/05; Required quantity: 2 | | | |
| 3.6 V6 FSI | 206 10/05→05/10 | Construction year from: 01/06 → → Construction year to: 03/10; for PR number: 1LB; Required quantity: 2 | | 2 11.8116-0237.1 390509 | Brake System: ATE |
| 4.2 V8 | 228 12/02→11/06 | for PR number: 1LB; Required quantity: 2 | | | |
| 4.2 V8 FSI | 257 06/06→05/10 | Construction year from: 12/06 → → Construction year to: 03/10; for PR number: 1LB; Required quantity: 2 | | 2 11.8116-0237.1 390509 | Brake System: ATE |
| 5.0 R50 TDI | 257 08/07→05/10 | Construction year from: 01/08 → → Construction year to: 03/10; for PR number: 1LB; Required quantity: 2 | | | |
| 5.0 V10 TDI | 230 10/02→05/10 | Construction year from: 11/02 →; for PR number: 1LB; → Construction year to: 03/10; Required quantity: 2 | | 2 11.8116-0237.1 390509 | Brake System: ATE |
| 6.0 W12 | 331 08/04→05/10 | for PR number: 1LB; → Construction year to: 11/06; Required quantity: 2 | | | |
|  Brake Disc | | | | | |
| 2.5 R5 TDI | 120 - 01/03→05/10 128 | for PR number: 1LB; → Construction year to: 03/10; Fitting Position: Front Axle | | 24.0130-0114.1 430114 | Outer diameter [mm]: 308 Brake Disc Thickness [mm] 29.5 Minimum thickness [mm] 25.5 Brake Disc Type: Vented |
| 3.0 TDI | 155 04/06→05/10 | | | | |
| 3.0 V6 TDI | 165 - 11/04→05/10 176 | | | | |
| 3.2 V6 | 162 10/02→11/06 | Construction year from: 11/02 →; for PR number: 1LB; → Construction year to: 12/05; Fitting Position: Front Axle | | 24.0130-0114.1 430114 | Outer diameter [mm]: 308 Brake Disc Thickness [mm] 29.5 Minimum thickness [mm] 25.5 Brake Disc Type: Vented |
| 3.2 V6 | 177 11/04→11/06 | for PR number: 1LB; → Construction year to: 12/05; Fitting Position: Front Axle | | | |
| 3.6 V6 FSI | 206 10/05→05/10 | Construction year from: 01/06 → → Construction year to: 03/10; for PR number: 1LB; Fitting Position: Front Axle | | 24.0130-0114.1 430114 | Outer diameter [mm]: 308 Brake Disc Thickness [mm] 29.5 Minimum thickness [mm] 25.5 Brake Disc Type: Vented |
| 4.2 V8 | 228 12/02→11/06 | for PR number: 1LB; Fitting Position: Front Axle | | | |
| → | | | | | |

| | kW | | | | |
|--|-------------------|--|------------------------------|---|--|
| VW - TOUAREG (7LA, 7L6, 7L7) 10/02→01/13 | | | | | |
|  Brake Disc | | | | | |
| 4.2 V8 FSI | 257 06/06→05/10 | Construction year from: 12/06 → → Construction year to: 03/10; for PR number: 1LB; Fitting Position: Front Axle | 24.0130-0114.1 430114 | Outer diameter [mm]: 308 Brake Disc Thickness [mm] 29.5 Minimum thickness [mm] 25.5 Brake Disc Type: Vented | |
| 5.0 R50 TDI | 257 08/07→05/10 | Construction year from: 01/08 → → Construction year to: 03/10; for PR number: 1LB; Fitting Position: Front Axle | 24.0130-0114.1 430114 | Outer diameter [mm]: 308 Brake Disc Thickness [mm] 29.5 Minimum thickness [mm] 25.5 Brake Disc Type: Vented | |
| 5.0 V10 TDI | 230 10/02→05/10 | Construction year from: 11/02 → ; for PR number: 1LB; → Construction year to: 03/10; Fitting Position: Front Axle | 24.0130-0114.1 430114 | Outer diameter [mm]: 308 Brake Disc Thickness [mm] 29.5 Minimum thickness [mm] 25.5 Brake Disc Type: Vented | |
| 6.0 W12 | 331 08/04→05/10 | for PR number: 1LB; → Construction year to: 11/06; Fitting Position: Front Axle | 24.0130-0114.1 430114 | Outer diameter [mm]: 308 Brake Disc Thickness [mm] 29.5 Minimum thickness [mm] 25.5 Brake Disc Type: Vented | |
| VW - TOURAN (1T1, 1T2) 02/03→05/10 | | | | | |
|  Wheel Speed Sensor | | | | | |
| 1.4 TSI | 103 02/06→05/10 | Construction year from: 09/06 → ; Fitting Position: Front Axle Left | 24.0711-5271.3 360301 | | |
| | | Construction year from: 09/06 → ; Fitting Position: Front Axle Right | 24.0711-5272.3 360302 | | |
| 1.4 TSI | 125 11/06→05/10 | Fitting Position: Front Axle Left | 24.0711-5271.3 360301 | | |
| 1.4 TSI EcoFuel | 110 05/09→05/10 | Fitting Position: Front Axle Right | 24.0711-5272.3 360302 | | |
| 1.6 | 75 07/03→05/10 | | | | |
| 1.6 BiFuel | 75 11/06→05/10 | | | | |
| 1.6 FSI | 85 02/03→01/07 | | | | |
| 1.9 TDI | 66 - 02/03→05/10 | | | | |
| | 77 | | | | |
| 2.0 EcoFuel | 80 02/06→05/09 | | | | |
| 2.0 FSI | 110 10/03→01/07 | | | | |
| 2.0 TDI | 103 12/05→05/10 | | | | |
| 2.0 TDI 16V | 103 08/03→05/10 | | | | |
| 2.0 TDI | 100 02/03→05/10 | Construction year from: 08/03 → ; Fitting Position: Front Axle Left | 24.0711-5271.3 360301 | | |
| | | Construction year from: 08/03 → ; Fitting Position: Front Axle Right | 24.0711-5272.3 360302 | | |
| 2.0 TDI | 125 12/05→05/10 | Construction year from: 02/06 → ; Fitting Position: Front Axle Left | 24.0711-5271.3 360301 | | |
| | | Construction year from: 02/06 → ; Fitting Position: Front Axle Right | 24.0711-5272.3 360302 | | |
| VW - TOURAN (1T3) 05/10→05/15 | | | | | |
|  Wheel Speed Sensor | | | | | |
| 1.2 TSI | 77 05/10→05/15 | Fitting Position: Front Axle Left | 24.0711-5271.3 360301 | | |
| 1.4 TSI | 103 - 05/10→05/15 | Fitting Position: Front Axle Right | 24.0711-5272.3 360302 | | |
| | 125 | | | | |
| 1.4 TSI EcoFuel | 110 05/10→05/15 | | | | |
| 1.6 TDI | 66 - 05/10→05/15 | | | | |
| | 77 | | | | |
| 2.0 TDI | 81 - 05/10→05/15 | | | | |
| | 130 | | | | |
| VW - TOURAN (5T1) 05/15→ | | | | | |
|  Brake Pad Set, disc brake | | | | | |
| 1.0 TSI | 85 12/18→ | for PR number: 1ZK / 1ZL; Fitting Position: Front Axle | 13.0470-2785.2 LD2785 | Brake System: Lucas / TRW 25683 20,4 Wear Warning Contact: prepared for wear indicator / incl. wear warning contact Ceramic | |
| 1.2 TSI | 81 05/15→ | | | | |
| 1.4 TSI | 110 05/15→ | | | | |
| 1.5 TSI | 110 11/18→ | | | | |
| 1.6 TDI | 81 - 05/15→ | | | | |
| | 85 | | | | |
| 1.8 TSI | 132 11/15→ | | | | |
| 2.0 TDI | 81 - 05/15→ | | | | |
| | 140 | | | | |
| VW - TOURAN VAN (1T1, 1T2) 02/03→05/10 | | | | | |
|  Wheel Speed Sensor | | | | | |
| 1.9 TDI | 66 - 08/03→05/10 | Fitting Position: Front Axle Left | 24.0711-5271.3 360301 | | |
| | 77 | | | | |
| 2.0 EcoFuel | 80 02/06→11/06 | Fitting Position: Front Axle Right | 24.0711-5272.3 360302 | | |
| 2.0 FSI | 110 05/04→01/07 | | | | |
| 2.0 TDi | 103 08/03→05/10 | | | | |
| FSI | 85 02/03→11/06 | | | | |
| 2.0 TDI | 100 02/03→05/10 | Construction year from: 08/03 → ; Fitting Position: Front Axle Left | 24.0711-5271.3 360301 | | |

| | | | | | |
|--|-----------|-------------|--|---|---|
| | kW | | | | |
| VW - TOURAN VAN (1T1, 1T2) 02/03→05/10 | | | | | |
|  Wheel Speed Sensor | | | | | |
| 2.0 TDI | 100 | 02/03→05/10 | Construction year from: 08/03 →; Fitting Position: Front Axle Right | | 24.0711-5272.3 360302 |
| VW - TOURAN VAN (1T3) 05/10→05/15 | | | | | |
|  Wheel Speed Sensor | | | | | |
| 1.2 TSI | 77 | 05/10→05/15 | Fitting Position: Front Axle Left | | 24.0711-5271.3 360301 |
| 1.4 TSI | 103 - 125 | 05/10→05/15 | Fitting Position: Front Axle Right | | 24.0711-5272.3 360302 |
| 1.4 TSi EcoFuel | 110 | 05/10→05/15 | | | |
| 1.6 TDI | 66 - 77 | 05/10→05/15 | | | |
| 2.0 TDi | 125 | 05/10→01/13 | | | |
| 2.0 TDI | 103 | 05/10→05/15 | | | |
| VW - TOURAN VAN (5T1) 05/15→ | | | | | |
|  Brake Pad Set, disc brake | | | | | |
| 2.0 TDI | 90 - 110 | 11/20→ | for PR number: 1ZK / 1ZL; Fitting Position: Front Axle | | 13.0470-2785.2 LD2785 Brake System: Lucas / TRW 25683 20,4 Wear Warning Contact: prepared for wear indicator / incl. wear warning contact Ceramic |
| VW - TRANSPORTER IV Bus (70B, 70C, 7DB, 7DK, 70J, 70K, 7DC, 7DJ) 09/90→08/04 | | | | | |
| Spring, brake caliper | | | | | |
| 1.9 TD | 50 | 10/92→04/03 | Construction year from: 05/96 →; for PR number: 1LU; Required quantity: 2; Fitting Position: Front Axle | 2 | 11.8116-0237.1 390509 Brake System: ATE |
| 2.0 | 62 | 09/90→04/03 | | | |
| 2.4 D | 57 | 09/90→04/98 | | | |
| 2.5 | 81 | 09/90→06/03 | | | |
| 2.5 TDI | 75 | 09/95→04/03 | | | |
| 2.4 D | 55 | 08/97→04/03 | for PR number: 1LU; Required quantity: 2; Fitting Position: Front Axle | 2 | 11.8116-0237.1 390509 Brake System: ATE |
| 2.5 | 85 | 08/96→04/03 | | | |
| 2.5 Syncro | 85 | 07/96→04/03 | | | |
| 2.5 TDI | 65 - 111 | 05/98→04/03 | | | |
| 2.5 TDI Syncro | 75 | 01/96→04/03 | | | |
| 2.8 VR6 | 150 | 04/00→04/03 | | | |
| 2.8 VR 6 | 103 | 11/95→04/00 | | | |
| 2.4 D Syncro | 57 | 10/92→09/98 | Construction year from: 07/95 →; for PR number: 1LU; Required quantity: 2; Fitting Position: Front Axle | 2 | 11.8116-0237.1 390509 Brake System: ATE |
| 2.5 Syncro | 81 | 08/92→04/03 | | | |
| VW - TRANSPORTER IV Platform/Chassis (70E, 70L, 70M, 7DE, 7DL, 7D 07/90→04/03 | | | | | |
| Spring, brake caliper | | | | | |
| 1.9 TD | 50 | 10/92→04/03 | Construction year from: 05/96 →; for PR number: 1LU; Required quantity: 2; Fitting Position: Front Axle | 2 | 11.8116-0237.1 390509 Brake System: ATE |
| 2.0 | 62 | 07/90→04/03 | | | |
| 2.4 D | 57 | 09/90→04/98 | | | |
| 2.5 | 81 | 11/90→04/03 | | | |
| 2.5 TDI | 75 | 09/95→04/03 | | | |
| 2.4 D | 55 | 08/97→04/03 | for PR number: 1LU; Required quantity: 2; Fitting Position: Front Axle | 2 | 11.8116-0237.1 390509 Brake System: ATE |
| 2.5 | 85 | 08/96→04/03 | | | |
| 2.5 Syncro | 85 | 08/96→04/03 | | | |
| 2.5 TDI | 65 | 05/98→04/03 | | | |
| 2.5 TDI Syncro | 75 | 05/98→04/03 | | | |
| 2.4 D Syncro | 57 | 10/92→09/98 | Construction year from: 07/95 →; for PR number: 1LU; Required quantity: 2; Fitting Position: Front Axle | 2 | 11.8116-0237.1 390509 Brake System: ATE |
| 2.5 Syncro | 81 | 11/92→11/01 | | | |
| VW - TRANSPORTER IV Van (70A, 70H, 7DA, 7DH) 07/90→04/03 | | | | | |
| Spring, brake caliper | | | | | |
| 1.9 TD | 50 | 10/92→04/03 | Construction year from: 05/96 →; for PR number: 1LU; Required quantity: 2; Fitting Position: Front Axle | 2 | 11.8116-0237.1 390509 Brake System: ATE |
| 2.0 | 62 | 07/90→04/03 | | | |
| 2.4 D | 57 | 07/90→04/98 | | | |
| 2.5 | 81 | 11/90→04/03 | | | |
| 2.5 TDI | 75 | 09/95→04/03 | | | |
| 2.4 D | 55 | 08/97→04/03 | for PR number: 1LU; Required quantity: 2; Fitting Position: Front Axle | 2 | 11.8116-0237.1 390509 Brake System: ATE |
| 2.5 | 85 | 08/96→04/03 | | | |
| 2.5 Syncro | 81 - 85 | 01/96→04/03 | | | |
| 2.5 TDI | 65 - 111 | 12/98→04/03 | | | |
| 2.5 TDI Syncro | 75 | 09/95→04/03 | | | |
| 2.8 VR6 | 103 - 150 | 05/96→04/03 | | | |
| 2.4 D Syncro | 57 | 10/92→09/98 | Construction year from: 07/95 →; for PR number: 1LU; | 2 | 11.8116-0237.1 390509 Brake System: ATE |

| | | | | | |
|--|-----|-------------|--|------------------------------|--|
| | kW | | | | |
| VW - TRANSPORTER IV Van (70A, 70H, 7DA, 7DH) 07/90→04/03 | | | | | |
| Spring, brake caliper | | | | | |
| 2.4 D Syncro | 57 | 10/92→09/98 | Required quantity: 2; Fitting Position: Front Axle | | |
| VW - TRANSPORTER V Bus (7HB, 7HJ, 7EB, 7EJ) 04/03→08/15 | | | | | |
|  Brake Caliper | | | | | |
| 1.9 TDI | 62 | 01/06→11/09 | Vehicle Identification Number from: 7H-A-200001 →; for PR number: 2E4; Fitting Position: Front Axle Left | 24.3441-9933.5 241141 | Brake System: ATE Supplementary Article/Supplementary Info: without holder Brake Caliper Type: Fist-type Caliper (2 pistons) |
| 2.0 CNG | 75 | 01/06→08/15 | Vehicle Identification Number from: 7H-A-200001 →; for PR number: 2E4; Fitting Position: Front Axle Right | 24.3441-9934.5 241142 | Brake System: ATE Supplementary Article/Supplementary Info: without holder Brake Caliper Type: Fist-type Caliper (2 pistons) |
| | | | for PR number: 2E3; Fitting Position: Front Axle Left | 24.3601-9947.5 240597 | Brake System: ATE Supplementary Article/Supplementary Info: without holder Brake Caliper Type: Fist-type Caliper |
| | | | for PR number: 2E3; Fitting Position: Front Axle Right | 24.3601-9948.5 240598 | Brake System: ATE Supplementary Article/Supplementary Info: without holder Brake Caliper Type: Fist-type Caliper |
| | | | Vehicle Identification Number from: 7H-A-200001 →; Fitting Position: Rear Axle Left | 24.3414-1711.5 240852 | Brake System: Lucas / TRW Supplementary Article/Supplementary Info: without holder Brake Caliper Type: Fist-type Caliper |
| | | | Vehicle Identification Number from: 7H-6-000001 →; for PR number: 2E3 / 2E4; → Vehicle Identification Number to: 7H-A-050000; Fitting Position: Rear Axle Left | 24.3414-1711.5 240852 | Brake System: Lucas / TRW Supplementary Article/Supplementary Info: without holder Brake Caliper Type: Fist-type Caliper |
| | | | Vehicle Identification Number from: 7H-8-028000 →; for PR number: 0WR; → Vehicle Identification Number to: 7H-8-200000; Fitting Position: Rear Axle Left | 24.3414-1711.5 240852 | Brake System: Lucas / TRW Supplementary Article/Supplementary Info: without holder Brake Caliper Type: Fist-type Caliper |
| | | | Vehicle Identification Number from: 7H-A-200001 →; Fitting Position: Rear Axle Right | 24.3414-1712.5 240853 | Brake System: Lucas / TRW Supplementary Article/Supplementary Info: without holder Brake Caliper Type: Fist-type Caliper |
| | | | Vehicle Identification Number from: 7H-8-028000 →; for PR number: 0WR; → Vehicle Identification Number to: 7H-8-200000; Fitting Position: Rear Axle Right | 24.3414-1712.5 240853 | Brake System: Lucas / TRW Supplementary Article/Supplementary Info: without holder Brake Caliper Type: Fist-type Caliper |
| | | | Vehicle Identification Number from: 7H-6-000001 →; for PR number: 2E3 / 2E4; → Vehicle Identification Number to: 7H-A-050000; Fitting Position: Rear Axle Right | 24.3414-1712.5 240853 | Brake System: Lucas / TRW Supplementary Article/Supplementary Info: without holder Brake Caliper Type: Fist-type Caliper |
| 1.9 TDI | 63 | 04/03→11/09 | Vehicle Identification Number from: 7H-A-200001 →; for PR number: 2E4; Fitting Position: Front Axle Left | 24.3441-9933.5 241141 | Brake System: ATE Supplementary Article/Supplementary Info: without holder Brake Caliper Type: Fist-type Caliper (2 pistons) |
| 2.0 | 77 | 11/03→08/15 | | | |
| 2.5 TDi | 120 | 11/03→11/09 | | | |
| 2.5 TDI | 96 | 04/03→11/09 | | | |
| | 128 | | | | |
| 2.5 TDI 4motion | 96 | 07/04→11/09 | Vehicle Identification Number from: 7H-A-200001 →; for PR number: 2E4; Fitting Position: Front Axle Right | 24.3441-9934.5 241142 | Brake System: ATE Supplementary Article/Supplementary Info: without holder Brake Caliper Type: Fist-type Caliper (2 pistons) |
| | 128 | | | | |
| 3.2 V6 | 170 | 02/04→11/09 | | | |
| | 173 | | | | |
| | | | for PR number: 2E3; Fitting Position: Front Axle Left | 24.3601-9947.5 240597 | Brake System: ATE Supplementary Article/Supplementary Info: without holder Brake Caliper Type: Fist-type Caliper |
| | | | for PR number: 2E3; Fitting Position: Front Axle Right | 24.3601-9948.5 240598 | Brake System: ATE Supplementary Article/Supplementary Info: without holder Brake Caliper Type: Fist-type Caliper |
| → | | | | | |

| | kW | | | | |
|--|-----|-------------|---|------------------------------|--|
| VW - TRANSPORTER V Bus (7HB, 7HJ, 7EB, 7EJ) 04/03→08/15 | | | | | |
|  Brake Caliper | | | | | |
| 1.9 TDI | 63 | 04/03→11/09 | Vehicle Identification Number from: 7H-A-200001 →; | 24.3414-1711.5 240852 | Brake System: Lucas / TRW Supplementary Article/Supplementary Info: without holder Brake Caliper Type: Fist-type Caliper |
| 2.0 | 85 | 11/03→08/15 | Fitting Position: Rear Axle Left | | |
| 2.5 TDi | 120 | 11/03→11/09 | | | |
| 2.5 TDI | 96 | 04/03→11/09 | | | |
| | 128 | | | | |
| 2.5 TDI 4motion | 96 | 07/04→11/09 | for PR number: 0WL / 0WN / 0WM / 0WP / 0WQ; | 24.3414-1711.5 240852 | Brake System: Lucas / TRW Supplementary Article/Supplementary Info: without holder Brake Caliper Type: Fist-type Caliper |
| | 128 | | → Vehicle Identification Number to: 7H-5-120000; | | |
| 3.2 V6 | 170 | 02/04→11/09 | Fitting Position: Rear Axle Left | | |
| | 173 | | | | |
| | | | Vehicle Identification Number from: 7H-8-028000 →; for PR number: 0WR; | 24.3414-1711.5 240852 | Brake System: Lucas / TRW Supplementary Article/Supplementary Info: without holder Brake Caliper Type: Fist-type Caliper |
| | | | → Vehicle Identification Number to: 7H-8-200000; | | |
| | | | Fitting Position: Rear Axle Left | | |
| | | | Vehicle Identification Number from: 7H-6-000001 →; | 24.3414-1711.5 240852 | Brake System: Lucas / TRW Supplementary Article/Supplementary Info: without holder Brake Caliper Type: Fist-type Caliper |
| | | | for PR number: 2E3 / 2E4; | | |
| | | | → Vehicle Identification Number to: 7H-A-050000; Fitting Position: Rear Axle Left | | |
| | | | for PR number: 0WL / 0WN / 0WM / 0WP / 0WQ; | 24.3414-1712.5 240853 | Brake System: Lucas / TRW Supplementary Article/Supplementary Info: without holder Brake Caliper Type: Fist-type Caliper |
| | | | → Vehicle Identification Number to: 7H-5-120000; | | |
| | | | Fitting Position: Rear Axle Right | | |
| | | | Vehicle Identification Number from: 7H-A-200001 →; | 24.3414-1712.5 240853 | Brake System: Lucas / TRW Supplementary Article/Supplementary Info: without holder Brake Caliper Type: Fist-type Caliper |
| | | | Fitting Position: Rear Axle Right | | |
| | | | Vehicle Identification Number from: 7H-8-028000 →; for PR number: 0WR; | 24.3414-1712.5 240853 | Brake System: Lucas / TRW Supplementary Article/Supplementary Info: without holder Brake Caliper Type: Fist-type Caliper |
| | | | → Vehicle Identification Number to: 7H-8-200000; | | |
| | | | Fitting Position: Rear Axle Right | | |
| | | | Vehicle Identification Number from: 7H-6-000001 →; | 24.3414-1712.5 240853 | Brake System: Lucas / TRW Supplementary Article/Supplementary Info: without holder Brake Caliper Type: Fist-type Caliper |
| | | | for PR number: 2E3 / 2E4; | | |
| | | | → Vehicle Identification Number to: 7H-A-050000; | | |
| | | | Fitting Position: Rear Axle Right | | |
| 2.0 BiTDI | 132 | 09/09→08/15 | Vehicle Identification Number from: 7H-A-200001 →; for PR number: 2E4; | 24.3441-9933.5 241141 | Brake System: ATE Supplementary Article/Supplementary Info: without holder Brake Caliper Type: Fist-type Caliper (2 pistons) |
| 2.0 BiTDI 4motion | 132 | 09/09→08/15 | Fitting Position: Front Axle Left | | |
| 2.0 TDI | 62 | 09/09→08/15 | | | |
| | 103 | | | | |
| 2.0 TDI 4motion | 103 | 09/09→08/15 | | | |
| | | | Vehicle Identification Number from: 7H-A-200001 →; for PR number: 2E4; | 24.3441-9934.5 241142 | Brake System: ATE Supplementary Article/Supplementary Info: without holder Brake Caliper Type: Fist-type Caliper (2 pistons) |
| | | | Fitting Position: Front Axle Right | | |
| | | | for PR number: 2E3; | 24.3601-9947.5 240597 | Brake System: ATE Supplementary Article/Supplementary Info: without holder Brake Caliper Type: Fist-type Caliper |
| | | | Fitting Position: Front Axle Left | | |
| | | | for PR number: 2E3; | 24.3601-9948.5 240598 | Brake System: ATE Supplementary Article/Supplementary Info: without holder Brake Caliper Type: Fist-type Caliper |
| | | | Fitting Position: Front Axle Right | | |
| | | | Vehicle Identification Number from: 7H-A-200001 →; | 24.3414-1711.5 240852 | Brake System: Lucas / TRW Supplementary Article/Supplementary Info: without holder Brake Caliper Type: Fist-type Caliper |
| | | | Fitting Position: Rear Axle Left | | |
| | | | Vehicle Identification Number from: 7H-6-000001 →; | 24.3414-1711.5 240852 | Brake System: Lucas / TRW Supplementary Article/Supplementary Info: without holder Brake Caliper Type: Fist-type Caliper |
| | | | for PR number: 2E3 / 2E4; | | |
| | | | → Vehicle Identification Number to: 7H-A-050000; Fitting Position: Rear Axle Left | | |
| | | | Vehicle Identification Number from: 7H-A-200001 →; | 24.3414-1712.5 240853 | Brake System: Lucas / TRW Supplementary Article/Supplementary Info: without holder Brake Caliper Type: Fist-type Caliper |
| | | | Fitting Position: Rear Axle Right | | |



→

| | | kW | | | | | |
|--|-----------|-------------|--|------------------------------|--|--|--|
| VW - TRANSPORTER V Bus (7HB, 7HJ, 7EB, 7EJ) 04/03→08/15 | | | | | | | |
|  Brake Caliper | | | | | | | |
| 2.0 BiTDI | 132 | 09/09→08/15 | Vehicle Identification Number from: 7H-6-000001 →; for PR number: 2E3 / 2E4; → Vehicle Identification Number to: 7H-A-050000; Fitting Position: Rear Axle Right | 24.3414-1712.5 240853 | Brake System: Lucas / TRW Supplementary Article/Supplementary Info: without holder Brake Caliper Type: Fist-type Caliper | | |
| 2.0 BiTDI 4motion | 132 | 09/09→08/15 | | | | | |
| 2.0 TDI | 62 - 103 | 09/09→08/15 | | | | | |
| 2.0 TDI 4motion | 103 | 09/09→08/15 | | | | | |
| 2.0 TDI | 84 - 85 | 05/11→08/15 | for PR number: 2E4; Fitting Position: Front Axle Left | 24.3441-9933.5 241141 | Brake System: ATE Supplementary Article/Supplementary Info: without holder Brake Caliper Type: Fist-type Caliper (2 pistons) | | |
| 2.0 TSI | 110 - 150 | 05/11→08/15 | | | | | |
| 2.0 TSI 4motion | 150 | 07/11→08/15 | for PR number: 2E4; Fitting Position: Front Axle Right | 24.3441-9934.5 241142 | Brake System: ATE Supplementary Article/Supplementary Info: without holder Brake Caliper Type: Fist-type Caliper (2 pistons) | | |
| | | | for PR number: 2E3; Fitting Position: Front Axle Left | 24.3601-9947.5 240597 | Brake System: ATE Supplementary Article/Supplementary Info: without holder Brake Caliper Type: Fist-type Caliper | | |
| | | | for PR number: 2E3; Fitting Position: Front Axle Right | 24.3601-9948.5 240598 | Brake System: ATE Supplementary Article/Supplementary Info: without holder Brake Caliper Type: Fist-type Caliper | | |
| | | | Fitting Position: Rear Axle Left | 24.3414-1711.5 240852 | Brake System: Lucas / TRW Supplementary Article/Supplementary Info: without holder Brake Caliper Type: Fist-type Caliper | | |
| | | | Fitting Position: Rear Axle Right | 24.3414-1712.5 240853 | Brake System: Lucas / TRW Supplementary Article/Supplementary Info: without holder Brake Caliper Type: Fist-type Caliper | | |
| 2.0 TDI | 100 | 05/10→08/15 | Vehicle Identification Number from: 7H-A-200001 →; for PR number: 2E4; Fitting Position: Front Axle Left | 24.3441-9933.5 241141 | Brake System: ATE Supplementary Article/Supplementary Info: without holder Brake Caliper Type: Fist-type Caliper (2 pistons) | | |
| 2.0 TDI 4motion | 100 | 05/10→08/15 | | | | | |
| | | | Vehicle Identification Number from: 7H-A-200001 →; for PR number: 2E4; Fitting Position: Front Axle Right | 24.3441-9934.5 241142 | Brake System: ATE Supplementary Article/Supplementary Info: without holder Brake Caliper Type: Fist-type Caliper (2 pistons) | | |
| | | | for PR number: 2E3; Fitting Position: Front Axle Left | 24.3601-9947.5 240597 | Brake System: ATE Supplementary Article/Supplementary Info: without holder Brake Caliper Type: Fist-type Caliper | | |
| | | | for PR number: 2E3; Fitting Position: Front Axle Right | 24.3601-9948.5 240598 | Brake System: ATE Supplementary Article/Supplementary Info: without holder Brake Caliper Type: Fist-type Caliper | | |
| | | | Vehicle Identification Number from: 7H-A-200001 →; Fitting Position: Rear Axle Left | 24.3414-1711.5 240852 | Brake System: Lucas / TRW Supplementary Article/Supplementary Info: without holder Brake Caliper Type: Fist-type Caliper | | |
| | | | Vehicle Identification Number from: 7H-A-200001 →; Fitting Position: Rear Axle Right | 24.3414-1712.5 240853 | Brake System: Lucas / TRW Supplementary Article/Supplementary Info: without holder Brake Caliper Type: Fist-type Caliper | | |
| 3.2 V6 4motion | 170 - 173 | 11/03→12/09 | Vehicle Identification Number from: 7H-A-200001 →; for PR number: 2E4; Fitting Position: Front Axle Left | 24.3441-9933.5 241141 | Brake System: ATE Supplementary Article/Supplementary Info: without holder Brake Caliper Type: Fist-type Caliper (2 pistons) | | |
| | | | Vehicle Identification Number from: 7H-A-200001 →; for PR number: 2E4; Fitting Position: Front Axle Right | | | | |

→



| | kW | | | | |
|--|--------------------------|--|---|------------------------------|--|
| VW - TRANSPORTER V Bus (7HB, 7HJ, 7EB, 7EJ) 04/03→08/15 | | | | | |
|  Brake Caliper | | | | | |
| 3.2 V6 4motion | 170 - 11/03→12/09 173 | Construction year from: 07/04 →; for PR number: 2E3; Fitting Position: Front Axle Left | | 24.3601-9947.5 240597 | Brake System: ATE Supplementary Article/Supplementary Info: without holder Brake Caliper Type: Fist-type Caliper |
| | | Construction year from: 07/04 →; for PR number: 2E3; Fitting Position: Front Axle Right | | 24.3601-9948.5 240598 | Brake System: ATE Supplementary Article/Supplementary Info: without holder Brake Caliper Type: Fist-type Caliper |
| | | Vehicle Identification Number from: 7H-A-200001 →; Fitting Position: Rear Axle Left | | 24.3414-1711.5 240852 | Brake System: Lucas / TRW Supplementary Article/Supplementary Info: without holder Brake Caliper Type: Fist-type Caliper |
| | | Construction year from: 07/04 →; for PR number: 0WL / 0WN / 0WM / 0WP / 0WQ; → Vehicle Identification Number to: 7H-5-120000; Fitting Position: Rear Axle Left | | 24.3414-1711.5 240852 | Brake System: Lucas / TRW Supplementary Article/Supplementary Info: without holder Brake Caliper Type: Fist-type Caliper |
| | | Vehicle Identification Number from: 7H-8-028000 →; for PR number: 0WR; → Vehicle Identification Number to: 7H-8-200000; Fitting Position: Rear Axle Left | | 24.3414-1711.5 240852 | Brake System: Lucas / TRW Supplementary Article/Supplementary Info: without holder Brake Caliper Type: Fist-type Caliper |
| | | Vehicle Identification Number from: 7H-6-000001 →; for PR number: 2E3 / 2E4; → Vehicle Identification Number to: 7H-A-050000; Fitting Position: Rear Axle Left | | 24.3414-1711.5 240852 | Brake System: Lucas / TRW Supplementary Article/Supplementary Info: without holder Brake Caliper Type: Fist-type Caliper |
| | | Construction year from: 07/04 →; for PR number: 0WL / 0WN / 0WM / 0WP / 0WQ; → Vehicle Identification Number to: 7H-5-120000; Fitting Position: Rear Axle Right | | 24.3414-1712.5 240853 | Brake System: Lucas / TRW Supplementary Article/Supplementary Info: without holder Brake Caliper Type: Fist-type Caliper |
| | | Vehicle Identification Number from: 7H-A-200001 →; Fitting Position: Rear Axle Right | | 24.3414-1712.5 240853 | Brake System: Lucas / TRW Supplementary Article/Supplementary Info: without holder Brake Caliper Type: Fist-type Caliper |
| | | Vehicle Identification Number from: 7H-8-028000 →; for PR number: 0WR; → Vehicle Identification Number to: 7H-8-200000; Fitting Position: Rear Axle Right | | 24.3414-1712.5 240853 | Brake System: Lucas / TRW Supplementary Article/Supplementary Info: without holder Brake Caliper Type: Fist-type Caliper |
| | | Vehicle Identification Number from: 7H-6-000001 →; for PR number: 2E3 / 2E4; → Vehicle Identification Number to: 7H-A-050000; Fitting Position: Rear Axle Right | | 24.3414-1712.5 240853 | Brake System: Lucas / TRW Supplementary Article/Supplementary Info: without holder Brake Caliper Type: Fist-type Caliper |
| Spring, brake caliper | | | | | |
| 1.9 TDI | 62 - 04/03→11/09 77 | Vehicle Identification Number from: 7H-A-200001 →; for PR number: 2E4; Required quantity: 2 | 2 | 11.8116-0126.2 390608 | Brake System: ATE |
| 2.0 | 85 11/03→08/15 | | | | |
| 2.0 BiTDI | 132 09/09→08/15 | | | | |
| 2.0 BiTDI 4motion | 132 09/09→08/15 | | | | |
| 2.0 CNG | 85 01/06→08/15 | | | | |
| 2.0 TDI | 62 - 09/09→08/15 103 | → Vehicle Identification Number to: 7H-A-050000; for PR number: 2E4; Required quantity: 2 | 2 | 11.8116-0237.1 390509 | Brake System: ATE |
| 2.0 TDI 4motion | 103 09/09→08/15 | for PR number: 2E3; Required quantity: 2 | 2 | 11.8116-0237.1 390509 | Brake System: ATE |
| 2.5 TDi | 120 11/03→11/09 | | | | |
| 2.5 TDI | 96 - 04/03→11/09 128 | | | | |
| 2.5 TDI 4motion | 96 - 07/04→11/09 128 | | | | |
| 3.2 V6 | 170 - 02/04→11/09 173 | | | | |
| 2.0 TDI | 84 - 05/11→08/15 85 | for PR number: 2E4; Required quantity: 2 | 2 | 11.8116-0126.2 390608 | Brake System: ATE |
| 2.0 TSI | 110 - 05/11→08/15 150 | for PR number: 2E3; Required quantity: 2 | 2 | 11.8116-0237.1 390509 | Brake System: ATE |
| 2.0 TSI 4motion | 150 07/11→08/15 | | | | |
| 2.0 TDI | 100 05/10→08/15 | Vehicle Identification Number from: 7H-A-200001 →; for PR number: 2E4; Required quantity: 2 | 2 | 11.8116-0126.2 390608 | Brake System: ATE |
| 2.0 TDI 4motion | 100 05/10→08/15 | | | | |
| → | | | | | |



| | kW | | | | |
|--|-----------|-------------|---|---|--|
| VW - TRANSPORTER V Bus (7HB, 7HJ, 7EB, 7EJ) 04/03→08/15 | | | | | |
| Spring, brake caliper | | | | | |
| 2.0 TDI | 100 | 05/10→08/15 | for PR number: 2E3; Required quantity: 2 | 2 | 11.8116-0237.1 390509 Brake System: ATE |
| 2.0 TDI 4motion | 100 | 05/10→08/15 | | | |
| 3.2 V6 4motion | 170 - 173 | 11/03→12/09 | Vehicle Identification Number from: 7H-A-200001 →; for PR number: 2E4; Required quantity: 2 | 2 | 11.8116-0126.2 390608 Brake System: ATE |
| | | | Construction year from: 07/04 →; for PR number: 2E3; Required quantity: 2 | 2 | 11.8116-0237.1 390509 Brake System: ATE |
| | | | Construction year from: 07/04 →; → Vehicle Identification Number to: 7H-A-050000; for PR number: 2E4; Required quantity: 2 | 2 | 11.8116-0237.1 390509 Brake System: ATE |
|  Brake Pad Set, disc brake | | | | | |
| 1.9 TDI | 62 - 75 | 01/06→11/09 | for PR number: 2E3; Fitting Position: Front Axle | | 13.0460-7236.2 607236 Brake System: ATE 23746 19,7 Wear Warning Contact: incl. wear warning contact |
| 2.0 CNG | 85 | 01/06→08/15 | | | |
| | | | Vehicle Identification Number from: 7H-A-200001 →; for PR number: 2E4; Fitting Position: Front Axle | | 13.0460-7286.2 607286 Brake System: ATE 24623 18,2 Wear Warning Contact: incl. wear warning contact |
| | | | Vehicle Identification Number from: 7H-A-200001 →; Fitting Position: Rear Axle | | 13.0460-2882.2 602882 Brake System: Lucas / TRW 23326 17,4 Wear Warning Contact: incl. wear warning contact Supplementary Article/Supplementary Info: with accessories |
| | | | Vehicle Identification Number from: 7H-8-028000 →; for PR number: 0WR; → Vehicle Identification Number to: 7H-8-200000; Fitting Position: Rear Axle | | 13.0460-2882.2 602882 Brake System: Lucas / TRW 23326 17,4 Wear Warning Contact: incl. wear warning contact Supplementary Article/Supplementary Info: with accessories |
| | | | Vehicle Identification Number from: 7H-6-000001 →; for PR number: 2E3 / 2E4; → Vehicle Identification Number to: 7H-A-050000; Fitting Position: Rear Axle | | 13.0460-2882.2 602882 Brake System: Lucas / TRW 23326 17,4 Wear Warning Contact: incl. wear warning contact Supplementary Article/Supplementary Info: with accessories |
| 1.9 TDI | 63 - 77 | 04/03→11/09 | for PR number: 2E3; Fitting Position: Front Axle | | 13.0460-7236.2 607236 Brake System: ATE 23746 19,7 Wear Warning Contact: incl. wear warning contact |
| 2.0 | 85 | 11/03→08/15 | | | |
| 2.5 TDi | 120 | 11/03→11/09 | | | |
| 2.5 TDI | 96 - 128 | 04/03→11/09 | Vehicle Identification Number from: 7H-A-200001 →; for PR number: 2E4; Fitting Position: Front Axle | | 13.0460-7286.2 607286 Brake System: ATE 24623 18,2 Wear Warning Contact: incl. wear warning contact |
| 2.5 TDI 4motion | 96 - 128 | 07/04→11/09 | | | |
| 3.2 V6 | 170 - 173 | 02/04→11/09 | Vehicle Identification Number from: 7H-A-200001 →; Fitting Position: Rear Axle | | 13.0460-2882.2 602882 Brake System: Lucas / TRW 23326 17,4 Wear Warning Contact: incl. wear warning contact Supplementary Article/Supplementary Info: with accessories |
| | | | for PR number: 0WL / 0WN / 0WM / 0WP / 0WQ; → Vehicle Identification Number to: 7H-5-120000; Fitting Position: Rear Axle | | 13.0460-2882.2 602882 Brake System: Lucas / TRW 23326 17,4 Wear Warning Contact: incl. wear warning contact Supplementary Article/Supplementary Info: with accessories |
| | | | Vehicle Identification Number from: 7H-6-000001 →; for PR number: 2E3 / 2E4; → Vehicle Identification Number to: 7H-A-050000; Fitting Position: Rear Axle | | 13.0460-2882.2 602882 Brake System: Lucas / TRW 23326 17,4 Wear Warning Contact: incl. wear warning contact Supplementary Article/Supplementary Info: with accessories |
| | | | Vehicle Identification Number from: 7H-8-028000 →; for PR number: 0WR; → Vehicle Identification Number to: 7H-8-200000; Fitting Position: Rear Axle | | 13.0460-2882.2 602882 Brake System: Lucas / TRW 23326 17,4 Wear Warning Contact: incl. wear warning contact Supplementary Article/Supplementary Info: with accessories |
| 2.0 BiTDI | 132 | 09/09→08/15 | for PR number: 2E3; Fitting Position: Front Axle | | 13.0460-7236.2 607236 Brake System: ATE 23746 19,7 Wear Warning Contact: incl. wear warning contact |
| 2.0 BiTDI 4motion | 132 | 09/09→08/15 | | | |
| 2.0 TDI | 62 - 103 | 09/09→08/15 | | | |
| 2.0 TDI 4motion | 103 | 09/09→08/15 | Vehicle Identification Number from: 7H-A-200001 →; for PR number: 2E4; Fitting Position: Front Axle | | 13.0460-7286.2 607286 Brake System: ATE 24623 18,2 Wear Warning Contact: incl. wear warning contact |
| → | | | | | |



| | kW | | | | |
|--|--|--|------------------------------|--|--|
| VW - TRANSPORTER V Bus (7HB, 7HJ, 7EB, 7EJ) 04/03→08/15 | | | | | |
|  Brake Pad Set, disc brake | | | | | |
| 2.0 BiTDI 2.0 BiTDI 4motion 2.0 TDI 2.0 TDI 4motion | 132 09/09→08/15 132 09/09→08/15 62 - 09/09→08/15 103 103 09/09→08/15 | Vehicle Identification Number from: 7H-A-200001 →; Fitting Position: Rear Axle | 13.0460-2882.2 602882 | Brake System: Lucas / TRW 23326 17,4 Wear Warning Contact: incl. wear warning contact Supplementary Article/Supplementary Info: with accessories | |
| | | Vehicle Identification Number from: 7H-6-000001 →; for PR number: 2E3 / 2E4; → Vehicle Identification Number to: 7H-A-050000; Fitting Position: Rear Axle | 13.0460-2882.2 602882 | Brake System: Lucas / TRW 23326 17,4 Wear Warning Contact: incl. wear warning contact Supplementary Article/Supplementary Info: with accessories | |
| 2.0 TDI 2.0 TSI 2.0 TSI 4motion | 84 - 05/11→08/15 85 110 - 05/11→08/15 150 150 07/11→08/15 | for PR number: 2E3; Fitting Position: Front Axle | 13.0460-7236.2 607236 | Brake System: ATE 23746 19,7 Wear Warning Contact: incl. wear warning contact | |
| | | for PR number: 2E4; Fitting Position: Front Axle | 13.0460-7286.2 607286 | Brake System: ATE 24623 18,2 Wear Warning Contact: incl. wear warning contact | |
| | | Fitting Position: Rear Axle | 13.0460-2882.2 602882 | Brake System: Lucas / TRW 23326 17,4 Wear Warning Contact: incl. wear warning contact Supplementary Article/Supplementary Info: with accessories | |
| 2.0 TDI 2.0 TDI 4motion | 100 05/10→08/15 100 05/10→08/15 | for PR number: 2E3; Fitting Position: Front Axle | 13.0460-7236.2 607236 | Brake System: ATE 23746 19,7 Wear Warning Contact: incl. wear warning contact | |
| | | Vehicle Identification Number from: 7H-A-200001 →; for PR number: 2E4; Fitting Position: Front Axle | 13.0460-7286.2 607286 | Brake System: ATE 24623 18,2 Wear Warning Contact: incl. wear warning contact | |
| | | Vehicle Identification Number from: 7H-A-200001 →; Fitting Position: Rear Axle | 13.0460-2882.2 602882 | Brake System: Lucas / TRW 23326 17,4 Wear Warning Contact: incl. wear warning contact Supplementary Article/Supplementary Info: with accessories | |
| 3.2 V6 4motion | 170 - 11/03→12/09 173 | Construction year from: 07/04 →; for PR number: 2E3; Fitting Position: Front Axle | 13.0460-7236.2 607236 | Brake System: ATE 23746 19,7 Wear Warning Contact: incl. wear warning contact | |
| | | Vehicle Identification Number from: 7H-A-200001 →; for PR number: 2E4; Fitting Position: Front Axle | 13.0460-7286.2 607286 | Brake System: ATE 24623 18,2 Wear Warning Contact: incl. wear warning contact | |
| | | Vehicle Identification Number from: 7H-A-200001 →; Fitting Position: Rear Axle | 13.0460-2882.2 602882 | Brake System: Lucas / TRW 23326 17,4 Wear Warning Contact: incl. wear warning contact Supplementary Article/Supplementary Info: with accessories | |
| | | Construction year from: 07/04 →; for PR number: 0WL / 0WN / 0WM / 0WP / 0WQ; → Vehicle Identification Number to: 7H-5-120000; Fitting Position: Rear Axle | 13.0460-2882.2 602882 | Brake System: Lucas / TRW 23326 17,4 Wear Warning Contact: incl. wear warning contact Supplementary Article/Supplementary Info: with accessories | |
| | | Vehicle Identification Number from: 7H-8-028000 →; for PR number: 0WR; → Vehicle Identification Number to: 7H-8-200000; Fitting Position: Rear Axle | 13.0460-2882.2 602882 | Brake System: Lucas / TRW 23326 17,4 Wear Warning Contact: incl. wear warning contact Supplementary Article/Supplementary Info: with accessories | |
| | | Vehicle Identification Number from: 7H-6-000001 →; for PR number: 2E3 / 2E4; → Vehicle Identification Number to: 7H-A-050000; Fitting Position: Rear Axle | 13.0460-2882.2 602882 | Brake System: Lucas / TRW 23326 17,4 Wear Warning Contact: incl. wear warning contact Supplementary Article/Supplementary Info: with accessories | |
|  Brake Disc | | | | | |
| 1.9 TDI 2.0 CNG → | 62 - 01/06→11/09 75 85 01/06→08/15 | for PR number: 2E3; Fitting Position: Front Axle | 24.0130-0114.1 430114 | Outer diameter [mm]: 308 Brake Disc Thickness [mm] 29.5 Minimum thickness [mm] 25.5 Brake Disc Type: Vented | |

| | kW | | | | |
|---|--|---|------------------------------|---|--|
| VW - TRANSPORTER V Bus (7HB, 7HJ, 7EB, 7EJ) 04/03→08/15 | | | | | |
|  Brake Disc | | | | | |
| 1.9 TDI 2.0 CNG | 62 - 01/06→11/09 75 85 01/06→08/15 | Vehicle Identification Number from: 7H-A-200001 →; for PR number: 2E4; Fitting Position: Front Axle | 24.0133-0100.1 433100 | Outer diameter [mm]: 340 Brake Disc Thickness [mm] 32.6 Minimum thickness [mm] 29.5 Brake Disc Type: Vented Supplementary Article/Info 2: with bolts/screws | |
| | | Vehicle Identification Number from: 7H-A-200001 →; Fitting Position: Rear Axle | 24.0122-0211.1 422211 | Outer diameter [mm]: 294 Brake Disc Thickness [mm] 21.9 Minimum thickness [mm] 19.5 Brake Disc Type: Vented Supplementary Article/Info 2: with bolts/screws | |
| | | Vehicle Identification Number from: 7H-8-028000 →; for PR number: 0WR; → Vehicle Identification Number to: 7H-8-200000; Fitting Position: Rear Axle | 24.0122-0211.1 422211 | Outer diameter [mm]: 294 Brake Disc Thickness [mm] 21.9 Minimum thickness [mm] 19.5 Brake Disc Type: Vented Supplementary Article/Info 2: with bolts/screws | |
| | | Vehicle Identification Number from: 7H-6-000001 →; for PR number: 2E3 / 2E4; → Vehicle Identification Number to: 7H-A-050000; Fitting Position: Rear Axle | 24.0122-0211.1 422211 | Outer diameter [mm]: 294 Brake Disc Thickness [mm] 21.9 Minimum thickness [mm] 19.5 Brake Disc Type: Vented Supplementary Article/Info 2: with bolts/screws | |
| 1.9 TDI 2.0 2.5 TDi 2.5 TDI | 63 - 04/03→11/09 77 85 11/03→08/15 120 11/03→11/09 96 - 04/03→11/09 128 | for PR number: 2E3; Fitting Position: Front Axle | 24.0130-0114.1 430114 | Outer diameter [mm]: 308 Brake Disc Thickness [mm] 29.5 Minimum thickness [mm] 25.5 Brake Disc Type: Vented | |
| 2.5 TDI 4motion 3.2 V6 | 96 - 07/04→11/09 128 170 - 02/04→11/09 173 | Vehicle Identification Number from: 7H-A-200001 →; for PR number: 2E4; Fitting Position: Front Axle | 24.0133-0100.1 433100 | Outer diameter [mm]: 340 Brake Disc Thickness [mm] 32.6 Minimum thickness [mm] 29.5 Brake Disc Type: Vented Supplementary Article/Info 2: with bolts/screws | |
| | | Vehicle Identification Number from: 7H-A-200001 →; Fitting Position: Rear Axle | 24.0122-0211.1 422211 | Outer diameter [mm]: 294 Brake Disc Thickness [mm] 21.9 Minimum thickness [mm] 19.5 Brake Disc Type: Vented Supplementary Article/Info 2: with bolts/screws | |
| | | for PR number: 0WL / 0WN / 0WM / 0WP / 0WQ; → Vehicle Identification Number to: 7H-5-120000; Fitting Position: Rear Axle | 24.0122-0211.1 422211 | Outer diameter [mm]: 294 Brake Disc Thickness [mm] 21.9 Minimum thickness [mm] 19.5 Brake Disc Type: Vented Supplementary Article/Info 2: with bolts/screws | |
| | | Vehicle Identification Number from: 7H-6-000001 →; for PR number: 2E3 / 2E4; → Vehicle Identification Number to: 7H-A-050000; Fitting Position: Rear Axle | 24.0122-0211.1 422211 | Outer diameter [mm]: 294 Brake Disc Thickness [mm] 21.9 Minimum thickness [mm] 19.5 Brake Disc Type: Vented Supplementary Article/Info 2: with bolts/screws | |
| | | Vehicle Identification Number from: 7H-8-028000 →; for PR number: 0WR; → Vehicle Identification Number to: 7H-8-200000; Fitting Position: Rear Axle | 24.0122-0211.1 422211 | Outer diameter [mm]: 294 Brake Disc Thickness [mm] 21.9 Minimum thickness [mm] 19.5 Brake Disc Type: Vented Supplementary Article/Info 2: with bolts/screws | |
| 2.0 BiTDI 2.0 BiTDI 4motion 2.0 TDI | 132 09/09→08/15 132 09/09→08/15 62 - 09/09→08/15 103 | for PR number: 2E3; Fitting Position: Front Axle | 24.0130-0114.1 430114 | Outer diameter [mm]: 308 Brake Disc Thickness [mm] 29.5 Minimum thickness [mm] 25.5 Brake Disc Type: Vented | |
| 2.0 TDI 4motion | 103 09/09→08/15 | Vehicle Identification Number from: 7H-A-200001 →; for PR number: 2E4; Fitting Position: Front Axle | 24.0133-0100.1 433100 | Outer diameter [mm]: 340 Brake Disc Thickness [mm] 32.6 Minimum thickness [mm] 29.5 Brake Disc Type: Vented Supplementary Article/Info 2: with bolts/screws | |
| | | Vehicle Identification Number from: 7H-A-200001 →; Fitting Position: Rear Axle | 24.0122-0211.1 422211 | Outer diameter [mm]: 294 Brake Disc Thickness [mm] 21.9 Minimum thickness [mm] 19.5 Brake Disc Type: Vented Supplementary Article/Info 2: with bolts/screws | |

→

| | kW | | | | |
|---|--|--|--------------------------------|--|--|
| VW - TRANSPORTER V Bus (7HB, 7HJ, 7EB, 7EJ) 04/03→08/15 | | | | | |
|  Brake Disc | | | | | |
| 2.0 BiTDI 2.0 BiTDI 4motion 2.0 TDI 2.0 TDI 4motion | 132 09/09→08/15 132 09/09→08/15 62 - 09/09→08/15 103 103 09/09→08/15 | Vehicle Identification Number from: 7H-6-000001 →; for PR number: 2E3 / 2E4; → Vehicle Identification Number to: 7H- A-050000; Fitting Position: Rear Axle | 24.0122-0211.1 422211 | Outer diameter [mm]: 294 Brake Disc Thickness [mm] 21.9 Minimum thickness [mm] 19.5 Brake Disc Type: Vented Supplementary Article/Info 2: with bolts/screws | |
| 2.0 TDI 2.0 TSI 2.0 TSI 4motion | 84 - 05/11→08/15 85 110 - 05/11→08/15 150 150 07/11→08/15 | for PR number: 2E3; Fitting Position: Front Axle | 24.0130-0114.1 430114 | Outer diameter [mm]: 308 Brake Disc Thickness [mm] 29.5 Minimum thickness [mm] 25.5 Brake Disc Type: Vented | |
| | | for PR number: 2E4; Fitting Position: Front Axle | 24.0133-0100.1 433100 | Outer diameter [mm]: 340 Brake Disc Thickness [mm] 32.6 Minimum thickness [mm] 29.5 Brake Disc Type: Vented Supplementary Article/Info 2: with bolts/screws | |
| | | Fitting Position: Rear Axle | 24.0122-0211.1 422211 | Outer diameter [mm]: 294 Brake Disc Thickness [mm] 21.9 Minimum thickness [mm] 19.5 Brake Disc Type: Vented Supplementary Article/Info 2: with bolts/screws | |
| 2.0 TDI 2.0 TDI 4motion | 100 05/10→08/15 100 05/10→08/15 | for PR number: 2E3; Fitting Position: Front Axle | 24.0130-0114.1 430114 | Outer diameter [mm]: 308 Brake Disc Thickness [mm] 29.5 Minimum thickness [mm] 25.5 Brake Disc Type: Vented | |
| | | Vehicle Identification Number from: 7H- A-200001 →; for PR number: 2E4; Fitting Position: Front Axle | 24.0133-0100.1 433100 | Outer diameter [mm]: 340 Brake Disc Thickness [mm] 32.6 Minimum thickness [mm] 29.5 Brake Disc Type: Vented Supplementary Article/Info 2: with bolts/screws | |
| | | Vehicle Identification Number from: 7H- A-200001 →; Fitting Position: Rear Axle | 24.0122-0211.1 422211 | Outer diameter [mm]: 294 Brake Disc Thickness [mm] 21.9 Minimum thickness [mm] 19.5 Brake Disc Type: Vented Supplementary Article/Info 2: with bolts/screws | |
| 3.2 V6 4motion | 170 - 11/03→12/09 173 | Construction year from: 07/04 →; for PR number: 2E3; Fitting Position: Front Axle | 24.0130-0114.1 430114 | Outer diameter [mm]: 308 Brake Disc Thickness [mm] 29.5 Minimum thickness [mm] 25.5 Brake Disc Type: Vented | |
| | | Vehicle Identification Number from: 7H- A-200001 →; for PR number: 2E4; Fitting Position: Front Axle | 24.0133-0100.1 433100 | Outer diameter [mm]: 340 Brake Disc Thickness [mm] 32.6 Minimum thickness [mm] 29.5 Brake Disc Type: Vented Supplementary Article/Info 2: with bolts/screws | |
| | | Vehicle Identification Number from: 7H- A-200001 →; Fitting Position: Rear Axle | 24.0122-0211.1 422211 | Outer diameter [mm]: 294 Brake Disc Thickness [mm] 21.9 Minimum thickness [mm] 19.5 Brake Disc Type: Vented Supplementary Article/Info 2: with bolts/screws | |
| | | Construction year from: 07/04 →; for PR number: 0WL / 0WN / 0WM / 0WP / 0WQ; → Vehicle Identification Number to: 7H-5-120000; Fitting Position: Rear Axle | 24.0122-0211.1 422211 | Outer diameter [mm]: 294 Brake Disc Thickness [mm] 21.9 Minimum thickness [mm] 19.5 Brake Disc Type: Vented Supplementary Article/Info 2: with bolts/screws | |
| | | Vehicle Identification Number from: 7H-6-000001 →; for PR number: 2E3 / 2E4; → Vehicle Identification Number to: 7H- A-050000; Fitting Position: Rear Axle | 24.0122-0211.1 422211 | Outer diameter [mm]: 294 Brake Disc Thickness [mm] 21.9 Minimum thickness [mm] 19.5 Brake Disc Type: Vented Supplementary Article/Info 2: with bolts/screws | |
| | | Vehicle Identification Number from: 7H-8-028000 →; for PR number: 0WR; → Vehicle Identification Number to: 7H-8-200000; Fitting Position: Rear Axle | 24.0122-0211.1 422211 | Outer diameter [mm]: 294 Brake Disc Thickness [mm] 21.9 Minimum thickness [mm] 19.5 Brake Disc Type: Vented Supplementary Article/Info 2: with bolts/screws | |
|  Brake Hose | | | | | |
| 1.9 TDI 2.0 2.0 BiTDI → | 62 - 04/03→11/09 77 85 11/03→08/15 132 09/09→08/15 | for PR number: 1BA / 1BB / 1BJ / 1BV / 1MG / 1MK / 1ML / 2MD / 2MF / 2MG / 2ML; Required quantity: 2; Fitting Position: Front Axle | 2 24.5140-0514.3 331290 | Length [mm]: 520 | |

| | kW | | | | |
|---|-----|-------------|---|---|---|
| VW - TRANSPORTER V Bus (7HB, 7HJ, 7EB, 7EJ) 04/03→08/15 | | | | | |
|  Brake Hose | | | | | |
| 2.0 BiTDI 4motion | 132 | 09/09→08/15 | for PR number: 0WL / 0WN / 0WM / 0WP / 0WQ; Required quantity: 2; Fitting Position: Front Axle | 2 | 24.5140-0514.3 331290 Length [mm]: 520 |
| 2.0 CNG | 85 | 01/06→08/15 | for PR number: 1BH / 1BX / 1MR / 2MQ / 2MZ / 2MU / 2MT; Required quantity: 2; Fitting Position: Front Axle | 2 | 83.6113-0552.3 330864 Length [mm]: 552 |
| 2.0 TDI | 62 | 09/09→08/15 | | 2 | 83.6113-0552.3 330864 Length [mm]: 552 |
| 2.0 TDI 4motion | 100 | 09/09→08/15 | for PR number: 0WR; Required quantity: 2; Fitting Position: Front Axle | 2 | 83.6113-0552.3 330864 Length [mm]: 552 |
| 2.5 TDi | 120 | 11/03→11/09 | | 2 | 83.6113-0552.3 330864 Length [mm]: 552 |
| 2.5 TDI | 96 | 04/03→11/09 | Braking System: for vehicles with brake-power regulator; Required quantity: 2; Fitting Position: at brake caliper / Rear Axle | 2 | 24.5140-0194.3 331383 Length [mm]: 190 |
| 2.5 TDI 4motion | 128 | 07/04→11/09 | | 2 | 24.5140-0194.3 331383 Length [mm]: 190 |
| 3.2 V6 | 170 | 02/04→11/09 | for PR number: 0E1 / 0E2 / 0WL / 0WN / 0WM / 0WP / 0WQ; Required quantity: 2; Fitting Position: Rear Axle | 2 | 24.5140-0194.3 331383 Length [mm]: 190 |
| | | | Required quantity: 2; Fitting Position: Rear Axle | 2 | 24.5237-0250.3 330880 Length [mm]: 250 |
| | | | for PR number: 0WR; Required quantity: 2; Fitting Position: Rear Axle | 2 | 24.5237-0250.3 330880 Length [mm]: 250 |
| 2.0 TDI | 84 | 05/11→08/15 | for PR number: 1BA / 1BB / 1BJ / 1BV / 1MG / 1MK / 1ML / 2MD / 2MF / 2MG / 2ML; Required quantity: 2; Fitting Position: Front Axle | 2 | 24.5140-0514.3 331290 Length [mm]: 520 |
| 2.0 TSI | 110 | 05/11→08/15 | | 2 | 83.6113-0552.3 330864 Length [mm]: 552 |
| 2.0 TSI 4motion | 150 | 07/11→08/15 | for PR number: 1BH / 1BX / 1MR / 2MQ / 2MZ / 2MU / 2MT; Required quantity: 2; Fitting Position: Front Axle | 2 | 83.6113-0552.3 330864 Length [mm]: 552 |
| | 150 | 07/11→08/15 | | 2 | 24.5140-0194.3 331383 Length [mm]: 190 |
| 3.2 V6 4motion | 170 | 11/03→12/09 | Construction year from: 07/04 →; for PR number: 1BA / 1BB / 1BJ / 1BV / 1MG / 1MK / 1ML / 2MD / 2MF / 2MG / 2ML; Required quantity: 2; Fitting Position: Front Axle | 2 | 24.5140-0514.3 331290 Length [mm]: 520 |
| | | | Construction year from: 07/04 →; for PR number: 0WL / 0WN / 0WM / 0WP / 0WQ; Required quantity: 2; Fitting Position: Front Axle | 2 | 24.5140-0514.3 331290 Length [mm]: 520 |
| | | | Construction year from: 07/04 →; for PR number: 1BH / 1BX / 1MR / 2MQ / 2MZ / 2MU / 2MT; Required quantity: 2; Fitting Position: Front Axle | 2 | 83.6113-0552.3 330864 Length [mm]: 552 |
| | | | Construction year from: 07/04 →; for PR number: 0WR; Required quantity: 2; Fitting Position: Front Axle | 2 | 83.6113-0552.3 330864 Length [mm]: 552 |
| | | | Construction year from: 07/04 →; for PR number: 0E1 / 0E2 / 0WL / 0WN / 0WM / 0WP / 0WQ; Required quantity: 2; Fitting Position: Rear Axle | 2 | 24.5140-0194.3 331383 Length [mm]: 190 |
| | | | Construction year from: 07/04 →; Braking System: for vehicles with brake-power regulator; Required quantity: 2; Fitting Position: at brake caliper / Rear Axle | 2 | 24.5140-0194.3 331383 Length [mm]: 190 |
| | | | Construction year from: 07/04 →; Required quantity: 2; Fitting Position: Rear Axle | 2 | 24.5237-0250.3 330880 Length [mm]: 250 |
| | | | Construction year from: 07/04 →; for PR number: 0WR; Required quantity: 2; Fitting Position: Rear Axle | 2 | 24.5237-0250.3 330880 Length [mm]: 250 |
| | | | | | |
|  Wheel Speed Sensor | | | | | |
| 1.9 TDI | 62 | 04/03→11/09 | Fitting Position: Front Axle Left | | 24.0711-5271.3 360301 |
| | 77 | | Fitting Position: Front Axle Right | | 24.0711-5272.3 360302 |
| 2.0 | 85 | 11/03→08/15 | Fitting Position: Rear Axle Left | | 24.0711-5271.3 360301 |
| 2.0 BiTDI | 132 | 09/09→08/15 | Fitting Position: Rear Axle Right | | 24.0711-5272.3 360302 |
| 2.0 BiTDI 4motion | 132 | 09/09→08/15 | | | |
| 2.0 CNG | 85 | 01/06→08/15 | | | |
| 2.0 TDI | 62 | 09/09→08/15 | | | |
| | 103 | | | | |
| 2.0 TDI 4motion | 100 | 09/09→08/15 | | | |
| | 103 | | | | |
| 2.0 TSI | 110 | 05/11→08/15 | | | |
| | 150 | | | | |
| 2.0 TSI 4motion | 150 | 07/11→08/15 | | | |
| 2.5 TDi | 120 | 11/03→11/09 | | | |
| → | | | | | |



| | kW | | | | |
|--|--------------------------|--|--|-------------------------|--|
| VW - TRANSPORTER V Bus (7HB, 7HJ, 7EB, 7EJ) 04/03→08/15 | | | | | |
|  Wheel Speed Sensor | | | | | |
| 2.5 TDI | 96 - 04/03→11/09 128 | | Fitting Position: Front Axle Left | 24.0711-5271.3 | 360301 |
| 2.5 TDI 4motion | 96 - 07/04→11/09 128 | | Fitting Position: Front Axle Right | 24.0711-5272.3 | 360302 |
| 3.2 V6 | 170 - 02/04→11/09 173 | | Fitting Position: Rear Axle Left | 24.0711-5271.3 | 360301 |
| | | | Fitting Position: Rear Axle Right | 24.0711-5272.3 | 360302 |
| 3.2 V6 4motion | 170 - 11/03→12/09 173 | | Construction year from: 07/04 →; Fitting Position: Front Axle Left | 24.0711-5271.3 | 360301 |
| | | | Construction year from: 07/04 →; Fitting Position: Front Axle Right | 24.0711-5272.3 | 360302 |
| | | | Construction year from: 07/04 →; Fitting Position: Rear Axle Left | 24.0711-5271.3 | 360301 |
| | | | Construction year from: 07/04 →; Fitting Position: Rear Axle Right | 24.0711-5272.3 | 360302 |
|  Cable Pull, parking brake | | | | | |
| 1.9 TDI | 62 - 04/03→11/09 77 | | for PR number: 0E1 / 0E2 / 0WL / 0WN / 0WM / 0WP / 0WQ; Required quantity: 2; Brake Type: Disc Brake; Fitting Position: Rear | 2 24.3727-0184.2 | 580184 Length [mm]: 1,303 |
| 2.0 | 85 11/03→08/15 | | | | |
| 2.0 BiTDI | 132 09/09→08/15 | | | | |
| 2.0 CNG | 85 01/06→08/15 | | | | |
| 2.0 TDI | 62 - 09/09→08/15 103 | | Vehicle Identification Number from: 7H-7-000001 →; for PR number: 0WR / 0E1; Required quantity: 2; Fitting Position: Rear | 2 24.3727-3409.2 | 583409 Length [mm]: 1,570 |
| 2.5 TDi | 120 11/03→11/09 | | | | |
| 2.5 TDI | 96 - 04/03→11/09 128 | | | | |
| 3.2 V6 | 170 - 02/04→11/09 173 | | | | |
| 2.0 BiTDI 4motion | 132 09/09→08/15 | | Vehicle Identification Number from: 7H-A-200001 →; Brake Type: Disc Brake; for PR number: G0C / G0K / G1C; Required quantity: 2; Fitting Position: Rear | 2 24.3727-0184.2 | 580184 Length [mm]: 1,303 |
| 2.0 TDI 4motion | 100 - 09/09→08/15 103 | | | | |
| 2.5 TDI 4motion | 96 - 07/04→11/09 128 | | | | |
| 3.2 V6 4motion | 170 - 11/03→12/09 173 | | Vehicle Identification Number from: 7H-7-000001 →; for PR number: 0WR / 0E1; Required quantity: 2; Fitting Position: Rear | 2 24.3727-3409.2 | 583409 Length [mm]: 1,570 |
| 2.0 TDI | 84 - 05/11→08/15 85 | | Brake Type: Disc Brake; for PR number: G0C / G0K / G1C; Required quantity: 2; Fitting Position: Rear | 2 24.3727-0184.2 | 580184 Length [mm]: 1,303 |
| 2.0 TSI | 110 - 05/11→08/15 150 | | | | |
| 2.0 TSI 4motion | 150 07/11→08/15 | | | | |
| VW - TRANSPORTER V Platform/Chassis (7JD, 7JE, 7JL, 7JY, 7JZ, 7FD 04/03→08/15 | | | | | |
|  Brake Caliper | | | | | |
| 1.9 TDI | 62 - 04/03→11/09 77 | | Vehicle Identification Number from: 7J-A-200001 →; for PR number: 2E4; Fitting Position: Front Axle Left | 24.3441-9933.5 | 241141 Brake System: ATE Supplementary Article/Supplementary Info: without holder Brake Caliper Type: Fist-type Caliper (2 pistons) |
| 2.0 | 85 11/03→05/13 | | | | |
| 2.0 CNG | 85 11/03→05/11 | | | | |
| 2.5 TDI | 96 - 04/03→11/09 128 | | | | |
| 2.5 TDI 4motion | 96 07/04→11/09 | | Vehicle Identification Number from: 7J-A-200001 →; for PR number: 2E4; Fitting Position: Front Axle Right | 24.3441-9934.5 | 241142 Brake System: ATE Supplementary Article/Supplementary Info: without holder Brake Caliper Type: Fist-type Caliper (2 pistons) |
| 3.2 V6 | 170 - 08/03→11/09 173 | | | | |
| | | | for PR number: 2E3; Fitting Position: Front Axle Left | 24.3601-9947.5 | 240597 Brake System: ATE Supplementary Article/Supplementary Info: without holder Brake Caliper Type: Fist-type Caliper |
| | | | for PR number: 2E3; Fitting Position: Front Axle Right | 24.3601-9948.5 | 240598 Brake System: ATE Supplementary Article/Supplementary Info: without holder Brake Caliper Type: Fist-type Caliper |
| | | | → Vehicle Identification Number to: 7J-A-010000; for PR number: 2E3 / 2E4; Fitting Position: Rear Axle Left | 24.3414-1711.5 | 240852 Brake System: Lucas / TRW Supplementary Article/Supplementary Info: without holder Brake Caliper Type: Fist-type Caliper |
| | | | Vehicle Identification Number from: 7J-A-200001 →; Fitting Position: Rear Axle Left | 24.3414-1711.5 | 240852 Brake System: Lucas / TRW Supplementary Article/Supplementary Info: without holder Brake Caliper Type: Fist-type Caliper |

| | | kW | | | | | |
|--|-------------------|-----|--|--|---------------------------------|------------------------------------|---|
| VW - TRANSPORTER V Platform/Chassis (7JD, 7JE, 7JL, 7JY, 7JZ, 7FD 04/03→08/15) | | | | | | | |
|  Brake Caliper | | | | | | | |
| 1.9 TDI | 62 - 04/03→11/09 | 77 | | Vehicle Identification Number from: 7J-8-000789 → → Vehicle Identification Number to: 7J-8-030000; | for PR number: 0WR / 0E0 / 0E9; | Fitting Position: Rear Axle Left | 24.3414-1711.5 240852 Brake System: Lucas / TRW Supplementary Article/Supplementary Info: without holder Brake Caliper Type: Fist-type Caliper |
| 2.0 | 85 11/03→05/13 | | | → Vehicle Identification Number to: 7J-A-010000; for PR number: 2E3 / 2E4; | | Fitting Position: Rear Axle Right | 24.3414-1712.5 240853 Brake System: Lucas / TRW Supplementary Article/Supplementary Info: without holder Brake Caliper Type: Fist-type Caliper |
| 2.0 CNG | 85 11/03→05/11 | | | Vehicle Identification Number from: 7J-A-200001 →; | | Fitting Position: Rear Axle Right | 24.3414-1712.5 240853 Brake System: Lucas / TRW Supplementary Article/Supplementary Info: without holder Brake Caliper Type: Fist-type Caliper |
| 2.5 TDI | 96 - 04/03→11/09 | 128 | | Vehicle Identification Number from: 7J-8-000789 → → Vehicle Identification Number to: 7J-8-030000; | for PR number: 0WR / 0E0 / 0E9; | Fitting Position: Rear Axle Right | 24.3414-1712.5 240853 Brake System: Lucas / TRW Supplementary Article/Supplementary Info: without holder Brake Caliper Type: Fist-type Caliper |
| 2.5 TDI 4motion | 96 07/04→11/09 | | | | | | |
| 3.2 V6 | 170 - 08/03→11/09 | 173 | | | | | |
| 2.0 BiTDI | 132 09/09→08/15 | | | Vehicle Identification Number from: 7J-A-200001 →; | for PR number: 2E4; | Fitting Position: Front Axle Left | 24.3441-9933.5 241141 Brake System: ATE Supplementary Article/Supplementary Info: without holder Brake Caliper Type: Fist-type Caliper (2 pistons) |
| 2.0 BiTDI 4motion | 132 09/09→08/15 | | | Vehicle Identification Number from: 7J-A-200001 →; | for PR number: 2E4; | Fitting Position: Front Axle Right | 24.3441-9934.5 241142 Brake System: ATE Supplementary Article/Supplementary Info: without holder Brake Caliper Type: Fist-type Caliper (2 pistons) |
| 2.0 TDI | 62 - 09/09→08/15 | 103 | | for PR number: 2E3; | | Fitting Position: Front Axle Left | 24.3601-9947.5 240597 Brake System: ATE Supplementary Article/Supplementary Info: without holder Brake Caliper Type: Fist-type Caliper |
| 2.0 TDI 4motion | 103 09/09→08/15 | | | for PR number: 2E3; | | Fitting Position: Front Axle Right | 24.3601-9948.5 240598 Brake System: ATE Supplementary Article/Supplementary Info: without holder Brake Caliper Type: Fist-type Caliper |
| | | | | → Vehicle Identification Number to: 7J-A-010000; for PR number: 2E3 / 2E4; | | Fitting Position: Rear Axle Left | 24.3414-1711.5 240852 Brake System: Lucas / TRW Supplementary Article/Supplementary Info: without holder Brake Caliper Type: Fist-type Caliper |
| | | | | Vehicle Identification Number from: 7J-A-200001 →; | | Fitting Position: Rear Axle Left | 24.3414-1711.5 240852 Brake System: Lucas / TRW Supplementary Article/Supplementary Info: without holder Brake Caliper Type: Fist-type Caliper |
| | | | | Vehicle Identification Number from: 7J-A-200001 →; | | Fitting Position: Rear Axle Right | 24.3414-1712.5 240853 Brake System: Lucas / TRW Supplementary Article/Supplementary Info: without holder Brake Caliper Type: Fist-type Caliper |
| | | | | → Vehicle Identification Number to: 7J-A-010000; for PR number: 2E3 / 2E4; | | Fitting Position: Rear Axle Right | 24.3414-1712.5 240853 Brake System: Lucas / TRW Supplementary Article/Supplementary Info: without holder Brake Caliper Type: Fist-type Caliper |
| 2.0 TDI | 84 - 05/10→08/15 | 100 | | for PR number: 2E4; | | Fitting Position: Front Axle Left | 24.3441-9933.5 241141 Brake System: ATE Supplementary Article/Supplementary Info: without holder Brake Caliper Type: Fist-type Caliper (2 pistons) |
| 2.0 TDI 4motion | 100 05/10→08/15 | | | for PR number: 2E4; | | Fitting Position: Front Axle Right | 24.3441-9934.5 241142 Brake System: ATE Supplementary Article/Supplementary Info: without holder Brake Caliper Type: Fist-type Caliper (2 pistons) |
| 2.0 TSI | 110 07/12→08/15 | | | for PR number: 2E3; | | Fitting Position: Front Axle Left | 24.3601-9947.5 240597 Brake System: ATE Supplementary Article/Supplementary Info: without holder Brake Caliper Type: Fist-type Caliper |
| → | | | | | | | |

| | kw | | | | |
|--|---|--|------------------------------|--|--|
| VW - TRANSPORTER V Platform/Chassis (7JD, 7JE, 7JL, 7JY, 7JZ, 7FD 04/03→08/15) | | | | | |
|  Brake Caliper | | | | | |
| 2.0 TDI 2.0 TDI 4motion 2.0 TSI | 84 - 05/10→08/15 100 100 05/10→08/15 110 07/12→08/15 | for PR number: 2E3; Fitting Position: Front Axle Right | 24.3601-9948.5 240598 | Brake System: ATE Supplementary Article/Supplementary Info: without holder Brake Caliper Type: Fist-type Caliper | |
| | | Fitting Position: Rear Axle Left | 24.3414-1711.5 240852 | Brake System: Lucas / TRW Supplementary Article/Supplementary Info: without holder Brake Caliper Type: Fist-type Caliper | |
| | | Fitting Position: Rear Axle Right | 24.3414-1712.5 240853 | Brake System: Lucas / TRW Supplementary Article/Supplementary Info: without holder Brake Caliper Type: Fist-type Caliper | |
| 2.5 TDI 4motion | 128 04/04→11/09 | Vehicle Identification Number from: 7J-A-200001 →; for PR number: 2E4; Fitting Position: Front Axle Left | 24.3441-9933.5 241141 | Brake System: ATE Supplementary Article/Supplementary Info: without holder Brake Caliper Type: Fist-type Caliper (2 pistons) | |
| | | Vehicle Identification Number from: 7J-A-200001 →; for PR number: 2E4; Fitting Position: Front Axle Right | 24.3441-9934.5 241142 | Brake System: ATE Supplementary Article/Supplementary Info: without holder Brake Caliper Type: Fist-type Caliper (2 pistons) | |
| | | Construction year from: 07/04 →; for PR number: 2E3; Fitting Position: Front Axle Left | 24.3601-9947.5 240597 | Brake System: ATE Supplementary Article/Supplementary Info: without holder Brake Caliper Type: Fist-type Caliper | |
| | | Construction year from: 07/04 →; for PR number: 2E3; Fitting Position: Front Axle Right | 24.3601-9948.5 240598 | Brake System: ATE Supplementary Article/Supplementary Info: without holder Brake Caliper Type: Fist-type Caliper | |
| | | Construction year from: 07/04 →; → Vehicle Identification Number to: 7J-A-010000; for PR number: 2E3 / 2E4; Fitting Position: Rear Axle Left | 24.3414-1711.5 240852 | Brake System: Lucas / TRW Supplementary Article/Supplementary Info: without holder Brake Caliper Type: Fist-type Caliper | |
| | | Vehicle Identification Number from: 7J-A-200001 →; Fitting Position: Rear Axle Left | 24.3414-1711.5 240852 | Brake System: Lucas / TRW Supplementary Article/Supplementary Info: without holder Brake Caliper Type: Fist-type Caliper | |
| | | Vehicle Identification Number from: 7J-8-000789 → → Vehicle Identification Number to: 7J-8-030000; for PR number: 0WR / 0E0 / 0E9; Fitting Position: Rear Axle Left | 24.3414-1711.5 240852 | Brake System: Lucas / TRW Supplementary Article/Supplementary Info: without holder Brake Caliper Type: Fist-type Caliper | |
| | | Construction year from: 07/04 →; → Vehicle Identification Number to: 7J-A-010000; for PR number: 2E3 / 2E4; Fitting Position: Rear Axle Right | 24.3414-1712.5 240853 | Brake System: Lucas / TRW Supplementary Article/Supplementary Info: without holder Brake Caliper Type: Fist-type Caliper | |
| | | Vehicle Identification Number from: 7J-A-200001 →; Fitting Position: Rear Axle Right | 24.3414-1712.5 240853 | Brake System: Lucas / TRW Supplementary Article/Supplementary Info: without holder Brake Caliper Type: Fist-type Caliper | |
| | | Vehicle Identification Number from: 7J-8-000789 → → Vehicle Identification Number to: 7J-8-030000; for PR number: 0WR / 0E0 / 0E9; Fitting Position: Rear Axle Right | 24.3414-1712.5 240853 | Brake System: Lucas / TRW Supplementary Article/Supplementary Info: without holder Brake Caliper Type: Fist-type Caliper | |
| 3.2 4motion | 170 11/03→11/09 | Vehicle Identification Number from: 7H-A-200001 →; for PR number: 2E4; Fitting Position: Front Axle Left | 24.3441-9933.5 241141 | Brake System: ATE Supplementary Article/Supplementary Info: without holder Brake Caliper Type: Fist-type Caliper (2 pistons) | |
| | | Vehicle Identification Number from: 7H-A-200001 →; for PR number: 2E4; Fitting Position: Front Axle Right | 24.3441-9934.5 241142 | Brake System: ATE Supplementary Article/Supplementary Info: without holder Brake Caliper Type: Fist-type Caliper (2 pistons) | |
| → | | | | | |



| | kW | | | | |
|--|-----|-------------|--|--------------------------------|--|
| VW - TRANSPORTER V Platform/Chassis (7JD, 7JE, 7JL, 7JY, 7JZ, 7FD 04/03→08/15) | | | | | |
|  Brake Caliper | | | | | |
| 3.2 4motion | 170 | 11/03→11/09 | Construction year from: 07/04 →; for PR number: 2E3; Fitting Position: Front Axle Left | 24.3601-9947.5 240597 | Brake System: ATE Supplementary Article/Supplementary Info: without holder Brake Caliper Type: Fist-type Caliper |
| | | | Construction year from: 07/04 →; for PR number: 2E3; Fitting Position: Front Axle Right | 24.3601-9948.5 240598 | Brake System: ATE Supplementary Article/Supplementary Info: without holder Brake Caliper Type: Fist-type Caliper |
| | | | Vehicle Identification Number from: 7H-A-200001 →; Fitting Position: Rear Axle Left | 24.3414-1711.5 240852 | Brake System: Lucas / TRW Supplementary Article/Supplementary Info: without holder Brake Caliper Type: Fist-type Caliper |
| | | | Construction year from: 07/04 →; for PR number: 0WL / 0WN / 0WM / 0WP / 0WQ; → Vehicle Identification Number to: 7H-5-120000; Fitting Position: Rear Axle Left | 24.3414-1711.5 240852 | Brake System: Lucas / TRW Supplementary Article/Supplementary Info: without holder Brake Caliper Type: Fist-type Caliper |
| | | | Vehicle Identification Number from: 7H-8-028000 →; for PR number: 0WR; → Vehicle Identification Number to: 7H-8-200000; Fitting Position: Rear Axle Left | 24.3414-1711.5 240852 | Brake System: Lucas / TRW Supplementary Article/Supplementary Info: without holder Brake Caliper Type: Fist-type Caliper |
| | | | Vehicle Identification Number from: 7H-6-000001 →; for PR number: 2E3 / 2E4; → Vehicle Identification Number to: 7H-A-050000; Fitting Position: Rear Axle Left | 24.3414-1711.5 240852 | Brake System: Lucas / TRW Supplementary Article/Supplementary Info: without holder Brake Caliper Type: Fist-type Caliper |
| | | | Construction year from: 07/04 →; for PR number: 0WL / 0WN / 0WM / 0WP / 0WQ; → Vehicle Identification Number to: 7H-5-120000; Fitting Position: Rear Axle Right | 24.3414-1712.5 240853 | Brake System: Lucas / TRW Supplementary Article/Supplementary Info: without holder Brake Caliper Type: Fist-type Caliper |
| | | | Vehicle Identification Number from: 7H-A-200001 →; Fitting Position: Rear Axle Right | 24.3414-1712.5 240853 | Brake System: Lucas / TRW Supplementary Article/Supplementary Info: without holder Brake Caliper Type: Fist-type Caliper |
| | | | Vehicle Identification Number from: 7H-8-028000 →; for PR number: 0WR; → Vehicle Identification Number to: 7H-8-200000; Fitting Position: Rear Axle Right | 24.3414-1712.5 240853 | Brake System: Lucas / TRW Supplementary Article/Supplementary Info: without holder Brake Caliper Type: Fist-type Caliper |
| | | | Vehicle Identification Number from: 7H-6-000001 →; for PR number: 2E3 / 2E4; → Vehicle Identification Number to: 7H-A-050000; Fitting Position: Rear Axle Right | 24.3414-1712.5 240853 | Brake System: Lucas / TRW Supplementary Article/Supplementary Info: without holder Brake Caliper Type: Fist-type Caliper |
| Spring, brake caliper | | | | | |
| 1.9 TDI | 62 | 04/03→11/09 | Vehicle Identification Number from: 7J-A-200001 →; for PR number: 2E4; Required quantity: 2 | 2 11.8116-0126.2 390608 | Brake System: ATE |
| 2.0 | 85 | 11/03→05/13 | | | |
| 2.0 BiTDI | 132 | 09/09→08/15 | | | |
| 2.0 BiTDI 4motion | 132 | 09/09→08/15 | → Vehicle Identification Number to: 7J-A-010000; for PR number: 2E4; Required quantity: 2 | 2 11.8116-0237.1 390509 | Brake System: ATE |
| 2.0 CNG | 85 | 11/03→05/11 | | | |
| 2.0 TDI | 62 | 09/09→08/15 | for PR number: 2E3; Required quantity: 2 | 2 11.8116-0237.1 390509 | Brake System: ATE |
| | 103 | | | | |
| 2.0 TDI 4motion | 103 | 09/09→08/15 | | | |
| 2.5 TDI | 96 | 04/03→11/09 | | | |
| | 128 | | | | |
| 2.5 TDI 4motion | 96 | 07/04→11/09 | | | |
| 3.2 V6 | 170 | 08/03→11/09 | | | |
| | 173 | | | | |
| 2.0 TDI | 84 | 05/10→08/15 | for PR number: 2E4; Required quantity: 2 | 2 11.8116-0126.2 390608 | Brake System: ATE |
| | 100 | | for PR number: 2E3; Required quantity: 2 | 2 11.8116-0237.1 390509 | Brake System: ATE |
| 2.0 TDI 4motion | 100 | 05/10→08/15 | | | |
| 2.0 TSI | 110 | 07/12→08/15 | | | |
| 2.5 TDI 4motion | 128 | 04/04→11/09 | Vehicle Identification Number from: 7J-A-200001 →; for PR number: 2E4; Required quantity: 2 | 2 11.8116-0126.2 390608 | Brake System: ATE |
| | | | Construction year from: 07/04 →; for PR number: 2E3; Required quantity: 2 | 2 11.8116-0237.1 390509 | Brake System: ATE |
| → | | | | | |



| | kW | | | | |
|--|-----|-------------|--|---|---|
| VW - TRANSPORTER V Platform/Chassis (7JD, 7JE, 7JL, 7JY, 7JZ, 7FD 04/03→08/15) | | | | | |
| Spring, brake caliper | | | | | |
| 2.5 TDI 4motion | 128 | 04/04→11/09 | Construction year from: 07/04 →; → Vehicle Identification Number to: 7J-A-010000; for PR number: 2E4; Required quantity: 2 | 2 | 11.8116-0237.1 390509 Brake System: ATE |
| 3.2 4motion | 170 | 11/03→11/09 | Vehicle Identification Number from: 7H-A-200001 →; for PR number: 2E4; Required quantity: 2 | 2 | 11.8116-0126.2 390608 Brake System: ATE |
| | | | Construction year from: 07/04 →; for PR number: 2E3; Required quantity: 2 | 2 | 11.8116-0237.1 390509 Brake System: ATE |
| | | | Construction year from: 07/04 →; → Vehicle Identification Number to: 7H-A-050000; for PR number: 2E4; Required quantity: 2 | 2 | 11.8116-0237.1 390509 Brake System: ATE |
|  Brake Pad Set, disc brake | | | | | |
| 1.9 TDI | 62 | 04/03→11/09 | for PR number: 2E3; Fitting Position: Front Axle | | 13.0460-7236.2 607236 Brake System: ATE 23746 19,7 Wear Warning Contact: incl. wear warning contact |
| 2.0 | 85 | 11/03→05/13 | | | |
| 2.0 CNG | 85 | 11/03→05/11 | | | |
| 2.5 TDI | 96 | 04/03→11/09 | Vehicle Identification Number from: 7J-A-200001 →; for PR number: 2E4; Fitting Position: Front Axle | | 13.0460-7286.2 607286 Brake System: ATE 24623 18,2 Wear Warning Contact: incl. wear warning contact |
| 2.5 TDI 4motion | 128 | | | | |
| 3.2 V6 | 170 | 08/03→11/09 | → Vehicle Identification Number to: 7J-A-010000; for PR number: 2E3 / 2E4; Fitting Position: Rear Axle | | 13.0460-2882.2 602882 Brake System: Lucas / TRW 23326 17,4 Wear Warning Contact: incl. wear warning contact Supplementary Article/Supplementary Info: with accessories |
| | 173 | | Vehicle Identification Number from: 7J-A-200001 →; Fitting Position: Rear Axle | | 13.0460-2882.2 602882 Brake System: Lucas / TRW 23326 17,4 Wear Warning Contact: incl. wear warning contact Supplementary Article/Supplementary Info: with accessories |
| | | | Vehicle Identification Number from: 7J-8-000789 → → Vehicle Identification Number to: 7J-8-030000; for PR number: 0WR / 0E0 / 0E9; Fitting Position: Rear Axle | | 13.0460-2882.2 602882 Brake System: Lucas / TRW 23326 17,4 Wear Warning Contact: incl. wear warning contact Supplementary Article/Supplementary Info: with accessories |
| 2.0 BiTDI | 132 | 09/09→08/15 | for PR number: 2E3; Fitting Position: Front Axle | | 13.0460-7236.2 607236 Brake System: ATE 23746 19,7 Wear Warning Contact: incl. wear warning contact |
| 2.0 BiTDI 4motion | 132 | 09/09→08/15 | | | |
| 2.0 TDI | 62 | 09/09→08/15 | | | |
| 2.0 TDI 4motion | 103 | 09/09→08/15 | Vehicle Identification Number from: 7J-A-200001 →; for PR number: 2E4; Fitting Position: Front Axle | | 13.0460-7286.2 607286 Brake System: ATE 24623 18,2 Wear Warning Contact: incl. wear warning contact |
| | | | Vehicle Identification Number from: 7J-A-200001 →; Fitting Position: Rear Axle | | 13.0460-2882.2 602882 Brake System: Lucas / TRW 23326 17,4 Wear Warning Contact: incl. wear warning contact Supplementary Article/Supplementary Info: with accessories |
| | | | → Vehicle Identification Number to: 7J-A-010000; for PR number: 2E3 / 2E4; Fitting Position: Rear Axle | | 13.0460-2882.2 602882 Brake System: Lucas / TRW 23326 17,4 Wear Warning Contact: incl. wear warning contact Supplementary Article/Supplementary Info: with accessories |
| 2.0 TDI | 84 | 05/10→08/15 | for PR number: 2E3; Fitting Position: Front Axle | | 13.0460-7236.2 607236 Brake System: ATE 23746 19,7 Wear Warning Contact: incl. wear warning contact |
| 2.0 TDI 4motion | 100 | 05/10→08/15 | | | |
| 2.0 TSI | 110 | 07/12→08/15 | for PR number: 2E4; Fitting Position: Front Axle | | 13.0460-7286.2 607286 Brake System: ATE 24623 18,2 Wear Warning Contact: incl. wear warning contact |
| | | | Fitting Position: Rear Axle | | 13.0460-2882.2 602882 Brake System: Lucas / TRW 23326 17,4 Wear Warning Contact: incl. wear warning contact Supplementary Article/Supplementary Info: with accessories |
| 2.5 TDI 4motion | 128 | 04/04→11/09 | Construction year from: 07/04 →; for PR number: 2E3; Fitting Position: Front Axle | | 13.0460-7236.2 607236 Brake System: ATE 23746 19,7 Wear Warning Contact: incl. wear warning contact |
| | | | Vehicle Identification Number from: 7J-A-200001 →; for PR number: 2E4; Fitting Position: Front Axle | | 13.0460-7286.2 607286 Brake System: ATE 24623 18,2 Wear Warning Contact: incl. wear warning contact |
| → | | | | | |

| | kW | | | | |
|--|-------------------|--|------------------------------|---|--|
| VW - TRANSPORTER V Platform/Chassis (7JD, 7JE, 7JL, 7JY, 7JZ, 7FD 04/03→08/15) | | | | | |
|  Brake Pad Set, disc brake | | | | | |
| 2.5 TDI 4motion | 128 04/04→11/09 | Construction year from: 07/04 →; → Vehicle Identification Number to: 7J-A-010000; for PR number: 2E3 / 2E4; Fitting Position: Rear Axle | 13.0460-2882.2 602882 | Brake System: Lucas / TRW 23326 17,4 Wear Warning Contact: incl. wear warning contact Supplementary Article/Supplementary Info: with accessories | |
| | | Vehicle Identification Number from: 7J-A-200001 →; Fitting Position: Rear Axle | 13.0460-2882.2 602882 | Brake System: Lucas / TRW 23326 17,4 Wear Warning Contact: incl. wear warning contact Supplementary Article/Supplementary Info: with accessories | |
| | | Vehicle Identification Number from: 7J-8-000789 → → Vehicle Identification Number to: 7J-8-030000; for PR number: 0WR / 0E0 / 0E9; Fitting Position: Rear Axle | 13.0460-2882.2 602882 | Brake System: Lucas / TRW 23326 17,4 Wear Warning Contact: incl. wear warning contact Supplementary Article/Supplementary Info: with accessories | |
| 3.2 4motion | 170 11/03→11/09 | Construction year from: 07/04 →; for PR number: 2E3; Fitting Position: Front Axle | 13.0460-7236.2 607236 | Brake System: ATE 23746 19,7 Wear Warning Contact: incl. wear warning contact | |
| | | Vehicle Identification Number from: 7H-A-200001 →; for PR number: 2E4; Fitting Position: Front Axle | 13.0460-7286.2 607286 | Brake System: ATE 24623 18,2 Wear Warning Contact: incl. wear warning contact | |
| | | Vehicle Identification Number from: 7H-A-200001 →; Fitting Position: Rear Axle | 13.0460-2882.2 602882 | Brake System: Lucas / TRW 23326 17,4 Wear Warning Contact: incl. wear warning contact Supplementary Article/Supplementary Info: with accessories | |
| | | Construction year from: 07/04 →; for PR number: 0WL / 0WN / 0WM / 0WP / 0WQ; → Vehicle Identification Number to: 7H-5-120000; Fitting Position: Rear Axle | 13.0460-2882.2 602882 | Brake System: Lucas / TRW 23326 17,4 Wear Warning Contact: incl. wear warning contact Supplementary Article/Supplementary Info: with accessories | |
| | | Vehicle Identification Number from: 7H-8-028000 →; for PR number: 0WR; → Vehicle Identification Number to: 7H-8-200000; Fitting Position: Rear Axle | 13.0460-2882.2 602882 | Brake System: Lucas / TRW 23326 17,4 Wear Warning Contact: incl. wear warning contact Supplementary Article/Supplementary Info: with accessories | |
| | | Vehicle Identification Number from: 7H-6-000001 →; for PR number: 2E3 / 2E4; → Vehicle Identification Number to: 7H-A-050000; Fitting Position: Rear Axle | 13.0460-2882.2 602882 | Brake System: Lucas / TRW 23326 17,4 Wear Warning Contact: incl. wear warning contact Supplementary Article/Supplementary Info: with accessories | |
|  Brake Disc | | | | | |
| 1.9 TDI | 62 - 04/03→11/09 | for PR number: 2E3; Fitting Position: Front Axle | 24.0130-0114.1 430114 | Outer diameter [mm]: 308 Brake Disc Thickness [mm] 29.5 Minimum thickness [mm] 25.5 Brake Disc Type: Vented | |
| 2.0 | 85 11/03→05/13 | | | | |
| 2.0 CNG | 85 11/03→05/11 | | | | |
| 2.5 TDI | 96 - 04/03→11/09 | | | | |
| 2.5 TDI 4motion | 128 | Vehicle Identification Number from: 7J-A-200001 →; for PR number: 2E4; Fitting Position: Front Axle | 24.0133-0100.1 433100 | Outer diameter [mm]: 340 Brake Disc Thickness [mm] 32.6 Minimum thickness [mm] 29.5 Brake Disc Type: Vented Supplementary Article/Info 2: with bolts/screws | |
| | 96 07/04→11/09 | | | | |
| 3.2 V6 | 170 - 08/03→11/09 | | | | |
| | 173 | | | | |
| | | → Vehicle Identification Number to: 7J-A-010000; for PR number: 2E3 / 2E4; Fitting Position: Rear Axle | 24.0122-0211.1 422211 | Outer diameter [mm]: 294 Brake Disc Thickness [mm] 21.9 Minimum thickness [mm] 19.5 Brake Disc Type: Vented Supplementary Article/Info 2: with bolts/screws | |
| | | Vehicle Identification Number from: 7J-A-200001 →; Fitting Position: Rear Axle | 24.0122-0211.1 422211 | Outer diameter [mm]: 294 Brake Disc Thickness [mm] 21.9 Minimum thickness [mm] 19.5 Brake Disc Type: Vented Supplementary Article/Info 2: with bolts/screws | |
| | | Vehicle Identification Number from: 7J-8-000789 → → Vehicle Identification Number to: 7J-8-030000; for PR number: 0WR / 0E0 / 0E9; Fitting Position: Rear Axle | 24.0122-0211.1 422211 | Outer diameter [mm]: 294 Brake Disc Thickness [mm] 21.9 Minimum thickness [mm] 19.5 Brake Disc Type: Vented Supplementary Article/Info 2: with bolts/screws | |

| | kW | | | | |
|---|--|--|------------------------------|---|--|
| VW - TRANSPORTER V Platform/Chassis (7JD, 7JE, 7JL, 7JY, 7JZ, 7FD 04/03→08/15) | | | | | |
| Brake Disc | | | | | |
| 2.0 BiTDI 2.0 BiTDI 4motion 2.0 TDI 2.0 TDI 4motion | 132 09/09→08/15 132 09/09→08/15 62 - 09/09→08/15 103 103 09/09→08/15 | for PR number: 2E3; Fitting Position: Front Axle | 24.0130-0114.1 430114 | Outer diameter [mm]: 308 Brake Disc Thickness [mm] 29.5 Minimum thickness [mm] 25.5 Brake Disc Type: Vented | |
| | | Vehicle Identification Number from: 7J-A-200001 →; for PR number: 2E4; Fitting Position: Front Axle | 24.0133-0100.1 433100 | Outer diameter [mm]: 340 Brake Disc Thickness [mm] 32.6 Minimum thickness [mm] 29.5 Brake Disc Type: Vented Supplementary Article/Info 2: with bolts/screws | |
| | | Vehicle Identification Number from: 7J-A-200001 →; Fitting Position: Rear Axle | 24.0122-0211.1 422211 | Outer diameter [mm]: 294 Brake Disc Thickness [mm] 21.9 Minimum thickness [mm] 19.5 Brake Disc Type: Vented Supplementary Article/Info 2: with bolts/screws | |
| | | → Vehicle Identification Number to: 7J-A-010000; for PR number: 2E3 / 2E4; Fitting Position: Rear Axle | 24.0122-0211.1 422211 | Outer diameter [mm]: 294 Brake Disc Thickness [mm] 21.9 Minimum thickness [mm] 19.5 Brake Disc Type: Vented Supplementary Article/Info 2: with bolts/screws | |
| 2.0 TDI 2.0 TDI 4motion 2.0 TSI | 84 - 05/10→08/15 100 100 05/10→08/15 110 07/12→08/15 | for PR number: 2E3; Fitting Position: Front Axle | 24.0130-0114.1 430114 | Outer diameter [mm]: 308 Brake Disc Thickness [mm] 29.5 Minimum thickness [mm] 25.5 Brake Disc Type: Vented | |
| | | for PR number: 2E4; Fitting Position: Front Axle | 24.0133-0100.1 433100 | Outer diameter [mm]: 340 Brake Disc Thickness [mm] 32.6 Minimum thickness [mm] 29.5 Brake Disc Type: Vented Supplementary Article/Info 2: with bolts/screws | |
| | | Fitting Position: Rear Axle | 24.0122-0211.1 422211 | Outer diameter [mm]: 294 Brake Disc Thickness [mm] 21.9 Minimum thickness [mm] 19.5 Brake Disc Type: Vented Supplementary Article/Info 2: with bolts/screws | |
| 2.5 TDI 4motion | 128 04/04→11/09 | Construction year from: 07/04 →; for PR number: 2E3; Fitting Position: Front Axle | 24.0130-0114.1 430114 | Outer diameter [mm]: 308 Brake Disc Thickness [mm] 29.5 Minimum thickness [mm] 25.5 Brake Disc Type: Vented | |
| | | Vehicle Identification Number from: 7J-A-200001 →; for PR number: 2E4; Fitting Position: Front Axle | 24.0133-0100.1 433100 | Outer diameter [mm]: 340 Brake Disc Thickness [mm] 32.6 Minimum thickness [mm] 29.5 Brake Disc Type: Vented Supplementary Article/Info 2: with bolts/screws | |
| | | Construction year from: 07/04 →; → Vehicle Identification Number to: 7J-A-010000; for PR number: 2E3 / 2E4; Fitting Position: Rear Axle | 24.0122-0211.1 422211 | Outer diameter [mm]: 294 Brake Disc Thickness [mm] 21.9 Minimum thickness [mm] 19.5 Brake Disc Type: Vented Supplementary Article/Info 2: with bolts/screws | |
| | | Vehicle Identification Number from: 7J-A-200001 →; Fitting Position: Rear Axle | 24.0122-0211.1 422211 | Outer diameter [mm]: 294 Brake Disc Thickness [mm] 21.9 Minimum thickness [mm] 19.5 Brake Disc Type: Vented Supplementary Article/Info 2: with bolts/screws | |
| | | Vehicle Identification Number from: 7J-8-000789 → → Vehicle Identification Number to: 7J-8-030000; for PR number: 0WR / 0E0 / 0E9; Fitting Position: Rear Axle | 24.0122-0211.1 422211 | Outer diameter [mm]: 294 Brake Disc Thickness [mm] 21.9 Minimum thickness [mm] 19.5 Brake Disc Type: Vented Supplementary Article/Info 2: with bolts/screws | |
| 3.2 4motion | 170 11/03→11/09 | Construction year from: 07/04 →; for PR number: 2E3; Fitting Position: Front Axle | 24.0130-0114.1 430114 | Outer diameter [mm]: 308 Brake Disc Thickness [mm] 29.5 Minimum thickness [mm] 25.5 Brake Disc Type: Vented | |
| | | Vehicle Identification Number from: 7H-A-200001 →; for PR number: 2E4; Fitting Position: Front Axle | 24.0133-0100.1 433100 | Outer diameter [mm]: 340 Brake Disc Thickness [mm] 32.6 Minimum thickness [mm] 29.5 Brake Disc Type: Vented Supplementary Article/Info 2: with bolts/screws | |

→

| | | kW | | | | | | | |
|---|-----|-------------|---|----------------|----------------|---|------------------|--------|------------------|
| VW - TRANSPORTER V Platform/Chassis (7JD, 7JE, 7JL, 7JY, 7JZ, 7FD 04/03→08/15) | | | | | | | | | |
|  Brake Disc | | | | | | | | | |
| 3.2 4motion | 170 | 11/03→11/09 | Vehicle Identification Number from: 7H-A-200001 →; Fitting Position: Rear Axle | 24.0122-0211.1 | 422211 | Outer diameter [mm]: 294 Brake Disc Thickness [mm] 21.9 Minimum thickness [mm] 19.5 Brake Disc Type: Vented Supplementary Article/Info 2: with bolts/screws | | | |
| | | | Construction year from: 07/04 →; for PR number: 0WL / 0WN / 0WM / 0WP / 0WQ; → Vehicle Identification Number to: 7H-5-120000; Fitting Position: Rear Axle | 24.0122-0211.1 | 422211 | Outer diameter [mm]: 294 Brake Disc Thickness [mm] 21.9 Minimum thickness [mm] 19.5 Brake Disc Type: Vented Supplementary Article/Info 2: with bolts/screws | | | |
| | | | Vehicle Identification Number from: 7H-6-000001 →; for PR number: 2E3 / 2E4; → Vehicle Identification Number to: 7H-A-050000; Fitting Position: Rear Axle | 24.0122-0211.1 | 422211 | Outer diameter [mm]: 294 Brake Disc Thickness [mm] 21.9 Minimum thickness [mm] 19.5 Brake Disc Type: Vented Supplementary Article/Info 2: with bolts/screws | | | |
| | | | Vehicle Identification Number from: 7H-8-028000 →; for PR number: 0WR; → Vehicle Identification Number to: 7H-8-200000; Fitting Position: Rear Axle | 24.0122-0211.1 | 422211 | Outer diameter [mm]: 294 Brake Disc Thickness [mm] 21.9 Minimum thickness [mm] 19.5 Brake Disc Type: Vented Supplementary Article/Info 2: with bolts/screws | | | |
|  Brake Hose | | | | | | | | | |
| 1.9 TDI | 62 | 04/03→11/09 | for PR number: 1BA / 1BB / 1BJ / 1BV / 1MG / 1MK / 1ML / 2MD / 2MF / 2MG / 2ML; Required quantity: 2; Fitting Position: Front Axle | 2 | 24.5140-0514.3 | 331290 | Length [mm]: 520 | | |
| 2.0 | 85 | 11/03→05/13 | | | | | | | |
| 2.0 BiTDI | 132 | 09/09→08/15 | | | | | | | |
| 2.0 BiTDI 4motion | 132 | 09/09→08/15 | | | | | | | |
| 2.0 CNG | 85 | 11/03→05/11 | for PR number: 0WL / 0WN / 0WM / 0WP / 0WQ; Required quantity: 2; Fitting Position: Front Axle | 2 | 24.5140-0514.3 | 331290 | Length [mm]: 520 | | |
| 2.0 TDI | 62 | 09/09→08/15 | | | | | | | |
| 2.0 TDI 4motion | 103 | | | | | | | | |
| | 100 | 09/09→08/15 | for PR number: 0WR; Required quantity: 2; Fitting Position: Front Axle | 2 | 83.6113-0552.3 | 330864 | Length [mm]: 552 | | |
| | 103 | | | | | | | | |
| 2.5 TDI | 96 | 04/03→11/09 | | | | | | | |
| | 128 | | | | | | | | |
| 2.5 TDI 4motion | 96 | 07/04→11/09 | for PR number: 1BH / 1BX / 1MR / 2MQ / 2MZ / 2MU / 2MT; Required quantity: 2; Fitting Position: Front Axle | 2 | 83.6113-0552.3 | 330864 | Length [mm]: 552 | | |
| 3.2 V6 | 170 | 08/03→11/09 | | | | | | | |
| | 173 | | Braking System: for vehicles with brake-power regulator; Required quantity: 2; Fitting Position: at brake caliper / Rear Axle | 2 | 24.5140-0194.3 | 331383 | Length [mm]: 190 | | |
| | | | for PR number: 0E1 / 0E2 / 0WL / 0WN / 0WM / 0WP / 0WQ; Required quantity: 2; Fitting Position: Rear Axle | 2 | 24.5140-0194.3 | 331383 | Length [mm]: 190 | | |
| | | | Required quantity: 2; Fitting Position: Rear Axle | 2 | 24.5237-0250.3 | 330880 | Length [mm]: 250 | | |
| | | | for PR number: 0WR; Required quantity: 2; Fitting Position: Rear Axle | 2 | 24.5237-0250.3 | 330880 | Length [mm]: 250 | | |
| 2.0 TDI | 84 | 05/11→08/15 | for PR number: 1BA / 1BB / 1BJ / 1BV / 1MG / 1MK / 1ML / 2MD / 2MF / 2MG / 2ML; Required quantity: 2; Fitting Position: Front Axle | 2 | 24.5140-0514.3 | 331290 | Length [mm]: 520 | | |
| 2.0 TSI | 110 | 07/12→08/15 | | | | | | | |
| | | | for PR number: 0WL / 0WN / 0WM / 0WP / 0WQ; Required quantity: 2; Fitting Position: Front Axle | 2 | 24.5140-0514.3 | 331290 | Length [mm]: 520 | | |
| | | | for PR number: 0WR; Required quantity: 2; Fitting Position: Front Axle | 2 | 83.6113-0552.3 | 330864 | Length [mm]: 552 | | |
| | | | for PR number: 1BH / 1BX / 1MR / 2MQ / 2MZ / 2MU / 2MT; Required quantity: 2; Fitting Position: Front Axle | 2 | 83.6113-0552.3 | 330864 | Length [mm]: 552 | | |
| | | | Braking System: for vehicles with brake-power regulator; Required quantity: 2; Fitting Position: at brake caliper / Rear Axle | 2 | 24.5140-0194.3 | 331383 | Length [mm]: 190 | | |
| | | | Required quantity: 2; Fitting Position: Rear Axle | 2 | 24.5140-0194.3 | 331383 | Length [mm]: 190 | | |
| | | | | | | | 24.5237-0250.3 | 330880 | Length [mm]: 250 |
| | | | for PR number: 0WR; Required quantity: 2; Fitting Position: Rear Axle | 2 | 24.5237-0250.3 | 330880 | Length [mm]: 250 | | |
| 2.5 TDI 4motion | 128 | 04/04→11/09 | Construction year from: 07/04 →; for PR number: 1BA / 1BB / 1BJ / 1BV / 1MG / 1MK / 1ML / 2MD / 2MF / 2MG / 2ML; Required quantity: 2; Fitting Position: Front Axle | 2 | 24.5140-0514.3 | 331290 | Length [mm]: 520 | | |
| 3.2 4motion | 170 | 11/03→11/09 | | | | | | | |

| | kW | | | | |
|--|------------------------------------|---|---|------------------------------|--------------------|
| VW - TRANSPORTER V Platform/Chassis (7JD, 7JE, 7JL, 7JY, 7JZ, 7FD 04/03→08/15) | | | | | |
|  Brake Hose | | | | | |
| 2.5 TDI 4motion 3.2 4motion | 128 04/04→11/09 170 11/03→11/09 | Construction year from: 07/04 →; for PR number: 0WL / 0WN / 0WM / 0WP / 0WQ; Required quantity: 2; Fitting Position: Front Axle | 2 | 24.5140-0514.3 331290 | Length [mm]: 520 |
| | | Construction year from: 07/04 →; for PR number: 0WR; Required quantity: 2; Fitting Position: Front Axle | 2 | 83.6113-0552.3 330864 | Length [mm]: 552 |
| | | Construction year from: 07/04 →; for PR number: 1BH / 1BX / 1MR / 2MQ / 2MZ / 2MU / 2MT; Required quantity: 2; Fitting Position: Front Axle | 2 | 83.6113-0552.3 330864 | Length [mm]: 552 |
| | | Construction year from: 07/04 →; for PR number: 0E1 / 0E2 / 0WL / 0WN / 0WM / 0WP / 0WQ; Required quantity: 2; Fitting Position: Rear Axle | 2 | 24.5140-0194.3 331383 | Length [mm]: 190 |
| | | Construction year from: 07/04 →; Braking System: for vehicles with brake- power regulator; Required quantity: 2; Fitting Position: at brake caliper / Rear Axle | 2 | 24.5140-0194.3 331383 | Length [mm]: 190 |
| | | Construction year from: 07/04 →; Required quantity: 2; Fitting Position: Rear Axle | 2 | 24.5237-0250.3 330880 | Length [mm]: 250 |
| | | Construction year from: 07/04 →; for PR number: 0WR; Required quantity: 2; Fitting Position: Rear Axle | 2 | 24.5237-0250.3 330880 | Length [mm]: 250 |
|  Wheel Speed Sensor | | | | | |
| 1.9 TDI | 62 - 04/03→11/09 77 | Fitting Position: Front Axle Left | | 24.0711-5271.3 360301 | |
| 2.0 | 85 11/03→05/13 | Fitting Position: Front Axle Right | | 24.0711-5272.3 360302 | |
| 2.0 BiTDI | 132 09/09→08/15 | Fitting Position: Rear Axle Left | | 24.0711-5271.3 360301 | |
| 2.0 BiTDI 4motion | 132 09/09→08/15 | Fitting Position: Rear Axle Right | | 24.0711-5272.3 360302 | |
| 2.0 CNG | 85 11/03→05/11 | | | | |
| 2.0 TDI | 62 - 09/09→08/15 103 | | | | |
| 2.0 TDI 4motion | 100 - 09/09→08/15 103 | | | | |
| 2.0 TSI | 110 07/12→08/15 | | | | |
| 2.5 TDI | 96 - 04/03→11/09 128 | | | | |
| 2.5 TDI 4motion | 96 07/04→11/09 | | | | |
| 3.2 V6 | 170 - 08/03→11/09 173 | | | | |
| 2.5 TDI 4motion 3.2 4motion | 128 04/04→11/09 170 11/03→11/09 | Construction year from: 07/04 →; Fitting Position: Front Axle Left | | 24.0711-5271.3 360301 | |
| | | Construction year from: 07/04 →; Fitting Position: Front Axle Right | | 24.0711-5272.3 360302 | |
| | | Construction year from: 07/04 →; Fitting Position: Rear Axle Left | | 24.0711-5271.3 360301 | |
| | | Construction year from: 07/04 →; Fitting Position: Rear Axle Right | | 24.0711-5272.3 360302 | |
|  Cable Pull, parking brake | | | | | |
| 1.9 TDI | 62 - 04/03→11/09 77 | for PR number: 0E1 / 0E2 / 0WL / 0WN / 0WM / 0WP / 0WQ; Required quantity: 2; Fitting Position: Rear | 2 | 24.3727-0184.2 580184 | Length [mm]: 1,303 |
| 2.0 | 85 11/03→05/13 | | | | |
| 2.0 BiTDI | 132 09/09→08/15 | | | | |
| 2.0 CNG | 85 11/03→05/11 | | | | |
| 2.0 TDI | 62 - 09/09→08/15 103 | | | | |
| 2.5 TDI | 96 - 04/03→11/09 128 | | | | |
| 3.2 V6 | 170 - 08/03→11/09 173 | | | | |
| 2.0 TDI 2.0 TSI | 84 05/11→08/15 110 07/12→08/15 | Required quantity: 2; Fitting Position: Rear | 2 | 24.3727-0184.2 580184 | Length [mm]: 1,303 |
| 3.2 4motion | 170 11/03→11/09 | Vehicle Identification Number from: 7H- A-200001 →; Brake Type: Disc Brake; for PR number: G0C / G0K / G1C; Required quantity: 2; Fitting Position: Rear | 2 | 24.3727-0184.2 580184 | Length [mm]: 1,303 |
| | | Vehicle Identification Number from: 7H-7-000001 →; for PR number: 0WR / 0E1; Required quantity: 2; Fitting Position: Rear | 2 | 24.3727-3409.2 583409 | Length [mm]: 1,570 |



| | kW | | | | |
|--|--|---|------------------------------|--|--|
| VW - TRANSPORTER V Van (7HA, 7HH, 7EA, 7EH) 04/03→ | | | | | |
|  Brake Caliper | | | | | |
| 1.9 TDI | 62 - 01/06→11/09 75 | Vehicle Identification Number from: 7H-A-200001 →; for PR number: 2E4; Fitting Position: Front Axle Left | 24.3441-9933.5 241141 | Brake System: ATE Supplementary Article/Supplementary Info: without holder Brake Caliper Type: Fist-type Caliper (2 pistons) | |
| | | Vehicle Identification Number from: 7H-A-200001 →; for PR number: 2E4; Fitting Position: Front Axle Right | 24.3441-9934.5 241142 | Brake System: ATE Supplementary Article/Supplementary Info: without holder Brake Caliper Type: Fist-type Caliper (2 pistons) | |
| | | for PR number: 2E3; Fitting Position: Front Axle Left | 24.3601-9947.5 240597 | Brake System: ATE Supplementary Article/Supplementary Info: without holder Brake Caliper Type: Fist-type Caliper | |
| | | for PR number: 2E3; Fitting Position: Front Axle Right | 24.3601-9948.5 240598 | Brake System: ATE Supplementary Article/Supplementary Info: without holder Brake Caliper Type: Fist-type Caliper | |
| | | Vehicle Identification Number from: 7H-A-200001 →; Fitting Position: Rear Axle Left | 24.3414-1711.5 240852 | Brake System: Lucas / TRW Supplementary Article/Supplementary Info: without holder Brake Caliper Type: Fist-type Caliper | |
| | | Vehicle Identification Number from: 7H-6-000001 →; for PR number: 2E3 / 2E4; → Vehicle Identification Number to: 7H-A-050000; Fitting Position: Rear Axle Left | 24.3414-1711.5 240852 | Brake System: Lucas / TRW Supplementary Article/Supplementary Info: without holder Brake Caliper Type: Fist-type Caliper | |
| | | Vehicle Identification Number from: 7H-8-028000 →; for PR number: 0WR; → Vehicle Identification Number to: 7H-8-200000; Fitting Position: Rear Axle Left | 24.3414-1711.5 240852 | Brake System: Lucas / TRW Supplementary Article/Supplementary Info: without holder Brake Caliper Type: Fist-type Caliper | |
| | | Vehicle Identification Number from: 7H-A-200001 →; Fitting Position: Rear Axle Right | 24.3414-1712.5 240853 | Brake System: Lucas / TRW Supplementary Article/Supplementary Info: without holder Brake Caliper Type: Fist-type Caliper | |
| | | Vehicle Identification Number from: 7H-8-028000 →; for PR number: 0WR; → Vehicle Identification Number to: 7H-8-200000; Fitting Position: Rear Axle Right | 24.3414-1712.5 240853 | Brake System: Lucas / TRW Supplementary Article/Supplementary Info: without holder Brake Caliper Type: Fist-type Caliper | |
| | | Vehicle Identification Number from: 7H-6-000001 →; for PR number: 2E3 / 2E4; → Vehicle Identification Number to: 7H-A-050000; Fitting Position: Rear Axle Right | 24.3414-1712.5 240853 | Brake System: Lucas / TRW Supplementary Article/Supplementary Info: without holder Brake Caliper Type: Fist-type Caliper | |
| 1.9 TDI 2.0 2.0 BiFuel 2.5 TDI 2.5 TDI 4motion 3.2 V6 | 63 - 04/03→11/09 77 85 11/03→08/15 85 05/11→08/15 96 - 04/03→11/09 128 96 - 07/04→11/09 128 170 - 04/03→11/09 173 | Vehicle Identification Number from: 7H-A-200001 →; for PR number: 2E4; Fitting Position: Front Axle Left | 24.3441-9933.5 241141 | Brake System: ATE Supplementary Article/Supplementary Info: without holder Brake Caliper Type: Fist-type Caliper (2 pistons) | |
| | | Vehicle Identification Number from: 7H-A-200001 →; for PR number: 2E4; Fitting Position: Front Axle Right | 24.3441-9934.5 241142 | Brake System: ATE Supplementary Article/Supplementary Info: without holder Brake Caliper Type: Fist-type Caliper (2 pistons) | |
| | | for PR number: 2E3; Fitting Position: Front Axle Left | 24.3601-9947.5 240597 | Brake System: ATE Supplementary Article/Supplementary Info: without holder Brake Caliper Type: Fist-type Caliper | |
| | | for PR number: 2E3; Fitting Position: Front Axle Right | 24.3601-9948.5 240598 | Brake System: ATE Supplementary Article/Supplementary Info: without holder Brake Caliper Type: Fist-type Caliper | |
| | | Vehicle Identification Number from: 7H-A-200001 →; Fitting Position: Rear Axle Left | 24.3414-1711.5 240852 | Brake System: Lucas / TRW Supplementary Article/Supplementary Info: without holder Brake Caliper Type: Fist-type Caliper | |
| → | | | | | |

| | kW | | | | |
|--|--------------------------|--|--|------------------------------|--|
| VW - TRANSPORTER V Van (7HA, 7HH, 7EA, 7EH) 04/03→ | | | | | |
|  Brake Caliper | | | | | |
| 1.9 TDI | 63 - 04/03→11/09 77 | for PR number: 0WL / 0WN / 0WM / 0WP / 0WQ; → Vehicle Identification Number to: 7H-5-120000; | | 24.3414-1711.5 240852 | Brake System: Lucas / TRW Supplementary Article/Supplementary Info: without holder Brake Caliper Type: Fist-type Caliper |
| 2.0 | 85 11/03→08/15 | | | | |
| 2.0 BiFuel | 85 05/11→08/15 | | | | |
| 2.5 TDI | 96 - 04/03→11/09 128 | Fitting Position: Rear Axle Left | | | |
| 2.5 TDI 4motion | 96 - 07/04→11/09 128 | Vehicle Identification Number from: 7H-8-028000 →; for PR number: 0WR; → Vehicle Identification Number to: 7H-8-200000; | | 24.3414-1711.5 240852 | Brake System: Lucas / TRW Supplementary Article/Supplementary Info: without holder Brake Caliper Type: Fist-type Caliper |
| 3.2 V6 | 170 - 04/03→11/09 173 | Fitting Position: Rear Axle Left | | | |
| | | Vehicle Identification Number from: 7H-6-000001 →; for PR number: 2E3 / 2E4; → Vehicle Identification Number to: 7H-A-050000; Fitting Position: Rear Axle Left | | 24.3414-1711.5 240852 | Brake System: Lucas / TRW Supplementary Article/Supplementary Info: without holder Brake Caliper Type: Fist-type Caliper |
| | | for PR number: 0WL / 0WN / 0WM / 0WP / 0WQ; → Vehicle Identification Number to: 7H-5-120000; | | 24.3414-1712.5 240853 | Brake System: Lucas / TRW Supplementary Article/Supplementary Info: without holder Brake Caliper Type: Fist-type Caliper |
| | | Fitting Position: Rear Axle Right | | | |
| | | Vehicle Identification Number from: 7H-A-200001 →; Fitting Position: Rear Axle Right | | 24.3414-1712.5 240853 | Brake System: Lucas / TRW Supplementary Article/Supplementary Info: without holder Brake Caliper Type: Fist-type Caliper |
| | | Vehicle Identification Number from: 7H-8-028000 →; for PR number: 0WR; → Vehicle Identification Number to: 7H-8-200000; | | 24.3414-1712.5 240853 | Brake System: Lucas / TRW Supplementary Article/Supplementary Info: without holder Brake Caliper Type: Fist-type Caliper |
| | | Fitting Position: Rear Axle Right | | | |
| | | Vehicle Identification Number from: 7H-6-000001 →; for PR number: 2E3 / 2E4; → Vehicle Identification Number to: 7H-A-050000; | | 24.3414-1712.5 240853 | Brake System: Lucas / TRW Supplementary Article/Supplementary Info: without holder Brake Caliper Type: Fist-type Caliper |
| | | Fitting Position: Rear Axle Right | | | |
| 2.0 BiTDI | 132 09/09→08/15 | Vehicle Identification Number from: 7H-A-200001 →; for PR number: 2E4; | | 24.3441-9933.5 241141 | Brake System: ATE Supplementary Article/Supplementary Info: without holder Brake Caliper Type: Fist-type Caliper (2 pistons) |
| 2.0 BiTDI 4motion | 132 09/09→08/15 | Fitting Position: Front Axle Left | | | |
| 2.0 TDI | 62 - 09/09→08/15 103 | | | | |
| 2.0 TDI 4motion | 103 09/09→08/15 | | | | |
| | | Vehicle Identification Number from: 7H-A-200001 →; for PR number: 2E4; | | 24.3441-9934.5 241142 | Brake System: ATE Supplementary Article/Supplementary Info: without holder Brake Caliper Type: Fist-type Caliper (2 pistons) |
| | | Fitting Position: Front Axle Right | | | |
| | | for PR number: 2E3; Fitting Position: Front Axle Left | | 24.3601-9947.5 240597 | Brake System: ATE Supplementary Article/Supplementary Info: without holder Brake Caliper Type: Fist-type Caliper |
| | | for PR number: 2E3; Fitting Position: Front Axle Right | | 24.3601-9948.5 240598 | Brake System: ATE Supplementary Article/Supplementary Info: without holder Brake Caliper Type: Fist-type Caliper |
| | | Vehicle Identification Number from: 7H-A-200001 →; Fitting Position: Rear Axle Left | | 24.3414-1711.5 240852 | Brake System: Lucas / TRW Supplementary Article/Supplementary Info: without holder Brake Caliper Type: Fist-type Caliper |
| | | Vehicle Identification Number from: 7H-6-000001 →; for PR number: 2E3 / 2E4; → Vehicle Identification Number to: 7H-A-050000; Fitting Position: Rear Axle Left | | 24.3414-1711.5 240852 | Brake System: Lucas / TRW Supplementary Article/Supplementary Info: without holder Brake Caliper Type: Fist-type Caliper |
| | | Vehicle Identification Number from: 7H-A-200001 →; Fitting Position: Rear Axle Right | | 24.3414-1712.5 240853 | Brake System: Lucas / TRW Supplementary Article/Supplementary Info: without holder Brake Caliper Type: Fist-type Caliper |
| | | Vehicle Identification Number from: 7H-6-000001 →; for PR number: 2E3 / 2E4; → Vehicle Identification Number to: 7H-A-050000; | | 24.3414-1712.5 240853 | Brake System: Lucas / TRW Supplementary Article/Supplementary Info: without holder Brake Caliper Type: Fist-type Caliper |
| | | Fitting Position: Rear Axle Right | | | |
| → | | | | | |



| | kw | | | | |
|--|---|--|------------------------------|--|--|
| VW - TRANSPORTER V Van (7HA, 7HH, 7EA, 7EH) 04/03→ | | | | | |
|  Brake Caliper | | | | | |
| 2.0 TDI 2.0 TSI 2.0 TSI 4motion | 84 05/11→08/15 110 - 05/11→08/15 150 150 07/11→08/15 | for PR number: 2E4; Fitting Position: Front Axle Left | 24.3441-9933.5 241141 | Brake System: ATE Supplementary Article/Supplementary Info: without holder Brake Caliper Type: Fist-type Caliper (2 pistons) | |
| | | for PR number: 2E4; Fitting Position: Front Axle Right | 24.3441-9934.5 241142 | Brake System: ATE Supplementary Article/Supplementary Info: without holder Brake Caliper Type: Fist-type Caliper (2 pistons) | |
| | | for PR number: 2E3; Fitting Position: Front Axle Left | 24.3601-9947.5 240597 | Brake System: ATE Supplementary Article/Supplementary Info: without holder Brake Caliper Type: Fist-type Caliper | |
| | | for PR number: 2E3; Fitting Position: Front Axle Right | 24.3601-9948.5 240598 | Brake System: ATE Supplementary Article/Supplementary Info: without holder Brake Caliper Type: Fist-type Caliper | |
| | | Fitting Position: Rear Axle Left | 24.3414-1711.5 240852 | Brake System: Lucas / TRW Supplementary Article/Supplementary Info: without holder Brake Caliper Type: Fist-type Caliper | |
| | | Fitting Position: Rear Axle Right | 24.3414-1712.5 240853 | Brake System: Lucas / TRW Supplementary Article/Supplementary Info: without holder Brake Caliper Type: Fist-type Caliper | |
| 2.0 TDI 2.0 TDI 4motion | 100 05/10→08/15 100 05/10→08/15 | Vehicle Identification Number from: 7H-A-200001 →; for PR number: 2E4; Fitting Position: Front Axle Left | 24.3441-9933.5 241141 | Brake System: ATE Supplementary Article/Supplementary Info: without holder Brake Caliper Type: Fist-type Caliper (2 pistons) | |
| | | Vehicle Identification Number from: 7H-A-200001 →; for PR number: 2E4; Fitting Position: Front Axle Right | 24.3441-9934.5 241142 | Brake System: ATE Supplementary Article/Supplementary Info: without holder Brake Caliper Type: Fist-type Caliper (2 pistons) | |
| | | for PR number: 2E3; Fitting Position: Front Axle Left | 24.3601-9947.5 240597 | Brake System: ATE Supplementary Article/Supplementary Info: without holder Brake Caliper Type: Fist-type Caliper | |
| | | for PR number: 2E3; Fitting Position: Front Axle Right | 24.3601-9948.5 240598 | Brake System: ATE Supplementary Article/Supplementary Info: without holder Brake Caliper Type: Fist-type Caliper | |
| | | Vehicle Identification Number from: 7H-A-200001 →; Fitting Position: Rear Axle Left | 24.3414-1711.5 240852 | Brake System: Lucas / TRW Supplementary Article/Supplementary Info: without holder Brake Caliper Type: Fist-type Caliper | |
| | | Vehicle Identification Number from: 7H-A-200001 →; Fitting Position: Rear Axle Right | 24.3414-1712.5 240853 | Brake System: Lucas / TRW Supplementary Article/Supplementary Info: without holder Brake Caliper Type: Fist-type Caliper | |
| 3.2 4motion 3.2 V6 4motion | 173 11/03→11/09 170 04/03→06/05 | Vehicle Identification Number from: 7H-A-200001 →; for PR number: 2E4; Fitting Position: Front Axle Left | 24.3441-9933.5 241141 | Brake System: ATE Supplementary Article/Supplementary Info: without holder Brake Caliper Type: Fist-type Caliper (2 pistons) | |
| | | Vehicle Identification Number from: 7H-A-200001 →; for PR number: 2E4; Fitting Position: Front Axle Right | 24.3441-9934.5 241142 | Brake System: ATE Supplementary Article/Supplementary Info: without holder Brake Caliper Type: Fist-type Caliper (2 pistons) | |
| | | Construction year from: 07/04 →; for PR number: 2E3; Fitting Position: Front Axle Left | 24.3601-9947.5 240597 | Brake System: ATE Supplementary Article/Supplementary Info: without holder Brake Caliper Type: Fist-type Caliper | |
| → | | | | | |



| | kW | | | | |
|--|------------------------------------|--|--------------------------------|--|--|
| VW - TRANSPORTER V Van (7HA, 7HH, 7EA, 7EH) 04/03→ | | | | | |
|  Brake Caliper | | | | | |
| 3.2 4motion 3.2 V6 4motion | 173 11/03→11/09 170 04/03→06/05 | Construction year from: 07/04 →; for PR number: 2E3; Fitting Position: Front Axle Right | 24.3601-9948.5 240598 | Brake System: ATE Supplementary Article/Supplementary Info: without holder Brake Caliper Type: Fist-type Caliper | |
| | | Vehicle Identification Number from: 7H-A-200001 →; Fitting Position: Rear Axle Left | 24.3414-1711.5 240852 | Brake System: Lucas / TRW Supplementary Article/Supplementary Info: without holder Brake Caliper Type: Fist-type Caliper | |
| | | Construction year from: 07/04 →; for PR number: 0WL / 0WN / 0WM / 0WP / 0WQ; → Vehicle Identification Number to: 7H-5-120000; Fitting Position: Rear Axle Left | 24.3414-1711.5 240852 | Brake System: Lucas / TRW Supplementary Article/Supplementary Info: without holder Brake Caliper Type: Fist-type Caliper | |
| | | Vehicle Identification Number from: 7H-8-028000 →; for PR number: 0WR; → Vehicle Identification Number to: 7H-8-200000; Fitting Position: Rear Axle Left | 24.3414-1711.5 240852 | Brake System: Lucas / TRW Supplementary Article/Supplementary Info: without holder Brake Caliper Type: Fist-type Caliper | |
| | | Vehicle Identification Number from: 7H-6-000001 →; for PR number: 2E3 / 2E4; → Vehicle Identification Number to: 7H-A-050000; Fitting Position: Rear Axle Left | 24.3414-1711.5 240852 | Brake System: Lucas / TRW Supplementary Article/Supplementary Info: without holder Brake Caliper Type: Fist-type Caliper | |
| | | Construction year from: 07/04 →; for PR number: 0WL / 0WN / 0WM / 0WP / 0WQ; → Vehicle Identification Number to: 7H-5-120000; Fitting Position: Rear Axle Right | 24.3414-1712.5 240853 | Brake System: Lucas / TRW Supplementary Article/Supplementary Info: without holder Brake Caliper Type: Fist-type Caliper | |
| | | Vehicle Identification Number from: 7H-A-200001 →; Fitting Position: Rear Axle Right | 24.3414-1712.5 240853 | Brake System: Lucas / TRW Supplementary Article/Supplementary Info: without holder Brake Caliper Type: Fist-type Caliper | |
| | | Vehicle Identification Number from: 7H-8-028000 →; for PR number: 0WR; → Vehicle Identification Number to: 7H-8-200000; Fitting Position: Rear Axle Right | 24.3414-1712.5 240853 | Brake System: Lucas / TRW Supplementary Article/Supplementary Info: without holder Brake Caliper Type: Fist-type Caliper | |
| | | Vehicle Identification Number from: 7H-6-000001 →; for PR number: 2E3 / 2E4; → Vehicle Identification Number to: 7H-A-050000; Fitting Position: Rear Axle Right | 24.3414-1712.5 240853 | Brake System: Lucas / TRW Supplementary Article/Supplementary Info: without holder Brake Caliper Type: Fist-type Caliper | |
| Spring, brake caliper | | | | | |
| 1.9 TDI | 62 - 04/03→11/09 77 | Vehicle Identification Number from: 7H-A-200001 →; for PR number: 2E4; Required quantity: 2 | 2 11.8116-0126.2 390608 | Brake System: ATE | |
| 2.0 | 85 11/03→08/15 | | | | |
| 2.0 BiFuel | 85 05/11→08/15 | | | | |
| 2.0 BiTDI | 132 09/09→08/15 | → Vehicle Identification Number to: 7H-A-050000; for PR number: 2E4; Required quantity: 2 | 2 11.8116-0237.1 390509 | Brake System: ATE | |
| 2.0 BiTDI 4motion | 132 09/09→08/15 | | | | |
| 2.0 TDI | 62 - 09/09→08/15 103 | for PR number: 2E3; Required quantity: 2 | 2 11.8116-0237.1 390509 | Brake System: ATE | |
| 2.0 TDI 4motion | 103 09/09→08/15 | | | | |
| 2.5 TDI | 96 - 04/03→11/09 128 | | | | |
| 2.5 TDI 4motion | 96 - 07/04→11/09 128 | | | | |
| 3.2 V6 | 170 - 04/03→11/09 173 | | | | |
| 2.0 TDI | 84 05/11→08/15 | for PR number: 2E4; Required quantity: 2 | 2 11.8116-0126.2 390608 | Brake System: ATE | |
| 2.0 TSI | 110 - 05/11→08/15 150 | for PR number: 2E3; Required quantity: 2 | 2 11.8116-0237.1 390509 | Brake System: ATE | |
| 2.0 TSI 4motion | 150 07/11→08/15 | | | | |
| 2.0 TDI | 100 05/10→08/15 | Vehicle Identification Number from: 7H-A-200001 →; for PR number: 2E4; Required quantity: 2 | 2 11.8116-0126.2 390608 | Brake System: ATE | |
| 2.0 TDI 4motion | 100 05/10→08/15 | | | | |
| | | for PR number: 2E3; Required quantity: 2 | 2 11.8116-0237.1 390509 | Brake System: ATE | |
| 3.2 4motion | 173 11/03→11/09 | Vehicle Identification Number from: 7H-A-200001 →; for PR number: 2E4; Required quantity: 2 | 2 11.8116-0126.2 390608 | Brake System: ATE | |
| 3.2 V6 4motion | 170 04/03→06/05 | | | | |
| | | Construction year from: 07/04 →; for PR number: 2E3; Required quantity: 2 | 2 11.8116-0237.1 390509 | Brake System: ATE | |
| → | | | | | |



| | | | | | |
|--|--|---|---|------------------------------|--|
| | kW | | | | |
| VW - TRANSPORTER V Van (7HA, 7HH, 7EA, 7EH) 04/03→ | | | | | |
| Spring, brake caliper | | | | | |
| 3.2 4motion 3.2 V6 4motion | 173 11/03→11/09 170 04/03→06/05 | Construction year from: 07/04 →; → Vehicle Identification Number to: 7H-A-050000; for PR number: 2E4; Required quantity: 2 | 2 | 11.8116-0237.1 390509 | Brake System: ATE |
|  Brake Pad Set, disc brake | | | | | |
| 1.9 TDI | 62 - 01/06→11/09 75 | for PR number: 2E3; Fitting Position: Front Axle | | 13.0460-7236.2 607236 | Brake System: ATE 23746 19,7 Wear Warning Contact: incl. wear warning contact |
| | | Vehicle Identification Number from: 7H-A-200001 →; for PR number: 2E4; Fitting Position: Front Axle | | 13.0460-7286.2 607286 | Brake System: ATE 24623 18,2 Wear Warning Contact: incl. wear warning contact |
| | | Vehicle Identification Number from: 7H-A-200001 →; Fitting Position: Rear Axle | | 13.0460-2882.2 602882 | Brake System: Lucas / TRW 23326 17,4 Wear Warning Contact: incl. wear warning contact Supplementary Article/Supplementary Info: with accessories |
| | | Vehicle Identification Number from: 7H-8-028000 →; for PR number: 0WR; → Vehicle Identification Number to: 7H-8-200000; Fitting Position: Rear Axle | | 13.0460-2882.2 602882 | Brake System: Lucas / TRW 23326 17,4 Wear Warning Contact: incl. wear warning contact Supplementary Article/Supplementary Info: with accessories |
| | | Vehicle Identification Number from: 7H-6-000001 →; for PR number: 2E3 / 2E4; → Vehicle Identification Number to: 7H-A-050000; Fitting Position: Rear Axle | | 13.0460-2882.2 602882 | Brake System: Lucas / TRW 23326 17,4 Wear Warning Contact: incl. wear warning contact Supplementary Article/Supplementary Info: with accessories |
| 1.9 TDI 2.0 2.0 BiFuel 2.5 TDI 2.5 TDI 4motion 3.2 V6 | 63 - 04/03→11/09 77 85 11/03→08/15 85 05/11→08/15 96 - 04/03→11/09 128 96 - 07/04→11/09 128 170 - 04/03→11/09 173 | for PR number: 2E3; Fitting Position: Front Axle | | 13.0460-7236.2 607236 | Brake System: ATE 23746 19,7 Wear Warning Contact: incl. wear warning contact |
| | | Vehicle Identification Number from: 7H-A-200001 →; for PR number: 2E4; Fitting Position: Front Axle | | 13.0460-7286.2 607286 | Brake System: ATE 24623 18,2 Wear Warning Contact: incl. wear warning contact |
| | | Vehicle Identification Number from: 7H-A-200001 →; Fitting Position: Rear Axle | | 13.0460-2882.2 602882 | Brake System: Lucas / TRW 23326 17,4 Wear Warning Contact: incl. wear warning contact Supplementary Article/Supplementary Info: with accessories |
| | | for PR number: 0WL / 0WN / 0WM / 0WP / 0WQ; → Vehicle Identification Number to: 7H-5-120000; Fitting Position: Rear Axle | | 13.0460-2882.2 602882 | Brake System: Lucas / TRW 23326 17,4 Wear Warning Contact: incl. wear warning contact Supplementary Article/Supplementary Info: with accessories |
| | | Vehicle Identification Number from: 7H-6-000001 →; for PR number: 2E3 / 2E4; → Vehicle Identification Number to: 7H-A-050000; Fitting Position: Rear Axle | | 13.0460-2882.2 602882 | Brake System: Lucas / TRW 23326 17,4 Wear Warning Contact: incl. wear warning contact Supplementary Article/Supplementary Info: with accessories |
| | | Vehicle Identification Number from: 7H-8-028000 →; for PR number: 0WR; → Vehicle Identification Number to: 7H-8-200000; Fitting Position: Rear Axle | | 13.0460-2882.2 602882 | Brake System: Lucas / TRW 23326 17,4 Wear Warning Contact: incl. wear warning contact Supplementary Article/Supplementary Info: with accessories |
| 2.0 BiTDI 2.0 BiTDI 4motion 2.0 TDI 2.0 TDI 4motion | 132 09/09→08/15 132 09/09→08/15 62 - 09/09→08/15 103 103 09/09→08/15 | for PR number: 2E3; Fitting Position: Front Axle | | 13.0460-7236.2 607236 | Brake System: ATE 23746 19,7 Wear Warning Contact: incl. wear warning contact |
| | | Vehicle Identification Number from: 7H-A-200001 →; for PR number: 2E4; Fitting Position: Front Axle | | 13.0460-7286.2 607286 | Brake System: ATE 24623 18,2 Wear Warning Contact: incl. wear warning contact |
| | | Vehicle Identification Number from: 7H-A-200001 →; Fitting Position: Rear Axle | | 13.0460-2882.2 602882 | Brake System: Lucas / TRW 23326 17,4 Wear Warning Contact: incl. wear warning contact Supplementary Article/Supplementary Info: with accessories |
| → | | | | | |







| | kW | | | | |
|--|--|--|--|------------------------------|--|
| VW - TRANSPORTER V Van (7HA, 7HH, 7EA, 7EH) 04/03→ | | | | | |
|  Brake Pad Set, disc brake | | | | | |
| 2.0 BiTDI 2.0 BiTDI 4motion 2.0 TDI 2.0 TDI 4motion | 132 09/09→08/15 132 09/09→08/15 62 - 09/09→08/15 103 103 09/09→08/15 | Vehicle Identification Number from: 7H-6-000001 →; for PR number: 2E3 / 2E4; → Vehicle Identification Number to: 7H- A-050000; Fitting Position: Rear Axle | | 13.0460-2882.2 602882 | Brake System: Lucas / TRW 23326 17,4 Wear Warning Contact: incl. wear warning contact Supplementary Article/Supple- mentary Info: with accessories |
| 2.0 TDI 2.0 TSI 2.0 TSI 4motion | 84 05/11→08/15 110 - 05/11→08/15 150 150 07/11→08/15 | for PR number: 2E3; Fitting Position: Front Axle | | 13.0460-7236.2 607236 | Brake System: ATE 23746 19,7 Wear Warning Contact: incl. wear warning contact |
| | | for PR number: 2E4; Fitting Position: Front Axle | | 13.0460-7286.2 607286 | Brake System: ATE 24623 18,2 Wear Warning Contact: incl. wear warning contact |
| | | Fitting Position: Rear Axle | | 13.0460-2882.2 602882 | Brake System: Lucas / TRW 23326 17,4 Wear Warning Contact: incl. wear warning contact Supplementary Article/Supple- mentary Info: with accessories |
| 2.0 TDI 2.0 TDI 4motion | 100 05/10→08/15 100 05/10→08/15 | for PR number: 2E3; Fitting Position: Front Axle | | 13.0460-7236.2 607236 | Brake System: ATE 23746 19,7 Wear Warning Contact: incl. wear warning contact |
| | | Vehicle Identification Number from: 7H- A-200001 →; for PR number: 2E4; Fitting Position: Front Axle | | 13.0460-7286.2 607286 | Brake System: ATE 24623 18,2 Wear Warning Contact: incl. wear warning contact |
| | | Vehicle Identification Number from: 7H- A-200001 →; Fitting Position: Rear Axle | | 13.0460-2882.2 602882 | Brake System: Lucas / TRW 23326 17,4 Wear Warning Contact: incl. wear warning contact Supplementary Article/Supple- mentary Info: with accessories |
| 3.2 4motion 3.2 V6 4motion | 173 11/03→11/09 170 04/03→06/05 | Construction year from: 07/04 →; for PR number: 2E3; Fitting Position: Front Axle | | 13.0460-7236.2 607236 | Brake System: ATE 23746 19,7 Wear Warning Contact: incl. wear warning contact |
| | | Vehicle Identification Number from: 7H- A-200001 →; for PR number: 2E4; Fitting Position: Front Axle | | 13.0460-7286.2 607286 | Brake System: ATE 24623 18,2 Wear Warning Contact: incl. wear warning contact |
| | | Vehicle Identification Number from: 7H- A-200001 →; Fitting Position: Rear Axle | | 13.0460-2882.2 602882 | Brake System: Lucas / TRW 23326 17,4 Wear Warning Contact: incl. wear warning contact Supplementary Article/Supple- mentary Info: with accessories |
| | | Construction year from: 07/04 →; for PR number: 0WL / 0WN / 0WM / 0WP / 0WQ; → Vehicle Identification Number to: 7H-5-120000; Fitting Position: Rear Axle | | 13.0460-2882.2 602882 | Brake System: Lucas / TRW 23326 17,4 Wear Warning Contact: incl. wear warning contact Supplementary Article/Supple- mentary Info: with accessories |
| | | Vehicle Identification Number from: 7H-8-028000 →; for PR number: 0WR; → Vehicle Identification Number to: 7H-8-200000; Fitting Position: Rear Axle | | 13.0460-2882.2 602882 | Brake System: Lucas / TRW 23326 17,4 Wear Warning Contact: incl. wear warning contact Supplementary Article/Supple- mentary Info: with accessories |
| | | Vehicle Identification Number from: 7H-6-000001 →; for PR number: 2E3 / 2E4; → Vehicle Identification Number to: 7H- A-050000; Fitting Position: Rear Axle | | 13.0460-2882.2 602882 | Brake System: Lucas / TRW 23326 17,4 Wear Warning Contact: incl. wear warning contact Supplementary Article/Supple- mentary Info: with accessories |
|  Brake Disc | | | | | |
| 1.9 TDI | 62 - 01/06→11/09 75 | for PR number: 2E3; Fitting Position: Front Axle | | 24.0130-0114.1 430114 | Outer diameter [mm]: 308 Brake Disc Thickness [mm] 29.5 Minimum thickness [mm] 25.5 Brake Disc Type: Vented |
| | | Vehicle Identification Number from: 7H- A-200001 →; for PR number: 2E4; Fitting Position: Front Axle | | 24.0133-0100.1 433100 | Outer diameter [mm]: 340 Brake Disc Thickness [mm] 32.6 Minimum thickness [mm] 29.5 Brake Disc Type: Vented Supplementary Article/Info 2: with bolts/screws |
| → | | | | | |





| | kW | | | | |
|---|--------------------------|---|------------------------------|---|--|
| VW - TRANSPORTER V Van (7HA, 7HH, 7EA, 7EH) 04/03→ | | | | | |
|  Brake Disc | | | | | |
| 1.9 TDI | 62 - 01/06→11/09 75 | Vehicle Identification Number from: 7H-A-200001 →; Fitting Position: Rear Axle | 24.0122-0211.1 422211 | Outer diameter [mm]: 294 Brake Disc Thickness [mm] 21.9 Minimum thickness [mm] 19.5 Brake Disc Type: Vented Supplementary Article/Info 2: with bolts/screws | |
| | | Vehicle Identification Number from: 7H-6-000001 →; for PR number: 2E3 / 2E4; → Vehicle Identification Number to: 7H-A-050000; Fitting Position: Rear Axle | 24.0122-0211.1 422211 | Outer diameter [mm]: 294 Brake Disc Thickness [mm] 21.9 Minimum thickness [mm] 19.5 Brake Disc Type: Vented Supplementary Article/Info 2: with bolts/screws | |
| | | Vehicle Identification Number from: 7H-8-028000 →; for PR number: 0WR; → Vehicle Identification Number to: 7H-8-200000; Fitting Position: Rear Axle | 24.0122-0211.1 422211 | Outer diameter [mm]: 294 Brake Disc Thickness [mm] 21.9 Minimum thickness [mm] 19.5 Brake Disc Type: Vented Supplementary Article/Info 2: with bolts/screws | |
| 1.9 TDI | 63 - 04/03→11/09 77 | for PR number: 2E3; Fitting Position: Front Axle | 24.0130-0114.1 430114 | Outer diameter [mm]: 308 Brake Disc Thickness [mm] 29.5 Minimum thickness [mm] 25.5 Brake Disc Type: Vented | |
| 2.0 | 85 11/03→08/15 | | | | |
| 2.0 BiFuel | 85 05/11→08/15 | | | | |
| 2.5 TDI | 96 - 04/03→11/09 128 | Vehicle Identification Number from: 7H-A-200001 →; for PR number: 2E4; Fitting Position: Front Axle | 24.0133-0100.1 433100 | Outer diameter [mm]: 340 Brake Disc Thickness [mm] 32.6 Minimum thickness [mm] 29.5 Brake Disc Type: Vented Supplementary Article/Info 2: with bolts/screws | |
| 2.5 TDI 4motion | 96 - 07/04→11/09 128 | | | | |
| 3.2 V6 | 170 - 04/03→11/09 173 | | | | |
| | | Vehicle Identification Number from: 7H-A-200001 →; Fitting Position: Rear Axle | 24.0122-0211.1 422211 | Outer diameter [mm]: 294 Brake Disc Thickness [mm] 21.9 Minimum thickness [mm] 19.5 Brake Disc Type: Vented Supplementary Article/Info 2: with bolts/screws | |
| | | for PR number: 0WL / 0WN / 0WM / 0WP / 0WQ; → Vehicle Identification Number to: 7H-5-120000; Fitting Position: Rear Axle | 24.0122-0211.1 422211 | Outer diameter [mm]: 294 Brake Disc Thickness [mm] 21.9 Minimum thickness [mm] 19.5 Brake Disc Type: Vented Supplementary Article/Info 2: with bolts/screws | |
| | | Vehicle Identification Number from: 7H-8-028000 →; for PR number: 0WR; → Vehicle Identification Number to: 7H-8-200000; Fitting Position: Rear Axle | 24.0122-0211.1 422211 | Outer diameter [mm]: 294 Brake Disc Thickness [mm] 21.9 Minimum thickness [mm] 19.5 Brake Disc Type: Vented Supplementary Article/Info 2: with bolts/screws | |
| | | Vehicle Identification Number from: 7H-6-000001 →; for PR number: 2E3 / 2E4; → Vehicle Identification Number to: 7H-A-050000; Fitting Position: Rear Axle | 24.0122-0211.1 422211 | Outer diameter [mm]: 294 Brake Disc Thickness [mm] 21.9 Minimum thickness [mm] 19.5 Brake Disc Type: Vented Supplementary Article/Info 2: with bolts/screws | |
| 2.0 BiTDI | 132 09/09→08/15 | for PR number: 2E3; Fitting Position: Front Axle | 24.0130-0114.1 430114 | Outer diameter [mm]: 308 Brake Disc Thickness [mm] 29.5 Minimum thickness [mm] 25.5 Brake Disc Type: Vented | |
| 2.0 BiTDI 4motion | 132 09/09→08/15 | | | | |
| 2.0 TDI | 62 - 09/09→08/15 103 | Vehicle Identification Number from: 7H-A-200001 →; for PR number: 2E4; Fitting Position: Front Axle | 24.0133-0100.1 433100 | Outer diameter [mm]: 340 Brake Disc Thickness [mm] 32.6 Minimum thickness [mm] 29.5 Brake Disc Type: Vented Supplementary Article/Info 2: with bolts/screws | |
| 2.0 TDI 4motion | 103 09/09→08/15 | | | | |
| | | Vehicle Identification Number from: 7H-A-200001 →; Fitting Position: Rear Axle | 24.0122-0211.1 422211 | Outer diameter [mm]: 294 Brake Disc Thickness [mm] 21.9 Minimum thickness [mm] 19.5 Brake Disc Type: Vented Supplementary Article/Info 2: with bolts/screws | |
| | | Vehicle Identification Number from: 7H-6-000001 →; for PR number: 2E3 / 2E4; → Vehicle Identification Number to: 7H-A-050000; Fitting Position: Rear Axle | 24.0122-0211.1 422211 | Outer diameter [mm]: 294 Brake Disc Thickness [mm] 21.9 Minimum thickness [mm] 19.5 Brake Disc Type: Vented Supplementary Article/Info 2: with bolts/screws | |
| 2.0 TDI | 84 05/11→08/15 | for PR number: 2E3; Fitting Position: Front Axle | 24.0130-0114.1 430114 | Outer diameter [mm]: 308 Brake Disc Thickness [mm] 29.5 Minimum thickness [mm] 25.5 Brake Disc Type: Vented | |
| 2.0 TSI | 110 - 05/11→08/15 150 | | | | |
| 2.0 TSI 4motion | 150 07/11→08/15 | | | | |
| → | | | | | |





| | kW | | | | |
|---|--|---|--------------------------------|---|--|
| VW - TRANSPORTER V Van (7HA, 7HH, 7EA, 7EH) 04/03→ | | | | | |
|  Brake Disc | | | | | |
| 2.0 TDI 2.0 TSI 2.0 TSI 4motion | 84 05/11→08/15 110 - 05/11→08/15 150 150 07/11→08/15 | for PR number: 2E4; Fitting Position: Front Axle | 24.0133-0100.1 433100 | Outer diameter [mm]: 340 Brake Disc Thickness [mm] 32.6 Minimum thickness [mm] 29.5 Brake Disc Type: Vented Supplementary Article/Info 2: with bolts/screws | |
| | | Fitting Position: Rear Axle | 24.0122-0211.1 422211 | Outer diameter [mm]: 294 Brake Disc Thickness [mm] 21.9 Minimum thickness [mm] 19.5 Brake Disc Type: Vented Supplementary Article/Info 2: with bolts/screws | |
| 2.0 TDI 2.0 TDI 4motion | 100 05/10→08/15 100 05/10→08/15 | for PR number: 2E3; Fitting Position: Front Axle | 24.0130-0114.1 430114 | Outer diameter [mm]: 308 Brake Disc Thickness [mm] 29.5 Minimum thickness [mm] 25.5 Brake Disc Type: Vented | |
| | | Vehicle Identification Number from: 7H-A-200001 →; for PR number: 2E4; Fitting Position: Front Axle | 24.0133-0100.1 433100 | Outer diameter [mm]: 340 Brake Disc Thickness [mm] 32.6 Minimum thickness [mm] 29.5 Brake Disc Type: Vented Supplementary Article/Info 2: with bolts/screws | |
| | | Vehicle Identification Number from: 7H-A-200001 →; Fitting Position: Rear Axle | 24.0122-0211.1 422211 | Outer diameter [mm]: 294 Brake Disc Thickness [mm] 21.9 Minimum thickness [mm] 19.5 Brake Disc Type: Vented Supplementary Article/Info 2: with bolts/screws | |
| 3.2 4motion 3.2 V6 4motion | 173 11/03→11/09 170 04/03→06/05 | Construction year from: 07/04 →; for PR number: 2E3; Fitting Position: Front Axle | 24.0130-0114.1 430114 | Outer diameter [mm]: 308 Brake Disc Thickness [mm] 29.5 Minimum thickness [mm] 25.5 Brake Disc Type: Vented | |
| | | Vehicle Identification Number from: 7H-A-200001 →; for PR number: 2E4; Fitting Position: Front Axle | 24.0133-0100.1 433100 | Outer diameter [mm]: 340 Brake Disc Thickness [mm] 32.6 Minimum thickness [mm] 29.5 Brake Disc Type: Vented Supplementary Article/Info 2: with bolts/screws | |
| | | Vehicle Identification Number from: 7H-A-200001 →; Fitting Position: Rear Axle | 24.0122-0211.1 422211 | Outer diameter [mm]: 294 Brake Disc Thickness [mm] 21.9 Minimum thickness [mm] 19.5 Brake Disc Type: Vented Supplementary Article/Info 2: with bolts/screws | |
| | | Construction year from: 07/04 →; for PR number: 0WL / 0WN / 0WM / 0WP / 0WQ; → Vehicle Identification Number to: 7H-5-120000; Fitting Position: Rear Axle | 24.0122-0211.1 422211 | Outer diameter [mm]: 294 Brake Disc Thickness [mm] 21.9 Minimum thickness [mm] 19.5 Brake Disc Type: Vented Supplementary Article/Info 2: with bolts/screws | |
| | | Vehicle Identification Number from: 7H-8-028000 →; for PR number: 0WR; → Vehicle Identification Number to: 7H-8-200000; Fitting Position: Rear Axle | 24.0122-0211.1 422211 | Outer diameter [mm]: 294 Brake Disc Thickness [mm] 21.9 Minimum thickness [mm] 19.5 Brake Disc Type: Vented Supplementary Article/Info 2: with bolts/screws | |
| | | Vehicle Identification Number from: 7H-6-000001 →; for PR number: 2E3 / 2E4; → Vehicle Identification Number to: 7H-A-050000; Fitting Position: Rear Axle | 24.0122-0211.1 422211 | Outer diameter [mm]: 294 Brake Disc Thickness [mm] 21.9 Minimum thickness [mm] 19.5 Brake Disc Type: Vented Supplementary Article/Info 2: with bolts/screws | |
|  Brake Hose | | | | | |
| 1.9 TDI 2.0 2.0 BiFuel 2.0 BiTDI 2.0 BiTDI 4motion 2.0 TDI | 62 - 04/03→11/09 77 85 11/03→08/15 85 05/11→08/15 132 09/09→08/15 132 09/09→08/15 62 - 09/09→08/15 | for PR number: 1BA / 1BB / 1BJ / 1BV / 1MG / 1MK / 1ML / 2MD / 2MF / 2MG / 2ML; Required quantity: 2; Fitting Position: Front Axle | 2 24.5140-0514.3 331290 | Length [mm]: 520 | |
| 2.0 TDI 4motion | 100 - 09/09→08/15 103 | for PR number: 0WR; Required quantity: 2; Fitting Position: Front Axle | 2 83.6113-0552.3 330864 | Length [mm]: 552 | |
| 2.5 TDI 2.5 TDI 4motion | 96 - 04/03→11/09 128 96 - 07/04→11/09 128 | for PR number: 1BH / 1BX / 1MR / 2MQ / 2MZ / 2MU / 2MT; Required quantity: 2; Fitting Position: Front Axle | 2 83.6113-0552.3 330864 | Length [mm]: 552 | |
| → | | | | | |







| | kW | | | | |
|---|------------------------|---|---|---|---|
| VW - TRANSPORTER V Van (7HA, 7HH, 7EA, 7EH) 04/03→ | | | | | |
|  Brake Hose | | | | | |
| 3.2 V6 | 170 | 04/03→11/09 173 | Braking System: for vehicles with brake-power regulator; Required quantity: 2; Fitting Position: at brake caliper / Rear Axle | 2 | 24.5140-0194.3 331383 Length [mm]: 190 |
| | | | for PR number: 0E1 / 0E2 / 0WL / 0WN / 0WM / 0WP / 0WQ; Required quantity: 2; Fitting Position: Rear Axle | 2 | 24.5140-0194.3 331383 Length [mm]: 190 |
| | | | Required quantity: 2; Fitting Position: Rear Axle | 2 | 24.5237-0250.3 330880 Length [mm]: 250 |
| | | | for PR number: 0WR; Required quantity: 2; Fitting Position: Rear Axle | 2 | 24.5237-0250.3 330880 Length [mm]: 250 |
| 2.0 TDI 2.0 TSI 2.0 TSI 4motion | 84 110 - 150 150 | 05/11→08/15 05/11→08/15 07/11→08/15 | for PR number: 1BA / 1BB / 1BJ / 1BV / 1MG / 1MK / 1ML / 2MD / 2MF / 2MG / 2ML; Required quantity: 2; Fitting Position: Front Axle | 2 | 24.5140-0514.3 331290 Length [mm]: 520 |
| | | | for PR number: 1BH / 1BX / 1MR / 2MQ / 2MZ / 2MU / 2MT; Required quantity: 2; Fitting Position: Front Axle | 2 | 83.6113-0552.3 330864 Length [mm]: 552 |
| | | | Required quantity: 2; Fitting Position: Rear Axle | 2 | 24.5140-0194.3 331383 Length [mm]: 190 |
| 3.2 4motion 3.2 V6 4motion | 173 170 | 11/03→11/09 04/03→06/05 | Construction year from: 07/04 →; for PR number: 1BA / 1BB / 1BJ / 1BV / 1MG / 1MK / 1ML / 2MD / 2MF / 2MG / 2ML; Required quantity: 2; Fitting Position: Front Axle | 2 | 24.5140-0514.3 331290 Length [mm]: 520 |
| | | | Construction year from: 07/04 →; for PR number: 0WL / 0WN / 0WM / 0WP / 0WQ; Required quantity: 2; Fitting Position: Front Axle | 2 | 24.5140-0514.3 331290 Length [mm]: 520 |
| | | | Construction year from: 07/04 →; for PR number: 1BH / 1BX / 1MR / 2MQ / 2MZ / 2MU / 2MT; Required quantity: 2; Fitting Position: Front Axle | 2 | 83.6113-0552.3 330864 Length [mm]: 552 |
| | | | Construction year from: 07/04 →; for PR number: 0WR; Required quantity: 2; Fitting Position: Front Axle | 2 | 83.6113-0552.3 330864 Length [mm]: 552 |
| | | | Construction year from: 07/04 →; for PR number: 0E1 / 0E2 / 0WL / 0WN / 0WM / 0WP / 0WQ; Required quantity: 2; Fitting Position: Rear Axle | 2 | 24.5140-0194.3 331383 Length [mm]: 190 |
| | | | Construction year from: 07/04 →; Braking System: for vehicles with brake-power regulator; Required quantity: 2; Fitting Position: at brake caliper / Rear Axle | 2 | 24.5140-0194.3 331383 Length [mm]: 190 |
| | | | Construction year from: 07/04 →; Required quantity: 2; Fitting Position: Rear Axle | 2 | 24.5237-0250.3 330880 Length [mm]: 250 |
| | | | Construction year from: 07/04 →; for PR number: 0WR; Required quantity: 2; Fitting Position: Rear Axle | 2 | 24.5237-0250.3 330880 Length [mm]: 250 |
|  Wheel Speed Sensor | | | | | |
| 1.9 TDI | 62 - 77 | 04/03→11/09 | Fitting Position: Front Axle Left | | 24.0711-5271.3 360301 |
| 2.0 | 85 | 11/03→08/15 | Fitting Position: Front Axle Right | | 24.0711-5272.3 360302 |
| 2.0 BiFuel | 85 | 05/11→08/15 | Fitting Position: Rear Axle Left | | 24.0711-5271.3 360301 |
| 2.0 BiTDI | 132 | 09/09→08/15 | Fitting Position: Rear Axle Right | | 24.0711-5272.3 360302 |
| 2.0 BiTDI 4motion | 132 | 09/09→08/15 | | | |
| 2.0 TDI | 62 - 103 | 09/09→08/15 | | | |
| 2.0 TDI 4motion | 100 - 103 | 09/09→08/15 | | | |
| 2.0 TSI | 110 - 150 | 05/11→08/15 | | | |
| 2.0 TSI 4motion | 150 | 07/11→08/15 | | | |
| 2.5 TDI | 96 - 128 | 04/03→11/09 | | | |
| 2.5 TDI 4motion | 96 - 128 | 07/04→11/09 | | | |
| 3.2 V6 | 170 - 173 | 04/03→11/09 | | | |
| 3.2 4motion | 173 | 11/03→11/09 | Construction year from: 07/04 →; Fitting Position: Front Axle Left | | 24.0711-5271.3 360301 |
| 3.2 V6 4motion | 170 | 04/03→06/05 | Construction year from: 07/04 →; Fitting Position: Front Axle Right | | 24.0711-5272.3 360302 |
| → | | | | | |



| | kW | | | | | |
|--|-----|-------------|--|----------------|-----------------------|--|
| VW - TRANSPORTER V Van (7HA, 7HH, 7EA, 7EH) 04/03→ | | | | | | |
|  Wheel Speed Sensor | | | | | | |
| 3.2 4motion | 173 | 11/03→11/09 | Construction year from: 07/04 →; Fitting Position: Rear Axle Left | 24.0711-5271.3 | 360301 | |
| 3.2 V6 4motion | 170 | 04/03→06/05 | | | | |
| | | | Construction year from: 07/04 →; Fitting Position: Rear Axle Right | 24.0711-5272.3 | 360302 | |
|  Cable Pull, parking brake | | | | | | |
| 1.9 TDI | 62 | 04/03→11/09 | for PR number: 0E1 / 0E2 / 0WL / 0WN / 0WM / 0WP / 0WQ; Required quantity: 2; Brake Type: Disc Brake; Fitting Position: Rear | 2 | 24.3727-0184.2 580184 | Length [mm]: 1,303 |
| 2.0 | 85 | 11/03→08/15 | | | | |
| 2.0 BiFuel | 85 | 05/11→08/15 | Vehicle Identification Number from: 7H-7-000001 →; for PR number: 0WR / 0E1; Required quantity: 2; Fitting Position: Rear | 2 | 24.3727-3409.2 583409 | Length [mm]: 1,570 |
| 2.0 BiTDI | 132 | 09/09→08/15 | | | | |
| 2.0 TDI | 62 | 09/09→08/15 | Vehicle Identification Number from: 7H-A-200001 →; Brake Type: Disc Brake; for PR number: G0C / G0K / G1C; Required quantity: 2; Fitting Position: Rear | 2 | 24.3727-0184.2 580184 | Length [mm]: 1,303 |
| 2.5 TDI | 96 | 04/03→11/09 | | | | |
| 3.2 V6 | 170 | 04/03→11/09 | Vehicle Identification Number from: 7H-7-000001 →; for PR number: 0WR / 0E1; Required quantity: 2; Fitting Position: Rear | 2 | 24.3727-3409.2 583409 | Length [mm]: 1,570 |
| | 128 | 09/09→08/15 | | | | |
| 2.0 BiTDI 4motion | 132 | 09/09→08/15 | Vehicle Identification Number from: 7H-A-200001 →; Brake Type: Disc Brake; for PR number: G0C / G0K / G1C; Required quantity: 2; Fitting Position: Rear | 2 | 24.3727-0184.2 580184 | Length [mm]: 1,303 |
| 2.0 TDI 4motion | 100 | 09/09→08/15 | | | | |
| 2.5 TDI 4motion | 96 | 07/04→11/09 | Vehicle Identification Number from: 7H-7-000001 →; for PR number: 0WR / 0E1; Required quantity: 2; Fitting Position: Rear | 2 | 24.3727-3409.2 583409 | Length [mm]: 1,570 |
| 3.2 4motion | 173 | 11/03→11/09 | | | | |
| 3.2 V6 4motion | 170 | 04/03→06/05 | Brake Type: Disc Brake; for PR number: G0C / G0K / G1C; Required quantity: 2; Fitting Position: Rear | 2 | 24.3727-0184.2 580184 | Length [mm]: 1,303 |
| 2.0 TDI | 84 | 05/11→08/15 | | | | |
| 2.0 TSI | 110 | 05/11→08/15 | Brake Type: Disc Brake; for PR number: G0C / G0K / G1C; Required quantity: 2; Fitting Position: Rear | 2 | 24.3727-0184.2 580184 | Length [mm]: 1,303 |
| 2.0 TSI 4motion | 150 | 07/11→08/15 | | | | |
| VW - TRANSPORTER VI / CARAVELLE VI Bus (SGB, SGJ, SHB, SHJ) 04/15→ | | | | | | |
|  Brake Caliper | | | | | | |
| 2.0 TDI | 62 | 04/15→ | Rim Size [in]: 17; Fitting Position: Front Axle Left | 24.3441-9933.5 | 241141 | Brake System: ATE Supplementary Article/Supplementary Info: without holder Brake Caliper Type: Fist-type Caliper (2 pistons) |
| 2.0 TDI 4motion | 150 | 06/15→ | | | | |
| 2.0 TSI | 110 | 04/15→07/19 | Rim Size [in]: 17; Fitting Position: Front Axle Right | 24.3441-9934.5 | 241142 | Brake System: ATE Supplementary Article/Supplementary Info: without holder Brake Caliper Type: Fist-type Caliper (2 pistons) |
| 2.0 TSI 4motion | 150 | 06/15→07/19 | | | | |
| ABT e-Caravelle | 83 | 01/20→ | Rim Size [in]: 16; Fitting Position: Front Axle Left | 24.3601-9947.5 | 240597 | Brake System: ATE Supplementary Article/Supplementary Info: without holder Brake Caliper Type: Fist-type Caliper |
| | | | | | | |
| | | | Rim Size [in]: 16; Fitting Position: Front Axle Right | 24.3601-9948.5 | 240598 | Brake System: ATE Supplementary Article/Supplementary Info: without holder Brake Caliper Type: Fist-type Caliper |
| | | | | | | |
| | | | Fitting Position: Rear Axle Left | 24.3414-1711.5 | 240852 | Brake System: Lucas / TRW Supplementary Article/Supplementary Info: without holder Brake Caliper Type: Fist-type Caliper |
| | | | Fitting Position: Rear Axle Right | 24.3414-1712.5 | 240853 | Brake System: Lucas / TRW Supplementary Article/Supplementary Info: without holder Brake Caliper Type: Fist-type Caliper |
| Spring, brake caliper | | | | | | |
| 2.0 TDI | 62 | 04/15→ | Rim Size [in]: 17; Required quantity: 2 | 2 | 11.8116-0126.2 390608 | Brake System: ATE |
| 2.0 TDI 4motion | 150 | 06/15→ | Rim Size [in]: 16; Required quantity: 2 | 2 | 11.8116-0237.1 390509 | Brake System: ATE |
| 2.0 TSI | 110 | 04/15→07/19 | | | | |
| 2.0 TSI 4motion | 150 | 06/15→07/19 | | | | |
| 2.0 TDI | 66 | 11/18→ | Rim Size [in]: 17; Required quantity: 2; Fitting Position: Front Axle | 2 | 11.8116-0126.2 390608 | Brake System: ATE |
| ABT e-Caravelle | 146 | 01/20→ | Rim Size [in]: 16; Required quantity: 2; Fitting Position: Front Axle | 2 | 11.8116-0237.1 390509 | Brake System: ATE |
| → | | | | | | |

| | kW | | | | |
|--|--------------------------|---|--------------------------------|---|--|
| VW - TRANSPORTER VI / CARAVELLE VI Bus (SGB, SGJ, SHB, SHJ) 04/15→ | | | | | |
|  Brake Pad Set, disc brake | | | | | |
| 2.0 TDI | 62 - 04/15→ 150 | Rim Size [in]: 16; Fitting Position: Front Axle | 13.0460-7236.2 607236 | Brake System: ATE 23746 19,7 Wear Warning Contact: incl. wear warning contact | |
| 2.0 TDI 4motion | 103 - 06/15→ 150 | | | | |
| 2.0 TSI | 110 - 04/15→07/19 150 | Rim Size [in]: 17; Fitting Position: Front Axle | 13.0460-7286.2 607286 | Brake System: ATE 24623 18,2 Wear Warning Contact: incl. wear warning contact | |
| 2.0 TSI 4motion | 150 06/15→07/19 | | | | |
| ABT e-Caravelle | 83 01/20→ | Fitting Position: Rear Axle | 13.0460-2882.2 602882 | Brake System: Lucas / TRW 23326 17,4 Wear Warning Contact: incl. wear warning contact Supplementary Article/Supplementary Info: with accessories | |
|  Brake Disc | | | | | |
| 2.0 TDI | 62 - 04/15→ 150 | Rim Size [in]: 16; Fitting Position: Front Axle | 24.0130-0114.1 430114 | Outer diameter [mm]: 308 Brake Disc Thickness [mm] 29.5 Minimum thickness [mm] 25.5 Brake Disc Type: Vented | |
| 2.0 TDI 4motion | 103 - 06/15→ 150 | | | | |
| 2.0 TSI | 110 - 04/15→07/19 150 | Rim Size [in]: 17; Fitting Position: Front Axle | 24.0133-0100.1 433100 | Outer diameter [mm]: 340 Brake Disc Thickness [mm] 32.6 Minimum thickness [mm] 29.5 Brake Disc Type: Vented Supplementary Article/Info 2: with bolts/screws | |
| 2.0 TSI 4motion | 150 06/15→07/19 | | | | |
| ABT e-Caravelle | 83 01/20→ | Fitting Position: Rear Axle | 24.0122-0211.1 422211 | Outer diameter [mm]: 294 Brake Disc Thickness [mm] 21.9 Minimum thickness [mm] 19.5 Brake Disc Type: Vented Supplementary Article/Info 2: with bolts/screws | |
|  Brake Hose | | | | | |
| 2.0 TDI | 62 - 04/15→ 150 | Required quantity: 2; Shock Absorber System: Increased shock absorption; for PR number: 1BA / 1BB / 1BC / 1BJ / 1BL / 1BV / 2MD / 2MF / 2MG / 2MH / 2MK / 2ML; Fitting Position: Front Axle | 2 24.5140-0514.3 331290 | Length [mm]: 520 | |
| 2.0 TDI 4motion | 103 - 06/15→ 150 | | | | |
| 2.0 TSI | 110 - 04/15→07/19 150 | | | | |
| 2.0 TSI 4motion | 150 06/15→07/19 | Required quantity: 2; Shock Absorber System: Normal Suspension; for PR number: 1BH / 1BX / 2MQ / 2MR / 2MT / 2MU; Fitting Position: Front Axle | 2 83.6113-0552.3 330864 | Length [mm]: 552 | |
| ABT e-Caravelle | 83 01/20→ | Required quantity: 2; Fitting Position: Rear Axle | 2 24.5237-0250.3 330880 | Length [mm]: 250 | |
|  Wheel Speed Sensor | | | | | |
| 2.0 TDI | 62 - 04/15→ 150 | Fitting Position: Front Axle Left | 24.0711-5271.3 360301 | | |
| 2.0 TDI 4motion | 103 - 06/15→ 150 | Fitting Position: Front Axle Right | 24.0711-5272.3 360302 | | |
| 2.0 TSI | 110 - 04/15→07/19 150 | Fitting Position: Rear Axle Left | 24.0711-5271.3 360301 | | |
| 2.0 TSI 4motion | 150 06/15→07/19 | Fitting Position: Rear Axle Right | 24.0711-5272.3 360302 | | |
| ABT e-Caravelle | 83 01/20→ | | | | |
|  Cable Pull, parking brake | | | | | |
| 2.0 TDI | 62 - 04/15→ 150 | Required quantity: 2; for PR number: G0C / G0K / G1C; Brake Type: Disc Brake; Fitting Position: Rear | 2 24.3727-0184.2 580184 | Length [mm]: 1,303 | |
| 2.0 TDI 4motion | 103 - 06/15→ 150 | | | | |
| 2.0 TSI | 110 - 04/15→07/19 150 | | | | |
| 2.0 TSI 4motion | 150 06/15→07/19 | | | | |
| ABT e-Caravelle | 83 01/20→ | | | | |
| VW - TRANSPORTER VI Platform/Chassis (SFD, SFE, SFL, SFZ, SJD, SJ 04/15→ | | | | | |
|  Brake Caliper | | | | | |
| 2.0 TDI | 62 - 04/15→ 150 | Rim Size [in]: 17; Fitting Position: Front Axle Left | 24.3441-9933.5 241141 | Brake System: ATE Supplementary Article/Supplementary Info: without holder Brake Caliper Type: Fist-type Caliper (2 pistons) | |
| 2.0 TDI 4motion | 103 - 06/15→ 150 | | | | |
| 2.0 TSI | 110 04/15→06/19 | | | | |
| → | | | | | |

| | kW | | | | |
|--|---------------------|---|--------------------------------|---|--|
| VW - TRANSPORTER VI Platform/Chassis (SFD, SFE, SFL, SFZ, SJD, SJ 04/15→) | | | | | |
|  Brake Caliper | | | | | |
| 2.0 TDI | 62 - 04/15→ 150 | Rim Size [in]: 17; Fitting Position: Front Axle Right | 24.3441-9934.5 241142 | Brake System: ATE Supplementary Article/Supplementary Info: without holder Brake Caliper Type: Fist-type Caliper (2 pistons) | |
| 2.0 TDI 4motion | 103 - 06/15→ 150 | Rim Size [in]: 16; Fitting Position: Front Axle Left | 24.3601-9947.5 240597 | Brake System: ATE Supplementary Article/Supplementary Info: without holder Brake Caliper Type: Fist-type Caliper | |
| 2.0 TSI | 110 04/15→06/19 | Rim Size [in]: 16; Fitting Position: Front Axle Right | 24.3601-9948.5 240598 | Brake System: ATE Supplementary Article/Supplementary Info: without holder Brake Caliper Type: Fist-type Caliper | |
| | | Fitting Position: Rear Axle Left | 24.3414-1711.5 240852 | Brake System: Lucas / TRW Supplementary Article/Supplementary Info: without holder Brake Caliper Type: Fist-type Caliper | |
| | | Fitting Position: Rear Axle Right | 24.3414-1712.5 240853 | Brake System: Lucas / TRW Supplementary Article/Supplementary Info: without holder Brake Caliper Type: Fist-type Caliper | |
| Spring, brake caliper | | | | | |
| 2.0 TDI | 62 - 04/15→ 150 | Rim Size [in]: 17; Required quantity: 2 | 2 11.8116-0126.2 390608 | Brake System: ATE | |
| 2.0 TDI 4motion | 103 - 06/15→ 150 | Rim Size [in]: 16; Required quantity: 2 | 2 11.8116-0237.1 390509 | Brake System: ATE | |
| 2.0 TSI | 110 04/15→06/19 | | | | |
| 2.0 TDI | 66 - 05/16→ 146 | Rim Size [in]: 17; Required quantity: 2; Fitting Position: Front Axle | 2 11.8116-0126.2 390608 | Brake System: ATE | |
| 2.0 TDI 4motion | 146 08/19→ | Rim Size [in]: 16; Required quantity: 2; Fitting Position: Front Axle | 2 11.8116-0237.1 390509 | Brake System: ATE | |
|  Brake Pad Set, disc brake | | | | | |
| 2.0 TDI | 62 - 04/15→ 150 | Rim Size [in]: 16; Fitting Position: Front Axle | 13.0460-7236.2 607236 | Brake System: ATE 23746 19,7 Wear Warning Contact: incl. wear warning contact | |
| 2.0 TDI 4motion | 103 - 06/15→ 150 | Rim Size [in]: 17; Fitting Position: Front Axle | 13.0460-7286.2 607286 | Brake System: ATE 24623 18,2 Wear Warning Contact: incl. wear warning contact | |
| 2.0 TSI | 110 04/15→06/19 | Fitting Position: Rear Axle | 13.0460-2882.2 602882 | Brake System: Lucas / TRW 23326 17,4 Wear Warning Contact: incl. wear warning contact Supplementary Article/Supplementary Info: with accessories | |
|  Brake Disc | | | | | |
| 2.0 TDI | 62 - 04/15→ 150 | Rim Size [in]: 16; Fitting Position: Front Axle | 24.0130-0114.1 430114 | Outer diameter [mm]: 308 Brake Disc Thickness [mm] 29.5 Minimum thickness [mm] 25.5 Brake Disc Type: Vented | |
| 2.0 TDI 4motion | 103 - 06/15→ 150 | Rim Size [in]: 17; Fitting Position: Front Axle | 24.0133-0100.1 433100 | Outer diameter [mm]: 340 Brake Disc Thickness [mm] 32.6 Minimum thickness [mm] 29.5 Brake Disc Type: Vented Supplementary Article/Info 2: with bolts/screws | |
| 2.0 TSI | 110 04/15→06/19 | Fitting Position: Rear Axle | 24.0122-0211.1 422211 | Outer diameter [mm]: 294 Brake Disc Thickness [mm] 21.9 Minimum thickness [mm] 19.5 Brake Disc Type: Vented Supplementary Article/Info 2: with bolts/screws | |
|  Brake Hose | | | | | |
| 2.0 TDI | 62 - 04/15→ 150 | Required quantity: 2; Shock Absorber System: Increased shock absorption; for PR number: 1BA / 1BB / 1BC / 1BJ / 1BL / 1BV / 2MD / 2MF / 2MG / 2MH / 2MK / 2ML; Fitting Position: Front Axle | 2 24.5140-0514.3 331290 | Length [mm]: 520 | |
| 2.0 TDI 4motion | 103 - 06/15→ 150 | | | | |
| 2.0 TSI | 110 04/15→06/19 | | | | |
| → | | | | | |

| | kW | | | | |
|--|--------------------------|--|---|------------------------------|--|
| VW - TRANSPORTER VI Platform/Chassis (SFD, SFE, SFL, SFZ, SJD, SJ 04/15→ | | | | | |
|  Brake Hose | | | | | |
| 2.0 TDI | 62 - 04/15→ 150 | Required quantity: 2; Shock Absorber System: Normal | 2 | 83.6113-0552.3 330864 | Length [mm]: 552 |
| 2.0 TDI 4motion | 103 - 06/15→ 150 | Suspension; for PR number: 1BH / 1BX / 2MQ / 2MR / | | | |
| 2.0 TSI | 110 04/15→06/19 | 2MT / 2MU; Fitting Position: Front Axle | | | |
| | | Required quantity: 2; Fitting Position: Rear Axle | 2 | 24.5237-0250.3 330880 | Length [mm]: 250 |
|  Wheel Speed Sensor | | | | | |
| 2.0 TDI | 62 - 04/15→ 150 | Fitting Position: Front Axle Left | | 24.0711-5271.3 360301 | |
| 2.0 TDI 4motion | 103 - 06/15→ 150 | Fitting Position: Front Axle Right | | 24.0711-5272.3 360302 | |
| 2.0 TSI | 110 04/15→06/19 | Fitting Position: Rear Axle Left | | 24.0711-5271.3 360301 | |
| | | Fitting Position: Rear Axle Right | | 24.0711-5272.3 360302 | |
|  Cable Pull, parking brake | | | | | |
| 2.0 TDI | 62 - 04/15→ 150 | Required quantity: 2; for PR number: G0C / G0K / G1C; | 2 | 24.3727-0184.2 580184 | Length [mm]: 1,303 |
| 2.0 TDI 4motion | 103 - 06/15→ 150 | Brake Type: Disc Brake; | | | |
| 2.0 TSI | 110 04/15→06/19 | Fitting Position: Rear | | | |
| VW - TRANSPORTER VI Van (SGA, SGH, SHA, SHH) 04/15→ | | | | | |
|  Brake Caliper | | | | | |
| 2.0 TDI | 62 - 04/15→ 150 | Rim Size [in]: 17; Fitting Position: Front Axle Left | | 24.3441-9933.5 241141 | Brake System: ATE Supplementary Article/Supplementary Info: without holder Brake Caliper Type: Fist-type Caliper (2 pistons) |
| 2.0 TDI 4motion | 103 - 06/15→ 150 | | | | |
| 2.0 TSI | 110 - 04/15→07/19 150 | | | | |
| 2.0 TSI 4motion | 150 06/15→07/19 | Rim Size [in]: 17; Fitting Position: Front Axle Right | | 24.3441-9934.5 241142 | Brake System: ATE Supplementary Article/Supplementary Info: without holder Brake Caliper Type: Fist-type Caliper (2 pistons) |
| ABT e-Transporter | 83 01/20→ | | | | |
| | | Rim Size [in]: 16; Fitting Position: Front Axle Left | | 24.3601-9947.5 240597 | Brake System: ATE Supplementary Article/Supplementary Info: without holder Brake Caliper Type: Fist-type Caliper |
| | | Rim Size [in]: 16; Fitting Position: Front Axle Right | | 24.3601-9948.5 240598 | Brake System: ATE Supplementary Article/Supplementary Info: without holder Brake Caliper Type: Fist-type Caliper |
| | | Fitting Position: Rear Axle Left | | 24.3414-1711.5 240852 | Brake System: Lucas / TRW Supplementary Article/Supplementary Info: without holder Brake Caliper Type: Fist-type Caliper |
| | | Fitting Position: Rear Axle Right | | 24.3414-1712.5 240853 | Brake System: Lucas / TRW Supplementary Article/Supplementary Info: without holder Brake Caliper Type: Fist-type Caliper |
| Spring, brake caliper | | | | | |
| 2.0 TDI | 62 - 04/15→ 150 | Rim Size [in]: 17; Required quantity: 2 | 2 | 11.8116-0126.2 390608 | Brake System: ATE |
| 2.0 TDI 4motion | 103 - 06/15→ 150 | Rim Size [in]: 16; Required quantity: 2 | 2 | 11.8116-0237.1 390509 | Brake System: ATE |
| 2.0 TSI | 110 - 04/15→07/19 150 | | | | |
| 2.0 TSI 4motion | 150 06/15→07/19 | | | | |
| 2.0 TDI | 66 - 08/18→ 146 | Rim Size [in]: 17; Required quantity: 2; Fitting Position: Front Axle | 2 | 11.8116-0126.2 390608 | Brake System: ATE |
| 2.0 TDI 4motion | 146 08/18→ | | | | |
| ABT e-Transporter | 83 01/20→ | Rim Size [in]: 16; Required quantity: 2; Fitting Position: Front Axle | 2 | 11.8116-0237.1 390509 | Brake System: ATE |
|  Brake Pad Set, disc brake | | | | | |
| 2.0 TDI | 62 - 04/15→ 150 | Rim Size [in]: 16; Fitting Position: Front Axle | | 13.0460-7236.2 607236 | Brake System: ATE 23746 19,7 Wear Warning Contact: incl. wear warning contact |
| 2.0 TDI 4motion | 103 - 06/15→ 150 | | | | |
| 2.0 TSI | 110 - 04/15→07/19 150 | Rim Size [in]: 17; Fitting Position: Front Axle | | 13.0460-7286.2 607286 | Brake System: ATE 24623 18,2 Wear Warning Contact: incl. wear warning contact |
| 2.0 TSI 4motion | 150 06/15→07/19 | | | | |
| ABT e-Transporter | 83 01/20→ | | | | |

| | kW | | | | |
|--|--------------------------|---|------------------------------|---|--------------------|
| VW - TRANSPORTER VI Van (SGA, SGH, SHA, SHH) 04/15→ | | | | | |
|  Brake Pad Set, disc brake | | | | | |
| 2.0 TDI | 62 - 04/15→ 150 | Fitting Position: Rear Axle | 13.0460-2882.2 602882 | Brake System: Lucas / TRW 23326 17,4 Wear Warning Contact: incl. wear warning contact Supplementary Article/Supplementary Info: with accessories | |
| 2.0 TDI 4motion | 103 - 06/15→ 150 | | | | |
| 2.0 TSI | 110 - 04/15→07/19 150 | | | | |
| 2.0 TSI 4motion | 150 06/15→07/19 | | | | |
| ABT e-Transporter | 83 01/20→ | | | | |
|  Brake Disc | | | | | |
| 2.0 TDI | 62 - 04/15→ 150 | Rim Size [in]: 16; Fitting Position: Front Axle | 24.0130-0114.1 430114 | Outer diameter [mm]: 308 Brake Disc Thickness [mm] 29.5 Minimum thickness [mm] 25.5 Brake Disc Type: Vented | |
| 2.0 TDI 4motion | 103 - 06/15→ 150 | | | | |
| 2.0 TSI | 110 - 04/15→07/19 150 | Rim Size [in]: 17; Fitting Position: Front Axle | 24.0133-0100.1 433100 | Outer diameter [mm]: 340 Brake Disc Thickness [mm] 32.6 Minimum thickness [mm] 29.5 Brake Disc Type: Vented Supplementary Article/Info 2: with bolts/screws | |
| 2.0 TSI 4motion | 150 06/15→07/19 | | | | |
| ABT e-Transporter | 83 01/20→ | | | | |
| | | Fitting Position: Rear Axle | 24.0122-0211.1 422211 | Outer diameter [mm]: 294 Brake Disc Thickness [mm] 21.9 Minimum thickness [mm] 19.5 Brake Disc Type: Vented Supplementary Article/Info 2: with bolts/screws | |
|  Brake Hose | | | | | |
| 2.0 TDI | 62 - 04/15→ 150 | Required quantity: 2; Shock Absorber System: Increased shock absorption; for PR number: 1BA / 1BB / 1BC / 1BJ / 1BL / 1BV / 2MD / 2MF / 2MG / 2MH / 2MK / 2ML; Fitting Position: Front Axle | 2 | 24.5140-0514.3 331290 | Length [mm]: 520 |
| 2.0 TDI 4motion | 103 - 06/15→ 150 | | | | |
| 2.0 TSI | 110 - 04/15→07/19 150 | | | | |
| 2.0 TSI 4motion | 150 06/15→07/19 | Required quantity: 2; Shock Absorber System: Normal Suspension; for PR number: 1BH / 1BX / 2MQ / 2MR / 2MT / 2MU; Fitting Position: Front Axle | 2 | 83.6113-0552.3 330864 | Length [mm]: 552 |
| ABT e-Transporter | 83 01/20→ | | | | |
| | | Required quantity: 2; Fitting Position: Rear Axle | 2 | 24.5237-0250.3 330880 | Length [mm]: 250 |
|  Wheel Speed Sensor | | | | | |
| 2.0 TDI | 62 - 04/15→ 150 | Fitting Position: Front Axle Left | 24.0711-5271.3 360301 | | |
| 2.0 TDI 4motion | 103 - 06/15→ 150 | Fitting Position: Front Axle Right | 24.0711-5272.3 360302 | | |
| 2.0 TSI | 110 - 04/15→07/19 150 | Fitting Position: Rear Axle Left | 24.0711-5271.3 360301 | | |
| 2.0 TSI 4motion | 150 06/15→07/19 | Fitting Position: Rear Axle Right | 24.0711-5272.3 360302 | | |
| ABT e-Transporter | 83 01/20→ | | | | |
|  Cable Pull, parking brake | | | | | |
| 2.0 TDI | 62 - 04/15→ 150 | Required quantity: 2; for PR number: G0C / G0K / G1C; Brake Type: Disc Brake; Fitting Position: Rear | 2 | 24.3727-0184.2 580184 | Length [mm]: 1,303 |
| 2.0 TDI 4motion | 103 - 06/15→ 150 | | | | |
| 2.0 TSI | 110 - 04/15→07/19 150 | | | | |
| 2.0 TSI 4motion | 150 06/15→07/19 | | | | |
| ABT e-Transporter | 83 01/20→ | | | | |
| VW - T-ROC (A11, D11) 07/17→ | | | | | |
|  Brake Pad Set, disc brake | | | | | |
| 1.0 TSI | 81 - 07/17→ 85 | for PR number: 1ZA / 1ZB / 1ZE / 1ZJ / 1ZQ / 1ZK / 1ZL / 1ZU; Fitting Position: Front Axle | 13.0470-2785.2 LD2785 | Brake System: Lucas / TRW 25683 20,4 Wear Warning Contact: prepared for wear indicator / incl. wear warning contact Ceramic | |
| 1.5 TSI | 110 11/17→ | | | | |
| 1.5 TSI 4motion | 110 05/18→11/19 | | | | |
| 1.6 TDI | 85 03/18→06/21 | | | | |
| 2.0 R 4motion | 221 09/19→ | | | | |
| 2.0 TDI | 110 03/18→ | | | | |
| 2.0 TDI 4motion | 110 - 09/17→ 140 | | | | |
| 2.0 TDI SCR | 85 11/20→ | | | | |
| 2.0 TSI 4motion | 140 07/17→ | | | | |

| | | | | | |
|--|-------------------|--|----------------------------------|------------------------------|---|
| | kW | | | | |
| VW - T-ROC Convertible (AC7, AC8) 12/19→ | | | | | |
|  Brake Pad Set, disc brake | | | | | |
| 1.0 TSI | 81 - 12/19→ | | for PR number: 1ZJ / 1ZK; | 13.0470-2785.2 LD2785 | Brake System: Lucas / TRW 25683 20,4 Wear Warning Contact: prepared for wear indicator / incl. wear warning contact Ceramic |
| 1.5 TSI | 85 110 12/19→ | | Fitting Position: Front Axle | | |
| VW - UP! (121, 122, BL1, BL2, BL3, 123) 08/11→ | | | | | |
|  Brake Pad Set, disc brake | | | | | |
| 1.0 | 44 - 08/11→08/20 | | for PR number: 1ZE; | 13.0470-2785.2 LD2785 | Brake System: Lucas / TRW 25683 20,4 Wear Warning Contact: prepared for wear indicator / incl. wear warning contact Ceramic |
| 1.0 EcoFuel | 55 50 11/12→ | | Construction year from: 05/16 →; | | |
| e-Up | 60 - 07/13→ 61 | | Fitting Position: Front Axle | | |
| 1.0 | 48 08/20→ | | for PR number: 1ZE; | 13.0470-2785.2 LD2785 | Brake System: Lucas / TRW 25683 20,4 Wear Warning Contact: prepared for wear indicator / incl. wear warning contact Ceramic |
| 1.0 GTI | 85 11/17→ | | Fitting Position: Front Axle | | |
| 1.0 TSI | 66 05/16→09/18 | | | | |



- EN** Technical translations
- DE** Technische Übersetzungen
- ES** Traducciones técnicas
- FR** Traductions techniques
- IT** Traduzioni tecniche

07/2022

Technical translations

Technische Übersetzungen - Traducciones tecnicas - Traductions techniques - Traduzioni tecniche

| EN | | EN | |
|---|--|---|--|
|  | Brake Hose | Brake Disc Thickness [mm] | Brake Disc Thickness [mm] |
|  | Cable Pull, parking brake | Brake Disc Type | Brake Disc Type |
|  | Brake Caliper | Brake Size | Brake Size |
|  | Brake Pad Set, disc brake | Brake System | Brake System |
|  | Brake Disc | Brake Type | Brake Type |
|  | Wheel Speed Sensor | Braking System | Braking System |
| + ESP | for vehicles with ESP | CB compatible package | CB compatible package |
| 14" | 14" | Centering Diameter [mm] | Centering Diameter [mm] |
| 17" | 17" | Coated | Coated |
| 5-Speed Manual Transmission | 5-Speed Manual Transmission | Comfort Package | Comfort Package |
| 6-Speed Manual Transmission | 6-Speed Manual Transmission | Construction year from → | Construction year from |
| 7-Speed Automatic Transmission | 7-Speed Automatic Transmission | Country specific article information | Country specific article information |
| Alloyed / High-carbon | Alloyed / High-carbon | Country specific package and status data | Country specific package and status data |
| at brake caliper | at brake caliper | Czech Republic | Czech Republic |
| ATE Ceramic | additional article information, ATE Ceramic | Disc Brake | Disc Brake |
| Black | Black | Drum Brake | Drum Brake |
| Bolt Hole Circle Ø [mm] | Bolt Hole Circle Ø [mm] | - ESP | for vehicles without ESP |
| Bore Ø [mm] | Bore Ø [mm] | excl. wear warning contact | excl. wear warning contact |
| Brake Caliper Colour | Brake Caliper Colour | External Thread [mm] | External Thread [mm] |
| Brake Caliper Type | Brake Caliper Type | Fist-type Caliper | Fist-type Caliper |
| Brake caliper with adjusting element for electr. hand-brake | Brake caliper with adjusting element for electr. handbrake | Fist-type Caliper (2 pistons) | Fist-type Caliper (2 pistons) |
| | | Fitting Position | Fitting Position |

Technical translations

Technische Übersetzungen - Traducciones técnicas - Traductions techniques - Traduzioni tecniche

| EN | | EN | |
|---|--|--|---|
| Flange Hole Diameter [mm] | Flange Hole Diameter [mm] | for vehicles without AMG sports package | for vehicles without AMG sports package |
| for brake disc diameter [mm] | for brake disc diameter [mm] | for vehicles without autom. distance control | for vehicles without autom. distance control |
| for extended wheelbase | for extended wheelbase | for vehicles without electric parking brake | for vehicles without electric parking brake |
| for individual equipment ID | for individual equipment ID | for vehicles without fold-down hand-brake lever | for vehicles without fold-down hand-brake lever |
| for POC | for POC | for vehicles without increased ground clearance | for vehicles without increased ground clearance |
| for PR number | for PR number | for vehicles without parking assistant system | for vehicles without parking assistant system |
| for RPO number (vehicle manufacturing date) from → | for RPO number (vehicle manufacturing date) from | for vehicles without sports brake system | for vehicles without sports brake system |
| for vehicles with Airmatic DC | for vehicles with Airmatic DC | for vehicles without sports suspension | for vehicles without sports suspension |
| for vehicles with AMG Sports Package | for vehicles with AMG Sports Package | for vehicles with sports package | for vehicles with sports package |
| for vehicles with brake-power regulator | for vehicles with brake-power regulator | Front | Front |
| for vehicles with electric parking brake | for vehicles with electric parking brake | Front Axle | Front Axle |
| for vehicles with electronic suspension control | for vehicles with electronic suspension control | Front Axle Left | Front Axle Left |
| for vehicles with increased ground clearance | for vehicles with increased ground clearance | Front Axle Right | Front Axle Right |
| for vehicles without Airmatic DC | for vehicles without Airmatic DC | Grey | Grey |
| | | Gross vehicle weight [kg] | Gross vehicle weight [kg] |
| | | Height [mm] | Height [mm] |

Technical translations

Technische Übersetzungen - Traducciones tecnicas - Traductions techniques - Traduzioni tecniche

| EN | | EN | |
|--------------------------------------|-------------------------------|---|--|
| Height 1 [mm] | Height 1 [mm] | not for government vehicles | not for government vehicles |
| Height 2 [mm] | Height 2 [mm] | not for SA code | not for SA code |
| High-carbon | High-carbon | not prepared for wear indicator | not prepared for wear indicator |
| incl. wear warning contact | incl. wear warning contact | Number of bolts/screws | Number of bolts/screws |
| Increased shock absorption | Increased shock absorption | Number of Doors | Number of Doors |
| Inner diameter [mm] | Inner diameter [mm] | Number of Holes | Number of Holes |
| Internal Thread [mm] | Internal Thread [mm] | Number of wear indicators [per axle] | Number of wear indicators [per axle] |
| Internal Thread 1 [mm] | Internal Thread 1 [mm] | Observe dimensions | Observe dimensions |
| Internal Thread 2 [mm] | Internal Thread 2 [mm] | Outer diameter [mm] | Outer diameter [mm] |
| Japan | Japan | Overall Length [mm] | Overall Length [mm] |
| Length [mm] | Length [mm] | Paired article numbers | Paired article numbers |
| Length 1 [mm] | Length 1 [mm] | Part number of recommended accessories | Part number of recommended accessories |
| Length 2 [mm] | Length 2 [mm] | Piston Diameter [mm] | Piston Diameter [mm] |
| Machining | Machining | prepared for wear indicator | prepared for wear indicator |
| Manual Transmission | Manual Transmission | Produkttyp vorhanden | Produkttyp vorhanden |
| MAPP code available | MAPP code available | Reached Quality Gates | Reached Quality Gates |
| Minimum thickness [mm] | Minimum thickness [mm] | Rear | Rear |
| Normal Suspension | Normal Suspension | Rear Axle | Rear Axle |
| not for brake caliper colour | not for brake caliper colour | Rear Axle Left | Rear Axle Left |
| not for cruise control system | not for cruise control system | Rear Axle Right | Rear Axle Right |
| not for extended wheelbase | not for extended wheelbase | | |

Technical translations

Technische Übersetzungen - Traducciones tecnicas - Traductions techniques - Traduzioni tecniche

| EN | | EN | |
|--|--|---|------------------------------------|
| replacement part | replacement part | Vehicle Equipment | Vehicle Equipment |
| Required quantity | Required quantity | Vehicle Identification Number from | Vehicle Identification Number from |
| Right Rear | Right Rear | → | |
| Rim Size [in] | Rim Size [in] | Vehicle Production Country | Vehicle Production Country |
| Service exchange part | Service exchange part | Warning Contact Length [mm] | Warning Contact Length [mm] |
| Shock Absorber System | Shock Absorber System | Wear Warning Contact | Wear Warning Contact |
| Slovakia | Slovakia | Wheelbase | Wheelbase |
| Solid | Solid | Wheelbase [mm] | Wheelbase [mm] |
| Spanner size 1 [mm] | Spanner size 1 [mm] | Width [mm] | Width [mm] |
| Spanner size 2 [mm] | Spanner size 2 [mm] | Width 1 [mm] | Width 1 [mm] |
| Special Purpose Vehicle | Special Purpose Vehicle | Width 2 [mm] | Width 2 [mm] |
| Supplementary Article/ Info 2 | Supplementary Article/Info 2 | with accessories | with accessories |
| Supplementary Article/ Supplementary Info | Supplementary Article/Supplementary Info | with acoustic wear warning | with acoustic wear warning |
| Surface | Surface | with anti-squeak plate | with anti-squeak plate |
| Suspension | Suspension | with bolts/screws | with bolts/screws |
| Test Mark | Test Mark | with brake caliper screws | with brake caliper screws |
| Thickness [mm] | Thickness [mm] | with electric motor | with electric motor |
| Thickness 1 [mm] | Thickness 1 [mm] | with hollow screw | with hollow screw |
| Thickness 2 [mm] | Thickness 2 [mm] | without cable | without cable |
| Thread Size | Thread Size | without hollow screw | without hollow screw |
| Transmission Type | Transmission Type | Yes | Yes |
| Unreached Quality Gates | Unreached Quality Gates | → Construction year to | Construction year to |
| usage number | usage number | | |

Technical translations

Technische Übersetzungen - Traducciones tecnicas - Traductions techniques - Traduzioni tecniche

| EN | DE |
|--|--|
| → for RPO number (vehicle manufacturing date) up to |  Bremsschlauch |
| for RPO number (vehicle manufacturing date) up to |  Seilzug, Feststellbremse |
| → Vehicle Identification Number to |  Bremssattel |
| Vehicle Identification Number to |  Bremsbelagsatz, Scheibenbremse |
| |  Bremsscheibe |
| |  Raddrehzahlsensor |
| + ESP | für Fahrzeuge mit ESP |
| 14" | 14" |
| 17" | 17" |
| 5-Speed Manual Transmission | Schaltgetriebe 5 Gang |
| 6-Speed Manual Transmission | Schaltgetriebe 6 Gang |
| 7-Speed Automatic Transmission | Getriebeautomatik 7 Gang |
| Alloyed / High-carbon | legiert/hochgekoht |
| at brake caliper | am Bremssattel |
| ATE Ceramic | Artikelzusatzbezeichnung, ATE Ceramic |
| Black | schwarz |
| Bolt Hole Circle Ø [mm] | Lochkreis-Ø [mm] |
| Bore Ø [mm] | Bohrung-Ø [mm] |
| Brake Caliper Colour | Bremssattelfarbe |
| Brake Caliper Type | Bremssattelausführung |
| Brake caliper with adjusting element for electr. hand-brake | Bremssattel mit Stellelement für elektr. Feststellbremse |

Technical translations

Technische Übersetzungen - Traducciones tecnicas - Traductions techniques - Traduzioni tecniche

| DE | | DE | |
|---|---|---|--|
| Brake Disc Thickness [mm] | Bremsscheibendicke [mm] | Flange Hole Diameter [mm] | Flanschlochdurchmesser [mm] |
| Brake Disc Type | Bremsscheibenart | for brake disc diameter [mm] | für Bremsscheibendurchmesser [mm] |
| Brake Size | Bremsengröße | for extended wheelbase | für verlängerten Radstand |
| Brake System | Bremssystem | for individual equipment ID | für Individualausstattungs-ID |
| Brake Type | Bremsenart | for POC | für POC |
| Braking System | Bremsanlage | for PR number | für PR-Nummer |
| CB compatible package | SB gerechte Verpackung | for RPO number (vehicle manufacturing date) from → | für Organisationsnummer ab |
| Centering Diameter [mm] | Zentrierungsdurchmesser [mm] | for vehicles with Airmatic DC | für Fahrzeuge mit Airmatic DC |
| Coated | beschichtet | for vehicles with AMG Sports Package | für Fahrzeuge mit AMG-Sportpaket |
| Comfort Package | Komfortausstattung | for vehicles with brake-power regulator | für Fahrzeuge mit Bremskraftregler |
| Construction year from → | Baujahr ab | for vehicles with electric parking brake | für Fahrzeuge mit elektrischer Feststellbremse |
| Country specific article information | Länderspezifische Artikelinformation | for vehicles with electronic suspension control | für Fahrzeuge mit elektr. Dämpferregulierung |
| Country specific package and status data | Länderspezifische Verpackungs- und Status-Informationen | for vehicles with increased ground clearance | für Fahrzeuge mit erhöhter Bodenfreiheit |
| Czech Republic | Tschechische Republik | for vehicles without Airmatic DC | für Fahrzeuge ohne Airmatic DC |
| Disc Brake | Scheibenbremse | | |
| Drum Brake | Trommelbremse | | |
| - ESP | für Fahrzeuge ohne ESP | | |
| excl. wear warning contact | exkl. Verschleißwarnkontakt | | |
| External Thread [mm] | Außengewinde [mm] | | |
| Fist-type Caliper | Faustsattel | | |
| Fist-type Caliper (2 pistons) | Faustsattel(2-Kolben) | | |
| Fitting Position | Einbauseite | | |

Technical translations

Technische Übersetzungen - Traducciones tecnicas - Traductions techniques - Traduzioni tecniche

| DE | | DE | |
|--|--|--------------------------------------|---------------------------------------|
| for vehicles without AMG sports package | für Fahrzeuge ohne AMG-Sportpaket | Height 1 [mm] | Höhe 1 [mm] |
| | | Height 2 [mm] | Höhe 2 [mm] |
| for vehicles without autom. distance control | für Fahrzeuge ohne autom. Distanzregelung | High-carbon | hochgekohlt |
| | | incl. wear warning contact | inkl. Verschleißwarnkontakt |
| for vehicles without electric parking brake | für Fahrzeuge ohne elektrische Feststellbremse | Increased shock absorption | verstärkte Dämpfung |
| for vehicles without fold-down hand-brake lever | für Fahrzeuge ohne abklappbaren Handbremshebel | Inner diameter [mm] | Innendurchmesser [mm] |
| | | Internal Thread [mm] | Innengewinde [mm] |
| for vehicles without increased ground clearance | für Fahrzeuge ohne erhöhte Bodenfreiheit | Internal Thread 1 [mm] | Innengewinde 1 [mm] |
| | | Internal Thread 2 [mm] | Innengewinde 2 [mm] |
| for vehicles without parking assistant system | für Fahrzeuge ohne Parkassistenzsystem | Japan | Japan |
| | | Length [mm] | Länge [mm] |
| for vehicles without sports brake system | für Fahrzeuge ohne Sportbremsanlage | Length 1 [mm] | Länge 1 [mm] |
| | | Length 2 [mm] | Länge 2 [mm] |
| for vehicles without sports suspension | für Fahrzeuge ohne Sportfahrwerk | Machining | Bearbeitung |
| | | Manual Transmission | Schaltgetriebe |
| for vehicles with sports package | für Fahrzeuge mit Sportpaket | MAPP code available | MAPP-Code vorhanden |
| Front | vorne | Minimum thickness [mm] | Mindestdicke [mm] |
| Front Axle | Vorderachse | Normal Suspension | normale Dämpfung |
| Front Axle Left | Vorderachse links | not for brake caliper colour | nicht für Bremssattelfarbe |
| Front Axle Right | Vorderachse rechts | not for cruise control system | nicht für Geschwindigkeitsregelanlage |
| Grey | grau | not for extended wheelbase | nicht für verlängerten Radstand |
| Gross vehicle weight [kg] | zul. Gesamtgewicht [kg] | | |
| Height [mm] | Höhe [mm] | | |

Technical translations

Technische Übersetzungen - Traducciones tecnicas - Traductions techniques - Traduzioni tecniche

| DE | | DE | |
|---|--|--|-------------------------------------|
| not for government vehicles | nicht für Behördenfahrzeuge | replacement part | Austauschteil |
| not for SA code | nicht für SA Code | Required quantity | benötigte Stückzahl |
| not prepared for wear indicator | nicht für Verschleißwarnanzeiger vorbereitet | Right Rear | hinten rechts |
| Number of bolts/screws | Anzahl der Schrauben | Rim Size [in] | Felgengröße [Zoll] |
| Number of Doors | Türenanzahl | Service exchange part | Austauschteil |
| Number of Holes | Lochanzahl | Shock Absorber System | Stoßdämpfer-System |
| Number of wear indicators [per axle] | Anzahl Verschleißanzeiger [pro Achse] | Slovakia | Slowakische Republik |
| Observe dimensions | Abmessungen beachten | Solid | Voll |
| Outer diameter [mm] | Außendurchmesser [mm] | Spanner size 1 [mm] | Schlüsselweite 1 [mm] |
| Overall Length [mm] | Länge über Alles [mm] | Spanner size 2 [mm] | Schlüsselweite 2 [mm] |
| Paired article numbers | paarige Artikelnummer | Special Purpose Vehicle | Sondereinsatz-Fzg |
| Part number of recommended accessories | Artikelnummer des empfohlenen Zubehörs | Supplementary Article/ Info 2 | Ergänzungsartikel/Ergänzende Info 2 |
| Piston Diameter [mm] | Kolbendurchmesser [mm] | Supplementary Article/ Supplementary Info | Ergänzungsartikel/Ergänzende Info |
| prepared for wear indicator | für Verschleißwarnanzeiger vorbereitet | Surface | Oberfläche |
| Produkttyp vorhanden | Produkttyp vorhanden | Suspension | Fahrwerk |
| Reached Quality Gates | Erfüllte Qualitätsstufen | Test Mark | Prüfzeichen |
| Rear | hinten | Thickness [mm] | Dicke/Stärke [mm] |
| Rear Axle | Hinterachse | Thickness 1 [mm] | Dicke/Stärke 1 [mm] |
| Rear Axle Left | Hinterachse links | Thickness 2 [mm] | Dicke/Stärke 2 [mm] |
| Rear Axle Right | Hinterachse rechts | Thread Size | Gewindemaß |
| | | Transmission Type | Getriebeart |
| | | Unreached Quality Gates | Nicht erfüllte Qualitätsstufen |
| | | usage number | Gebrauchsnummer |

Technical translations

Technische Übersetzungen - Traducciones tecnicas - Traductions techniques - Traduzioni tecniche

| DE | | DE | |
|--|-----------------------------------|---|-----------------------------|
| Vehicle Equipment | Fahrzeugausstattung | → for RPO number (vehicle manufacturing date) up to | für Organisationsnummer bis |
| Vehicle Identification Number from → | Fahrgestellnummer ab | | |
| Vehicle Production Country | Fahrzeugproduktionsland | → Vehicle Identification Number to | Fahrgestellnummer bis |
| Warning Contact Length [mm] | Warnkontaktlänge [mm] | | |
| Wear Warning Contact | Verschleißwarnkontakt | | |
| Wheelbase | Radstand | | |
| Wheelbase [mm] | Radstand [mm] | | |
| Width [mm] | Breite [mm] | | |
| Width 1 [mm] | Breite 1 [mm] | | |
| Width 2 [mm] | Breite 2 [mm] | | |
| with accessories | mit Zubehör | | |
| with acoustic wear warning | mit akustischer Verschleißwarnung | | |
| with anti-squeak plate | mit Anti-Quietsch-Blech | | |
| with bolts/screws | mit Schrauben | | |
| with brake caliper screws | mit Bremssattelschrauben | | |
| with electric motor | mit Elektromotor | | |
| with hollow screw | mit Hohlschraube | | |
| without cable | ohne Kabel | | |
| without hollow screw | ohne Hohlschraube | | |
| Yes | Ja | | |
| → Construction year to | Baujahr bis | | |

Technical translations

Technische Übersetzungen - Traducciones técnicas - Traductions techniques - Traduzioni tecniche

| ES | | ES | |
|---|--|---|---|
|  | Tubo flexible de frenos | Brake Disc Thickness [mm] | Espesor de disco de frenos [mm] |
|  | Cable de accionamiento, freno de estacionamiento | Brake Disc Type | Tipo de disco de frenos |
|  | Pinza de freno | Brake Size | Tamaño freno |
|  | Juego de pastillas de freno | Brake System | Sistema de frenos |
|  | Disco de freno | Brake Type | Tipo de freno |
|  | Sensor de velocidad de la rueda | Braking System | Frenos |
| + ESP | para vehículos con ESP | CB compatible package | Embalaje apto para autoservicio |
| 14" | 14" | Centering Diameter [mm] | Diámetro de centrado [mm] |
| 17" | 17" | Coated | revestido |
| 5-Speed Manual Transmission | Caja de cambios manual, 5 marchas | Comfort Package | Equipamiento de confort |
| 6-Speed Manual Transmission | Caja de cambios manual, 6 marchas | Construction year from → | año construcción desde |
| 7-Speed Automatic Transmission | Caja automática, 7 marchas | Country specific article information | Información específica del país sobre el artículo |
| Alloyed / High-carbon | aleado/alt. carburado | Country specific package and status data | Información específica del país sobre el embalaje y sobre el estado |
| at brake caliper | en la pinza del freno | Czech Republic | República Checa |
| ATE Ceramic | Denominación adicional del artículo, ATE Ceramic | Disc Brake | Discos |
| Black | negro | Drum Brake | Tambor |
| Bolt Hole Circle Ø [mm] | corona de agujeros - Ø [mm] | - ESP | para vehículos sin ESP |
| Bore Ø [mm] | Taladro Ø [mm] | excl. wear warning contact | excl. contacto de avisador de desgaste |
| Brake Caliper Colour | Color pinza freno | External Thread [mm] | Rosca exterior [mm] |
| Brake Caliper Type | Tipo de pinza de freno | Fist-type Caliper | Montura de puño |
| Brake caliper with adjusting element for electr. hand-brake | Pinza del freno con accionador con freno de detención electr | Fist-type Caliper (2 pistons) | Montura de puño (2 émbolos) |
| | | Fitting Position | Lado de montaje |

Technical translations

Technische Übersetzungen - Traducciones técnicas - Traductions techniques - Traduzioni tecniche

| ES | | ES | |
|---|--|--|---|
| Flange Hole Diameter [mm] | Diám. taladro brida [mm] | for vehicles without AMG sports package | para vehículos sin paquete deportivo AMG |
| for brake disc diameter [mm] | para diámetro disco de freno [mm] | for vehicles without autom. distance control | para vehículos sin regulación automática de distancia |
| for extended wheelbase | para distancia entre ejesprolongada | for vehicles without electric parking brake | para vehículos sin freno de estacionamiento electrónico |
| for individual equipment ID | para ID equipamiento individual | for vehicles without fold-down hand-brake lever | para vehículos sin palanca de freno desplegable |
| for POC | para POC | for vehicles without increased ground clearance | para vehículos sin altura libre elevada |
| for PR number | Número de PR | for vehicles without parking assistant system | para vehic. sin auxiliar de aparcamiento |
| for RPO number (vehicle manufacturing date) from → | para números de organización desde | for vehicles without sports brake system | para vehículos sin sistema de frenos deportivos |
| for vehicles with Airmatic DC | para vehículos con Airmatic DC | for vehicles without sports suspension | para vehículos sin chasis deportivo |
| for vehicles with AMG Sports Package | para vehículos con paquete sport AMG | for vehicles with sports package | para vehículos con paquete sport |
| for vehicles with brake-power regulator | para vehículos con regulador de fuerza de frenado | Front | delante |
| for vehicles with electric parking brake | para vehículos con freno de estacionamiento electrónico | Front Axle | Eje delantero |
| for vehicles with electronic suspension control | para vehículos con regulación eléctrica de amortiguación | Front Axle Left | Eje delantero, izquierda |
| for vehicles with increased ground clearance | para vehículos con altura libre aumentada | Front Axle Right | Eje delantero, derecha |
| for vehicles without Airmatic DC | para vehículos sin Airmatic DC | Grey | gris |
| | | Gross vehicle weight [kg] | Peso total autorizado [kg] |
| | | Height [mm] | Altura [mm] |

Technical translations

Technische Übersetzungen - Traducciones técnicas - Traductions techniques - Traduzioni tecniche

| ES | | ES | |
|--------------------------------------|--|---|--|
| Height 1 [mm] | Altura 1 [mm] | not for government vehicles | no para veh. admon. pública |
| Height 2 [mm] | Altura 2 [mm] | not for SA code | no para código SA |
| High-carbon | altamente carbonizado | not prepared for wear indicator | no preparado para indicador de desgaste |
| incl. wear warning contact | con contacto avisador de desgaste | Number of bolts/screws | cantidad de tornillos |
| Increased shock absorption | Amortiguación reforzada | Number of Doors | Número de puertas |
| Inner diameter [mm] | Diámetro interior [mm] | Number of Holes | Número de orificios |
| Internal Thread [mm] | Rosca interior [mm] | Number of wear indicators [per axle] | cantidad indicadores de desgaste [por eje] |
| Internal Thread 1 [mm] | Rosca interior 1 [mm] | Observe dimensions | Observar dimensiones |
| Internal Thread 2 [mm] | Rosca interior 2 [mm] | Outer diameter [mm] | Diámetro exterior [mm] |
| Japan | Japón | Overall Length [mm] | Longitud total [mm] |
| Length [mm] | Longitud [mm] | Paired article numbers | Referencia artículo par |
| Length 1 [mm] | Longitud 1 [mm] | Part number of recommended accessories | Nº art. de accesorio recomendado |
| Length 2 [mm] | Longitud 2 [mm] | Piston Diameter [mm] | Diámetro del pistón [mm] |
| Machining | Procesamiento | prepared for wear indicator | preparado para indicador desgaste |
| Manual Transmission | Caja de cambios manual | Produkttyp vorhanden | Produkttyp vorhanden |
| MAPP code available | Code MAPP disponible | Reached Quality Gates | Erfüllte Qualitätsstufen |
| Minimum thickness [mm] | Espesor mínimo [mm] | Rear | posterior |
| Normal Suspension | Amortiguación normal | Rear Axle | Eje trasero |
| not for brake caliper colour | no para color pinza freno | Rear Axle Left | Eje trasero izquierda |
| not for cruise control system | no para sistemas de control de velocidad | Rear Axle Right | Eje trasero, derecha |
| not for extended wheelbase | no para distancia entre ejes prolongada | | |







Technical translations

Technische Übersetzungen - Traducciones técnicas - Traductions techniques - Traduzioni tecniche

| ES | | ES | |
|--|--|---|-----------------------------------|
| replacement part | Recambio | Vehicle Equipment | Equipamiento de vehículo |
| Required quantity | Número de piezas necesarias | Vehicle Identification Number from | nº de chasis desde |
| Right Rear | Atrás derecha | → | |
| Rim Size [in] | Tamaño de llanta [in] | Vehicle Production Country | País producción vehículo |
| Service exchange part | Pieza de intercambio | Warning Contact Length [mm] | Longitud contacto de aviso [mm] |
| Shock Absorber System | Sistema de amortiguadores | Wear Warning Contact | Contacto avisador de desgaste |
| Slovakia | República eslovaca | Wheelbase | Distancia entre ejes |
| Solid | Macizo | Wheelbase [mm] | Distancia entre ejes [mm] |
| Spanner size 1 [mm] | Ancho de llave 1 [mm] | Width [mm] | Ancho [mm] |
| Spanner size 2 [mm] | Ancho de llave 2 [mm] | Width 1 [mm] | Ancho 1 [mm] |
| Special Purpose Vehicle | Vehículo especial | Width 2 [mm] | Ancho 2 [mm] |
| Supplementary Article/ Info 2 | Artículo complementario / información complementaria 2 | with accessories | con accesorios |
| Supplementary Article/ Supplementary Info | Artículo complementario/Información complementaria | with acoustic wear warning | con avisador acústico de desgaste |
| Surface | Superficie | with anti-squeak plate | Chapa antichirridos |
| Suspension | Suspensión | with bolts/screws | con tornillos |
| Test Mark | Homologación | with brake caliper screws | con tornillos pinza freno |
| Thickness [mm] | Espesor [mm] | with electric motor | con electromotor |
| Thickness 1 [mm] | Espesor/grosor 1 [mm] | with hollow screw | con tornillo hueco |
| Thickness 2 [mm] | Espesor/grosor 2 [mm] | without cable | sin cable |
| Thread Size | Medida de rosca | without hollow screw | sin tornillo hueco |
| Transmission Type | Clase de caja de cambios | Yes | sí |
| Unreached Quality Gates | Nicht erfüllte Qualitätsstufen | → Construction year to | año construcción hasta |
| usage number | Número de uso | | |

Technical translations

Technische Übersetzungen - Traducciones técnicas - Traductions techniques - Traduzioni tecniche

| ES | FR |
|---|--|
| → for RPO number (vehicle manufacturing date) up to |  Flexible de frein |
| para n.º de org. hasta |  Tirette à câble, frein de stationnement |
| → Vehicle Identification Number to |  Étrier de frein |
| nº de chasis hasta |  Kit de plaquettes de frein, frein à disque |
| |  Disque de frein |
| |  Capteur de vitesse de roue |
| | + ESP pour véhicules avec ESP |
| | 14" 14" |
| | 17" 17" |
| | 5-Speed Manual Transmission Boîte de vitesses manuelle à 5 vitesses |
| | 6-Speed Manual Transmission Boîte de vitesses manuelle à 6 vitesses |
| | 7-Speed Automatic Transmission Boîte automatique à 7 vitesses |
| | Alloyed / High-carbon allié/carbonisé |
| | at brake caliper à l'étrier de frein |
| | ATE Ceramic Designation d'article complémentaire, ATE Ceramic |
| | Black noir |
| | Bolt Hole Circle Ø [mm] Cercle de perçage -Ø [mm] |
| | Bore Ø [mm] Alésage-Ø [mm] |
| | Brake Caliper Colour Couleur de l'étrier |
| | Brake Caliper Type Type d'étrier de frein |
| | Brake caliper with adjusting element for electr. hand-brake Étrier de frein + élément d'ajustage pr frein de stationnemt |

Technical translations

Technische Übersetzungen - Traducciones técnicas - Traductions techniques - Traduzioni tecniche

| FR | | FR | |
|---|---|---|--|
| Brake Disc Thickness [mm] | Épaisseur du disque de frein [mm] | Flange Hole Diameter [mm] | Diamètre du trou de bride [mm] |
| Brake Disc Type | Type de disque de frein | for brake disc diameter [mm] | pour diamètre du disque de frein [mm] |
| Brake Size | Dimension des freins | for extended wheelbase | pour empattement rallongé |
| Brake System | Système de freinage | for individual equipment ID | pour ID d'équipement individuel |
| Brake Type | Type de freinage | for POC | pour POC |
| Braking System | Dispositif de freinage | for PR number | pour numéro PR |
| CB compatible package | Emballage LS | for RPO number (vehicle manufacturing date) from → | pour n° OPR(date de fabrication du véhicule) à partir de |
| Centering Diameter [mm] | Diamètre du centrage [mm] | for vehicles with Airmatic DC | pour véhicules avec Airmatic DC |
| Coated | revêtu | for vehicles with AMG Sports Package | pour véhicules avec équipement-sport AMG |
| Comfort Package | Équipement de confort | for vehicles with brake-power regulator | pour véhicules avec régulateur de freinage |
| Construction year from → | Année à partir de | for vehicles with electric parking brake | pour véhicules avec frein d'arrêt électrique |
| Country specific article information | Informations articles spécifiques aux pays | for vehicles with electronic suspension control | pour véhicules avec réglage d'amortisseur électronique |
| Country specific package and status data | Informations d'emballage et d'état spécifiques aux pays | for vehicles with increased ground clearance | pour véhicules avec garde au sol augmentée |
| Czech Republic | République tchèque | for vehicles without Airmatic DC | pour véhicules sans Airmatic DC |
| Disc Brake | Frein à disque | | |
| Drum Brake | Frein à tambour | | |
| - ESP | pour véhicules sans ESP | | |
| excl. wear warning contact | contact de signal d'usure exclu | | |
| External Thread [mm] | Filetage extérieur [mm] | | |
| Fist-type Caliper | Étrier flottant | | |
| Fist-type Caliper (2 pistons) | Étrier flottant (2 pistons) | | |
| Fitting Position | Côté d'assemblage | | |

Technical translations

Technische Übersetzungen - Traducciones técnicas - Traductions techniques - Traduzioni tecniche

| FR | | FR | |
|--|--|--------------------------------------|------------------------------------|
| for vehicles without AMG sports package | pour véhicules sans paquet-sport AMG | Height 1 [mm] | Hauteur 1 [mm] |
| for vehicles without autom. distance control | pour véhicules sans régulation de distance autom. | Height 2 [mm] | Hauteur 2 [mm] |
| for vehicles without electric parking brake | pour véhicules sans frein d'arrêt électrique | High-carbon | à haute teneur en carbone |
| for vehicles without fold-down hand-brake lever | pour véhicules sans levier de frein à main abattible | incl. wear warning contact | contact de signal d'usure inclu |
| for vehicles without increased ground clearance | pour véhicules sans garde au sol augmentée | Increased shock absorption | Amortissement renforcé |
| for vehicles without parking assistant system | pour véhicules sans assistance partronic | Inner diameter [mm] | Diamètre intérieur [mm] |
| for vehicles without sports brake system | pour véhicules sans système de freinage sport | Internal Thread [mm] | Taraudage [mm] |
| for vehicles without sports suspension | pour véhicules sans châssis sportif | Internal Thread 1 [mm] | Taraudage 1 [mm] |
| for vehicles with sports package | pour véhicules avec équipement sport | Internal Thread 2 [mm] | Taraudage 2 [mm] |
| Front | avant | Japan | Japon |
| Front Axle | Essieu avant | Length [mm] | Longueur [mm] |
| Front Axle Left | Essieu avant gauche | Length 1 [mm] | Longueur 1 [mm] |
| Front Axle Right | Essieu avant droit | Length 2 [mm] | Longueur 2 [mm] |
| Grey | gris | Machining | Traitement |
| Gross vehicle weight [kg] | Poids total autorisé en charge [kg] | Manual Transmission | boîte de vitesses manuelle |
| Height [mm] | Hauteur [mm] | MAPP code available | MAPP-Code existant |
| | | Minimum thickness [mm] | Épaisseur minimum [mm] |
| | | Normal Suspension | Amortissement normal |
| | | not for brake caliper colour | pas pour couleur de l'étrier-frein |
| | | not for cruise control system | pas pour régulateur de vitesse |
| | | not for extended wheelbase | pas pour empattement rallongé |

Technical translations

Technische Übersetzungen - Traducciones técnicas - Traductions techniques - Traduzioni tecniche

| FR | | FR | |
|---|---|--|--|
| not for government vehicles | pas pour véhicules de l'administration | replacement part | Pièce de rechange |
| not for SA code | pas pour SA code | Required quantity | Nombre de pièces nécessaires |
| not prepared for wear indicator | non préparé pour indicateur d'usure | Right Rear | arrière droite |
| Number of bolts/screws | Nombre de vis | Rim Size [in] | Dimension de la jante [pouces] |
| Number of Doors | Nombre de portes | Service exchange part | Echange standard |
| Number of Holes | Nombre de trous | Shock Absorber System | Système d'amortisseur |
| Number of wear indicators [per axle] | Nombre d'indicateurs d'usure [par essieu] | Slovakia | République slovaque |
| Observe dimensions | Respecter les dimensions | Solid | plein |
| Outer diameter [mm] | Diamètre extérieur [mm] | Spanner size 1 [mm] | Largeur de clé 1 [mm] |
| Overall Length [mm] | Longueur globale [mm] | Spanner size 2 [mm] | Largeur de clé 2 [mm] |
| Paired article numbers | Numéro d'article en paire | Special Purpose Vehicle | Véhicule à usage spécial |
| Part number of recommended accessories | Référence de l'accessoire recommandé | Supplementary Article/ Info 2 | Article complémentaire / Info complémentaire 2 |
| Piston Diameter [mm] | Diamètre du piston [mm] | Supplementary Article/ Supplementary Info | Article complémentaire/Info complémentaire |
| prepared for wear indicator | préparé pour indicateur d'usure | Surface | Surface |
| Produkttyp vorhanden | Produkttyp vorhanden | Suspension | Châssis |
| Reached Quality Gates | Erfüllte Qualitätsstufen | Test Mark | Marque de conformité |
| Rear | arrière | Thickness [mm] | Épaisseur [mm] |
| Rear Axle | Essieu arrière | Thickness 1 [mm] | Épaisseur 1 [mm] |
| Rear Axle Left | Essieu arrière gauche | Thickness 2 [mm] | Épaisseur 2 [mm] |
| Rear Axle Right | Essieu arrière droit | Thread Size | Filetage |
| | | Transmission Type | Type d'entraînement |
| | | Unreached Quality Gates | Nicht erfüllte Qualitätsstufen |
| | | usage number | Numéro d'utilisation |





Technical translations

Technische Übersetzungen - Traducciones tecnicas - Traductions techniques - Traduzioni tecniche

| FR | | FR | |
|--|---|--|---|
| Vehicle Equipment | Équipement véhicule | → for RPO number (vehicle manufacturing date) up to | pour numéro OPR (date de fabrication du véhicule) jusqu'à |
| Vehicle Identification Number from → | N° de châssis à partir de | | |
| Vehicle Production Country | Pays constructeur du véhicule | → Vehicle Identification Number to | N° de châssis jusqu'à |
| Warning Contact Length [mm] | Longueur de contacts d'avertissement [mm] | | |
| Wear Warning Contact | Indicateur d'usure | | |
| Wheelbase | Empattement | | |
| Wheelbase [mm] | Empattement [mm] | | |
| Width [mm] | Largeur [mm] | | |
| Width 1 [mm] | Largeur 1 [mm] | | |
| Width 2 [mm] | Largeur 2 [mm] | | |
| with accessories | avec accessoires | | |
| with acoustic wear warning | avec indicateur d'usure | | |
| with anti-squeak plate | avec tôle anti-bruit | | |
| with bolts/screws | avec vis/boulons | | |
| with brake caliper screws | avec vis d'étrier de frein | | |
| with electric motor | avec moteur électrique | | |
| with hollow screw | avec vis creuse | | |
| without cable | sans câble | | |
| without hollow screw | sans vis creuse | | |
| Yes | Oui | | |
| → Construction year to | Année jusqu'à | | |

Technical translations

Technische Übersetzungen - Traducciones tecnicas - Traductions techniques - Traduzioni tecniche

| IT | | IT | |
|---|--|---|---|
|  | Flessibile del freno | Brake Disc Thickness [mm] | Spessore disco freno [mm] |
|  | Cavo comando, Freno stazionamento | Brake Disc Type | Tipo disco freno |
|  | Pinza freno | Brake Size | Misura freno |
|  | Kit pastiglie freno, Freno a disco | Brake System | Sistema frenante |
|  | Discofreno | Brake Type | Tipo freno |
|  | Sensore velocità ruote | Braking System | Impianto frenante |
| + ESP | per veicoli con ESP | CB compatible package | Imballaggio self-service |
| 14" | 14" | Centering Diameter [mm] | Diametro centraggio [mm] |
| 17" | 17" | Coated | rivestito |
| 5-Speed Manual Transmission | Cambio manuale a 5 marce | Comfort Package | Equipaggiamento comfort |
| 6-Speed Manual Transmission | Cambio manuale a 6 marce | Construction year from → | Anno da |
| 7-Speed Automatic Transmission | Cambio automatico a 7 marce | Country specific article information | Informazioni sull'articolo specifiche per i diversi Paesi |
| Alloyed / High-carbon | legato /ad alto tenore di carbonio | Country specific package and status data | Informazioni di imballaggio e di stato specifiche per i diversi Paesi |
| at brake caliper | alla pinza freno | Czech Republic | Repubblica ceca |
| ATE Ceramic | Denominazione aggiuntiva dell'articolo, ATE Ceramic | Disc Brake | Freno a disco |
| Black | nero | Drum Brake | Freno a tamburo |
| Bolt Hole Circle Ø [mm] | Cerchio foro-Ø [mm] | - ESP | per veicoli senza ESP |
| Bore Ø [mm] | Alesaggio-Ø [mm] | excl. wear warning contact | senza contatto segnalazione usura |
| Brake Caliper Colour | Colore pinza freno | External Thread [mm] | Filetto esterno [mm] |
| Brake Caliper Type | Tipo pinza freno | Fist-type Caliper | Pinza a pugno |
| Brake caliper with adjusting element for electr. hand-brake | Pinza freno con regolatore per freno stazionamento elettrico | Fist-type Caliper (2 pistons) | Pinza a pugno (2 pistoni) |
| | | Fitting Position | Lato montaggio |

Technical translations

Technische Übersetzungen - Traducciones técnicas - Traductions techniques - Traduzioni tecniche

| IT | | IT | |
|---|--|--|--|
| Flange Hole Diameter [mm] | Diametro foro flangia [mm] | for vehicles without AMG sports package | per veicoli senza pacchetto sportivo AMG |
| for brake disc diameter [mm] | per diametro disco freno [mm] | for vehicles without autom. distance control | per veicoli senza regolatore automatico distanza |
| for extended wheelbase | per passo allungato | for vehicles without electric parking brake | per veicoli senza freno stazionamento elettrico |
| for individual equipment ID | per ID-equipaggiamento individuale | for vehicles without fold-down hand-brake lever | per veicoli senza leva freno a mano ribaltabile |
| for POC | per POC | for vehicles without increased ground clearance | per veicoli senza altezza da terra maggiorata |
| for PR number | per N° PR | for vehicles without parking assistant system | per veicoli senza sistema assistenza parcheggio |
| for RPO number (vehicle manufacturing date) from → | per numero organizzazione da | for vehicles without sports brake system | per veicoli senza impianti frenante sportivo |
| for vehicles with Airmatic DC | per veicoli con Airmatic DC | for vehicles without sports suspension | per veicoli senza autotelaio sportivo |
| for vehicles with AMG Sports Package | per veicoli con pacchetto sportivo AMG | for vehicles with sports package | per veicoli con pacchetto sportivo |
| for vehicles with brake-power regulator | per veicoli con modulatore frenata | Front | anteriore |
| for vehicles with electric parking brake | per veicoli con freno stazionamento elettrico | Front Axle | Assale anteriore |
| for vehicles with electronic suspension control | per veicoli con regolazione elettr. ammortizzatori | Front Axle Left | Assale anteriore Sx |
| for vehicles with increased ground clearance | per veicoli con altezza da terra maggiorata | Front Axle Right | Assale anteriore Dx |
| for vehicles without Airmatic DC | per veicoli senza Airmatic DC | Grey | grigio |
| | | Gross vehicle weight [kg] | Peso complessivo omologato [kg] |
| | | Height [mm] | Altezza [mm] |

Technical translations

Technische Übersetzungen - Traducciones tecnicas - Traductions techniques - Traduzioni tecniche

| IT | | IT | |
|--------------------------------------|---------------------------------------|---|---|
| Height 1 [mm] | Altezza 1 [mm] | not for government vehicles | Non per veicoli dell'amministrazione pubbl. |
| Height 2 [mm] | Altezza 2 [mm] | not for SA code | non per codice SA |
| High-carbon | ad alto tenore di carbonio | not prepared for wear indicator | Non predisposto per contatto segnalazione usura |
| incl. wear warning contact | Con contatto segnalazione usura | Number of bolts/screws | N° viti/bulloni |
| Increased shock absorption | Ammortizzazione rinforzata | Number of Doors | N° portiere |
| Inner diameter [mm] | Diametro interno [mm] | Number of Holes | N° fori |
| Internal Thread [mm] | Filettatura interna [mm] | Number of wear indicators [per axle] | N° indicatori usura [per asse] |
| Internal Thread 1 [mm] | Filettatura interna 1 [mm] | Observe dimensions | Osservare le misure |
| Internal Thread 2 [mm] | Filettatura interna 2 [mm] | Outer diameter [mm] | Diametro esterno [mm] |
| Japan | Giappone | Overall Length [mm] | Lunghezza totale [mm] |
| Length [mm] | Lunghezza [mm] | Paired article numbers | N° articolo appaiato |
| Length 1 [mm] | Lunghezza 1 [mm] | Part number of recommended accessories | N° articolo accessorio consigliato |
| Length 2 [mm] | Lunghezza 2 [mm] | Piston Diameter [mm] | Diametro pistone [mm] |
| Machining | Lavorazione/Trattamento | prepared for wear indicator | Predisposto per contatto segnalazione usura |
| Manual Transmission | Cambio manuale | Produkttyp vorhanden | Produkttyp vorhanden |
| MAPP code available | MAPP-Code disponibile | Reached Quality Gates | Erfüllte Qualitätsstufen |
| Minimum thickness [mm] | Spessore min. [mm] | Rear | posteriore |
| Normal Suspension | Ammortizzazione normale | Rear Axle | Assale posteriore |
| not for brake caliper colour | non per colore pinza freno | Rear Axle Left | Assale posteriore Sx |
| not for cruise control system | non per impianto regolazione velocità | Rear Axle Right | Assale posteriore Dx |
| not for extended wheelbase | Non per passo allungato | | |

Technical translations

Technische Übersetzungen - Traducciones tecnicas - Traductions techniques - Traduzioni tecniche

| IT | | IT | |
|--|---|---|---|
| replacement part | Ricambio di rotazione | Vehicle Equipment | Equipaggiamento veicolo |
| Required quantity | N° pezzi occorrenti | Vehicle Identification Number from | N° telaio da |
| Right Rear | posteriore Dx | → | |
| Rim Size [in] | Misura cerchione [pollici] | Vehicle Production Country | Paese produzione veicolo |
| Service exchange part | Ricambio di rotazione | Warning Contact Length [mm] | Lunghezza contatti di segnalazione [mm] |
| Shock Absorber System | Ammortizzatore, sistema | Wear Warning Contact | Contatto avvisatore usura |
| Slovakia | Repubblica slovacca | Wheelbase | Passo ruote |
| Solid | Pieno | Wheelbase [mm] | Passo ruote [mm] |
| Spanner size 1 [mm] | Apertura chiave 1 [mm] | Width [mm] | Larghezza [mm] |
| Spanner size 2 [mm] | Apertura chiave 2 [mm] | Width 1 [mm] | Larghezza 1 [mm] |
| Special Purpose Vehicle | Autoveicolo usi speciali | Width 2 [mm] | Larghezza 2 [mm] |
| Supplementary Article/ Info 2 | Articolo complementare/Info integrativa 2 | with accessories | con accessori |
| Supplementary Article/ Supplementary Info | Articolo complementare/Info integrativa | with acoustic wear warning | con segnalatore acustico usura |
| Surface | Superficie | with anti-squeak plate | con lamierino anticigolio |
| Suspension | Autotelaio | with bolts/screws | con bulloni/viti |
| Test Mark | Marchio controllo | with brake caliper screws | con bulloni pinza freno |
| Thickness [mm] | Spessore [mm] | with electric motor | con motore elettrico |
| Thickness 1 [mm] | Spessore 1 [mm] | with hollow screw | con vite cava |
| Thickness 2 [mm] | Spessore 2 [mm] | without cable | senza cavo |
| Thread Size | Dimensioni filettatura | without hollow screw | senza vite cava |
| Transmission Type | Modalità di trasmissione | Yes | Si |
| Unreached Quality Gates | Nicht erfüllte Qualitätsstufen | → Construction year to | Anno fino a |
| usage number | Codice d'uso | | |

Technical translations

Technische Übersetzungen - Traducciones tecnicas - Traductions techniques - Traduzioni tecniche

IT

→ for RPO
number
(vehicle
manufac-
turing date)
up to

per numero organizzazione fino a

→ Vehicle
Identification
Number to

N° telaio fino a

ATE – A Trademark of the
Continental Corporation

**Continental Aftermarket & Services
GmbH**

Sodener Straße 9
D-65824 Schwalbach
Tel. +49 (0) 6196 87 0
Fax +49 (0) 6196 865 71

www.ate.de

**Continental Automotive Trading
Italia S.r.l.**

Via Matteotti, 62
I-20092 Cinisello Balsamo (MI)
Tel. +39 02 35680 1
Fax +39 02 35680 325
E-Mail: supporto@continental-corporation.com

www.ate-freni.it

Continental Automotive France SAS

1 rue de Clairefontaine
F-78120 Rambouillet
Tél. +33 (0)1 34 57 40 19
Fax +33 (0)1 34 57 40 72

www.ate-freinage.fr

Continental Automotive Spain, S.A.

C/ Sepúlveda, 11
E-28108 Alcobendas (Madrid) Phone
+34 (0) 657 21 21
Fax +34 (0)91 657 21 49

www.frenos-ate.es