

ATE New Parts ATE Neuteile

05/2022



Brakethrough Technology



Erstklassig First-class

Besser ist besser

Wenn es um Qualität geht, genügt uns ein „sehr gut“ noch lange nicht. Wir erfüllen hohe Ansprüche an das Qualitätsmanagement und die europäische Sicherheitsnorm ECE-R90 wird von ATE sogar übertroffen. Zudem führen wir zahlreiche zusätzliche Tests durch, unter anderem zu Verschleiß und Wärmeleistung.

Auch Nachhaltigkeit ist uns wichtig: Wir stellen die Mischungen für ATE Bremsbeläge auf kupferfreie Materialien um und setzen bei ATE Ceramic auf geringen Abrieb. Nutzen ausschließlich umweltfreundliches Material für die Beschichtung von Bremscheiben. Und bereiten Produkte wie Bremsattel wieder auf.

Better is better

When it comes to quality, “very good” is simply not good enough for us. We meet high standards of quality management – and ATE even exceeds the European safety standard ECE-R90. We also perform many additional tests, including wear and thermal performance.

Sustainability is also important to us: we convert the compounds for ATE brake pads to copperfree materials and opt for low abrasion with ATE Ceramic. We only use environmentally friendly material for the coating of brake discs – and we remanufacture products like brake callipers.

Höchste Qualität für optimale Leistung.



NEU: SUPER DOT 5.1

Neue Premium-Flüssigkeit ATE SUPER DOT 5.1 mit bester Funktionalität bei heißen wie kalten Einsatzbedingungen: 5°C höherer Nassiedepunkt und höheres Wechselintervall als ATE SL.6 bei gleich guter Viskosität, ideal für Fahrzeuge mit modernen Fahrerassistenzsystemen wie ESP®, ABS und ASR.

Große Auswahl für alle Einsatzgebiete

- | ATE SL als bewährter DOT 4 Typ, ATE TYP 200 für Rennsportbegeisterte und ATE DOT 3 G für Oldtimer und Fahrzeuge, wo die Verwendung einer DOT 3-Flüssigkeit vom Fahrzeughersteller vorgeschrieben ist
- | ATE SL.6 ist optimal für ESP®, ABS und ASR: dünnflüssig auch bei niedrigen Temperaturen, schnelle Reaktionszeit
- | Siedepunkte und Viskosität übertreffen gesetzliche und technische Anforderungen
- | Schutz vor Korrosion durch hochwertige Additive

Die Eigenschaften von ATE Bremsflüssigkeiten

	Siedepunkt	Nassiedepunkt	Viskosität bei -40°C	Wechselintervall
ATE SUPER DOT 5.1	min. 265°C	min. 180°C	max. 750 mm ² /s	bis 3 Jahre
ATE TYP 200 DOT 4 Racing-Qualität	min. 280°C	min. 198°C	max. 1.400 mm ² /s	bis 3 Jahre
ATE SL.6 DOT 4 Ideal für ESP®, ABS, ASR	min. 265°C	min. 175°C	max. 700 mm ² /s	bis 2 Jahre
ATE SL DOT 4	min. 260°C	min. 165°C	max. 1.400 mm ² /s	bis 1 Jahr
ATE G DOT 3	min. 245°C	min. 150°C	max. 1.500 mm ² /s	bis 1 Jahr

Zur Erhaltung der Funktionssicherheit der Bremsanlage muss Bremsflüssigkeit entsprechend der vom Fahrzeughersteller vorgegebenen Qualität und in den angegebenen Wechselintervallen ausgetauscht werden.

Servicegeräte

Natürlich bieten wir auch Geräte für Tests, Entlüftung und Entsorgung von Bremsflüssigkeiten an. Sie arbeiten exakt und zuverlässig, sind leicht zu bedienen und technologisch auf dem neuesten Stand.

Erfahren Sie mehr über ATE Bremsflüssigkeiten auf www.ate.de/bremsfluessigkeit sowie über unsere Servicegeräte auf www.ate-info.de



Typ	ATE Sachnummer	EAN-Nr. 4006633	Gebinde	Paletteneinheit
SUPER DOT 5.1 SAE-Spezifikation, J1704-FMVSS 116/DOT 5.1 ISO Klasse 5-1 – niedrigviskos	706602 03.9901-6602.2	45757 6	1 l	600 Kannen ²
	706603 03.9901-6603.2	45759 0	5 l	400 Kannen ³
	706611 03.9901-6611.2	45761 3	20 l	36 Kannen
TYP 200 SAE-Spezifikation, J1704-FMVSS 116/DOT 4	706202 03.9901-6202.2	10825 6	1 l	600 Kannen ²
	706203 03.9901-6203.2	12166 8	5 l	400 Kannen ³
	706220 03.9901-6220.2	12780 6	30 l	22 Kannen
SL.6 SAE-Spezifikation, J1704-FMVSS 116/DOT 4 ISO-Klasse 6 – niedrigviskos	706402 03.9901-6402.2	20746 1	1 l	600 Kannen ²
	706403 03.9901-6403.2	20748 5	5 l	400 Kannen ³
	706411 03.9901-6411.2	20750 8	20 l	36 Kannen
	706420 03.9901-6420.2	23120 6	30 l	22 Kannen
	706414 03.9901-6414.2	23005 6	50 l	12 Kannen
	706405 03.9901-6405.2	23121 3	200 l	1 Stück
SL SAE-Spezifikation, J1704-FMVSS 116/DOT 4	705801 03.9901-5801.2	49001 6	1/2 l	1.200 Kannen ¹
	705802 03.9901-5802.2	49002 3	1 l	600 Kannen ²
	705803 03.9901-5803.2	49003 0	5 l	400 Kannen ³
	705811 03.9901-5811.2	29907 7	20 l	12 Kannen
	705820 03.9901-5820.2	10824 9	30 l	22 Kannen
	705814 03.9901-5814.2	10366 4	50 l	12 Kannen
	705805 03.9901-5805.2	49005 4	200 l	1 Stück
G SAE-Spezifikation, J1703-FMVSS 116/DOT 3	705302 03.9901-5302.2	10199 8	1 l	600 Kannen ²
	705303 03.9901-5303.2	10201 8	5 l	400 Kannen ³

Abweichende Artikelnummern für Lieferländer außerhalb Deutschlands möglich.

Paletteneinheit:

¹ 20 Kannen je Karton

² 10 Kannen je Karton

³ 4 Kannen je Karton

Top quality for optimum performance.



NEW: SUPER DOT 5.1

The new premium ATE SUPER DOT 5.1 brake fluid with optimum performance in both hot and cold conditions: 5°C higher wet boiling point than ATE SL.6, same excellent viscosity, longer change interval, ideal for vehicles with advanced driver assistance systems like ESP®, ABS and ASR.

Wide selection for all applications

- | ATE SL as a proven DOT 4 grade, ATE TYPE 200 for racing enthusiasts and ATE DOT 3 G for classic cars and vehicles for which the manufacturer specifies a DOT 3 brake fluid
- | ATE SL.6 is optimal for ESP®, ABS and ASR: low viscosity even at low temperatures, with a fast reaction time
- | Boiling points and viscosities are better than in statutory and technical regulations
- | Protection from corrosion by high-grade additives

Properties of ATE brake fluids

	Boiling point	Wet boiling point	Viscosity at -40°C	Change interval
ATE SUPER DOT 5.1	min. 265 °C / 509 °F	min. 180 °C / 356 °F	max. 750 mm ² /s	up to 3 years
ATE TYPE 200 DOT 4 Racing quality	min. 280 °C / 536 °F	min. 198 °C / 388 °F	max. 1,400 mm ² /s	up to 3 years
ATE SL.6 DOT 4 Ideal for ESP®, ABS, ASR	min. 265 °C / 509 °F	min. 175 °C / 347 °F	max. 700 mm ² /s	up to 2 years
ATE SL DOT 4	min. 260 °C / 500 °F	min. 165 °C / 329 °F	max. 1,400 mm ² /s	up to 1 year
ATE G/ATE Blue DOT 3	min. 245 °C / 473 °F	min. 150 °C / 302 °F	max. 1,500 mm ² /s	up to 1 year

To maintain the operational reliability and safety of the brake system, you must change the brake fluid in accordance with the vehicle manufacturer's recommendations on quality and at the specified change intervals.

Service units

Of course we also offer devices for testing, bleeding and disposing of brake fluids. The devices work accurately and reliably, are easy to use and their technology is state-of-the-art.



To learn more about ATE brake fluids go to www.ate.de/bremsfluessigkeit. Information on our service units is available at www.ate-info.de

Type	ATE item code	Language variations	Container	Pallet unit
SUPER DOT 5.1 SAE specification, J1704-FMVSS 116/DOT 5.1 ISO Class 5-1 – low viscosity	706602 03.9901-6602.2	DE, EN, ES, PT, CN, FR, IT, AR, SE, NL, JP, TH, GR	1 L	600 cans ²
	706612 03.9901-6612.2	PL, RU, CZ, SK, SLO, HU, BG, KA, HR, SR, RO	1 L	600 cans ²
	706603 03.9901-6603.2	DE, EN, ES, PT, CN, FR, IT, AR, SE, NL, JP, TH, GR, PL, RU, CZ, SK, SLO, HU, BG, KA, HR, SR, RO	5 L	400 cans ³
	706611 03.9901-6611.2	DE, EN, ES, PT, CN, FR, IT, AR, SE, NL, JP, TH, GR, PL, RU, CZ, SK, SLO, HU, BG, KA, HR, SR, RO	20 L	36 cans
TYP 200 SAE specification, J1704-FMVSS 116/DOT 4	706202 03.9901-6202.2	DE, EN, ES, PT, CN, FR, IT, AR, SE, NL, JP, TH, GR	1 L	600 cans ²
	706212 03.9901-6212.2	PL, RU, CZ, SK, SLO, HU, BG, KA, HR, SR, RO	1 L	600 cans ²
	706203 03.9901-6203.2	DE, EN, PL, ES, CN, FR, IT, RO, AR, SE, RU, HR, SR, CZ, SK, SLO, GR, HU, JP, TH, BG, NL, PT, KA, DK, FI, SQ, TR, LV, NO, LT, MS, HY	5 L	400 cans ³
	706220 03.9901-6220.2	DE, EN, PL, ES, CN, FR, IT, RO, AR, SE, RU, HR, SR, CZ, SK, SLO, GR, HU, JP, TH, BG, NL, PT, KA, DK, FI, SQ, TR	30 L	22 cans
SL.6 SAE specification, J1704-FMVSS 116/DOT 4 ISO Class 6 – low viscosity	706402 03.9901-6402.2	DE, EN, ES, PT, CN, FR, IT, AR, SE, NL, JP, TH, GR	1 L	600 cans ²
	706432 03.9901-6432.2	PL, RU, CZ, SK, SLO, HU, BG, KA, HR, SR, RO	1 L	600 cans ²
	706403 03.9901-6403.2	DE, EN, PL, ES, CN, FR, IT, RO, AR, SE, RU, HR, SR, CZ, SK, SLO, GR, HU, JP, TH, BG, NL, PT, KA, DK, FI, SQ, TR, LV, NO, LT, MS, HY	5 L	400 cans ³
	706411 03.9901-6411.2	DE, EN, PL, ES, CN, FR, IT, RO, AR, SE, RU, HR, SR, CZ, SK, SLO, GR, HU, JP, TH, BG, NL, PT, KA, DK, FI, SQ, TR, LV	20 L	36 cans
	706420 03.9901-6420.2	DE, EN, PL, ES, CN, FR, IT, RO, AR, SE, RU, HR, SR, CZ, SK, SLO, GR, HU, JP, TH, BG, NL, PT, KA, DK, FI, SQ, TR	30 L	22 cans
	706414 03.9901-6414.2	DE, EN, PL, ES, CN, FR, IT, RO, AR, SE, RU, HR, SR, CZ, SK, SLO, GR, HU, JP, TH, BG, NL, PT, KA, DK, FI, SQ, TR	50 L	12 cans
	706405 03.9901-6405.2	DE, EN, PL, ES, CN, FR, IT, RO, AR, SE, RU, HR, SR, CZ, SK, SLO, GR, HU, JP, TH, BG, NL, PT, KA, DK, FI, SQ, TR	200 L	1 item
SL SAE specification, J1704-FMVSS 116/DOT 4	705801 03.9901-5801.2	DE, EN, ES, AR, TH, CN	1/2 L	1,200 cans ¹
	705831 03.9901-5831.2	PL, RO, RU, HR, SLO, KA	1/2 L	1,200 cans ²
	705802 03.9901-5802.2	DE, EN, ES, PT, CN, FR, IT, AR, SE, NL, JP, TH, GR	1 L	600 cans ²
	705832 03.9901-5832.2	PL, RU, CZ, SK, SLO, HU, BG, KA, HR, SR, RO	1 L	600 cans ²
	705803 03.9901-5803.2	DE, EN, PL, ES, CN, FR, IT, RO, AR, SE, RU, HR, SR, CZ, SK, SLO, GR, HU, JP, TH, BG, NL, PT, KA, DK, FI, SQ, TR, LV, NO, LT, MS, HY	5 L	400 cans ³
	705811 03.9901-5811.2	DE, EN, PL, ES, CN, FR, IT, RO, AR, SE, RU, HR, SR, CZ, SK, SLO, GR, HU, JP, TH, BG, NL, PT, KA, DK, FI, SQ, TR, LV	20 L	12 cans
	705820 03.9901-5820.2	DE, EN, PL, ES, CN, FR, IT, RO, AR, SE, RU, HR, SR, CZ, SK, SLO, GR, HU, JP, TH, BG, NL, PT, KA, DK, FI, SQ, TR	30 L	22 cans
	705814 03.9901-5814.2	DE, EN, PL, ES, CN, FR, IT, RO, AR, SE, RU, HR, SR, CZ, SK, SLO, GR, HU, JP, TH, BG, NL, PT, KA, DK, FI, SQ, TR	50 L	12 cans
	705805 03.9901-5805.2	DE, EN, PL, ES, CN, FR, IT, RO, AR, SE, RU, HR, SR, CZ, SK, SLO, GR, HU, JP, TH, BG, NL, PT, KA, DK, FI, SQ, TR	200 L	1 item
G SAE specification, J1703-FMVSS 116/DOT 3	705302 03.9901-5302.2	-	1 L	600 cans ²
	705303 03.9901-5303.2	-	5 L	400 cans ³
BLUE SAE specification, J1703-FMVSS 116/DOT 3	700301 03.9901-0301.2	-	1/2 L	1,200 cans ²
	700302 03.9901-0302.2	-	1 L	600 cans ²

Item codes may be different for countries of delivery other than Germany.

Pallet unit: ¹20 cans per box, ²10 cans per box, ³4 cans per box

EN Table of contents

Index of vehicles
Product details
Applications of vehicles
Technical translations

DE Inhaltsverzeichnis

8	Herstellerverzeichnis
11	Produktdetails
21	Fahrzeugverwendungen
47	Technische Übersetzungen

ES Índice

8	Índice de vehículos	8
11	Descripción del producto	11
21	Aplicaciones	21
47	Traducciones técnicas	47

FR Table des matières

Liste des véhicules
Présentation du produit
Applications
Traductions techniques







IT Sommario

8	Indice autovetture	8
11	Panoramica prodotti	11
21	Applicazioni autoveicoli	21
47	Traduzioni tecniche	47



- EN** Index of vehicles
- DE** Herstellerverzeichnis
- ES** Índice de vehículos
- FR** Liste des véhicules
- IT** Indice autovetture

05/2022

					
AUDI	22	HYUNDAI	29	OPEL	35
A3 (8V1, 8VK)	22	KONA SUV Van (OS, OSE, OSI)	30	ASTRA J Hatchback Van (P10)	36
A3 Convertible (8V7, 8VE)	22	SANTA FE IV (TM, TMA)	30	ASTRA J Saloon	36
A3 Limousine (8VS, 8VM)	22	SANTA FE IV SUV Van (TM)	30	ASTRA J Sports Tourer (P10)	36
A3 Sportback (8VA, 8VF)	23	TUCSON (TL, TLE)	30	CASCADA (W13)	36
Q2 (GAB, GAG)	23			ZAFIRA TOURER C (P12)	36
				ZAFIRA TOURER C VAN (P12)	37
BMW	23	JAGUAR	30	PEUGEOT	37
1 (F40)	23	XE (X760)	30	4007 (VU_, VV_)	37
2 Gran Coupe (F44)	23			4008	37
X2 (F39)	23			PARTNER Box Body/MPV	37
				PARTNER Platform/Chassis	37
				PARTNER TEPEE	37
CHEVROLET	23	KIA	30	PORSCHE	37
CRUZE (J300)	23	PICANTO II (TA)	30	MACAN (95B)	37
CRUZE Hatchback (J305)	24	SORENTO III (UM)	30		
CRUZE Station Wagon (J308)	24				
ORLANDO (J309)	24	LADA	31		
		VESTA (GFL_)	31		
		VESTA SW Estate (GFK_)	31		
CITROËN	24	LAND ROVER	31	RENAULT	38
BERLINGO / BERLINGO FIRST Box Body/MPV (M_)	24	DISCOVERY SPORT (L550)	31	ARKANA I (LCM_, LDN_)	38
BERLINGO Box Body/MPV (B9)	24	DISCOVERY SPORT VAN (L550)	31	CLIO IV (BH_)	38
BERLINGO MULTISPACE (B9)	24	RANGE ROVER EVOQUE (L538)	31	CLIO IV Hatchback Van (BH_)	38
BERLINGO Platform/Chassis (B9)	25	RANGE ROVER EVOQUE Convertible (L538)	32	DUSTER (HM_)	38
C4 AIRCROSS	25	RANGE ROVER EVOQUE VAN (L538)	32	DUSTER (HS_)	38
C4 GRAND PICASSO I (UA_)	25			KAPTUR (H5_)	38
C4 PICASSO I MPV (UD_)	25			LOGAN II Estate (K8_)	38
C-CROSSER (VU_, VV_)	25			SANDERO/STEPWAY II (B8_)	38
				THALIA III (L8_)	39
CUPRA	25	LEXUS	32	SEAT	39
ATECA (KH7, KHP)	25	GX (URJ15_, GRJ15_)	32	ALHAMBRA (710, 711)	39
				ALHAMBRA VAN (711)	39
				ATECA (KH7, KHP)	39
				LEON (5F1)	39
				LEON Hatchback Van (5F1)	39
				LEON SC (5F5)	40
				LEON ST (5F8)	40
				LEON ST Estate Van (5F8)	40
DACIA	25	MAZDA	32	SKODA	40
DUSTER (HM_)	25	6 Estate (GJ, GL)	32	KAROQ (NU7, ND7)	40
DUSTER (HS_)	26	6 Estate Van (GJ)	32	OCTAVIA III (5E3, NL3, NR3)	41
DUSTER SUV Van	26	6 Saloon (GJ, GL)	32	OCTAVIA III Combi (5E5, 5E6)	41
LOGAN II	26			SUPERB III (3V3)	41
LOGAN MCV II	26			SUPERB III Estate (3V5)	42
SANDERO II	26				
		MERCEDES-BENZ	32	SSANGYONG	42
		A-CLASS (W177)	32	TIVOLI	42
		A-CLASS Saloon (V177)	32	XLV SUV	42
		B-CLASS Sports Tourer (W247)	33	XLV VAN	42
		CITAN Box Body/MPV (W415)	33		
		CITAN Mixto (Double Cabin) (W415)	33	TOYOTA	42
		CITAN MPV (W415)	33	4 RUNNER V (_N28_)	42
		CLA (C118)	33	FJ CRUISER (GSJ1_)	42
		CLA Shooting Brake (X118)	33	LAND CRUISER 200 (_J2_)	43
				LAND CRUISER PRADO (_J15_)	43
				YARIS (_P21_, _PA1_, _PH1_)	43
FIAT	27	MINI	33	VAUXHALL	43
500 (312_)	27	MINI CLUBMAN (F54)	33	ASTRA Mk VI (J) (P10)	43
500 C (312_)	27	MINI COUNTRYMAN (F60)	33	ASTRA Mk VI (J) Estate (P10)	43
500e (332_)	27			ASTRA Mk VI (J) GTC (P10)	43
500e Convertible (332_)	27			ASTRA Mk VI (J) Saloon (P10)	44
				CASCADA Convertible (W13)	44
				ZAFIRA Mk III (P12)	44
FORD	27	MITSUBISHI	33	VW	44
B-MAX (JK)	27	ASX (GA_W_)	33	ARTEON (3H7, 3H8)	44
B-MAX Van (JK)	27	ASX Van (GA_W_)	34	ARTEON SHOOTING BRAKE (3H9)	44
FIESTA VI (CB1, CCN)	27	GRANDIS (NA_W)	34	GOLF ALLTRACK VII Variant (BA5, BV5)	45
FIESTA VI Van	27	LANCER VII (CS_A, CT_A)	34		
TOURNEO COURIER B460 MPV	27	LANCER VIII (CY_A, CZ_A)	34		
TOURNEO CUSTOM V362 Bus (F3)	28	LANCER VIII Sportback (CX_A)	34		
TRANSIT COURIER B460 Box Body/MPV	28	OUTLANDER II (CW_W)	34		
TRANSIT COURIER B460 MPV	28	OUTLANDER II Van (CW_W)	35		
TRANSIT CUSTOM V362 Bus (F3)	28				
TRANSIT CUSTOM V362 Van (FY, FZ)	28				
TRANSIT V363 Bus (FAD, FBD)	28				
TRANSIT V363 Platform/Chassis (FED, FFD)	28				
TRANSIT V363 Van (FCD, FDD)	28				
		NISSAN	35		
		JUKE (F15)	35		
		JUKE Van (F15)	35		
		SENTRA VI (B16)	35		
		SENTRA VII (B17)	35		
		TIIDA Hatchback (C12)	35		
HONDA	29	OPEL	35		
CIVIC VIII Hatchback (FN, FK)	29	ASTRA J (P10)	35		
CIVIC VIII Saloon (FD, FA)	29	ASTRA J Estate Van (P10)	35		
CR-V III (RE_)	29	ASTRA J GTC	36		
HYUNDAI	29				
ix20 (JC)	29				
KONA (OS, OSE, OSI)	30				

**VW****44**

GOLF SPORTSVAN VII (AM1, AN1)	45
GOLF VII Variant (BA5, BV5)	44
PASSAT ALLTRACK B8 Variant (3G5, CB5)	45
PASSAT B8 (3G2, CB2)	45
PASSAT B8 Variant (3G5, CB5)	45
SHARAN (7N1, 7N2)	46
SHARAN VAN (7N1, 7N2)	46
TOURAN (5T1)	46
TOURAN VAN (5T1)	46
T-ROC (A11, D11)	46
T-ROC Convertible (AC7, AC8)	46





- EN** Product details
- DE** Produktdetails
- ES** Descripción del producto
- FR** Présentation du produit
- IT** Panoramica prodotti

05/2022



03.0137-9321.2

669321

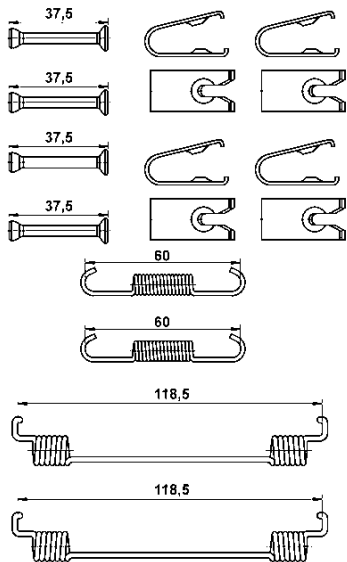

Accessory Kit, brake shoes

FIAT, LADA, TOYOTA

13.0460-5544.2

605544

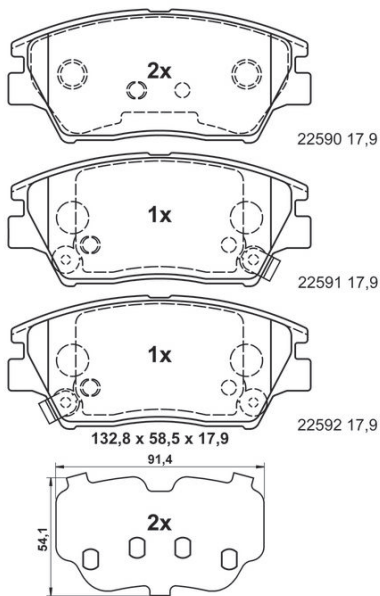

Brake Pad Set, disc brake

Thickness [mm] 17.2

with anti-squeak plate

+ WK

Height [mm] 58.5

Width [mm] 132.8

SSANGYONG

13.0460-7332.2

607332

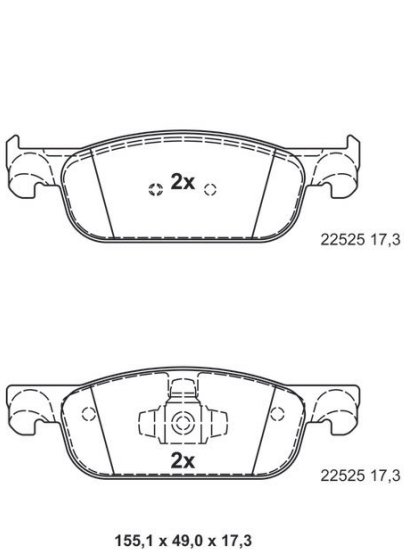

Brake Pad Set, disc brake

Thickness [mm] 17.3

ATE

- WE / - WK

Height [mm] 49

Width [mm] 155.1

DACIA, RENAULT



13.0470-5681.2

LD5681

ATE Ceramic

[1:3]



Brake Pad Set, disc brake

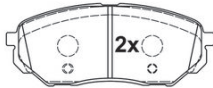

22378 17,0

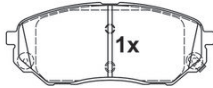

22379 17,0

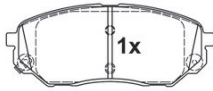

22380 17,0

152,0 x 60,5 x 17,0

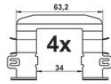
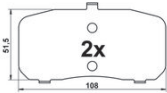

Thickness [mm] 17
with anti-squeak plate

Mobis

+ Zub

+ WK

Height [mm] 60.5

Width [mm] 152

HYUNDAI, KIA

13.0470-5781.2

LD5781

ATE Ceramic



Brake Pad Set, disc brake

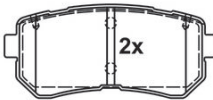

24949 15,6

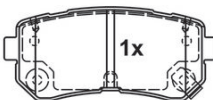

24950 15,6

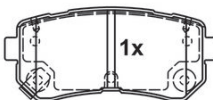

24951 15,6

93,1 x 41,0 x 15,6

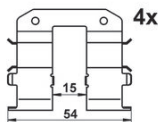

Thickness [mm] 15.6

MAN

+ Zub

+ WK

Height [mm] 41

Width [mm] 93.1

HYUNDAI, KIA

13.0470-7349.2

LD7349

ATE Ceramic



Brake Pad Set, disc brake

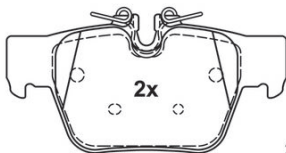

26212 16,3

122,8 x 60,6 x 16,3

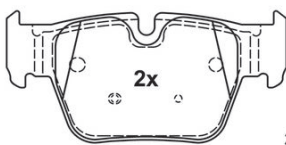

26213 14,3

122,8 x 57,1 x 14,3

Height 1 [mm]: 60.6

ATE

Thickness 2 [mm] 14.3

Thickness 1 [mm] 16.3

+ WE / - WK

Width [mm] 122.8

Height 2 [mm]: 57.1

BMW, MINI

24.0124-0265.1

424265

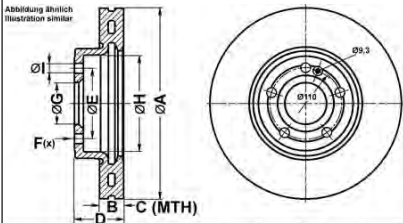

	A	B	C	D	E	F(x)	G	H	I
	295,0	24,0	21,4	51,0	112,0	5	67,0	154,5	15,3



Brake Disc

- Ø 154.5
- Minimum thickness [mm] 21.4
- Machining: HC
- + S
- Brake Disc Thickness [mm] 24
- SurfaceB
- Centering Diameter [mm]: 67
- Number of Holes: 5
- Bore Ø [mm] 15.3
- Bolt Hole Circle Ø [mm]: 112
- Height [mm] 51
- Vented
- Ø 295
- MERCEDES-BENZ**

24.0128-0328.1

428328

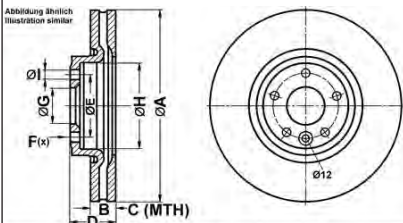

	A	B	C	D	E	F(x)	G	H	I
	316,0	28,0	26,0	48,2	108,0	5	63,5	150,5	13,8



Brake Disc

- Ø 150.5
- Minimum thickness [mm] 26
- Machining: HC
- Brake Disc Thickness [mm] 28
- SurfaceB
- Centering Diameter [mm]: 63.5
- Number of Holes: 5
- Bore Ø [mm] 13.8
- Bolt Hole Circle Ø [mm]: 108
- Height [mm] 48.2
- Vented
- Ø 316
- JAGUAR**

24.0710-2096.3

360629



Wheel Speed Sensor

- L= 217
- L= 323
- FORD**



24.0710-2098.3

360630



Wheel Speed Sensor

L= 510

L= 594

DACIA, RENAULT

24.0710-2107.3

360631



Wheel Speed Sensor

L= 607

L= 711

CITROËN, PEUGEOT

24.0710-2109.3

360632



Wheel Speed Sensor

L= 569

L= 660

FORD

24.0710-2110.3

360633



Wheel Speed Sensor

L= 569

L= 660

FORD

24.0710-2111.3

360634



Wheel Speed Sensor

L= 1,538

L= 1,630

MERCEDES-BENZ

24.0710-5050.3

360479



Wheel Speed Sensor

L= 1,010

MITSUBISHI

24.0710-5051.3

360480



Wheel Speed Sensor

L= 1,053

MITSUBISHI

24.0710-5053.3

360482



Wheel Speed Sensor

L= 555

HONDA

24.0710-5054.3

360483



Wheel Speed Sensor

L= 555

HONDA

24.0710-5055.3

360484



Wheel Speed Sensor

L= 723

HONDA



24.0710-5056.3

360485



Wheel Speed Sensor

L= 681

HONDA

24.0710-5057.3

360486



Wheel Speed Sensor

L= 542

HONDA

24.0710-5058.3

360487



Wheel Speed Sensor

L= 542

HONDA

24.0711-5457.3

360424



Wheel Speed Sensor

without cable

PORSCHE

24.0711-5506.3

360555



Wheel Speed Sensor

L= 815

LAND ROVER

24.3219-1773.3

020615



Wheel Brake Cylinder

GG

Piston Diameter [mm]: 19

NISSAN

24.3727-0359.2

580359



Cable Pull, parking brake

L= 1,645

CITROËN, MITSUBISHI, PEUGEOT

24.3727-0360.2

580360



Cable Pull, parking brake

L= 1,627

CITROËN, MITSUBISHI, PEUGEOT

24.3727-1836.2

581836



Cable Pull, parking brake

L= 1,940

MAZDA

24.3727-2130.2

582130



Cable Pull, parking brake

L= 2,120

MITSUBISHI



24.4153-0222.3

011047



Brake Master Cylinder

without brake fluid reservoir

ATE

2x

M12x1

L2= 116.8

L1= 38.1

Cast Aluminium

Ø 23.8

SEAT, VW

24.4153-1522.3

011048



Brake Master Cylinder

without brake fluid reservoir

ATE

2x

M12x1

L2= 123.3

L1= 18

Cast Aluminium

Ø 23.8

AUDI, CUPRA, SEAT, SKODA, VW

24.5176-0654.3

331627



Brake Hose

Flange Hole Diameter [mm]: 10

with hollow screw

M10x1,5

L= 654

CHEVROLET, OPEL, VAUXHALL

24.5203-0290.3

331545



Brake Hose

L= 295

Spanner size 1 [mm]: 17

LEXUS, TOYOTA



Brake Hose

Flange Hole Diameter [mm]: 10

without hollow screw

L= 244

Spanner size 1 [mm]: 17

LEXUS, TOYOTA





EN Applications of vehicles

DE Fahrzeugverwendungen











ES Aplicaciones

FR Applications













IT Applicazioni autoveicoli















05/2022































	kW			 	! #		
AUDI - A3 (8V1, 8VK) 04/12→10/20							
 Brake Master Cylinder							
1.0 TFSI 1.2 TFSI 1.4 TFSI 1.4 TSI 1.5 TFSI 1.6 TDI 1.8 TFSI 1.8 TFSI quattro 2.0 TDI 2.0 TDI quattro 2.0 TFSI 2.0 TFSI quattro S3 quattro	85 77 - 81 90 - 103 110 110 77 - 85 132 132 81 - 135 110 - 135 140 140 206 - 228	07/16→12/17 02/13→08/16 04/12→08/16 05/14→12/17 05/17→12/17 10/12→10/20 04/12→08/16 08/12→08/16 04/12→10/20 10/12→12/17 05/16→12/17 05/16→12/17 11/12→12/17		for left-hand drive vehicles		24.4153-1522.3 011048	ATE Ø 23.8 without brake fluid reservoir
AUDI - A3 Convertible (8V7, 8VE) 10/13→							
 Brake Master Cylinder							
1.4 TFSI 1.4 TSI 1.5 TFSI 1.6 TDI 1.8 TFSI 1.8 TFSI quattro 2.0 TDI 2.0 TDI quattro 2.0 TFSI 2.0 TFSI quattro 35 TFSI 40 TFSI 40 TFSI quattro S3 quattro	85 - 103 110 110 81 - 85 125 - 132 132 100 - 135 110 - 135 140 140 162 110 140 140 210 - 228	10/13→ 05/14→10/20 05/17→10/18 02/14→10/20 10/13→10/20 03/14→ 10/13→ 03/14→10/20 05/16→10/20 05/14→10/20 10/18→10/20 11/18→10/20 11/18→10/20 03/14→		for left-hand drive vehicles		24.4153-1522.3 011048	ATE Ø 23.8 without brake fluid reservoir
AUDI - A3 Limousine (8VS, 8VM) 05/13→							
 Brake Master Cylinder							
1.0 TFSI 1.2 TFSI 1.4 TFSI 1.4 TSI 1.5 TFSI 1.6 TDI 1.6 TDI quattro 1.8 TFSI 1.8 TFSI quattro 2.0 TDI 2.0 TDI quattro 2.0 TFSI 2.0 TFSI quattro 30 TDI 30 TFSI 35 TDI 35 TFSI 40 TDI quattro 40 TFSI 40 TFSI quattro RS3 quattro S3 quattro	85 77 - 81 90 - 103 110 110 77 - 85 81 125 - 132 132 81 - 135 110 - 135 140 - 162 140 85 85 110 110 135 140 140 140 294 206 - 228	07/16→10/20 10/13→ 05/13→ 05/14→10/20 05/17→10/18 09/13→ 05/15→ 05/13→ 11/13→ 05/13→ 10/13→10/20 11/15→10/20 05/16→10/20 07/18→10/20 07/18→10/20 07/18→10/20 07/18→10/20 07/18→07/19 07/18→10/20 07/18→10/20 04/17→10/20 10/13→		for left-hand drive vehicles		24.4153-1522.3 011048	ATE Ø 23.8 without brake fluid reservoir





























	kW			 	! #		
AUDI - A3 Sportback (8VA, 8VF) 09/12→							
 Brake Master Cylinder							
1.0 TFSI 1.2 TFSI 1.4 TFSI 1.4 TFSI e-tron 1.4 TFSI g-tron 1.4 TFSI 1.5 TFSI 1.6 TDI 1.6 TDI quattro 1.8 TFSI 1.8 TFSI quattro 2.0 TDI 2.0 TDI quattro 2.0 TFSI 2.0 TFSI quattro 30 g-tron 30 TDI 30 TFSI 35 TDI 35 TFSI 40 TDI quattro 40 TFSI 40 TFSI quattro RS3 quattro S3 quattro	85 77 - 81 90 - 103 110 - 150 81 110 110 77 - 85 81 132 132 81 - 135 110 - 135 140 140 96 85 85 110 110 135 140 140 270 - 294 206 - 228	07/16→10/20 05/13→ 09/12→ 05/14→10/20 11/13→10/20 05/14→10/20 05/17→10/18 10/12→ 05/15→08/16 09/12→ 05/13→ 09/12→10/20 02/13→10/20 05/16→10/20 05/16→10/20 11/18→10/20 07/18→10/20 07/18→10/20 10/18→10/20 07/18→10/20 07/18→10/20 07/18→10/20 03/15→ 11/12→		for left-hand drive vehicles		24.4153-1522.3 011048	ATE Ø 23.8 without brake fluid reservoir
AUDI - Q2 (GAB, GAG) 06/16→							
 Brake Master Cylinder							
1.0 TFSI 2.0 TDI 2.0 TDI quattro 2.0 TFSI quattro 30 TDI 30 TFSI 35 TDI 35 TDI quattro 35 TFSI 40 TFSI quattro SQ2 TFSI quattro 1.4 TFSI 1.6 TDI 2.0 TDI quattro 30 TFSI	85 110 110 140 85 85 110 110 110 140 221 110 85 140 81	10/16→10/20 09/16→ 09/16→ 05/17→ 07/18→ 07/18→10/20 09/16→ 09/18→ 07/18→ 09/18→ 08/18→ 06/16→08/18 06/16→10/18 07/16→08/18 08/20→		for left-hand drive vehicles; → 11/18 for left-hand drive vehicles; 12/18→; +PR 1ZA / 1ZB / 1ZE / 1ZJ / 1ZK / 1ZU for left-hand drive vehicles for left-hand drive vehicles; +PR 1ZA / 1ZB / 1ZE / 1ZJ / 1ZK / 1ZU		24.4153-1522.3 011048 24.4153-1522.3 011048 24.4153-1522.3 011048 24.4153-1522.3 011048	ATE Ø 23.8 without brake fluid reservoir ATE Ø 23.8 without brake fluid reservoir ATE Ø 23.8 without brake fluid reservoir
BMW - 1 (F40) 07/19→							
 Brake Pad Set, disc brake							
M 135 i xDrive	225	07/19→	➔			13.0470-7349.2 LD7349	ATE + WE / - WK Ceramic
BMW - 2 Gran Coupe (F44) 11/19→							
 Brake Pad Set, disc brake							
M 235 i xDrive	225	11/19→	➔			13.0470-7349.2 LD7349	ATE + WE / - WK Ceramic
BMW - X2 (F39) 11/17→							
 Brake Pad Set, disc brake							
M35 i	225	11/18→	➔			13.0470-7349.2 LD7349	ATE + WE / - WK Ceramic
CHEVROLET - CRUZE (J300) 05/09→							
 Brake Hose							
1.4 1.6 1.7 D 1.7 TD 1.8 1.8 LPG ➔	74 - 103 80 - 91 96 81 103 - 104 104	09/10→ 05/09→ 01/12→ 11/13→ 05/09→ 06/11→	➔			24.5176-0654.3 331627	L= 654













	kW			 	! #		
CHEVROLET - CRUZE (J300) 05/09→							
 Brake Hose							
2.0 CDI	92	05/09→	→	<input type="checkbox"/>		24.5176-0654.3 331627	L= 654
2.0 VCDi	120 122	03/12→11/18					
CHEVROLET - CRUZE Hatchback (J305) 12/10→							
 Brake Hose							
1.4	74	06/12→	→	<input type="checkbox"/>		24.5176-0654.3 331627	L= 654
	103						
1.6	80	06/11→					
	91						
1.7 D	96	01/12→12/15					
1.7 TD	81	08/13→12/15					
1.8	103	06/11→					
	104						
1.8 LPG	104	06/11→12/15					
2.0 CDI	120	06/11→					
CHEVROLET - CRUZE Station Wagon (J308) 08/12→							
 Brake Hose							
1.4	74	08/12→	→	<input type="checkbox"/>		24.5176-0654.3 331627	L= 654
	103						
1.6	86	08/12→12/15					
	91						
1.7 TD	81	08/12→					
	96						
1.8	104	08/12→					
2.0 TD	120	08/12→					
CHEVROLET - ORLANDO (J309) 12/10→							
 Brake Hose							
1.4	103	06/12→	→	<input type="checkbox"/>		24.5176-0654.3 331627	L= 654
1.8	104	02/11→					
1.8 LPG	104	06/11→12/15					
2.0 D	96	02/11→					
	120						
2.0 LPG	103	02/12→					
CITROËN - BERLINGO / BERLINGO FIRST Box Body/MPV (M_) 07/96→12/11							
 Wheel Speed Sensor							
Electric	42	01/11→12/11	←	→Orga 13964	2	24.0710-2107.3 360631	L= 711
CITROËN - BERLINGO Box Body/MPV (B9) 04/08→							
 Wheel Speed Sensor							
1.6	66	04/08→	←	→Orga 13964	2	24.0710-2107.3 360631	L= 711
	80						
1.6 BlueHDi 100	73	12/14→					
1.6 BlueHDi 120	88	12/14→					
1.6 HDi 110	80	04/08→					
	82						
1.6 HDi 115	84	07/10→					
1.6 HDi 75	55	04/08→					
1.6 HDi 90	66	07/10→					
	68						
1.6 HDi 90 16V	66	04/08→					
1.6 VTi 120	88	11/09→					
1.6 VTi 95	72	07/10→					
Electric	35	01/13→					
	49						
1.6 BlueHDi 100 4x4	73	12/14→	←	→Orga 14237	2	24.0710-2107.3 360631	L= 711
1.6 HDi 115 4x4	84	02/12→					
1.6 HDi 75 4x4	55	02/12→					
1.6 HDi 90 4x4	66	02/12→					
PureTech 110	81	01/18→					
CITROËN - BERLINGO MULTISPACE (B9) 04/08→							
 Wheel Speed Sensor							
1.6	66	04/08→	←	→Orga 13964	2	24.0710-2107.3 360631	L= 711
	81						
1.6 BlueHDi 100	73	12/14→					
1.6 BlueHDi 120	88	12/14→					
1.6 HDi 110	80	04/08→					
	82						
1.6 HDi 115	84	07/10→					
1.6 HDi 75 16V	55	04/08→					
1.6 HDi 90	66	04/08→					
	68						
→							















	kw					! #		
CITROËN - BERLINGO MULTISPACE (B9) 04/08→								
 Wheel Speed Sensor								
1.6 VTi 120 1.6 VTi 95	88 72	11/09→ 07/10→	←	→Orga 13964	2	24.0710-2107.3	360631	L= 711
1.6 HDi 115 4x4 1.6 HDi 90 4x4 Electric	84 66 49	02/12→ 02/12→12/14 09/17→	←	→Orga 14237	2	24.0710-2107.3	360631	L= 711
CITROËN - BERLINGO Platform/Chassis (B9) 04/08→								
 Wheel Speed Sensor								
1.6 BlueHDi 100 1.6 HDi 90 16V	73 66	12/14→ 04/08→	←	→Orga 13964	2	24.0710-2107.3	360631	L= 711
1.6 HDi 90 1.6 HDi 92	66 68	07/10→ 07/10→12/17	←	→Orga 14237	2	24.0710-2107.3	360631	L= 711
CITROËN - C4 AIRCROSS 08/10→								
 Cable Pull, parking brake								
1.6 1.6 HDi 115 1.8 HDi 150 2.0	86 84 110 110	04/12→ 04/12→ 04/12→ 04/12→		→Orga 13114; <input type="checkbox"/> →Orga 13114; <input type="checkbox"/>		24.3727-0359.2 24.3727-0360.2	580359 580360	L= 1,645 L= 1,627
1.6 HDi 115 AWC 1.8 HDi 150 AWC 2.0 AWC	84 110 110	05/12→ 04/12→ 04/12→		→Orga 13114; <input type="checkbox"/>		24.3727-0359.2	580359	L= 1,645
CITROËN - C4 GRAND PICASSO I (UA_) 10/06→12/13								
 Wheel Speed Sensor								
1.6 16V 1.6 HDi 1.6 HDi 110 1.6 THP 155 1.6 VTi 120 1.8 i 16V 1.8 i 16V CNG 1.8 i 16V Flex 2.0 HDi 138 2.0 HDi 150 2.0 HDi 165 2.0 i 16V	103 - 110 80 82 115 88 92 86 86 100 110 120 103 - 105	07/08→08/13 10/06→06/11 09/10→08/13 09/10→08/13 07/08→08/13 10/06→12/10 03/09→12/11 06/09→01/13 10/06→12/13 07/09→08/13 09/10→08/13 10/06→08/13	←		2	24.0710-2107.3	360631	L= 711
CITROËN - C4 PICASSO I MPV (UD_) 10/06→12/15								
 Wheel Speed Sensor								
1.6 16V 1.6 HDi 1.6 HDi 110 1.6 THP 140 1.6 THP 155 1.6 VTi 120 1.8 Bifuel 1.8 i 16V 2.0 HDi 138 2.0 HDi 150 2.0 HDi 165 2.0 i 16V	110 80 82 103 115 88 92 92 100 110 120 103 - 105	07/08→08/13 02/07→08/13 09/10→08/13 07/08→08/13 09/10→08/13 07/08→08/13 01/09→10/12 02/07→12/11 10/06→08/13 07/09→08/13 09/10→08/13 09/07→08/13	←		2	24.0710-2107.3	360631	L= 711
CITROËN - C-CROSSER (VU_, VV_) 02/07→12/12								
 Cable Pull, parking brake								
2.0 2.0 All-wheel Drive	108 108	11/10→12/12 11/10→12/12		<input type="checkbox"/> <input type="checkbox"/>		24.3727-0359.2 24.3727-0360.2	580359 580360	L= 1,645 L= 1,627
CUPRA - ATECA (KH7, KHP) 09/18→								
 Brake Master Cylinder								
2.0 TSI 4Drive	221 - 257	09/18→		for left-hand drive vehicles		24.4153-1522.3	011048	ATE Ø 23.8 without brake fluid reservoir
DACIA - DUSTER (HM_) 10/17→								
 Wheel Speed Sensor								
1.0 LPG 1.0 TCe 100 1.0 TCe 90 1.2 TCe 125 1.3 TCe 130 1.3 TCe 150	74 74 67 92 96 110	01/19→ 01/19→ 05/21→ 10/17→ 01/19→ 01/19→	→	<input type="checkbox"/>		24.0710-2098.3	360630	L= 594











	kw			 	! #		
DACIA - DUSTER (HM_) 10/17→							
 Wheel Speed Sensor							
1.5 dCi 110 1.5 dCi 115 1.5 dCi 90 1.5 dCi 95 1.6 S Ce 115 1.6 S Ce 115 LPG	80 85 66 70 84 80	10/17→ 10/17→ 10/17→ 10/17→ 10/17→ 10/17→	→	☐		24.0710-2098.3 360630	L= 594
DACIA - DUSTER (HS_) 04/10→01/18							
 Wheel Speed Sensor							
1.2 TCe 125 1.5 dCi 1.6 16V 1.6 16V Hi-Flex 1.6 16V LPG 1.6 S Ce 115 1.6 S Ce 115 LPG	92 63 - 81 77 77 77 84 84	10/13→01/18 04/10→01/18 04/10→01/18 08/10→01/18 04/11→01/18 06/15→01/18 06/15→01/18	→	☐		24.0710-2098.3 360630	L= 594
DACIA - DUSTER SUV Van 04/11→							
 Wheel Speed Sensor							
1.2 TCe 125 4x4 1.5 dCi 1.6 16V 1.6 16V Hi-Flex 1.6 S Ce 115	92 66 - 80 77 77 84	10/13→ 04/11→ 04/11→ 04/11→ 06/15→	→	☐		24.0710-2098.3 360630	L= 594
DACIA - LOGAN II 10/12→							
 Brake Pad Set, disc brake							
1.0 LPG 1.0 S Ce 75 1.0 TCe 100 1.5 Blue dCi 95	74 54 74 70	11/19→ 01/17→ 11/19→ 05/18→	←			13.0460-7332.2 607332	ATE - WE / - WK
1.2 1.2 LPG 1.6	54 - 55 53 - 55 59 - 63	10/12→ 10/12→ 06/13→	←	for individual equipment ID: CTCRO / ENPB01		13.0460-7332.2 607332	ATE - WE / - WK
1.5 dCi 1.5 dCi / Blue dCi 75 1.6 16V TCe 90	63 - 66 55 77 66	10/12→ 04/15→; 10/12→ 01/13→ 10/12→	←	for individual equipment ID: SAN713 / ENPA01 / ENPB01 / ENPE01		13.0460-7332.2 607332	ATE - WE / - WK
TCe 90 LPG	66	09/15→	←	for individual equipment ID: CTCRO / ENPB01		13.0460-7332.2 607332	ATE - WE / - WK
			←	for individual equipment ID: SAN713 / ENPA01 / ENPB01 / ENPE01		13.0460-7332.2 607332	ATE - WE / - WK
DACIA - LOGAN MCV II 02/13→							
 Brake Pad Set, disc brake							
1.0 LPG 1.0 S Ce 75 1.0 TCe 100 1.2 1.5 Blue dCi 95 TCe 90 LPG	74 54 74 54 70 66	11/19→ 12/16→ 11/19→ 05/15→ 10/18→ 09/15→	←			13.0460-7332.2 607332	ATE - WE / - WK
1.2 1.2 LPG 1.5 dCi 1.6 TCe 90	55 53 - 55 66 62 66	02/13→ 02/13→ 02/13→ 06/13→ 02/13→	←	04/15→		13.0460-7332.2 607332	ATE - WE / - WK
DACIA - SANDERO II 10/12→							
 Brake Pad Set, disc brake							
1.0 LPG 1.0 TCe 100 1.5 Blue dCi 95	74 74 70	11/19→ 11/19→ 08/18→	←			13.0460-7332.2 607332	ATE - WE / - WK
1.0 S Ce 75 1.2	54 54	12/16→ 05/15→	←	for individual equipment ID: CTCRO		13.0460-7332.2 607332	ATE - WE / - WK
			←	for individual equipment ID: VSUVE / ENPA01 / ENPB01 / ENPE01		13.0460-7332.2 607332	ATE - WE / - WK
→							















	kW			 	! #		
DACIA - SANDERO II 10/12→							
 Brake Pad Set, disc brake							
1.2 1.2 LPG 1.5 dCi	55 55 63 - 66	10/12→ 10/12→ 10/12→	←	04/15→; for individual equipment ID: ENPA01 / ENPB01 / ENPE01		13.0460-7332.2 607332	ATE - WE / - WK
1.5 dCi 75 / Blue dCi 75 1.6 TCe 90	55 63 66	10/12→ 11/12→ 10/12→	←	for individual equipment ID: CTCRO		13.0460-7332.2 607332	ATE - WE / - WK
TCe 90 LPG	66	09/15→	←	for individual equipment ID: CTCRO		13.0460-7332.2 607332	ATE - WE / - WK
			←	for individual equipment ID: SAN713 / VSUVE / ENPA01 / ENPB01 / ENPE01		13.0460-7332.2 607332	ATE - WE / - WK
FIAT - 500 (312_) 07/07→							
Accessory Kit, brake shoes							
1.0 Mild Hybrid	51	01/20→	→			03.0137-9321.2 669321	
FIAT - 500 C (312_) 09/09→							
Accessory Kit, brake shoes							
1.0 Mild Hybrid	51	01/20→	→			03.0137-9321.2 669321	
FIAT - 500e (332_) 10/20→							
Accessory Kit, brake shoes							
Elektro Elektro 3+1	70 87	10/20→ 10/20→	→			03.0137-9321.2 669321	
FIAT - 500e Convertible (332_) 10/20→							
Accessory Kit, brake shoes							
Elektro	70 - 87	10/20→	→			03.0137-9321.2 669321	
FORD - B-MAX (JK) 10/12→							
 Wheel Speed Sensor							
1.0 EcoBoost	74 - 103	10/12→	→	for vehicles without Active City Stop	2	24.0710-2109.3 360632	L= 660
1.4 1.4 LPG	66 64 - 66	10/12→ 08/13→	→	for vehicles with Active City Stop	2	24.0710-2110.3 360633	L= 660
1.5 TDCi	55 - 70	10/12→					
1.6 TDCi	70	10/12→					
1.6 Ti	77	10/12→					
FORD - B-MAX Van (JK) 08/12→							
 Wheel Speed Sensor							
1.0 EcoBoost	74 - 92	10/12→	→	for vehicles without Active City Stop	2	24.0710-2109.3 360632	L= 660
1.4 1.4 LPG	66 66	10/12→ 10/12→	→	for vehicles with Active City Stop	2	24.0710-2110.3 360633	L= 660
1.5 TDCi	55 - 70	10/12→					
1.6 TDCi	70	10/12→					
1.6 Ti	77	10/12→					
1.0 EcoBoost	88	08/12→	→	10/12→; for vehicles without Active City Stop	2	24.0710-2109.3 360632	L= 660
			→	10/12→; for vehicles with Active City Stop	2	24.0710-2110.3 360633	L= 660
FORD - FIESTA VI (CB1, CCN) 06/08→							
 Wheel Speed Sensor							
1.6 ST 1.6 ST200	134 147	03/13→04/17 04/16→04/17	→		2	24.0710-2109.3 360632	L= 660
FORD - FIESTA VI Van 08/08→							
 Wheel Speed Sensor							
1.6 ST	134	03/13→	→		2	24.0710-2109.3 360632	L= 660
FORD - TOURNEO COURIER B460 MPV 02/14→							
 Wheel Speed Sensor							
1.0 EcoBoost 1.5 EcoBlue 1.5 TDCi	74 74 55 - 70	02/14→ 04/18→ 02/14→	→		2	24.0710-2109.3 360632	L= 660
1.6 TDCi	70	02/14→					

















	kw			 	! #		
FORD - TOURNEO CUSTOM V362 Bus (F3) 04/12→							
 Wheel Speed Sensor							
2.0 EcoBlue	77 - 125	12/15→	←	→ 05/19	2	24.0710-2096.3 360629	L= 323
2.2 TDCi	74 - 114	04/12→12/15	←	05/12→	2	24.0710-2096.3 360629	L= 323
FORD - TRANSIT COURIER B460 Box Body/MPV 02/14→							
 Wheel Speed Sensor							
1.0 EcoBoost 1.5 EcoBlue 1.5 TDCi 1.6 TDCi	74 74 55 - 70 70	02/14→ 04/18→ 02/14→ 02/14→	→		2	24.0710-2109.3 360632	L= 660
FORD - TRANSIT COURIER B460 MPV 02/14→							
 Wheel Speed Sensor							
1.0 EcoBoost 1.5 EcoBlue 1.5 TDCi 1.6 TDCi	74 74 55 - 70 70	02/14→ 04/18→ 02/14→ 02/14→	→		2	24.0710-2109.3 360632	L= 660
FORD - TRANSIT CUSTOM V362 Bus (F3) 04/12→							
 Wheel Speed Sensor							
2.0 EcoBlue	77 - 125	12/15→	←	→ 05/19	2	24.0710-2096.3 360629	L= 323
2.2 TDCi	74 - 114	04/12→12/15	←		2	24.0710-2096.3 360629	L= 323
FORD - TRANSIT CUSTOM V362 Van (FY, FZ) 09/12→							
 Wheel Speed Sensor							
2.0 EcoBlue	77 - 125	12/15→	←	→ 05/19	2	24.0710-2096.3 360629	L= 323
2.2 TDCi	74 - 114	09/12→12/15					
2.2 TDCi	92	09/12→04/16	←		2	24.0710-2096.3 360629	L= 323
FORD - TRANSIT V363 Bus (FAD, FBD) 08/13→							
 Wheel Speed Sensor							
2.0 EcoBlue 2.2 TDCi 2.2 TDCi 4x4 2.2 TDCi All-wheel Drive 2.2 TDCi RWD	77 - 125 74 - 114 92 114 74 - 114	03/16→ 08/13→12/18 08/13→12/18 08/15→12/18 08/13→12/18	←	for single tyres	2	24.0710-2096.3 360629	L= 323
FORD - TRANSIT V363 Platform/Chassis (FED, FFD) 08/13→							
 Wheel Speed Sensor							
2.0 EcoBlue 2.0 EcoBlue 4x4 2.0 EcoBlue RWD 2.2 TDCi 2.2 TDCi 4x4 2.2 TDCi RWD	77 - 125 96 - 125 77 - 125 74 92 - 114 74 - 114	03/16→ 01/17→ 03/16→ 08/13→12/18 08/13→12/18 08/13→12/18	←	for single tyres	2	24.0710-2096.3 360629	L= 323
2.2 TDCi	92 - 114	08/13→12/18	←	05/14→; for single tyres	2	24.0710-2096.3 360629	L= 323
FORD - TRANSIT V363 Van (FCD, FDD) 08/13→							
 Wheel Speed Sensor							
2.0 EcoBlue 2.0 EcoBlue 4x4 2.0 EcoBlue RWD 2.2 TDCi →	77 - 125 96 - 125 77 - 125 74 - 114	03/16→ 01/17→ 03/16→ 08/13→12/18	←	for single tyres	2	24.0710-2096.3 360629	L= 323















	kw					! #		
FORD - TRANSIT V363 Van (FCD, FDD) 08/13→								
 Wheel Speed Sensor								
2.2 TDCi 4x4	92 - 114	08/13→12/18	←	for single tyres		2	24.0710-2096.3 360629	L= 323
2.2 TDCi RWD	74 - 114	08/13→12/18						
HONDA - CIVIC VIII Hatchback (FN, FK) 09/05→								
 Wheel Speed Sensor								
1.4	73	10/08→	←	→ 12/12; ☐			24.0710-5055.3 360484	L= 723
			←	→ 12/12; ☐			24.0710-5056.3 360485	L= 681
			→	→ 12/12; ☐			24.0710-5053.3 360482	L= 555
			→	→ 12/12; ☐			24.0710-5054.3 360483	L= 555
1.4	61	09/05→	←	01/06→ 01/12; ☐			24.0710-5055.3 360484	L= 723
			←	01/06→ 01/12; ☐			24.0710-5056.3 360485	L= 681
			→	01/06→ 01/12; ☐			24.0710-5053.3 360482	L= 555
			→	01/06→ 01/12; ☐			24.0710-5054.3 360483	L= 555
1.8 2.2 CTDi	103 103	09/05→ 09/05→	←	01/06→ 12/12; ☐			24.0710-5055.3 360484	L= 723
			←	01/06→ 12/12; ☐			24.0710-5056.3 360485	L= 681
			→	01/06→ 12/12; ☐			24.0710-5053.3 360482	L= 555
			→	01/06→ 12/12; ☐			24.0710-5054.3 360483	L= 555
2.0 i-VTEC Type R Type R	177 148	03/10→12/10 09/06→	←	☐			24.0710-5055.3 360484	L= 723
			←	☐			24.0710-5056.3 360485	L= 681
			→	☐			24.0710-5053.3 360482	L= 555
			→	☐			24.0710-5054.3 360483	L= 555
HONDA - CIVIC VIII Saloon (FD, FA) 09/05→								
 Wheel Speed Sensor								
2.0 i-VTEC Type R	165	08/07→09/10	←	☐			24.0710-5055.3 360484	L= 723
			←	☐			24.0710-5056.3 360485	L= 681
			→	☐			24.0710-5053.3 360482	L= 555
			→	☐			24.0710-5054.3 360483	L= 555
HONDA - CR-V III (RE_) 06/06→								
 Wheel Speed Sensor								
2.0 i-VTEC	105 - 110	01/07→06/12	→	☐			24.0710-5057.3 360486	L= 542
2.4	124	06/06→	→	☐			24.0710-5058.3 360487	L= 542
2.0 i-VTEC 4WD	110	10/06→06/12	→	01/07→; ☐			24.0710-5057.3 360486	L= 542
			→	01/07→; ☐			24.0710-5058.3 360487	L= 542
2.2 i-CTDi 4WD	103	01/07→	→	→ 09/12; ☐			24.0710-5057.3 360486	L= 542
2.2 i-DTEC 4WD	110	01/07→	→	→ 09/12; ☐			24.0710-5058.3 360487	L= 542
2.4	125	04/07→						
2.4 i-Vtec 4WD	125	04/07→						
2.4 i-VTEC 4WD	122	09/09→						
2.4 4WD	124	09/06→	→	09/07→ 09/12; ☐			24.0710-5057.3 360486	L= 542
			→	09/07→ 09/12; ☐			24.0710-5058.3 360487	L= 542
2.4 i-VTEC 4WD	118	10/06→	→	01/07→ 09/12; ☐			24.0710-5057.3 360486	L= 542
			→	01/07→ 09/12; ☐			24.0710-5058.3 360487	L= 542
HYUNDAI - ix20 (JC) 11/10→								
 Brake Pad Set, disc brake								
1.4	66 - 74	11/10→	→				13.0470-5781.2 LD5781	MAN + WK + Zub Ceramic
1.4 CRDi	57 - 66	11/10→						
1.4 LPG	66	11/10→						
1.6	92	11/10→						
1.6 CRDI	85 - 94	06/11→						
1.6 LPG	92	11/10→						

















	kw			 	! #		
HYUNDAI - KONA (OS, OSE, OSI) 06/17→							
 Brake Pad Set, disc brake							
1.0 T-GDi 1.6 CRDi 1.6 CRDi e-VGT 1.6 CRDi e-VGT AWD 1.6 T-GDi	88 85 100 100 130	07/17→ 08/18→ 07/17→ 07/17→ 07/17→	➔			13.0470-5781.2 LD5781	MAN + WK + Zub Ceramic
1.0 T-GDi Hybrid 48V 1.6 CRDi Hybrid 48V 1.6 CRDi Hybrid 48V 4WD 1.6 T-GDi 4WD	88 100 100 130	11/20→ 11/20→ 11/20→ 06/17→	➔	- eFSB		13.0470-5781.2 LD5781	MAN + WK + Zub Ceramic
1.6 T-GDi 1.6 T-GDi 4WD	146 146	11/20→ 11/20→	➔	- eFSB; Brake Size: 15"		13.0470-5781.2 LD5781	MAN + WK + Zub Ceramic
HYUNDAI - KONA SUV Van (OS, OSE, OSI) 06/17→							
 Brake Pad Set, disc brake							
1.0 T-GDi	88	07/17→	➔			13.0470-5781.2 LD5781	MAN + WK + Zub Ceramic
HYUNDAI - SANTA FE IV (TM, TMA) 02/18→							
 Brake Pad Set, disc brake							
2.0 AWD 2.0 T-GDi 3.5 MPI AWD	173 173 183	02/18→ 02/18→ 07/19→	➔	→ 12/19; Brake Size: 17"		13.0470-5681.2 LD5681	Mobis + WK + Zub Ceramic
2.0 CRDi 2.0 CRDi AWD 2.2 CRDi 2.2 CRDi AWD 2.4 2.4 AWD 2.4 GDI 2.4 GDI AWD	110 - 137 110 - 137 147 147 127 127 138 136 - 138	02/18→ 02/18→ 07/18→ 07/18→ 07/18→ 07/18→ 07/18→ 07/18→	➔	Brake Size: 17"		13.0470-5681.2 LD5681	Mobis + WK + Zub Ceramic
HYUNDAI - SANTA FE IV SUV Van (TM) 02/18→							
 Brake Pad Set, disc brake							
2.2 CRDi 2.2 CRDi AWD	147 147	07/18→ 07/18→	➔	Brake Size: 17"		13.0470-5681.2 LD5681	Mobis + WK + Zub Ceramic
HYUNDAI - TUCSON (TL, TLE) 05/15→							
 Brake Pad Set, disc brake							
1.6 GDi	97	06/15→09/20	➔	- eFSB		13.0470-5781.2 LD5781	MAN + WK + Zub Ceramic
JAGUAR - XE (X760) 03/15→							
 Brake Disc							
2.0 2.0 AWD 2.0 D 2.0 D AWD	147 - 184 184 120 - 132 132 - 177	03/15→ 02/17→ 03/15→ 10/15→	➔	Brake Size: 16.5"		24.0128-0328.1 428328	Ø 316 Brake Disc Thickness [mm] 28 Minimum thickness [mm] 26 Vented
KIA - PICANTO II (TA) 05/11→05/17							
 Brake Pad Set, disc brake							
1.0 1.0 Bi-Fuel 1.0 Flex 1.0 LPG 1.2	49 - 51 60 59 49 63 - 64	05/11→03/17 05/11→10/14 08/11→03/17 08/13→03/17 09/11→03/17	➔			13.0470-5781.2 LD5781	MAN + WK + Zub Ceramic
KIA - SORENTO III (UM) 01/15→							
 Brake Pad Set, disc brake							
2.0 CRDi 2.0 CRDi 4WD 2.0 CRDi 4WD 2.2 CRDi 2.2 CRDi 4WD 2.2 CRDi 4WD	136 - 137 137 136 143 - 147 147 145	07/15→ 07/15→ 07/15→ 01/15→ 01/15→ 11/16→	➔	Rim Size [in]: 17		13.0470-5681.2 LD5681	Mobis + WK + Zub Ceramic













	kw			 	! #		
KIA - SORENTO III (UM) 01/15→							
 Brake Pad Set, disc brake							
2.4	126 - 129	01/15→	←	Rim Size [in]: 17		13.0470-5681.2 LD5681	Mobis + WK + Zub Ceramic
2.4 4WD	126 - 129	01/15→					
2.4 GDI	138	01/15→					
2.4 GDI 4WD	138	01/15→					
3.5 D-CVVT	183 - 203	07/17→					
3.5 D-CVVT 4WD	183	12/18→					
2.2 CRDi 4WD	149	01/15→	←	Brake Size: 17"		13.0470-5681.2 LD5681	Mobis + WK + Zub Ceramic
2.2 CRDi 4WD	142	11/16→	←			13.0470-5681.2 LD5681	Mobis + WK + Zub Ceramic
3.3	199	04/15→					
3.3 4WD	196 - 199	01/15→					
3.3 CVVT 4WD	184	04/15→					
3.5 D-CVVT 4WD	203	07/17→					
LADA - VESTA (GFL_) 11/15→							
Accessory Kit, brake shoes							
1.6	75 - 83	11/15→	→			03.0137-9321.2 669321	
1.6 CNG	78	08/17→					
1.8	90	06/16→					
1.8 Sport	107	02/19→					
LADA - VESTA SW Estate (GFK_) 11/15→							
Accessory Kit, brake shoes							
1.6	75 - 83	11/15→	→			03.0137-9321.2 669321	
1.8	90	07/16→					
Cross 1.6	75	11/18→					
LAND ROVER - DISCOVERY SPORT (L550) 09/14→							
 Wheel Speed Sensor							
1.5 P300e Hybrid 4x4	147 - 227	02/20→	←	→ KH999999	2	24.0711-5506.3 360555	L= 815
2.0 4x4	176 - 213	11/14→					
2.0 D	110	08/15→					
2.0 D150 MHEV 4x4	110	05/19→					
2.0 D165	120	07/20→					
2.0 D165 MHEV 4x4	120	07/20→					
2.0 D180 MHEV 4x4	132	05/19→					
2.0 D200 MHEV 4x4	150	07/20→					
2.0 D240 MHEV 4x4	177	05/19→					
2.0 D 4x4	110 - 177	12/14→					
2.0 P200 4x4	147	07/20→					
2.0 P200 FLEX MHEV 4x4	147	09/20→					
2.0 P200 MHEV 4x4	147	05/19→					
2.0 P250 4x4	183	05/19→					
2.0 P250 MHEV 4x4	184	05/19→					
2.0 P290 MHEV 4x4	213	07/20→					
2.0 Si4 FLEX 4x4	177	12/18→					
2.2 D 4x4	110 - 140	09/14→					
LAND ROVER - DISCOVERY SPORT VAN (L550) 09/14→							
 Wheel Speed Sensor							
eD4 E-Capability SD4 4x4	110 - 177	08/15→ 06/15→	←	→ KH999999	2	24.0711-5506.3 360555	L= 815
Si4 4x4	177 - 213	01/17→					
TD4 4x4	110 - 132	12/14→					
LAND ROVER - RANGE ROVER EVOQUE (L538) 06/11→12/19							
 Wheel Speed Sensor							
2.0 4x4	176 - 213	06/11→12/19	←		2	24.0711-5506.3 360555	L= 815
2.0 D	110	06/15→12/19					
2.0 D 4x4	110 - 177	05/15→12/19					
2.2 D	110	06/11→12/19					
2.2 D 4x4	110 - 140	06/11→12/19					















	kw			 	! #		
LAND ROVER - RANGE ROVER EVOQUE Convertible (L538) 11/15→12/19							
 Wheel Speed Sensor							
2.0 4x4 2.0 D 4x4	177 110 - 177	11/15→12/19 11/15→12/19	←		2	24.0711-5506.3 360555	L= 815
LAND ROVER - RANGE ROVER EVOQUE VAN (L538) 06/11→12/19							
 Wheel Speed Sensor							
SD4 4x4 Si4 4x4 TD4 TD4 4x4	140 177 110 110	05/15→12/19 09/13→12/19 05/15→12/19 05/15→12/19	←		2	24.0711-5506.3 360555	L= 815
LEXUS - GX (URJ15_, GRJ15_) 11/09→							
 Brake Hose							
460 4WD	218 - 225	01/10→	→	inner	2	24.5203-0290.3 331545	L= 295
			→	<input type="checkbox"/> / Outer		24.5296-0253.3 331547	L= 244
MAZDA - 6 Estate (GJ, GL) 08/12→							
 Cable Pull, parking brake							
2.0 2.2 D 2.2 D 4WD 2.2 D AWD	107 - 121 110 - 129 129 110 - 129	12/12→ 08/12→ 07/14→ 12/12→		Disc Brake; <input type="checkbox"/>		24.3727-1836.2 581836	L= 1,940
MAZDA - 6 Estate Van (GJ) 01/13→05/16							
 Cable Pull, parking brake							
2.0 2.2 D 2.2 D AWD 2.5	107 - 121 110 - 129 110 - 129 141	04/15→05/16 04/15→05/16 01/13→05/16 04/15→05/16		for left-hand drive vehicles; - eFSB; <input type="checkbox"/>		24.3727-1836.2 581836	L= 1,940
MAZDA - 6 Saloon (GJ, GL) 12/12→							
 Cable Pull, parking brake							
2.0 2.2 D 2.2 D 4WD	107 - 121 110 - 129 129	01/13→ 12/12→ 07/14→		Disc Brake; <input type="checkbox"/>		24.3727-1836.2 581836	L= 1,940
MERCEDES-BENZ - A-CLASS (W177) 03/18→							
 Brake Disc							
A 160 A 180	80 100	06/18→ 06/18→	←	for vehicles without AMG sports package; for vehicles without sports brake system; Vehicle Main Current: for vehicles with 12V main current		24.0124-0265.1 424265	Ø 295 Brake Disc Thickness [mm] 24 Minimum thickness [mm] 21.4 Vented + S
A 160 d A 180 d	70 85	05/19→ 03/18→	←	for vehicles without AMG sports package; for vehicles without sports brake system		24.0124-0265.1 424265	Ø 295 Brake Disc Thickness [mm] 24 Minimum thickness [mm] 21.4 Vented + S
MERCEDES-BENZ - A-CLASS Saloon (V177) 09/18→							
 Brake Disc							
A 160 d A 180 d	70 85	10/19→ 09/18→	←	for vehicles without AMG sports package; for vehicles without sports brake system		24.0124-0265.1 424265	Ø 295 Brake Disc Thickness [mm] 24 Minimum thickness [mm] 21.4 Vented + S
A 180	100	04/19→	←	for vehicles without AMG sports package; for vehicles without sports brake system; Vehicle Main Current: for vehicles with 12V main current		24.0124-0265.1 424265	Ø 295 Brake Disc Thickness [mm] 24 Minimum thickness [mm] 21.4 Vented + S

















	kW					! #		
MERCEDES-BENZ - B-CLASS Sports Tourer (W247) 12/18→								
 Brake Disc								
B 160 B 160 d B 180 B 180 d	80 70 100 85	04/19→ 05/19→ 12/18→ 12/18→	←	for vehicles without AMG sports package; for vehicles without sports brake system		24.0124-0265.1	424265	Ø 295 Brake Disc Thickness [mm] 24 Minimum thickness [mm] 21.4 Vented + S
MERCEDES-BENZ - CITAN Box Body/MPV (W415) 11/12→08/21								
 Wheel Speed Sensor								
108 CDI 109 CDI 111 CDI 112	55 - 59 66 - 70 81 - 85 84	11/12→08/21 11/12→08/21 06/13→08/21 06/13→08/21	→	Rim Size [in]: 15 / 16; ☐		24.0710-2111.3	360634	L= 1,630
MERCEDES-BENZ - CITAN Mixto (Double Cabin) (W415) 11/12→08/21								
 Wheel Speed Sensor								
109 CDI 111 CDI	66 81	11/12→08/21 06/13→08/21	→	Rim Size [in]: 15 / 16; ☐		24.0710-2111.3	360634	L= 1,630
MERCEDES-BENZ - CITAN MPV (W415) 11/12→08/21								
 Wheel Speed Sensor								
108 CDI 109 CDI 111 CDI 112	55 - 59 66 - 70 81 - 85 84	11/12→08/21 11/12→08/21 06/13→08/21 06/13→08/21	→	Rim Size [in]: 15 / 16; ☐		24.0710-2111.3	360634	L= 1,630
MERCEDES-BENZ - CLA (C118) 03/19→								
 Brake Disc								
CLA 180	100	03/19→	←	for vehicles without AMG sports package; for vehicles without sports brake system; Vehicle Main Current: for vehicles with 12V main current		24.0124-0265.1	424265	Ø 295 Brake Disc Thickness [mm] 24 Minimum thickness [mm] 21.4 Vented + S
CLA 180 d	85	03/19→	←	for vehicles without AMG sports package; for vehicles without sports brake system		24.0124-0265.1	424265	Ø 295 Brake Disc Thickness [mm] 24 Minimum thickness [mm] 21.4 Vented + S
MERCEDES-BENZ - CLA Shooting Brake (X118) 06/19→								
 Brake Disc								
CLA 180	100	06/19→	←	for vehicles without AMG sports package; for vehicles without sports brake system; Vehicle Main Current: for vehicles with 12V main current		24.0124-0265.1	424265	Ø 295 Brake Disc Thickness [mm] 24 Minimum thickness [mm] 21.4 Vented + S
MINI - MINI CLUBMAN (F54) 11/14→								
 Brake Pad Set, disc brake								
John Cooper Works	225	07/19→	→			13.0470-7349.2	LD7349	ATE + WE / - WK Ceramic
MINI - MINI COUNTRYMAN (F60) 10/16→								
 Brake Pad Set, disc brake								
John Cooper Works ALL4	225	07/19→	→			13.0470-7349.2	LD7349	ATE + WE / - WK Ceramic
MITSUBISHI - ASX (GA_W_) 11/09→								
 Wheel Speed Sensor								
1.6 LPG 1.6 MIVEC 1.8 1.8 DI-D 2.0 MIVEC 1.6 MIVEC	86 86 102 85 - 110 110 85	06/10→ 06/10→ 02/10→ 06/10→ 06/10→ 05/10→	→	→ 06/12; ☐		24.0710-5050.3	360479	L= 1,010
			→	→ 06/12; ☐		24.0710-5051.3	360480	L= 1,053
			→	06/10→ 06/12; ☐		24.0710-5050.3	360479	L= 1,010
→			→	06/10→ 06/12; ☐		24.0710-5051.3	360480	L= 1,053















	kw			 	! #		
MITSUBISHI - ASX (GA_W_) 11/09→							
 Cable Pull, parking brake							
1.6 LPG	86	06/10→		→ 06/12; Disc Brake; <input type="checkbox"/>		24.3727-0359.2 580359	L= 1,645
1.6 MIVEC	86	06/10→		→ 06/12; Disc Brake; <input type="checkbox"/>		24.3727-0360.2 580360	L= 1,627
1.8	102	02/10→					
1.8 DI-D	85 -	06/10→					
	110						
1.8 DI-D 4WD	85 -	06/10→					
	110						
2.0 MIVEC	110	06/10→					
2.0 MIVEC 4WD	110	06/10→					
1.6 MIVEC	85	05/10→		06/10→ 06/12; Disc Brake; <input type="checkbox"/>		24.3727-0359.2 580359	L= 1,645
				06/10→ 06/12; Disc Brake; <input type="checkbox"/>		24.3727-0360.2 580360	L= 1,627
MITSUBISHI - ASX Van (GA_W_) 06/10→							
 Cable Pull, parking brake							
1.8 DI-D 4WD	110	06/10→		→ 06/12; Disc Brake; <input type="checkbox"/>		24.3727-0359.2 580359	L= 1,645
				→ 06/12; Disc Brake; <input type="checkbox"/>		24.3727-0360.2 580360	L= 1,627
MITSUBISHI - GRANDIS (NA_W_) 03/03→12/11							
 Cable Pull, parking brake							
2.0 DI-D	100 -	09/05→03/10		Disc Brake; <input type="checkbox"/>		24.3727-2130.2 582130	L= 2,120
	103						
2.4 MIVEC	121 -	04/04→12/11					
	130						
2.4 MIVEC 4WD	121	04/04→12/11					
MITSUBISHI - LANCER VII (CS_A, CT_A) 03/00→12/13							
 Wheel Speed Sensor							
2.0	92	08/05→12/13	➡	+ RUS; <input type="checkbox"/>		24.0710-5050.3 360479	L= 1,010
2.0 GDi	92	09/03→12/13					
2.0 i	113	10/07→12/13	➡	+ RUS; <input type="checkbox"/>		24.0710-5051.3 360480	L= 1,053
MITSUBISHI - LANCER VIII (CY_A, CZ_A) 03/07→							
 Wheel Speed Sensor							
1.5	80	06/08→	➡	<input type="checkbox"/>		24.0710-5050.3 360479	L= 1,010
1.5 Bifuel	80	02/10→					
1.6 MIVEC	86	05/10→	➡	<input type="checkbox"/>		24.0710-5051.3 360480	L= 1,053
1.8	103 -	02/08→					
	105						
1.8 Bifuel	105	01/10→					
1.8 DI-D	85 -	05/10→					
	110						
1.8 Flexfuel	103 -	03/09→					
	105						
1.8 Mivec	110	11/09→					
2.0	108	01/09→					
2.0 DI-D	103	01/08→					
2.0 i	113	04/07→					
MITSUBISHI - LANCER VIII Sportback (CX_A) 10/07→							
 Wheel Speed Sensor							
1.5	80	06/08→	➡	<input type="checkbox"/>		24.0710-5050.3 360479	L= 1,010
1.5 Bifuel	80	03/10→					
1.6 MIVEC	86	05/10→	➡	<input type="checkbox"/>		24.0710-5051.3 360480	L= 1,053
1.8	105	06/08→					
1.8 Bifuel	105	02/10→					
1.8 DI-D	85 -	05/10→					
	110						
1.8 Flex	103	03/09→					
1.8 MIVEC	103	03/09→					
2.0 DI-D	103	06/08→					
MITSUBISHI - OUTLANDER II (CW_W_) 11/06→12/12							
 Wheel Speed Sensor							
2.0	108	11/06→11/12	➡	<input type="checkbox"/>		24.0710-5050.3 360479	L= 1,010
2.0 4WD	108	11/06→11/12	➡	<input type="checkbox"/>		24.0710-5051.3 360480	L= 1,053
2.2 DI-D	130	11/06→11/12	➡	for vehicles without 3rd seating row; <input type="checkbox"/>		24.0710-5050.3 360479	L= 1,010
			➡	for vehicles without 3rd seating row; <input type="checkbox"/>		24.0710-5051.3 360480	L= 1,053
 Cable Pull, parking brake							
2.0	108	11/06→11/12		Disc Brake; <input type="checkbox"/>		24.3727-0359.2 580359	L= 1,645
2.0 4WD	108	11/06→11/12		Disc Brake; <input type="checkbox"/>		24.3727-0360.2 580360	L= 1,627
→							











	kw					! #		
MITSUBISHI - OUTLANDER II (CW_W) 11/06→12/12								
 Cable Pull, parking brake								
2.0 DI-D	103	02/07→11/12		Disc Brake; Number of seats: 5; <input type="checkbox"/>		24.3727-0359.2	580359	L= 1,645
2.2 DI-D	130	11/06→11/12		Disc Brake; Number of seats: 5; <input type="checkbox"/>		24.3727-0360.2	580360	L= 1,627
2.2 DI-D 4WD	103 - 130	11/06→11/12						
2.4 4WD	125	09/07→11/12						
2.4 Flex 4WD	125	09/07→11/12						
MITSUBISHI - OUTLANDER II Van (CW_W) 11/06→12/12								
 Wheel Speed Sensor								
Di-D 4WD	103	12/06→06/10	➔	<input type="checkbox"/>		24.0710-5050.3	360479	L= 1,010
			➔	<input type="checkbox"/>		24.0710-5051.3	360480	L= 1,053
 Cable Pull, parking brake								
Di-D 4WD	103 - 130	12/06→12/12		Disc Brake; Number of seats: 5; <input type="checkbox"/>		24.3727-0359.2	580359	L= 1,645
				Disc Brake; Number of seats: 5; <input type="checkbox"/>		24.3727-0360.2	580360	L= 1,627
NISSAN - JUKE (F15) 06/10→								
 Wheel Brake Cylinder								
1.2 DIG-T	85	05/14→	➔		2	24.3219-1773.3	020615	GG
1.5 dCi	81	06/10→						
1.6	69 - 86	06/10→						
1.6 CVTC	72	08/14→						
1.6 LPG	80 - 85	01/12→						
NISSAN - JUKE Van (F15) 06/10→								
 Wheel Brake Cylinder								
CVTC	86	03/13→	➔		2	24.3219-1773.3	020615	GG
dCi	81	06/10→						
NISSAN - SENTRA VI (B16) 09/06→12/13								
 Wheel Brake Cylinder								
2.0	104	10/06→12/12	➔		2	24.3219-1773.3	020615	GG
NISSAN - SENTRA VII (B17) 08/12→								
 Wheel Brake Cylinder								
1.8	96	08/12→	➔	Vehicle Production Country Japan	2	24.3219-1773.3	020615	GG
NISSAN - TIIDA Hatchback (C12) 08/10→								
 Wheel Brake Cylinder								
1.8	96	08/12→	➔		2	24.3219-1773.3	020615	GG
OPEL - ASTRA J (P10) 09/09→10/15								
 Brake Hose								
1.3 CDTi	70	12/09→10/15	➔	<input type="checkbox"/>		24.5176-0654.3	331627	L= 654
1.4	64 - 74	12/09→10/15						
1.4 LPG	103	01/12→10/15						
1.4 Turbo	88 - 103	12/09→10/15						
1.6	85	12/09→10/15						
1.6 CDTi	81 - 100	11/13→10/15						
1.6 SIDI	125	12/12→10/15						
1.6 Turbo	132	12/09→10/15						
1.6 Turbo 4x4	132	12/09→10/15						
1.7 CDTi	81 - 96	09/09→10/15						
2.0 BiTurbo CDTi	143	09/12→10/15						
2.0 CDTi	96 - 121	09/09→10/15						
OPEL - ASTRA J Estate Van (P10) 09/09→10/15								
 Brake Hose								
1.3 CDTi	70	10/12→10/15	➔	<input type="checkbox"/>		24.5176-0654.3	331627	L= 654
1.6 CDTi	81	01/14→10/15						
1.7 CDTi	96	10/12→10/15						
2.0 CDTi	121	10/12→10/15						











	kW			 	! #		
OPEL - ASTRA J GTC 10/11→							
 Brake Hose							
1.4	74	10/11→	→	<input type="checkbox"/>		24.5176-0654.3 331627	L= 654
1.6	103	10/11→					
1.6 CDTI	81	07/14→					
	100						
1.6 SIDI	125	12/12→					
	147						
1.7 CDTI	81	10/11→10/15					
	96						
1.8	103	10/11→10/15					
2.0 BiTurbo CDTI	143	10/12→10/15					
2.0 CDTI	96	10/11→10/15					
	121						
2.0	206	04/12→	→	<input type="checkbox"/>	06/12→; <input type="checkbox"/>	24.5176-0654.3 331627	L= 654
OPEL - ASTRA J Hatchback Van (P10) 09/09→10/15							
 Brake Hose							
1.3 CDTi	70	05/13→10/15	→	<input type="checkbox"/>		24.5176-0654.3 331627	L= 654
1.6 CDTi	81	01/14→10/15					
1.7 CDTi	81	05/13→10/15					
OPEL - ASTRA J Saloon 06/12→							
 Brake Hose							
1.3 CDTI	70	06/12→10/15	→	<input type="checkbox"/>		24.5176-0654.3 331627	L= 654
1.4	64	06/12→10/15					
	74						
1.4 LPG	103	07/14→					
1.4 Turbo	88	06/12→					
	103						
1.6	85	06/12→					
1.6 CDTi	81	01/14→					
	100						
1.6 SIDI	125	06/12→10/15					
1.6 Turbo	132	06/12→					
1.7 CDTI	74	06/12→10/15					
	96						
OPEL - ASTRA J Sports Tourer (P10) 10/10→10/15							
 Brake Hose							
1.3 CDTI	70	10/10→10/14	→	<input type="checkbox"/>		24.5176-0654.3 331627	L= 654
1.4	64	10/10→10/15					
	74						
1.4 LPG	103	12/11→10/15					
1.4 Turbo	88	10/10→10/15					
	103						
1.6	85	10/10→10/15					
1.6 CDTi	81	11/13→10/15					
	100						
1.6 SIDI	125	12/12→10/15					
1.6 Turbo	132	10/10→10/15					
1.7 CDTI	74	10/10→10/15					
	96						
2.0 BiTurbo CDTI	143	09/12→10/15					
2.0 CDTI	96	10/10→10/15					
	121						
OPEL - CASCADA (W13) 03/13→04/19							
 Brake Hose							
1.4	88	04/13→04/18	→	<input type="checkbox"/>		24.5176-0654.3 331627	L= 654
1.4 Turbo	103	03/13→04/18					
1.6	100	11/13→04/19					
	147						
1.6 SIDI	125	04/13→04/19					
2.0 CDTI	121	04/13→04/18					
	143						
OPEL - ZAFIRA TOURER C (P12) 10/11→							
 Brake Hose							
1.4	88	10/11→	→	<input type="checkbox"/>		24.5176-0654.3 331627	L= 654
	103						
1.4 LPG	103	10/11→					
1.6	100	12/12→					
	125						
1.6 CDTI	88	02/13→					
	100						
1.6 CNG	110	10/11→					
1.6 SIDI	147	07/13→					
→							















	kW					! #		
OPEL - ZAFIRA TOURER C (P12) 10/11→								
 Brake Hose								
1.8 2.0 BiTurbo CDTi 2.0 CDTi	85 - 103 143 81 - 125	10/11→ 01/13→ 10/11→	→	<input type="checkbox"/>			24.5176-0654.3 331627	L= 654
OPEL - ZAFIRA TOURER C VAN (P12) 10/11→								
 Brake Hose								
2.0 CDTi	81 - 121	01/12→	→	<input type="checkbox"/>			24.5176-0654.3 331627	L= 654
PEUGEOT - 4007 (VU_, VV_) 02/07→03/13								
 Cable Pull, parking brake								
2.0	108	11/10→03/13		→ 11/12; <input type="checkbox"/>			24.3727-0359.2 580359	L= 1,645
				→ 11/12; <input type="checkbox"/>			24.3727-0360.2 580360	L= 1,627
2.0 4x4	108	11/10→03/13		→ 11/12; <input type="checkbox"/>			24.3727-0359.2 580359	L= 1,645
PEUGEOT - 4008 05/12→								
 Cable Pull, parking brake								
1.6 1.6 HDi 1.8 HDi 2.0	86 84 110 110	05/12→ 05/12→ 05/12→ 05/13→		→Orga 13114; <input type="checkbox"/>			24.3727-0359.2 580359	L= 1,645
				→Orga 13114; <input type="checkbox"/>			24.3727-0360.2 580360	L= 1,627
1.6 HDi AWC 1.8 HDi AWC 2.0 AWC	84 110 110	05/12→ 05/12→ 05/12→		→Orga 13114; <input type="checkbox"/>			24.3727-0359.2 580359	L= 1,645
PEUGEOT - PARTNER Box Body/MPV 04/08→								
 Wheel Speed Sensor								
1.2 THP 1.6 1.6 BlueHDi 100 1.6 BlueHDi 120 1.6 HDi 1.6 HDi / BlueHDi 75 1.6 HDi 16V 1.6 HDi 16V 4x4 1.6 HDi 90 Électrique	81 66 - 88 73 88 55 - 84 55 66 - 68 66 68 68 49	02/16→ 04/08→ 04/15→ 04/15→ 04/08→ 07/11→ 04/08→ 04/12→ 04/10→ 06/13→	←	→Orga 14237		2	24.0710-2107.3 360631	L= 711
PEUGEOT - PARTNER Platform/Chassis 01/09→								
 Wheel Speed Sensor								
1.6 BlueHDi 100 1.6 HDi 1.6 HDi 16V	73 55 - 66 66	04/15→ 01/09→ 01/09→	←	→Orga 14237		2	24.0710-2107.3 360631	L= 711
PEUGEOT - PARTNER TEEPEE 04/08→								
 Wheel Speed Sensor								
1.2 THP 1.6 BlueHDi 100 1.6 BlueHDi 100 4x4 1.6 BlueHDi 120 1.6 HDi 1.6 HDi / BlueHDi 75 1.6 HDi 16V 1.6 HDi 75 1.6 HDi 90 1.6 VTi Électrique	81 73 73 88 66 - 84 55 66 55 68 66 - 88 49	02/16→ 12/14→ 04/15→ 12/14→ 04/08→ 06/08→12/18 04/08→ 06/08→ 04/10→ 04/08→ 06/13→	←	→Orga 14237		2	24.0710-2107.3 360631	L= 711
PORSCHE - MACAN (95B) 02/14→								
 Wheel Speed Sensor								
2.0 2.9 Turbo AWD 3.0 GTS 3.0 S →	174 - 185 324 265 250 - 260	07/14→ 05/18→ 10/15→09/18 02/14→	←	<input type="checkbox"/>			24.0711-5457.3 360424	
			→	<input type="checkbox"/>			24.0711-5457.3 360424	













	kw			 	! #		
PORSCHE - MACAN (95B) 02/14→							
 Wheel Speed Sensor							
3.0 S Diesel	155 - 190	02/14→09/18	←	<input type="checkbox"/>		24.0711-5457.3	360424
3.6 Turbo	294 - 324	02/14→	→	<input type="checkbox"/>		24.0711-5457.3	360424
GTS	280	12/19→					
2.0	195	05/18→	→	<input type="checkbox"/>		24.0711-5457.3	360424
RENAULT - ARKANA I (LCM_, LDN_) 03/19→							
 Wheel Speed Sensor							
1.3 TCe 150 1.6	110 84	08/19→ 08/19→	→	<input type="checkbox"/>		24.0710-2098.3	360630 L= 594
RENAULT - CLIO IV (BH_) 11/12→							
 Brake Pad Set, disc brake							
0.9 TCe 75 0.9 TCe 90 LPG 1.2 16V	56 66 55	05/18→ 06/16→ 06/15→	←		Rim Size [in]: 15 / 16	13.0460-7332.2	607332 ATE - WE / - WK
0.9 TCe 90 1.2 16V 1.2 LPG 1.2 LPG 16V 1.5 dCi 75	66 54 53 54 55	11/12→ 11/12→ 01/14→ 11/12→06/15 11/12→	←		04/15→; Rim Size [in]: 15 / 16	13.0460-7332.2	607332 ATE - WE / - WK
1.5 dCi 1.5 dCi 90	62 - 63 66	11/12→ 11/12→	←		Manual Transmission; 04/15→; Rim Size [in]: 15 / 16	13.0460-7332.2	607332 ATE - WE / - WK
RENAULT - CLIO IV Hatchback Van (BH_) 01/14→							
 Brake Pad Set, disc brake							
0.9 TCe 90 1.2 16V	66 54 - 55	01/14→ 01/14→	←		04/15→; Rim Size [in]: 15 / 16	13.0460-7332.2	607332 ATE - WE / - WK
1.2 16V LPG 1.5 dCi 75	53 55	01/14→ 01/14→					
0.9 TCe 90 LPG 1.5 dCi 90	66 66	08/15→ 01/14→	←		Rim Size [in]: 15 / 16 Manual Transmission; 04/15→; Rim Size [in]: 15 / 16	13.0460-7332.2	607332 ATE - WE / - WK
RENAULT - DUSTER (HM_) 10/17→							
 Wheel Speed Sensor							
1.5 dCi 110 1.6 SCe 115	80 84	07/19→ 07/19→	→	<input type="checkbox"/>		24.0710-2098.3	360630 L= 594
RENAULT - DUSTER (HS_) 01/11→							
 Wheel Speed Sensor							
1.5 dCi 1.6 16V 2.0	63 75 - 84 98 - 105	02/12→ 02/12→ 10/11→	→	<input type="checkbox"/>		24.0710-2098.3	360630 L= 594
RENAULT - KAPTUR (H5_) 03/16→							
 Wheel Speed Sensor							
1.3 TCe 150 1.6	110 84	10/21→ 03/16→	→	<input type="checkbox"/>		24.0710-2098.3	360630 L= 594
RENAULT - LOGAN II Estate (K8_) 11/13→							
 Brake Pad Set, disc brake							
1.6	78	12/13→	←		04/15→; for individual equipment ID: SAN713 / ENPA01 / ENPB01 / ENPE01	13.0460-7332.2	607332 ATE - WE / - WK
			←		for individual equipment ID: CTCRO / ENPB01	13.0460-7332.2	607332 ATE - WE / - WK
RENAULT - SANDERO/STEPWAY II (B8_) 11/13→							
 Brake Pad Set, disc brake							
1.2 16V TCe 90	55 66	04/15→ 09/15→	←		VSUVE for individual equipment ID: SAN713 / VSUVE / ENPA01 / ENPB01 / ENPE01	13.0460-7332.2	607332 ATE - WE / - WK
			←		for individual equipment ID: CTCRO	13.0460-7332.2	607332 ATE - WE / - WK















	kW					! #		
RENAULT - THALIA III (L8_) 12/13→								
 Brake Pad Set, disc brake								
1.0 SCe 1.5 dCi	54 70	01/17→ 11/19→				13.0460-7332.2	607332	ATE - WE / - WK
SEAT - ALHAMBRA (710, 711) 06/10→								
 Brake Master Cylinder								
1.4 TSI 1.8 TSI 2.0 TDI 2.0 TDi 4Drive 2.0 TDI 4Drive 2.0 TFSI 2.0 TSI	110 118 85 - 135 130 103 - 135 147 162	06/10→ 11/12→ 06/10→ 11/18→ 05/11→ 11/10→05/12 05/15→		for right-hand drive vehicles		24.4153-0222.3	011047	ATE Ø 23.8 without brake fluid reservoir
SEAT - ALHAMBRA VAN (711) 06/10→								
 Brake Master Cylinder								
TDI TDI 4Drive TSi	110 - 135 110 110	05/15→ 05/15→ 05/15→		for right-hand drive vehicles		24.4153-0222.3	011047	ATE Ø 23.8 without brake fluid reservoir
SEAT - ATECA (KH7, KHP) 04/16→								
 Brake Master Cylinder								
1.4 TSI 4Drive 1.5 TSI 4Drive 2.0 TDI 4Drive 2.0 TSI 4Drive	110 110 110 - 140 140	06/16→ 07/18→ 04/16→ 05/17→		for left-hand drive vehicles		24.4153-1522.3	011048	ATE Ø 23.8 without brake fluid reservoir
SEAT - LEON (5F1) 09/12→05/21								
 Brake Master Cylinder								
1.0 TSi 1.0 TSI 1.2 TSI 1.4 TSI 1.5 TGi 1.5 TSI 1.6 TDI 2.0 Cupra 2.0 TSI	63 85 81 92 - 110 96 96 - 110 85 213 140	09/18→08/20 05/15→08/20 04/14→08/20 05/14→08/20 10/18→08/20 09/18→08/20 11/16→08/20 10/15→08/20 09/18→08/20		for left-hand drive vehicles		24.4153-1522.3	011048	ATE Ø 23.8 without brake fluid reservoir
1.2 TSI 1.4 TGI 1.4 TSI 1.6 TDI 1.8 TSI 2.0 Cupra 2.0 TDI	63 - 77 81 90 - 103 66 - 81 132 195 - 206 81 - 135	12/12→08/20 02/13→08/18 09/12→08/20 09/12→08/20 02/13→08/18 10/13→08/20 09/12→08/20		02/14→; for left-hand drive vehicles		24.4153-1522.3	011048	ATE Ø 23.8 without brake fluid reservoir
2.0 Cupra 2.0 Cupra R	221 228	01/17→08/18 11/17→08/18		for left-hand drive vehicles; +PR 1ZA / 1ZE		24.4153-1522.3	011048	ATE Ø 23.8 without brake fluid reservoir
SEAT - LEON Hatchback Van (5F1) 09/12→08/20								
 Brake Master Cylinder								
1.0 TSI 1.2 TSI 1.4 TSI 1.6 TDI 2.0 Cupra	85 81 110 85 213 - 221	05/15→08/20 04/14→08/18 05/14→08/20 11/16→08/20 09/15→08/18		for left-hand drive vehicles		24.4153-1522.3	011048	ATE Ø 23.8 without brake fluid reservoir
1.2 TSI 1.4 TSI 1.6 TDI 1.8 TFSI 2.0 TDI	63 90 - 103 66 - 81 132 110 - 135	01/13→08/18 09/12→10/16 09/12→10/16 02/13→08/18 10/12→08/18		02/14→; for left-hand drive vehicles		24.4153-1522.3	011048	ATE Ø 23.8 without brake fluid reservoir
				02/14→; for left-hand drive vehicles; +PR 1ZA / 1ZE		24.4153-1522.3	011048	ATE Ø 23.8 without brake fluid reservoir

	kW			 	! #		
SEAT - LEON SC (5F5) 01/13→12/18							
 Brake Master Cylinder							
1.0 TSI	85	05/15→08/18		for left-hand drive vehicles		24.4153-1522.3 011048	ATE Ø 23.8 without brake fluid reservoir
1.2 TSI	81	05/14→08/18					
1.4 TSI	92 - 110	05/14→08/18		for left-hand drive vehicles; +PR 1ZA / 1ZE		24.4153-1522.3 011048	ATE Ø 23.8 without brake fluid reservoir
1.6 TDI	85	11/16→08/18					
2.0 Cupra	213	10/15→11/16					
1.2 TSI	63 - 77	01/13→08/18		02/14→; for left-hand drive vehicles		24.4153-1522.3 011048	ATE Ø 23.8 without brake fluid reservoir
1.4 TSI	90 - 103	02/13→11/16		02/14→; for left-hand drive vehicles; +PR 1ZA / 1ZE		24.4153-1522.3 011048	ATE Ø 23.8 without brake fluid reservoir
1.6 TDI	66 - 81	02/13→08/18					
1.8 TSI	132	02/13→08/18					
2.0 Cupra	195 - 206	10/13→11/16					
2.0 TDI	81 - 135	02/13→08/18					
2.0 Cupra	221	01/17→08/18		for left-hand drive vehicles; +PR 1ZA / 1ZE		24.4153-1522.3 011048	ATE Ø 23.8 without brake fluid reservoir
SEAT - LEON ST (5F8) 09/12→08/20							
 Brake Master Cylinder							
1.0 TSi	63	09/18→08/20		for left-hand drive vehicles		24.4153-1522.3 011048	ATE Ø 23.8 without brake fluid reservoir
1.0 TSI	85	05/15→08/20					
1.2 TSI	81	05/14→08/20		for left-hand drive vehicles; +PR 1ZA / 1ZE		24.4153-1522.3 011048	ATE Ø 23.8 without brake fluid reservoir
1.4 TSI	92 - 110	05/14→08/20					
1.5 TGi	96	10/18→08/20					
1.5 TSI	96 - 110	09/18→08/20					
1.6 TDI	85	11/16→08/20					
1.6 TDI 4Drive	77 - 81	04/14→08/20					
1.8 TSI 4Drive	132	11/14→08/18					
2.0 Cupra	213	10/15→08/20					
2.0 TDI 4Drive	110 - 135	04/14→08/18					
1.2 TSI	63 - 77	08/13→08/20		02/14→; for left-hand drive vehicles		24.4153-1522.3 011048	ATE Ø 23.8 without brake fluid reservoir
1.4 TGI	81	10/13→08/18		02/14→; for left-hand drive vehicles; +PR 1ZA / 1ZE		24.4153-1522.3 011048	ATE Ø 23.8 without brake fluid reservoir
1.4 TSI	90 - 103	09/12→08/20					
1.6 TDI	66 - 81	09/13→08/20					
1.8 TSI	132	10/13→08/18					
2.0 Cupra	195 - 206	10/13→08/20					
2.0 TDI	81 - 135	02/13→08/20					
1.6 TDI 4Drive	85	07/18→08/20		for left-hand drive vehicles; +PR 1ZA / 1ZE		24.4153-1522.3 011048	ATE Ø 23.8 without brake fluid reservoir
2.0 Cupra	221	11/16→08/18					
2.0 Cupra 4Drive	221	11/16→08/20					
2.0 TSI	140	07/18→08/20					
2.0 TSI 4Drive	140	09/18→08/20					
SEAT - LEON ST Estate Van (5F8) 01/13→08/20							
 Brake Master Cylinder							
1.0 TSI	85	05/15→08/20		for left-hand drive vehicles		24.4153-1522.3 011048	ATE Ø 23.8 without brake fluid reservoir
1.2 TSI	81	05/14→08/18					
1.4 TSI	110	05/14→08/20		for left-hand drive vehicles; +PR 1ZA / 1ZE		24.4153-1522.3 011048	ATE Ø 23.8 without brake fluid reservoir
1.6 TDI	85	11/16→08/20					
2.0 TDI 4Drive	110 - 135	09/14→08/18					
1.2 TSI	63	01/13→08/18		02/14→; for left-hand drive vehicles		24.4153-1522.3 011048	ATE Ø 23.8 without brake fluid reservoir
1.6 TDI	81	09/13→08/20					
1.8 TFSI	132	10/13→08/18		02/14→; for left-hand drive vehicles; +PR 1ZA / 1ZE		24.4153-1522.3 011048	ATE Ø 23.8 without brake fluid reservoir
2.0 Cupra	206	10/13→08/20					
2.0 TDI	110 - 135	04/13→08/18					
2.0 Cupra	221	11/16→08/18		for left-hand drive vehicles; +PR 1ZA / 1ZE		24.4153-1522.3 011048	ATE Ø 23.8 without brake fluid reservoir
2.0 Cupra 4Drive	221	11/16→08/18					
SKODA - KAROQ (NU7, ND7) 07/17→							
 Brake Master Cylinder							
1.0 TSI	81 - 85	07/17→		for left-hand drive vehicles		24.4153-1522.3 011048	ATE Ø 23.8 without brake fluid reservoir
1.4 TSI	110	07/17→					
1.5 TSI	110	07/17→					
1.5 TSI 4x4	110	07/17→					











	kw			 	! #		
SKODA - KAROQ (NU7, ND7) 07/17→							
 Brake Master Cylinder							
1.6 SRE 1.6 TDI 2.0 TDI 2.0 TDI 4x4 2.0 TSI 4x4	81 85 85 110 85 140 140	07/17→ 07/17→ 07/17→ 07/17→ 04/19→		for left-hand drive vehicles		24.4153-1522.3 011048	ATE Ø 23.8 without brake fluid reservoir
SKODA - OCTAVIA III (5E3, NL3, NR3) 11/12→03/21							
 Brake Master Cylinder							
1.0 TSI 1.2 TSI 1.4 TSI 1.5 TSI 1.6 1.6 TDI 1.6 TDI 4x4 1.8 TSI 4x4 2.0 TDI 4x4 2.0 TSI 2.0 TSI 4x4 2.0 TSI RS	85 81 110 110 81 85 77 85 132 110 140 140 169 180	05/16→10/20 05/15→02/17 08/14→10/20 02/17→10/20 01/14→10/20 02/17→10/20 05/13→10/20 05/14→10/20 05/13→10/20 02/17→10/20 02/19→10/20 05/15→10/20		for left-hand drive vehicles; +PR 1ZA / 1ZB / 1ZE / 1ZF		24.4153-1522.3 011048	ATE Ø 23.8 without brake fluid reservoir
1.2 TSI 1.4 TSI 1.4 TSI G-TEC 1.6 TDI 1.8 TSI 2.0 TDI 2.0 TDI RS 2.0 TSI RS	63 77 103 81 66 81 132 105 110 135 162	11/12→02/17 11/12→02/17 11/13→02/17 11/12→10/20 11/12→10/20 11/12→10/20 05/13→10/20 05/13→02/17		01/14→; for left-hand drive vehicles; +PR 1ZA / 1ZB / 1ZE / 1ZF		24.4153-1522.3 011048	ATE Ø 23.8 without brake fluid reservoir
2.0 TDI / TDI RS 4x4	135	05/13→10/20		09/14→; +PR 1ZA / 1ZB / 1ZE / 1ZF; for left-hand drive vehicles		24.4153-1522.3 011048	ATE Ø 23.8 without brake fluid reservoir
SKODA - OCTAVIA III Combi (5E5, 5E6) 11/12→10/20							
 Brake Master Cylinder							
1.0 TSI 1.2 TSI 1.4 TSI 1.5 TSI 1.5 TSI G-TEC 1.6 1.6 TDI 1.6 TDI 4x4 2.0 TDI / TDI RS 4x4 2.0 TSI 2.0 TSI 4x4 2.0 TSI RS	85 81 110 110 96 81 85 81 85 135 140 140 169 180	05/16→10/20 05/15→02/17 08/14→10/20 02/17→10/20 01/19→10/20 01/14→02/17 02/17→10/20 05/15→10/20 05/13→10/20 02/17→10/20 02/19→10/20 05/15→10/20		+PR 1ZA / 1ZB / 1ZE / 1ZF; for left-hand drive vehicles		24.4153-1522.3 011048	ATE Ø 23.8 without brake fluid reservoir
1.2 TSI 1.4 TSI 1.4 TSI G-TEC 1.6 TDI 1.6 TDI 4x4 1.8 TSI 1.8 TSI 4x4 2.0 TDI 2.0 TDI 4x4 2.0 TDI RS 2.0 TSI RS	63 77 103 81 66 81 77 132 132 105 110 110 135 162	11/12→02/17 11/12→02/17 11/12→02/17 11/12→10/20 11/12→05/15 11/12→10/20 11/12→02/17 11/12→10/20 11/12→10/20 05/13→10/20 11/12→02/17		01/14→; for left-hand drive vehicles; +PR 1ZA / 1ZB / 1ZE / 1ZF		24.4153-1522.3 011048	ATE Ø 23.8 without brake fluid reservoir
SKODA - SUPERB III (3V3) 03/15→							
 Brake Master Cylinder							
1.4 TSI 1.4 TSI 4x4 1.5 TSI 1.6 TDI 1.8 TSI 2.0 TDI →	92 110 110 110 88 132 90 147	03/15→ 03/15→ 02/17→ 03/15→ 03/15→ 03/15→		for left-hand drive vehicles		24.4153-1522.3 011048	ATE Ø 23.8 without brake fluid reservoir

	kW			 	! #		
SKODA - SUPERB III (3V3) 03/15→							
 Brake Master Cylinder							
2.0 TDI 4x4	110 - 147	03/15→		for left-hand drive vehicles		24.4153-1522.3 011048	ATE Ø 23.8 without brake fluid reservoir
2.0 TSI	140 - 162	03/15→					
2.0 TSI 4x4	200 - 206	03/15→					
SKODA - SUPERB III Estate (3V5) 03/15→							
 Brake Master Cylinder							
1.4 TSI	92 - 110	03/15→		for left-hand drive vehicles		24.4153-1522.3 011048	ATE Ø 23.8 without brake fluid reservoir
1.4 TSI 4x4	110	03/15→					
1.5 TSi	110	02/17→					
1.6 TDI	88	03/15→					
1.8 TSI	132	03/15→					
2.0 TDI	90 - 147	03/15→					
2.0 TDI 4x4	110 - 147	03/15→					
2.0 TSI	140 - 162	03/15→					
2.0 TSI 4x4	200 - 206	03/15→					
SSANGYONG - TIVOLI 01/15→							
 Brake Pad Set, disc brake							
1.5	120	06/19→	←			13.0460-5544.2 605544	+ WK
1.5 All-wheel Drive	120	06/19→					
1.6	93 - 94	04/15→					
1.6 All-wheel Drive	93	04/15→					
1.6 CNG	94	07/18→					
1.6 GPL	94	04/15→					
1.6 GPL All-wheel Drive	94	03/15→					
1.6 XDi 160	83 - 100	04/15→					
1.6 XDi 160 All-wheel Drive	85 - 100	04/15→					
1.6 All-wheel Drive	94	03/15→	←	09/15→		13.0460-5544.2 605544	+ WK
SSANGYONG - XLV SUV 04/16→							
 Brake Pad Set, disc brake							
1.6 CNG	94	07/18→	←			13.0460-5544.2 605544	+ WK
1.6 GPL	94	05/16→					
1.6 GPL All-wheel Drive	94	05/16→					
e-XDi 160	85	04/16→					
e-XDi 160 All-wheel Drive	85	04/16→					
e-XGi 160	93 - 94	04/16→					
e-XGi 160 All-wheel Drive	93 - 94	04/16→					
SSANGYONG - XLV VAN 04/16→							
 Brake Pad Set, disc brake							
e-XDi	85	12/16→	←			13.0460-5544.2 605544	+ WK
e-XDi All-wheel Drive	85	12/16→					
e-XGi	94	12/16→					
e-XGi All-wheel Drive	94	12/16→					
TOYOTA - 4 RUNNER V (_N28_) 03/09→							
 Brake Hose							
4.0	202	01/10→	→	inner	2	24.5203-0290.3 331545	L= 295
4.0 4WD	202	01/10→	→	□ / Outer		24.5296-0253.3 331547	L= 244
TOYOTA - FJ CRUISER (GSJ1_) 06/05→01/18							
 Brake Hose							
4.0	176 - 178	06/05→12/11	→	08/09→; inner	2	24.5203-0290.3 331545	L= 295
4.0 4WD	176	06/05→12/09	→	08/09→; □ / Outer		24.5296-0253.3 331547	L= 244
4.0	191	01/10→06/14	→	inner	2	24.5203-0290.3 331545	L= 295
			→	→ 07/13; □ / Outer		24.5296-0253.3 331547	L= 244
4.0 4WD	178	01/06→01/18	→	08/09→; inner	2	24.5203-0290.3 331545	L= 295
→							

	kw					! #			
TOYOTA - FJ CRUISER (GSJ1_) 06/05→01/18									
 Brake Hose									
4.0 4WD	178	01/06→01/18	➡	☐ / Outer			24.5296-0253.3	331547	L= 244
4.0 4WD	191	01/10→06/14	➡	12/10→; inner	2		24.5203-0290.3	331545	L= 295
			➡	08/12→ 07/13; ☐ / Outer			24.5296-0253.3	331547	L= 244
			➡	12/10→ 07/12; ☐ / Outer			24.5296-0253.3	331547	L= 244
4.0 4WD	200 - 203	06/05→01/18	➡	inner	2		24.5203-0290.3	331545	L= 295
			➡	☐ / Outer			24.5296-0253.3	331547	L= 244
TOYOTA - LAND CRUISER 200 (_J2_) 08/07→									
 Brake Hose									
4.0	176	01/10→	➡	inner	2		24.5203-0290.3	331545	L= 295
			➡	☐ / Outer			24.5296-0253.3	331547	L= 244
TOYOTA - LAND CRUISER PRADO (_J15_) 07/09→									
 Brake Hose									
2.7	120	08/09→	➡	01/10→; inner	2		24.5203-0290.3	331545	L= 295
3.0 D	70	07/09→							
3.0 D-4D	140	08/09→		01/10→; ☐ / Outer					
3.0 TDi	120	08/09→							
4.0 V6 Dual VVTi	205	08/09→							
4.0 V6 VVT-i	207	08/09→							
4.0 V6 VVTi	202	08/09→							
2.8 D-4D	130	06/15→	➡	inner	2		24.5203-0290.3	331545	L= 295
3.5	206	09/15→	➡	☐ / Outer					
4.0 V6 VVTi	183 - 203	01/10→					24.5296-0253.3	331547	L= 244
3.0 D-4D	127	08/09→	➡	03/10→; inner	2		24.5203-0290.3	331545	L= 295
			➡	03/10→; ☐ / Outer					
TOYOTA - YARIS (_P21_, _PA1_, _PH1_) 02/20→									
Accessory Kit, brake shoes									
1.0	53	02/20→	➡				03.0137-9321.2	669321	
1.5	92	02/20→							
VAUXHALL - ASTRA Mk VI (J) (P10) 12/09→10/15									
 Brake Hose									
1.3 CDTi	70	12/09→10/15	➡	☐			24.5176-0654.3	331627	L= 654
1.4	64 - 74	12/09→10/15							
	74								
1.4 Turbo	88 - 103	12/09→10/15							
1.6	85	12/09→10/15							
1.6 CDTi	81 - 100	11/13→10/15							
1.6 Turbo	132	12/09→10/15							
1.7 CDTi	81 - 96	12/09→10/15							
1.7 CDTi	74	10/10→10/15							
2.0 BiTurbo CDTi	143	12/12→10/15							
2.0 CDTi	118 - 121	12/09→10/15							
VAUXHALL - ASTRA Mk VI (J) Estate (P10) 10/10→10/15									
 Brake Hose									
1.3 CDTi	70	10/10→10/15	➡	☐			24.5176-0654.3	331627	L= 654
1.4	64 - 74	10/10→10/15							
	74								
1.4 Turbo	103	10/10→10/15							
1.6	85	10/10→10/15							
1.6 CDTi	81 - 100	01/14→10/15							
1.6 Turbo	132	10/10→10/15							
1.7 CDTi	81 - 96	10/10→10/15							
2.0 BiTurbo CDTi	143	12/12→10/15							
2.0 CDTi	118 - 121	10/10→10/15							
VAUXHALL - ASTRA Mk VI (J) GTC (P10) 10/11→10/15									
 Brake Hose									
1.4	74 - 103	10/11→10/15	➡	☐			24.5176-0654.3	331627	L= 654
→									

	kw			 	! #		
VAUXHALL - ASTRA Mk VI (J) GTC (P10) 10/11→10/15							
 Brake Hose							
1.6 1.6 CDTi 1.6 SIDI 1.7 CDTi 2.0 BiTurbo CDTi 2.0 CDTi 2.0 VXR	132 81 - 100 147 81 - 96 143 121 206	10/11→10/15 07/14→10/15 09/13→10/15 10/11→10/15 12/12→10/15 10/11→10/15 04/12→10/15	➔	<input type="checkbox"/>		24.5176-0654.3 331627	L= 654
VAUXHALL - ASTRA Mk VI (J) Saloon (P10) 06/12→10/15							
 Brake Hose							
1.3 CDTi 1.4 1.4 Turbo 1.6 1.6 Turbo 1.7 CDTi	70 74 103 85 132 81 - 96	06/12→10/15 06/12→10/15 06/12→10/15 06/12→10/15 06/12→10/15 06/12→10/15	➔	<input type="checkbox"/>		24.5176-0654.3 331627	L= 654
VAUXHALL - CASCADA Convertible (W13) 02/13→							
 Brake Hose							
1.4 1.6 2.0 CDTi	103 125 - 147 121 - 143	02/13→ 02/13→ 02/13→	➔	<input type="checkbox"/>		24.5176-0654.3 331627	L= 654
VAUXHALL - ZAFIRA Mk III (P12) 10/11→08/18							
 Brake Hose							
1.4 1.6 CDTi 1.6 CNG 1.6 SIDI 1.8 2.0 BiTurbo CDTi 2.0 CDTi	88 - 103 99 - 100 110 147 85 - 103 143 81 - 125	10/11→08/18 03/13→08/18 10/11→08/18 07/13→08/18 10/11→08/18 11/12→08/18 10/11→08/18	➔	<input type="checkbox"/>		24.5176-0654.3 331627	L= 654
VW - ARTEON (3H7, 3H8) 03/17→							
 Brake Master Cylinder							
1.5 TSI 2.0 TDI 2.0 TDI 4motion 2.0 TSI 2.0 TSI 4motion	110 110 - 147 140 - 176 140 200 - 206	11/17→07/19 03/17→ 03/17→ 05/17→ 04/17→		for left-hand drive vehicles; Manufacturer Restriction ATE		24.4153-1522.3 011048	ATE Ø 23.8 without brake fluid reservoir
VW - ARTEON SHOOTING BRAKE (3H9) 06/20→							
 Brake Master Cylinder							
1.5 TSi 2.0 TDI 2.0 TDI 4motion 2.0 TSi 2.0 TSi 4motion 2.0 TSi 4motion	110 110 - 147 140 - 147 200 206	08/20→ 09/20→ 09/20→ 09/20→ 09/20→ 06/20→		for left-hand drive vehicles; Manufacturer Restriction ATE		24.4153-1522.3 011048	ATE Ø 23.8 without brake fluid reservoir
VW - GOLF VII Variant (BA5, BV5) 04/13→							
 Brake Master Cylinder							
1.0 TSI 1.2 TSI 1.4 TSI 1.4 TSI MultiFuel 1.5 TSI 1.6 1.6 TDI →	63 - 85 81 92 - 110 92 96 - 110 81 85	05/15→ 04/14→ 05/14→ 05/14→03/17 04/17→ 05/14→03/17 11/16→		for left-hand drive vehicles; +PR 1ZA / 1ZD / 1ZE / 1ZF / 1ZP		24.4153-1522.3 011048	ATE Ø 23.8 without brake fluid reservoir

	kw					! #		
VW - GOLF VII Variant (BA5, BV5) 04/13→								
 Brake Master Cylinder								
1.8 TSI 4motion 2.0 GTD 2.0 R 360S 4motion 2.0 R 4motion	132 135 265 206 - 228	11/16→ 01/15→03/17 09/16→ 03/15→		for left-hand drive vehicles; +PR 1ZA / 1ZD / 1ZE / 1ZF / 1ZP			24.4153-1522.3 011048	ATE Ø 23.8 without brake fluid reservoir
1.2 TSI 1.4 TGI CNG 1.4 TSI 1.4 TSI MultiFuel 1.6 TDI 1.6 TDI 4motion 2.0 TDI 2.0 TDI 4motion	63 - 77 81 90 - 103 90 66 - 81 77 - 81 81 110 110	05/13→ 09/13→ 05/13→ 04/13→03/17 05/13→03/17 05/13→03/17 04/13→ 04/13→		12/13→; for left-hand drive vehicles; +PR 1ZA / 1ZD / 1ZE / 1ZF / 1ZP			24.4153-1522.3 011048	ATE Ø 23.8 without brake fluid reservoir
VW - GOLF ALLTRACK VII Variant (BA5, BV5) 12/14→								
 Brake Master Cylinder								
1.6 TDI 4motion 1.8 TSI 4motion 2.0 TDI 4motion	81 132 110 - 135	12/14→ 12/14→ 12/14→		+PR 1ZA / 1ZD / 1ZE / 1ZF / 1ZP; for left-hand drive vehicles			24.4153-1522.3 011048	ATE Ø 23.8 without brake fluid reservoir
VW - GOLF SPORTSVAN VII (AM1, AN1) 02/14→								
 Brake Master Cylinder								
1.0 TSI 1.2 TSI 1.4 TSI 1.4 TSI MultiFuel 1.5 TSI 1.6 1.6 TDI 2.0 TDI	63 - 85 63 - 81 92 - 110 92 96 - 110 81 66 - 85 81 - 110	05/15→ 04/14→ 02/14→ 04/14→ 05/17→ 05/14→ 02/14→ 02/14→		for left-hand drive vehicles			24.4153-1522.3 011048	ATE Ø 23.8 without brake fluid reservoir
VW - PASSAT ALLTRACK B8 Variant (3G5, CB5) 05/15→								
 Brake Master Cylinder								
1.4 TSI 4motion 2.0 TDI 4motion 2.0 TSI 4motion	110 110 - 176 162 - 206	05/15→ 05/15→ 07/15→		for left-hand drive vehicles; +PR 1ZA / 1ZD			24.4153-1522.3 011048	ATE Ø 23.8 without brake fluid reservoir
VW - PASSAT B8 (3G2, CB2) 08/14→								
 Brake Master Cylinder								
1.4 GTE Hybrid 1.4 TSI 1.4 TSI 4motion 1.5 TSI 1.8 TSI 2.0 TDI 2.0 TDI 4motion 2.0 TSI 2.0 TSI 4motion 1.6 TDI 2.0 TDI 4motion	115 92 - 110 110 110 132 81 - 147 140 - 147 140 - 162 200 - 206 88 110 - 176	06/15→11/18 11/14→ 02/15→ 08/18→ 02/15→ 11/14→ 11/14→ 02/15→ 02/15→ 05/15→ 08/14→ 08/14→		for left-hand drive vehicles; +PR 1ZA / 1ZD 11/14→; for left-hand drive vehicles; +PR 1ZA / 1ZD			24.4153-1522.3 011048	ATE Ø 23.8 without brake fluid reservoir ATE Ø 23.8 without brake fluid reservoir
VW - PASSAT B8 Variant (3G5, CB5) 08/14→								
 Brake Master Cylinder								
1.4 GTE Hybrid 1.4 TSI 1.4 TSI 4motion →	115 92 - 110 110	06/15→ 11/14→ 02/15→		for left-hand drive vehicles; +PR 1ZA / 1ZD			24.4153-1522.3 011048	ATE Ø 23.8 without brake fluid reservoir

	kw			 	! #		
VW - PASSAT B8 Variant (3G5, CB5) 08/14→							
 Brake Master Cylinder							
1.5 TSI 1.8 TSI 2.0 TDI 2.0 TDI 4motion 2.0 TSI 2.0 TSI 4motion	110 132 90 - 147 140 - 147 140 200 - 206	08/18→ 02/15→ 11/14→ 11/14→ 11/18→ 05/15→		for left-hand drive vehicles; +PR 1ZA / 1ZD		24.4153-1522.3 011048	ATE Ø 23.8 without brake fluid reservoir
1.6 TDI 2.0 TDI 4motion 2.0 TSI	88 110 - 176 162	08/14→ 08/14→ 08/14→		11/14→; for left-hand drive vehicles; +PR 1ZA / 1ZD		24.4153-1522.3 011048	ATE Ø 23.8 without brake fluid reservoir
VW - SHARAN (7N1, 7N2) 05/10→							
 Brake Master Cylinder							
1.4 TSI 2.0 TDI	110 100 - 103	05/10→ 05/10→		07/10→; for right-hand drive vehicles		24.4153-0222.3 011047	ATE Ø 23.8 without brake fluid reservoir
1.4 TSI 2.0 TDI 2.0 TDI 4motion 2.0 TFSI 2.0 TSI	110 85 - 135 103 - 135 147 162	05/15→ 08/10→ 05/11→ 12/10→11/15 05/15→		for right-hand drive vehicles		24.4153-0222.3 011047	ATE Ø 23.8 without brake fluid reservoir
VW - SHARAN VAN (7N1, 7N2) 05/10→							
 Brake Master Cylinder							
1.4 TSI 2.0 TDI	110 100 - 103	05/10→11/15 05/10→11/15		07/10→; for right-hand drive vehicles		24.4153-0222.3 011047	ATE Ø 23.8 without brake fluid reservoir
2.0 TDI 2.0 TSI	85 - 125 147	08/10→11/15 12/10→11/15		for right-hand drive vehicles		24.4153-0222.3 011047	ATE Ø 23.8 without brake fluid reservoir
VW - TOURAN (5T1) 05/15→							
 Brake Master Cylinder							
1.0 TSI 1.2 TSI 1.4 TSI 1.5 TSI 1.6 TDI 1.8 TSI 2.0 TDI	85 81 110 110 81 - 85 132 81 - 140	12/18→ 05/15→ 05/15→ 11/18→ 05/15→ 11/15→ 05/15→		for left-hand drive vehicles		24.4153-1522.3 011048	ATE Ø 23.8 without brake fluid reservoir
VW - TOURAN VAN (5T1) 05/15→							
 Brake Master Cylinder							
2.0 TDI	90 - 110	11/20→		for left-hand drive vehicles		24.4153-1522.3 011048	ATE Ø 23.8 without brake fluid reservoir
VW - T-ROC (A11, D11) 07/17→							
 Brake Master Cylinder							
1.0 TSI 1.5 TSI 1.5 TSI 4motion 1.6 TDI 2.0 R 4motion 2.0 TDI 2.0 TDI 4motion 2.0 TDI SCR 2.0 TSI 4motion	81 - 85 110 110 85 221 110 110 - 140 85 140	07/17→ 11/17→ 05/18→11/19 03/18→06/21 09/19→ 03/18→ 09/17→ 11/20→ 07/17→		for left-hand drive vehicles		24.4153-1522.3 011048	ATE Ø 23.8 without brake fluid reservoir
VW - T-ROC Convertible (AC7, AC8) 12/19→							
 Brake Master Cylinder							
1.0 TSI 1.5 TSI	81 - 85 110	12/19→ 12/19→		for left-hand drive vehicles		24.4153-1522.3 011048	ATE Ø 23.8 without brake fluid reservoir















- EN** Technical translations
- DE** Technische Übersetzungen
- ES** Traducciones técnicas
- FR** Traductions techniques
- IT** Traduzioni tecniche

05/2022



Technical translations

Technische Übersetzungen - Traducciones tecnicas - Traductions techniques - Traduzioni tecniche

EN		EN	
	Brake Master Cylinder	Bore Ø [mm]	Bore Ø [mm]
	Brake Hose	Brake Disc Thickness [mm]	Brake Disc Thickness [mm]
	Cable Pull, parking brake	Brake Size	Brake Size
	Brake Pad Set, disc brake	Cast Aluminium	Cast Aluminium
	Brake Disc	CB compatible package	CB compatible package
	Wheel Brake Cylinder	Centering Diameter [mm]	Centering Diameter [mm]
	Wheel Speed Sensor	Country specific package and status data	Country specific package and status data
	Rear Axle Left	Disc Brake	Disc Brake
	Rear Axle Right	- eFSB	for vehicles without electric parking brake
	Left Rear	Flange Hole Diameter [mm]	Flange Hole Diameter [mm]
	Right Rear	for individual equipment ID	for individual equipment ID
	Front Axle Left	for left-hand drive vehicles	for left-hand drive vehicles
	Front Axle Right	for right-hand drive vehicles	for right-hand drive vehicles
+PR	for PR number	for single tyres	for single tyres
+ RUS	Russia	for vehicles with 12V main current	for vehicles with 12V main current
+ S	with bolts/screws	for vehicles with Active City Stop	for vehicles with Active City Stop
+ WE	prepared for wear indicator	for vehicles without 3rd seating row	for vehicles without 3rd seating row
+ WK	with acoustic wear warning	for vehicles without Active City Stop	for vehicles without Active City Stop
+ Zub	with accessories		
15"	15"		
16.5"	16.5"		
17"	17"		
ATE Ceramic	additional article information, ATE Ceramic		
B	Coated		
Bolt Hole Circle Ø [mm]	Bolt Hole Circle Ø [mm]		















Technical translations

Technische Übersetzungen - Traducciones tecnicas - Traductions techniques - Traduzioni tecniche

EN		EN	
for vehicles without AMG sports package	for vehicles without AMG sports package	Thickness 1 [mm]	Thickness 1 [mm]
for vehicles without sports brake system	for vehicles without sports brake system	Thickness 2 [mm]	Thickness 2 [mm]
GG	Grey Cast Iron	usage number	usage number
HC	High-carbon	Vehicle Main Current	Vehicle Main Current
Height [mm]	Height [mm]	Vehicle Production Country	Vehicle Production Country
Height 1 [mm]	Height 1 [mm]	- WE	not prepared for wear indicator
Height 2 [mm]	Height 2 [mm]	Width [mm]	Width [mm]
inner	inner	with anti-squeak plate	with anti-squeak plate
Japan	Japan	with hollow screw	with hollow screw
L=	Length [mm]	without brake fluid reservoir	without brake fluid reservoir
L=	Cable Length [mm]	without cable	without cable
L1=	Length 1 [mm]	without hollow screw	without hollow screw
L2=	Length 2 [mm]	- WK	excl. wear warning contact
Machining	Machining	x	Number of connectors
MAN	Brake System, Mando	Yes	Yes
Manual Transmission	Manual Transmission	∅	Diameter [mm] Inner diameter [mm] Outer diameter [mm]
Manufacturer Restriction	Manufacturer Restriction	→	Construction year from
Minimum thickness [mm]	Minimum thickness [mm]	→	Construction year to Vehicle Identification Number to
Number of Holes	Number of Holes	→Orga	for RPO number (vehicle manufacturing date) up to
Number of seats	Number of seats		
Outer	Outer		
Piston Diameter [mm]	Piston Diameter [mm]		
Rim Size [in]	Rim Size [in]		
Spanner size 1 [mm]	Spanner size 1 [mm]		
Surface	Surface		
Thickness [mm]	Thickness [mm]		

Technical translations

Technische Übersetzungen - Traducciones tecnicas - Traductions techniques - Traduzioni tecniche

DE		DE	
	Hauptbremszylinder	Bore Ø [mm]	Bohrung-Ø [mm]
	Bremsschlauch	Brake Disc Thickness [mm]	Bremsscheibendicke [mm]
	Seilzug, Feststellbremse	Brake Size	Bremsengröße
	Bremsbelagsatz, Scheibenbremse	Cast Aluminium	Aluguss
	Bremsscheibe	CB compatible package	SB gerechte Verpackung
	Radbremszylinder	Centering Diameter [mm]	Zentrierungsdurchmesser [mm]
	Raddrehzahlsensor	Country specific package and status data	Länderspezifische Verpackungs- und Status-Informationen
	Hinterachse links	Disc Brake	Scheibenbremse
	Hinterachse rechts	- eFSB	für Fahrzeuge ohne elektrische Feststellbremse
	hinten links	Flange Hole Diameter [mm]	Flanschlochdurchmesser [mm]
	hinten rechts	for individual equipment ID	für Individualausstattungs-ID
	Vorderachse links	for left-hand drive vehicles	für Linkslenker
	Vorderachse rechts	for right-hand drive vehicles	für Rechtslenker
+PR	für PR-Nummer	for single tyres	für Einfachbereifung
+ RUS	Russland	for vehicles with 12V main current	für Fahrzeuge mit 12V Bordnetz
+ S	mit Schrauben	for vehicles with Active City Stop	für Fahrzeuge mit Active City Stop
+ WE	für Verschleißwarnanzeiger vorbereitet	for vehicles without 3rd seating row	für Fahrzeuge ohne 3. Sitzreihe
+ WK	mit akustischer Verschleißwarnung	for vehicles without Active City Stop	für Fahrzeuge ohne Active City Stop
+ Zub	mit Zubehör		
15"	15"		
16.5"	16,5"		
17"	17"		
ATE Ceramic	Artikelzusatzbezeichnung, ATE Ceramic		
B	beschichtet		
Bolt Hole Circle Ø [mm]	Lochkreis-Ø [mm]		

Technical translations

Technische Übersetzungen - Traducciones tecnicas - Traductions techniques - Traduzioni tecniche

DE		DE	
for vehicles without AMG sports package	für Fahrzeuge ohne AMG-Sportpaket	Thickness 1 [mm]	Dicke/Stärke 1 [mm]
for vehicles without sports brake system	für Fahrzeuge ohne Sportbremsanlage	Thickness 2 [mm]	Dicke/Stärke 2 [mm]
GG	Grauguss	usage number	Gebrauchsnummer
HC	hochgekoht	Vehicle Main Current	Bordnetzausführung
Height [mm]	Höhe [mm]	Vehicle Production Country	Fahrzeugproduktionsland
Height 1 [mm]	Höhe 1 [mm]	- WE	nicht für Verschleißwarnanzeiger vorbereitet
Height 2 [mm]	Höhe 2 [mm]	Width [mm]	Breite [mm]
inner	innen	with anti-squeak plate	mit Anti-Quietsch-Blech
Japan	Japan	with hollow screw	mit Hohlschraube
L=	Länge [mm]	without brake fluid reservoir	ohne Bremsflüssigkeitsbehälter
L=	Kabellänge [mm]	without cable	ohne Kabel
L1=	Länge 1 [mm]	without hollow screw	ohne Hohlschraube
L2=	Länge 2 [mm]	- WK	exkl. Verschleißwarnkontakt
Machining	Bearbeitung	x	Anschlussanzahl
MAN	Bremssystem, Mando	Yes	Ja
Manual Transmission	Schaltgetriebe	Ø	Durchmesser [mm] Innendurchmesser [mm] Außendurchmesser [mm]
Manufacturer Restriction	Herstellereinschränkung	→	Baujahr ab
Minimum thickness [mm]	Mindestdicke [mm]	→	Baujahr bis Fahrgestellnummer bis
Number of Holes	Lochanzahl	→Orga	für Organisationsnummer bis
Number of seats	Anzahl Sitzplätze		
Outer	außen		
Piston Diameter [mm]	Kolbendurchmesser [mm]		
Rim Size [in]	Felgengröße [Zoll]		
Spanner size 1 [mm]	Schlüsselweite 1 [mm]		
Surface	Oberfläche		
Thickness [mm]	Dicke/Stärke [mm]		

Technical translations

Technische Übersetzungen - Traducciones técnicas - Traductions techniques - Traduzioni tecniche

ES		ES	
	Cilindro principal de freno	Bore Ø [mm]	Taladro Ø [mm]
	Tubo flexible de frenos	Brake Disc Thickness [mm]	Espesor de disco de frenos [mm]
	Cable de accionamiento, freno de estacionamiento	Brake Size	Tamaño freno
	Juego de pastillas de freno	Cast Aluminium	Fundición de aluminio
	Disco de freno	CB compatible package	Embalaje apto para autoservicio
	Cilindro de freno de rueda	Centering Diameter [mm]	Diámetro de centrado [mm]
	Sensor de velocidad de la rueda	Country specific package and status data	Información específica del país sobre el embalaje y sobre el estado
	Eje trasero izquierda	Disc Brake	Discos
	Eje trasero, derecha	- eFSB	para vehículos sin freno de estacionamiento electrónico
	Atrás izquierda	Flange Hole Diameter [mm]	Diám. taladro brida [mm]
	Atrás derecha	for individual equipment ID	para ID equipamiento individual
	Eje delantero, izquierda	for left-hand drive vehicles	para vehic. dirección izquierda
	Eje delantero, derecha	for right-hand drive vehicles	para vehíc. dirección a la derecha
+PR	Número de PR	for single tyres	para neumáticos sencillos
+ RUS	Rusia	for vehicles with 12V main current	para vehículos con red de a bordo 12V
+ S	con tornillos	for vehicles with Active City Stop	para vehículos con Active City Stop
+ WE	preparado para indicador desgaste	for vehicles without 3rd seating row	para vehículos sin 3 hileras de asientos
+ WK	con avisador acústico de desgaste	for vehicles without Active City Stop	para vehículos sin Active City Stop
+ Zub	con accesorios		
15"	15"		
16.5"	16,5"		
17"	17"		
ATE Ceramic	Denominación adicional del artículo, ATE Ceramic		
B	revestido		
Bolt Hole Circle Ø [mm]	corona de agujeros - Ø [mm]		









Technical translations

Technische Übersetzungen - Traducciones tecnicas - Traductions techniques - Traduzioni tecniche

ES		ES	
for vehicles without AMG sports package	para vehículos sin paquete deportivo AMG	Thickness 1 [mm]	Espesor/grosor 1 [mm]
for vehicles without sports brake system	para vehículos sin sistema de frenos deportivos	Thickness 2 [mm]	Espesor/grosor 2 [mm]
GG	Fundición gris	usage number	Número de uso
HC	altamente carbonizado	Vehicle Main Current	Modelo red de a bordo
Height [mm]	Altura [mm]	Vehicle Production Country	País producción vehículo
Height 1 [mm]	Altura 1 [mm]	- WE	no preparado para indicador de desgaste
Height 2 [mm]	Altura 2 [mm]	Width [mm]	Ancho [mm]
inner	interior	with anti-squeak plate	Chapa antichirridos
Japan	Japón	with hollow screw	con tornillo hueco
L=	Longitud [mm]	without brake fluid reservoir	sin depósito líquido frenos
L=	Longitud de cable [mm]	without cable	sin cable
L1=	Longitud 1 [mm]	without hollow screw	sin tornillo hueco
L2=	Longitud 2 [mm]	- WK	excl. contacto de avisador de desgaste
Machining	Procesamiento	x	Número de conexiones
MAN	Sistema de frenos, Mando	Yes	sí
Manual Transmission	Caja de cambios manual	Ø	Diámetro [mm] Diámetro interior [mm] Diámetro exterior [mm]
Manufacturer Restriction	Restricción de fabricante	→	año construcción desde
Minimum thickness [mm]	Espesor mínimo [mm]	→	año construcción hasta nº de chasis hasta
Number of Holes	Número de orificios	→Orga	para n.º de org. hasta
Number of seats	Número de asientos		
Outer	exterior		
Piston Diameter [mm]	Diámetro del pistón [mm]		
Rim Size [in]	Tamaño de llanta [in]		
Spanner size 1 [mm]	Ancho de llave 1 [mm]		
Surface	Superficie		
Thickness [mm]	Espesor [mm]		

Technical translations

Technische Übersetzungen - Traducciones técnicas - Traductions techniques - Traduzioni tecniche

FR		FR	
	Maître-cylindre de frein	Bore Ø [mm]	Alésage-Ø [mm]
	Flexible de frein	Brake Disc Thickness [mm]	Épaisseur du disque de frein [mm]
	Tirette à câble, frein de stationnement	Brake Size	Dimension des freins
	Kit de plaquettes de frein, frein à disque	Cast Aluminium	Fonte d'aluminium
	Disque de frein	CB compatible package	Emballage LS
	Cylindre de roue	Centering Diameter [mm]	Diamètre du centrage [mm]
	Capteur de vitesse de roue	Country specific package and status data	Informations d'emballage et d'état spécifiques aux pays
<input type="checkbox"/>	Essieu arrière gauche	Disc Brake	Frein à disque
<input type="checkbox"/>	Essieu arrière droit	- eFSB	pour véhicules sans frein d'arrêt électrique
<input type="checkbox"/>	arrière gauche	Flange Hole Diameter [mm]	Diamètre du trou de bride [mm]
<input type="checkbox"/>	arrière droite	for individual equipment ID	pour ID d'équipement individuel
<input type="checkbox"/>	Essieu avant gauche	for left-hand drive vehicles	pour véhicules avec direction à gauche
<input type="checkbox"/>	Essieu avant droit	for right-hand drive vehicles	pour véhicules avec direction à droite
+PR	pour numéro PR	for single tyres	pour pneus simples
+ RUS	Russie	for vehicles with 12V main current	pour véhicules avec réseau de bord de 12V
+ S	avec vis/boulons	for vehicles with Active City Stop	pour véhicule avec Active City Stop
+ WE	préparé pour indicateur d'usure	for vehicles without 3rd seating row	pour véhicules sans 3ième rangée de sièges
+ WK	avec indicateur d'usure	for vehicles without Active City Stop	pour véhicule sans Active City Stop
+ Zub	avec accessoires		
15"	15"		
16.5"	16,5"		
17"	17"		
ATE Ceramic	Designation d'article complémentaire, ATE Ceramic		
B	revêtu		
Bolt Hole Circle Ø [mm]	Cercle de perçage -Ø [mm]		













Technical translations

Technische Übersetzungen - Traducciones técnicas - Traductions techniques - Traduzioni tecniche

FR		FR	
for vehicles without AMG sports package	pour véhicules sans paquet-sport AMG	Thickness 1 [mm]	Épaisseur 1 [mm]
for vehicles without sports brake system	pour véhicules sans système de freinage sport	Thickness 2 [mm]	Épaisseur 2 [mm]
GG	Fonte grise	usage number	Numéro d'utilisation
HC	à haute teneur en carbone	Vehicle Main Current	Type de réseau de bord
Height [mm]	Hauteur [mm]	Vehicle Production Country	Pays constructeur du véhicule
Height 1 [mm]	Hauteur 1 [mm]	- WE	non préparé pour indicateur d'usure
Height 2 [mm]	Hauteur 2 [mm]	Width [mm]	Largeur [mm]
inner	intérieur	with anti-squeak plate	avec tôle anti-bruit
Japan	Japon	with hollow screw	avec vis creuse
L=	Longueur [mm]	without brake fluid reservoir	sans réservoir du liquide de frein
L=	Longueur de câble [mm]	without cable	sans câble
L1=	Longueur 1 [mm]	without hollow screw	sans vis creuse
L2=	Longueur 2 [mm]	- WK	contact de signal d'usure exclu
Machining	Traitement	x	Nombre de connexions
MAN	Système de freinage, Mando	Yes	Oui
Manual Transmission	boîte de vitesses manuelle	Ø	Diamètre [mm] Diamètre intérieur [mm] Diamètre extérieur [mm]
Manufacturer Restriction	Montage d'origine	→	Année à partir de
Minimum thickness [mm]	Épaisseur minimum [mm]	→	Année jusqu'à N° de châssis jusqu'à
Number of Holes	Nombre de trous	→Orga	pour numéro OPR (date de fabrication du véhicule) jusqu'à
Number of seats	Nombre de sièges		
Outer	extérieur		
Piston Diameter [mm]	Diamètre du piston [mm]		
Rim Size [in]	Dimension de la jante [pouces]		
Spanner size 1 [mm]	Largeur de clé 1 [mm]		
Surface	Surface		
Thickness [mm]	Épaisseur [mm]		

Technical translations

Technische Übersetzungen - Traducciones tecnicas - Traductions techniques - Traduzioni tecniche

IT		IT	
	Cilindro maestro del freno	Bolt Hole Circle Ø [mm]	Cerchio foro-Ø [mm]
	Flessibile del freno	Bore Ø [mm]	Alesaggio-Ø [mm]
	Cavo comando, Freno stazionamento	Brake Disc Thickness [mm]	Spessore disco freno [mm]
	Kit pastiglie freno, Freno a disco	Brake Size	Misura freno
	Discofreno	Cast Aluminium	Alluminio pressofuso
	Cilindretto freno	CB compatible package	Imballaggio self-service
	Sensore velocità ruote	Centering Diameter [mm]	Diametro centraggio [mm]
	Assale posteriore Sx	Country specific package and status data	Informazioni di imballaggio e di stato specifiche per i diversi Paesi
	Assale posteriore Dx	Disc Brake	Freno a disco
	posteriore Sx	- eFSB	per veicoli senza freno stazionamento elettrico
	posteriore Dx	Flange Hole Diameter [mm]	Diametro foro flangia [mm]
	Assale anteriore Sx	for individual equipment ID	per ID-equipaggiamento individuale
	Assale anteriore Dx	for left-hand drive vehicles	per veicolo con guida a Sx
+PR	per N° PR	for right-hand drive vehicles	per veicolo con guida a Dx
+ RUS	Russia	for single tyres	per pneumatici singoli
+ S	con bulloni/viti	for vehicles with 12V main current	per veicoli con impianto elettrico di bordo a 12 Volt
+ WE	Predisposto per contatto segnalazione usura	for vehicles with Active City Stop	per veicoli con Active City Stop
+ WK	con segnalatore acustico usura	for vehicles without 3rd seating row	per veicoli senza 3ª fila sedili
+ Zub	con accessori		
15"	15"		
16.5"	16,5"		
17"	17"		
ATE Ceramic	Denominazione aggiuntiva dell'articolo, ATE Ceramic		
B	rivestito		

Technical translations

Technische Übersetzungen - Traducciones tecnicas - Traductions techniques - Traduzioni tecniche

IT		IT	
for vehicles without Active City Stop	per veicoli senza Active City Stop	Surface	Superficie
for vehicles without AMG sports package	per veicoli senza pacchetto sportivo AMG	Thickness [mm]	Spessore [mm]
for vehicles without sports brake system	per veicoli senza impianti frenante sportivo	Thickness 1 [mm]	Spessore 1 [mm]
GG	Ghisa grigia	Thickness 2 [mm]	Spessore 2 [mm]
HC	ad alto tenore di carbonio	usage number	Codice d'uso
Height [mm]	Altezza [mm]	Vehicle Main Current	Tipo imp. elettrico di bordo
Height 1 [mm]	Altezza 1 [mm]	Vehicle Production Country	Paese produzione veicolo
Height 2 [mm]	Altezza 2 [mm]	- WE	Non predisposto per contatto segnalazione usura
inner	interno	Width [mm]	Larghezza [mm]
Japan	Giappone	with anti-squeak plate	con lamierino anticigolio
L=	Lunghezza [mm]	with hollow screw	con vite cava
L=	Lunghezza cavo [mm]	without brake fluid reservoir	senza serbatoio liquido freni
L1=	Lunghezza 1 [mm]	without cable	senza cavo
L2=	Lunghezza 2 [mm]	without hollow screw	senza vite cava
Machining	Lavorazione/Trattamento	- WK	senza contatto segnalazione usura
MAN	Sistema frenante, Mando	x	N° raccordi
Manual Transmission	Cambio manuale	Yes	Sì
Manufacturer Restriction	Limitazione costruttore	Ø	Diametro [mm] Diametro interno [mm] Diametro esterno [mm]
Minimum thickness [mm]	Spessore min. [mm]	→	Anno da
Number of Holes	N° fori	→	Anno fino a N° telaio fino a
Number of seats	N° posti a sedere	→Orga	per numero organizzazione fino a
Outer	Esterno		
Piston Diameter [mm]	Diametro pistone [mm]		
Rim Size [in]	Misura cerchione [pollici]		
Spanner size 1 [mm]	Apertura chiave 1 [mm]		

ATE – A Trademark of the
Continental Corporation

**Continental Aftermarket & Services
GmbH**

Sodener Straße 9
D-65824 Schwalbach
Tel. +49 (0) 6196 87 0
Fax +49 (0) 6196 865 71

www.ate.de

**Continental Automotive Trading
Italia S.r.l.**

Via Matteotti, 62
I-20092 Cinisello Balsamo (MI)
Tel. +39 02 35680 1
Fax +39 02 35680 325
E-Mail: supporto@continental-corporation.com

www.ate-freni.it

Continental Automotive France SAS

1 rue de Clairefontaine
F-78120 Rambouillet
Tél. +33 (0)1 34 57 40 19
Fax +33 (0)1 34 57 40 72

www.ate-freinage.fr

Continental Automotive Spain, S.A.

C/ Sepúlveda, 11
E-28108 Alcobendas (Madrid) Phone
+34 (0) 657 21 21
Fax +34 (0)91 657 21 49

www.frenos-ate.es