

ATE New Parts ATE Neuteile

06/2022



Brakethrough Technology



Erstklassig First-class

Besser ist besser

Wenn es um Qualität geht, genügt uns ein „sehr gut“ noch lange nicht. Wir erfüllen hohe Ansprüche an das Qualitätsmanagement und die europäische Sicherheitsnorm ECE-R90 wird von ATE sogar übertroffen. Zudem führen wir zahlreiche zusätzliche Tests durch, unter anderem zu Verschleiß und Wärmeleistung.

Auch Nachhaltigkeit ist uns wichtig: Wir stellen die Mischungen für ATE Bremsbeläge auf kupferfreie Materialien um und setzen bei ATE Ceramic auf geringen Abrieb. Nutzen ausschließlich umweltfreundliches Material für die Beschichtung von Bremscheiben. Und bereiten Produkte wie Bremsattel wieder auf.

Better is better

When it comes to quality, “very good” is simply not good enough for us. We meet high standards of quality management – and ATE even exceeds the European safety standard ECE-R90. We also perform many additional tests, including wear and thermal performance.

Sustainability is also important to us: we convert the compounds for ATE brake pads to copperfree materials and opt for low abrasion with ATE Ceramic. We only use environmentally friendly material for the coating of brake discs – and we remanufacture products like brake callipers.

Höchste Qualität für optimale Leistung.



NEU: SUPER DOT 5.1

Neue Premium-Flüssigkeit ATE SUPER DOT 5.1 mit bester Funktionalität bei heißen wie kalten Einsatzbedingungen: 5°C höherer Nassiedepunkt und höheres Wechselintervall als ATE SL.6 bei gleich guter Viskosität, ideal für Fahrzeuge mit modernen Fahrerassistenzsystemen wie ESP®, ABS und ASR.

Große Auswahl für alle Einsatzgebiete

- | ATE SL als bewährter DOT 4 Typ, ATE TYP 200 für Rennsportbegeisterte und ATE DOT 3 G für Oldtimer und Fahrzeuge, wo die Verwendung einer DOT 3-Flüssigkeit vom Fahrzeughersteller vorgeschrieben ist
- | ATE SL.6 ist optimal für ESP®, ABS und ASR: dünnflüssig auch bei niedrigen Temperaturen, schnelle Reaktionszeit
- | Siedepunkte und Viskosität übertreffen gesetzliche und technische Anforderungen
- | Schutz vor Korrosion durch hochwertige Additive

Die Eigenschaften von ATE Bremsflüssigkeiten

	Siedepunkt	Nassiedepunkt	Viskosität bei -40°C	Wechselintervall
ATE SUPER DOT 5.1	min. 265°C	min. 180°C	max. 750 mm ² /s	bis 3 Jahre
ATE TYP 200 DOT 4 Racing-Qualität	min. 280°C	min. 198°C	max. 1.400 mm ² /s	bis 3 Jahre
ATE SL.6 DOT 4 Ideal für ESP®, ABS, ASR	min. 265°C	min. 175°C	max. 700 mm ² /s	bis 2 Jahre
ATE SL DOT 4	min. 260°C	min. 165°C	max. 1.400 mm ² /s	bis 1 Jahr
ATE G DOT 3	min. 245°C	min. 150°C	max. 1.500 mm ² /s	bis 1 Jahr

Zur Erhaltung der Funktionssicherheit der Bremsanlage muss Bremsflüssigkeit entsprechend der vom Fahrzeughersteller vorgegebenen Qualität und in den angegebenen Wechselintervallen ausgetauscht werden.

Servicegeräte

Natürlich bieten wir auch Geräte für Tests, Entlüftung und Entsorgung von Bremsflüssigkeiten an. Sie arbeiten exakt und zuverlässig, sind leicht zu bedienen und technologisch auf dem neuesten Stand.

Erfahren Sie mehr über ATE Bremsflüssigkeiten auf www.ate.de/bremsfluessigkeit sowie über unsere Servicegeräte auf www.ate-info.de



Typ	ATE Sachnummer	EAN-Nr. 4006633	Gebinde	Paletteneinheit
SUPER DOT 5.1 SAE-Spezifikation, J1704-FMVSS 116/DOT 5.1 ISO Klasse 5-1 – niedrigviskos	706602 03.9901-6602.2	45757 6	1 l	600 Kannen ²
	706603 03.9901-6603.2	45759 0	5 l	400 Kannen ³
	706611 03.9901-6611.2	45761 3	20 l	36 Kannen
TYP 200 SAE-Spezifikation, J1704-FMVSS 116/DOT 4	706202 03.9901-6202.2	10825 6	1 l	600 Kannen ²
	706203 03.9901-6203.2	12166 8	5 l	400 Kannen ³
	706220 03.9901-6220.2	12780 6	30 l	22 Kannen
SL.6 SAE-Spezifikation, J1704-FMVSS 116/DOT 4 ISO-Klasse 6 – niedrigviskos	706402 03.9901-6402.2	20746 1	1 l	600 Kannen ²
	706403 03.9901-6403.2	20748 5	5 l	400 Kannen ³
	706411 03.9901-6411.2	20750 8	20 l	36 Kannen
	706420 03.9901-6420.2	23120 6	30 l	22 Kannen
	706414 03.9901-6414.2	23005 6	50 l	12 Kannen
	706405 03.9901-6405.2	23121 3	200 l	1 Stück
SL SAE-Spezifikation, J1704-FMVSS 116/DOT 4	705801 03.9901-5801.2	49001 6	1/2 l	1.200 Kannen ¹
	705802 03.9901-5802.2	49002 3	1 l	600 Kannen ²
	705803 03.9901-5803.2	49003 0	5 l	400 Kannen ³
	705811 03.9901-5811.2	29907 7	20 l	12 Kannen
	705820 03.9901-5820.2	10824 9	30 l	22 Kannen
	705814 03.9901-5814.2	10366 4	50 l	12 Kannen
	705805 03.9901-5805.2	49005 4	200 l	1 Stück
G SAE-Spezifikation, J1703-FMVSS 116/DOT 3	705302 03.9901-5302.2	10199 8	1 l	600 Kannen ²
	705303 03.9901-5303.2	10201 8	5 l	400 Kannen ³

Abweichende Artikelnummern für Lieferländer außerhalb Deutschlands möglich.

Paletteneinheit:

¹ 20 Kannen je Karton

² 10 Kannen je Karton

³ 4 Kannen je Karton

Top quality for optimum performance.



NEW: SUPER DOT 5.1

The new premium ATE SUPER DOT 5.1 brake fluid with optimum performance in both hot and cold conditions: 5°C higher wet boiling point than ATE SL.6, same excellent viscosity, longer change interval, ideal for vehicles with advanced driver assistance systems like ESP®, ABS and ASR.

Wide selection for all applications

- | ATE SL as a proven DOT 4 grade, ATE TYPE 200 for racing enthusiasts and ATE DOT 3 G for classic cars and vehicles for which the manufacturer specifies a DOT 3 brake fluid
- | ATE SL.6 is optimal for ESP®, ABS and ASR: low viscosity even at low temperatures, with a fast reaction time
- | Boiling points and viscosities are better than in statutory and technical regulations
- | Protection from corrosion by high-grade additives

Properties of ATE brake fluids

	Boiling point	Wet boiling point	Viscosity at -40°C	Change interval
ATE SUPER DOT 5.1	min. 265 °C / 509 °F	min. 180 °C / 356 °F	max. 750 mm ² /s	up to 3 years
ATE TYPE 200 DOT 4 Racing quality	min. 280 °C / 536 °F	min. 198 °C / 388 °F	max. 1,400 mm ² /s	up to 3 years
ATE SL.6 DOT 4 Ideal for ESP®, ABS, ASR	min. 265 °C / 509 °F	min. 175 °C / 347 °F	max. 700 mm ² /s	up to 2 years
ATE SL DOT 4	min. 260 °C / 500 °F	min. 165 °C / 329 °F	max. 1,400 mm ² /s	up to 1 year
ATE G/ATE Blue DOT 3	min. 245 °C / 473 °F	min. 150 °C / 302 °F	max. 1,500 mm ² /s	up to 1 year

To maintain the operational reliability and safety of the brake system, you must change the brake fluid in accordance with the vehicle manufacturer's recommendations on quality and at the specified change intervals.

Service units

Of course we also offer devices for testing, bleeding and disposing of brake fluids. The devices work accurately and reliably, are easy to use and their technology is state-of-the-art.



To learn more about ATE brake fluids go to www.ate.de/bremsfluessigkeit. Information on our service units is available at www.ate-info.de

Type	ATE item code	Language variations	Container	Pallet unit
SUPER DOT 5.1 SAE specification, J1704-FMVSS 116/DOT 5.1 ISO Class 5-1 – low viscosity	706602 03.9901-6602.2	DE, EN, ES, PT, CN, FR, IT, AR, SE, NL, JP, TH, GR	1 L	600 cans ²
	706612 03.9901-6612.2	PL, RU, CZ, SK, SLO, HU, BG, KA, HR, SR, RO	1 L	600 cans ²
	706603 03.9901-6603.2	DE, EN, ES, PT, CN, FR, IT, AR, SE, NL, JP, TH, GR, PL, RU, CZ, SK, SLO, HU, BG, KA, HR, SR, RO	5 L	400 cans ³
	706611 03.9901-6611.2	DE, EN, ES, PT, CN, FR, IT, AR, SE, NL, JP, TH, GR, PL, RU, CZ, SK, SLO, HU, BG, KA, HR, SR, RO	20 L	36 cans
TYP 200 SAE specification, J1704-FMVSS 116/DOT 4	706202 03.9901-6202.2	DE, EN, ES, PT, CN, FR, IT, AR, SE, NL, JP, TH, GR	1 L	600 cans ²
	706212 03.9901-6212.2	PL, RU, CZ, SK, SLO, HU, BG, KA, HR, SR, RO	1 L	600 cans ²
	706203 03.9901-6203.2	DE, EN, PL, ES, CN, FR, IT, RO, AR, SE, RU, HR, SR, CZ, SK, SLO, GR, HU, JP, TH, BG, NL, PT, KA, DK, FI, SQ, TR, LV, NO, LT, MS, HY	5 L	400 cans ³
	706220 03.9901-6220.2	DE, EN, PL, ES, CN, FR, IT, RO, AR, SE, RU, HR, SR, CZ, SK, SLO, GR, HU, JP, TH, BG, NL, PT, KA, DK, FI, SQ, TR	30 L	22 cans
SL.6 SAE specification, J1704-FMVSS 116/DOT 4 ISO Class 6 – low viscosity	706402 03.9901-6402.2	DE, EN, ES, PT, CN, FR, IT, AR, SE, NL, JP, TH, GR	1 L	600 cans ²
	706432 03.9901-6432.2	PL, RU, CZ, SK, SLO, HU, BG, KA, HR, SR, RO	1 L	600 cans ²
	706403 03.9901-6403.2	DE, EN, PL, ES, CN, FR, IT, RO, AR, SE, RU, HR, SR, CZ, SK, SLO, GR, HU, JP, TH, BG, NL, PT, KA, DK, FI, SQ, TR, LV, NO, LT, MS, HY	5 L	400 cans ³
	706411 03.9901-6411.2	DE, EN, PL, ES, CN, FR, IT, RO, AR, SE, RU, HR, SR, CZ, SK, SLO, GR, HU, JP, TH, BG, NL, PT, KA, DK, FI, SQ, TR, LV	20 L	36 cans
	706420 03.9901-6420.2	DE, EN, PL, ES, CN, FR, IT, RO, AR, SE, RU, HR, SR, CZ, SK, SLO, GR, HU, JP, TH, BG, NL, PT, KA, DK, FI, SQ, TR	30 L	22 cans
	706414 03.9901-6414.2	DE, EN, PL, ES, CN, FR, IT, RO, AR, SE, RU, HR, SR, CZ, SK, SLO, GR, HU, JP, TH, BG, NL, PT, KA, DK, FI, SQ, TR	50 L	12 cans
	706405 03.9901-6405.2	DE, EN, PL, ES, CN, FR, IT, RO, AR, SE, RU, HR, SR, CZ, SK, SLO, GR, HU, JP, TH, BG, NL, PT, KA, DK, FI, SQ, TR	200 L	1 item
SL SAE specification, J1704-FMVSS 116/DOT 4	705801 03.9901-5801.2	DE, EN, ES, AR, TH, CN	1/2 L	1,200 cans ¹
	705831 03.9901-5831.2	PL, RO, RU, HR, SLO, KA	1/2 L	1,200 cans ²
	705802 03.9901-5802.2	DE, EN, ES, PT, CN, FR, IT, AR, SE, NL, JP, TH, GR	1 L	600 cans ²
	705832 03.9901-5832.2	PL, RU, CZ, SK, SLO, HU, BG, KA, HR, SR, RO	1 L	600 cans ²
	705803 03.9901-5803.2	DE, EN, PL, ES, CN, FR, IT, RO, AR, SE, RU, HR, SR, CZ, SK, SLO, GR, HU, JP, TH, BG, NL, PT, KA, DK, FI, SQ, TR, LV, NO, LT, MS, HY	5 L	400 cans ³
	705811 03.9901-5811.2	DE, EN, PL, ES, CN, FR, IT, RO, AR, SE, RU, HR, SR, CZ, SK, SLO, GR, HU, JP, TH, BG, NL, PT, KA, DK, FI, SQ, TR, LV	20 L	12 cans
	705820 03.9901-5820.2	DE, EN, PL, ES, CN, FR, IT, RO, AR, SE, RU, HR, SR, CZ, SK, SLO, GR, HU, JP, TH, BG, NL, PT, KA, DK, FI, SQ, TR	30 L	22 cans
	705814 03.9901-5814.2	DE, EN, PL, ES, CN, FR, IT, RO, AR, SE, RU, HR, SR, CZ, SK, SLO, GR, HU, JP, TH, BG, NL, PT, KA, DK, FI, SQ, TR	50 L	12 cans
	705805 03.9901-5805.2	DE, EN, PL, ES, CN, FR, IT, RO, AR, SE, RU, HR, SR, CZ, SK, SLO, GR, HU, JP, TH, BG, NL, PT, KA, DK, FI, SQ, TR	200 L	1 item
G SAE specification, J1703-FMVSS 116/DOT 3	705302 03.9901-5302.2	-	1 L	600 cans ²
	705303 03.9901-5303.2	-	5 L	400 cans ³
BLUE SAE specification, J1703-FMVSS 116/DOT 3	700301 03.9901-0301.2	-	1/2 L	1,200 cans ²
	700302 03.9901-0302.2	-	1 L	600 cans ²

Item codes may be different for countries of delivery other than Germany.

Pallet unit: ¹20 cans per box, ²10 cans per box, ³4 cans per box

EN Table of contents

Index of vehicles
Product details
Applications of vehicles
Technical translations

DE Inhaltsverzeichnis

8	Herstellerverzeichnis
11	Produktdetails
25	Fahrzeugverwendungen
65	Technische Übersetzungen

ES Índice

8	Índice de vehículos	8
11	Descripción del producto	11
25	Aplicaciones	25
65	Traducciones técnicas	65

FR Table des matières

Liste des véhicules
Présentation du produit
Applications
Traductions techniques

IT Sommario

8	Indice autovetture	8
11	Panoramica prodotti	11
25	Applicazioni autoveicoli	25
65	Traduzioni tecniche	65



- EN** Index of vehicles
- DE** Herstellerverzeichnis
- ES** Índice de vehículos
- FR** Liste des véhicules
- IT** Indice autovetture

06/2022



**AUDI 26**

A3 (8V1, 8VK)	26
A3 Convertible (8V7, 8VE)	26
A3 Limousine (8VS, 8VM)	26
A3 Sportback (8PA)	26
A3 Sportback (8VA, 8VF)	27
A4 Allroad B9 (8WH, 8WJ)	27
A4 B9 (8W2, 8WC)	27
A4 B9 Avant (8W5, 8WD)	28
A5 (F53, F5P)	28
A5 Convertible (F57, F5E)	29
A5 Sportback (F5A, F5F)	29
A6 Allroad C7 (4GH, 4GJ)	30
A6 C7 (4G2, 4GC)	30
A6 C7 Avant (4G5, 4GD)	30
A7 Sportback (4GA, 4GF)	31
TT (8J3)	31
TT Roadster (8J9)	31

BMW 31

1 (F40)	31
2 Gran Coupe (F44)	31
X2 (F39)	31

CHEVROLET 31

CAMARO	31
CAMARO Convertible	31
CORVETTE (C7)	31
CORVETTE Convertible (C7)	32
MALIBU (V300)	32
TRAX	32

CHRYSLER 32

300C	32
300C (LX, LE)	32
300C Touring (LX, LE)	32

CUPRA 32

ATECA (KH7, KHP)	32
FORMENTOR (KM7)	32
LEON (KL1)	32

FIAT 32

500 (312_)	33
500 C (312_)	33
500e (332_)	33
500e Convertible (332_)	33
PANDA (312_, 319_)	33

FORD 33

GALAXY III (CK)	33
GALAXY MK III VAN (CK)	33
MONDEO V Hatchback (CE)	33
MONDEO V Saloon (CD)	33
MONDEO V Turnier (CF)	34
S-MAX (CJ, WA6)	34

HONDA 34

HR-V (RU)	34
-----------	----

HYUNDAI 34

ACCENT III (MC)	34
ACCENT III Saloon (MC)	34
ACCENT IV (RB)	34
ACCENT IV Saloon (RB)	34
ACCENT V Saloon (HC)	35
BAYON (BC3)	35
ELANTRA III (XD)	35
ELANTRA III Saloon (XD)	35
GETZ (TB)	35
i10 I (PA)	35

**HYUNDAI 34**

i10 II (BA, IA)	36
i10 III (AC3, AI3)	36
i10 II Saloon	36
i20 ACTIVE (IB, GB)	37
i20 I (PB, PBT)	36
i20 II (GB, IB)	36
i20 II Coupe (GB)	36
i20 II Hatchback Van (GB, IB)	36
i20 III (BC3, BI3)	36
i30 (GD)	37
i30 Coupe	37
i30 Estate (GD)	37
i30 Hatchback Van (GDE)	37
i30 Kombi Van (GDE, GD)	37
MATRIX (FC)	37
SOLARIS Saloon (HCR)	37

KIA 37

CEE'D (JD)	37
CEE'D Combi Van (JD)	38
CEE'D Sportswagon (JD)	38
PICANTO III (JA)	38
PRO CEE'D (JD)	38
PRO CEE'D Hatchback Van (JD)	38
RIO II (JB)	38
RIO III (UB)	38
RIO III Hatchback Van (UB)	39
RIO III Saloon (UB)	39
RIO II Saloon (JB)	38
RIO IV (YB, SC, FB)	39
RIO IV Hatchback Van (YB, SC, FB)	39
RIO IV Saloon (SC, FB)	39

LADA 39

NIVA Closed Off-Road Vehicle (2121, 2131)	39
---	----

LANCIA 39

THEMA (LX_)	39
YPSILON (312_)	40

MERCEDES-BENZ 40

C-CLASS (W205)	40
C-CLASS Convertible (A205)	40
C-CLASS Coupe (C205)	40
C-CLASS T-Model (S205)	41
CITAN Box Body/MPV (W415)	41
CITAN Mixto (Double Cabin) (W415)	41
CITAN MPV (W415)	42
CLA Coupe (C117)	42
CLA Shooting Brake (X117)	42
EQC (N293)	42
GLA-CLASS (X156)	42
GLC (X253)	42
GLC Coupe (C253)	43
S-CLASS (W222, V222, X222)	43
SL (R231)	43
SPRINTER 4,6-t Platform/Chassis (B906)	43
SPRINTER 4,6-t Van (B906)	43
SPRINTER 5-t Bus (B906)	43
SPRINTER 5-t Platform/Chassis (B906)	44
SPRINTER 5-t Van (B906)	44
VIANO (W639)	44
VITO / MIXTO Van (W639)	44
VITO Bus (W639)	45

MINI 45

MINI CLUBMAN (F54)	45
MINI COUNTRYMAN (F60)	45

MITSUBISHI 45

COLT VI (Z3_A, Z2_A)	45
----------------------	----

**NISSAN 45**

CABSTAR (F24M, F24W)	45
LEAF (ZE1)	45
NT400 CABSTAR (F24M)	46
NV200 Van	46
NV250 Bus (X61)	46
NV250 Van (X61)	46

OPEL 46

AMPERA (R12)	46
ASTRA J (P10)	46
ASTRA J Estate Van (P10)	47
ASTRA J GTC	47
ASTRA J Hatchback Van (P10)	47
ASTRA J Saloon	48
ASTRA J Sports Tourer (P10)	48
CASCADA (W13)	49
INSIGNIA A (G09)	49
INSIGNIA A Country Tourer (G09)	49
INSIGNIA A Saloon (G09)	50
INSIGNIA A Sports Tourer (G09)	50
INSIGNIA B Country Tourer (Z18)	51
INSIGNIA B Grand Sport (Z18)	51
INSIGNIA B Sports Tourer (Z18)	51
INSIGNIA B Sports Tourer Combi Van (Z18)	51
MOKKA / MOKKA X (J13)	51
MOKKA X VAN (J13)	52
ZAFIRA TOURER C (P12)	52
ZAFIRA TOURER C VAN (P12)	52

RENAULT 52

KANGOO / GRAND KANGOO II (KW0/1_)	52
KANGOO BE BOP (KW0/1_)	53
KANGOO Express (FW0/1_)	53

SAAB 53

9-5 (YS3G)	53
------------	----

SEAT 53

ALHAMBRA (710, 711)	53
ALHAMBRA VAN (711)	53
LEON (5F1)	53
LEON Hatchback Van (5F1)	53
LEON SC (5F5)	53
LEON ST (5F8)	54
LEON ST Estate Van (5F8)	54

SKODA 54

KAROQ (NU7, ND7)	54
------------------	----

SUZUKI 54

CELERIO (LF)	54
SWIFT V (AZ)	54

TESLA 54

MODEL S (5YJS)	54
MODEL X (5YJX)	54

TOYOTA 55

ALLION I (_T24_)	55
AURIS (_E15_)	55
AURIS Hatchback Van (_E15_)	55
COROLLA Saloon (_E16_)	55
RAUM MPV (NC22_)	55
VERSO (_R2_)	55
VERSO VAN (_R2_)	55
YARIS (_P21_, _PA1_, _PH1_)	56
YARIS VERSO (_P2_)	56
YARIS VERSO VAN (_P2_)	56

**VAUXHALL****56**

AMPERA (R12)	56
ASTRA Mk VI (J) (P10)	56
ASTRA Mk VI (J) Estate (P10)	57
ASTRA Mk VI (J) GTC (P10)	57
ASTRA Mk VI (J) Saloon (P10)	58
CASCADA Convertible (W13)	58
INSIGNIA Mk I (A) Country Tourer (G09)	58
INSIGNIA Mk I (A) Hatchback (G09)	58
INSIGNIA Mk I (A) Saloon (G09)	59
INSIGNIA Mk I (A) Sports Tourer (G09)	59
INSIGNIA Mk II (B) Country Tourer (Z18)	60
INSIGNIA Mk II (B) Hatchback (Z18)	60
INSIGNIA Mk II (B) Sports Tourer (Z18)	60
MOKKA / MOKKA X (J13)	60
ZAFIRA Mk III (P12)	60

VOLVO**61**

S60 I (384)	61
V70 II (285)	61

VW**61**

CALIFORNIA T6 Camper (SGC, SGG, SHC)	61
CRAFTER 30-35 Bus (2E_)	61
CRAFTER 30-50 Platform/Chassis (2F_)	61
CRAFTER 30-50 Van (2E_)	61
CRAFTER Bus (SYI, SYJ)	62
CRAFTER Platform/Chassis (SZ_)	62
CRAFTER Van (SY_, SX_)	62
GOLF ALLTRACK VII Variant (BA5, BV5)	63
GOLF SPORTSVAN VII (AM1, AN1)	63
GOLF VAN VII Variant (BA5)	63
GOLF VII (5G1, BQ1, BE1, BE2)	62
GOLF VII Van (5G1)	62
GOLF VII Variant (BA5, BV5)	62
GRAND CALIFORNIA Camper (SCB, SCC)	63
SHARAN (7N1, 7N2)	63
SHARAN VAN (7N1, 7N2)	64
T-ROC (A11, D11)	64



- EN** Product details
- DE** Produktdetails
- ES** Descripción del producto
- FR** Présentation du produit
- IT** Panoramica prodotti

06/2022



03.0137-9348.2

669348

Accessory Kit, parking brake shoes

HYUNDAI, KIA

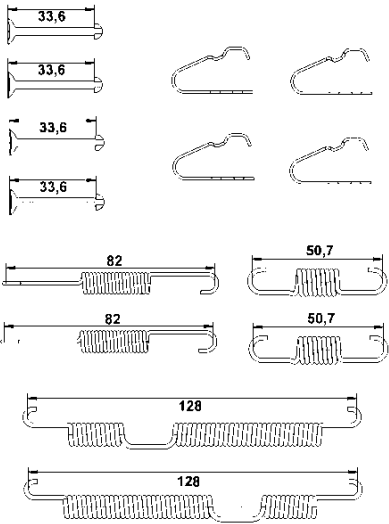

03.9302-0950.2

740334

Brake Bleeder Adapter

Nummer 9



13.0460-0521.2

610521

Accessory Kit, disc brake pad

AUDI, CUPRA, SEAT

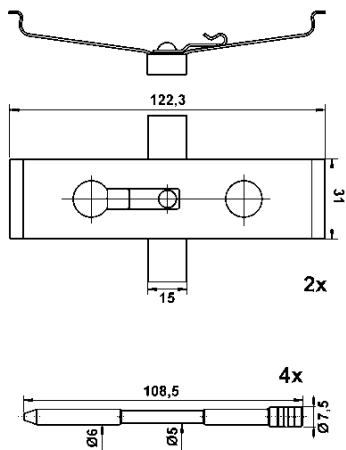

13.0460-0524.2

610524

Accessory Kit, disc brake pad

TESLA, VOLVO

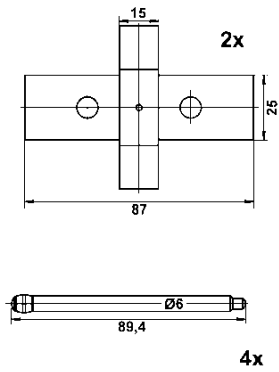

13.0460-2634.2

602634

 Brake Pad Set, disc brake

Thickness [mm] 18.2
 with brake caliper screws
 TRW
 + Zub
 + WE / - WK

Height [mm] 59.1
 Width [mm] 106.1

MERCEDES-BENZ

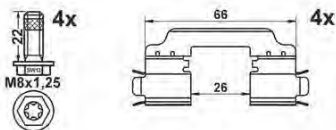
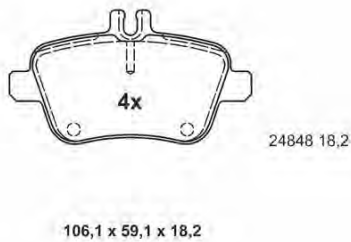

13.0460-3879.2

603879

 Brake Pad Set, disc brake

Thickness [mm] 20.9
 + WE / - WK
 Height [mm] 70.8
 Part number of recommended accessories: 24.8190-0831.2 / 24.8190-0994.2
 Width [mm] 177.6

VW

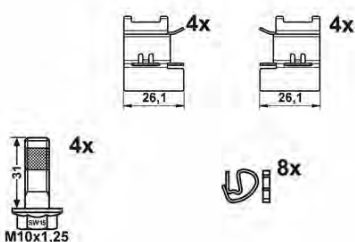
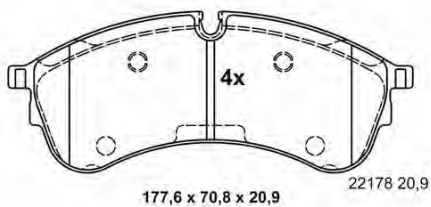

13.0460-4898.2

604898

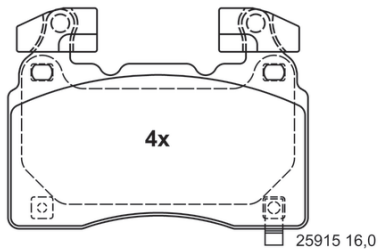

131,7 x 97,0 x 16,0



Brake Pad Set, disc brake

Thickness [mm] 16

BRE

+ WK

Height [mm] 97

Width [mm] 131.7

CHEVROLET, OPEL, VAUXHALL

13.0460-7349.2

607349

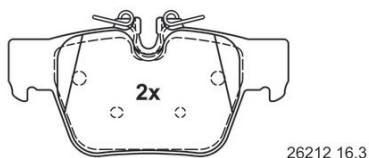

122,8 x 60,6 x 16,3

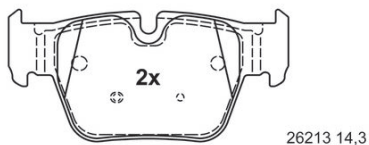

122,8 x 57,1 x 14,3



Brake Pad Set, disc brake

Height 1 [mm]: 60.6

ATE

Thickness 2 [mm] 14.3

Thickness 1 [mm] 16.3

+ WE / - WK

Width [mm] 122.8

Height 2 [mm]: 57.1

BMW, MINI

13.0460-7360.2

607360

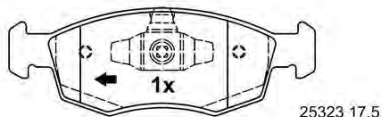

25323 17,5

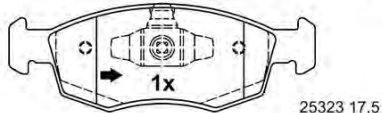

25323 17,5

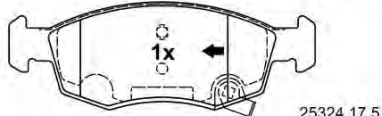

25324 17,5

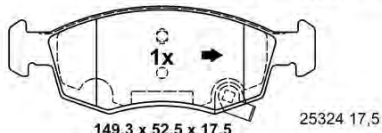

25324 17,5

149,3 x 52,5 x 17,5

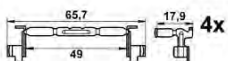

Brake Pad Set, disc brake

Thickness [mm] 17.5

ATE

with spring clip

+ WK

Height [mm] 52.5

Width [mm] 149.3

FIAT, LANCIA

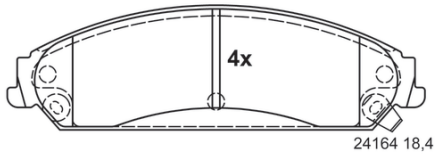

13.0460-8018.2**608018**

183,3 x 54,7 x 18,4

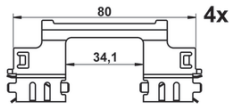
**Brake Pad Set, disc brake**

Thickness [mm] 18.4

+ Zub

+ WK

Height [mm] 54.7

Width [mm] 183.3

CHRYSLER, LANCIA**13.0470-2780.2****LD2780**

ATE Ceramic

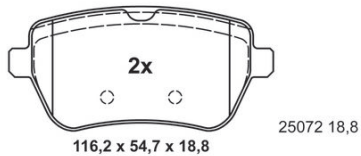

116,2 x 54,7 x 18,8

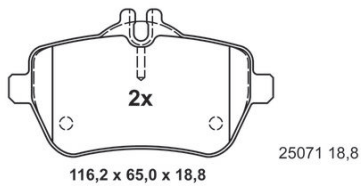

116,2 x 65,0 x 18,8

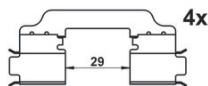

4x

M8x22

**Brake Pad Set, disc brake**

Thickness [mm] 18.8

with brake caliper screws

Height 1 [mm]: 54.7

TRW

+ Zub

+ WE / - WK

Width [mm] 116.2

Height 2 [mm]: 65

MERCEDES-BENZ**13.0470-4898.2****LD4898**

ATE Ceramic

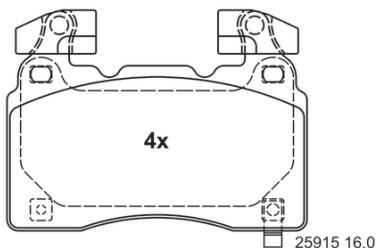

131,7 x 97,0 x 16,0

**Brake Pad Set, disc brake**

Thickness [mm] 16

BRE

+ WK

Height [mm] 97

Width [mm] 131.7

OPEL, VAUXHALL

13.0470-5508.2

LD5508

ATE Ceramic

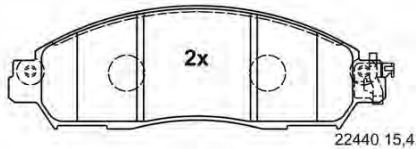
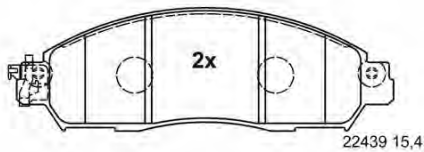

165,5 x 54,0 x 15,4



Brake Pad Set, disc brake

Thickness [mm] 15.4

AKE

+ WK

Height [mm] 54

Width [mm] 165.5

NISSAN

13.0470-5527.2

LD5527

ATE Ceramic

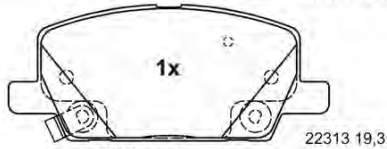
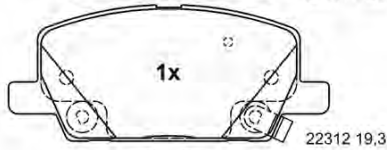
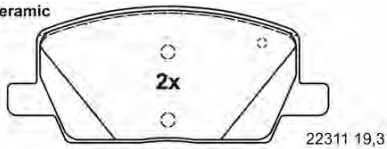

140,6 x 59,6 x 19,3

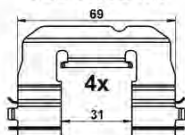

Brake Pad Set, disc brake

Thickness [mm] 19.3

MAN

+ Zub

+ WK

Height [mm] 59.6

Width [mm] 140.6

2x

CHEVROLET, OPEL, VAUXHALL

13.0470-7313.2

LD7313

ATE Ceramic

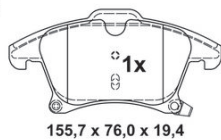

155,7 x 76,0 x 19,4

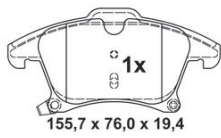

155,7 x 76,0 x 19,4

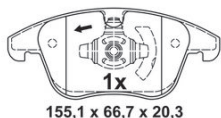

155,1 x 66,7 x 20,3



155,1 x 66,7 x 20,3

[1:3]



Brake Pad Set, disc brake

Height 1 [mm]: 76

ATE

B2= 155.1

B1= 155.7

Thickness 2 [mm] 20.3

Thickness 1 [mm] 19.4

+ WK

Height 2 [mm]: 66.7

2x

FORD

24.0109-0186.1

409186

Abbildung ähnlich
Illustration similar

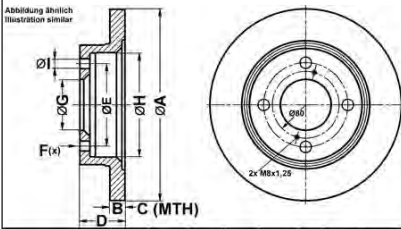

A	B	C	D	E	F(x)	G	H	I
228,0	9,0	8,0	34,2	100,0	4	62,0	127,0	12,7



Brake Disc

Ø 127

Minimum thickness [mm] 8

Brake Disc Thickness [mm] 9

SurfaceB

Centering Diameter [mm]: 62

Number of Holes: 4

Bore Ø [mm] 12.7

Bolt Hole Circle Ø [mm]: 100

Height [mm] 34.2

Ø 228

SUZUKI

24.0125-0221.1

425221

Abbildung ähnlich
Illustration similar

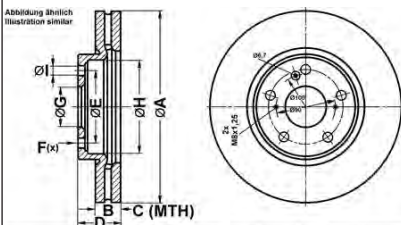

A	B	C	D	E	F(x)	G	H	I
293,0	25,0	23,0	47,2	114,3	5	64,0	148,0	12,7



Brake Disc

Ø 148

Minimum thickness [mm] 23

Brake Disc Thickness [mm] 25

SurfaceB

Centering Diameter [mm]: 64

Number of Holes: 5

Bore Ø [mm] 12.7

Bolt Hole Circle Ø [mm]: 114.3

Height [mm] 47.2

Vented

Ø 293

HONDA

24.0710-2112.3

360635



Wheel Speed Sensor

L= 1,540

L= 1,624

MERCEDES-BENZ, NISSAN, RENAULT

24.0710-2113.3

360636



Wheel Speed Sensor

L= 709

L= 800

MERCEDES-BENZ, NISSAN, RENAULT

24.0710-2114.3

360637



Wheel Speed Sensor

L= 520

L= 612

MERCEDES-BENZ

24.0710-2115.3

360638



Wheel Speed Sensor

L= 712

L= 804

MERCEDES-BENZ

24.0710-2116.3

360639



Wheel Speed Sensor

L= 507

L= 591

MERCEDES-BENZ, NISSAN, RENAULT

24.0710-2117.3

360640



Wheel Speed Sensor

L= 626

L= 708

MERCEDES-BENZ

24.0710-2118.3

360641



Wheel Speed Sensor

L= 1,545

L= 1,641

MERCEDES-BENZ



24.0710-2119.3

360642



Wheel Speed Sensor

L= 1,508

L= 1,604

MERCEDES-BENZ

24.0710-2120.3

360643



Wheel Speed Sensor

L= 670

L= 751

MERCEDES-BENZ

24.0710-2124.3

360644



Wheel Speed Sensor

L= 921

L= 1,003

MERCEDES-BENZ

24.3217-1740.3

020607



Wheel Brake Cylinder

ALU

Piston Diameter [mm]: 17.5

HYUNDAI, KIA

24.3219-1749.3

020500



Wheel Brake Cylinder

ALU

Piston Diameter [mm]: 19

SUZUKI, TOYOTA

24.3306-1701.5

241421



Brake Caliper

without holder

Service exchange part

Piston Diameter [mm]: 30

ALU

Brake Caliper (3 pistons)

LADA

24.3306-1702.5

241422



Brake Caliper

without holder

Service exchange part

Piston Diameter [mm]: 30

ALU

Brake Caliper (3 pistons)

LADA

24.3421-1724.5

241450



Brake Caliper

without holder

Service exchange part

Piston Diameter [mm]: 42

OPEL, SAAB, VAUXHALL

24.3481-9961.5

241459



Brake Caliper

ATE

without holder

Service exchange part

Piston Diameter [mm]: 48

NISSAN

24.3521-8503.5

241461



Brake Caliper

ATE

without holder

Service exchange part

Piston Diameter [mm]: 52

MERCEDES-BENZ, VW

24.3521-8504.5

241462



Brake Caliper

ATE

without holder

Service exchange part

Piston Diameter [mm]: 52

MERCEDES-BENZ, VW

24.3541-9953.5

241455



Brake Caliper

without holder

Service exchange part

Piston Diameter [mm]: 54

HYUNDAI

24.3541-9954.5

241456



Brake Caliper

without holder

Service exchange part

Piston Diameter [mm]: 54

HYUNDAI

24.3571-1805.5

241414



Brake Caliper

without holder

Service exchange part

Piston Diameter [mm]: 57

HYUNDAI, KIA

24.3601-1753.5

241439



Brake Caliper

MAN

without holder

Service exchange part

Piston Diameter [mm]: 60

CHEVROLET, OPEL, SAAB, VAUXHALL

24.3601-1754.5

241440



Brake Caliper

MAN

without holder

Service exchange part

Piston Diameter [mm]: 60

CHEVROLET, OPEL, SAAB, VAUXHALL

24.3727-0489.2

580489

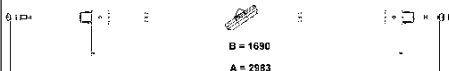

Cable Pull, parking brake

L= 2,983

MERCEDES-BENZ

24.4120-1713.3

011102



Brake Master Cylinder

without brake fluid reservoir

2x

M12x1

L2= 96.9

L1= 12

Cast Aluminium

Ø 20.6

HYUNDAI

24.5140-0421.3

331622

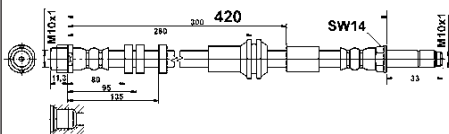

Brake Hose

L= 420

Spanner size 1 [mm]: 14

AUDI

24.5141-0637.3

331628

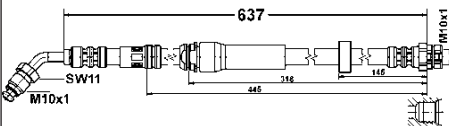

Brake Hose

L= 637

Spanner size 2 [mm]: 17

Spanner size 1 [mm]: 11

AUDI

24.5201-0265.3

331623

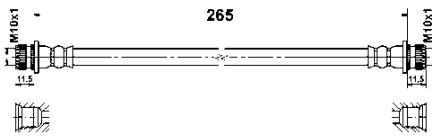

 Brake Hose

L= 265

MITSUBISHI

24.5202-0160.3

331624

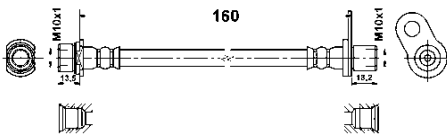

 Brake Hose

L= 160

TOYOTA

83.7847-0556.3

331339

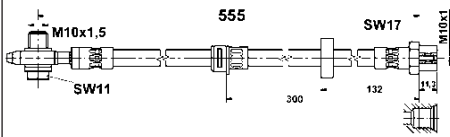

 Brake Hose

with hollow screw

M10x1,5

L= 555

Spanner size 1 [mm]: 17

SEAT, VW

83.8207-0290.3

331534

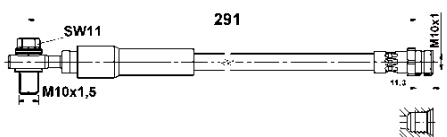

 Brake Hose

Flange Hole Diameter [mm]: 10

with hollow screw

M10x1,5

L= 291

Spanner size 2 [mm]: 17

Spanner size 1 [mm]: 11

AUDI, SKODA, VW



EN Applications of vehicles











DE Fahrzeugverwendungen

ES Aplicaciones

FR Applications

IT Applicazioni autoveicoli

06/2022

	kW			 	! #		
AUDI - A3 (8V1, 8VK) 04/12→10/20							
 Brake Hose							
1.0 TFSI 1.2 TFSI 81 1.4 TFSI 103 1.4 TSI 1.5 TFSI 1.6 TDI 85 1.8 TFSI 132 1.8 TFSI quattro 132 2.0 TDI 81 - 135 2.0 TDI quattro 110 - 135 2.0 TFSI 140 2.0 TFSI quattro 140 S3 quattro 206 - 228	85 77 - 81 90 - 103 110 110 77 - 85 132 132 81 - 135 110 - 135 140 140 206 - 228	07/16→12/17 02/13→08/16 04/12→08/16 05/14→12/17 05/17→12/17 10/12→10/20 04/12→08/16 08/12→08/16 04/12→10/20 10/12→12/17 05/16→12/17 05/16→12/17 11/12→12/17	➔	+PR 0N1	2	83.8207-0290.3 331534	L= 291
AUDI - A3 Convertible (8V7, 8VE) 10/13→							
 Brake Hose							
1.4 TFSI 103 1.4 TSI 110 1.5 TFSI 110 1.6 TDI 81 - 85 1.8 TFSI 125 - 132 1.8 TFSI quattro 132 2.0 TDI 100 - 135 2.0 TDI quattro 110 - 135 2.0 TFSI 140 2.0 TFSI quattro 140 - 162 35 TFSI 110 40 TFSI 140 40 TFSI quattro 140 S3 quattro 210 - 228	85 - 103 110 110 81 - 85 125 - 132 132 100 - 135 110 - 135 140 140 - 162 110 140 140 210 - 228	10/13→ 05/14→10/20 05/17→10/18 02/14→10/20 10/13→10/20 03/14→ 10/13→ 03/14→10/20 05/16→10/20 05/14→10/20 10/18→10/20 11/18→10/20 11/18→10/20 03/14→	➔	+PR 0N1	2	83.8207-0290.3 331534	L= 291
AUDI - A3 Limousine (8VS, 8VM) 05/13→							
 Brake Hose							
1.0 TFSI 1.2 TFSI 81 1.4 TFSI 103 1.4 TSI 110 1.5 TFSI 110 1.6 TDI 77 - 85 1.6 TDI quattro 81 1.8 TFSI 125 - 132 1.8 TFSI quattro 132 2.0 TDI 81 - 135 2.0 TDI quattro 110 - 135 2.0 TFSI 140 - 162 2.0 TFSI quattro 140 30 TDI 85 30 TFSI 85 35 TDI 110 35 TFSI 110 40 TDI quattro 135 40 TFSI 140 40 TFSI quattro 140 RS3 quattro 294 S3 quattro 206 - 228	85 77 - 81 90 - 103 110 110 77 - 85 81 125 - 132 132 81 - 135 110 - 135 140 - 162 140 85 85 110 110 135 140 140 294 206 - 228	07/16→10/20 10/13→ 05/13→ 05/14→10/20 05/17→10/18 09/13→ 05/15→ 05/13→ 11/13→ 05/13→ 10/13→10/20 11/15→10/20 05/16→10/20 07/18→10/20 07/18→10/20 07/18→10/20 07/18→10/20 07/18→07/19 07/18→10/20 07/18→10/20 04/17→10/20 10/13→	➔	+PR 0N1	2	83.8207-0290.3 331534	L= 291
AUDI - A3 Sportback (8PA) 09/04→12/15							
Accessory Kit, disc brake pad							
RS3 quattro	250	01/11→12/12	➔	04/11→; +PR 1LG		13.0460-0521.2 610521	

AUDI - A3 Sportback (8VA, 8VF) 09/12→

 **Brake Hose**

1.0 TFSI	85	07/16→10/20	➔	+PR 0N1	2	83.8207-0290.3	331534	L= 291
1.2 TFSI	77 -	05/13→						
	81							
1.4 TFSI	90 -	09/12→						
	103							
1.4 TFSI e-tron	110 -	05/14→10/20						
	150							
1.4 TFSI g-tron	81	11/13→10/20						
1.4 TFSI	110	05/14→10/20						
1.5 TFSI	110	05/17→10/18						
1.6 TDI	77 -	10/12→						
	85							
1.6 TDI quattro	81	05/15→08/16						
1.8 TFSI	132	09/12→						
1.8 TFSI quattro	132	05/13→						
2.0 TDI	81 -	09/12→10/20						
	135							
2.0 TDI quattro	110 -	02/13→10/20						
	135							
2.0 TFSI	140	05/16→10/20						
2.0 TFSI quattro	140	05/16→10/20						
30 g-tron	96	11/18→10/20						
30 TDI	85	07/18→10/20						
30 TFSI	85	07/18→10/20						
35 TDI	110	07/18→10/20						
35 TFSI	110	10/18→10/20						
40 TDI quattro	135	07/18→10/20						
40 TFSI	140	07/18→10/20						
40 TFSI quattro	140	07/18→10/20						
RS3 quattro	270 -	03/15→						
	294							
S3 quattro	206 -	11/12→						
	228							

AUDI - A4 Allroad B9 (8WH, 8WJ) 01/16→











 **Brake Hose**

2.0 TDI quattro	100 -	01/16→	➔	+PR 1LA / 1LB; ☐		24.5141-0637.3	331628	L= 637
	140							
2.0 TFSI Mild Hybrid quattro	185	11/18→10/19						
2.0 TFSI quattro	183 -	01/16→						
	185							
3.0 TDI quattro	160 -	01/16→10/19						
	210							
40 TDI Mild Hybrid quattro	150	09/20→						
40 TDI quattro	140	01/20→						
45 TDI quattro	170	07/18→						
45 TFSI Mild Hybrid quattro	180 -	07/18→						
	195							
50 TDI Mild Hybrid quattro	210	08/20→						
50 TDI quattro	210	11/19→						

AUDI - A4 B9 (8W2, 8WC) 05/15→

 **Brake Hose**

1.4 TFSI	110	08/15→11/19	➔	+PR 1LA / 1LB; ☐		24.5141-0637.3	331628	L= 637
2.0 TDI	90 -	05/15→						
	140							
2.0 TDI quattro	110 -	09/15→11/19						
	140							
2.0 TFSI	140 -	05/15→						
	185							
2.0 TFSI Mild Hybrid	185	05/17→11/19						
2.0 TFSI Mild Hybrid quattro	185	05/17→11/19						
2.0 TFSI quattro	183 -	05/15→						
	185							
3.0 TDI	160	09/15→08/18						
3.0 TDI quattro	160 -	05/15→08/18						
	200							
30 TDI	90	05/16→11/19						
30 TDI Mild Hybrid	100	07/19→						
35 TDI	110	08/15→11/19						
35 TDI Mild Hybrid	120	03/19→						
35 TFSI Mild Hybrid	110	12/18→11/19						
40 TDI	140	05/15→11/19						
40 TDI Mild Hybrid	150	09/20→						
40 TDI Mild Hybrid quattro	150	05/20→						
40 TDI quattro	140	09/15→11/19						
→								

	kW			 	! #		
AUDI - A4 B9 (8W2, 8WC) 05/15→							
 Brake Hose							
40 TFSI Mild Hybrid	140	05/17→	←	+PR 1LA / 1LB; ☐		24.5141-0637.3 331628	L= 637
	150						
40 TFSI Mild Hybrid quattro	150	06/20→					
45 TDI quattro	170	07/18→11/19					
45 TFSI Mild Hybrid	180	07/18→11/19					
45 TFSI Mild Hybrid quattro	180	07/18→					
	195						
50 TDI Mild Hybrid quattro	210	08/20→					
50 TDI quattro	210	07/18→11/19					
S4 quattro	260	05/16→11/19					
S4 TDI Mild Hybrid quattro	251	05/19→					
	255						
AUDI - A4 B9 Avant (8W5, 8WD) 08/15→							
 Brake Hose							
1.4 TFSI	110	02/16→10/19	←	+PR 1LA / 1LB; ☐		24.5141-0637.3 331628	L= 637
2.0 TDI	90	08/15→10/19					
	140						
2.0 TDI quattro	110	10/15→10/19					
	140						
2.0 TFSI	140	08/15→					
	185						
2.0 TFSI g-tron	125	11/16→10/19					
2.0 TFSI Mild Hybrid	185	05/17→10/19					
2.0 TFSI Mild Hybrid quattro	185	11/18→					
2.0 TFSI quattro	183	08/15→10/19					
	185						
3.0 TDI	160	10/15→08/18					
3.0 TDI quattro	160	08/15→08/18					
	200						
30 TDI	90	10/18→10/19					
30 TDI Mild Hybrid	100	07/19→					
35 TDI	110	10/18→10/19					
35 TDI Mild Hybrid	120	07/19→					
35 TFSI Mild Hybrid	110	12/18→10/19					
40 TDI	140	10/18→05/19					
40 TDI Mild Hybrid quattro	150	05/20→					
40 TDI quattro	140	10/18→09/20					
40 TFSI g-tron	125	11/16→10/19					
40 TFSI Mild Hybrid	140	05/17→					
	150						
40 TFSI Mild Hybrid quattro	150	06/20→					
45 TDI quattro	170	07/18→10/19					
45 TFSI Mild Hybrid	180	07/18→10/19					
45 TFSI Mild Hybrid quattro	180	07/18→					
	195						
50 TDI Mild Hybrid quattro	210	08/20→					
50 TDI quattro	210	07/18→10/19					
S4 quattro	260	05/16→10/19					
S4 TDI Mild Hybrid quattro	251	05/19→					
	255						
AUDI - A5 (F53, F5P) 06/16→							
 Brake Hose							
1.4 TFSI	110	11/16→02/20	←	+PR 1LA / 1LB; ☐		24.5141-0637.3 331628	L= 637
2.0 TDI	110	07/16→					
	140						
2.0 TDI quattro	140	10/16→					
2.0 TFSI	140	09/16→					
	185						
2.0 TFSI Mild Hybrid	185	05/17→02/20					
2.0 TFSI Mild Hybrid quattro	185	05/17→02/20					
2.0 TFSI quattro	183	06/16→					
	185						
3.0 TDI	160	11/16→08/18					
3.0 TDI quattro	160	07/16→02/20					
	210						
30 TDI Mild Hybrid	100	10/19→					
35 TDI	110	05/17→					
	120						
35 TFSI	110	03/20→					
35 TFSI Mild Hybrid	110	02/19→02/20					
40 TDI	140	06/16→02/20					
40 TDI Mild Hybrid →	150	09/20→					

AUDI - A5 (F53, F5P) 06/16→

 **Brake Hose**

40 TDI Mild Hybrid quattro	150	09/20→	←	+PR 1LA / 1LB; ☐		24.5141-0637.3 331628	L= 637
40 TDI quattro	140	10/16→02/20					
40 TFSI Mild Hybrid	140 -	05/17→					
	150						
40 TFSI Mild Hybrid quattro	150	07/20→					
45 TDI quattro	170	07/18→02/20					
45 TFSI Mild Hybrid	180	07/18→02/20					
45 TFSI Mild Hybrid quattro	180 -	07/18→					
	195						
50 TDI Mild Hybrid quattro	210	08/20→					
50 TDI quattro	210	01/17→02/20					
RS5 quattro	331	04/17→					
S5 quattro	260	07/16→					
S5 TDI Mild Hybrid quattro	251 -	12/18→					
	255						

AUDI - A5 Convertible (F57, F5E) 11/16→











 **Brake Hose**















2.0 TDI	110 -	11/16→12/19	←	+PR 1LA / 1LB; ☐		24.5141-0637.3 331628	L= 637
	140						
2.0 TDI quattro	140	03/17→					
2.0 TFSI	140 -	03/17→12/19					
	185						
2.0 TFSI Mild Hybrid	185	05/17→12/19					
2.0 TFSI Mild Hybrid quattro	185	05/17→12/19					
2.0 TFSI quattro	185	11/16→12/19					
3.0 TDI	160	03/17→08/18					
3.0 TDI quattro	160 -	11/16→12/19					
	210						
30 TDI MILD HYBRID	100	07/18→12/19					
35 TDI	120	10/19→					
35 TFSI Mild Hybrid	110	06/20→					
40 TDI	140	11/16→12/19					
40 TDI Mild Hybrid	150	09/20→					
40 TDI Mild Hybrid quattro	150	09/20→					
40 TDI quattro	140	03/17→12/19					
40 TFSI Mild Hybrid	140 -	05/17→					
	150						
40 TFSI Mild Hybrid quattro	150	06/20→					
45 TFSI Mild Hybrid	180	07/18→12/19					
45 TFSI Mild Hybrid quattro	180 -	07/18→					
	195						
50 TDI quattro	210	11/16→12/19					
S5 quattro	260	03/17→					



























AUDI - A5 Sportback (F5A, F5F) 06/16→

















 **Brake Hose**













1.4 TFSI	110	01/17→02/20	←	+PR 1LA / 1LB; ☐		24.5141-0637.3 331628	L= 637
2.0 TDI	100 -	09/16→					
	140						
2.0 TDI quattro	110 -	10/16→					
	140						
2.0 TFSI	140 -	11/16→					
	185						
2.0 TFSI g-tron	125	02/17→02/20					
2.0 TFSI Mild Hybrid	185	05/17→02/20					
2.0 TFSI Mild Hybrid quattro	185	05/17→02/20					
2.0 TFSI quattro	183 -	09/16→					
	185						
3.0 TDI	160	03/17→08/18					
3.0 TDI quattro	160 -	09/16→					
	210						
30 TDI Mild Hybrid	100	10/19→					
35 TDI	110 -	01/17→					
	120						
35 TFSI Mild Hybrid	110	08/18→02/20					
40 TDI	140	09/16→02/20					
40 TDI Mild Hybrid	150	09/20→					
40 TDI Mild Hybrid quattro	150	09/20→					
40 TDI quattro	140	08/16→02/20					
40 TFSI g-tron	125	02/17→					
40 TFSI Mild Hybrid	140 -	05/17→					
	150						











	kW			 	! #		
AUDI - A5 Sportback (F5A, F5F) 06/16→							
 Brake Hose							
40 TFSI Mild Hybrid quattro	150	06/20→	←	+PR 1LA / 1LB; ☐		24.5141-0637.3 331628	L= 637
45 TDI quattro	170	07/18→02/20					
45 TFSI Mild Hybrid quattro	180	07/18→02/20					
45 TFSI Mild Hybrid quattro	180	02/19→					
50 TDI Mild Hybrid quattro	195						
50 TDI Mild Hybrid quattro	210	08/20→					
50 TDI quattro	210	01/17→02/20					
RS5 quattro	331	06/18→					
S5 quattro	260	09/16→					
S5 TDI Mild Hybrid quattro	251 - 255	12/18→					
AUDI - A6 Allroad C7 (4GH, 4GJ) 01/12→09/18							
 Brake Hose							
3.0 TDI quattro	140 - 235	01/12→09/18	→		2	24.5140-0421.3 331622	L= 420
3.0 TFSI quattro	228 - 245	01/12→09/18					
AUDI - A6 C7 (4G2, 4GC) 11/10→09/18							
 Brake Hose							
1.8 TFSI	140	09/14→09/18	→	+PR 1KW / 1KY / 2EA / 2EE / 2EJ	2	24.5140-0421.3 331622	L= 420
2.0 TDI	100 - 140	01/12→09/18					
2.0 TDI quattro	140	04/15→09/18					
2.0 TFSI	132 - 185	05/11→09/18					
2.0 TFSI Hybrid	155	11/11→04/15					
2.0 TFSI quattro	155 - 185	05/12→09/18					
2.8 FSI quattro	162	09/14→09/18					
3.0 TDI	155 - 160	09/14→09/18					
3.0 TDI quattro	155 - 240	09/14→09/18					
3.0 TFSI quattro	245 - 250	09/14→09/18					
S6 quattro	331	10/14→09/18					
2.0 TDI	120 - 130	03/11→09/18	→	04/11→; +PR 1KW / 1KY / 2EA / 2EE / 2EJ	2	24.5140-0421.3 331622	L= 420
2.0 TFSI	155	03/11→05/13					
2.8 FSI	150	11/10→04/15					
2.8 FSI quattro	150	11/10→04/15					
3.0 TDI	150	11/10→09/18					
3.0 TDI quattro	150 - 180	03/11→09/18					
3.0 TFSI quattro	220 - 228	11/10→09/18					
2.0 TFSI	162	05/13→09/18	→	09/14→; +PR 1KW / 1KY / 2EA / 2EE / 2EJ	2	24.5140-0421.3 331622	L= 420
3.0 TDI quattro	230	11/11→09/18	→	12/11→; +PR 1KW / 1KY / 2EA / 2EE / 2EJ	2	24.5140-0421.3 331622	L= 420
S6 quattro	309	02/12→09/18	→	04/12→; +PR 1KW / 1KY / 2EA / 2EE / 2EJ	2	24.5140-0421.3 331622	L= 420
AUDI - A6 C7 Avant (4G5, 4GD) 05/11→09/18							
 Brake Hose							
1.8 TFSI	140	09/14→09/18	→	+PR 1KW / 1KY / 2EA / 2EE / 2EJ	2	24.5140-0421.3 331622	L= 420
2.0 TDI	100 - 140	01/12→09/18					
2.0 TDI quattro	140	04/15→09/18					
2.0 TFSI	132 - 185	06/11→09/18					
2.0 TFSI quattro	183 - 185	05/15→09/18					
2.8 FSI quattro	162	09/14→09/18					
3.0 TDI	155 - 160	09/14→09/18					
3.0 TDI quattro	155 - 240	09/14→09/18					
3.0 TFSI quattro	228 - 245	11/11→09/18					
S6 quattro	331	10/14→09/18					
2.0 TDI	120 - 130	05/11→09/18	→	09/11→; +PR 1KW / 1KY / 2EA / 2EE / 2EJ	2	24.5140-0421.3 331622	L= 420
2.8 FSI	150	05/11→04/15					
2.8 FSI quattro	150	05/11→04/15					









	kw					! #		
AUDI - A6 C7 Avant (4G5, 4GD) 05/11→09/18								
 Brake Hose								
3.0 TDI 3.0 TDI quattro	150 150 - 180	05/11→09/18 05/11→09/18	➔	09/11→; +PR 1KW / 1KY / 2EA / 2EE / 2EJ		2	24.5140-0421.3 331622	L= 420
3.0 TFSI quattro 3.0 TDI quattro	220 230	05/11→05/12 11/11→09/18	➔	12/11→; +PR 1KW / 1KY / 2EA / 2EE / 2EJ		2	24.5140-0421.3 331622	L= 420
RS6 performance quattro	445	11/15→09/18	➔	+PR 1KJ / 1KQ		2	24.5140-0421.3 331622	L= 420
RS6 quattro	412	01/13→09/18	➔	03/13→; +PR 1KJ / 1KQ		2	24.5140-0421.3 331622	L= 420
S6 quattro	309	02/12→09/18	➔	04/12→; +PR 1KW / 1KY / 2EA / 2EE / 2EJ		2	24.5140-0421.3 331622	L= 420
AUDI - A7 Sportback (4GA, 4GF) 07/10→05/18								
 Brake Hose								
1.8 TFSI 2.0 TFSI 2.0 TFSI quattro	140 185 183 - 185	04/15→05/18 09/14→05/18 05/15→05/18	➔	+PR 1KW / 1KY / 2EA / 2EE / 2EJ		2	24.5140-0421.3 331622	L= 420
2.8 FSI quattro 3.0 TDI 3.0 TDI quattro	150 - 162 140 - 160 140 - 240	10/10→05/18 11/10→05/18 10/10→05/18						
3.0 TFSI quattro 3.0 TFSI QUATTRO S7 quattro	220 - 245 250 309 - 331	10/10→05/18 05/16→05/18 02/12→05/18						
2.8 FSI RS7 performance quattro RS7 quattro	150 445 412	02/11→03/15 11/15→04/18 10/13→04/18	➔	05/11→; +PR 1KW / 1KY / 2EA / 2EE / 2EJ +PR 1KJ / 1KQ		2	24.5140-0421.3 331622	L= 420
AUDI - TT (8J3) 07/06→01/15								
Accessory Kit, disc brake pad								
2.5 RS quattro	250 - 265	07/09→06/14	←	+PR 1LA			13.0460-0521.2 610521	
AUDI - TT Roadster (8J9) 03/07→06/14								
Accessory Kit, disc brake pad								
2.5 RS quattro	250 - 265	07/09→06/14	←	+PR 1LA			13.0460-0521.2 610521	
BMW - 1 (F40) 07/19→								
 Brake Pad Set, disc brake								
M 135i xDrive	225	07/19→	➔				13.0460-7349.2 607349	ATE + WE / - WK
BMW - 2 Gran Coupe (F44) 11/19→								
 Brake Pad Set, disc brake								
M 235i xDrive	225	11/19→	➔				13.0460-7349.2 607349	ATE + WE / - WK
BMW - X2 (F39) 11/17→								
 Brake Pad Set, disc brake								
M35i	225	11/18→	➔				13.0460-7349.2 607349	ATE + WE / - WK
CHEVROLET - CAMARO 09/15→								
 Brake Pad Set, disc brake								
6.2	339	09/15→	←	- Performance Parts			13.0460-4898.2 604898	BRE + WK
CHEVROLET - CAMARO Convertible 09/15→								
 Brake Pad Set, disc brake								
6.2	333	06/16→	←	- Performance Parts			13.0460-4898.2 604898	BRE + WK
6.2	339	01/16→	←				13.0460-4898.2 604898	BRE + WK
CHEVROLET - CORVETTE (C7) 09/13→								
 Brake Pad Set, disc brake								
6.2	343	04/14→	←	for vehicles with sports package			13.0460-4898.2 604898	BRE + WK

























	kW					! #		
CHEVROLET - CORVETTE Convertible (C7) 09/13→								
 Brake Pad Set, disc brake								
6.2	343	04/14→		for vehicles with sports package			13.0460-4898.2 604898	BRE + WK
CHEVROLET - MALIBU (V300) 01/12→								
 Brake Caliper								
2.0	193	01/12→12/15		Brake Size: 17"; 			24.3601-1753.5 241439	MAN without holder
2.0 D	115 - 118	04/12→		Brake Size: 17"; 			24.3601-1754.5 241440	MAN without holder
2.4	123 - 125	01/12→						
3.0	196	04/13→						
CHEVROLET - TRAX 12/12→								
 Brake Pad Set, disc brake								
1.4	103	12/12→		2018→			13.0470-5527.2 LD5527	MAN + WK + Zub Ceramic
1.4 AWD	103	12/12→						
1.6	85	12/12→						
1.8	103	03/13→						
1.8 AWD	103	03/13→						
CHRYSLER - 300C 09/10→								
 Brake Pad Set, disc brake								
3.0 CRD	176	09/11→		for vehicles with sports package			13.0460-8018.2 608018	+ WK + Zub
3.6	210 - 218	01/11→		for individual equipment ID: BR5			13.0460-8018.2 608018	+ WK + Zub
6.4	347	09/11→						
CHRYSLER - 300C (LX, LE) 09/04→								
 Brake Pad Set, disc brake								
2.7	130 - 142	09/04→11/12		for vehicles with sports package			13.0460-8018.2 608018	+ WK + Zub
3.0 CRD	160	09/05→11/12						
3.0 V6 CRD	155	11/10→11/12						
3.5	183	09/04→11/12						
3.5 AWD	186	09/04→12/10						
5.7	250 - 268	09/04→						
5.7 AWD	268	09/08→						
6.1 SRT8	317	06/05→11/12						
CHRYSLER - 300C Touring (LX, LE) 09/04→12/10								
 Brake Pad Set, disc brake								
2.7	130 - 142	09/04→12/10		for vehicles with sports package			13.0460-8018.2 608018	+ WK + Zub
3.0 CRD	160	09/05→12/10						
3.5	183	09/04→12/10						
3.5 AWD	183	09/04→12/10						
5.7	250	09/04→12/10						
5.7 AWD	250	04/05→12/10						
6.1 SRT8	317	06/05→12/10						
CUPRA - ATECA (KH7, KHP) 09/18→								
Accessory Kit, disc brake pad								
2.0 TSI 4Drive	221 - 257	09/18→		+PR 1ZT / 1LE			13.0460-0521.2 610521	
CUPRA - FORMENTOR (KM7) 07/20→								
Accessory Kit, disc brake pad								
1.4 e-Hybrid	110 - 150	01/21→		+PR 1LE / 1LF			13.0460-0521.2 610521	
1.5 TSI	110	11/20→						
2.0 TDI	110	03/21→						
2.0 TDI 4Drive	110	03/21→						
2.0 TSI	180	03/21→						
2.0 TSI 4Drive	140 - 228	07/20→						
2.5 VZ5 4Drive	287	10/21→						
VZ 1.4 e-Hybrid	180	02/21→						
CUPRA - LEON (KL1) 09/20→								
Accessory Kit, disc brake pad								
1.4 e-HYBRID	110	09/20→		+PR 1LE			13.0460-0521.2 610521	
VZ 1.4 e-HYBRID	180	09/20→						



















	kw			 	! #		
FIAT - 500 (312_) 07/07→							
 Brake Pad Set, disc brake							
1.0 Mild Hybrid	51	01/20→	←		13.0460-7360.2	607360	ATE + WK with spring clip
FIAT - 500 C (312_) 09/09→							
 Brake Pad Set, disc brake							
1.0 Mild Hybrid	51	01/20→	←		13.0460-7360.2	607360	ATE + WK with spring clip
FIAT - 500e (332_) 10/20→							
 Brake Pad Set, disc brake							
Elektro Elektro 3+1	70 87	10/20→ 10/20→	←		13.0460-7360.2	607360	ATE + WK with spring clip
FIAT - 500e Convertible (332_) 10/20→							
 Brake Pad Set, disc brake							
Elektro	70 - 87	10/20→	←		13.0460-7360.2	607360	ATE + WK with spring clip
FIAT - PANDA (312_, 319_) 02/12→							
 Brake Pad Set, disc brake							
1.0 Mild Hybrid	51	01/20→	←		13.0460-7360.2	607360	ATE + WK with spring clip
FORD - GALAXY III (CK) 01/15→							
 Brake Pad Set, disc brake							
1.5 EcoBoost 2.0 EcoBoost 2.0 TDCi	118 176 88 - 132	01/15→06/18 01/15→ 01/15→06/18	←	Rim Size [in]: 16	13.0470-7313.2	LD7313	ATE + WK Ceramic
2.0 TDCi 4x4 2.0 TDCi Bi-Turbo	110 - 132 154	05/15→06/18 01/15→06/18					
1.5 EcoBoost 2.0 EcoBlue	121 88 - 140	07/18→ 07/18→	←	Rim Size [in]: 17	13.0470-7313.2	LD7313	ATE + WK Ceramic
2.0 EcoBlue 4x4 2.0 EcoBlue Bi-Turbo	110 - 140 176	07/18→ 07/18→					
FORD - GALAXY MK III VAN (CK) 03/19→							
 Brake Pad Set, disc brake							
2.0 EcoBlue 2.0 EcoBlue AWD	110 140	03/19→ 03/19→	←	Rim Size [in]: 17	13.0470-7313.2	LD7313	ATE + WK Ceramic
FORD - MONDEO V Hatchback (CE) 09/14→							
 Brake Pad Set, disc brake							
1.0 EcoBoost 1.5 EcoBoost	92 118 - 121	02/15→ 09/14→	←		13.0470-7313.2	LD7313	ATE + WK Ceramic
1.5 TDCi 1.6 TDCi	88 85	03/15→ 09/14→					
2.0 EcoBlue	88 - 140	01/19→					
2.0 EcoBlue 4x4 2.0 EcoBoost	140 149 - 176	01/19→ 09/14→					
2.0 TDCi	110 - 132	09/14→					
2.0 TDCi 4x4 2.0 TDCi Bi-Turbo	110 - 132 154	02/15→ 03/15→					
FORD - MONDEO V Saloon (CD) 09/12→							
 Brake Pad Set, disc brake							
1.0 EcoBoost 1.5 EcoBoost	92 118 - 121	02/15→ 09/14→	←		13.0470-7313.2	LD7313	ATE + WK Ceramic
1.5 TDCi 2.0 EcoBlue	88 88 - 140	03/15→ 01/19→					
2.0 EcoBlue 4x4 2.0 EcoBoost	140 146 - 179	01/19→ 09/12→					
2.0 Hybrid	103 - 140	08/14→					
→							









	kw			 	! #		
FORD - MONDEO V Saloon (CD) 09/12→							
 Brake Pad Set, disc brake							
2.0 TDCi	110 - 132	09/14→	←			13.0470-7313.2 LD7313	ATE + WK Ceramic
2.0 TDCi 4x4	110 - 132	09/14→					
2.0 TDCi Bi-Turbo	154	05/15→					
2.5	110	05/15→					
FORD - MONDEO V Turnier (CF) 09/14→							
 Brake Pad Set, disc brake							
1.0 EcoBoost	92	02/15→	←			13.0470-7313.2 LD7313	ATE + WK Ceramic
1.5 EcoBoost	118 - 121	09/14→					
1.5 TDCi	88	03/15→					
1.6 TDCi	85	09/14→					
2.0 EcoBlue	88 - 140	01/19→					
2.0 EcoBlue 4x4	140	01/19→					
2.0 EcoBoost	149 - 176	09/14→					
2.0 Hybrid	103	02/19→					
2.0 Hybrid iVCT	138	01/19→					
2.0 TDCi	110 - 132	09/14→					
2.0 TDCi 4x4	110 - 132	02/15→					
2.0 TDCi Bi-Turbo	154	03/15→					
FORD - S-MAX (CJ, WA6) 01/15→							
 Brake Pad Set, disc brake							
1.5 EcoBoost	118	01/15→06/18	←	Rim Size [in]: 16		13.0470-7313.2 LD7313	ATE + WK Ceramic
2.0 EcoBoost	176	01/15→					
2.0 TDCi	88 - 132	01/15→06/18					
2.0 TDCi 4x4	110 - 132	01/15→06/18					
2.0 TDCi Bi-Turbo	154	01/15→06/18					
1.5 EcoBoost	121	07/18→	←	Rim Size [in]: 17		13.0470-7313.2 LD7313	ATE + WK Ceramic
2.0 EcoBlue	88 - 110	07/18→					
2.0 EcoBlue 4x4	110	07/18→					
2.0 EcoBlue Bi-Turbo	176	07/18→					
2.0 EcoBlue	140	07/18→	←			13.0470-7313.2 LD7313	ATE + WK Ceramic
2.0 EcoBlue 4x4	140	07/18→	←	Brake Size: 17"		13.0470-7313.2 LD7313	ATE + WK Ceramic
HONDA - HR-V (RU) 11/14→							
 Brake Disc							
1.5	88 - 96	01/15→	←			24.0125-0221.1 425221	Ø 293 Brake Disc Thickness [mm] 25 Minimum thickness [mm] 23 Vented
1.5 i-VTEC	134	04/19→					
1.6 i-DTEC	88	08/15→					
1.8	104	11/14→					
HYUNDAI - ACCENT III (MC) 08/05→12/10							
 Wheel Brake Cylinder							
1.4 GL	71	11/05→11/10	→	- ABS	2	24.3217-1740.3 020607	ALU
1.5 CRDi GLS	81	11/05→11/10					
1.6 GLS	82	11/05→11/10					
HYUNDAI - ACCENT III Saloon (MC) 11/05→12/12							
 Wheel Brake Cylinder							
1.4 GL	71	11/05→11/10	→	- ABS	2	24.3217-1740.3 020607	ALU
1.5	75	01/08→12/12					
1.5 CRDi GLS	81	11/05→11/10					
1.6 GLS	82	11/05→11/10					
HYUNDAI - ACCENT IV (RB) 11/10→							
Accessory Kit, parking brake shoes							
1.4	73 - 74	04/15→	→	for vehicles with drum brakes on the rear axle		03.0137-9348.2 669348	
1.4	79	11/10→	→			03.0137-9348.2 669348	
HYUNDAI - ACCENT IV Saloon (RB) 08/10→							
Accessory Kit, parking brake shoes							
1.4	74	11/10→	→			03.0137-9348.2 669348	
1.4 CRDi	66	11/10→	→				

	kW			 	! #		
HYUNDAI - ACCENT V Saloon (HC) 01/17→							
Accessory Kit, parking brake shoes							
1.4	74	07/18→	➔			03.0137-9348.2 669348	
HYUNDAI - BAYON (BC3) 05/21→							
Accessory Kit, parking brake shoes							
1.0 T-GDI	74	05/21→	➔			03.0137-9348.2 669348	
1.0 T-GDI 48V-Hybrid	74 - 88	05/21→					
1.2 MPI	62	05/21→					
1.4 MPI	74	05/21→					
HYUNDAI - ELANTRA III (XD) 03/00→08/06							
 Brake Caliper							
1.5 VVTi	77	08/03→05/06	←	☐		24.3541-9953.5 241455	without holder
1.6	82	09/03→07/06	←	☐		24.3541-9954.5 241456	without holder
1.6	66 - 79	06/00→07/06	←	10/01→ 05/06; ☐		24.3541-9953.5 241455	without holder
1.8	97	06/00→07/06	←	10/01→ 05/06; ☐		24.3541-9954.5 241456	without holder
2.0	102 - 104	06/00→07/06					
2.0 CRDi	83	04/01→07/06					
1.6	77	05/03→07/06	←	08/03→ 05/06; ☐		24.3541-9953.5 241455	without holder
			←	08/03→ 05/06; ☐		24.3541-9954.5 241456	without holder
2.0	105	10/03→07/06	←	→ 05/06; ☐		24.3541-9953.5 241455	without holder
			←	→ 05/06; ☐		24.3541-9954.5 241456	without holder
HYUNDAI - ELANTRA III Saloon (XD) 03/00→09/06							
 Brake Caliper							
1.6	66 - 79	06/00→07/06	←	10/01→ 05/06; ☐		24.3541-9953.5 241455	without holder
1.8	97	06/00→07/06	←	10/01→ 05/06; ☐		24.3541-9954.5 241456	without holder
2.0	102 - 104	06/00→07/06					
2.0 CRDi	83	04/01→07/06					
1.6	77	05/03→05/06	←	08/03→; ☐		24.3541-9953.5 241455	without holder
			←	08/03→; ☐		24.3541-9954.5 241456	without holder
1.8	79	06/00→07/03	←	10/01→; ☐		24.3541-9953.5 241455	without holder
			←	10/01→; ☐		24.3541-9954.5 241456	without holder
2.0	105	10/03→07/06	←	→ 05/06; ☐		24.3541-9953.5 241455	without holder
			←	→ 05/06; ☐		24.3541-9954.5 241456	without holder
HYUNDAI - GETZ (TB) 06/01→01/11							
Accessory Kit, parking brake shoes							
1.1	46	09/02→09/05	➔	→ 07/05; + ABS		03.0137-9348.2 669348	
1.6	77	09/02→09/05					
1.1	49	09/05→06/09	➔	→ 02/09; + ABS		03.0137-9348.2 669348	
1.4 i	71	08/05→12/10					
1.5 CRDi	65	08/05→06/09					
1.3	61 - 63	09/03→06/09	➔	→ 04/05; + ABS		03.0137-9348.2 669348	
1.5 CRDi	60	03/03→09/05					
1.5 i	73	03/03→09/05					
1.3 i	60	09/02→03/04	➔	+ ABS		03.0137-9348.2 669348	
1.6	78	06/05→06/09	➔	08/05→; + ABS		03.0137-9348.2 669348	
HYUNDAI - i10 I (PA) 10/07→							
 Brake Master Cylinder							
1.2	64	12/15→		for left-hand drive vehicles		24.4120-1713.3 011102	Ø 20.6 without brake fluid reservoir
Accessory Kit, parking brake shoes							
1.0	51	01/11→12/17	➔			03.0137-9348.2 669348	
1.1	48 - 51	12/07→12/13					
1.1 CRDi	55	01/08→12/11					
1.1 LPG	48 - 51	01/09→12/13					
1.2	55 - 64	10/08→					
1.2 LPG	57	01/10→12/13					
➔							

	kW			 	! #		
HYUNDAI - i10 I (PA) 10/07→							
Accessory Kit, parking brake shoes							
1.2	57	11/08→12/11	➔	09/10→		03.0137-9348.2 669348	
HYUNDAI - i10 II (BA, IA) 08/13→							
 Brake Master Cylinder							
1.0	49	08/13→		12/13→; for left-hand drive vehicles		24.4120-1713.3 011102	Ø 20.6 without brake fluid reservoir
1.0 LPG	49 - 51	02/14→		for left-hand drive vehicles		24.4120-1713.3 011102	Ø 20.6 without brake fluid reservoir
1.2	64	12/13→					
Accessory Kit, parking brake shoes							
1.0	49	08/13→	➔			03.0137-9348.2 669348	
1.0 LPG	49 - 51	02/14→					
1.2	64	12/13→					
HYUNDAI - i10 II Saloon 12/13→							
 Brake Master Cylinder							
1.2	64	08/15→		for left-hand drive vehicles		24.4120-1713.3 011102	Ø 20.6 without brake fluid reservoir
HYUNDAI - i10 III (AC3, AI3) 09/19→							
Accessory Kit, parking brake shoes							
1.0 MPI	49	09/19→	➔			03.0137-9348.2 669348	
1.0 T-GDi	74	02/20→					
1.2 MPI	62	09/19→					
HYUNDAI - i20 I (PB, PBT) 08/08→							
Accessory Kit, parking brake shoes							
1.1 CRDi	55	03/12→12/15	➔	- ESP		03.0137-9348.2 669348	
1.2	56 - 63	08/08→12/15					
1.2 LPG	60	01/09→08/14					
1.6	91	12/08→					
HYUNDAI - i20 II (GB, IB) 11/14→							
Accessory Kit, parking brake shoes							
1.0 T-GDI	74 - 88	01/16→	➔			03.0137-9348.2 669348	
1.1 CRDi	55	11/14→					
1.2	55 - 62	11/14→					
1.2 LPG	55	01/19→					
1.2 LPGI	61	11/14→					
1.4	74	11/14→					
1.4 CRDi	66	11/14→					
HYUNDAI - i20 II Coupe (GB) 03/15→							
Accessory Kit, parking brake shoes							
1.0 T-GDI	74 - 88	01/16→	➔			03.0137-9348.2 669348	
1.1 CRDi	55	05/15→					
1.2	62	05/15→					
1.4	74	05/15→					
1.4 CRDi	66	05/15→					
HYUNDAI - i20 II Hatchback Van (GB, IB) 11/14→							
Accessory Kit, parking brake shoes							
1.0 T-GDI	74	01/16→	➔			03.0137-9348.2 669348	
1.1 CRDi	55	05/15→					
1.2 MPI	55 - 62	05/15→					
1.4 CRDi	66	05/15→					
1.4 MPI	74	05/15→					
HYUNDAI - i20 III (BC3, BI3) 08/20→							
Accessory Kit, parking brake shoes							
1.0 T-GDI	74	08/20→	➔			03.0137-9348.2 669348	
1.0 T-GDI hybrid 48V	74 - 88	08/20→					
1.2	62	08/20→					

	kw			 	! #		
HYUNDAI - i20 ACTIVE (IB, GB) 09/15→							
Accessory Kit, parking brake shoes							
1.0 T-GDI 1.4	88 74	09/15→ 09/15→	➔			03.0137-9348.2 669348	
HYUNDAI - i30 (GD) 06/11→							
 Brake Caliper							
1.4 1.4 CRDi 1.4 LPG 1.6 1.6 CRDi 1.6 GDI	73 66 73 88 - 96 81 - 94 99	12/11→12/15 12/11→12/16 01/13→ 12/11→ 12/11→12/16 12/11→12/16	←	Brake Size: 16"; 		24.3571-1805.5 241414	without holder
1.4 1.6 CRDi	74 100	12/14→12/16 11/11→12/16	←	Brake Size: 16"; → 01/15; 		24.3571-1805.5 241414	without holder
HYUNDAI - i30 Coupe 05/13→							
 Brake Caliper							
1.4 1.4 CRDi 1.6 CRDi 1.6 GDI	73 66 81 - 100 99	05/13→ 05/13→ 05/13→ 05/13→	←	Brake Size: 16"; 		24.3571-1805.5 241414	without holder
HYUNDAI - i30 Estate (GD) 06/12→							
 Brake Caliper							
1.4 1.4 CRDi 1.6 1.6 CRDi 1.6 GDI	73 - 74 66 88 - 95 81 - 100 99	06/12→ 06/12→ 06/12→ 06/12→ 06/12→	←	Brake Size: 16"; 		24.3571-1805.5 241414	without holder
HYUNDAI - i30 Hatchback Van (GDE) 06/12→							
 Brake Caliper							
1.6 CRDi 1.6 GDI	81 99	05/15→ 05/15→	←	Brake Size: 16"; 		24.3571-1805.5 241414	without holder
HYUNDAI - i30 Kombi Van (GDE, GD) 06/12→							
 Brake Caliper							
1.4 MPI	74	05/15→	←	Brake Size: 16"; 		24.3571-1805.5 241414	without holder
HYUNDAI - MATRIX (FC) 06/01→08/10							
 Brake Caliper							
1.5 CRDi 1.6 1.8	60 76 90	10/01→08/10 06/01→08/10 06/01→08/10	←	03/02→; 		24.3541-9953.5 241455	without holder
1.5 CRDi 1.5 CRDi VGT 1.6	75 81 66	12/04→08/10 08/05→08/10 01/02→12/05	←			24.3541-9953.5 241455	without holder
			←			24.3541-9954.5 241456	without holder
			←			24.3541-9954.5 241456	without holder
HYUNDAI - SOLARIS Saloon (HCR) 01/17→							
Accessory Kit, parking brake shoes							
1.4 1.6	74 89 - 90	01/17→ 01/17→	➔			03.0137-9348.2 669348	
KIA - CEE'D (JD) 05/12→07/18							
 Brake Caliper							
1.4 CRDi 90 1.4 CVVT 1.4 LPG 1.6 CRDi 110 1.6 CRDi 128 1.6 CVVT 1.6 GDI 1.6 GT	66 66 - 73 72 81 94 95 - 96 99 150	05/12→07/18 05/12→07/18 05/12→07/18 05/12→07/18 05/12→07/18 01/13→07/18 05/12→07/18 06/13→07/18	←	Brake Size: 16"; 		24.3571-1805.5 241414	without holder

	kw			 	! #		
KIA - CEE'D Combi Van (JD) 07/12→07/18							
 Brake Caliper							
1.4 CRDi 1.4 CVVT 1.6 CRDi 1.6 GDi	66 73 94 99	04/15→07/18 04/15→07/18 07/12→07/18 04/15→07/18	←	Brake Size: 16"; 		24.3571-1805.5 241414	without holder
KIA - CEE'D Sportswagon (JD) 09/12→07/18							
 Brake Caliper							
1.4 CRDi 90 1.4 CVVT 1.4 LPG 1.6 CRDi 110 1.6 CRDi 128 1.6 CVVT 1.6 GDI	66 73 72 81 94 95 - 96 99	09/12→07/18 09/12→07/15 01/13→07/18 03/13→07/18 09/12→07/15 11/14→07/18 09/12→07/18	←	Brake Size: 16"; 		24.3571-1805.5 241414	without holder
KIA - PICANTO III (JA) 03/17→							
 Wheel Brake Cylinder							
1.0 1.0 LPG 1.2 1.2 MPI	49 - 51 48 62 62	03/17→ 11/18→ 03/17→ 07/20→	→		2	24.3217-1740.3 020607	ALU
KIA - PRO CEE'D (JD) 03/13→07/18							
 Brake Caliper							
1.4 CRDi 90 1.4 CVVT 1.6 CRDi 110 1.6 CRDi 128 1.6 CVVT 1.6 GDI 1.6 GT 1.4 MPI	66 73 - 74 81 94 95 99 150 73	03/13→07/18 03/13→07/18 03/13→07/18 03/13→07/15 03/13→07/18 03/13→07/18 06/13→07/18 07/13→07/18	←	Brake Size: 16"; 		24.3571-1805.5 241414	without holder
			→	→ 05/15; Brake Size: 16"; 		24.3571-1805.5 241414	without holder
KIA - PRO CEE'D Hatchback Van (JD) 03/12→07/18							
 Brake Caliper							
1.4 CRDi 1.4 CVVT 1.6 CRDi 1.6 GDI	66 73 94 99	05/15→07/18 05/12→07/18 10/12→07/18 04/15→07/18	←	Brake Size: 16"; 		24.3571-1805.5 241414	without holder
KIA - RIO II (JB) 03/05→12/11							
 Wheel Brake Cylinder							
1.4 1.4 16V 1.5 CRDi 1.6 CVVT	55 71 65 - 81 82	01/10→12/11 03/05→12/11 03/05→12/11 03/05→12/11	→		2	24.3217-1740.3 020607	ALU
KIA - RIO II Saloon (JB) 03/05→12/11							
 Wheel Brake Cylinder							
1.4 16V 1.5 CRDi 1.6 16V 1.5 CRDi	71 81 82 65	03/05→12/11 03/05→12/11 03/05→12/11 06/08→12/11	→		2	24.3217-1740.3 020607	ALU
			→	- ABS	2	24.3217-1740.3 020607	ALU
KIA - RIO III (UB) 09/11→12/17							
Accessory Kit, parking brake shoes							
1.1 CRDi 1.2 1.25 1.25 CVVT 1.25 LPG 1.2 CVVT 1.4 CRDi 1.4 CVVT	55 51 64 63 - 65 63 62 66 79 - 80	09/11→12/17 09/11→12/17 11/14→12/17 09/11→12/17 09/11→12/17 11/14→12/17 09/11→12/17 09/11→12/17	→	for vehicles with drum brakes on the rear axle		03.0137-9348.2 669348	

	kw			 	! #		
KIA - RIO III Hatchback Van (UB) 09/11→							
Accessory Kit, parking brake shoes							
1.1 CRDi 1.2 CVVT 1.4 CRDi 1.4 CVVT	55 63 66 80	09/11→ 04/15→12/17 04/15→ 04/15→	➡	for vehicles with drum brakes on the rear axle		03.0137-9348.2 669348	
KIA - RIO III Saloon (UB) 09/10→12/17							
Accessory Kit, parking brake shoes							
1.25 CVVT 1.2 CVVT 1.4 CVVT	61 - 65 64 80	06/11→12/17 11/14→12/17 10/11→12/17	➡	for vehicles with drum brakes on the rear axle		03.0137-9348.2 669348	
1.4 CVVT	79	06/11→12/17	➡	09/11→; for vehicles with drum brakes on the rear axle		03.0137-9348.2 669348	
KIA - RIO IV (YB, SC, FB) 01/17→							
Accessory Kit, parking brake shoes							
1.0 T-GDI 100 1.0 T-GDI 100 Eco-Dynamics+ 1.0 T-GDI 120 1.0 T-GDI 120 Eco-Dynamics+ 1.25 1.25 LPG 1.2 CVVT 1.4 1.4 CRDi 77 1.4 CRDi 90 1.6 1.6 Flex	74 74 88 88 62 60 62 73 - 74 57 66 89 - 90 94	01/17→ 02/17→ 01/17→ 02/17→ 01/17→ 07/20→ 05/20→ 01/17→ 01/17→ 01/17→ 01/17→ 01/17→ 07/17→	➡			03.0137-9348.2 669348	
KIA - RIO IV Hatchback Van (YB, SC, FB) 01/17→							
Accessory Kit, parking brake shoes							
1.0 T-GDI 100 1.0 T-GDI 120	74 88	01/17→ 01/17→	➡			03.0137-9348.2 669348	
KIA - RIO IV Saloon (SC, FB) 07/17→							
Accessory Kit, parking brake shoes							
1.4 1.6	73 - 74 90	07/17→ 07/17→ 07/17→	➡			03.0137-9348.2 669348	
LADA - NIVA Closed Off-Road Vehicle (2121, 2131) 12/76→							
 Brake Caliper							
1600 1600 4x4	56 54 - 63	12/76→12/93 10/86→03/95	←	<input type="checkbox"/>		24.3306-1701.5 241421	without holder Brake Caliper (3 pistons)
1700 i 1900 Diesel	59 55	06/96→12/06 01/99→12/06	←	<input type="checkbox"/>		24.3306-1702.5 241422	without holder Brake Caliper (3 pistons)
1700 i 4x4	60	10/00→12/15	←	→ 12/10; <input type="checkbox"/>		24.3306-1701.5 241421	without holder Brake Caliper (3 pistons)
			←	→ 12/10; <input type="checkbox"/>		24.3306-1702.5 241422	without holder Brake Caliper (3 pistons)
1700 i 4x4	61	05/04→	←	09/10→; <input type="checkbox"/>		24.3306-1701.5 241421	without holder Brake Caliper (3 pistons)
			←	09/10→; <input type="checkbox"/>		24.3306-1702.5 241422	without holder Brake Caliper (3 pistons)
1900 Diesel	48	01/93→08/99	←	03/93→; <input type="checkbox"/>		24.3306-1701.5 241421	without holder Brake Caliper (3 pistons)
			←	03/93→; <input type="checkbox"/>		24.3306-1702.5 241422	without holder Brake Caliper (3 pistons)
LANCIA - THEMA (LX_) 09/11→10/14							
 Brake Pad Set, disc brake							
3.0 D 3.6 3.6 4WD	140 - 176 210 210	09/11→10/14 09/11→10/14 09/11→10/14	←	Vented		13.0460-8018.2 608018	+ WK + Zub

LANCIA - YPSILON (312_) 05/11→

Brake Pad Set, disc brake

1.0 Mild Hybrid	51	03/20→	←		13.0460-7360.2	607360	ATE + WK with spring clip
-----------------	----	--------	---	--	-----------------------	---------------	---------------------------

MERCEDES-BENZ - C-CLASS (W205) 07/13→

Wheel Speed Sensor

AMG C 43 4-matic	270 - 287	04/16→	→		2	24.0710-2124.3	360644	L= 1,003
C 160	95	04/15→						
C 180	110 - 115	03/14→						
C 180 BlueTEC / d	85	05/14→05/18						
C 180 d	90	05/18→						
C 200	150	08/19→						
C 200 4-matic	135 - 150	04/15→						
C 200 BlueTEC / d	100	05/14→05/18						
C 200 d	100 - 118	10/15→						
C 200 EQ Boost	135	04/18→						
C 200 EQ Boost 4-matic	135	04/18→						
C 220 BlueTEC / d	120 - 125	02/14→05/18						
C 220 d	143	05/18→						
C 220 d 4-matic	125 - 143	04/15→						
C 250	155	03/14→05/18						
C 250 BlueTEC / d	150	02/14→05/18						
C 250 BlueTEC / d 4-matic	150	02/14→05/18						
C 300	180 - 190	09/15→						
C 300 4-matic	180 - 190	12/13→						
C 300 BlueTEC Hybrid / h	150	05/14→05/18						
C 300 d	180	06/18→						
C 300 d 4-matic	180	06/18→						
C 300 de	143 - 225	05/19→						
C 300 e	155 - 235	07/19→						
C 300 e 4-matic	155 - 235	07/19→						
C 300 EQ Boost	190	05/19→						
C 300 EQ Boost 4-matic	190	05/19→						
C 350 e	155 - 205	02/15→08/18						
C 400 4-matic	245	10/14→						
C 450 AMG 4-matic	270	04/15→05/18						
C 200	135	12/13→08/18	→	02/14→	2	24.0710-2124.3	360644	L= 1,003

MERCEDES-BENZ - C-CLASS Convertible (A205) 06/16→

Wheel Speed Sensor

AMG C 43 4-matic	270 - 287	10/16→	→		2	24.0710-2124.3	360644	L= 1,003
C 180	115	06/16→						
C 200	135 - 150	06/16→						
C 200 4-matic	135	06/16→05/18						
C 200 d	118	07/18→						
C 200 EQ Boost	135	05/18→						
C 200 EQ Boost 4-matic	135	05/18→						
C 220 d	120 - 143	06/16→						
C 220 d 4-matic	125 - 143	06/16→						
C 250	155	06/16→05/18						
C 250 d	150	06/16→05/18						
C 300	180 - 190	06/16→						
C 300 d	180	07/18→						
C 300 EQ Boost	190	05/19→						
C 300 EQ Boost 4-matic	190	05/19→						
C 400 4-matic	245	06/16→						

MERCEDES-BENZ - C-CLASS Coupe (C205) 10/15→

Wheel Speed Sensor

AMG C 43 4-matic	270 - 287	04/16→	→		2	24.0710-2124.3	360644	L= 1,003
→								

MERCEDES-BENZ - C-CLASS Coupe (C205) 10/15→

Wheel Speed Sensor

C 180	110 - 115	10/15→	➔		2	24.0710-2124.3	360644	L= 1,003
C 200	135	10/15→05/18						
C 200 4-matic	135	04/16→05/18						
C 200 d	118	07/18→						
C 200 EQ Boost	135	05/18→						
C 200 EQ Boost 4-matic	135	05/18→						
C 220 d	120 - 143	10/15→						
C 220 d 4-matic	125 - 143	04/16→						
C 250	155	10/15→05/18						
C 250 d	150	10/15→05/18						
C 250 d 4-matic	150	04/16→05/18						
C 300	180 - 190	10/15→						
C 300 4-matic	190	05/18→						
C 300 d	180	07/18→						
C 300 d 4-matic	180	07/18→						
C 300 EQ Boost	190	05/19→						
C 300 EQ Boost 4-matic	190	05/19→						
C 400 4-matic	245	04/16→						

MERCEDES-BENZ - C-CLASS T-Model (S205) 09/14→

Wheel Speed Sensor

AMG C 43 4-matic	270 - 287	04/16→	➔		2	24.0710-2124.3	360644	L= 1,003
C 160	95	04/15→						
C 180	115	09/14→						
C 180 BlueTEC / d	85	09/14→05/18						
C 180 d	90	05/18→						
C 200	135	09/14→05/18						
C 200 4-matic	135	04/15→05/18						
C 200 BlueTEC / d	100	09/14→05/18						
C 200 d	100 - 118	10/15→						
C 200 EQ Boost	135	04/18→						
C 200 EQ Boost 4-matic	135	04/18→						
C 220 BlueTEC / d	120 - 125	09/14→05/18						
C 220 d	143	04/18→						
C 220 d 4-matic	125 - 143	04/15→						
C 250	155	09/14→05/18						
C 250 BlueTEC / d	150	09/14→05/18						
C 250 BlueTEC / d 4-matic	150	10/14→05/18						
C 300	180 - 190	09/15→						
C 300 4-matic	190	05/18→						
C 300 BlueTEC Hybrid / h	150	10/14→05/18						
C 300 d	180	06/18→						
C 300 d 4-matic	180	06/18→						
C 300 de	143 - 225	05/19→						
C 300 e	155 - 235	07/19→						
C 300 EQ Boost	190	05/19→						
C 300 EQ Boost 4-matic	190	05/19→						
C 350 e	155 - 205	02/15→05/18						
C 400 4-matic	245	10/14→						
C 450 AMG 4-matic	270	04/15→05/18						

MERCEDES-BENZ - CITAN Box Body/MPV (W415) 11/12→08/21































Wheel Speed Sensor













108 CDI	55 - 59	11/12→08/21	←	for steel rims	2	24.0710-2113.3	360636	L= 800
109 CDI	66 - 70	11/12→08/21	←	for light alloy rims	2	24.0710-2115.3	360638	L= 804
111 CDI	81 - 85	06/13→08/21	➔	Rim Size [in]: 14; ☐		24.0710-2112.3	360635	L= 1,624
112	84	06/13→08/21	➔	Rim Size [in]: 15 / 16; ☐		24.0710-2114.3	360637	L= 612
			➔	Rim Size [in]: 14; ☐		24.0710-2116.3	360639	L= 591











MERCEDES-BENZ - CITAN Mixto (Double Cabin) (W415) 11/12→08/21















Wheel Speed Sensor















109 CDI	66	11/12→08/21	←	for steel rims	2	24.0710-2113.3	360636	L= 800
111 CDI	81	06/13→08/21						
➔								























	kw					! #		
MERCEDES-BENZ - CITAN Mixto (Double Cabin) (W415) 11/12→08/21								
 Wheel Speed Sensor								
109 CDI 111 CDI	66 81	11/12→08/21 06/13→08/21	←	for light alloy rims	2	24.0710-2115.3	360638	L= 804
			→	Rim Size [in]: 14; 		24.0710-2112.3	360635	L= 1,624
			→	Rim Size [in]: 15 / 16; 		24.0710-2114.3	360637	L= 612
			→	Rim Size [in]: 14; 		24.0710-2116.3	360639	L= 591
MERCEDES-BENZ - CITAN MPV (W415) 11/12→08/21								
 Wheel Speed Sensor								
108 CDI	55 - 59	11/12→08/21	←	for steel rims	2	24.0710-2113.3	360636	L= 800
109 CDI	66 - 70	11/12→08/21	←	for light alloy rims	2	24.0710-2115.3	360638	L= 804
111 CDI	81 - 85	06/13→08/21	→	Rim Size [in]: 14; 		24.0710-2112.3	360635	L= 1,624
			→	Rim Size [in]: 15 / 16; 		24.0710-2114.3	360637	L= 612
112	84	06/13→08/21	→	Rim Size [in]: 14; 		24.0710-2116.3	360639	L= 591
MERCEDES-BENZ - CLA Coupe (C117) 01/13→03/19								
 Brake Pad Set, disc brake								
CLA 220 4-matic	135	04/16→03/19	→	for vehicles with sports package / for vehicles with AMG Sports Package		13.0460-2634.2	602634	TRW + WE / - WK + Zub
CLA 250 4-matic	155 - 160	07/13→03/19	→			13.0460-2634.2	602634	TRW + WE / - WK + Zub
MERCEDES-BENZ - CLA Shooting Brake (X117) 01/15→03/19								
 Brake Pad Set, disc brake								
CLA 220 4-matic CLA 220 d 4-matic CLA 250 4-matic	135 125 155 - 160	04/16→03/19 07/18→03/19 01/15→03/19	→			13.0460-2634.2	602634	TRW + WE / - WK + Zub
MERCEDES-BENZ - EQC (N293) 05/19→								
 Wheel Speed Sensor								
EQC 400 4-matic	300	05/19→	←			24.0710-2118.3	360641	L= 1,641
			←			24.0710-2119.3	360642	L= 1,604
			→			24.0710-2117.3	360640	L= 708
			→			24.0710-2120.3	360643	L= 751
MERCEDES-BENZ - GLA-CLASS (X156) 12/13→								
 Brake Pad Set, disc brake								
GLA 220 4-matic GLA 250 4-matic	135 155	01/17→ 12/13→	→			13.0460-2634.2	602634	TRW + WE / - WK + Zub
MERCEDES-BENZ - GLC (X253) 06/15→								
 Wheel Speed Sensor								
200 d 200 d 4-matic 200 EQ Boost 200 EQ Boost 4-matic 220 d 220 d 4-matic	120 120 145 145 143 120 - 143	04/19→ 04/19→ 04/19→ 04/19→ 04/19→ 06/15→ 06/15→	←			24.0710-2118.3	360641	L= 1,641
			←			24.0710-2119.3	360642	L= 1,604
			→			24.0710-2117.3	360640	L= 708
			→			24.0710-2120.3	360643	L= 751
250 4-matic 250 CNG 4-matic 250 d 4-matic 250 Flexfuel 4-matic 300 300 4-matic 300 d 4-matic 300 de 4-matic 300 e 4-matic 300 EQ Boost 4-matic 350 d 4-matic 350 e 4-matic 400 d 4-matic F-CELL 4-matic	155 155 150 155 180 180 180 143 - 225 155 - 235 190 190 155 - 235 243 80 - 155	06/15→04/19 06/15→04/19 06/15→04/19 06/15→04/19 01/16→04/19 07/15→04/19 04/19→ 05/20→ 11/19→ 04/19→ 10/16→04/19 01/16→04/19 08/19→ 04/20→ 04/16→	→					
AMG 43 4-matic	270 - 287	04/16→	→			24.0710-2117.3	360640	L= 708
			→			24.0710-2120.3	360643	L= 751























	kW			 	! #		
MERCEDES-BENZ - GLC Coupe (C253) 06/16→							
 Wheel Speed Sensor							
200 d	120	04/19→	←	☐		24.0710-2118.3 360641	L= 1,641
200 d 4-matic	120	04/19→	←	☐		24.0710-2119.3 360642	L= 1,604
200 EQ Boost	145	04/19→	→	☐		24.0710-2117.3 360640	L= 708
200 EQ Boost 4-matic	145	04/19→	→	☐		24.0710-2120.3 360643	L= 751
220 d 4-matic	120 - 143	06/16→	→	☐			
250 4-matic	155	06/16→04/19					
250 d 4-matic	150	06/16→04/19					
260 4-matic	145	11/19→					
300 4-matic	180 - 190	10/16→					
300 d 4-matic	180	04/19→					
300 de 4-matic	143 - 225	05/20→					
300 e 4-matic	155 - 235	11/19→					
300 EQ Boost 4-matic	190	04/19→					
350 d 4-matic	190	10/16→04/19					
350 e 4-matic	155 - 235	10/16→04/19					
400 d 4-matic	243	08/19→					
AMG 43 4-matic	270 - 287	10/16→	→	☐		24.0710-2117.3 360640	L= 708
			→	☐		24.0710-2120.3 360643	L= 751
MERCEDES-BENZ - S-CLASS (W222, V222, X222) 05/13→							
 Brake Pad Set, disc brake							
S 300 BlueTEC Hybrid / h	150 - 170	02/14→05/17	→			13.0470-2780.2 LD2780	TRW + WE / - WK + Zub Ceramic
S 320	200	05/14→					
S 350 BlueTEC / d	190	05/13→05/17					
S 350 BlueTEC / d 4-matic	190	02/14→05/17					
S 350 BlueTEC 4-matic	185	02/14→05/17					
S 350 d	210	07/17→					
S 350 d 4-matic	183 - 210	05/17→					
MERCEDES-BENZ - SL (R231) 12/11→							
 Brake Pad Set, disc brake							
350	225	02/12→	→	03/12→		13.0470-2780.2 LD2780	TRW + WE / - WK + Zub Ceramic
MERCEDES-BENZ - SPRINTER 4,6-t Platform/Chassis (B906) 06/06→							
 Brake Caliper							
411 CDI	80 - 84	06/09→	←	☐		24.3521-8503.5 241461	ATE without holder
413 CDI	95	03/09→	←	☐		24.3521-8504.5 241462	ATE without holder
414 CDI	105	05/16→					
415 CDI	110	06/06→					
416 CDI	120	03/09→					
418 CDI	135	06/06→12/09					
419 CDI	140	03/09→					
424	190	06/06→12/13					
MERCEDES-BENZ - SPRINTER 4,6-t Van (B906) 06/06→							
 Brake Caliper							
411 CDI	80 - 84	06/09→	←	☐		24.3521-8503.5 241461	ATE without holder
413 CDI	95	06/06→05/16	←	☐		24.3521-8504.5 241462	ATE without holder
414 CDI	105	05/16→					
414 CDI 4x4	105	05/16→					
415 CDI	110	06/09→12/09					
416 CDI	120	03/09→					
416 CDI 4x4	120	11/13→					
418 CDI	135	06/09→05/16					
419 CDI	140	03/09→					
424	190	06/06→12/13					
MERCEDES-BENZ - SPRINTER 5-t Bus (B906) 06/06→							
 Brake Caliper							
513 CDI	95	03/09→	←	☐		24.3521-8503.5 241461	ATE without holder
515 CDI	110	06/06→	←	☐		24.3521-8504.5 241462	ATE without holder
516 CDI	120	03/09→	←	☐			
519 CDI	140	03/09→					











	kW			 	! #			
MERCEDES-BENZ - SPRINTER 5-t Platform/Chassis (B906) 06/06→								
 Brake Caliper								
509 CDI	65	06/06→12/09	←	<input type="checkbox"/>		24.3521-8503.5	241461	ATE without holder
510 CDI	70	03/09→						
511 CDI	80 - 84	06/06→	←	<input type="checkbox"/>		24.3521-8504.5	241462	ATE without holder
511 CDI 4x4	80	06/06→12/09						
513 CDI 4x4	95	05/11→05/16						
514 CDI	105	05/16→						
514 CDI 4x4	105	05/16→						
515 CDI	110	06/06→						
515 CDI 4x4	110	06/06→12/09						
516	115	09/08→						
516 CDI	120	03/09→						
516 CDI 4x4	120	05/11→						
516 NGT	115	09/08→						
518 CDI	135	06/06→12/09						
518 CDI 4x4	135	06/06→12/09						
519 CDI / BlueTEC	140	03/09→						
519 CDI / BlueTEC 4x4	140	03/09→						
524	190	06/06→12/13						
513 CDI	95	06/06→05/16	←	03/09→; <input type="checkbox"/>		24.3521-8503.5	241461	ATE without holder
			←	03/09→; <input type="checkbox"/>		24.3521-8504.5	241462	ATE without holder
MERCEDES-BENZ - SPRINTER 5-t Van (B906) 06/06→								
 Brake Caliper								
509 CDI	65	06/06→12/09	←	<input type="checkbox"/>		24.3521-8503.5	241461	ATE without holder
510 CDI	70	03/09→05/16						
511 CDI	80 - 84	06/06→	←	<input type="checkbox"/>		24.3521-8504.5	241462	ATE without holder
511 CDI 4x4	80	06/06→12/09						
513 CDI 4x4	95	06/06→						
514 CDI	105	05/16→						
514 CDI 4x4	105	05/16→						
515 CDI	110	06/06→						
515 CDI 4x4	110	06/06→12/09						
516	115	03/09→						
516 CDI	120	03/09→						
516 CDI 4x4	120	06/06→						
516 NGT	115	03/09→						
518 CDI	135	06/06→12/09						
518 CDI 4x4	135	06/06→12/09						
519 CDI / BlueTEC	140	03/09→						
519 CDI / BlueTEC 4x4	140	03/09→						
524	190	06/06→12/13						
513 CDI	95	06/06→	←	03/09→; <input type="checkbox"/>		24.3521-8503.5	241461	ATE without holder
			←	03/09→; <input type="checkbox"/>		24.3521-8504.5	241462	ATE without holder
MERCEDES-BENZ - VIANO (W639) 09/03→								
 Cable Pull, parking brake								
3.2	140 - 160	09/03→			for left-hand drive vehicles; Wheelbase [mm]: 3,430; RWD; for facelift; <input type="checkbox"/>	24.3727-0489.2	580489	L= 2,983
3.5	190	09/07→						
3.7	165 - 170	06/04→						
CDI 2.0	80 - 85	09/03→						
CDI 2.0 4-matic	80 - 85	07/05→						
CDI 2.2	70 - 120	09/03→						
CDI 2.2 4-matic	100 - 120	07/05→						
CDI 3.0	150 - 165	03/06→						
MERCEDES-BENZ - VITO / MIXTO Van (W639) 08/03→								
 Cable Pull, parking brake								
109 CDI	65 - 70	09/03→			for left-hand drive vehicles; Wheelbase [mm]: 3,430; RWD; for facelift; <input type="checkbox"/>	24.3727-0489.2	580489	L= 2,983
110 CDI	70	09/10→						
111 CDI	80 - 85	09/03→						
111 CDI 4x4	80	09/07→						
113 CDI	100	09/10→						
113 CDI 4x4	100	09/10→						
115 CDI	110	09/03→						
115 CDI 4x4	110	07/06→						
116 CDI	120	09/10→						
116 CDI 4x4	120	09/10→						

	kw			 	! #		
MERCEDES-BENZ - VITO / MIXTO Van (W639) 08/03→							
 Cable Pull, parking brake							
119 120 CDI 122 122 CDI 123 126	140 150 160 165 170 190	09/03→ 07/06→ 09/03→ 09/10→ 06/04→07/08 09/07→		for left-hand drive vehicles; Wheelbase [mm]: 3,430; RWD; for facelift; <input type="checkbox"/>		24.3727-0489.2 580489	L= 2,983
MERCEDES-BENZ - VITO Bus (W639) 09/03→							
 Cable Pull, parking brake							
109 CDI 109 CDI 4x4 110 CDI 111 CDI 111 CDI 4x4 113 CDI 113 CDI 4x4 115 CDI 115 CDI 4x4 116 CDI 116 CDI 4x4 119 120 CDI 122 122 CDI 123 126	65 - 70 70 70 80 - 85 80 100 100 110 110 120 120 140 150 160 165 170 190	09/03→ 09/07→08/14 09/10→08/14 09/03→ 09/07→08/14 09/10→ 09/10→08/14 09/03→ 09/07→08/14 09/10→ 09/10→08/14 09/03→ 07/06→ 09/03→ 09/10→ 06/04→07/08 09/07→		for left-hand drive vehicles; Wheelbase [mm]: 3,430; RWD; for facelift; <input type="checkbox"/>		24.3727-0489.2 580489	L= 2,983
MINI - MINI CLUBMAN (F54) 11/14→							
 Brake Pad Set, disc brake							
John Cooper Works	225	07/19→	➡			13.0460-7349.2 607349	ATE + WE / - WK
MINI - MINI COUNTRYMAN (F60) 10/16→							
 Brake Pad Set, disc brake							
John Cooper Works ALL4	225	07/19→	➡			13.0460-7349.2 607349	ATE + WE / - WK
MITSUBISHI - COLT VI (Z3_A, Z2_A) 10/02→12/12							
 Brake Hose							
1.1 1.1 LPG 1.3 1.3 Flexfuel 1.3 LPG	55 55 68 - 70 70 70	10/04→06/12 10/04→06/12 06/04→06/12 10/08→06/12 06/04→06/12	➡	02/09→; for vehicles with drum brakes on the rear axle	2	24.5201-0265.3 331623	L= 265
NISSAN - CABSTAR (F24M, F24W) 09/06→12/13							
 Brake Caliper							
32.11 DCI 35.11 DCI 2.5 28.11 DCI 32.12 DCI 34.12 DCI 28.12 DCI 35.12 DCI 2.5 34.110 DCI 2.5 35.14 DCI 45.14 DCI 2.5 45.13 DCI 2.5 35.13 DCI 35.14 DCI 3.0 35.15 DCI 45.15 DCI 3.0	81 81 81 90 90 90 90 82 100 100 96 96 101 110 110	09/06→12/13 09/06→12/13 09/06→12/13 09/06→12/13 09/06→12/13 09/06→12/13 09/06→12/13 01/07→04/12 09/06→12/13 09/06→12/13 09/06→12/12 09/06→12/12 09/06→12/13 09/06→12/13 09/06→12/13	←	<input type="checkbox"/>		24.3481-9961.5 241459	ATE without holder
			←	Gross vehicle weight [kg]: 3,500; <input type="checkbox"/>		24.3481-9961.5 241459	ATE without holder
NISSAN - LEAF (ZE1) 08/17→							
 Brake Pad Set, disc brake							
Electric	110 - 160	08/17→	←			13.0470-5508.2 LD5508	AKE + WK Ceramic

	kw					! #			
NISSAN - NT400 CABSTAR (F24M) 08/09→									
 Brake Caliper									
28.12	90	01/14→	←	☐			24.3481-9961.5	241459	ATE without holder
32.12	90	01/14→							
35.12	90	01/14→							
35.13	96	09/16→	←		Gross vehicle weight [kg]: 3,500; ☐		24.3481-9961.5	241459	ATE without holder
45.14	100	01/14→							
35.14	100	01/14→							
45.15	107 -	01/14→							
35.15	110	01/14→							
	110	01/14→							
NISSAN - NV200 Van 02/10→									
 Brake Pad Set, disc brake									
e-NV	80	05/14→	←		04/17→		13.0470-5508.2	LD5508	AKE + WK Ceramic
NISSAN - NV250 Bus (X61) 07/19→									
 Wheel Speed Sensor									
dCi 115	85	07/19→	←			2	24.0710-2113.3	360636	L= 800
dCi 80	59	07/19→	→	☐			24.0710-2112.3	360635	L= 1,624
dCi 95	70	07/19→	→	☐			24.0710-2116.3	360639	L= 591
NISSAN - NV250 Van (X61) 07/19→									
 Wheel Speed Sensor									
dCi 115	85	07/19→	←			2	24.0710-2113.3	360636	L= 800
dCi 80	59	07/19→	→	☐			24.0710-2112.3	360635	L= 1,624
dCi 95	70	07/19→	→	☐			24.0710-2116.3	360639	L= 591
OPEL - AMPERA (R12) 11/11→03/15									
 Brake Pad Set, disc brake									
EV 150	111	11/11→03/15	←		JB000001 / J4000001→		13.0470-5527.2	LD5527	MAN + WK + Zub Ceramic
OPEL - ASTRA J (P10) 09/09→10/15									
 Brake Caliper									
1.3 CDTi	70	12/09→10/15	←		for brake disc diameter [mm]: 321; ☐		24.3601-1753.5	241439	MAN without holder
1.4	64 -	12/09→10/15	←		for brake disc diameter [mm]: 321; ☐		24.3601-1754.5	241440	MAN without holder
	74								
1.4 LPG	103	01/12→10/15							
1.4 Turbo	103	12/09→10/15							
1.6	85	12/09→10/15							
1.6 CDTi	81	02/14→10/15							
1.6 SIDI	125	12/12→10/15							
1.6 Turbo	132	12/09→10/15							
1.6 Turbo 4x4	132	12/09→10/15							
1.7 CDTi	92 -	12/09→10/15							
	96								
2.0 CDTi	96 -	06/11→10/15							
	121								
1.4 Turbo	88	10/10→10/15	←		11/10→;		24.3601-1753.5	241439	MAN without holder
			←		for brake disc diameter [mm]: 321; ☐		24.3601-1754.5	241440	MAN without holder
			←		11/10→;		24.3601-1754.5	241440	MAN without holder
			←		for brake disc diameter [mm]: 321; ☐		24.3601-1753.5	241439	MAN without holder
1.6 CDTi	100	11/13→10/15	←		01/14→;		24.3601-1753.5	241439	MAN without holder
			←		for brake disc diameter [mm]: 321; ☐		24.3601-1754.5	241440	MAN without holder
			←		01/14→;		24.3601-1754.5	241440	MAN without holder
			←		for brake disc diameter [mm]: 321; ☐		24.3601-1753.5	241439	MAN without holder
1.7 CDTi	81	09/09→10/15	←		12/09→;		24.3601-1753.5	241439	MAN without holder
2.0 CDTi	118	09/09→10/15	←		for brake disc diameter [mm]: 321; ☐		24.3601-1754.5	241440	MAN without holder
			←		12/09→;		24.3601-1754.5	241440	MAN without holder
			←		for brake disc diameter [mm]: 321; ☐		24.3601-1753.5	241439	MAN without holder
2.0 BiTurbo CDTi	143	09/12→10/15	←		12/12→;		24.3601-1753.5	241439	MAN without holder
			←		for brake disc diameter [mm]: 321; ☐		24.3601-1754.5	241440	MAN without holder
			←		12/12→;		24.3601-1754.5	241440	MAN without holder
			←		for brake disc diameter [mm]: 321; ☐		24.3601-1753.5	241439	MAN without holder
 Brake Pad Set, disc brake									
1.3 CDTi	70	12/09→10/15	←		for brake disc diameter [mm]: 300;		13.0470-5527.2	LD5527	MAN + WK + Zub Ceramic
1.4	64 -	12/09→10/15			JB000001 / J4000001→				
	74								
1.4 LPG	103	01/12→10/15							
1.4 Turbo	103	12/09→10/15							





















	kw			 	! #		
OPEL - ASTRA J (P10) 09/09→10/15							
 Brake Pad Set, disc brake							
1.6 1.6 CDTi	85 81 - 100	12/09→10/15 11/13→10/15	←	for brake disc diameter [mm]: 300; JB000001 / J4000001→		13.0470-5527.2 LD5527	MAN + WK + Zub Ceramic
1.6 SIDI 1.6 Turbo 1.6 Turbo 4x4 1.7 CDTi	125 132 132 81 - 96	12/12→10/15 12/09→10/15 12/09→10/15 09/09→10/15					
2.0 BiTurbo CDTi 2.0 CDTi	143 96 - 121	09/12→10/15 09/09→10/15					
1.4 Turbo	88	10/10→10/15	←	11/10→; for brake disc diameter [mm]: 300; JB000001 / J4000001→		13.0470-5527.2 LD5527	MAN + WK + Zub Ceramic
OPEL - ASTRA J Estate Van (P10) 09/09→10/15							
 Brake Caliper							
1.3 CDTi 1.6 CDTi	70 81	10/12→10/15 01/14→10/15	←	for brake disc diameter [mm]: 321; 		24.3601-1753.5 241439	MAN without holder
1.7 CDTi 2.0 CDTi	96 121	10/12→10/15 10/12→10/15	←	for brake disc diameter [mm]: 321; 		24.3601-1754.5 241440	MAN without holder
 Brake Pad Set, disc brake							
1.3 CDTi 1.6 CDTi 1.7 CDTi 2.0 CDTi	70 81 96 121	10/12→10/15 01/14→10/15 10/12→10/15 10/12→10/15	←	for brake disc diameter [mm]: 300; JB000001 / J4000001→		13.0470-5527.2 LD5527	MAN + WK + Zub Ceramic
OPEL - ASTRA J GTC 10/11→							
 Brake Caliper							
1.4	74 - 103	10/11→	←	for brake disc diameter [mm]: 321; 		24.3601-1753.5 241439	MAN without holder
1.6 1.6 CDTi	132 81 - 100	10/11→ 07/14→	←	for brake disc diameter [mm]: 321; 		24.3601-1754.5 241440	MAN without holder
1.6 SIDI 1.7 CDTi	125 - 147 81 - 96	12/12→ 10/11→10/15					
1.8 2.0 CDTi	103 96 - 121	10/11→10/15 10/11→10/15					
2.0 BiTurbo CDTi	143	10/12→10/15	←	12/12→; for brake disc diameter [mm]: 321; 		24.3601-1753.5 241439	MAN without holder
			←	12/12→; for brake disc diameter [mm]: 321; 		24.3601-1754.5 241440	MAN without holder
 Brake Pad Set, disc brake							
1.4 1.6 1.6 CDTi	74 - 103 132 81 - 100	10/11→ 10/11→ 07/14→	←	for brake disc diameter [mm]: 300; JB000001 / J4000001→		13.0470-5527.2 LD5527	MAN + WK + Zub Ceramic
1.6 SIDI 1.7 CDTi	125 - 147 81 - 96	12/12→ 10/11→10/15					
1.8 2.0 CDTi	103 96 - 121	10/11→10/15 10/11→10/15					
2.0 BiTurbo CDTi	143	10/12→10/15	←	12/12→; for brake disc diameter [mm]: 300; JB000001 / J4000001→		13.0470-5527.2 LD5527	MAN + WK + Zub Ceramic
OPEL - ASTRA J Hatchback Van (P10) 09/09→10/15							
 Brake Caliper							
1.3 CDTi 1.6 CDTi	70 81	05/13→10/15 01/14→10/15	←	for brake disc diameter [mm]: 321; 		24.3601-1753.5 241439	MAN without holder
1.7 CDTi	81	05/13→10/15	←	for brake disc diameter [mm]: 321; 		24.3601-1754.5 241440	MAN without holder
 Brake Pad Set, disc brake							
1.3 CDTi 1.6 CDTi 1.7 CDTi	70 81 81	05/13→10/15 01/14→10/15 05/13→10/15	←	for brake disc diameter [mm]: 300; JB000001 / J4000001→		13.0470-5527.2 LD5527	MAN + WK + Zub Ceramic

	kw			 	! #		
OPEL - ASTRA J Saloon 06/12→							
 Brake Caliper							
1.3 CDTI 1.4	70 64 - 74	06/12→10/15 06/12→10/15	←	for brake disc diameter [mm]: 321; 		24.3601-1753.5 241439	MAN without holder
1.4 LPG 1.4 Turbo	103 88 - 103	07/14→ 06/12→	←	for brake disc diameter [mm]: 321; 		24.3601-1754.5 241440	MAN without holder
1.6 1.6 CDTi	85 81 - 100	06/12→ 01/14→					
1.6 SIDI 1.6 Turbo	125 132	06/12→10/15 06/12→					
1.7 CDTI	74 - 96	06/12→10/15					
 Brake Pad Set, disc brake							
1.3 CDTI 1.4	70 64 - 74	06/12→10/15 06/12→10/15	←	for brake disc diameter [mm]: 300; JB000001 / J4000001→		13.0470-5527.2 LD5527	MAN + WK + Zub Ceramic
1.4 LPG 1.4 Turbo	103 88 - 103	07/14→ 06/12→					
1.6 1.6 CDTi	85 81 - 100	06/12→ 01/14→					
1.6 SIDI 1.6 Turbo	125 132	06/12→10/15 06/12→					
1.7 CDTI	74 - 96	06/12→10/15					
OPEL - ASTRA J Sports Tourer (P10) 10/10→10/15							
 Brake Caliper							
1.3 CDTI 1.4	70 64 - 74	10/10→10/14 10/10→10/15	←	11/10→; for brake disc diameter [mm]: 321; 		24.3601-1753.5 241439	MAN without holder
1.4 Turbo	88 - 103	10/10→10/15	←	11/10→; for brake disc diameter [mm]: 321; 		24.3601-1754.5 241440	MAN without holder
1.6 1.6 Turbo	85 132	10/10→10/15 10/10→10/15					
1.7 CDTI	74 - 96	10/10→10/15					
2.0 CDTI	118	10/10→10/15					
1.4 LPG	103	12/11→10/15	←	01/12→; for brake disc diameter [mm]: 321; 		24.3601-1753.5 241439	MAN without holder
			←	01/12→; for brake disc diameter [mm]: 321; 		24.3601-1754.5 241440	MAN without holder
1.6 CDTi 1.6 SIDI	81 125	02/14→10/15 12/12→10/15	←	for brake disc diameter [mm]: 321; 		24.3601-1753.5 241439	MAN without holder
2.0 CDTI	96 - 121	08/11→10/15	←	for brake disc diameter [mm]: 321; 		24.3601-1754.5 241440	MAN without holder
1.6 CDTi	100	11/13→10/15	←	01/14→; for brake disc diameter [mm]: 321; 		24.3601-1753.5 241439	MAN without holder
			←	01/14→; for brake disc diameter [mm]: 321; 		24.3601-1754.5 241440	MAN without holder
2.0 BiTurbo CDTI	143	09/12→10/15	←	12/12→; for brake disc diameter [mm]: 321; 		24.3601-1753.5 241439	MAN without holder
			←	12/12→; for brake disc diameter [mm]: 321; 		24.3601-1754.5 241440	MAN without holder
 Brake Pad Set, disc brake							
1.3 CDTI 1.4	70 64 - 74	10/10→10/14 10/10→10/15	←	11/10→; for brake disc diameter [mm]: 300; JB000001 / J4000001→		13.0470-5527.2 LD5527	MAN + WK + Zub Ceramic
1.4 Turbo	88 - 103	10/10→10/15					
1.6 1.6 Turbo	85 132	10/10→10/15 10/10→10/15					
1.7 CDTI	74 - 96	10/10→10/15					
2.0 CDTI	118	10/10→10/15					
1.4 LPG 1.6 CDTi	103 81 - 100	12/11→10/15 11/13→10/15	←	for brake disc diameter [mm]: 300; JB000001 / J4000001→		13.0470-5527.2 LD5527	MAN + WK + Zub Ceramic
1.6 SIDI 2.0 BiTurbo CDTI	125 143	12/12→10/15 09/12→10/15					
2.0 CDTI	96 - 121	08/11→10/15					

	kw			 	! #			
OPEL - CASCADA (W13) 03/13→04/19								
 Brake Caliper								
1.4	88	04/13→04/18	←	☐		24.3601-1753.5	241439	MAN without holder
1.4 Turbo	103	03/13→04/18	←	☐		24.3601-1754.5	241440	MAN without holder
1.6	100 - 147	11/13→04/19	←	☐				
1.6 SIDI	125	04/13→04/19						
2.0 CDTI	121 - 143	04/13→04/18						
OPEL - INSIGNIA A (G09) 07/08→03/17								
 Brake Caliper								
1.4	103	04/11→03/17	←	☐	06/11→; for brake disc diameter [mm]: 337; ☐	24.3421-1724.5	241450	without holder
			←	☐	06/11→; for brake disc diameter [mm]: 321; ☐	24.3601-1753.5	241439	MAN without holder
			←	☐	06/11→; for brake disc diameter [mm]: 321; ☐	24.3601-1754.5	241440	MAN without holder
1.4 LPG	103	07/12→03/17	←	☐	for brake disc diameter [mm]: 337; ☐	24.3421-1724.5	241450	without holder
1.6	85	07/08→03/17	←	☐	for brake disc diameter [mm]: 321; ☐	24.3601-1753.5	241439	MAN without holder
1.6 CDTi	88 - 100	07/15→03/17	←	☐	for brake disc diameter [mm]: 321; ☐	24.3601-1754.5	241440	MAN without holder
1.6 SIDI	125	03/13→03/17	←	☐	for brake disc diameter [mm]: 321; ☐			
1.8	103	07/08→03/17						
2.0 Biturbo CDTI	140 - 143	07/08→03/17						
2.0 Biturbo CDTI 4x4	140 - 143	05/09→03/17						
2.0 CDTI	81 - 125	07/08→03/17						
2.0 CDTI 4x4	118 - 125	06/10→03/17						
2.0 E85 Turbo	162	10/10→03/17						
2.0 Turbo	162 - 184	07/08→03/17						
2.0 Turbo 4x4	162	07/08→03/17						
1.6 Turbo	132	07/08→03/17	←	☐	10/08→; for brake disc diameter [mm]: 337; ☐	24.3421-1724.5	241450	without holder
			←	☐	10/08→; for brake disc diameter [mm]: 321; ☐	24.3601-1753.5	241439	MAN without holder
			←	☐	10/08→; for brake disc diameter [mm]: 321; ☐	24.3601-1754.5	241440	MAN without holder
2.0 CDTI	88	03/12→03/17	←	☐	03/13→; for brake disc diameter [mm]: 337; ☐	24.3421-1724.5	241450	without holder
			←	☐	03/13→; for brake disc diameter [mm]: 321; ☐	24.3601-1753.5	241439	MAN without holder
			←	☐	03/13→; for brake disc diameter [mm]: 321; ☐	24.3601-1754.5	241440	MAN without holder
2.0 CDTI	103	06/13→03/17	←	☐	07/13→; for brake disc diameter [mm]: 337; ☐	24.3421-1724.5	241450	without holder
			←	☐	07/13→; for brake disc diameter [mm]: 321; ☐	24.3601-1753.5	241439	MAN without holder
			←	☐	07/13→; for brake disc diameter [mm]: 321; ☐	24.3601-1754.5	241440	MAN without holder
2.0 Turbo 4x4	184	07/11→03/17	←	☐	09/11→; for brake disc diameter [mm]: 337; ☐	24.3421-1724.5	241450	without holder
			←	☐	09/11→; for brake disc diameter [mm]: 321; ☐	24.3601-1753.5	241439	MAN without holder
			←	☐	09/11→; for brake disc diameter [mm]: 321; ☐	24.3601-1754.5	241440	MAN without holder
2.8 V6 Turbo 4x4	191	07/08→03/17	←	☐	for brake disc diameter [mm]: 337; ☐	24.3421-1724.5	241450	without holder
OPEL - INSIGNIA A Country Tourer (G09) 07/08→03/17								
 Brake Caliper								
1.6 CDTi	88 - 100	07/15→03/17	←	☐	for brake disc diameter [mm]: 337; ☐	24.3421-1724.5	241450	without holder
1.6 SIDI	125	07/14→03/17	←	☐	for brake disc diameter [mm]: 321; ☐	24.3601-1753.5	241439	MAN without holder
2.0 CDTi	88 - 125	07/08→03/17	←	☐	for brake disc diameter [mm]: 321; ☐	24.3601-1754.5	241440	MAN without holder
2.0 CDTi 4x4	120 - 143	09/13→03/17						
2.0 Turbo 4x4	184	09/13→03/17						





OPEL - INSIGNIA A Saloon (G09) 07/08→03/17















 **Brake Caliper**























1.4	103	04/11→03/17	←	06/11→; for brake disc diameter [mm]: 337; 	24.3421-1724.5	241450	without holder
			←	06/11→; for brake disc diameter [mm]: 321; 	24.3601-1753.5	241439	MAN without holder
			←	06/11→; for brake disc diameter [mm]: 321; 	24.3601-1754.5	241440	MAN without holder
1.4 LPG	103	07/12→03/17	←	for brake disc diameter [mm]: 337; 	24.3421-1724.5	241450	without holder
1.6	85	07/08→03/17	←	for brake disc diameter [mm]: 321; 	24.3601-1753.5	241439	MAN without holder
1.6 CDTi	88 -	07/15→03/17	←	for brake disc diameter [mm]: 321; 	24.3601-1754.5	241440	MAN without holder
1.6 SIDI	100		←	for brake disc diameter [mm]: 321; 	24.3601-1754.5	241440	MAN without holder
1.8	125	03/13→03/17					
2.0 Biturbo CDTi	103	07/08→03/17					
2.0 Biturbo CDTi 4x4	140 -	07/08→03/17					
	143						
2.0 CDTi	140 -	07/08→03/17					
	143						
2.0 CDTi 4x4	81 -	07/08→03/17					
	125						
2.0 Turbo	118 -	06/10→03/17					
	125						
2.0 Turbo 4x4	162 -	07/08→03/17					
2.0 Turbo E85	184	07/08→03/17					
	162	07/08→03/17					
	162	07/08→03/17					
1.6 Turbo	132	07/08→03/17	←	10/08→; for brake disc diameter [mm]: 337; 	24.3421-1724.5	241450	without holder
			←	10/08→; for brake disc diameter [mm]: 321; 	24.3601-1753.5	241439	MAN without holder
			←	10/08→; for brake disc diameter [mm]: 321; 	24.3601-1754.5	241440	MAN without holder
2.0 CDTi	88	03/12→03/17	←	03/13→; for brake disc diameter [mm]: 337; 	24.3421-1724.5	241450	without holder
			←	03/13→; for brake disc diameter [mm]: 321; 	24.3601-1753.5	241439	MAN without holder
			←	03/13→; for brake disc diameter [mm]: 321; 	24.3601-1754.5	241440	MAN without holder
2.0 CDTi	103	06/13→03/17	←	07/13→; for brake disc diameter [mm]: 337; 	24.3421-1724.5	241450	without holder
			←	07/13→; for brake disc diameter [mm]: 321; 	24.3601-1753.5	241439	MAN without holder
			←	07/13→; for brake disc diameter [mm]: 321; 	24.3601-1754.5	241440	MAN without holder
2.0 Turbo 4x4	184	07/11→03/17	←	09/11→; for brake disc diameter [mm]: 337; 	24.3421-1724.5	241450	without holder
			←	09/11→; for brake disc diameter [mm]: 321; 	24.3601-1753.5	241439	MAN without holder
			←	09/11→; for brake disc diameter [mm]: 321; 	24.3601-1754.5	241440	MAN without holder
2.8 V6 Turbo 4x4	191	07/08→03/17	←	for brake disc diameter [mm]: 337; 	24.3421-1724.5	241450	without holder













OPEL - INSIGNIA A Sports Tourer (G09) 07/08→03/17













 **Brake Caliper**















1.4	103	09/11→06/13	←	for brake disc diameter [mm]: 337; 	24.3421-1724.5	241450	without holder
			←	for brake disc diameter [mm]: 321; 	24.3601-1753.5	241439	MAN without holder
			←	for brake disc diameter [mm]: 321; 	24.3601-1754.5	241440	MAN without holder
1.4 LPG	103	07/12→06/13					
1.6	85	07/08→06/12					
1.6 CDTi	88 -	07/15→01/17	←	for brake disc diameter [mm]: 321; 	24.3601-1754.5	241440	MAN without holder
	100						
1.6 SIDI	125	03/13→11/14					
1.6 Turbo	132	01/09→06/13					
1.8	103	07/08→06/13					
2.0 Biturbo CDTi	140 -	07/08→03/17					
	143						
2.0 Biturbo CDTi 4x4	140 -	07/08→03/17					
	143						
2.0 CDTi	81 -	07/08→12/16					
	125						
2.0 CDTi 4x4	118 -	06/10→12/16					
	125						
2.0 E85 Turbo	162	09/10→11/11					
2.0 Turbo	162 -	07/08→11/14					
	184						
2.0 Turbo 4x4	162 -	07/08→06/13					
	184						
2.0 CDTi	88	03/12→06/15	←	03/13→; for brake disc diameter [mm]: 337; 	24.3421-1724.5	241450	without holder
→							













	kw				! #		
OPEL - INSIGNIA A Sports Tourer (G09) 07/08→03/17							
 Brake Caliper							
2.0 CDTi	88	03/12→06/15	←	03/13→; for brake disc diameter [mm]: 321; 		24.3601-1753.5 241439	MAN without holder
			←	03/13→; for brake disc diameter [mm]: 321; 		24.3601-1754.5 241440	MAN without holder
2.8 V6 Turbo 4x4	191	10/08→06/13	←	for brake disc diameter [mm]: 337; 		24.3421-1724.5 241450	without holder
OPEL - INSIGNIA B Country Tourer (Z18) 06/17→							
 Brake Pad Set, disc brake							
1.5	121	06/17→	←	+POC JQ5; Brake Size: 18"		13.0460-4898.2 604898	BRE + WK
1.6 Turbo	147	06/18→				13.0470-4898.2 LD4898	BRE + WK Ceramic
2.0 4x4	191	06/17→					
2.0 CDTi	125	06/17→					
2.0 CDTi 4x4	125	06/17→					
2.0 GSi 4x4	154	01/18→					
OPEL - INSIGNIA B Grand Sport (Z18) 03/17→							
 Brake Pad Set, disc brake							
1.4 Turbo	107	04/20→	←	+POC JQ5; Brake Size: 18"		13.0460-4898.2 604898	BRE + WK
1.5	103 - 121	03/17→				13.0470-4898.2 LD4898	BRE + WK Ceramic
1.5 CDTi	90	02/20→					
1.6 CDTi	81 - 100	03/17→					
1.6 Turbo	147	06/18→					
2.0	147	04/20→					
2.0 4x4	191	03/17→					
2.0 CDTi	125 - 128	03/17→					
2.0 CDTi 4x4	125 - 128	03/17→					
2.0 GSi 4x4	154 - 169	03/17→					
2.0 Turbo	125 - 147	11/20→					
OPEL - INSIGNIA B Sports Tourer (Z18) 03/17→							
 Brake Pad Set, disc brake							
1.5	103 - 121	03/17→	←	+POC JQ5; Brake Size: 18"		13.0460-4898.2 604898	BRE + WK
1.5 CDTi	90	02/20→				13.0470-4898.2 LD4898	BRE + WK Ceramic
1.6 CDTi	81 - 100	03/17→					
1.6 Turbo	147	06/18→					
2.0	125 - 147	04/20→					
2.0 4x4	169 - 191	03/17→					
2.0 CDTi	125 - 128	03/17→					
2.0 CDTi 4x4	125 - 154	03/17→					
2.0 GSi 4x4	154	03/17→					
OPEL - INSIGNIA B Sports Tourer Combi Van (Z18) 03/17→							
 Brake Pad Set, disc brake							
CDTi ECOTEC	100	03/17→	←	+POC JQ5; Brake Size: 18"		13.0460-4898.2 604898	BRE + WK
						13.0470-4898.2 LD4898	BRE + WK Ceramic
OPEL - MOKKA / MOKKA X (J13) 06/12→							
 Brake Pad Set, disc brake							
1.4	88 - 103	04/13→	←	JB000001 / J4000001→		13.0470-5527.2 LD5527	MAN + WK + Zub Ceramic
1.4 4x4	103 - 112	06/12→					
1.4 LPG	103	04/13→					
1.6	85	06/12→					
1.6 CDTi	81 - 100	01/15→					
1.6 CDTi 4x4	81 - 100	01/15→					
1.7 CDTi	96	06/12→					
1.7 CDTi 4x4	96	06/12→					
1.8	103	01/13→					
1.8 4x4	103	01/13→					



















	kw					! #		
OPEL - MOKKA X VAN (J13) 06/12→								
 Brake Pad Set, disc brake								
1.6 CDTi	100	03/18→	←	JB000001 / J4000001→		13.0470-5527.2	LD5527	MAN + WK + Zub Ceramic
OPEL - ZAFIRA TOURER C (P12) 10/11→								
 Brake Caliper								
1.4	88 - 103	10/11→	←	11/11→; for brake disc diameter [mm]: 321; 		24.3601-1753.5	241439	MAN without holder
1.4 LPG	103	10/11→	←	11/11→; for brake disc diameter [mm]: 321; 		24.3601-1754.5	241440	MAN without holder
1.6 CNG	110	10/11→						
1.8	85 - 103	10/11→						
2.0 CDTi	81	10/11→						
1.6	100 - 125	12/12→	←	for brake disc diameter [mm]: 321; 		24.3601-1753.5	241439	MAN without holder
1.6 CDTI	88 - 99	07/14→	←	for brake disc diameter [mm]: 321; 		24.3601-1754.5	241440	MAN without holder
1.6 SIDI	147	07/13→	←	03/13→; for brake disc diameter [mm]: 321; 		24.3601-1753.5	241439	MAN without holder
2.0 BiTurbo CDTI	143	01/13→						
2.0 CDTi	96 - 125	10/11→						
1.6 CDTI	100	02/13→	←	03/13→; for brake disc diameter [mm]: 321; 		24.3601-1754.5	241440	MAN without holder
 Brake Pad Set, disc brake								
1.4	88 - 103	10/11→	←	11/11→; for brake disc diameter [mm]: 300; JB000001 / J4000001→		13.0470-5527.2	LD5527	MAN + WK + Zub Ceramic
1.4 LPG	103	10/11→	←	for brake disc diameter [mm]: 300; JB000001 / J4000001→		13.0470-5527.2	LD5527	MAN + WK + Zub Ceramic
1.6 CNG	110	10/11→						
1.8	85 - 103	10/11→						
2.0 CDTi	81	10/11→						
1.6	100 - 125	12/12→	←	for brake disc diameter [mm]: 300; JB000001 / J4000001→		13.0470-5527.2	LD5527	MAN + WK + Zub Ceramic
1.6 CDTI	88 - 99	07/14→	←	03/13→; for brake disc diameter [mm]: 300; JB000001 / J4000001→		13.0470-5527.2	LD5527	MAN + WK + Zub Ceramic
1.6 SIDI	147	07/13→						
2.0 BiTurbo CDTI	143	01/13→						
2.0 CDTi	96 - 125	10/11→						
1.6 CDTI	100	02/13→	←	03/13→; for brake disc diameter [mm]: 300; JB000001 / J4000001→		13.0470-5527.2	LD5527	MAN + WK + Zub Ceramic
OPEL - ZAFIRA TOURER C VAN (P12) 10/11→								
 Brake Caliper								
2.0 CDTi	81 - 121	01/12→	←	for brake disc diameter [mm]: 321; 		24.3601-1753.5	241439	MAN without holder
			←	for brake disc diameter [mm]: 321; 		24.3601-1754.5	241440	MAN without holder
 Brake Pad Set, disc brake								
2.0 CDTi	81 - 121	01/12→	←	for brake disc diameter [mm]: 300; JB000001 / J4000001→		13.0470-5527.2	LD5527	MAN + WK + Zub Ceramic
RENAULT - KANGOO / GRAND KANGOO II (KW0/1_) 02/08→								
 Wheel Speed Sensor								
1.2 TCe 115	84	07/13→	←		2	24.0710-2113.3	360636	L= 800
1.5 dCi	78	02/08→	→	Rim Size [in]: 14; 		24.0710-2112.3	360635	L= 1,624
1.5 dCi 105	76	02/08→						
1.5 dCi 110	80 - 81	09/10→						
1.5 dCi 115	85	03/19→	→	Rim Size [in]: 14; 		24.0710-2116.3	360639	L= 591
1.5 dCi 70	50	02/08→						
1.5 dCi 75	55	11/12→						
1.5 dCi 80	59	03/19→						
1.5 dCi 85	63	02/08→						
1.5 dCi 90	66 - 67	06/08→						
1.5 dCi 95	70	03/19→						
1.6	64	02/08→						
1.6 16V	78	02/08→						
1.6 16V FLEX	78	02/08→						
1.6 16V LPG	78	12/08→						































	kw					! #		
RENAULT - KANGOO BE BOP (KW0/1_) 02/09→								
 Wheel Speed Sensor								
1.5 dCi	66 - 80	02/09→	←			2	24.0710-2113.3 360636	L= 800
1.5 dCi 75	55	09/10→	→	Rim Size [in]: 14; ☐			24.0710-2112.3 360635	L= 1,624
1.6	78	02/09→12/12	→	Rim Size [in]: 14; ☐			24.0710-2116.3 360639	L= 591
RENAULT - KANGOO Express (FW0/1_) 02/08→								
 Wheel Speed Sensor								
1.2 TCe 115	84	07/13→	←			2	24.0710-2113.3 360636	L= 800
1.5 dCi 105	76	02/08→	→	Rim Size [in]: 14; ☐			24.0710-2112.3 360635	L= 1,624
1.5 dCi 110	80 - 81	09/10→	→	Rim Size [in]: 14; ☐			24.0710-2116.3 360639	L= 591
1.5 dCi 115	85	10/19→						
1.5 dCi 70	50	02/08→						
1.5 dCi 75	55	09/10→						
1.5 dCi 80	59	10/19→						
1.5 dCi 85	63	02/08→						
1.5 dCi 90	66 - 67	06/09→						
1.5 dCi 95	70	10/19→						
1.6	64	02/08→						
1.6 16V	78	02/08→						
1.6 16V FLEX	78	02/08→						
1.6 16V LPG	78	02/08→						
Z.E.	44	10/11→						
SAAB - 9-5 (YS3G) 01/10→01/12								
 Brake Caliper								
1.6 Turbo	132	05/10→01/12	←	Brake Size: 17" plus; ☐			24.3421-1724.5 241450	without holder
2.0 t BioPower	162	05/10→01/12	←	Rim Size [in]: 17; ☐			24.3601-1753.5 241439	MAN without holder
2.0 t BioPower XWD	162	05/10→01/12	←	Rim Size [in]: 17; ☐			24.3601-1754.5 241440	MAN without holder
2.0 TiD	118	05/10→01/12						
2.0 TTiD	140	05/10→01/12						
2.0 TTiD XWD	140	05/10→01/12						
2.0 Turbo	162	05/10→01/12						
2.0 Turbo XWD	162	05/10→01/12						
2.8 Turbo V6 XWD	221	05/10→01/12						
SEAT - ALHAMBRA (710, 711) 06/10→								
 Brake Hose								
1.4 TSI	110	06/10→	←			2	83.7847-0556.3 331339	L= 555
1.8 TSI	118	11/12→						
2.0 TDI	85 - 135	06/10→						
2.0 TDi 4Drive	130	11/18→						
2.0 TDI 4Drive	103 - 135	05/11→						
2.0 TFSI	147	11/10→05/12						
2.0 TSI	162	05/15→						
SEAT - ALHAMBRA VAN (711) 06/10→								
 Brake Hose								
TDI	110 - 135	05/15→	←			2	83.7847-0556.3 331339	L= 555
TDI 4Drive	110	05/15→						
TSi	110	05/15→						
SEAT - LEON (5F1) 09/12→05/21								
Accessory Kit, disc brake pad								
2.0 Cupra	195 - 221	10/13→08/20	←	+ Performance Pack			13.0460-0521.2 610521	
2.0 Cupra R	228	11/17→08/18						
SEAT - LEON Hatchback Van (5F1) 09/12→08/20								
Accessory Kit, disc brake pad								
2.0 Cupra	213 - 221	09/15→08/18	←	+ Performance Pack			13.0460-0521.2 610521	
SEAT - LEON SC (5F5) 01/13→12/18								
Accessory Kit, disc brake pad								
2.0 Cupra	195 - 221	10/13→08/18	←	+ Performance Pack			13.0460-0521.2 610521	





























































	kw			 	! #		
SEAT - LEON ST (5F8) 09/12→08/20							
Accessory Kit, disc brake pad							
2.0 Cupra	195 - 221	10/13→08/20	←	+ Performance Pack		13.0460-0521.2	610521
2.0 Cupra 4Drive	221	11/16→08/20					
SEAT - LEON ST Estate Van (5F8) 01/13→08/20							
Accessory Kit, disc brake pad							
2.0 Cupra	206 - 221	10/13→08/20	←	+ Performance Pack		13.0460-0521.2	610521
2.0 Cupra 4Drive	221	11/16→08/18					
SKODA - KAROQ (NU7, ND7) 07/17→							
 Brake Hose							
1.0 TSI	81 - 85	07/17→	→	+PR 0N1	2	83.8207-0290.3	331534 L= 291
1.4 TSI	110	07/17→					
1.5 TSI	110	07/17→					
1.5 TSI 4x4	110	07/17→					
1.6 SRE	81	07/17→					
1.6 TDI	85	07/17→					
2.0 TDI	85 - 110	07/17→					
2.0 TDI 4x4	85 - 140	07/17→					
2.0 TSI 4x4	140	04/19→					
SUZUKI - CELERIO (LF) 02/14→							
 Wheel Brake Cylinder							
1.0	50	03/14→	→			24.3219-1749.3	020500 ALU
			→			24.3219-1750.3	020501 ALU
SUZUKI - SWIFT V (AZ) 01/17→							
 Brake Disc							
1.0	82	04/17→	→			24.0109-0186.1	409186 Ø 228 Brake Disc Thickness [mm] 9 Minimum thickness [mm] 8
1.0 SHVS	82	04/17→					
1.2	66 - 67	01/17→					
1.2 AllGrip	66	04/17→					
1.2 Hybrid)	61	06/20→					
1.2 Hybrid) AllGrip	61	06/20→					
1.2 SHVS	66	04/17→					
1.2 SHVS AllGrip	66	04/17→					
TESLA - MODEL X (5YJX) 09/13→							
Accessory Kit, disc brake pad							
100D AWD	386	08/17→	→			13.0460-0524.2	610524
60D AWD	386	06/16→					
75D AWD	386	06/16→					
90D AWD	386	09/15→					
EV AWD	386 - 599	05/19→					
P100D AWD	568	10/16→					
P90D AWD	568	09/15→					
TESLA - MODEL S (5YJS) 09/12→							
Accessory Kit, disc brake pad							
100D AWD	310 - 386	06/17→	→			13.0460-0524.2	610524
60	225 - 350	11/13→					
60D AWD	245 - 386	10/14→					
70	235 - 350	09/15→					
70D AWD	245 - 386	04/15→					
75	235 - 350	11/16→					
75D AWD	245 - 386	06/16→					
85	270 - 285	09/12→02/16					
85D AWD	276 - 386	10/14→02/16					
90	285	11/15→					
90D AWD	310 - 386	09/15→					
→							

























	kw					! #		
TESLA - MODEL S (5YJS) 09/12→								
Accessory Kit, disc brake pad								
EV AWD	386 - 599	06/19→	➔				13.0460-0524.2	610524
P100D AWD	450 - 568	10/16→						
P85	310 - 350	05/13→12/14						
P85D AWD	515 - 568	10/14→02/16						
P90D AWD	346 - 568	09/15→						
TOYOTA - ALLION I (_T24_) 06/01→06/07								
 Wheel Brake Cylinder								
1.5	80	06/01→04/05	➔	<input type="checkbox"/>			24.3219-1749.3	020500 ALU
1.8	92	06/01→09/04	➔	<input type="checkbox"/>			24.3219-1750.3	020501 ALU
TOYOTA - AURIS (_E15_) 10/06→09/12								
 Brake Hose								
1.33 Dual-VVTi	73 - 74	05/09→09/12	➔	Vehicle Production Country Turkey; 154→; <input type="checkbox"/> / inner			24.5202-0160.3	331624 L= 160
1.4	71	03/07→09/12						
1.4 D-4D	66	03/07→09/12						
1.6	91 - 97	03/07→09/12						
1.8	100 - 108	10/06→09/12						
1.5	81	10/06→08/12	➔	09/09→; Vehicle Production Country Turkey; 154→; <input type="checkbox"/> / inner			24.5202-0160.3	331624 L= 160
1.5 4WD	77	10/06→09/12	➔	09/09→; Vehicle Production Country Great Britain / Turkey; 154→; <input type="checkbox"/> / inner			24.5202-0160.3	331624 L= 160
1.8 4WD	100	10/06→10/09	➔	02/09→; Vehicle Production Country Turkey; 154→; <input type="checkbox"/> / inner			24.5202-0160.3	331624 L= 160
2.0 D-4D	93	10/06→09/12	➔	03/07→; Vehicle Production Country Turkey; 154→; <input type="checkbox"/> / inner			24.5202-0160.3	331624 L= 160
TOYOTA - AURIS Hatchback Van (_E15_) 03/07→09/12								
 Brake Hose								
1.4 D-4D	66	03/07→09/12	➔	Vehicle Production Country Turkey; 154→; <input type="checkbox"/> / inner			24.5202-0160.3	331624 L= 160
TOYOTA - COROLLA Saloon (_E16_) 05/12→								
 Wheel Brake Cylinder								
1.5	80	05/12→	➔	<input type="checkbox"/>			24.3219-1749.3	020500 ALU
			➔	<input type="checkbox"/>			24.3219-1750.3	020501 ALU
TOYOTA - RAUM MPV (NCZ2_) 05/03→								
 Wheel Brake Cylinder								
1.5	80	05/03→10/11	➔	<input type="checkbox"/>			24.3219-1749.3	020500 ALU
1.5 4WD	77	05/03→10/11	➔	<input type="checkbox"/>			24.3219-1750.3	020501 ALU
TOYOTA - VERSO (_R2_) 04/09→08/18								
 Brake Hose								
1.6	81 - 97	04/09→08/18	➔	<input type="checkbox"/> / inner			24.5202-0160.3	331624 L= 160
1.8	108	04/09→08/18						
2.0 D-4D	93	04/09→08/18						
2.2 D-4D	100 - 110	04/09→08/18						
2.2 D-CAT	130	04/09→08/18						
TOYOTA - VERSO VAN (_R2_) 04/09→08/18								
 Brake Hose								
D4d VVTi	130 - 108	04/09→08/18	➔	<input type="checkbox"/> / inner			24.5202-0160.3	331624 L= 160





























	kw					! #		
TOYOTA - YARIS (_P21_, _PA1_, _PH1_) 02/20→								
 Wheel Brake Cylinder								
1.5 Hybrid	85	02/20→	→	☐		24.3219-1749.3	020500	ALU
			→	☐		24.3219-1750.3	020501	ALU
TOYOTA - YARIS VERSO (_P2_) 08/99→09/05								
 Wheel Brake Cylinder								
1.3	62	11/02→09/05	→	- ABS; Manual Transmission; ☐		24.3219-1749.3	020500	ALU
			→	- ABS; Manual Transmission; ☐		24.3219-1750.3	020501	ALU
1.3	63	08/99→10/02	→	11/99→; - ABS; Manual Transmission; ☐		24.3219-1749.3	020500	ALU
			→	11/99→; - ABS; Manual Transmission; ☐		24.3219-1750.3	020501	ALU
1.4 D-4D	55	09/00→09/05	→	- ABS; ☐		24.3219-1749.3	020500	ALU
			→	12/01→; - ABS; ☐		24.3219-1750.3	020501	ALU
1.5	77	03/00→09/05	→	- ABS; ☐		24.3219-1749.3	020500	ALU
			→	05/03→; - ABS; ☐		24.3219-1750.3	020501	ALU
1.5	78	03/00→09/05	→	→ 03/03; - ABS; ☐		24.3219-1749.3	020500	ALU
			→	→ 03/03; - ABS; ☐		24.3219-1750.3	020501	ALU
1.5 4WD	78	03/00→09/05	→	- ABS; ☐		24.3219-1749.3	020500	ALU
			→	- ABS; ☐		24.3219-1750.3	020501	ALU
TOYOTA - YARIS VERSO VAN (_P2_) 03/00→09/05								
 Wheel Brake Cylinder								
1.3 VVTi	62 - 63	03/00→09/05	→	- ABS; Manual Transmission; ☐		24.3219-1749.3	020500	ALU
			→	- ABS; Manual Transmission; ☐		24.3219-1750.3	020501	ALU
1.4 D4d	55	10/01→09/05	→	- ABS; ☐		24.3219-1749.3	020500	ALU
			→	12/01→; - ABS; ☐		24.3219-1750.3	020501	ALU
1.5 VVTi	78	03/00→03/03	→	- ABS; ☐		24.3219-1749.3	020500	ALU
			→	- ABS; ☐		24.3219-1750.3	020501	ALU
VAUXHALL - AMPERA (R12) 03/12→								
 Brake Pad Set, disc brake								
EV 150	111	03/12→	←	JB000001 / J4000001→		13.0470-5527.2	LD5527	MAN + WK + Zub Ceramic
VAUXHALL - ASTRA Mk VI (J) (P10) 12/09→10/15								
 Brake Caliper								
1.3 CDTi	70	12/09→10/15	←	for brake disc diameter [mm]: 321; ☐		24.3601-1753.5	241439	MAN without holder
1.4	64 - 74	12/09→10/15	←	for brake disc diameter [mm]: 321; ☐		24.3601-1754.5	241440	MAN without holder
1.4 Turbo	103	12/09→10/15						
1.6	85	12/09→10/15						
1.6 Turbo	132	12/09→10/15						
1.7 CDTi	81 - 96	12/09→10/15						
1.7 CDTi	74	10/10→10/15						
2.0 BiTurbo CDTi	143	12/12→10/15						
2.0 CDTi	118 - 121	12/09→10/15						
1.4 Turbo	88	08/10→10/15	←	11/10→; for brake disc diameter [mm]: 321; ☐		24.3601-1753.5	241439	MAN without holder
			←	11/10→; for brake disc diameter [mm]: 321; ☐		24.3601-1754.5	241440	MAN without holder
1.6 CDTi	81	11/13→10/15	←	02/14→; for brake disc diameter [mm]: 321; ☐		24.3601-1753.5	241439	MAN without holder
			←	02/14→; for brake disc diameter [mm]: 321; ☐		24.3601-1754.5	241440	MAN without holder
1.6 CDTi	100	11/13→10/15	←	01/14→; for brake disc diameter [mm]: 321; ☐		24.3601-1753.5	241439	MAN without holder
			←	01/14→; for brake disc diameter [mm]: 321; ☐		24.3601-1754.5	241440	MAN without holder
 Brake Pad Set, disc brake								
1.3 CDTi	70	12/09→10/15	←	for brake disc diameter [mm]: 300; JB000001 / J4000001→		13.0470-5527.2	LD5527	MAN + WK + Zub Ceramic
1.4	64 - 74	12/09→10/15						
1.4 Turbo	88 - 103	12/09→10/15						
→								













	kw				! #		
VAUXHALL - ASTRA Mk VI (J) (P10) 12/09→10/15							
 Brake Pad Set, disc brake							
1.6 1.6 Turbo 1.7 CDTi 1.7 CDTi 2.0 BiTurbo CDTi 2.0 CDTi	85 132 81 - 96 74 143 118 - 121	12/09→10/15 12/09→10/15 12/09→10/15 10/10→10/15 12/12→10/15 12/09→10/15	←	for brake disc diameter [mm]: 300; JB000001 / J4000001→		13.0470-5527.2 LD5527	MAN + WK + Zub Ceramic
1.6 CDTi	81	11/13→10/15	←	02/14→; for brake disc diameter [mm]: 300; JB000001 / J4000001→		13.0470-5527.2 LD5527	MAN + WK + Zub Ceramic
1.6 CDTi	100	11/13→10/15	←	01/14→; for brake disc diameter [mm]: 300; JB000001 / J4000001→		13.0470-5527.2 LD5527	MAN + WK + Zub Ceramic
VAUXHALL - ASTRA Mk VI (J) Estate (P10) 10/10→10/15							
 Brake Caliper							
1.3 CDTi 1.4 1.4 Turbo 1.6 1.6 Turbo 1.7 CDTi 2.0 CDTi	70 64 - 74 103 85 132 81 - 92 118	10/10→10/15 10/10→10/15 10/10→10/15 10/10→10/15 10/10→10/15 10/10→10/15 10/10→06/11	←	11/10→; for brake disc diameter [mm]: 321; 		24.3601-1753.5 241439	MAN without holder
1.6 CDTi	81	01/14→10/15	←	02/14→; for brake disc diameter [mm]: 321; 		24.3601-1753.5 241439	MAN without holder
1.6 CDTi	81	01/14→10/15	←	02/14→; for brake disc diameter [mm]: 321; 		24.3601-1754.5 241440	MAN without holder
1.6 CDTi 1.7 CDTi 2.0 BiTurbo CDTi 2.0 CDTi	100 96 143 121	01/14→10/15 06/11→10/15 12/12→10/15 08/11→10/15	←	for brake disc diameter [mm]: 321; 		24.3601-1753.5 241439	MAN without holder
1.6 CDTi	100	01/14→10/15	←	for brake disc diameter [mm]: 321; 		24.3601-1754.5 241440	MAN without holder
 Brake Pad Set, disc brake							
1.3 CDTi 1.4 1.4 Turbo 1.6 1.6 Turbo 1.7 CDTi 2.0 CDTi	70 64 - 74 103 85 132 81 - 92 118	10/10→10/15 10/10→10/15 10/10→10/15 10/10→10/15 10/10→10/15 10/10→10/15 10/10→06/11	←	11/10→; for brake disc diameter [mm]: 300; JB000001 / J4000001→		13.0470-5527.2 LD5527	MAN + WK + Zub Ceramic
1.6 CDTi	81	01/14→10/15	←	02/14→; for brake disc diameter [mm]: 300; JB000001 / J4000001→		13.0470-5527.2 LD5527	MAN + WK + Zub Ceramic
1.6 CDTi 1.7 CDTi 2.0 BiTurbo CDTi 2.0 CDTi	100 96 143 121	01/14→10/15 06/11→10/15 12/12→10/15 08/11→10/15	←	for brake disc diameter [mm]: 300; JB000001 / J4000001→		13.0470-5527.2 LD5527	MAN + WK + Zub Ceramic
VAUXHALL - ASTRA Mk VI (J) GTC (P10) 10/11→10/15							
 Brake Caliper							
1.4 1.6 1.6 CDTi 1.6 SIDI 1.7 CDTi 2.0 BiTurbo CDTi 2.0 CDTi	74 - 103 132 81 - 100 147 81 - 96 143 121	10/11→10/15 10/11→10/15 07/14→10/15 09/13→10/15 10/11→10/15 12/12→10/15 10/11→10/15	←	for brake disc diameter [mm]: 321; 		24.3601-1753.5 241439	MAN without holder
1.6 CDTi	100	07/14→10/15	←	for brake disc diameter [mm]: 321; 		24.3601-1754.5 241440	MAN without holder
 Brake Pad Set, disc brake							
1.4 1.6 1.6 CDTi 1.6 SIDI 1.7 CDTi 2.0 BiTurbo CDTi 2.0 CDTi	74 - 103 132 81 - 100 147 81 - 96 143 121	10/11→10/15 10/11→10/15 07/14→10/15 09/13→10/15 10/11→10/15 12/12→10/15 10/11→10/15	←	for brake disc diameter [mm]: 300; JB000001 / J4000001→		13.0470-5527.2 LD5527	MAN + WK + Zub Ceramic













	kw				! #			
VAUXHALL - ASTRA Mk VI (J) Saloon (P10) 06/12→10/15								
 Brake Caliper								
1.3 CDTI 1.4 1.4 Turbo 1.6 1.6 Turbo 1.7 CDTI	70 74 103 85 132 81 - 96	06/12→10/15 06/12→10/15 06/12→10/15 06/12→10/15 06/12→10/15 06/12→10/15	←	for brake disc diameter [mm]: 321; 		24.3601-1753.5 24.3601-1754.5	241439 241440	MAN without holder MAN without holder
 Brake Pad Set, disc brake								
1.3 CDTI 1.4 1.4 Turbo 1.6 1.6 Turbo 1.7 CDTI	70 74 103 85 132 81 - 96	06/12→10/15 06/12→10/15 06/12→10/15 06/12→10/15 06/12→10/15 06/12→10/15	←	for brake disc diameter [mm]: 300; JB000001 / J400001→		13.0470-5527.2	LD5527	MAN + WK + Zub Ceramic
VAUXHALL - CASCADA Convertible (W13) 02/13→								
 Brake Caliper								
1.4 1.6 2.0 CDTI	103 125 - 147 121 - 143	02/13→ 02/13→ 02/13→	←			24.3601-1753.5 24.3601-1754.5	241439 241440	MAN without holder MAN without holder
VAUXHALL - INSIGNIA Mk I (A) Country Tourer (G09) 07/08→05/17								
 Brake Caliper								
1.6 CDTI 1.6 Turbo 2.0 Biturbo CDTI 4x4 2.0 CDTI 2.0 CDTI 4x4	100 125 143 125 125	07/15→05/17 07/13→05/17 09/13→05/17 11/14→05/17 11/14→05/17	←	for brake disc diameter [mm]: 337; 		24.3421-1724.5 24.3601-1753.5 24.3601-1754.5	241450 241439 241440	without holder MAN without holder MAN without holder
2.0 CDTI	120	07/13→05/17	←	09/13→; for brake disc diameter [mm]: 337; 		24.3421-1724.5	241450	without holder
			←	for brake disc diameter [mm]: 337; 		24.3421-1724.5	241450	without holder
			←	09/13→; for brake disc diameter [mm]: 321; 		24.3601-1753.5	241439	MAN without holder
			←	for brake disc diameter [mm]: 321; 		24.3601-1753.5	241439	MAN without holder
			←	09/13→; for brake disc diameter [mm]: 321; 		24.3601-1754.5	241440	MAN without holder
			←	for brake disc diameter [mm]: 321; 		24.3601-1754.5	241440	MAN without holder
VAUXHALL - INSIGNIA Mk I (A) Hatchback (G09) 07/08→05/17								
 Brake Caliper								
1.4	103	04/11→05/17	←	06/11→; for brake disc diameter [mm]: 337; 		24.3421-1724.5	241450	without holder
			←	06/11→; for brake disc diameter [mm]: 321; 		24.3601-1753.5	241439	MAN without holder
			←	06/11→; for brake disc diameter [mm]: 321; 		24.3601-1754.5	241440	MAN without holder
1.4 LPG 1.6 1.6 CDTI 1.6 Turbo	103 85 100 125 - 132	07/12→05/17 07/08→07/12 07/15→05/17 01/09→05/17	←	for brake disc diameter [mm]: 337; 		24.3421-1724.5	241450	without holder
			←	for brake disc diameter [mm]: 321; 		24.3601-1753.5	241439	MAN without holder
			←	for brake disc diameter [mm]: 321; 		24.3601-1754.5	241440	MAN without holder
1.8 2.0 Biturbo CDTI 2.0 Biturbo CDTI 4x4 2.0 CDTI	103 143 143 81 - 140	07/08→05/17 03/12→05/17 03/12→05/17 07/08→05/17						
2.0 CDTI 4x4	125 - 140	05/09→05/17						
2.0 Turbo 2.0 Turbo 4x4	162 162	07/08→05/17 07/08→05/17						
2.0 CDTI	88	03/12→03/16	←	03/13→; for brake disc diameter [mm]: 337; 		24.3421-1724.5	241450	without holder
			←	03/13→; for brake disc diameter [mm]: 321; 		24.3601-1753.5	241439	MAN without holder
			←	03/13→; for brake disc diameter [mm]: 321; 		24.3601-1754.5	241440	MAN without holder
2.0 CDTI 4x4	118	07/08→05/17	←	06/10→; for brake disc diameter [mm]: 337; 		24.3421-1724.5	241450	without holder
			←	06/10→; for brake disc diameter [mm]: 321; 		24.3601-1753.5	241439	MAN without holder
→								









	kw					! #		
VAUXHALL - INSIGNIA Mk I (A) Hatchback (G09) 07/08→05/17								
 Brake Caliper								
2.0 CDTI 4x4	118	07/08→05/17	←	06/10→; for brake disc diameter [mm]: 321; 		24.3601-1754.5	241440	MAN without holder
2.0 Turbo	184	07/11→05/17	←	04/14→; for brake disc diameter [mm]: 337; 		24.3421-1724.5	241450	without holder
			←	04/14→; for brake disc diameter [mm]: 321; 		24.3601-1753.5	241439	MAN without holder
			←	04/14→; for brake disc diameter [mm]: 321; 		24.3601-1754.5	241440	MAN without holder
2.8 V6 Turbo 4x4	191	07/08→05/17	←	for brake disc diameter [mm]: 337; 		24.3421-1724.5	241450	without holder
VAUXHALL - INSIGNIA Mk I (A) Saloon (G09) 07/08→05/17								
 Brake Caliper								
1.4	103	04/11→05/17	←	06/11→; for brake disc diameter [mm]: 337; 		24.3421-1724.5	241450	without holder
			←	06/11→; for brake disc diameter [mm]: 321; 		24.3601-1753.5	241439	MAN without holder
			←	06/11→; for brake disc diameter [mm]: 321; 		24.3601-1754.5	241440	MAN without holder
1.4 LPG	103	07/12→05/17	←	for brake disc diameter [mm]: 337; 		24.3421-1724.5	241450	without holder
1.6	85	07/08→07/12	←	for brake disc diameter [mm]: 321; 		24.3601-1753.5	241439	MAN without holder
1.6 CDTi	100	07/15→05/17	←	for brake disc diameter [mm]: 321; 		24.3601-1753.5	241439	MAN without holder
1.6 Turbo	132	01/09→05/17	←	for brake disc diameter [mm]: 321; 		24.3601-1754.5	241440	MAN without holder
1.8	103	07/08→05/17	←	for brake disc diameter [mm]: 321; 		24.3601-1754.5	241440	MAN without holder
2.0 Biturbo CDTI	143	03/12→05/17	←	for brake disc diameter [mm]: 321; 		24.3601-1754.5	241440	MAN without holder
2.0 Biturbo CDTI 4x4	143	03/12→05/17	←	for brake disc diameter [mm]: 321; 		24.3601-1754.5	241440	MAN without holder
2.0 CDTI	96 -	07/08→05/17	←	for brake disc diameter [mm]: 321; 		24.3601-1754.5	241440	MAN without holder
	140		←	for brake disc diameter [mm]: 321; 		24.3601-1754.5	241440	MAN without holder
2.0 CDTI 4x4	125 -	05/09→05/17	←	for brake disc diameter [mm]: 321; 		24.3601-1754.5	241440	MAN without holder
	140		←	for brake disc diameter [mm]: 321; 		24.3601-1754.5	241440	MAN without holder
2.0 Turbo	162	07/08→05/17	←	for brake disc diameter [mm]: 321; 		24.3601-1754.5	241440	MAN without holder
2.0 Turbo 4x4	162 -	07/08→05/17	←	for brake disc diameter [mm]: 321; 		24.3601-1754.5	241440	MAN without holder
	184		←	for brake disc diameter [mm]: 321; 		24.3601-1754.5	241440	MAN without holder
2.0 CDTI 4x4	118	07/08→05/17	←	06/10→; for brake disc diameter [mm]: 337; 		24.3421-1724.5	241450	without holder
			←	06/10→; for brake disc diameter [mm]: 321; 		24.3601-1753.5	241439	MAN without holder
			←	06/10→; for brake disc diameter [mm]: 321; 		24.3601-1754.5	241440	MAN without holder
			←	06/10→; for brake disc diameter [mm]: 321; 		24.3601-1754.5	241440	MAN without holder
2.0 Turbo	184	09/11→05/17	←	04/14→; for brake disc diameter [mm]: 337; 		24.3421-1724.5	241450	without holder
			←	04/14→; for brake disc diameter [mm]: 321; 		24.3601-1753.5	241439	MAN without holder
			←	04/14→; for brake disc diameter [mm]: 321; 		24.3601-1754.5	241440	MAN without holder
			←	04/14→; for brake disc diameter [mm]: 321; 		24.3601-1754.5	241440	MAN without holder
2.8 V6 Turbo 4x4	191	07/08→05/17	←	for brake disc diameter [mm]: 337; 		24.3421-1724.5	241450	without holder
VAUXHALL - INSIGNIA Mk I (A) Sports Tourer (G09) 07/08→05/17								
 Brake Caliper								
1.4	103	04/11→05/17	←	06/11→; for brake disc diameter [mm]: 337; 		24.3421-1724.5	241450	without holder
			←	06/11→; for brake disc diameter [mm]: 321; 		24.3601-1753.5	241439	MAN without holder
			←	06/11→; for brake disc diameter [mm]: 321; 		24.3601-1754.5	241440	MAN without holder
1.4 LPG	103	07/12→05/17	←	for brake disc diameter [mm]: 337; 		24.3421-1724.5	241450	without holder
1.6	85	07/08→07/12	←	for brake disc diameter [mm]: 321; 		24.3601-1753.5	241439	MAN without holder
1.6 CDTI	100	07/15→05/17	←	for brake disc diameter [mm]: 321; 		24.3601-1753.5	241439	MAN without holder
1.6 Turbo	125 -	01/09→05/17	←	for brake disc diameter [mm]: 321; 		24.3601-1754.5	241440	MAN without holder
	132		←	for brake disc diameter [mm]: 321; 		24.3601-1754.5	241440	MAN without holder
1.8	103	07/08→05/17	←	for brake disc diameter [mm]: 321; 		24.3601-1754.5	241440	MAN without holder
2.0 Biturbo CDTI	143	03/12→05/17	←	for brake disc diameter [mm]: 321; 		24.3601-1754.5	241440	MAN without holder
2.0 Biturbo CDTI 4x4	143	03/12→05/17	←	for brake disc diameter [mm]: 321; 		24.3601-1754.5	241440	MAN without holder
2.0 CDTI	81 -	07/08→05/17	←	for brake disc diameter [mm]: 321; 		24.3601-1754.5	241440	MAN without holder
	140		←	for brake disc diameter [mm]: 321; 		24.3601-1754.5	241440	MAN without holder
2.0 CDTI 4x4	125 -	05/09→05/17	←	for brake disc diameter [mm]: 321; 		24.3601-1754.5	241440	MAN without holder
	140		←	for brake disc diameter [mm]: 321; 		24.3601-1754.5	241440	MAN without holder
2.0 Turbo	162	07/08→05/17	←	for brake disc diameter [mm]: 321; 		24.3601-1754.5	241440	MAN without holder
2.0 Turbo 4x4	162	07/08→05/17	←	for brake disc diameter [mm]: 321; 		24.3601-1754.5	241440	MAN without holder
2.0 CDTI	88	03/12→03/16	←	03/13→; for brake disc diameter [mm]: 337; 		24.3421-1724.5	241450	without holder
			←	03/13→; for brake disc diameter [mm]: 321; 		24.3601-1753.5	241439	MAN without holder
			←	03/13→; for brake disc diameter [mm]: 321; 		24.3601-1754.5	241440	MAN without holder
→								

	kw					! #		
VAUXHALL - INSIGNIA Mk I (A) Sports Tourer (G09) 07/08→05/17								
 Brake Caliper								
2.0 CDTi 4x4	118	07/08→05/17	←	06/10→; for brake disc diameter [mm]: 337; 		24.3421-1724.5	241450	without holder
			←	06/10→; for brake disc diameter [mm]: 321; 		24.3601-1753.5	241439	MAN without holder
			←	06/10→; for brake disc diameter [mm]: 321; 		24.3601-1754.5	241440	MAN without holder
2.0 Turbo	184	07/11→05/17	←	04/14→; for brake disc diameter [mm]: 337; 		24.3421-1724.5	241450	without holder
			←	04/14→; for brake disc diameter [mm]: 321; 		24.3601-1753.5	241439	MAN without holder
			←	04/14→; for brake disc diameter [mm]: 321; 		24.3601-1754.5	241440	MAN without holder
2.8 V6 Turbo	191	08/08→05/17	←	for brake disc diameter [mm]: 337; 		24.3421-1724.5	241450	without holder
VAUXHALL - INSIGNIA Mk II (B) Country Tourer (Z18) 03/17→								
 Brake Pad Set, disc brake								
2.0 D	125	03/17→	←	+POC JQ5; Brake Size: 18"		13.0460-4898.2	604898	BRE + WK
2.0 D 4x4	125	09/17→				13.0470-4898.2	LD4898	BRE + WK Ceramic
2.0 GSi 4x4	154	07/17→						
VAUXHALL - INSIGNIA Mk II (B) Hatchback (Z18) 03/17→								
 Brake Pad Set, disc brake								
1.5	103 - 121	03/17→	←	+POC JQ5; Brake Size: 18"		13.0460-4898.2	604898	BRE + WK
1.5 CDTi	90	02/20→				13.0470-4898.2	LD4898	BRE + WK Ceramic
1.6 D	81 - 100	03/17→						
1.6 Turbo	147	06/18→						
2.0 4x4	191	03/17→						
2.0 D	125 - 128	03/17→						
2.0 D 4x4	128	02/20→						
2.0 GSi 4X4	169	04/20→						
2.0 GSi 4x4	154	07/17→						
2.0 T	147	04/20→						
VAUXHALL - INSIGNIA Mk II (B) Sports Tourer (Z18) 03/17→								
 Brake Pad Set, disc brake								
1.5	103 - 121	03/17→	←	+POC JQ5; Brake Size: 18"		13.0460-4898.2	604898	BRE + WK
1.6 D	81 - 100	03/17→				13.0470-4898.2	LD4898	BRE + WK Ceramic
1.6 Turbo	147	06/18→						
2.0 4x4	191	03/17→						
2.0 D	125	03/17→						
2.0 GSi 4x4	154	07/17→						
VAUXHALL - MOKKA / MOKKA X (J13) 06/12→								
 Brake Pad Set, disc brake								
1.4	103	04/13→	←	JB000001 / J4000001→		13.0470-5527.2	LD5527	MAN + WK + Zub Ceramic
1.4 4x4	103 - 112	06/12→						
1.6	85	06/12→						
1.6 CDTi	100	01/15→						
1.6 CDTi	81	06/15→						
1.6 CDTi 4x4	100	01/15→						
1.7 CDTi	96	06/12→						
1.7 CDTi 4x4	96	06/12→						
VAUXHALL - ZAFIRA Mk III (P12) 10/11→08/18								
 Brake Caliper								
1.4	88 - 103	10/11→08/18	←	11/11→; for brake disc diameter [mm]: 321; 		24.3601-1753.5	241439	MAN without holder
1.6 CNG	110	10/11→08/18	←	11/11→; for brake disc diameter [mm]: 321; 		24.3601-1754.5	241440	MAN without holder
1.8	85 - 103	10/11→08/18						
2.0 CDTi	81 - 121	10/11→08/18						
1.6 CDTi	99 - 100	03/13→08/18	←	for brake disc diameter [mm]: 321; 		24.3601-1753.5	241439	MAN without holder
1.6 SIDI	147	07/13→08/18	←	for brake disc diameter [mm]: 321; 		24.3601-1754.5	241440	MAN without holder
2.0 CDTi	125	01/15→08/18						
2.0 BiTurbo CDTi	143	11/12→08/18	←	12/12→; for brake disc diameter [mm]: 321; 		24.3601-1753.5	241439	MAN without holder
→								

	kW					! #		
VAUXHALL - ZAFIRA Mk III (P12) 10/11→08/18								
 Brake Caliper								
2.0 BiTurbo CDTi	143	11/12→08/18	←	12/12→;	for brake disc diameter [mm]: 321; 		24.3601-1754.5 241440	MAN without holder
 Brake Pad Set, disc brake								
1.4	88 - 103	10/11→08/18	←	11/11→;	for brake disc diameter [mm]: 300; JB000001 / J4000001→		13.0470-5527.2 LD5527	MAN + WK + Zub Ceramic
1.6 CNG	110	10/11→08/18						
1.8	85 - 103	10/11→08/18						
2.0 CDTi	81 - 121	10/11→08/18						
1.6 CDTi	99 - 100	03/13→08/18	←	for brake disc diameter [mm]: 300;	JB000001 / J4000001→		13.0470-5527.2 LD5527	MAN + WK + Zub Ceramic
1.6 SIDI	147	07/13→08/18						
2.0 BiTurbo CDTi	143	11/12→08/18						
2.0 CDTi	125	01/15→08/18						
VOLVO - S60 I (384) 07/00→04/10								
Accessory Kit, disc brake pad								
5 T AWD R 2	221	01/03→04/10	→	03/03→	01/09		13.0460-0524.2 610524	
VOLVO - V70 II (285) 11/99→12/08								
Accessory Kit, disc brake pad								
5 T AWD R 2	221	03/03→08/07	→	→	07/07		13.0460-0524.2 610524	
VW - CALIFORNIA T6 Camper (SGC, SGG, SHC) 04/15→								
 Brake Pad Set, disc brake								
2.0 TDI	62 - 150	04/15→	←	+PR 1LB			13.0460-3879.2 603879	+ WE / - WK
2.0 TDI 4motion	103 - 150	06/15→						
2.0 TSI	110 - 150	04/15→07/19						
2.0 TSI 4motion	150	06/15→07/19						
VW - CRAFTER 30-35 Bus (2E_) 04/06→12/16								
 Brake Caliper								
2.0 TDI	80 - 100	05/11→12/16	←	07/11→; +PR 0WF; 			24.3521-8503.5 241461	ATE without holder
			←	07/11→; +PR 0WF; 			24.3521-8504.5 241462	ATE without holder
2.0 TDI	84 - 120	07/11→12/16	←	+PR 0WF; 			24.3521-8503.5 241461	ATE without holder
2.0 TDI 4motion	120	11/11→12/16	←	+PR 0WF; 			24.3521-8504.5 241462	ATE without holder
2.5 TDI	65 - 120	04/06→05/13						
VW - CRAFTER 30-50 Platform/Chassis (2F_) 04/06→12/16								
 Brake Caliper								
2.0 TDI	80 - 100	05/11→12/16	←	07/11→; +PR 0WF; 			24.3521-8503.5 241461	ATE without holder
			←	07/11→; +PR 0WF; 			24.3521-8504.5 241462	ATE without holder
2.0 TDI	84 - 120	07/11→12/16	←	+PR 0WF; 			24.3521-8503.5 241461	ATE without holder
2.0 TDI 4motion	120	11/11→12/16	←	+PR 0WF; 			24.3521-8504.5 241462	ATE without holder
2.5 TDI	65 - 120	04/06→05/13						
VW - CRAFTER 30-50 Van (2E_) 04/06→12/16								
 Brake Caliper								
2.0 TDI	80 - 100	05/11→12/16	←	07/11→; +PR 0WF; 			24.3521-8503.5 241461	ATE without holder
			←	07/11→; +PR 0WF; 			24.3521-8504.5 241462	ATE without holder
2.0 TDI	84 - 120	07/11→12/16	←	+PR 0WF; 			24.3521-8503.5 241461	ATE without holder
2.5 TDI	65 - 120	04/06→05/13	←	+PR 0WF; 			24.3521-8504.5 241462	ATE without holder
2.0 TDI 4motion	120	07/11→12/16	←	11/11→; +PR 0WF; 			24.3521-8503.5 241461	ATE without holder
			←	11/11→; +PR 0WF; 			24.3521-8504.5 241462	ATE without holder

	kw			 	! #		
VW - CRAFTER Bus (SYI, SYJ) 09/16→							
 Brake Pad Set, disc brake							
2.0 TDI	75 - 130	09/16→	←	+PR 1LB		13.0460-3879.2 603879	+ WE / - WK
2.0 TDI 4motion	103 - 130	03/17→					
VW - CRAFTER Platform/Chassis (SZ_) 11/16→							
 Brake Pad Set, disc brake							
2.0 TDI	75 - 130	11/16→	←	+PR 1LB		13.0460-3879.2 603879	+ WE / - WK
2.0 TDI 4motion	103 - 130	03/17→					
2.0 TDI RWD	80 - 130	11/16→					
VW - CRAFTER Van (SY_, SX_) 09/16→							
 Brake Pad Set, disc brake							
2.0 TDI	75 - 130	09/16→	←	+PR 1LB		13.0460-3879.2 603879	+ WE / - WK
2.0 TDI 4motion	103 - 130	03/17→					
2.0 TDI RWD	80 - 130	05/17→					
VW - GOLF VII (5G1, BQ1, BE1, BE2) 08/12→							
 Brake Hose							
1.0 TSI	63 - 85	05/15→	→	+PR 0N1	2	83.8207-0290.3 331534	L= 291
1.2 TSI	77 - 81	11/12→					
1.4 GTE Hybrid	110	05/14→					
1.4 TSI	92 - 110	05/14→					
1.4 TSI MultiFuel	90 - 92	04/13→					
1.5 TGI	96	11/18→					
1.5 TSI	96 - 110	04/17→					
1.6	81	05/14→07/17					
1.6 TDI	66 - 85	04/13→08/20					
2.0 GTD	135	04/13→					
2.0 GTI	155 - 180	04/13→					
2.0 GTI Clubsport	195	02/16→03/17					
2.0 GTI Clubsport S	228	09/16→					
2.0 GTI TCR	213	11/18→					
2.0 TDI	81 - 110	08/12→					
1.2 TSI	63	08/12→03/17	→	11/12→; +PR 0N1	2	83.8207-0290.3 331534	L= 291
1.4 TSI	103	08/12→03/17					
1.6 TDI	77	08/12→03/17					
1.4 TGI CNG	81	06/13→	→	08/13→; +PR 0N1	2	83.8207-0290.3 331534	L= 291
1.4 TSI	90	11/12→	→	06/13→; +PR 0N1	2	83.8207-0290.3 331534	L= 291
1.6 TDI	81	01/13→					
VW - GOLF VII Van (5G1) 08/12→							
 Brake Hose							
1.2 TSi BlueMotion	63	08/12→	→	11/12→; +PR 0N1	2	83.8207-0290.3 331534	L= 291
1.4 TSi BlueMotion	103	08/12→					
1.6 TDi BlueMotion	77	08/12→					
1.2 TSi BlueMotion	77	11/12→	→	+PR 0N1	2	83.8207-0290.3 331534	L= 291
1.4 TSi BlueMotion	90	05/13→					
1.6 TDi BlueMotion	66 - 81	04/13→					
2.0 GTD	135	04/13→					
2.0 GTI	162 - 169	04/13→					
2.0 TDi BlueMotion	110	05/13→					
VW - GOLF VII Variant (BA5, BV5) 04/13→							
 Brake Hose							
1.0 TSI	63 - 85	05/15→	→	+PR 0N1	2	83.8207-0290.3 331534	L= 291
1.2 TSI	81	04/14→					
1.4 TGI CNG	81	09/13→					

	kw			 	! #		
VW - GOLF VII Variant (BA5, BV5) 04/13→							
 Brake Hose							
1.4 TSI	92 - 110	05/14→	➔	+PR 0N1	2	83.8207-0290.3 331534	L= 291
1.4 TSI MultiFuel	90 - 92	04/13→03/17					
1.5 TGI	96	12/18→					
1.5 TSI	96 - 110	04/17→					
1.6	81	05/14→03/17					
1.6 TDI	85	11/16→					
1.8 TSI 4motion	132	11/16→					
2.0 GTD	135	01/15→03/17					
1.2 TSI	63 - 77	05/13→	➔	07/13→; +PR 0N1	2	83.8207-0290.3 331534	L= 291
1.4 TSI	90 - 103	05/13→					
1.6 TDI	66 - 81	05/13→03/17					
2.0 TDI	81 - 110	04/13→					
VW - GOLF ALLTRACK VII Variant (BA5, BV5) 12/14→							
 Brake Hose							
1.6 TDI 4motion	81	12/14→	➔	+PR 0N1	2	83.8207-0290.3 331534	L= 291
1.8 TSI 4motion	132	12/14→					
2.0 TDI 4motion	110 - 135	12/14→					
VW - GOLF SPORTSVAN VII (AM1, AN1) 02/14→							
 Brake Hose							
1.0 TSI	63 - 85	05/15→	➔	+PR 0N1	2	83.8207-0290.3 331534	L= 291
1.2 TSI	63 - 81	04/14→					
1.4 TSI	92	04/14→					
1.4 TSI MultiFuel	92	04/14→					
1.5 TSI	96 - 110	05/17→					
1.6	81	05/14→					
1.6 TDI	66 - 85	02/14→					
2.0 TDI	81	05/14→11/17					
1.4 TSI	110	02/14→	➔	05/14→; +PR 0N1	2	83.8207-0290.3 331534	L= 291
1.6 TDI	81	02/14→					
2.0 TDI	110	02/14→					
VW - GOLF VAN VII Variant (BA5) 04/13→03/17							
 Brake Hose							
1.2 TSi BlueMotion	63 - 77	04/13→03/17	➔	+PR 0N1	2	83.8207-0290.3 331534	L= 291
1.4 TSi BlueMotion	90 - 103	05/13→03/17					
1.6 TDi BlueMotion	66 - 77	05/13→03/17					
1.6 TDi BlueMotion 4motion	77	05/13→03/17					
2.0 TDi BlueMotion	110	04/13→03/17					
2.0 TDi BlueMotion 4motion	110	04/13→03/17					
VW - GRAND CALIFORNIA Camper (SCB, SCC) 04/19→							
 Brake Pad Set, disc brake							
2.0 TDI	103 - 130	04/19→	➔	+PR 1LB		13.0460-3879.2 603879	+ WE / - WK
2.0 TDI 4motion	103 - 130	04/19→					
VW - SHARAN (7N1, 7N2) 05/10→							
 Brake Hose							
1.4 TSI	110	05/10→	➔	07/10→	2	83.7847-0556.3 331339	L= 555
2.0 TDI	100 - 103	05/10→					
1.4 TSI	110	05/15→	➔		2	83.7847-0556.3 331339	L= 555
2.0 TDI	85 - 135	08/10→					
2.0 TDI 4motion	103 - 135	05/11→					
2.0 TFSI	147	12/10→11/15					
2.0 TSI	162	05/15→					

	kW			 	! #		
VW - SHARAN VAN (7N1, 7N2) 05/10→							
 Brake Hose							
1.4 TSI 2.0 TDI	110 100 - 103	05/10→11/15 05/10→11/15	←	07/10→	2	83.7847-0556.3 331339	L= 555
2.0 TDI 2.0 TSI	85 - 125 147	08/10→11/15 12/10→11/15	←		2	83.7847-0556.3 331339	L= 555
VW - T-ROC (A11, D11) 07/17→							
 Brake Hose							
1.0 TSI 1.5 TSI 1.5 TSI 4motion 1.6 TDI 2.0 R 4motion 2.0 TDI 2.0 TDI 4motion 2.0 TDI SCR 2.0 TSI 4motion	81 - 85 110 110 85 221 110 110 - 140 85 140	07/17→ 11/17→ 05/18→11/19 03/18→06/21 09/19→ 03/18→ 09/17→ 11/20→ 07/17→	→	+PR 0N1	2	83.8207-0290.3 331534	L= 291















- EN** Technical translations
- DE** Technische Übersetzungen
- ES** Traducciones técnicas
- FR** Traductions techniques
- IT** Traduzioni tecniche

06/2022



Technical translations

Technische Übersetzungen - Traducciones tecnicas - Traductions techniques - Traduzioni tecniche

EN		EN	
	Brake Master Cylinder	ATE Ceramic	additional article information, ATE Ceramic
	Brake Hose	B	Coated
	Cable Pull, parking brake	B1=	Width 1 [mm]
	Brake Caliper	B2=	Width 2 [mm]
	Brake Pad Set, disc brake	Bolt Hole Circle Ø [mm]	Bolt Hole Circle Ø [mm]
	Brake Disc	Bore Ø [mm]	Bore Ø [mm]
	Wheel Brake Cylinder	Brake Caliper (3 pistons)	Brake Caliper (3 pistons)
	Wheel Speed Sensor	Brake Disc Thickness [mm]	Brake Disc Thickness [mm]
	Rear Axle Left	Brake Size	Brake Size
	Rear Axle Right	BRE	Brake System, Brembo
	Centre	Cast Aluminium	Cast Aluminium
	Front Axle Left	CB compatible package	CB compatible package
	Front Axle Right	Centering Diameter [mm]	Centering Diameter [mm]
+ ABS	for vehicles with ABS	Country specific package and status data	Country specific package and status data
+POC	for POC	- ESP	for vehicles without ESP
+PR	for PR number	Flange Hole Diameter [mm]	Flange Hole Diameter [mm]
+ WE	prepared for wear indicator	for brake disc diameter [mm]	for brake disc diameter [mm]
+ WK	with acoustic wear warning	for facelift	for facelift
+ Zub	with accessories	for individual equipment ID	for individual equipment ID
16"	16"	for left-hand drive vehicles	for left-hand drive vehicles
17" plus	17" plus	for light alloy rims	for light alloy rims
17"	17"	for steel rims	for steel rims
18"	18"		
- ABS	for vehicles without ABS		
Accessories	Accessories		
AKE	Brake System, Akebono		
ALU	Aluminium		













Technical translations

Technische Übersetzungen - Traducciones tecnicas - Traductions techniques - Traduzioni tecniche

EN		EN	
for vehicles with AMG Sports Package	for vehicles with AMG Sports Package	Service exchange part	Service exchange part
for vehicles with drum brakes on the rear axle	for vehicles with drum brakes on the rear axle	Spanner size 1 [mm]	Spanner size 1 [mm]
for vehicles with sports package	for vehicles with sports package	Spanner size 2 [mm]	Spanner size 2 [mm]
Great Britain	Great Britain	Surface	Surface
Gross vehicle weight [kg]	Gross vehicle weight [kg]	Thickness [mm]	Thickness [mm]
Height [mm]	Height [mm]	Thickness 1 [mm]	Thickness 1 [mm]
Height 1 [mm]	Height 1 [mm]	Thickness 2 [mm]	Thickness 2 [mm]
Height 2 [mm]	Height 2 [mm]	TRW	Brake System, Lucas / TRW
inner	inner	Turkey	Turkey
L=	Length [mm]	usage number	usage number
L=	Cable Length [mm]	Vehicle Production Country	Vehicle Production Country
L1=	Length 1 [mm]	Wheelbase [mm]	Wheelbase [mm]
L2=	Length 2 [mm]	Width [mm]	Width [mm]
MAN	Brake System, Mando	with brake caliper screws	with brake caliper screws
Manual Transmission	Manual Transmission	with hollow screw	with hollow screw
Minimum thickness [mm]	Minimum thickness [mm]	without brake fluid reservoir	without brake fluid reservoir
Number of Holes	Number of Holes	with spring clip	with spring clip
Part number of recommended accessories	Part number of recommended accessories	- WK	excl. wear warning contact
- Performance Parts	for vehicles without Performance brakes	x	Number of wear indicators [per axle] Number of connectors
Piston Diameter [mm]	Piston Diameter [mm]	Yes	Yes
replacement part	replacement part	∅	Diameter [mm] Inner diameter [mm] Outer diameter [mm]
Rim Size [in]	Rim Size [in]	→	Production date from Construction year from Vehicle Identification Number from
RWD	Rear-Wheel Drive	→	Construction year to

Technical translations

Technische Übersetzungen - Traducciones tecnicas - Traductions techniques - Traduzioni tecniche

DE		DE	
	Hauptbremszylinder	ATE Ceramic	Artikelzusatzbezeichnung, ATE Ceramic
	Bremsschlauch	B	beschichtet
	Seilzug, Feststellbremse	B1=	Breite 1 [mm]
	Bremssattel	B2=	Breite 2 [mm]
	Bremsbelagsatz, Scheibenbremse	Bolt Hole Circle Ø [mm]	Lochkreis-Ø [mm]
	Bremsscheibe	Bore Ø [mm]	Bohrung-Ø [mm]
	Radbremszylinder	Brake Caliper (3 pistons)	Bremssattel(3-Kolben)
	Raddrehzahlsensor	Brake Disc Thickness [mm]	Bremsscheibendicke [mm]
	Hinterachse links	Brake Size	Bremsengröße
	Hinterachse rechts	BRE	Bremssystem, Brembo
	mitte	Cast Aluminium	Aluguss
	Vorderachse links	CB compatible package	SB gerechte Verpackung
	Vorderachse rechts	Centering Diameter [mm]	Zentrierungsdurchmesser [mm]
+ ABS	für Fahrzeuge mit ABS	Country specific package and status data	Länderspezifische Verpackungs- und Status-Informationen
+POC	für POC	- ESP	für Fahrzeuge ohne ESP
+PR	für PR-Nummer	Flange Hole Diameter [mm]	Flanschlochdurchmesser [mm]
+ WE	für Verschleißwarnanzeiger vorbereitet	for brake disc diameter [mm]	für Bremsscheibendurchmesser [mm]
+ WK	mit akustischer Verschleißwarnung	for facelift	für Facelift
+ Zub	mit Zubehör	for individual equipment ID	für Individualausstattungs-ID
16"	16"	for left-hand drive vehicles	für Linkslenker
17" plus	17" plus	for light alloy rims	für Leichtmetallfelgen
17"	17"	for steel rims	für Stahlfelgen
18"	18"		
- ABS	für Fahrzeuge ohne ABS		
Accessories	Zubehör		
AKE	Bremssystem, Akebono		
ALU	Aluminium		













Technical translations

Technische Übersetzungen - Traducciones tecnicas - Traductions techniques - Traduzioni tecniche

DE		DE	
for vehicles with AMG Sports Package	für Fahrzeuge mit AMG-Sportpaket	Service exchange part	Austauschteil
for vehicles with drum brakes on the rear axle	für Fahrzeuge mit Trommelbremse an der Hinterachse	Spanner size 1 [mm]	Schlüsselweite 1 [mm]
for vehicles with sports package	für Fahrzeuge mit Sportpaket	Spanner size 2 [mm]	Schlüsselweite 2 [mm]
Great Britain	Groß Britannien	Surface	Oberfläche
Gross vehicle weight [kg]	zul. Gesamtgewicht [kg]	Thickness [mm]	Dicke/Stärke [mm]
Height [mm]	Höhe [mm]	Thickness 1 [mm]	Dicke/Stärke 1 [mm]
Height 1 [mm]	Höhe 1 [mm]	Thickness 2 [mm]	Dicke/Stärke 2 [mm]
Height 2 [mm]	Höhe 2 [mm]	TRW	Bremssystem, Lucas / TRW
inner	innen	Turkey	Türkei
L=	Länge [mm]	usage number	Gebrauchsnummer
L=	Kabellänge [mm]	Vehicle Production Country	Fahrzeugproduktionsland
L1=	Länge 1 [mm]	Wheelbase [mm]	Radstand [mm]
L2=	Länge 2 [mm]	Width [mm]	Breite [mm]
MAN	Bremssystem, Mando	with brake caliper screws	mit Bremssattelschrauben
Manual Transmission	Schaltgetriebe	with hollow screw	mit Hohlschraube
Minimum thickness [mm]	Mindestdicke [mm]	without brake fluid reservoir	ohne Bremsflüssigkeitsbehälter
Number of Holes	Lochanzahl	with spring clip	mit Haltefeder
Part number of recommended accessories	Artikelnummer des empfohlenen Zubehörs	- WK	exkl. Verschleißwarnkontakt
- Performance Parts	für Fahrzeuge ohne Performance Bremse	x	Anzahl Verschleißanzeiger [pro Achse] Anschlussanzahl
Piston Diameter [mm]	Kolbendurchmesser [mm]	Yes	Ja
replacement part	Austauschteil	∅	Durchmesser [mm] Innendurchmesser [mm] Außendurchmesser [mm]
Rim Size [in]	Felgengröße [Zoll]	→	Produktionsdatum ab Baujahr ab Fahrgestellnummer ab
RWD	Heckantrieb	→	Baujahr bis

Technical translations

Technische Übersetzungen - Traducciones técnicas - Traductions techniques - Traduzioni tecniche

ES		ES	
	Cilindro principal de freno	ATE Ceramic	Denominación adicional del artículo, ATE Ceramic
	Tubo flexible de frenos	B	revestido
	Cable de accionamiento, freno de estacionamiento	B1=	Ancho 1 [mm]
	Pinza de freno	B2=	Ancho 2 [mm]
	Juego de pastillas de freno	Bolt Hole Circle Ø [mm]	corona de agujeros - Ø [mm]
	Disco de freno	Bore Ø [mm]	Taladro Ø [mm]
	Cilindro de freno de rueda	Brake Caliper (3 pistons)	Pinza de freno (3 émbolos)
	Sensor de velocidad de la rueda	Brake Disc Thickness [mm]	Espesor de disco de frenos [mm]
	Eje trasero izquierda	Brake Size	Tamaño freno
	Eje trasero, derecha	BRE	Sistema de frenos, Brembo
	centro	Cast Aluminium	Fundición de aluminio
	Eje delantero, izquierda	CB compatible package	Embalaje apto para autoservicio
	Eje delantero, derecha	Centering Diameter [mm]	Diámetro de centrado [mm]
+ ABS	para vehículos con ABS	Country specific package and status data	Información específica del país sobre el embalaje y sobre el estado
+POC	para POC	- ESP	para vehículos sin ESP
+PR	Número de PR	Flange Hole Diameter [mm]	Diám. taladro brida [mm]
+ WE	preparado para indicador desgaste	for brake disc diameter [mm]	para diámetro disco de freno [mm]
+ WK	con avisador acústico de desgaste	for facelift	para facelift
+ Zub	con accesorios	for individual equipment ID	para ID equipamiento individual
16"	16"	for left-hand drive vehicles	para vehic. dirección izquierda
17" plus	17" plus	for light alloy rims	para llantas de metal ligero
17"	17"	for steel rims	para llantas de acero
18"	18"		
- ABS	para vehículos sin ABS		
Accessories	Accesorios		
AKE	Sistema de frenos, Akebono		
ALU	Aluminio		

Technical translations

Technische Übersetzungen - Traducciones técnicas - Traductions techniques - Traduzioni tecniche

ES	ES
for vehicles with AMG Sports Package para vehículos con paquete sport AMG	Service exchange part Pieza de intercambio
for vehicles with drum brakes on the rear axle para vehículos con freno de tambor en eje trasero	Spanner size 1 [mm] Ancho de llave 1 [mm]
for vehicles with sports package para vehículos con paquete sport	Spanner size 2 [mm] Ancho de llave 2 [mm]
Great Britain Gran Bretaña	Surface Superficie
Gross vehicle weight [kg] Peso total autorizado [kg]	Thickness [mm] Espesor [mm]
Height [mm] Altura [mm]	Thickness 1 [mm] Espesor/grosor 1 [mm]
Height 1 [mm] Altura 1 [mm]	Thickness 2 [mm] Espesor/grosor 2 [mm]
Height 2 [mm] Altura 2 [mm]	TRW Sistema de frenos, Lucas / TRW
inner interior	Turkey Turquía
L= Longitud [mm]	usage number Número de uso
L= Longitud de cable [mm]	Vehicle Production Country País producción vehículo
L1= Longitud 1 [mm]	Wheelbase [mm] Distancia entre ejes [mm]
L2= Longitud 2 [mm]	Width [mm] Ancho [mm]
MAN Sistema de frenos, Mando	with brake caliper screws con tornillos pinza freno
Manual Transmission Caja de cambios manual	with hollow screw con tornillo hueco
Minimum thickness [mm] Espesor mínimo [mm]	without brake fluid reservoir sin depósito líquido frenos
Number of Holes Número de orificios	with spring clip con clip de sujeción
Part number of recommended accessories Nº art. de accesorio recomendado	- WK excl. contacto de avisador de desgaste
- Performance Parts para vehículos sin frenos alto rendimiento	x cantidad indicadores de desgaste [por eje] Número de conexiones
Piston Diameter [mm] Diámetro del pistón [mm]	Yes sí
replacement part Recambio	∅ Diámetro [mm] Diámetro interior [mm] Diámetro exterior [mm]
Rim Size [in] Tamaño de llanta [in]	→ fecha de producción desde año construcción desde nº de chasis desde
RWD Tracción trasera	

Technical translations

Technische Übersetzungen - Traducciones tecnicas - Traductions techniques - Traduzioni tecniche

ES	FR
→ año construcción hasta	 Maître-cylindre de frein
	 Flexible de frein
	 Tirette à câble, frein de stationnement
	 Étrier de frein
	 Kit de plaquettes de frein, frein à disque
	 Disque de frein
	 Cylindre de roue
	 Capteur de vitesse de roue
	 Essieu arrière gauche
	 Essieu arrière droit
	 centre
	 Essieu avant gauche
	 Essieu avant droit
	+ ABS pour véhicules avec système antiblo- cage
	+POC pour POC
	+PR pour numéro PR
	+ WE préparé pour indicateur d'usure
	+ WK avec indicateur d'usure
	+ Zub avec accessoires
	16" 16"
	17" plus 17" plus
	17" 17"
	18" 18"
	- ABS pour véhicules sans système antiblo- cage
	Accessories Accessoires



Technical translations

Technische Übersetzungen - Traducciones técnicas - Traductions techniques - Traduzioni tecniche

FR		FR	
AKE	Système de freinage, Akebono	for vehicles with AMG Sports Package	pour véhicules avec équipement-sport AMG
ALU	Aluminium	for vehicles with drum brakes on the rear axle	pour véhicules avec frein à tambour à l'essieu arrière
ATE Ceramic	Designation d'article complémentaire, ATE Ceramic	for vehicles with sports package	pour véhicules avec équipement sport
B	revêtu	Great Britain	Grande-Bretagne
B1=	Largeur 1 [mm]	Gross vehicle weight [kg]	Poids total autorisé en charge [kg]
B2=	Largeur 2 [mm]	Height [mm]	Hauteur [mm]
Bolt Hole Circle Ø [mm]	Cercle de perçage -Ø [mm]	Height 1 [mm]	Hauteur 1 [mm]
Bore Ø [mm]	Alésage-Ø [mm]	Height 2 [mm]	Hauteur 2 [mm]
Brake Caliper (3 pistons)	Étrier de frein (3-pistons)	inner	intérieur
Brake Disc Thickness [mm]	Épaisseur du disque de frein [mm]	L=	Longueur [mm]
Brake Size	Dimension des freins	L=	Longueur de câble [mm]
BRE	Système de freinage, Brembo	L1=	Longueur 1 [mm]
Cast Aluminium	Fonte d'aluminium	L2=	Longueur 2 [mm]
CB compatible package	Emballage LS	MAN	Système de freinage, Mando
Centering Diameter [mm]	Diamètre du centrage [mm]	Manual Transmission	boîte de vitesses manuelle
Country specific package and status data	Informations d'emballage et d'état spécifiques aux pays	Minimum thickness [mm]	Épaisseur minimum [mm]
- ESP	pour véhicules sans ESP	Number of Holes	Nombre de trous
Flange Hole Diameter [mm]	Diamètre du trou de bride [mm]	Part number of recommended accessories	Référence de l'accessoire recommandé
for brake disc diameter [mm]	pour diamètre du disque de frein [mm]	- Performance Parts	pour véhicules sans frein Performance
for facelift	pour facelift	Piston Diameter [mm]	Diamètre du piston [mm]
for individual equipment ID	pour ID d'équipement individuel	replacement part	Pièce de rechange
for left-hand drive vehicles	pour véhicules avec direction à gauche	Rim Size [in]	Dimension de la jante [pouces]
for light alloy rims	pour jante en alliage léger	RWD	Propulsion
for steel rims	pour jante en acier		

Technical translations













Technische Übersetzungen - Traducciones tecnicas - Traductions techniques - Traduzioni tecniche

FR		FR
Service exchange part	Echange standard	→ Année jusqu'à
Spanner size 1 [mm]	Largeur de clé 1 [mm]	
Spanner size 2 [mm]	Largeur de clé 2 [mm]	
Surface	Surface	
Thickness [mm]	Épaisseur [mm]	
Thickness 1 [mm]	Épaisseur 1 [mm]	
Thickness 2 [mm]	Épaisseur 2 [mm]	
TRW	Système de freinage, Lucas / TRW	
Turkey	Turquie	
usage number	Numéro d'utilisation	
Vehicle Production Country	Pays constructeur du véhicule	
Wheelbase [mm]	Empattement [mm]	
Width [mm]	Largeur [mm]	
with brake caliper screws	avec vis d'étrier de frein	
with hollow screw	avec vis creuse	
without brake fluid reservoir	sans réservoir du liquide de frein	
with spring clip	avec ressort de retenue	
- WK	contact de signal d'usure exclu	
x	Nombre d'indicateurs d'usure [par essieu] Nombre de connexions	
Yes	Oui	
Ø	Diamètre [mm] Diamètre intérieur [mm] Diamètre extérieur [mm]	
→	Date de production à partir de Année à partir de N° de châssis à partir de	



Technical translations

Technische Übersetzungen - Traducciones tecnicas - Traductions techniques - Traduzioni tecniche

IT		IT	
	Cilindro maestro del freno	ALU	Alluminio
	Flessibile del freno	ATE Ceramic	Denominazione aggiuntiva dell'articolo, ATE Ceramic
	Cavo comando, Freno stazionamento	B	rivestito
	Pinza freno	B1=	Larghezza 1 [mm]
	Kit pastiglie freno, Freno a disco	B2=	Larghezza 2 [mm]
	Discofreno	Bolt Hole Circle Ø [mm]	Cerchio foro-Ø [mm]
	Cilindretto freno	Bore Ø [mm]	Alesaggio-Ø [mm]
	Sensore velocità ruote	Brake Caliper (3 pistons)	Pinza freno(3 pistoni)
	Assale posteriore Sx	Brake Disc Thickness [mm]	Spessore disco freno [mm]
	Assale posteriore Dx	Brake Size	Misura freno
	centro	BRE	Sistema frenante, Brembo
	Assale anteriore Sx	Cast Aluminium	Alluminio pressofuso
	Assale anteriore Dx	CB compatible package	Imballaggio self-service
+ ABS	per veicoli con ABS	Centering Diameter [mm]	Diametro centraggio [mm]
+POC	per POC	Country specific package and status data	Informazioni di imballaggio e di stato specifiche per i diversi Paesi
+PR	per N° PR	- ESP	per veicoli senza ESP
+ WE	Predisposto per contatto segnalazione usura	Flange Hole Diameter [mm]	Diametro foro flangia [mm]
+ WK	con segnalatore acustico usura	for brake disc diameter [mm]	per diametro disco freno [mm]
+ Zub	con accessori	for facelift	per Facelift
16"	16"	for individual equipment ID	per ID-equipaggiamento individuale
17" plus	17" plus	for left-hand drive vehicles	per veicolo con guida a Sx
17"	17"	for light alloy rims	per cerchioni in lega leggera
18"	18"	for steel rims	per cerchioni in acciaio
- ABS	per veicoli senza ABS		
Accessories	Accessori		
AKE	Sistema frenante, Akebono		

Technical translations

Technische Übersetzungen - Traducciones técnicas - Traductions techniques - Traduzioni tecniche

IT		IT	
for vehicles with AMG Sports Package	per veicoli con pacchetto sportivo AMG	Service exchange part	Ricambio di rotazione
for vehicles with drum brakes on the rear axle	per veicoli con freni a tamburo ad assale posteriore	Spanner size 1 [mm]	Apertura chiave 1 [mm]
for vehicles with sports package	per veicoli con pacchetto sportivo	Spanner size 2 [mm]	Apertura chiave 2 [mm]
Great Britain	Gran Bretagna	Surface	Superficie
Gross vehicle weight [kg]	Peso complessivo omologato [kg]	Thickness [mm]	Spessore [mm]
Height [mm]	Altezza [mm]	Thickness 1 [mm]	Spessore 1 [mm]
Height 1 [mm]	Altezza 1 [mm]	Thickness 2 [mm]	Spessore 2 [mm]
Height 2 [mm]	Altezza 2 [mm]	TRW	Sistema frenante, Lucas / TRW
inner	interno	Turkey	Turchia
L=	Lunghezza [mm]	usage number	Codice d'uso
L=	Lunghezza cavo [mm]	Vehicle Production Country	Paese produzione veicolo
L1=	Lunghezza 1 [mm]	Wheelbase [mm]	Passo ruote [mm]
L2=	Lunghezza 2 [mm]	Width [mm]	Larghezza [mm]
MAN	Sistema frenante, Mando	with brake caliper screws	con bulloni pinza freno
Manual Transmission	Cambio manuale	with hollow screw	con vite cava
Minimum thickness [mm]	Spessore min. [mm]	without brake fluid reservoir	senza serbatoio liquido freni
Number of Holes	N° fori	with spring clip	con molla di tenuta
Part number of recommended accessories	N° articolo accessorio consigliato	- WK	senza contatto segnalazione usura
- Performance Parts	per veicoli senza freno Performance	x	N° indicatori usura [per asse] N° raccordi
Piston Diameter [mm]	Diametro pistone [mm]	Yes	Sì
replacement part	Ricambio di rotazione	∅	Diametro [mm] Diametro interno [mm] Diametro esterno [mm]
Rim Size [in]	Misura cerchione [pollici]	→	Data di produzione da Anno da N° telaio da
RWD	Trazione posteriore	→	Anno fino a

ATE – A Trademark of the
Continental Corporation

**Continental Aftermarket & Services
GmbH**

Sodener Straße 9
D-65824 Schwalbach
Tel. +49 (0) 6196 87 0
Fax +49 (0) 6196 865 71

www.ate.de

**Continental Automotive Trading
Italia S.r.l.**

Via Matteotti, 62
I-20092 Cinisello Balsamo (MI)
Tel. +39 02 35680 1
Fax +39 02 35680 325
E-Mail: supporto@continental-corporation.com

www.ate-freni.it

Continental Automotive France SAS

1 rue de Clairefontaine
F-78120 Rambouillet
Tél. +33 (0)1 34 57 40 19
Fax +33 (0)1 34 57 40 72

www.ate-freinage.fr

Continental Automotive Spain, S.A.

C/ Sepúlveda, 11
E-28108 Alcobendas (Madrid) Phone
+34 (0) 657 21 21
Fax +34 (0)91 657 21 49

www.frenos-ate.es