

ATE New Parts

ATE Neuteile

01/2022



Brakethrough Technology



Erstklassig First-class

Besser ist besser

Wenn es um Qualität geht, genügt uns ein „sehr gut“ noch lange nicht. Wir erfüllen hohe Ansprüche an das Qualitätsmanagement und die europäische Sicherheitsnorm ECE-R90 wird von ATE sogar übertroffen. Zudem führen wir zahlreiche zusätzliche Tests durch, unter anderem zu Verschleiß und Wärmeleistung.

Auch Nachhaltigkeit ist uns wichtig: Wir stellen die Mischungen für ATE Bremsbeläge auf kupferfreie Materialien um und setzen bei ATE Ceramic auf geringen Abrieb. Nutzen ausschließlich umweltfreundliches Material für die Beschichtung von Bremscheiben. Und bereiten Produkte wie Bremsattel wieder auf.

Better is better

When it comes to quality, “very good” is simply not good enough for us. We meet high standards of quality management – and ATE even exceeds the European safety standard ECE-R90. We also perform many additional tests, including wear and thermal performance.

Sustainability is also important to us: we convert the compounds for ATE brake pads to copperfree materials and opt for low abrasion with ATE Ceramic. We only use environmentally friendly material for the coating of brake discs – and we remanufacture products like brake callipers.

Höchste Qualität für optimale Leistung.



NEU: SUPER DOT 5.1

Neue Premium-Flüssigkeit ATE SUPER DOT 5.1 mit bester Funktionalität bei heißen wie kalten Einsatzbedingungen: 5°C höherer Nassiedepunkt und höheres Wechselintervall als ATE SL.6 bei gleich guter Viskosität, ideal für Fahrzeuge mit modernen Fahrerassistenzsystemen wie ESP®, ABS und ASR.

Große Auswahl für alle Einsatzgebiete

- | ATE SL als bewährter DOT 4 Typ, ATE TYP 200 für Rennsportbegeisterte und ATE DOT 3 G für Oldtimer und Fahrzeuge, wo die Verwendung einer DOT 3-Flüssigkeit vom Fahrzeughersteller vorgeschrieben ist
- | ATE SL.6 ist optimal für ESP®, ABS und ASR: dünnflüssig auch bei niedrigen Temperaturen, schnelle Reaktionszeit
- | Siedepunkte und Viskosität übertreffen gesetzliche und technische Anforderungen
- | Schutz vor Korrosion durch hochwertige Additive

Die Eigenschaften von ATE Bremsflüssigkeiten

	Siedepunkt	Nassiedepunkt	Viskosität bei -40°C	Wechselintervall
ATE SUPER DOT 5.1	min. 265°C	min. 180°C	max. 750 mm ² /s	bis 3 Jahre
ATE TYP 200 DOT 4 Racing-Qualität	min. 280°C	min. 198°C	max. 1.400 mm ² /s	bis 3 Jahre
ATE SL.6 DOT 4 Ideal für ESP®, ABS, ASR	min. 265°C	min. 175°C	max. 700 mm ² /s	bis 2 Jahre
ATE SL DOT 4	min. 260°C	min. 165°C	max. 1.400 mm ² /s	bis 1 Jahr
ATE G DOT 3	min. 245°C	min. 150°C	max. 1.500 mm ² /s	bis 1 Jahr

Zur Erhaltung der Funktionssicherheit der Bremsanlage muss Bremsflüssigkeit entsprechend der vom Fahrzeughersteller vorgegebenen Qualität und in den angegebenen Wechselintervallen ausgetauscht werden.

Servicegeräte

Natürlich bieten wir auch Geräte für Tests, Entlüftung und Entsorgung von Bremsflüssigkeiten an. Sie arbeiten exakt und zuverlässig, sind leicht zu bedienen und technologisch auf dem neuesten Stand.

Erfahren Sie mehr über ATE Bremsflüssigkeiten auf www.ate.de/bremsfluessigkeit sowie über unsere Servicegeräte auf www.ate-info.de



Typ	ATE Sachnummer	EAN-Nr. 4006633	Gebinde	Paletteneinheit
SUPER DOT 5.1 SAE-Spezifikation, J1704-FMVSS 116/DOT 5.1 ISO Klasse 5-1 – niedrigviskos	706602 03.9901-6602.2	45757 6	1 l	600 Kannen ²
	706603 03.9901-6603.2	45759 0	5 l	400 Kannen ³
	706611 03.9901-6611.2	45761 3	20 l	36 Kannen
TYP 200 SAE-Spezifikation, J1704-FMVSS 116/DOT 4	706202 03.9901-6202.2	10825 6	1 l	600 Kannen ²
	706203 03.9901-6203.2	12166 8	5 l	400 Kannen ³
	706220 03.9901-6220.2	12780 6	30 l	22 Kannen
SL.6 SAE-Spezifikation, J1704-FMVSS 116/DOT 4 ISO-Klasse 6 – niedrigviskos	706402 03.9901-6402.2	20746 1	1 l	600 Kannen ²
	706403 03.9901-6403.2	20748 5	5 l	400 Kannen ³
	706411 03.9901-6411.2	20750 8	20 l	36 Kannen
	706420 03.9901-6420.2	23120 6	30 l	22 Kannen
	706414 03.9901-6414.2	23005 6	50 l	12 Kannen
	706405 03.9901-6405.2	23121 3	200 l	1 Stück
SL SAE-Spezifikation, J1704-FMVSS 116/DOT 4	705801 03.9901-5801.2	49001 6	1/2 l	1.200 Kannen ¹
	705802 03.9901-5802.2	49002 3	1 l	600 Kannen ²
	705803 03.9901-5803.2	49003 0	5 l	400 Kannen ³
	705811 03.9901-5811.2	29907 7	20 l	12 Kannen
	705820 03.9901-5820.2	10824 9	30 l	22 Kannen
	705814 03.9901-5814.2	10366 4	50 l	12 Kannen
	705805 03.9901-5805.2	49005 4	200 l	1 Stück
G SAE-Spezifikation, J1703-FMVSS 116/DOT 3	705302 03.9901-5302.2	10199 8	1 l	600 Kannen ²
	705303 03.9901-5303.2	10201 8	5 l	400 Kannen ³

Abweichende Artikelnummern für Lieferländer außerhalb Deutschlands möglich.

Paletteneinheit:

¹ 20 Kannen je Karton

² 10 Kannen je Karton

³ 4 Kannen je Karton

Top quality for optimum performance.



NEW: SUPER DOT 5.1

The new premium ATE SUPER DOT 5.1 brake fluid with optimum performance in both hot and cold conditions: 5°C higher wet boiling point than ATE SL.6, same excellent viscosity, longer change interval, ideal for vehicles with advanced driver assistance systems like ESP®, ABS and ASR.

Wide selection for all applications

- | ATE SL as a proven DOT 4 grade, ATE TYPE 200 for racing enthusiasts and ATE DOT 3 G for classic cars and vehicles for which the manufacturer specifies a DOT 3 brake fluid
- | ATE SL.6 is optimal for ESP®, ABS and ASR: low viscosity even at low temperatures, with a fast reaction time
- | Boiling points and viscosities are better than in statutory and technical regulations
- | Protection from corrosion by high-grade additives

Properties of ATE brake fluids

	Boiling point	Wet boiling point	Viscosity at -40°C	Change interval
ATE SUPER DOT 5.1	min. 265 °C / 509 °F	min. 180 °C / 356 °F	max. 750 mm ² /s	up to 3 years
ATE TYPE 200 DOT 4 Racing quality	min. 280 °C / 536 °F	min. 198 °C / 388 °F	max. 1,400 mm ² /s	up to 3 years
ATE SL.6 DOT 4 Ideal for ESP®, ABS, ASR	min. 265 °C / 509 °F	min. 175 °C / 347 °F	max. 700 mm ² /s	up to 2 years
ATE SL DOT 4	min. 260 °C / 500 °F	min. 165 °C / 329 °F	max. 1,400 mm ² /s	up to 1 year
ATE G/ATE Blue DOT 3	min. 245 °C / 473 °F	min. 150 °C / 302 °F	max. 1,500 mm ² /s	up to 1 year

To maintain the operational reliability and safety of the brake system, you must change the brake fluid in accordance with the vehicle manufacturer's recommendations on quality and at the specified change intervals.

Service units

Of course we also offer devices for testing, bleeding and disposing of brake fluids. The devices work accurately and reliably, are easy to use and their technology is state-of-the-art.



To learn more about ATE brake fluids go to www.ate.de/bremsfluessigkeit. Information on our service units is available at www.ate-info.de

Type	ATE item code	Language variations	Container	Pallet unit
SUPER DOT 5.1 SAE specification, J1704-FMVSS 116/DOT 5.1 ISO Class 5-1 – low viscosity	706602 03.9901-6602.2	DE, EN, ES, PT, CN, FR, IT, AR, SE, NL, JP, TH, GR	1 L	600 cans ²
	706612 03.9901-6612.2	PL, RU, CZ, SK, SLO, HU, BG, KA, HR, SR, RO	1 L	600 cans ²
	706603 03.9901-6603.2	DE, EN, ES, PT, CN, FR, IT, AR, SE, NL, JP, TH, GR, PL, RU, CZ, SK, SLO, HU, BG, KA, HR, SR, RO	5 L	400 cans ³
	706611 03.9901-6611.2	DE, EN, ES, PT, CN, FR, IT, AR, SE, NL, JP, TH, GR, PL, RU, CZ, SK, SLO, HU, BG, KA, HR, SR, RO	20 L	36 cans
TYP 200 SAE specification, J1704-FMVSS 116/DOT 4	706202 03.9901-6202.2	DE, EN, ES, PT, CN, FR, IT, AR, SE, NL, JP, TH, GR	1 L	600 cans ²
	706212 03.9901-6212.2	PL, RU, CZ, SK, SLO, HU, BG, KA, HR, SR, RO	1 L	600 cans ²
	706203 03.9901-6203.2	DE, EN, PL, ES, CN, FR, IT, RO, AR, SE, RU, HR, SR, CZ, SK, SLO, GR, HU, JP, TH, BG, NL, PT, KA, DK, FI, SQ, TR, LV, NO, LT, MS, HY	5 L	400 cans ³
	706220 03.9901-6220.2	DE, EN, PL, ES, CN, FR, IT, RO, AR, SE, RU, HR, SR, CZ, SK, SLO, GR, HU, JP, TH, BG, NL, PT, KA, DK, FI, SQ, TR	30 L	22 cans
SL.6 SAE specification, J1704-FMVSS 116/DOT 4 ISO Class 6 – low viscosity	706402 03.9901-6402.2	DE, EN, ES, PT, CN, FR, IT, AR, SE, NL, JP, TH, GR	1 L	600 cans ²
	706432 03.9901-6432.2	PL, RU, CZ, SK, SLO, HU, BG, KA, HR, SR, RO	1 L	600 cans ²
	706403 03.9901-6403.2	DE, EN, PL, ES, CN, FR, IT, RO, AR, SE, RU, HR, SR, CZ, SK, SLO, GR, HU, JP, TH, BG, NL, PT, KA, DK, FI, SQ, TR, LV, NO, LT, MS, HY	5 L	400 cans ³
	706411 03.9901-6411.2	DE, EN, PL, ES, CN, FR, IT, RO, AR, SE, RU, HR, SR, CZ, SK, SLO, GR, HU, JP, TH, BG, NL, PT, KA, DK, FI, SQ, TR, LV	20 L	36 cans
	706420 03.9901-6420.2	DE, EN, PL, ES, CN, FR, IT, RO, AR, SE, RU, HR, SR, CZ, SK, SLO, GR, HU, JP, TH, BG, NL, PT, KA, DK, FI, SQ, TR	30 L	22 cans
	706414 03.9901-6414.2	DE, EN, PL, ES, CN, FR, IT, RO, AR, SE, RU, HR, SR, CZ, SK, SLO, GR, HU, JP, TH, BG, NL, PT, KA, DK, FI, SQ, TR	50 L	12 cans
	706405 03.9901-6405.2	DE, EN, PL, ES, CN, FR, IT, RO, AR, SE, RU, HR, SR, CZ, SK, SLO, GR, HU, JP, TH, BG, NL, PT, KA, DK, FI, SQ, TR	200 L	1 item
SL SAE specification, J1704-FMVSS 116/DOT 4	705801 03.9901-5801.2	DE, EN, ES, AR, TH, CN	1/2 L	1,200 cans ¹
	705831 03.9901-5831.2	PL, RO, RU, HR, SLO, KA	1/2 L	1,200 cans ²
	705802 03.9901-5802.2	DE, EN, ES, PT, CN, FR, IT, AR, SE, NL, JP, TH, GR	1 L	600 cans ²
	705832 03.9901-5832.2	PL, RU, CZ, SK, SLO, HU, BG, KA, HR, SR, RO	1 L	600 cans ²
	705803 03.9901-5803.2	DE, EN, PL, ES, CN, FR, IT, RO, AR, SE, RU, HR, SR, CZ, SK, SLO, GR, HU, JP, TH, BG, NL, PT, KA, DK, FI, SQ, TR, LV, NO, LT, MS, HY	5 L	400 cans ³
	705811 03.9901-5811.2	DE, EN, PL, ES, CN, FR, IT, RO, AR, SE, RU, HR, SR, CZ, SK, SLO, GR, HU, JP, TH, BG, NL, PT, KA, DK, FI, SQ, TR, LV	20 L	12 cans
	705820 03.9901-5820.2	DE, EN, PL, ES, CN, FR, IT, RO, AR, SE, RU, HR, SR, CZ, SK, SLO, GR, HU, JP, TH, BG, NL, PT, KA, DK, FI, SQ, TR	30 L	22 cans
	705814 03.9901-5814.2	DE, EN, PL, ES, CN, FR, IT, RO, AR, SE, RU, HR, SR, CZ, SK, SLO, GR, HU, JP, TH, BG, NL, PT, KA, DK, FI, SQ, TR	50 L	12 cans
	705805 03.9901-5805.2	DE, EN, PL, ES, CN, FR, IT, RO, AR, SE, RU, HR, SR, CZ, SK, SLO, GR, HU, JP, TH, BG, NL, PT, KA, DK, FI, SQ, TR	200 L	1 item
G SAE specification, J1703-FMVSS 116/DOT 3	705302 03.9901-5302.2	-	1 L	600 cans ²
	705303 03.9901-5303.2	-	5 L	400 cans ³
BLUE SAE specification, J1703-FMVSS 116/DOT 3	700301 03.9901-0301.2	-	1/2 L	1,200 cans ²
	700302 03.9901-0302.2	-	1 L	600 cans ²

Item codes may be different for countries of delivery other than Germany.

Pallet unit: ¹20 cans per box, ²10 cans per box, ³4 cans per box

EN Table of contents

Index of vehicles
Product details
Applications of vehicles
Technical translations

DE Inhaltsverzeichnis

8	Herstellerverzeichnis
10	Produktdetails
15	Fahrzeugverwendungen
32	Technische Übersetzungen

ES Índice

8	Índice de vehículos	8
10	Descripción del producto	10
15	Aplicaciones	15
32	Traducciones técnicas	32

FR Table des matières

Liste des véhicules
Présentation du produit
Applications
Traductions techniques

IT Sommario

8	Indice autovetture	8
10	Panoramica prodotti	10
15	Applicazioni autoveicoli	15
32	Traduzioni tecniche	32



- EN** Index of vehicles
- DE** Herstellerverzeichnis
- ES** Índice de vehículos
- FR** Liste des véhicules
- IT** Indice autovetture

01/2022





AUDI 16

A3 (8V1, 8VK)	16
A3 Convertible (8V7, 8VE)	16
A3 Limousine (8VS, 8VM)	16
A3 Sportback (8VA, 8VF)	16
Q2 (GAB, GAG)	17

BMW 17

3 (G20, G80, G28)	17
3 Touring (G21, G81)	17
3 Touring Van (G21)	18
4 Convertible (G23, G83)	18
4 Coupe (G22, G82)	18
4 Gran Coupe (G26)	18
7 (G11, G12)	18
8 Convertible (G14, F91)	18
8 Coupe (G15, F92)	18
8 Gran Coupe (G16, F93)	18
X7 (G07)	19

FORD 19

TOURNEO CUSTOM V362 Bus (F3)	19
TRANSIT CUSTOM V362 Bus (F3)	19
TRANSIT CUSTOM V362 Van (FY, FZ)	19
TRANSIT V363 Bus (FAD, FBD)	19
TRANSIT V363 Platform/Chassis (FED, FFD)	19
TRANSIT V363 Van (FCD, FDD)	19

LAND ROVER 19

DISCOVERY SPORT (L550)	19
DISCOVERY SPORT VAN (L550)	20
RANGE ROVER EVOQUE (L551)	20

LEXUS 20

ES (_Z10_, _A10_, _H10_)	20
GX (URJ15_, GRJ15_)	20
NX (_Z1_)	20
UX (_AA1_, _AH1_, _MA1_)	21

MERCEDES-BENZ 21

C-CLASS (W205)	21
C-CLASS Convertible (A205)	21
C-CLASS Coupe (C205)	22
C-CLASS T-Model (S205)	22
CLS (C257)	22
E-CLASS (W213)	23
E-CLASS All-Terrain (S213)	23
E-CLASS Convertible (A238)	23
E-CLASS Coupe (C238)	24
E-CLASS T-Model (S213)	24
GLC (X253)	24
GLC Coupe (C253)	25

MITSUBISHI 25

PAJERO II (V3_W, V2_W, V4_W)	25
PAJERO II Canvas Top (V2_W, V4_W)	25

SEAT 25

ATECA (KH7, KHP)	25
LEON (5F1)	25
LEON Hatchback Van (5F1)	25
LEON SC (5F5)	26
LEON ST (5F8)	26
LEON ST Estate Van (5F8)	26

SKODA 26

OCTAVIA III (5E3, NL3, NR3)	26
OCTAVIA III Combi (5E5, 5E6)	27



SMART 27

FORTWO Cabrio (451)	27
FORTWO Coupe (450)	27
FORTWO Coupe (451)	27

TOYOTA 27

4 RUNNER V (_N28_)	27
CAMRY (_V7_, _VA7_, _VH7_)	27
C-HR (_X1_)	28
C-HR VAN (_X1_)	28
FJ CRUISER (GSJ1_)	28
LAND CRUISER 200 (_J2_)	28
LAND CRUISER PRADO (_J15_)	28
LAND CRUISER VAN (_J15_)	28
RAV 4 V (_A5_, _H5_)	28
RAV 4 V VAN (_A5_, _H5_)	28

VW 28

CADDY ALLTRACK Box Body/MPV (SAA)	29
CADDY ALLTRACK MPV (SAB)	29
CADDY IV Box Body/MPV (SAA, SAH)	29
CADDY IV MPV (SAB, SAJ)	29
GOLF ALLTRACK VII Variant (BA5, BV5)	31
GOLF SPORTSVAN VII (AM1, AN1)	31
GOLF VAN VII Variant (BA5)	31
GOLF VI (5K1)	29
GOLF VII (5G1, BQ1, BE1, BE2)	29
GOLF VIII (CD1)	30
GOLF VIII Variant (CG5)	30
GOLF VII Van (5G1)	30
GOLF VII Variant (BA5, BV5)	30
T-ROC (A11)	31
T-ROC Convertible (AC7)	31



- EN** Product details
- DE** Produktdetails
- ES** Descripción del producto
- FR** Présentation du produit
- IT** Panoramica prodotti

01/2022



13.0460-0522.2

610522

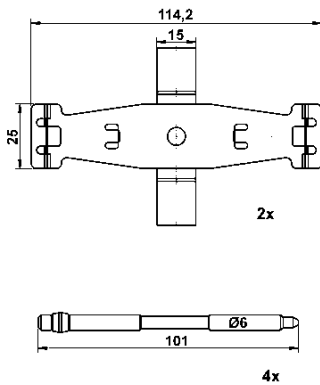

Accessory Kit, disc brake pad

Disc Brake

MERCEDES-BENZ

13.0460-2640.2

602640



Brake Pad Set, disc brake

Thickness [mm] 18

with brake caliper screws

Height 1 [mm]: 80.5

TRW

+ Zub

Observe dimensions

+ WE / - WK

Width [mm] 116.1

Height 2 [mm]: 74.8

BMW

13.0460-5524.2

605524



Brake Pad Set, disc brake

Thickness [mm] 17

with brake caliper screws

Height 1 [mm]: 49.7

+ Zub

+ WE / - WK

Width [mm] 98.6

Height 2 [mm]: 44.3

BMW

13.0470-5524.2

LD5524



Brake Pad Set, disc brake

Thickness [mm] 17
with brake caliper screws
Height 1 [mm]: 49.7
+ Zub
+ WE / - WK
Width [mm] 98.6
Height 2 [mm]: 44.3

BMW

13.0470-5693.2

LD5693



Brake Pad Set, disc brake

Thickness [mm] 14.5
AKE
- WE / - WK
Height [mm] 42.7
Width [mm] 121

LEXUS, TOYOTA

24.3421-1721.5

241435



Brake Caliper

without holder
Service exchange part
Piston Diameter [mm]: 42

SMART

24.3421-1722.5

241436



Brake Caliper

without holder
Service exchange part
Piston Diameter [mm]: 42

SMART

24.3571-1803.5

241427



Brake Caliper

without holder
Service exchange part
Piston Diameter [mm]: 57

AUDI, SEAT, SKODA, VW

24.3571-1804.5

241428



Brake Caliper

without holder

Service exchange part

Piston Diameter [mm]: 57

AUDI, SEAT, SKODA, VW

24.3727-0683.2

580683

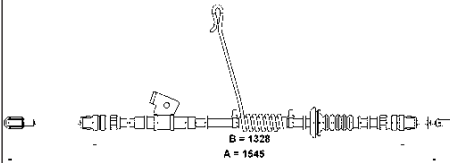

Cable Pull, parking brake

L= 1,545

FORD

24.3727-2124.2

582124

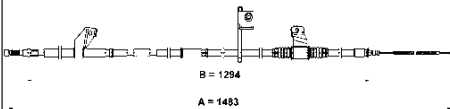

Cable Pull, parking brake

L= 1,483

MITSUBISHI

24.5201-0258.3

331544

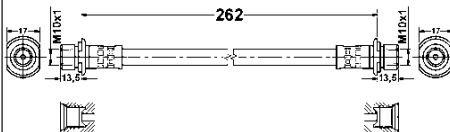

Brake Hose

L= 262

Spanner size 1 [mm]: 17

LEXUS, TOYOTA

24.8190-0821.2

620821



Warning Contact, brake pad wear

Disc Brake

L= 841

LAND ROVER



EN Applications of vehicles

DE Fahrzeugverwendungen



















ES Aplicaciones











FR Applications

















IT Applicazioni autoveicoli















01/2022





















	kW			 	! #			
AUDI - A3 (8V1, 8VK) 04/12→10/20								
 Brake Caliper								
1.0 TFSI	85	07/16→12/17	←	+PR 1ZE / 1ZP; 		24.3571-1803.5	241427	without holder
1.2 TFSI	77 - 81	02/13→08/16	←	+PR 1ZE / 1ZP; 		24.3571-1804.5	241428	without holder
1.4 TFSI	90 - 103	04/12→08/16						
1.4 TSI	110	05/14→12/17						
1.5 TFSI	110	05/17→12/17						
1.6 TDI	77 - 85	10/12→10/20						
1.8 TFSI	132	04/12→08/16						
1.8 TFSI quattro	132	08/12→08/16						
2.0 TDI	81 - 135	04/12→10/20						
2.0 TDI quattro	110 - 135	10/12→12/17						
2.0 TFSI	140	05/16→12/17						
2.0 TFSI quattro	140	05/16→12/17						
S3 quattro	206 - 228	11/12→12/17						
AUDI - A3 Convertible (8V7, 8VE) 10/13→								
 Brake Caliper								
1.4 TFSI	85 - 103	10/13→	←	+PR 1ZE / 1ZP; 		24.3571-1803.5	241427	without holder
1.4 TSI	110	05/14→10/20	←	+PR 1ZE / 1ZP; 		24.3571-1804.5	241428	without holder
1.5 TFSI	110	05/17→10/18						
1.6 TDI	81 - 85	02/14→10/20						
1.8 TFSI	125 - 132	10/13→10/20						
1.8 TFSI quattro	132	03/14→						
2.0 TDI	100 - 135	10/13→						
2.0 TDI quattro	110 - 135	03/14→10/20						
2.0 TFSI	140	05/16→10/20						
2.0 TFSI quattro	140 - 162	05/14→10/20						
35 TFSI	110	10/18→10/20						
40 TFSI	140	11/18→10/20						
40 TFSI quattro	140	11/18→10/20						
S3 quattro	210 - 228	03/14→						
AUDI - A3 Limousine (8VS, 8VM) 05/13→								
 Brake Caliper								
1.0 TFSI	85	07/16→10/20	←	+PR 1ZE / 1ZP; 		24.3571-1803.5	241427	without holder
1.2 TFSI	77 - 81	10/13→	←	+PR 1ZE / 1ZP; 		24.3571-1804.5	241428	without holder
1.4 TFSI	90 - 103	05/13→						
1.4 TSI	110	05/14→10/20						
1.5 TFSI	110	05/17→10/18						
1.6 TDI	77 - 85	09/13→						
1.6 TDI quattro	81	05/15→						
1.8 TFSI	125 - 132	05/13→						
1.8 TFSI quattro	132	11/13→						
2.0 TDI	81 - 135	05/13→						
2.0 TDI quattro	110 - 135	10/13→10/20						
2.0 TFSI	140 - 162	11/15→10/20						
2.0 TFSI quattro	140	05/16→10/20						
30 TDI	85	07/18→10/20						
30 TFSI	85	07/18→10/20						
35 TDI	110	07/18→10/20						
35 TFSI	110	10/18→10/20						
40 TDI quattro	135	07/18→07/19						
40 TFSI	140	07/18→10/20						
40 TFSI quattro	140	07/18→10/20						
RS3 quattro	294	04/17→10/20						
S3 quattro	206 - 228	10/13→						
AUDI - A3 Sportback (8VA, 8VF) 09/12→								
 Brake Caliper								
1.0 TFSI	85	07/16→10/20	←	+PR 1ZE / 1ZP; 		24.3571-1803.5	241427	without holder







	kw			 	! #		
AUDI - A3 Sportback (8VA, 8VF) 09/12→							
 Brake Caliper							
1.2 TFSI	77 - 81	05/13→	←	+PR 1ZE / 1ZP; ☐		24.3571-1804.5 241428	without holder
1.4 TFSI	90 - 103	09/12→					
1.4 TFSI e-tron	110 - 150	05/14→10/20					
1.4 TFSI g-tron	81	11/13→10/20					
1.4 TSI	110	05/14→10/20					
1.5 TFSI	110	05/17→10/18					
1.6 TDI	77 - 85	10/12→					
1.6 TDI quattro	81	05/15→08/16					
1.8 TFSI	132	09/12→					
1.8 TFSI quattro	132	05/13→					
2.0 TDI	81 - 135	09/12→10/20					
2.0 TDI quattro	110 - 135	02/13→10/20					
2.0 TFSI	140	05/16→10/20					
2.0 TFSI quattro	140	05/16→10/20					
30 g-tron	96	11/18→10/20					
30 TDI	85	07/18→10/20					
30 TFSI	85	07/18→10/20					
35 TDI	110	07/18→10/20					
35 TFSI	110	10/18→10/20					
40 TDI quattro	135	07/18→10/20					
40 TFSI	140	07/18→10/20					
40 TFSI quattro	140	07/18→10/20					
S3 quattro	206 - 228	11/12→					
AUDI - Q2 (GAB, GAG) 06/16→							
 Brake Caliper							
1.0 TFSI	85	10/16→10/20	←	+PR 1ZE / 1ZJ; ☐		24.3571-1803.5 241427	without holder
1.4 TFSI	110	06/16→08/18					
1.6 TDI	85	06/16→10/18	←	+PR 1ZE / 1ZJ; ☐		24.3571-1804.5 241428	without holder
2.0 TDI	110	09/16→					
2.0 TDI quattro	110 - 140	07/16→					
2.0 TFSI quattro	140	05/17→					
30 TDI	85	07/18→					
30 TFSI	81 - 85	07/18→					
35 TDI	110	09/16→					
35 TDI quattro	110	09/18→					
35 TFSI	110	07/18→					
40 TFSI quattro	140	09/18→					
SQ2 TFSI quattro	221	08/18→					
BMW - 3 (G20, G80, G28) 11/18→							
 Brake Pad Set, disc brake							
316 d	85 - 90	03/20→	→	for vehicles without M-sport brakes		13.0460-5524.2 605524	+ WE / - WK + Zub
316 d Mild-Hybrid	85 - 90	08/20→				13.0470-5524.2 LD5524	+ WE / - WK + Zub Ceramic
318 d	100 - 110	03/19→03/20					
318 d Mild-Hybrid	100 - 110	04/20→					
318 i	115	03/20→					
320 d	120 - 140	11/18→					
320 d Mild-Hybrid	120 - 140	03/20→					
320 d Mild-Hybrid xDrive	120 - 140	03/20→					
320 d xDrive	120 - 140	11/18→02/20					
320 i	135	03/19→					
320 i 1.6	125	03/19→					
BMW - 3 Touring (G21, G81) 07/19→							
 Brake Pad Set, disc brake							
316 d	85 - 90	11/20→	→	for vehicles without M-sport brakes		13.0460-5524.2 605524	+ WE / - WK + Zub
316 d Mild-Hybrid	85 - 90	07/20→				13.0470-5524.2 LD5524	+ WE / - WK + Zub Ceramic
318 d	100 - 110	11/19→07/20					
318 i	115	03/20→					







	kW					! #		
BMW - 3 Touring (G21, G81) 07/19→								
 Brake Pad Set, disc brake								
320 d	120 - 140	07/19→02/20	➡	for vehicles without M-sport brakes			13.0460-5524.2 605524	+ WE / - WK + Zub
320 d Mild-Hybrid	120 - 140	03/20→					13.0470-5524.2 LD5524	+ WE / - WK + Zub Ceramic
320 d Mild-Hybrid xDrive	120 - 140	03/20→						
320 d xDrive	120 - 140	07/19→02/20						
320 i	135	11/19→						
BMW - 3 Touring Van (G21) 07/19→								
 Brake Pad Set, disc brake								
320 d	140	07/19→02/20	➡	for vehicles without M-sport brakes			13.0460-5524.2 605524	+ WE / - WK + Zub
320 d Mild-Hybrid	140	03/20→					13.0470-5524.2 LD5524	+ WE / - WK + Zub Ceramic
320 d Mild-Hybrid xDrive	140	03/20→						
320 d xDrive	140	07/19→02/20						
320 i	135	11/19→						
BMW - 4 Convertible (G23, G83) 11/20→								
 Brake Pad Set, disc brake								
420 d Mild-Hybrid	120 - 140	11/20→	➡	for vehicles without M-sport brakes			13.0460-5524.2 605524	+ WE / - WK + Zub
420 i	135	11/20→					13.0470-5524.2 LD5524	+ WE / - WK + Zub Ceramic
BMW - 4 Coupe (G22, G82) 07/20→								
 Brake Pad Set, disc brake								
420 d Mild-Hybrid	140	07/20→	➡	for vehicles without M-sport brakes			13.0460-5524.2 605524	+ WE / - WK + Zub
420 d Mild-Hybrid xDrive	120 - 140	07/20→					13.0470-5524.2 LD5524	+ WE / - WK + Zub Ceramic
420 i	135	07/20→						
420 i 1.6	125	11/20→						
420 i xDrive	135	07/21→						
BMW - 4 Gran Coupe (G26) 07/21→								
 Brake Pad Set, disc brake								
420 d Mild-Hybrid	140	07/21→	➡	for vehicles without M-sport brakes			13.0460-5524.2 605524	+ WE / - WK + Zub
420 d Mild-Hybrid xDrive	140	07/21→					13.0470-5524.2 LD5524	+ WE / - WK + Zub Ceramic
420 i	135	07/21→						
BMW - 7 (G11, G12) 07/15→								
 Brake Pad Set, disc brake								
750 Li xDrive	330	03/16→	➡				13.0460-2640.2 602640	TRW + WE / - WK + Zub
Li xDrive	448	12/16→02/19						
M 760 i	448	12/16→02/19						
M 760 Li xDrive	430	03/19→						
BMW - 8 Convertible (G14, F91) 11/18→								
 Brake Pad Set, disc brake								
840 d Mild-Hybrid xDrive	250	11/20→	➡	for vehicles with sports package;			13.0460-2640.2 602640	TRW + WE / - WK + Zub
840 d xDrive	235	11/18→10/20		for vehicles with sports brake system				
840 i	245 - 250	07/19→	➡	for vehicles with M-sport brakes /			13.0460-2640.2 602640	TRW + WE / - WK + Zub
840 i xDrive	245 - 250	07/19→		for vehicles with M-performance brakes				
M 850 i xDrive	390	11/18→	➡				13.0460-2640.2 602640	TRW + WE / - WK + Zub
BMW - 8 Coupe (G15, F92) 07/18→								
 Brake Pad Set, disc brake								
840 d Mild-Hybrid xDrive	250	11/20→	➡	for vehicles with sports package;			13.0460-2640.2 602640	TRW + WE / - WK + Zub
840 d xDrive	235	07/18→10/20		for vehicles with sports brake system				
840 i	245 - 250	07/19→	➡	for vehicles with M-sport brakes /			13.0460-2640.2 602640	TRW + WE / - WK + Zub
840 i xDrive	245 - 250	07/19→		for vehicles with M-performance brakes				
M 850 i xDrive	390	10/18→	➡				13.0460-2640.2 602640	TRW + WE / - WK + Zub
BMW - 8 Gran Coupe (G16, F93) 07/19→								
 Brake Pad Set, disc brake								
840 d Mild-Hybrid xDrive	250	11/20→	➡	for vehicles with sports package;			13.0460-2640.2 602640	TRW + WE / - WK + Zub
840 d xDrive	235	07/19→10/20		for vehicles with sports brake system				
840 i	245 - 250	07/19→	➡	for vehicles with M-sport brakes /			13.0460-2640.2 602640	TRW + WE / - WK + Zub
840 i xDrive	245 - 250	07/19→		for vehicles with M-performance brakes				







	kw					! #		
BMW - 8 Gran Coupe (G16, F93) 07/19→								
 Brake Pad Set, disc brake								
840 i xDrive	245 - 250	07/19→	➡	for vehicles with M-sport brakes / for vehicles with M-performance brakes		13.0460-2640.2	602640	TRW + WE / - WK + Zub
M 850 i xDrive	390	07/19→	➡			13.0460-2640.2	602640	TRW + WE / - WK + Zub
BMW - X7 (G07) 03/19→								
 Brake Pad Set, disc brake								
xDrive M 50 i	390	07/19→	➡			13.0460-2640.2	602640	TRW + WE / - WK + Zub
FORD - TOURNEO CUSTOM V362 Bus (F3) 04/12→								
 Cable Pull, parking brake								
2.0 EcoBlue	77 - 125	12/15→		→ 04/16; for extended wheelbase; <input type="checkbox"/>		24.3727-0683.2	580683	L= 1,545
2.2 TDCi	74 - 114	04/12→12/15		05/12→; for extended wheelbase; <input type="checkbox"/>		24.3727-0683.2	580683	L= 1,545
FORD - TRANSIT CUSTOM V362 Bus (F3) 04/12→								
 Cable Pull, parking brake								
2.0 EcoBlue	77 - 125	12/15→		→ 04/16; for extended wheelbase; <input type="checkbox"/>		24.3727-0683.2	580683	L= 1,545
2.2 TDCi	74 - 114	04/12→12/15		for extended wheelbase; <input type="checkbox"/>		24.3727-0683.2	580683	L= 1,545
FORD - TRANSIT CUSTOM V362 Van (FY, FZ) 09/12→								
 Cable Pull, parking brake								
2.0 EcoBlue	77 - 125	12/15→		→ 04/16; for extended wheelbase; <input type="checkbox"/>		24.3727-0683.2	580683	L= 1,545
2.2 TDCi	74 - 114	09/12→04/16		for extended wheelbase; <input type="checkbox"/>		24.3727-0683.2	580683	L= 1,545
FORD - TRANSIT V363 Bus (FAD, FBD) 08/13→								
 Cable Pull, parking brake								
2.0 EcoBlue	77 - 125	03/16→		for vehicles with single rear axle; Flatbed / Double Cab; <input type="checkbox"/>		24.3727-0683.2	580683	L= 1,545
2.2 TDCi	114	12/14→12/18						
2.2 TDCi All-wheel Drive	114	08/15→12/18						
FORD - TRANSIT V363 Platform/Chassis (FED, FFD) 08/13→								
 Cable Pull, parking brake								
2.0 EcoBlue	77 - 125	03/16→		for vehicles with single rear axle; Flatbed / Double Cab; <input type="checkbox"/>		24.3727-0683.2	580683	L= 1,545
2.0 EcoBlue 4x4	96 - 125	01/17→						
2.0 EcoBlue RWD	77 - 125	03/16→						
2.2 TDCi	74 - 92	08/13→12/18		for vehicles with single rear axle; <input type="checkbox"/>		24.3727-0683.2	580683	L= 1,545
2.2 TDCi 4x4	92 - 114	08/13→12/18						
2.2 TDCi RWD	74 - 114	08/13→12/18						
2.2 TDCi	114	08/13→12/18		05/14→; for vehicles with single rear axle; Flatbed / Double Cab; <input type="checkbox"/>		24.3727-0683.2	580683	L= 1,545
FORD - TRANSIT V363 Van (FCD, FDD) 08/13→								
 Cable Pull, parking brake								
2.0 EcoBlue	77 - 125	03/16→		for vehicles with single rear axle; Flatbed / Double Cab; <input type="checkbox"/>		24.3727-0683.2	580683	L= 1,545
2.0 EcoBlue 4x4	96 - 125	01/17→						
2.0 EcoBlue RWD	77 - 125	03/16→						
2.2 TDCi 4x4	114	08/15→12/18						
LAND ROVER - DISCOVERY SPORT (L550) 09/14→								
Warning Contact, brake pad wear								
1.5 P300e Hybrid 4x4	147 - 227	02/20→	➡	JH000001→		24.8190-0821.2	620821	
2.0 4x4	177 - 213	11/14→						
2.0 D	110	08/15→						
2.0 D150 MHEV 4x4	110	05/19→						
2.0 D165	120	07/20→						







	kW			 	! #								
LAND ROVER - DISCOVERY SPORT (L550) 09/14→													
Warning Contact, brake pad wear													
2.0 D165 MHEV 4x4	120	07/20→	➔	JH000001→		24.8190-0821.2	620821						
2.0 D180 MHEV 4x4	132	05/19→											
2.0 D200 MHEV 4x4	150	07/20→											
2.0 D240 MHEV 4x4	177	05/19→											
2.0 D 4x4	110 -	12/14→											
	177												
2.0 P200 4x4	147	07/20→											
2.0 P200 FLEX MHEV 4x4	147	09/20→											
2.0 P200 MHEV 4x4	147	05/19→											
2.0 P250 4x4	183	05/19→											
2.0 P250 MHEV 4x4	184	05/19→											
2.0 P290 MHEV 4x4	213	07/20→											
2.0 Si4 FLEX 4x4	177	12/18→											
2.2 D 4x4	110 -	09/14→											
	140												
LAND ROVER - DISCOVERY SPORT VAN (L550) 09/14→													
Warning Contact, brake pad wear													
eD4 E-Capability	110	08/15→						➔	JH000001→		24.8190-0821.2	620821	
SD4 4x4	177	06/15→											
Si4 4x4	177 -	01/17→											
	213												
TD4 4x4	110 -	12/14→											
	132												
LAND ROVER - RANGE ROVER EVOQUE (L551) 12/18→													
Warning Contact, brake pad wear													
1.5 P160 MHEV	118	09/20→	➔			24.8190-0821.2	620821						
1.5 P300e Hybrid 4x4	147 -	02/20→											
	227												
2.0 D150	110	12/18→											
2.0 D150 4x4	110	12/18→											
2.0 D150 MHEV 4x4	110	12/18→											
2.0 D165	120	07/20→											
2.0 D165 4x4	120	07/20→											
2.0 D165 MHEV 4x4	120	07/20→											
2.0 D180 4x4	132	12/18→											
2.0 D180 MHEV 4x4	132	12/18→											
2.0 D200 4x4	150	07/20→											
2.0 D200 MHEV 4x4	150	07/20→											
2.0 D240 MHEV 4x4	177	12/18→											
2.0 P200 4x4	147	12/18→											
2.0 P200 FLEX MHEV 4x4	147	09/20→											
2.0 P200 MHEV 4x4	147	12/18→											
2.0 P250 4x4	184	12/18→											
2.0 P250 MHEV 4x4	183	12/18→											
2.0 P300 4x4	221	07/20→											
2.0 P300 MHEV 4x4	221	12/18→											
LEXUS - ES (_Z10_, _A10_, _H10_) 07/18→													
 Brake Pad Set, disc brake													
200	110 -	10/18→						➔			13.0470-5693.2	LD5693	AKE - WE / - WK Ceramic
	123												
250	147 -	10/18→											
	152												
300h	131 -	07/18→											
	160												
350	183	10/18→											
LEXUS - GX (URJ15_, GRJ15_) 11/09→													
 Brake Hose													
460 4WD	218 -	01/10→	←		2	24.5201-0258.3	331544	L= 262					
	225												
LEXUS - NX (_Z1_) 07/14→													
 Brake Pad Set, disc brake													
200	110	11/14→	➔			13.0470-5693.2	LD5693	AKE - WE / - WK Ceramic					
200 AWD	110	11/14→											
200t	175	07/14→											
200t AWD	175	07/14→											
300	175	09/17→											
300 AWD	175	09/17→											
300h	112 -	07/14→											
	145												
300h AWD	112 -	07/14→											
	147												



















	kw			 	! #		
LEXUS - UX (_AA1_, _AH1_, _MA1_) 10/18→							
 Brake Pad Set, disc brake							
200	110 - 126	10/18→	➔			13.0470-5693.2 LD5693	AKE - WE / - WK Ceramic
250h	107 - 112	10/18→					
250h E-Four	107 - 112	10/18→					
MERCEDES-BENZ - C-CLASS (W205) 07/13→							
Accessory Kit, disc brake pad							
C 160 C 180	95 110 - 115	04/15→ 03/14→	←	for vehicles with AMG Sports Package; for vehicles with sports brake system		13.0460-0522.2 610522	
C 180 BlueTEC / d C 200 4-matic C 200 BlueTEC / d C 200 d	85 135 100 100 - 118	05/14→05/18 04/15→08/18 05/14→05/18 10/15→					
C 200 EQ Boost C 220 BlueTEC / d	135 120 - 125	04/18→ 02/14→05/18					
C 220 d C 220 d 4-matic	143 125 - 143	05/18→ 04/15→					
C 250 BlueTEC / d 4-matic C 300	150 180 - 190	02/14→05/18 09/15→					
C 300 4-matic	180 - 190	12/13→					
C 300 d C 300 d 4-matic C 300 de C 300 e	180 180 225 155	06/18→ 06/18→ 05/19→ 07/19→					
C 160 C 250 C 300 BlueTEC Hybrid / h C 350 e	95 155 150 155 - 205	06/19→ 03/14→05/18 05/14→05/18 02/15→08/18	←			13.0460-0522.2 610522	
C 400 4-matic	245	10/14→					
C 180 d C 200 EQ Boost 4-matic C 300 e	90 135 235	05/18→ 04/18→ 07/19→	←	for vehicles with electronic suspension control		13.0460-0522.2 610522	
C 200	135	12/13→08/18	←	02/14→; for vehicles with AMG Sports Package; for vehicles with sports brake system		13.0460-0522.2 610522	
C 200 C 250 BlueTEC / d C 300 de C 300 e 4-matic C 300 EQ Boost C 300 EQ Boost 4-matic	150 150 143 155 190 190	08/19→ 02/14→05/18 05/19→ 07/19→ 05/19→ 05/19→	←	for vehicles without AMG sports package; for vehicles without sports brake system		13.0460-0522.2 610522	
C 200 4-matic	150	08/19→	←	for vehicles with electronic suspension control		13.0460-0522.2 610522	
			←	for vehicles with AMG Sports Package; for vehicles with sports brake system		13.0460-0522.2 610522	
			←	for vehicles without AMG sports package; for vehicles without sports brake system		13.0460-0522.2 610522	
C 300 e 4-matic	235	07/19→	←			13.0460-0522.2 610522	
			←	for vehicles without AMG sports package; for vehicles without sports brake system		13.0460-0522.2 610522	
MERCEDES-BENZ - C-CLASS Convertible (A205) 06/16→							
Accessory Kit, disc brake pad							
C 180 C 200 C 200 4-matic C 200 EQ Boost 4-matic C 220 d	115 135 135 135 120 - 143	06/16→ 06/16→05/18 06/16→05/18 05/18→ 06/16→	←	for vehicles with AMG Sports Package; for vehicles with sports brake system		13.0460-0522.2 610522	
C 220 d 4-matic	125 - 143	06/16→					
C 250 C 250 d C 300	155 150 180 - 190	06/16→05/18 06/16→05/18 06/16→					
C 300 d C 300 EQ Boost 4-matic	180 190	07/18→ 05/19→					















	kw			 	! #		
MERCEDES-BENZ - C-CLASS Convertible (A205) 06/16→							
Accessory Kit, disc brake pad							
C 200 C 200 d C 200 EQ Boost	150 118 135	08/19→ 07/18→ 05/18→	←	for vehicles with electronic suspension control		13.0460-0522.2	610522
C 300 EQ Boost	190	05/19→	←	for vehicles without AMG sports package; for vehicles without sports brake system		13.0460-0522.2	610522
C 400 4-matic	245	06/16→	←			13.0460-0522.2	610522
MERCEDES-BENZ - C-CLASS Coupe (C205) 10/15→							
Accessory Kit, disc brake pad							
C 180 C 200 EQ Boost	110 135	11/18→ 05/18→	←	for vehicles with electronic suspension control		13.0460-0522.2	610522
C 180 C 200 C 200 4-matic C 200 EQ Boost 4-matic C 220 d C 220 d 4-matic C 250 d C 250 d 4-matic C 300 C 300 4-matic C 300 d	115 135 135 135 120 - 143 125 - 143 150 150 180 - 190 190 180	10/15→ 10/15→05/18 04/16→05/18 05/18→ 10/15→ 04/16→ 10/15→05/18 04/16→05/18 10/15→ 05/18→ 07/18→	←	for vehicles with AMG Sports Package; for vehicles with sports brake system		13.0460-0522.2	610522
C 200 d C 300 d 4-matic C 400 4-matic	118 180 245	07/18→ 07/18→ 04/16→	←			13.0460-0522.2	610522
C 300 EQ Boost C 300 EQ Boost 4-matic	190 190	05/19→ 05/19→	←	for vehicles without AMG sports package; for vehicles without sports brake system		13.0460-0522.2	610522
MERCEDES-BENZ - C-CLASS T-Model (S205) 09/14→							
Accessory Kit, disc brake pad							
C 160 C 180 C 180 BlueTEC / d C 180 d C 200 C 200 4-matic C 200 BlueTEC / d C 200 d C 200 EQ Boost C 200 EQ Boost 4-matic C 220 BlueTEC / d C 220 d C 220 d 4-matic C 250 BlueTEC / d 4-matic C 300 C 300 d C 300 d 4-matic C 300 e	95 115 85 90 135 135 100 100 - 118 135 135 120 - 125 143 125 150 180 - 190 180 180 155	04/15→ 09/14→ 09/14→05/18 05/18→ 09/14→05/18 04/15→05/18 09/14→05/18 10/15→ 04/18→ 04/18→ 09/14→05/18 04/18→ 04/15→05/18 10/14→05/18 09/15→ 06/18→ 06/18→ 07/19→	←	for vehicles with AMG Sports Package; for vehicles with sports brake system		13.0460-0522.2	610522
C 180 C 300 de C 300 EQ Boost C 300 EQ Boost 4-matic	115 143 190 190	06/19→ 05/19→ 05/19→ 05/19→	←	for vehicles without AMG sports package; for vehicles without sports brake system		13.0460-0522.2	610522
C 200 d C 220 d 4-matic	110 143	05/18→ 05/18→	←	for vehicles with electronic suspension control		13.0460-0522.2	610522
C 250 C 250 BlueTEC / d C 300 4-matic C 300 BlueTEC Hybrid / h C 300 de C 300 e C 350 e C 400 4-matic	155 150 190 150 225 235 155 - 205 245	09/14→05/18 09/14→05/18 05/18→ 10/14→05/18 05/19→ 07/19→ 02/15→05/18 205 10/14→	←			13.0460-0522.2	610522
MERCEDES-BENZ - CLS (C257) 12/17→							
Accessory Kit, disc brake pad							
CLS 220 d CLS 350 EQ Boost 4-matic	143 220	06/18→ 08/18→	←	for vehicles with AMG Sports Package; for vehicles with sports brake system		13.0460-0522.2	610522

















	kw			 	! #		
MERCEDES-BENZ - CLS (C257) 12/17→							
Accessory Kit, disc brake pad							
CLS 300 d	180	04/18→	←	for vehicles without AMG sports package; for vehicles without sports brake system		13.0460-0522.2	610522
CLS 300 d 4-matic	195	04/21→	←			13.0460-0522.2	610522
			←	for vehicles without AMG sports package; for vehicles without sports brake system		13.0460-0522.2	610522
CLS 350 EQ Boost	220	08/18→	←	for vehicles with electronic suspension control		13.0460-0522.2	610522
MERCEDES-BENZ - E-CLASS (W213) 01/16→							
Accessory Kit, disc brake pad							
E 180	115	01/17→	←	for vehicles with AMG Sports Package; for vehicles with sports brake system		13.0460-0522.2	610522
E 200	135	01/16→					
E 200 4-matic	135	07/16→					
E 200 d	110 - 118	07/16→					
		07/16→					
E 220 d	120 - 143	01/16→					
		01/16→					
E 220 d 4-matic	120 - 143	10/16→					
		10/16→					
E 250	155	07/16→					
E 300	190	04/19→					
E 300 d	180	12/17→					
E 300 e	155 - 235	11/18→					
E 200 E 200 EQ Boost E 200 EQ Boost 4-matic E 300 E 300 4-matic E 300 e 4-matic E 300 EQ Boost E 350 d E 350 e	145	10/18→	←	for vehicles without AMG sports package; for vehicles without sports brake system		13.0460-0522.2	610522
	145	06/19→					
	145	06/19→					
	180 - 190	07/16→					
	180	09/16→					
	155 - 235	07/20→					
	190	06/19→					
	190	01/16→05/18					
	155 - 210	07/16→					
	210	07/16→					
E 300 d 4-matic E 300 de 4-matic	195	01/21→	←	for vehicles with AMG Sports Package; for vehicles with sports brake system		13.0460-0522.2	610522
	143	06/20→					
E 300 de E 350 EQ Boost	143 - 225	10/18→	←	for vehicles with electronic suspension control		13.0460-0522.2	610522
	220	08/18→					
E 300 de 4-matic	225	06/20→	←	for vehicles with electronic suspension control		13.0460-0522.2	610522
			←	for vehicles without AMG sports package; for vehicles without sports brake system		13.0460-0522.2	610522
E 350 d 4-matic	190	06/17→05/18	←	for vehicles with AMG Sports Package; +SA 158; for vehicles with sports brake system		13.0460-0522.2	610522
E 350 e	235	11/19→	←			13.0460-0522.2	610522
			←	for vehicles without AMG sports package; for vehicles without sports brake system		13.0460-0522.2	610522
MERCEDES-BENZ - E-CLASS All-Terrain (S213) 01/17→							
Accessory Kit, disc brake pad							
E 200 EQ Boost	145	08/20→	←	for vehicles without AMG sports package; for vehicles without sports brake system		13.0460-0522.2	610522
			←	for vehicles with AMG Sports Package; for vehicles with sports brake system		13.0460-0522.2	610522
E 220 d 4-matic	143	01/17→	←	for vehicles with AMG Sports Package; for vehicles with sports brake system		13.0460-0522.2	610522
MERCEDES-BENZ - E-CLASS Convertible (A238) 06/17→							
Accessory Kit, disc brake pad							
E 200	135	06/17→	←	for vehicles with AMG Sports Package; for vehicles with sports brake system		13.0460-0522.2	610522
E 200 4-matic	135	10/17→					
E 200 EQ Boost	145	06/19→					
E 200 EQ Boost 4-matic	145	06/19→					
E 220 d	120 - 143	06/17→					
		06/17→					
E 220 d 4-matic	143	10/17→					

























	kW			 	! #		
MERCEDES-BENZ - E-CLASS Convertible (A238) 06/17→							
Accessory Kit, disc brake pad							
E 300 E 300 d E 300 EQ Boost	190 180 190	03/19→ 05/18→ 06/19→	←	for vehicles with AMG Sports Package; for vehicles with sports brake system		13.0460-0522.2	610522
E 300 E 350 EQ Boost	180 220	06/17→ 10/17→	←	for vehicles without AMG sports package; for vehicles without sports brake system		13.0460-0522.2	610522
E 300 d 4-matic	195	04/21→	←			13.0460-0522.2	610522
			←	for vehicles with AMG Sports Package; for vehicles with sports brake system		13.0460-0522.2	610522
MERCEDES-BENZ - E-CLASS Coupe (C238) 12/16→							
Accessory Kit, disc brake pad							
E 200 E 200 4-matic E 200 EQ Boost E 200 EQ Boost 4-matic E 220 d E 220 d 4-matic E 300 E 300 d	135 135 145 145 120 - 143 143 190 180	12/16→ 06/17→ 06/19→ 06/19→ 12/16→ 03/17→ 08/18→ 05/18→	←	for vehicles with AMG Sports Package; for vehicles with sports brake system		13.0460-0522.2	610522
E 300 E 350 EQ Boost	180 220	12/16→ 10/17→	←	for vehicles without AMG sports package; for vehicles without sports brake system		13.0460-0522.2	610522
E 300 d 4-matic	195	01/21→	←	for vehicles with AMG Sports Package; for vehicles with sports brake system		13.0460-0522.2	610522
			←	for vehicles without AMG sports package; for vehicles without sports brake system		13.0460-0522.2	610522
E 300 EQ Boost	190	06/19→	←	for vehicles with electronic suspension control		13.0460-0522.2	610522
MERCEDES-BENZ - E-CLASS T-Model (S213) 07/16→							
Accessory Kit, disc brake pad							
E 200 E 200 4-matic E 200 d E 200 EQ Boost 4-matic E 220 d E 220 d 4-matic E 250 E 300 d	135 135 110 - 118 145 120 - 143 143 155 180	07/16→ 01/17→ 10/16→ 06/19→ 07/16→ 01/17→ 07/16→ 12/17→	←	for vehicles with AMG Sports Package; for vehicles with sports brake system		13.0460-0522.2	610522
E 200 EQ Boost E 350 d	145 190	06/19→ 10/16→	←	for vehicles without AMG sports package; for vehicles without sports brake system		13.0460-0522.2	610522
E 220 d E 300 d 4-matic E 300 e	143 195 155 - 235	09/20→ 01/21→ 06/20→	←	for vehicles with AMG Sports Package; for vehicles with sports brake system		13.0460-0522.2	610522
			←	for vehicles without AMG sports package; for vehicles without sports brake system		13.0460-0522.2	610522
E 300 EQ Boost	190	06/19→	←	for vehicles with electronic suspension control		13.0460-0522.2	610522
MERCEDES-BENZ - GLC (X253) 06/15→							
Accessory Kit, disc brake pad							
200 d 200 d 4-matic 200 EQ Boost 220 d 220 d 4-matic 250 4-matic 250 d 4-matic 300 300 4-matic 300 EQ Boost 4-matic 350 d 4-matic	120 120 145 143 120 - 125 155 150 180 180 190 190	04/19→ 04/19→ 04/19→ 04/19→ 06/15→04/19 06/15→04/19 06/15→04/19 01/16→04/19 07/15→04/19 04/19→ 10/16→04/19	←	for vehicles without AMG sports package; for vehicles without sports brake system		13.0460-0522.2	610522
200 EQ Boost 4-matic 220 d 4-matic 250 CNG 4-matic 250 Flexfuel 4-matic 300 d 4-matic	145 143 155 155 180	04/19→ 04/19→ 06/15→04/19 06/15→04/19 04/19→	←	for vehicles with AMG Sports Package; for vehicles with sports brake system		13.0460-0522.2	610522























	kW			 	! #		
MERCEDES-BENZ - GLC Coupe (C253) 06/16→							
Accessory Kit, disc brake pad							
200 d	120	04/19→	←	for vehicles with AMG Sports Package; for vehicles with sports brake system		13.0460-0522.2	610522
200 d 4-matic	120	04/19→					
220 d 4-matic	143	04/19→					
260 4-matic	145	11/19→					
300 4-matic	190	11/19→					
300 d 4-matic	180	04/19→					
200 EQ Boost	145	04/19→	←	for vehicles without AMG sports package;		13.0460-0522.2	610522
220 d 4-matic	120 - 125	06/16→04/19		for vehicles without sports brake system			
250 4-matic	155	06/16→04/19					
250 d 4-matic	150	06/16→04/19					
300 4-matic	180	10/16→04/19					
300 EQ Boost 4-matic	190	04/19→					
350 d 4-matic	190	10/16→04/19					
200 EQ Boost 4-matic	145	04/19→	←	for vehicles with electronic suspension control		13.0460-0522.2	610522
MITSUBISHI - PAJERO II (V3_W, V2_W, V4_W) 12/90→05/01							
Cable Pull, parking brake							
2.5 TD 4WD	73	12/90→10/99		→ 05/94; Disc Brake; <input type="checkbox"/>		24.3727-2124.2	582124 L= 1,483
3.0 V6 24V	130	06/97→10/99		Disc Brake; <input type="checkbox"/>		24.3727-2124.2	582124 L= 1,483
MITSUBISHI - PAJERO II Canvas Top (V2_W, V4_W) 12/90→04/00							
Cable Pull, parking brake							
2.4	82	04/91→04/00		→ 03/00; Disc Brake; <input type="checkbox"/>		24.3727-2124.2	582124 L= 1,483
SEAT - ATECA (KH7, KHP) 04/16→							
Brake Caliper							
1.0 TSI	81 - 85	05/16→	←	+PR 1ZE / 1ZJ; <input type="checkbox"/>		24.3571-1803.5	241427 without holder
1.4 TSI	110	06/16→	←	+PR 1ZE / 1ZJ; <input type="checkbox"/>		24.3571-1804.5	241428 without holder
1.4 TSI 4Drive	110	06/16→					
1.5 TSI	110	07/18→					
1.5 TSI 4Drive	110	07/18→					
1.6 TDI	85	04/16→07/18					
2.0 TDI	81 - 110	04/16→					
2.0 TDI 4Drive	110 - 140	04/16→					
2.0 TSI 4Drive	140	05/17→					
SEAT - LEON (5F1) 09/12→							
Brake Caliper							
1.0 TSi	63	09/18→	←	+PR 1ZE; <input type="checkbox"/>		24.3571-1803.5	241427 without holder
1.0 TSI	85	05/15→					
1.2 TSI	63 - 81	12/12→	←	+PR 1ZE; <input type="checkbox"/>		24.3571-1804.5	241428 without holder
1.4 TGI	81	02/13→					
1.4 TSI	90 - 110	09/12→					
1.5 TGI	96	10/18→					
1.5 TSI	96 - 110	09/18→					
1.6 TDI	66 - 85	11/12→					
1.8 TSI	132	02/13→					
2.0 Cupra	195 - 221	10/13→					
2.0 Cupra R	228	11/17→					
2.0 TDI	81 - 135	09/12→					
2.0 TSI	140	09/18→					
SEAT - LEON Hatchback Van (5F1) 09/12→							
Brake Caliper							
1.0 TSI	85	05/15→	←	+PR 1ZE; <input type="checkbox"/>		24.3571-1803.5	241427 without holder
1.2 TSI	63 - 81	01/13→	←	+PR 1ZE; <input type="checkbox"/>		24.3571-1804.5	241428 without holder
1.4 TSI	90 - 110	09/12→					
1.6 TDI	66 - 85	09/12→					
1.8 TFSI	132	02/13→					
2.0 Cupra	213 - 221	09/15→					
2.0 TDI	110 - 135	10/12→					

























	kW			 	! #			
SEAT - LEON SC (5F5) 01/13→								
 Brake Caliper								
1.0 TSI	85	05/15→08/18	←	+PR 1ZE; 		24.3571-1803.5	241427	without holder
1.2 TSI	63 - 81	01/13→08/18	←	+PR 1ZE; 		24.3571-1804.5	241428	without holder
1.4 TSI	90 - 110	02/13→08/18						
1.6 TDI	66 - 85	02/13→08/18						
1.8 TSI	132	02/13→08/18						
2.0 Cupra	195 - 221	10/13→08/18						
2.0 TDI	81 - 135	02/13→						
SEAT - LEON ST (5F8) 09/12→								
 Brake Caliper								
1.0 TSi	63	09/18→	←	+PR 1ZE; 		24.3571-1803.5	241427	without holder
1.0 TSI	85	05/15→						
1.2 TSI	63 - 81	08/13→	←	+PR 1ZE; 		24.3571-1804.5	241428	without holder
1.4 TGI	81	10/13→						
1.4 TSI	90 - 110	09/12→						
1.5 TGI	96	10/18→						
1.5 TSI	96 - 110	09/18→						
1.6 TDI	66 - 85	09/13→						
1.6 TDI 4Drive	77 - 85	04/14→						
1.8 TSI	132	10/13→						
1.8 TSI 4Drive	132	11/14→						
2.0 Cupra	195 - 221	10/13→						
2.0 Cupra 4Drive	221	11/16→						
2.0 TDI	81 - 135	02/13→						
2.0 TDI 4Drive	110 - 135	04/14→						
2.0 TSI	140	09/18→						
2.0 TSI 4Drive	140	09/18→						
SEAT - LEON ST Estate Van (5F8) 01/13→								
 Brake Caliper								
1.0 TSI	85	05/15→	←	+PR 1ZE; 		24.3571-1803.5	241427	without holder
1.2 TSI	63 - 81	01/13→	←	+PR 1ZE; 		24.3571-1804.5	241428	without holder
1.4 TSI	110	05/14→						
1.6 TDI	81 - 85	09/13→						
1.8 TFSI	132	10/13→						
2.0 Cupra	206 - 221	10/13→						
2.0 Cupra 4Drive	221	11/16→						
2.0 TDI	110 - 135	04/13→						
2.0 TDI 4Drive	110 - 135	09/14→						
SKODA - OCTAVIA III (5E3, NL3, NR3) 11/12→								
 Brake Caliper								
1.0 TSI	85	05/16→	←	+PR 1ZJ; 		24.3571-1803.5	241427	without holder
1.2 TSI	63 - 81	11/12→	←	+PR 1ZJ; 		24.3571-1804.5	241428	without holder
1.4 TSI	103 - 110	11/12→						
1.4 TSI G-TEC	81	11/13→						
1.5 TSI	110	02/17→						
1.6	81	01/14→						
1.6 TDI	66 - 85	11/12→						
1.6 TDI 4x4	77 - 85	09/14→						
1.8 TSI	132	11/12→						
1.8 TSI 4x4	132	09/14→						
2.0 TDI	105 - 110	11/12→						
2.0 TDI / TDI RS 4x4	135	05/13→						
2.0 TDI 4x4	110	09/14→						
2.0 TDI RS	135	05/13→						
2.0 TSI	140	02/17→						
2.0 TSI 4x4	140	02/19→						

	kw			 	! #		
SKODA - OCTAVIA III (5E3, NL3, NR3) 11/12→							
 Brake Caliper							
2.0 TSI RS	162 - 180	05/13→	←	+PR 1ZJ; <input type="checkbox"/>		24.3571-1803.5 241427	without holder
			←	+PR 1ZJ; <input type="checkbox"/>		24.3571-1804.5 241428	without holder
SKODA - OCTAVIA III Combi (5E5, 5E6) 11/12→							
 Brake Caliper							
1.0 TSI	85	05/16→	←	+PR 1ZJ; <input type="checkbox"/>		24.3571-1803.5 241427	without holder
1.2 TSI	63 - 81	11/12→	←	+PR 1ZJ; <input type="checkbox"/>		24.3571-1804.5 241428	without holder
1.4 TSI	103 - 110	11/12→					
1.4 TSI G-TEC	81	11/13→					
1.5 TSI	110	02/17→					
1.5 TSI G-TEC	96	01/19→					
1.6	81	01/14→					
1.6 TDI	66 - 85	11/12→					
1.6 TDI 4x4	77 - 85	11/12→					
1.8 TSI	132	11/12→					
1.8 TSI 4x4	132	11/12→					
2.0 TDI	105 - 110	11/12→					
2.0 TDI / TDI RS 4x4	135	09/14→					
2.0 TDI 4x4	110	11/12→					
2.0 TDI RS	135	05/13→					
2.0 TSI	140	02/17→					
2.0 TSI 4x4	140	02/19→					
2.0 TSI RS	162 - 180	11/12→					
SMART - FORTWO Cabrio (451) 01/07→							
 Brake Caliper							
0.8 CDi	33 - 40	01/07→	←	<input type="checkbox"/>		24.3421-1721.5 241435	without holder
1.0	52	01/07→	←	<input type="checkbox"/>		24.3421-1722.5 241436	without holder
1.0 Brabus	72 - 88	01/08→					
1.0 Turbo	62	01/07→					
1.0 Turbo Brabus electric drive	75 - 20	07/10→ 11/09→					
electric drive Brabus	55 - 60	01/13→					
SMART - FORTWO Coupe (450) 01/04→02/07							
 Brake Caliper							
0.7	40	01/04→01/07	←	<input type="checkbox"/>		24.3421-1721.5 241435	without holder
			←	<input type="checkbox"/>		24.3421-1722.5 241436	without holder
SMART - FORTWO Coupe (451) 01/07→							
 Brake Caliper							
0.8 CDi	33 - 40	01/07→	←	<input type="checkbox"/>		24.3421-1721.5 241435	without holder
1.0	45 - 52	01/07→	←	<input type="checkbox"/>		24.3421-1722.5 241436	without holder
1.0 Brabus	72	01/08→					
1.0 Turbo	62	01/07→					
1.0 Turbo Brabus electric drive	75 - 20	07/10→ 11/09→					
electric drive Brabus	55 - 60	01/13→					
TOYOTA - 4 RUNNER V (_N28_) 03/09→							
 Brake Hose							
4.0	202	01/10→	←		2	24.5201-0258.3 331544	L= 262
4.0 4WD	202	01/10→					
TOYOTA - CAMRY (_V7_, _VA7_, _VH7_) 06/17→							
 Brake Pad Set, disc brake							
2.0	110 - 123	10/17→	→			13.0470-5693.2 LD5693	AKE - WE / - WK Ceramic
2.5	131 - 152	08/17→					
2.5 Hybrid	129 - 131	08/17→					

	kW			 	! #		
TOYOTA - CAMRY (_V7_, _VA7_, _VH7_) 06/17→							
 Brake Pad Set, disc brake							
3.5	183 - 219	08/17→	→			13.0470-5693.2 LD5693	AKE - WE / - WK Ceramic
TOYOTA - C-HR (_X1_) 10/16→							
 Brake Pad Set, disc brake							
1.2	85	10/16→	→			13.0470-5693.2 LD5693	AKE - WE / - WK Ceramic
1.8 Hybrid	72 - 90	10/16→					
2.0	109	11/16→					
1.2 4WD	85 - 96	10/16→	→	→ 04/18		13.0470-5693.2 LD5693	AKE - WE / - WK Ceramic
TOYOTA - C-HR VAN (_X1_) 10/16→							
 Brake Pad Set, disc brake							
1.8 Hybrid	72	10/16→	→			13.0470-5693.2 LD5693	AKE - WE / - WK Ceramic
TOYOTA - FJ CRUISER (GSJ1_) 06/05→01/18							
 Brake Hose							
4.0	176	06/05→10/09	←	08/09→	2	24.5201-0258.3 331544	L= 262
4.0 4WD	176	06/05→12/09					
4.0	178 - 191	01/06→06/14	←		2	24.5201-0258.3 331544	L= 262
4.0 4WD	178 - 203	06/05→01/18					
4.0 4WD	191	01/10→06/14	←	12/10→	2	24.5201-0258.3 331544	L= 262
TOYOTA - LAND CRUISER 200 (_J2_) 08/07→							
 Brake Hose							
4.0	176	01/10→	←		2	24.5201-0258.3 331544	L= 262
TOYOTA - LAND CRUISER PRADO (_J15_) 07/09→							
 Brake Hose							
2.7	120	08/09→	←	01/10→	2	24.5201-0258.3 331544	L= 262
3.0 D	70	07/09→					
3.0 D-4D	140	08/09→					
3.0 TDi	120	08/09→					
4.0 V6 Dual VVTi	205	08/09→					
4.0 V6 VVT-i	207	08/09→					
4.0 V6 VVTi	202	08/09→					
2.8 D-4D	130	06/15→	←		2	24.5201-0258.3 331544	L= 262
3.5	206	09/15→					
4.0 V6 VVTi	183 - 203	01/10→					
3.0 D-4D	127	08/09→	←	03/10→	2	24.5201-0258.3 331544	L= 262
TOYOTA - LAND CRUISER VAN (_J15_) 01/11→							
 Brake Hose							
3.0 D4d 4WD	140	01/11→	←		2	24.5201-0258.3 331544	L= 262
TOYOTA - RAV 4 V (_A5_, _H5_) 12/18→							
 Brake Pad Set, disc brake							
2.0	129	12/18→	→	+ RUS		13.0470-5693.2 LD5693	AKE - WE / - WK Ceramic
2.0 AWD	129	12/18→					
2.5 Hybrid	131	12/18→					
2.5 Hybrid AWD	131 - 163	12/18→					
2.5 VVTi	149	12/18→					
2.5 VVTi AWD	149 - 152	12/18→					
2.0 VVTi	110 - 127	12/18→	→			13.0470-5693.2 LD5693	AKE - WE / - WK Ceramic
2.0 VVTi AWD	110 - 127	12/18→					
TOYOTA - RAV 4 V VAN (_A5_, _H5_) 12/18→							
 Brake Pad Set, disc brake							
2.0 VVTi	129	12/18→	→	+ RUS		13.0470-5693.2 LD5693	AKE - WE / - WK Ceramic
2.0 VVTi AWD	129	12/18→					
2.5 Hybrid	131	12/18→					
2.5 Hybrid AWD	131	12/18→					

	kw			 	! #			
VW - CADDY IV Box Body/MPV (SAA, SAH) 05/15→								
 Brake Caliper								
1.0 TSI	75	11/15→09/20	←	+PR 1ZE; 		24.3571-1803.5	241427	without holder
1.2 TSI	62	06/15→09/20	←	+PR 1ZE; 		24.3571-1804.5	241428	without holder
1.4 TGI CNG	81	06/15→09/20						
1.4 TSI	92 - 96	05/15→09/20						
1.6	81	11/15→09/20						
1.6 TDI	55 - 75	05/15→09/20						
2.0 TDI	55 - 110	05/15→09/20						
2.0 TDI 4motion	55 - 110	05/15→09/20						
ABT e-Caddy	83	04/20→						
VW - CADDY IV MPV (SAB, SAJ) 05/15→								
 Brake Caliper								
1.0 TSI	62 - 75	11/15→09/20	←	+PR 1ZE; 		24.3571-1803.5	241427	without holder
1.2 TSI	62	06/15→09/20	←	+PR 1ZE; 		24.3571-1804.5	241428	without holder
1.4 TGI CNG	81	06/15→09/20						
1.4 TSI	92 - 96	05/15→09/20						
1.6	81	11/15→09/20						
1.6 TDI	55 - 75	05/15→09/20						
2.0 TDI	55 - 110	05/15→09/20						
2.0 TDI 4motion	81 - 110	05/15→09/20						
ABT e-Caddy	83	04/20→						
VW - CADDY ALLTRACK Box Body/MPV (SAA) 05/15→								
 Brake Caliper								
1.0 TSI	75	11/15→	←	+PR 1ZE; 		24.3571-1803.5	241427	without holder
1.2 TSI	62	06/15→	←	+PR 1ZE; 		24.3571-1804.5	241428	without holder
1.4 TGI CNG	81	06/15→						
1.4 TSI	92 - 96	05/15→						
1.6 SRE	81	11/15→09/20						
1.6 TDI	55 - 75	05/15→						
2.0 TDI	55 - 110	05/15→						
2.0 TDI 4motion	81 - 110	05/15→						
VW - CADDY ALLTRACK MPV (SAB) 05/15→								
 Brake Caliper								
1.0 TSI	62 - 75	11/15→	←	+PR 1ZE; 		24.3571-1803.5	241427	without holder
1.2 TSI	62	06/15→	←	+PR 1ZE; 		24.3571-1804.5	241428	without holder
1.4 TGI CNG	81	06/15→						
1.4 TSI	92 - 96	05/15→						
1.6 TDI	55 - 75	05/15→						
2.0 TDI	55 - 110	05/15→						
2.0 TDI 4motion	81 - 110	05/15→						
VW - GOLF VI (5K1) 10/08→12/14								
 Brake Caliper								
Blue E-Motion	65	12/10→11/13	←	+PR 1ZE / 1ZP; 		24.3571-1803.5	241427	without holder
			←	+PR 1ZE / 1ZP; 		24.3571-1804.5	241428	without holder
VW - GOLF VII (5G1, BQ1, BE1, BE2) 08/12→								
 Brake Caliper								
1.0 TSI	63 - 85	05/15→	←	+PR 1ZE / 1ZP; 		24.3571-1803.5	241427	without holder
1.2 TSI	63 - 81	08/12→	←	+PR 1ZE / 1ZP; 		24.3571-1804.5	241428	without holder
1.4 GTE Hybrid	110	05/14→						
1.4 TGI CNG	81	06/13→						
1.4 TSI	90 - 110	08/12→						

	kW			 	! #		
VW - GOLF VII (5G1, BQ1, BE1, BE2) 08/12→							
 Brake Caliper							
1.4 TSI MultiFuel	90 - 92	04/13→	←	+PR 1ZE / 1ZP; 		24.3571-1803.5 241427	without holder
1.5 TGI 1.5 TSI	96 - 110	11/18→ 04/17→	←	+PR 1ZE / 1ZP; 		24.3571-1804.5 241428	without holder
1.6 1.6 TDI	81 - 66	05/14→07/17 08/12→					
1.6 TDI 4motion	85 - 77	11/12→					
2.0 GTD 2.0 GTI	135 - 155	04/13→ 04/13→					
2.0 GTI Clubsport 2.0 GTI Clubsport S 2.0 GTI TCR	180 - 195 - 228 - 213	02/16→03/17 09/16→ 11/18→					
2.0 R 360S 4motion 2.0 R 4motion	265 - 206	09/16→ 11/13→					
2.0 TDI 2.0 TDI 4motion e-Golf	228 - 81 - 110 - 110 - 85 - 100	08/12→ 11/12→08/20 03/14→					
VW - GOLF VII Van (5G1) 08/12→							
 Brake Caliper							
1.2 TSi BlueMotion	63 - 77	08/12→	←	+PR 1ZE / 1ZP; 		24.3571-1803.5 241427	without holder
1.4 TSi BlueMotion	90 - 103	08/12→	←	+PR 1ZE / 1ZP; 		24.3571-1804.5 241428	without holder
1.6 TDi BlueMotion	66 - 81	08/12→					
2.0 GTD 2.0 GTI	135 - 162	04/13→ 04/13→					
2.0 TDi BlueMotion 2.0 TDi BlueMotion 4motion	169 - 110 - 110	05/13→ 05/13→					
VW - GOLF VII Variant (BA5, BV5) 04/13→							
 Brake Caliper							
1.0 TSI	63 - 85	05/15→	←	+PR 1ZE / 1ZP; 		24.3571-1803.5 241427	without holder
1.2 TSI	63 - 81	05/13→	←	+PR 1ZE / 1ZP; 		24.3571-1804.5 241428	without holder
1.4 TGI CNG 1.4 TSI	81 - 90	09/13→ 05/13→					
1.4 TSI MultiFuel	110 - 90	04/13→03/17					
1.5 TGI 1.5 TSI	92 - 96 - 96	12/18→ 04/17→					
1.6 1.6 TDI	110 - 81 - 66	05/14→03/17 05/13→					
1.6 TDI 4motion	85 - 77	05/13→03/17					
1.8 TSI 4motion 2.0 GTD 2.0 R 360S 4motion 2.0 R 4motion	81 - 132 - 135 - 265 - 206	11/16→ 01/15→03/17 09/16→ 03/15→					
2.0 TDI 2.0 TDI 4motion	228 - 81 - 110 - 110	04/13→ 04/13→05/18					
VW - GOLF VIII (CD1) 07/19→							
 Brake Caliper							
1.0 eTSI 1.5 eTSI	81 - 110	06/20→ 12/19→	←	+PR 1ZE / 1ZJ / 1ZP / 1ZQ; 		24.3571-1803.5 241427	without holder
			←	+PR 1ZE / 1ZJ / 1ZP / 1ZQ; 		24.3571-1804.5 241428	without holder
VW - GOLF VIII Variant (CG5) 08/20→							
 Brake Caliper							
1.0 eTSI 1.5 eTSI	81 - 96 - 110	09/20→ 12/20→	←	+PR 1ZE / 1ZJ / 1ZP / 1ZQ; 		24.3571-1803.5 241427	without holder
			←	+PR 1ZE / 1ZJ / 1ZP / 1ZQ; 		24.3571-1804.5 241428	without holder

	kw			 	! #		
VW - GOLF ALLTRACK VII Variant (BA5, BV5) 12/14→							
 Brake Caliper							
1.6 TDI 4motion	81	12/14→	←	+PR 1ZE / 1ZP; 		24.3571-1803.5 241427	without holder
1.8 TSI 4motion	132	12/14→	←	+PR 1ZE / 1ZP; 		24.3571-1804.5 241428	without holder
2.0 TDI 4motion	110 - 135	12/14→					
VW - GOLF SPORTSVAN VII (AM1, AN1) 02/14→							
 Brake Caliper							
1.0 TSI	63 - 85	05/15→	←	+PR 1ZE / 1ZP; 		24.3571-1803.5 241427	without holder
1.2 TSI	63 - 81	04/14→	←	+PR 1ZE / 1ZP; 		24.3571-1804.5 241428	without holder
1.4 TSI	92 - 110	02/14→					
1.4 TSI MultiFuel	92	04/14→					
1.5 TSI	96 - 110	05/17→					
1.6	81	05/14→					
1.6 TDI	66 - 81	02/14→					
2.0 TDI	81 - 110	02/14→					
1.6 TDI	85	11/16→	←	+PR 1ZE; 		24.3571-1803.5 241427	without holder
			←	+PR 1ZE; 		24.3571-1804.5 241428	without holder
VW - GOLF VAN VII Variant (BA5) 04/13→03/17							
 Brake Caliper							
1.2 TSi BlueMotion	63 - 77	04/13→03/17	←	+PR 1ZE / 1ZP; 		24.3571-1803.5 241427	without holder
1.4 TSi BlueMotion	90 - 103	05/13→03/17	←	+PR 1ZE / 1ZP; 		24.3571-1804.5 241428	without holder
1.6 TDi BlueMotion	66 - 81	05/13→03/17					
1.6 TDi BlueMotion 4motion	77	05/13→03/17					
2.0 TDi BlueMotion 4motion	110	04/13→03/17					
2.0 TDi BlueMotion 4motion	110	04/13→03/17					
VW - T-ROC (A11) 07/17→							
 Brake Caliper							
1.0 TSI	81 - 85	07/17→	←	+PR 1ZE / 1ZJ / 1ZQ; 		24.3571-1803.5 241427	without holder
1.5 TSI	110	11/17→	←	+PR 1ZE / 1ZJ / 1ZQ; 		24.3571-1804.5 241428	without holder
1.5 TSI 4motion	110	05/18→					
1.6 TDI	85	03/18→					
2.0 R 4motion	221	09/19→					
2.0 TDI	110	03/18→					
2.0 TDI 4motion	110 - 140	09/17→					
2.0 TDI SCR	85	11/20→					
2.0 TSI 4motion	140	07/17→					
VW - T-ROC Convertible (AC7) 12/19→							
 Brake Caliper							
1.0 TSI	81 - 85	12/19→	←	+PR 1ZJ; 		24.3571-1803.5 241427	without holder
1.5 TSI	110	12/19→	←	+PR 1ZJ; 		24.3571-1804.5 241428	without holder







- EN** Technical translations
- DE** Technische Übersetzungen
- ES** Traducciones técnicas
- FR** Traductions techniques
- IT** Traduzioni tecniche

01/2022







Technical translations

Technische Übersetzungen - Traducciones tecnicas - Traductions techniques - Traduzioni tecniche

EN		EN	
	Brake Hose	for vehicles with electronic suspension control	for vehicles with electronic suspension control
	Cable Pull, parking brake		
	Brake Caliper	for vehicles with M-performance brakes	for vehicles with M-performance brakes
	Brake Pad Set, disc brake		
<input type="checkbox"/>	Left Rear	for vehicles with M-sport brakes	for vehicles with M-sport brakes
<input type="checkbox"/>	Right Rear	for vehicles without AMG sports package	for vehicles without AMG sports package
<input type="checkbox"/>	Front Axle Left		
<input type="checkbox"/>	Front Axle Right	for vehicles without M-sport brakes	for vehicles without M-sport brakes
+PR	for PR number	for vehicles without sports brake system	for vehicles without sports brake system
+ RUS	Russia		
+SA	for SA code		
+ WE	prepared for wear indicator	for vehicles with single rear axle	for vehicles with single rear axle
+ Zub	with accessories		
AKE	Brake System, Akebono	for vehicles with sports brake system	for vehicles with sports brake system
ATE Ceramic	additional article information, ATE Ceramic		
CB compatible package	CB compatible package	for vehicles with sports package	for vehicles with sports package
Codes of set object definitions	Codes of set object definitions	Height [mm]	Height [mm]
		Height 1 [mm]	Height 1 [mm]
		Height 2 [mm]	Height 2 [mm]
Country specific package and status data	Country specific package and status data	L=	Length [mm]
		Observe dimensions	Observe dimensions
Disc Brake	Disc Brake	Piston Diameter [mm]	Piston Diameter [mm]
Flatbed / Double Cab	Flatbed / Double Cab	replacement part	replacement part
for extended wheelbase	for extended wheelbase	Service exchange part	Service exchange part
for vehicles with AMG Sports Package	for vehicles with AMG Sports Package		

Technical translations

Technische Übersetzungen - Traducciones tecnicas - Traductions techniques - Traduzioni tecniche

EN		DE	
Spanner size 1 [mm]	Spanner size 1 [mm]		Bremsschlauch
Thickness [mm]	Thickness [mm]		Seilzug, Feststellbremse
TRW	Brake System, Lucas / TRW		Bremssattel
usage number	usage number		Bremsbelagsatz, Scheibenbremse
- WE	not prepared for wear indicator		
Width [mm]	Width [mm]	<input type="checkbox"/>	hinten links
with brake caliper screws	with brake caliper screws	<input type="checkbox"/>	hinten rechts
- WK	excl. wear warning contact without integrated wear warning contact	<input type="checkbox"/>	Vorderachse links
Yes	Yes	<input type="checkbox"/>	Vorderachse rechts
→	Construction year from Vehicle Identification Number from		
→	Construction year to	+PR	für PR-Nummer
		+ RUS	Russland
		+SA	für SA Code
		+ WE	für Verschleißwarnanzeiger vorbereitet
		+ Zub	mit Zubehör
		AKE	Bremssystem, Akebono
		ATE Ceramic	Artikelzusatzbezeichnung, ATE Ceramic
		CB compatible package	SB gerechte Verpackung
		Codes of set object definitions	Codes der gesetzten Objektdefinitionen
		Country specific package and status data	Länderspezifische Verpackungs- und Status-Informationen
		Disc Brake	Scheibenbremse
		Flatbed / Double Cab	Pritsche/Doppelk.
		for extended wheelbase	für verlängerten Radstand
		for vehicles with AMG Sports Package	für Fahrzeuge mit AMG-Sportpaket





Technical translations

Technische Übersetzungen - Traducciones tecnicas - Traductions techniques - Traduzioni tecniche

DE		DE	
for vehicles with electronic suspension control	für Fahrzeuge mit elektr. Dämpferregulierung	Spanner size 1 [mm]	Schlüsselweite 1 [mm]
		Thickness [mm]	Dicke/Stärke [mm]
for vehicles with M-performance brakes	für Fahrzeuge mit M-Performance Bremse	TRW	Bremssystem, Lucas / TRW
		usage number	Gebrauchsnummer
for vehicles with M-sport brakes	für Fahrzeuge mit M-Sportbremse	- WE	nicht für Verschleißwarnanzeiger vorbereitet
		Width [mm]	Breite [mm]
for vehicles without AMG sports package	für Fahrzeuge ohne AMG-Sportpaket	with brake caliper screws	mit Bremssattelschrauben
		- WK	exkl. Verschleißwarnkontakt ohne integrierten Verschleißwarnkontakt
for vehicles without M-sport brakes	für Fahrzeuge ohne M-Sportbremse	Yes	Ja
		→	Baujahr ab Fahrgestellnummer ab
for vehicles without sports brake system	für Fahrzeuge ohne Sportbremsanlage	→	Baujahr bis
for vehicles with single rear axle	für Fahrzeuge mit Einfachbereifung hinten		
for vehicles with sports brake system	für Fahrzeuge mit Sportbremsanlage		
for vehicles with sports package	für Fahrzeuge mit Sportpaket		
Height [mm]	Höhe [mm]		
Height 1 [mm]	Höhe 1 [mm]		
Height 2 [mm]	Höhe 2 [mm]		
L=	Länge [mm]		
Observe dimensions	Abmessungen beachten		
Piston Diameter [mm]	Kolbendurchmesser [mm]		
replacement part	Austauschteil		
Service exchange part	Austauschteil		

Technical translations





Technische Übersetzungen - Traducciones técnicas - Traductions techniques - Traduzioni tecniche

ES		ES	
	Tubo flexible de frenos	for vehicles with electronic suspension control	para vehículos con regulación eléctrica de amortiguación
	Cable de accionamiento, freno de estacionamiento		
	Pinza de freno	for vehicles with M-performance brakes	para vehículos con freno de alto rendimiento M
	Juego de pastillas de freno		
<input type="checkbox"/>	Atrás izquierda	for vehicles with M-sport brakes	Para vehículos con frenos deportivos M
<input type="checkbox"/>	Atrás derecha	for vehicles without AMG sports package	para vehículos sin paquete deportivo AMG
<input type="checkbox"/>	Eje delantero, izquierda	for vehicles without M-sport brakes	Para vehículos sin frenos deportivos M
<input type="checkbox"/>	Eje delantero, derecha		
+PR	Número de PR	for vehicles without sports brake system	para vehículos sin sistema de frenos deportivos
+ RUS	Rusia		
+SA	para código SA		
+ WE	preparado para indicador desgaste	for vehicles with single rear axle	para vehículos con neumático simple trasero
+ Zub	con accesorios		
AKE	Sistema de frenos, Akebono	for vehicles with sports brake system	para vehículos con sistema de frenos deportivos
ATE Ceramic	Denominación adicional del artículo, ATE Ceramic		
CB compatible package	Embalaje apto para autoservicio	for vehicles with sports package	para vehículos con paquete sport
Codes of set object definitions	Codes der gesetzten Objektdefinitionen	Height [mm]	Altura [mm]
		Height 1 [mm]	Altura 1 [mm]
		Height 2 [mm]	Altura 2 [mm]
Country specific package and status data	Información específica del país sobre el embalaje y sobre el estado	L=	Longitud [mm]
		Observe dimensions	Observar dimensiones
Disc Brake	Discos	Piston Diameter [mm]	Diámetro del pistón [mm]
Flatbed / Double Cab	Plataforma/cabina doble		
for extended wheelbase	para distancia entre ejesprolongada	replacement part	Recambio
for vehicles with AMG Sports Package	para vehículos con paquete sport AMG	Service exchange part	Pieza de intercambio



Technical translations

Technische Übersetzungen - Traducciones técnicas - Traductions techniques - Traduzioni tecniche

ES		FR	
Spanner size 1 [mm]	Ancho de llave 1 [mm]		Flexible de frein
Thickness [mm]	Espesor [mm]		Tirette à câble, frein de stationnement
TRW	Sistema de frenos, Lucas / TRW		Étrier de frein
usage number	Número de uso		Kit de plaquettes de frein, frein à disque
- WE	no preparado para indicador de desgaste	<input type="checkbox"/>	arrière gauche
Width [mm]	Ancho [mm]	<input type="checkbox"/>	arrière droite
with brake caliper screws	con tornillos pinza freno	<input checked="" type="checkbox"/>	Essieu avant gauche
- WK	excl. contacto de avisador de desgaste sin contacto de aviso de desgaste	<input checked="" type="checkbox"/>	Essieu avant droit
Yes	sí	+PR	pour numéro PR
→	año construcción desde n° de chasis desde	+ RUS	Russie
→	año construcción hasta	+SA	pour SA code
		+ WE	préparé pour indicateur d'usure
		+ Zub	avec accessoires
		AKE	Système de freinage, Akebono
		ATE Ceramic	Designation d'article complémentaire, ATE Ceramic
		CB compatible package	Emballage LS
		Codes of set object definitions	Codes der gesetzten Objektdefinitionen
		Country specific package and status data	Informations d'emballage et d'état spécifiques aux pays
		Disc Brake	Frein à disque
		Flatbed / Double Cab	Camion plate-forme/cab.double
		for extended wheelbase	pour empattement rallongé
		for vehicles with AMG Sports Package	pour véhicules avec équipement-sport AMG

Technical translations





Technische Übersetzungen - Traducciones técnicas - Traductions techniques - Traduzioni tecniche

FR		FR	
for vehicles with electronic suspension control	pour véhicules avec réglage d'amortisseur électronique	Spanner size 1 [mm]	Largeur de clé 1 [mm]
		Thickness [mm]	Épaisseur [mm]
for vehicles with M-performance brakes	pour véhicules avec frein M performance	TRW	Système de freinage, Lucas / TRW
		usage number	Numéro d'utilisation
for vehicles with M-sport brakes	pour véhicules avec système de freinage sport M	- WE	non préparé pour indicateur d'usure
		Width [mm]	Largeur [mm]
for vehicles without AMG sports package	pour véhicules sans paquet-sport AMG	with brake caliper screws	avec vis d'étrier de frein
		- WK	contact de signal d'usure exclu sans contact du palpeur d'usure intégré
for vehicles without M-sport brakes	pour véhicules sans système de freinage sport M	Yes	Oui
		→	Année à partir de N° de châssis à partir de
for vehicles without sports brake system	pour véhicules sans système de freinage sport	→	Année jusqu'à
for vehicles with single rear axle	pour véhicules avec pneus simples à l'arrière		
for vehicles with sports brake system	pour véhicules avec système de freinage sport		
for vehicles with sports package	pour véhicules avec équipement sport		
Height [mm]	Hauteur [mm]		
Height 1 [mm]	Hauteur 1 [mm]		
Height 2 [mm]	Hauteur 2 [mm]		
L=	Longueur [mm]		
Observe dimensions	Respecter les dimensions		
Piston Diameter [mm]	Diamètre du piston [mm]		
replacement part	Pièce de rechange		
Service exchange part	Echange standard		



Technical translations

Technische Übersetzungen - Traducciones tecnicas - Traductions techniques - Traduzioni tecniche

IT		IT	
	Flessibile del freno	for vehicles with electronic suspension control	per veicoli con regolazione elettr. ammortizzatori
	Cavo comando, Freno stazionamento		
	Pinza freno	for vehicles with M-performance brakes	per veicoli con freno M Performance
	Kit pastiglie freno, Freno a disco	for vehicles with M-sport brakes	per veicoli con freni sportivi M
<input type="checkbox"/>	posteriore Sx		
<input type="checkbox"/>	posteriore Dx	for vehicles without AMG sports package	per veicoli senza pacchetto sportivo AMG
<input type="checkbox"/>	Assale anteriore Sx	for vehicles without M-sport brakes	per veicoli senza freni sportivi M
<input type="checkbox"/>	Assale anteriore Dx		
+PR	per N° PR	for vehicles without sports brake system	per veicoli senza impianti frenante sportivo
+ RUS	Russia		
+SA	per codice SA		
+ WE	Predisposto per contatto segnalazione usura	for vehicles with single rear axle	per veicoli con pneumatico in singolo posteriore
+ Zub	con accessori	for vehicles with sports brake system	per veicoli con impianto frenante sportivo
AKE	Sistema frenante, Akebono		
ATE Ceramic	Denominazione aggiuntiva dell'articolo, ATE Ceramic	for vehicles with sports package	per veicoli con pacchetto sportivo
CB compatible package	Imballaggio self-service	Height [mm]	Altezza [mm]
Codes of set object definitions	Codes der gesetzten Objektdefinitionen	Height 1 [mm]	Altezza 1 [mm]
Country specific package and status data	Informazioni di imballaggio e di stato specifiche per i diversi Paesi	Height 2 [mm]	Altezza 2 [mm]
		L=	Lunghezza [mm]
Disc Brake	Freno a disco	Observe dimensions	Osservare le misure
Flatbed / Double Cab	Pianale piatto / Cabina doppia	Piston Diameter [mm]	Diametro pistone [mm]
for extended wheelbase	per passo allungato	replacement part	Ricambio di rotazione
for vehicles with AMG Sports Package	per veicoli con pacchetto sportivo AMG	Service exchange part	Ricambio di rotazione

Technical translations

Technische Übersetzungen - Traducciones tecnicas - Traductions techniques - Traduzioni tecniche

IT	
Spanner size 1 [mm]	Apertura chiave 1 [mm]
Thickness [mm]	Spessore [mm]
TRW	Sistema frenante, Lucas / TRW
usage number	Codice d'uso
- WE	Non predisposto per contatto segnalazione usura
Width [mm]	Larghezza [mm]
with brake caliper screws	con bulloni pinza freno
- WK	senza contatto segnalazione usura senza segnalatore usura integrato
Yes	Sì
→	Anno da N° telaio da
→	Anno fino a



ATE – A Trademark of the
Continental Corporation

**Continental Aftermarket & Services
GmbH**

Sodener Straße 9
D-65824 Schwalbach
Tel. +49 (0) 6196 87 0
Fax +49 (0) 6196 865 71

www.ate.de

**Continental Automotive Trading
Italia S.r.l.**

Via Matteotti, 62
I-20092 Cinisello Balsamo (MI)
Tel. +39 02 35680 1
Fax +39 02 35680 325
E-Mail: supporto@continental-corporation.com

www.ate-freni.it

Continental Automotive France SAS

1 rue de Clairefontaine
F-78120 Rambouillet
Tél. +33 (0)1 34 57 40 19
Fax +33 (0)1 34 57 40 72

www.ate-freinage.fr

Continental Automotive Spain, S.A.

C/ Sepúlveda, 11
E-28108 Alcobendas (Madrid) Phone
+34 (0) 657 21 21
Fax +34 (0)91 657 21 49

www.frenos-ate.es