



Nuevas referencias en almacén

Por aplicación

12/2017

www.ate.de





Denominación

Ref. OE correspondientes a las referencias ATE



Referencia anterior / varios

AUDI

A2 (00-05)	1,4 TDI	TI	11.2003	07.2005	24.3344-1709.5	240810	PINZA DE GARRA	6Q0 615 423 B , 6Q0 615 423 A	24.3344-1709.7
	1,6 FSI	TI	05.2002	07.2005	24.3344-1709.5	240810	PINZA DE GARRA	6Q0 615 423 B , 6Q0 615 423 A	24.3344-1709.7
A3 / A3 (8P) Sportback (03-13)	1,2 TSI		04.2010	08.2013	11.0230-0663.1	260131	CALIPER MOUNT. BRACKET	1K0 615 125 B	
	1,4 TFSI		07.2007	08.2013	11.0230-0663.1	260131	CALIPER MOUNT. BRACKET	1K0 615 125 B	
			07.2007	12.2008	24.9145-0001.2	399005	HYDRAULIC CONTROL UNI	1K0 698 517 B	
	1,6		05.2003	08.2013	11.0230-0663.1	260131	CALIPER MOUNT. BRACKET	1K0 615 125 B	
			05.2003	12.2008	24.9145-0001.2	399005	HYDRAULIC CONTROL UNI	1K0 698 517 B	
	1,6 FSI		08.2003	08.2013	11.0230-0663.1	260131	CALIPER MOUNT. BRACKET	1K0 615 125 B	
			08.2003	12.2008	24.9145-0001.2	399005	HYDRAULIC CONTROL UNI	1K0 698 517 B	
	1,6 TDI		05.2009	08.2013	11.0230-0663.1	260131	CALIPER MOUNT. BRACKET	1K0 615 125 B	
	1,8 TFSI		01.2007	08.2013	11.0230-0663.1	260131	CALIPER MOUNT. BRACKET	1K0 615 125 B	
			01.2007	12.2008	24.9145-0001.2	399005	HYDRAULIC CONTROL UNI	1K0 698 517 B	
	1,8 TFSI quattro		05.2008	08.2013	11.0230-0663.1	260131	CALIPER MOUNT. BRACKET	1K0 615 125 B	
			05.2008	12.2008	24.9145-0001.2	399005	HYDRAULIC CONTROL UNI	1K0 698 517 B	
	1,9 TDI		06.2003	08.2013	11.0230-0663.1	260131	CALIPER MOUNT. BRACKET	1K0 615 125 B	
			06.2003	12.2008	24.9145-0001.2	399005	HYDRAULIC CONTROL UNI	1K0 698 517 B	
	2,0 FSI		05.2003	08.2013	11.0230-0663.1	260131	CALIPER MOUNT. BRACKET	1K0 615 125 B	
			05.2003	12.2008	24.9145-0001.2	399005	HYDRAULIC CONTROL UNI	1K0 698 517 B	
	2,0 TDI		06.2006	06.2008	11.0230-0663.1	260131	CALIPER MOUNT. BRACKET	1K0 615 125 B	
			03.2006	08.2013	11.0230-0663.1	260131	CALIPER MOUNT. BRACKET	1K0 615 125 B	



Denominación

Ref. OE correspondientes a las referencias ATE



Referencia anterior / varios

AUDI

A3 / A3 (8P) Sportback (03-13)	2,0 TDI		05.2003	08.2013	11.0230-0663.1	260131	CALIPER MOUNT. BRACKET	1K0 615 125 B	
			05.2003	12.2008	24.9145-0001.2	399005	HYDRAULIC CONTROL UNI	1K0 698 517 B	
			03.2006	12.2008	24.9145-0001.2	399005	HYDRAULIC CONTROL UNI	1K0 698 517 B	
			06.2006	06.2008	24.9145-0001.2	399005	HYDRAULIC CONTROL UNI	1K0 698 517 B	
	2,0 TDI quattro		03.2006	08.2013	11.0230-0663.1	260131	CALIPER MOUNT. BRACKET	1K0 615 125 B	
			05.2003	08.2013	11.0230-0663.1	260131	CALIPER MOUNT. BRACKET	1K0 615 125 B	
			08.2004	08.2013	11.0230-0663.1	260131	CALIPER MOUNT. BRACKET	1K0 615 125 B	
			08.2004	12.2008	24.9145-0001.2	399005	HYDRAULIC CONTROL UNI	1K0 698 517 B	
			05.2003	12.2008	24.9145-0001.2	399005	HYDRAULIC CONTROL UNI	1K0 698 517 B	
			03.2006	12.2008	24.9145-0001.2	399005	HYDRAULIC CONTROL UNI	1K0 698 517 B	
	2,0 TFSI		06.2004	08.2013	11.0230-0663.1	260131	CALIPER MOUNT. BRACKET	1K0 615 125 B	
			06.2004	12.2008	24.9145-0001.2	399005	HYDRAULIC CONTROL UNI	1K0 698 517 B	
	2,0 TFSI quattro		06.2004	08.2013	11.0230-0663.1	260131	CALIPER MOUNT. BRACKET	1K0 615 125 B	
			06.2004	12.2008	24.9145-0001.2	399005	HYDRAULIC CONTROL UNI	1K0 698 517 B	
	3,2 quattro		07.2003	08.2013	11.0230-0663.1	260131	CALIPER MOUNT. BRACKET	1K0 615 125 B	
			07.2003	12.2008	24.9145-0001.2	399005	HYDRAULIC CONTROL UNI	1K0 698 517 B	
	S3		11.2006	12.2008	24.9145-0001.2	399005	HYDRAULIC CONTROL UNI	1K0 698 517 B	
			07.2008	12.2008	24.9145-0001.2	399005	HYDRAULIC CONTROL UNI	1K0 698 517 B	
A4 (B6/B7) (01-08)	1,6		12.2000	11.2008	11.0230-0807.1	260134	CALIPER MOUNT. BRACKET	4F0 615 125	
	1,8 T		11.2002	11.2008	11.0230-0807.1	260134	CALIPER MOUNT. BRACKET	4F0 615 125	
			07.2001	11.2008	11.0230-0807.1	260134	CALIPER MOUNT. BRACKET	4F0 615 125	



Denominación

Ref. OE correspondientes a las referencias ATE



Referencia anterior / varios

AUDI

A4 (B6/B7) (01-08)	1,8 T		12.2000	11.2008	11.0230-0807.1	260134	CALIPER MOUNT. BRACKET	4F0 615 125	
			07.2002	11.2008	11.0230-0807.1	260134	CALIPER MOUNT. BRACKET	4F0 615 125	
	1,8 T quattro		07.2002	11.2008	11.0230-0807.1	260134	CALIPER MOUNT. BRACKET	4F0 615 125	
			11.2002	11.2008	11.0230-0807.1	260134	CALIPER MOUNT. BRACKET	4F0 615 125	
			12.2000	11.2008	11.0230-0807.1	260134	CALIPER MOUNT. BRACKET	4F0 615 125	
			07.2001	11.2008	11.0230-0807.1	260134	CALIPER MOUNT. BRACKET	4F0 615 125	
	1,9 TDI		04.2001	11.2008	11.0230-0807.1	260134	CALIPER MOUNT. BRACKET	4F0 615 125	
			06.2004	11.2008	11.0230-0807.1	260134	CALIPER MOUNT. BRACKET	4F0 615 125	
			12.2000	11.2008	11.0230-0807.1	260134	CALIPER MOUNT. BRACKET	4F0 615 125	
	1,9 TDI quattro		12.2000	11.2008	11.0230-0807.1	260134	CALIPER MOUNT. BRACKET	4F0 615 125	
	2		12.2000	11.2008	11.0230-0807.1	260134	CALIPER MOUNT. BRACKET	4F0 615 125	
	2,0 FSI		07.2002	11.2008	11.0230-0807.1	260134	CALIPER MOUNT. BRACKET	4F0 615 125	
	2,0 TDI		11.2004	11.2008	11.0230-0807.1	260134	CALIPER MOUNT. BRACKET	4F0 615 125	
			06.2006	11.2008	11.0230-0807.1	260134	CALIPER MOUNT. BRACKET	4F0 615 125	
	2,0 TDI quattro		01.2006	11.2008	11.0230-0807.1	260134	CALIPER MOUNT. BRACKET	4F0 615 125	
			06.2006	11.2008	11.0230-0807.1	260134	CALIPER MOUNT. BRACKET	4F0 615 125	
	2,0 TFSI		06.2005	11.2008	11.0230-0807.1	260134	CALIPER MOUNT. BRACKET	4F0 615 125	
			11.2004	11.2008	11.0230-0807.1	260134	CALIPER MOUNT. BRACKET	4F0 615 125	
	2,0 TFSI quattro		06.2005	11.2008	11.0230-0807.1	260134	CALIPER MOUNT. BRACKET	4F0 615 125	
			11.2004	11.2008	11.0230-0807.1	260134	CALIPER MOUNT. BRACKET	4F0 615 125	
	2,4		09.2001	11.2008	11.0230-0807.1	260134	CALIPER MOUNT. BRACKET	4F0 615 125	



Denominación

Ref. OE correspondientes a las referencias ATE



Referencia anterior / varios

AUDI

Modelo	Motor	Fecha inicio	Fecha fin	Ref. ATE	Ref. OE	Denominación	Ref. OE correspondientes a las referencias ATE
A4 (B6/B7) (01-08)	2,5 TDI	12.2000	11.2008	11.0230-0807.1	260134	CALIPER MOUNT. BRACKET	4F0 615 125
	2,5 TDI quattro	12.2000	11.2008	11.0230-0807.1	260134	CALIPER MOUNT. BRACKET	4F0 615 125
	2,7 TDI	01.2006	11.2008	11.0230-0807.1	260134	CALIPER MOUNT. BRACKET	4F0 615 125
		11.2005	11.2008	11.0230-0807.1	260134	CALIPER MOUNT. BRACKET	4F0 615 125
	3	12.2000	11.2008	11.0230-0807.1	260134	CALIPER MOUNT. BRACKET	4F0 615 125
	3,0 quattro	12.2000	11.2008	11.0230-0807.1	260134	CALIPER MOUNT. BRACKET	4F0 615 125
	3,0 TDI quattro	01.2006	11.2008	11.0230-0807.1	260134	CALIPER MOUNT. BRACKET	4F0 615 125
		11.2004	11.2008	11.0230-0807.1	260134	CALIPER MOUNT. BRACKET	4F0 615 125
	3,2 FSI	01.2005	11.2008	11.0230-0807.1	260134	CALIPER MOUNT. BRACKET	4F0 615 125
	3,2 FSI quattro	01.2005	11.2008	11.0230-0807.1	260134	CALIPER MOUNT. BRACKET	4F0 615 125
	S4	03.2003		11.0230-0663.1	260131	CALIPER MOUNT. BRACKET	1K0 615 125 B
A4 Cabrióle (02-08)	1,8 T	04.2002	11.2008	11.0230-0807.1	260134	CALIPER MOUNT. BRACKET	4F0 615 125
	1,8 T quattro	05.2003	11.2008	11.0230-0807.1	260134	CALIPER MOUNT. BRACKET	4F0 615 125
	2	05.2004	11.2008	11.0230-0807.1	260134	CALIPER MOUNT. BRACKET	4F0 615 125
	2,0 TDI	10.2005	11.2008	11.0230-0807.1	260134	CALIPER MOUNT. BRACKET	4F0 615 125
	2,0 TFSI	01.2006	11.2008	11.0230-0807.1	260134	CALIPER MOUNT. BRACKET	4F0 615 125
	2,0 TFSI quattro	11.2005	11.2008	11.0230-0807.1	260134	CALIPER MOUNT. BRACKET	4F0 615 125
	2,4	04.2002	11.2008	11.0230-0807.1	260134	CALIPER MOUNT. BRACKET	4F0 615 125
	2,5 TDI	08.2002	11.2008	11.0230-0807.1	260134	CALIPER MOUNT. BRACKET	4F0 615 125
	2,7 TDI	06.2006	11.2008	11.0230-0807.1	260134	CALIPER MOUNT. BRACKET	4F0 615 125
	3	04.2002	11.2008	11.0230-0807.1	260134	CALIPER MOUNT. BRACKET	4F0 615 125



Denominación

Ref. OE correspondientes a las referencias ATE



Referencia anterior / varios

AUDI

Modelo	Motor	Fecha 1	Fecha 2	Código 1	Código 2	Denominación	Ref. OE	Referencia anterior / varios
A4 Cabriolé (02-08)	3,0 quattro	05.2003	11.2008	11.0230-0807.1	260134	CALIPER MOUNT. BRACKET	4F0 615 125	
	3,0 TDI quattro	01.2006	11.2008	11.0230-0807.1	260134	CALIPER MOUNT. BRACKET	4F0 615 125	
		10.2005	11.2008	11.0230-0807.1	260134	CALIPER MOUNT. BRACKET	4F0 615 125	
	3,2 FSI	10.2005	11.2008	11.0230-0807.1	260134	CALIPER MOUNT. BRACKET	4F0 615 125	
	3,2 FSI quattro	10.2005	11.2008	11.0230-0807.1	260134	CALIPER MOUNT. BRACKET	4F0 615 125	
	S4	02.2004	11.2008	11.0230-0663.1	260131	CALIPER MOUNT. BRACKET	1K0 615 125 B	
A6 (4F2/C6) Limousine (04-11)	2,0 TDI	07.2004	03.2011	11.0230-0663.1	260131	CALIPER MOUNT. BRACKET	1K0 615 125 B	
		10.2008	03.2011	11.0230-0807.1	260134	CALIPER MOUNT. BRACKET	4F0 615 125	
		06.2005	03.2011	11.0230-0807.1	260134	CALIPER MOUNT. BRACKET	4F0 615 125	
		10.2008	03.2011	11.0230-0663.1	260131	CALIPER MOUNT. BRACKET	1K0 615 125 B	
		06.2005	03.2011	11.0230-0663.1	260131	CALIPER MOUNT. BRACKET	1K0 615 125 B	
		07.2004	03.2011	11.0230-0807.1	260134	CALIPER MOUNT. BRACKET	4F0 615 125	
	2,0 TFSI	06.2005	03.2011	11.0230-0807.1	260134	CALIPER MOUNT. BRACKET	4F0 615 125	
		06.2005	03.2011	11.0230-0663.1	260131	CALIPER MOUNT. BRACKET	1K0 615 125 B	
	2,4	04.2004	03.2011	11.0230-0807.1	260134	CALIPER MOUNT. BRACKET	4F0 615 125	
		04.2004	03.2011	11.0230-0663.1	260131	CALIPER MOUNT. BRACKET	1K0 615 125 B	
	2,4 quattro	01.2005	03.2011	11.0230-0807.1	260134	CALIPER MOUNT. BRACKET	4F0 615 125	
		01.2005	03.2011	11.0230-0663.1	260131	CALIPER MOUNT. BRACKET	1K0 615 125 B	
	2,7 TDI	11.2004	03.2011	11.0230-0807.1	260134	CALIPER MOUNT. BRACKET	4F0 615 125	
		10.2008	03.2011	11.0230-0807.1	260134	CALIPER MOUNT. BRACKET	4F0 615 125	
		10.2008	03.2011	11.0230-0663.1	260131	CALIPER MOUNT. BRACKET	1K0 615 125 B	



Denominación

Ref. OE correspondientes a las referencias ATE



Referencia anterior / varios

AUDI

A6 (4F2/C6) Limousine (04-11)	2,7 TDI		11.2004	03.2011	11.0230-0663.1	260131	CALIPER MOUNT. BRACKET	1K0 615 125 B	
	2,7 TDI quattro		06.2005	03.2011	11.0230-0807.1	260134	CALIPER MOUNT. BRACKET	4F0 615 125	
			11.2004	03.2011	11.0230-0807.1	260134	CALIPER MOUNT. BRACKET	4F0 615 125	
			10.2008	03.2011	11.0230-0663.1	260131	CALIPER MOUNT. BRACKET	1K0 615 125 B	
			10.2008	03.2011	11.0230-0807.1	260134	CALIPER MOUNT. BRACKET	4F0 615 125	
			11.2004	03.2011	11.0230-0663.1	260131	CALIPER MOUNT. BRACKET	1K0 615 125 B	
			06.2005	03.2011	11.0230-0663.1	260131	CALIPER MOUNT. BRACKET	1K0 615 125 B	
	2,8 FSI		10.2008	03.2011	11.0230-0807.1	260134	CALIPER MOUNT. BRACKET	4F0 615 125	
			11.2006	03.2011	11.0230-0807.1	260134	CALIPER MOUNT. BRACKET	4F0 615 125	
			10.2008	03.2011	11.0230-0663.1	260131	CALIPER MOUNT. BRACKET	1K0 615 125 B	
			11.2006	03.2011	11.0230-0663.1	260131	CALIPER MOUNT. BRACKET	1K0 615 125 B	
	2,8 FSI quattro		10.2008	03.2011	11.0230-0663.1	260131	CALIPER MOUNT. BRACKET	1K0 615 125 B	
			04.2007	03.2011	11.0230-0807.1	260134	CALIPER MOUNT. BRACKET	4F0 615 125	
			04.2007	03.2011	11.0230-0663.1	260131	CALIPER MOUNT. BRACKET	1K0 615 125 B	
			10.2008	03.2011	11.0230-0807.1	260134	CALIPER MOUNT. BRACKET	4F0 615 125	
	3		04.2004	03.2011	11.0230-0807.1	260134	CALIPER MOUNT. BRACKET	4F0 615 125	
			04.2004	03.2011	11.0230-0663.1	260131	CALIPER MOUNT. BRACKET	1K0 615 125 B	
	3,0 quattro		04.2004	03.2011	11.0230-0807.1	260134	CALIPER MOUNT. BRACKET	4F0 615 125	
			04.2004	03.2011	11.0230-0663.1	260131	CALIPER MOUNT. BRACKET	1K0 615 125 B	
	3,0 TDI quattro		10.2008	03.2011	11.0230-0663.1	260131	CALIPER MOUNT. BRACKET	1K0 615 125 B	
			06.2006	03.2011	11.0230-0663.1	260131	CALIPER MOUNT. BRACKET	1K0 615 125 B	



Denominación

Ref. OE correspondientes a las referencias ATE



Referencia anterior / varios

AUDI

Modelo	Motor	04.2004	03.2011	11.0230-0663.1	260131	CALIPER MOUNT. BRACKET	1K0 615 125 B
A6 (4F2/C6) Limousine (04-11)	3,0 TDI quattro	04.2004	03.2011	11.0230-0663.1	260131	CALIPER MOUNT. BRACKET	1K0 615 125 B
		04.2004	03.2011	11.0230-0807.1	260134	CALIPER MOUNT. BRACKET	4F0 615 125
		06.2006	03.2011	11.0230-0807.1	260134	CALIPER MOUNT. BRACKET	4F0 615 125
		10.2008	03.2011	11.0230-0807.1	260134	CALIPER MOUNT. BRACKET	4F0 615 125
	3,0 TFSI quattro	10.2008	03.2011	11.0230-0807.1	260134	CALIPER MOUNT. BRACKET	4F0 615 125
		10.2008	03.2011	11.0230-0663.1	260131	CALIPER MOUNT. BRACKET	1K0 615 125 B
	3,2 FSI	04.2004	03.2011	11.0230-0807.1	260134	CALIPER MOUNT. BRACKET	4F0 615 125
		04.2004	03.2011	11.0230-0663.1	260131	CALIPER MOUNT. BRACKET	1K0 615 125 B
	3,2 FSI quattro	04.2004	03.2011	11.0230-0663.1	260131	CALIPER MOUNT. BRACKET	1K0 615 125 B
		04.2004	03.2011	11.0230-0807.1	260134	CALIPER MOUNT. BRACKET	4F0 615 125
	4,2 FSI quattro	06.2006	03.2011	11.0230-0663.1	260131	CALIPER MOUNT. BRACKET	1K0 615 125 B
		06.2006	03.2011	11.0230-0807.1	260134	CALIPER MOUNT. BRACKET	4F0 615 125
	4,2 quattro	04.2004	03.2011	11.0230-0807.1	260134	CALIPER MOUNT. BRACKET	4F0 615 125
		04.2004	03.2011	11.0230-0663.1	260131	CALIPER MOUNT. BRACKET	1K0 615 125 B
A6 (4F5/C6) Avant (05-11)	2,0 TDI	03.2005	08.2011	11.0230-0807.1	260134	CALIPER MOUNT. BRACKET	4F0 615 125
		10.2008	08.2011	11.0230-0807.1	260134	CALIPER MOUNT. BRACKET	4F0 615 125
		06.2005	08.2011	11.0230-0807.1	260134	CALIPER MOUNT. BRACKET	4F0 615 125
		03.2005	08.2011	11.0230-0663.1	260131	CALIPER MOUNT. BRACKET	1K0 615 125 B
		06.2005	08.2011	11.0230-0663.1	260131	CALIPER MOUNT. BRACKET	1K0 615 125 B
		10.2008	08.2011	11.0230-0663.1	260131	CALIPER MOUNT. BRACKET	1K0 615 125 B
	2,0 TFSI	06.2005	08.2011	11.0230-0663.1	260131	CALIPER MOUNT. BRACKET	1K0 615 125 B



Denominación

Ref. OE correspondientes a las referencias ATE



Referencia anterior / varios

AUDI

A6 (4F5/C6) Avant (05-11)	2,0 TFSI		06.2005	08.2011	11.0230-0807.1	260134	CALIPER MOUNT. BRACKET	4F0 615 125	
	2,4		03.2005	08.2011	11.0230-0663.1	260131	CALIPER MOUNT. BRACKET	1K0 615 125 B	
			03.2005	08.2011	11.0230-0807.1	260134	CALIPER MOUNT. BRACKET	4F0 615 125	
	2,4 quattro		03.2005	08.2011	11.0230-0807.1	260134	CALIPER MOUNT. BRACKET	4F0 615 125	
			03.2005	08.2011	11.0230-0663.1	260131	CALIPER MOUNT. BRACKET	1K0 615 125 B	
	2,7 TDI		10.2008	08.2011	11.0230-0807.1	260134	CALIPER MOUNT. BRACKET	4F0 615 125	
			03.2005	08.2011	11.0230-0807.1	260134	CALIPER MOUNT. BRACKET	4F0 615 125	
			03.2005	08.2011	11.0230-0663.1	260131	CALIPER MOUNT. BRACKET	1K0 615 125 B	
			10.2008	08.2011	11.0230-0663.1	260131	CALIPER MOUNT. BRACKET	1K0 615 125 B	
	2,7 TDI quattro		10.2008	08.2011	11.0230-0663.1	260131	CALIPER MOUNT. BRACKET	1K0 615 125 B	
			06.2005	08.2011	11.0230-0663.1	260131	CALIPER MOUNT. BRACKET	1K0 615 125 B	
			03.2005	08.2011	11.0230-0663.1	260131	CALIPER MOUNT. BRACKET	1K0 615 125 B	
			03.2005	08.2011	11.0230-0807.1	260134	CALIPER MOUNT. BRACKET	4F0 615 125	
			06.2005	08.2011	11.0230-0807.1	260134	CALIPER MOUNT. BRACKET	4F0 615 125	
			10.2008	08.2011	11.0230-0807.1	260134	CALIPER MOUNT. BRACKET	4F0 615 125	
	2,8 FSI		11.2006	08.2011	11.0230-0807.1	260134	CALIPER MOUNT. BRACKET	4F0 615 125	
			10.2008	08.2011	11.0230-0807.1	260134	CALIPER MOUNT. BRACKET	4F0 615 125	
			11.2006	08.2011	11.0230-0663.1	260131	CALIPER MOUNT. BRACKET	1K0 615 125 B	
			10.2008	08.2011	11.0230-0663.1	260131	CALIPER MOUNT. BRACKET	1K0 615 125 B	
	2,8 FSI quattro		04.2007	08.2011	11.0230-0807.1	260134	CALIPER MOUNT. BRACKET	4F0 615 125	
			10.2008	08.2011	11.0230-0807.1	260134	CALIPER MOUNT. BRACKET	4F0 615 125	



Denominación

Ref. OE correspondientes a las referencias ATE



Referencia anterior / varios

AUDI

Audi Model	Engine	Year	Year	Part No.	Part No.	Part Name	Ref. OE
A6 (4F5/C6) Avant (05-11)	2,8 FSI quattro	10.2008	08.2011	11.0230-0663.1	260131	CALIPER MOUNT. BRACKET	1K0 615 125 B
		04.2007	08.2011	11.0230-0663.1	260131	CALIPER MOUNT. BRACKET	1K0 615 125 B
	3	03.2005	08.2011	11.0230-0807.1	260134	CALIPER MOUNT. BRACKET	4F0 615 125
		03.2005	08.2011	11.0230-0663.1	260131	CALIPER MOUNT. BRACKET	1K0 615 125 B
	3,0 quattro	03.2005	08.2011	11.0230-0807.1	260134	CALIPER MOUNT. BRACKET	4F0 615 125
		03.2005	08.2011	11.0230-0663.1	260131	CALIPER MOUNT. BRACKET	1K0 615 125 B
	3,0 TDI quattro	03.2005	08.2011	11.0230-0663.1	260131	CALIPER MOUNT. BRACKET	1K0 615 125 B
		06.2006	08.2011	11.0230-0663.1	260131	CALIPER MOUNT. BRACKET	1K0 615 125 B
		10.2008	08.2011	11.0230-0663.1	260131	CALIPER MOUNT. BRACKET	1K0 615 125 B
		03.2005	08.2011	11.0230-0807.1	260134	CALIPER MOUNT. BRACKET	4F0 615 125
		06.2006	08.2011	11.0230-0807.1	260134	CALIPER MOUNT. BRACKET	4F0 615 125
		10.2008	08.2011	11.0230-0807.1	260134	CALIPER MOUNT. BRACKET	4F0 615 125
	3,0 TFSI quattro	10.2008	08.2011	11.0230-0663.1	260131	CALIPER MOUNT. BRACKET	1K0 615 125 B
		10.2008	08.2011	11.0230-0807.1	260134	CALIPER MOUNT. BRACKET	4F0 615 125
	3,2 FSI	03.2005	08.2011	11.0230-0663.1	260131	CALIPER MOUNT. BRACKET	1K0 615 125 B
		03.2005	08.2011	11.0230-0807.1	260134	CALIPER MOUNT. BRACKET	4F0 615 125
	3,2 FSI quattro	03.2005	08.2011	11.0230-0663.1	260131	CALIPER MOUNT. BRACKET	1K0 615 125 B
		03.2005	08.2011	11.0230-0807.1	260134	CALIPER MOUNT. BRACKET	4F0 615 125
	4,2 FSI quattro	06.2006	08.2011	11.0230-0663.1	260131	CALIPER MOUNT. BRACKET	1K0 615 125 B
		06.2006	08.2011	11.0230-0807.1	260134	CALIPER MOUNT. BRACKET	4F0 615 125
	4,2 quattro	03.2005	08.2011	11.0230-0663.1	260131	CALIPER MOUNT. BRACKET	1K0 615 125 B



Denominación

Ref. OE correspondientes a las referencias ATE



Referencia anterior / varios

AUDI

Modelo	Motor	03.2005	08.2011	11.0230-0807.1	260134	CALIPER MOUNT. BRACKET	4F0 615 125	
A6 (4F5/C6) Avant (05-11)	4,2 quattro							
A6 Allroad (06-11)	2,7 TDI	05.2006	05.2011	11.0230-0807.1	260134	CALIPER MOUNT. BRACKET	4F0 615 125	
		05.2006	05.2011	11.0230-0663.1	260131	CALIPER MOUNT. BRACKET	1K0 615 125 B	
		10.2008	05.2011	11.0230-0663.1	260131	CALIPER MOUNT. BRACKET	1K0 615 125 B	
		10.2008	05.2011	11.0230-0807.1	260134	CALIPER MOUNT. BRACKET	4F0 615 125	
	3,0 TDI	10.2008	05.2011	11.0230-0663.1	260131	CALIPER MOUNT. BRACKET	1K0 615 125 B	
		05.2006	05.2011	11.0230-0663.1	260131	CALIPER MOUNT. BRACKET	1K0 615 125 B	
		05.2006	05.2011	11.0230-0807.1	260134	CALIPER MOUNT. BRACKET	4F0 615 125	
		10.2008	05.2011	11.0230-0807.1	260134	CALIPER MOUNT. BRACKET	4F0 615 125	
	3,0 TFSI	10.2008	05.2011	11.0230-0663.1	260131	CALIPER MOUNT. BRACKET	1K0 615 125 B	
		10.2008	05.2011	11.0230-0807.1	260134	CALIPER MOUNT. BRACKET	4F0 615 125	
	3,2 FSI	05.2006	05.2011	11.0230-0807.1	260134	CALIPER MOUNT. BRACKET	4F0 615 125	
		05.2006	05.2011	11.0230-0663.1	260131	CALIPER MOUNT. BRACKET	1K0 615 125 B	
	4,2 FSI	05.2006	05.2011	11.0230-0663.1	260131	CALIPER MOUNT. BRACKET	1K0 615 125 B	
		05.2006	05.2011	11.0230-0807.1	260134	CALIPER MOUNT. BRACKET	4F0 615 125	
A8 (03-09)	2,8 FSI	08.2007	10.2009	11.0230-0807.1	260134	CALIPER MOUNT. BRACKET	4F0 615 125	
	3		10.2009	11.0230-0807.1	260134	CALIPER MOUNT. BRACKET	4F0 615 125	
	3,0 quattro		05.2004	11.0230-0807.1	260134	CALIPER MOUNT. BRACKET	4F0 615 125	
	3,0 TDI quattro		10.2009	11.0230-0807.1	260134	CALIPER MOUNT. BRACKET	4F0 615 125	
	3,2 FSI		10.2009	11.0230-0807.1	260134	CALIPER MOUNT. BRACKET	4F0 615 125	
	3,2 FSI quattro		10.2009	11.0230-0807.1	260134	CALIPER MOUNT. BRACKET	4F0 615 125	



					Denominación	Ref. OE correspondientes a las referencias ATE	 Referencia anterior / varios
---	---	---	--	---	---------------------	---	--

AUDI

Audi Model	Engine	Year	ATE Part No.	ATE Part No.	ATE Part No.	Denominación	Ref. OE correspondientes a las referencias ATE	Referencia anterior / varios
A8 (03-09)	3,7 quattro	10.2009	11.0230-0807.1	260134		CALIPER MOUNT. BRACKET	4F0 615 125	
	4,0 TDI quattro	10.2009	11.0230-0807.1	260134		CALIPER MOUNT. BRACKET	4F0 615 125	
	4,2 FSI quattro	10.2009	11.0230-0807.1	260134		CALIPER MOUNT. BRACKET	4F0 615 125	
	4,2 quattro	10.2009	11.0230-0807.1	260134		CALIPER MOUNT. BRACKET	4F0 615 125	
	4,2 TDI quattro	10.2009	11.0230-0807.1	260134		CALIPER MOUNT. BRACKET	4F0 615 125	
	6,0 W12 quattro	10.2009	11.0230-0807.1	260134		CALIPER MOUNT. BRACKET	4F0 615 125	



Denominación

Ref. OE correspondientes a las referencias ATE



Referencia anterior / varios

BMW

Modelo	Referencia	01.2011	12.2011	24.9145-0003.2	399007	Denominación	Ref. OE correspondientes a las referencias ATE	Referencia anterior / varios
1er Reihe/E81/E87 Limousine (04-11)	116 d					HYDRAULIC CONTROL UNI	34 51 6 863 354 , 34 51 6 862 870 , 34 51 6 797 896	
		03.2009	05.2011	24.9145-0003.2	399007	HYDRAULIC CONTROL UNI	34 51 6 863 354 , 34 51 6 862 870 , 34 51 6 797 896	
	116 i	09.2008	12.2008	24.9145-0003.2	399007	HYDRAULIC CONTROL UNI	34 51 6 863 354 , 34 51 6 862 870 , 34 51 6 797 896	
		01.2009	05.2011	24.9145-0003.2	399007	HYDRAULIC CONTROL UNI	34 51 6 863 354 , 34 51 6 862 870 , 34 51 6 797 896	
	118 d	09.2008	05.2011	24.9145-0003.2	399007	HYDRAULIC CONTROL UNI	34 51 6 863 354 , 34 51 6 862 870 , 34 51 6 797 896	
	118 i	09.2008	05.2011	24.9145-0003.2	399007	HYDRAULIC CONTROL UNI	34 51 6 863 354 , 34 51 6 862 870 , 34 51 6 797 896	
	120 d	09.2008	05.2011	24.9145-0003.2	399007	HYDRAULIC CONTROL UNI	34 51 6 863 354 , 34 51 6 862 870 , 34 51 6 797 896	
	120 i	09.2008	05.2011	24.9145-0003.2	399007	HYDRAULIC CONTROL UNI	34 51 6 863 354 , 34 51 6 862 870 , 34 51 6 797 896	
	123 d	09.2008	05.2011	24.9145-0003.2	399007	HYDRAULIC CONTROL UNI	34 51 6 863 354 , 34 51 6 862 870 , 34 51 6 797 896	
1er Reihe/E82 Coupe (07-13)	118 d	09.2009	10.2013	24.9145-0003.2	399007	HYDRAULIC CONTROL UNI	34 51 6 863 354 , 34 51 6 862 870 , 34 51 6 797 896	
	120 d	09.2008	10.2013	24.9145-0003.2	399007	HYDRAULIC CONTROL UNI	34 51 6 863 354 , 34 51 6 862 870 , 34 51 6 797 896	
	120 i	09.2009	10.2013	24.9145-0003.2	399007	HYDRAULIC CONTROL UNI	34 51 6 863 354 , 34 51 6 862 870 , 34 51 6 797 896	
	123 d	09.2008	10.2013	24.9145-0003.2	399007	HYDRAULIC CONTROL UNI	34 51 6 863 354 , 34 51 6 862 870 , 34 51 6 797 896	
1er Reihe/E88 Cabrio (08-13)	118 d	09.2008	10.2013	24.9145-0003.2	399007	HYDRAULIC CONTROL UNI	34 51 6 863 354 , 34 51 6 862 870 , 34 51 6 797 896	



Denominación

Ref. OE correspondientes a las referencias ATE



Referencia anterior / varios

BMW

Modelo	Referencia	Fecha	Referencia	Código	Código	Denominación	Referencias OE
1er Reihe/E88 Cabrio (08-13)	118 i	09.2008	10.2013	24.9145-0003.2	399007	HYDRAULIC CONTROL UNI	34 51 6 863 354 , 34 51 6 862 870 , 34 51 6 797 896
	120 d	09.2008	10.2013	24.9145-0003.2	399007	HYDRAULIC CONTROL UNI	34 51 6 863 354 , 34 51 6 862 870 , 34 51 6 797 896
	120 i	09.2008	10.2013	24.9145-0003.2	399007	HYDRAULIC CONTROL UNI	34 51 6 863 354 , 34 51 6 862 870 , 34 51 6 797 896
	123 d	09.2008	10.2013	24.9145-0003.2	399007	HYDRAULIC CONTROL UNI	34 51 6 863 354 , 34 51 6 862 870 , 34 51 6 797 896
2er Reihe/F45 Active Tourer (14-)	214 d	03.2015		13.0470-2795.2	LD2795	CERAMIC PAST. DE FRENO	34 10 6 863 292 , 34 11 6 860 016
	216 i	11.2015		13.0470-2795.2	LD2795	CERAMIC PAST. DE FRENO	34 10 6 863 292 , 34 11 6 860 016
3er Reihe/E90 Limousine (05-12)	316 d	07.2009	03.2012	24.9145-0003.2	399007	HYDRAULIC CONTROL UNI	34 51 6 863 354 , 34 51 6 862 870 , 34 51 6 797 896
	316 i	09.2008	03.2012	24.9145-0003.2	399007	HYDRAULIC CONTROL UNI	34 51 6 863 354 , 34 51 6 862 870 , 34 51 6 797 896
	318 d	09.2008	03.2012	24.9145-0003.2	399007	HYDRAULIC CONTROL UNI	34 51 6 863 354 , 34 51 6 862 870 , 34 51 6 797 896
	318 i	09.2008	03.2012	24.9145-0003.2	399007	HYDRAULIC CONTROL UNI	34 51 6 863 354 , 34 51 6 862 870 , 34 51 6 797 896
	320 d	09.2008	03.2012	24.9145-0003.2	399007	HYDRAULIC CONTROL UNI	34 51 6 863 354 , 34 51 6 862 870 , 34 51 6 797 896
	320 i	09.2008	03.2012	24.9145-0003.2	399007	HYDRAULIC CONTROL UNI	34 51 6 863 354 , 34 51 6 862 870 , 34 51 6 797 896
3er Reihe/E91 Touring (05-12)	316 d	09.2009	05.2012	24.9145-0003.2	399007	HYDRAULIC CONTROL UNI	34 51 6 863 354 , 34 51 6 862 870 , 34 51 6 797 896
	316i	09.2008	05.2012	24.9145-0003.2	399007	HYDRAULIC CONTROL UNI	34 51 6 863 354 , 34 51 6 862 870 , 34 51 6 797 896



Denominación

Ref. OE correspondientes a las referencias ATE









Referencia anterior / varios

BMW

Modelo	Referencia		09.2008	05.2012	24.9145-0003.2	399007	Denominación	Ref. OE correspondientes a las referencias ATE	
3er Reihe/E91 Touring (05-12)	318 d						HYDRAULIC CONTROL UNI	34 51 6 863 354 , 34 51 6 862 870 , 34 51 6 797 896	
	318 i		09.2008	05.2012	24.9145-0003.2	399007	HYDRAULIC CONTROL UNI	34 51 6 863 354 , 34 51 6 862 870 , 34 51 6 797 896	
	320 d		09.2008	05.2012	24.9145-0003.2	399007	HYDRAULIC CONTROL UNI	34 51 6 863 354 , 34 51 6 862 870 , 34 51 6 797 896	
	320 i		09.2008	05.2012	24.9145-0003.2	399007	HYDRAULIC CONTROL UNI	34 51 6 863 354 , 34 51 6 862 870 , 34 51 6 797 896	
3er Reihe/E92 Coupe (06-13)	316 i		09.2008	06.2013	24.9145-0003.2	399007	HYDRAULIC CONTROL UNI	34 51 6 863 354 , 34 51 6 862 870 , 34 51 6 797 896	
	318 i		03.2010	06.2013	24.9145-0003.2	399007	HYDRAULIC CONTROL UNI	34 51 6 863 354 , 34 51 6 862 870 , 34 51 6 797 896	
	320 d		09.2008	06.2013	24.9145-0003.2	399007	HYDRAULIC CONTROL UNI	34 51 6 863 354 , 34 51 6 862 870 , 34 51 6 797 896	
	320 i		09.2008	06.2013	24.9145-0003.2	399007	HYDRAULIC CONTROL UNI	34 51 6 863 354 , 34 51 6 862 870 , 34 51 6 797 896	
3er Reihe/E93 Cabrio (07-13)	318 i		03.2010	11.2013	24.9145-0003.2	399007	HYDRAULIC CONTROL UNI	34 51 6 863 354 , 34 51 6 862 870 , 34 51 6 797 896	
	320 d		01.2010	11.2013	24.9145-0003.2	399007	HYDRAULIC CONTROL UNI	34 51 6 863 354 , 34 51 6 862 870 , 34 51 6 797 896	
			09.2008	11.2013	24.9145-0003.2	399007	HYDRAULIC CONTROL UNI	34 51 6 863 354 , 34 51 6 862 870 , 34 51 6 797 896	
	320 i		09.2008	11.2013	24.9145-0003.2	399007	HYDRAULIC CONTROL UNI	34 51 6 863 354 , 34 51 6 862 870 , 34 51 6 797 896	
Z3/E36 (95-02)	1,8	TI	10.1995	10.1998	24.3361-8505.5	240633	PINZA DE GARRA	34 21 1 164 397	
	1,9	TI	10.1995	12.2002	24.3361-8505.5	240633	PINZA DE GARRA	34 21 1 164 397	
	2	TI	04.1999	08.2000	24.3361-8505.5	240633	PINZA DE GARRA	34 21 1 164 397	



					Denominación	Ref. OE correspondientes a las referencias ATE	 Referencia anterior / varios
---	---	---	--	---	---------------------	---	--

BMW

Z3/E36 (95-02)	2,2	TI	10.2000	12.2002	24.3361-8505.5	240633	PINZA DE GARRA	34 21 1 164 397	
	2,8 Coupe	TI	07.1997	06.2000	24.3361-8505.5	240633	PINZA DE GARRA	34 21 1 164 397	
	2,8 Roadster	TI	05.1997	06.2000	24.3361-8505.5	240633	PINZA DE GARRA	34 21 1 164 397	
	3,0 Coupe	TI	06.2000	12.2002	24.3361-8505.5	240633	PINZA DE GARRA	34 21 1 164 397	
	3,0 Roadster	TI	06.2000	12.2002	24.3361-8505.5	240633	PINZA DE GARRA	34 21 1 164 397	

Classic NFZ

STEYR DAIMLER PUCH 380-10230 (58-88)	1090		01.1975	12.1979	03.0370-0115.2	050115	JUEGO DE REPARACION	34 31 4 050 590	03.0370-0115.2
--------------------------------------	------	--	---------	---------	----------------	--------	---------------------	-----------------	----------------



					Denominación	Ref. OE correspondientes a las referencias ATE	Referencia anterior / varios
--	--	--	--	--	---------------------	---	-------------------------------------

Classic PKW

BMW 2,5/2,8/3,0/3,3 (68-77)	2500		01.1969	08.1973	03.3402-2204.1	829089	GOMA FRENO	411 721 269 B , 90.81052.1118 , 10548.45020.01/16	
	2800		01.1969	08.1973	03.3402-2204.1	829089	GOMA FRENO	411 721 269 B , 90.81052.1118 , 10548.45020.01/16	
	3,0 S/LS/CS		01.1971	08.1973	03.3402-2204.1	829089	GOMA FRENO	411 721 269 B , 90.81052.1118 , 10548.45020.01/16	
JAGUAR XJ (X300) (94-97)	12 6,0	DI	11.1994	07.1997	11.9601-9781.2	220991	PINZA DE GARRA	JLM 21470 , JLM 11717	
	6 3,2	DI	11.1994	07.1997	11.9601-9781.2	220991	PINZA DE GARRA	JLM 21470 , JLM 11717	
	6 Sovereign 4,0	DI	11.1994	07.1997	11.9601-9781.2	220991	PINZA DE GARRA	JLM 21470 , JLM 11717	
	R Super Charged 4,0	DI	11.1994	07.1997	11.9601-9781.2	220991	PINZA DE GARRA	JLM 21470 , JLM 11717	
NSU 1000/1200 (63-72)	1000		08.1963	12.1967	03.0370-0115.2	050115	JUEGO DE REPARACION	34 31 4 050 590	03.0370-0115.2
NSU PRINZ 4 (61-71)	600		08.1961	11.1971	03.0370-0115.2	050115	JUEGO DE REPARACION	34 31 4 050 590	03.0370-0115.2
STEYR DAIMLER PUCH 500/600/700 (58-69)	500/500 D		01.1958	12.1969	03.0370-0115.2	050115	JUEGO DE REPARACION	34 31 4 050 590	03.0370-0115.2
	650T/650 TR		01.1961	12.1969	03.0370-0115.2	050115	JUEGO DE REPARACION	34 31 4 050 590	03.0370-0115.2
	700C/700 E		01.1960	12.1969	03.0370-0115.2	050115	JUEGO DE REPARACION	34 31 4 050 590	03.0370-0115.2



Denominación

Ref. OE correspondientes a las referencias ATE



Referencia anterior / varios

DACIA

DUSTER (HS_) (10-)	1,2 TCe 125		09.2013		24.5201-0280.3	331569	LATIGUILLO	46 21 072 11R	
	1,2 TCe 125 4x4		06.2015		24.5201-0280.3	331569	LATIGUILLO	46 21 072 11R	
	1,5 dCi		09.2013		24.5201-0280.3	331569	LATIGUILLO	46 21 072 11R	
	1,5 dCi 4x4		08.2013		24.5201-0280.3	331569	LATIGUILLO	46 21 072 11R	
LOGAN II Limousine (L52_) (12-)	0,9 TCe 90		11.2012		24.5201-0280.3	331569	LATIGUILLO	46 21 072 11R	
	0,9 TCe 90 LPG		09.2015		24.5201-0280.3	331569	LATIGUILLO	46 21 072 11R	
	1,2 16V 75		11.2012		24.5201-0280.3	331569	LATIGUILLO	46 21 072 11R	
	1,2 16V LPG		11.2012		24.5201-0280.3	331569	LATIGUILLO	46 21 072 11R	
	1,5 dCi 75		11.2012		24.5201-0280.3	331569	LATIGUILLO	46 21 072 11R	
	1,5 DCi 85		01.2013		24.5201-0280.3	331569	LATIGUILLO	46 21 072 11R	
	1,5 dCi 90		11.2012		24.5201-0280.3	331569	LATIGUILLO	46 21 072 11R	
	1,6 16V		04.2015		24.5201-0280.3	331569	LATIGUILLO	46 21 072 11R	
			01.2013		24.5201-0280.3	331569	LATIGUILLO	46 21 072 11R	
LOGAN II MCV Kombi (13-)	0,9 TCe 90		02.2013		24.5201-0280.3	331569	LATIGUILLO	46 21 072 11R	
	0,9 TCe 90 LPG		09.2015		24.5201-0280.3	331569	LATIGUILLO	46 21 072 11R	
	1,0 SCe 75		12.2016		24.5201-0280.3	331569	LATIGUILLO	46 21 072 11R	
	1,2 16V		02.2013		24.5201-0280.3	331569	LATIGUILLO	46 21 072 11R	
	1,2 16V LPG		02.2013		24.5201-0280.3	331569	LATIGUILLO	46 21 072 11R	
	1,5 dCi 75		02.2013		24.5201-0280.3	331569	LATIGUILLO	46 21 072 11R	
	1,5 dCi 85		02.2013		24.5201-0280.3	331569	LATIGUILLO	46 21 072 11R	
	1,5 dCi 90		02.2013		24.5201-0280.3	331569	LATIGUILLO	46 21 072 11R	



Denominación

Ref. OE correspondientes a las referencias ATE



Referencia anterior / varios

DACIA

LOGAN II MCV Kombi (13-)	1,6		06.2013		24.5201-0280.3	331569	LATIGUILLO	46 21 072 11R	
SANDERO II (B52_) (12-)	0,9 TCe 90		11.2012		24.5201-0280.3	331569	LATIGUILLO	46 21 072 11R	
	0,9 TCe 90 LPG		09.2015		24.5201-0280.3	331569	LATIGUILLO	46 21 072 11R	
	1,0 SCe 75		12.2016		24.5201-0280.3	331569	LATIGUILLO	46 21 072 11R	
	1,2 16V		11.2012		24.5201-0280.3	331569	LATIGUILLO	46 21 072 11R	
	1,2 16V LPG		11.2012		24.5201-0280.3	331569	LATIGUILLO	46 21 072 11R	
	1,5 dCi 75		11.2012		24.5201-0280.3	331569	LATIGUILLO	46 21 072 11R	
	1,5 dCi 85		01.2013		24.5201-0280.3	331569	LATIGUILLO	46 21 072 11R	
	1,5 dCi 90		11.2012		24.5201-0280.3	331569	LATIGUILLO	46 21 072 11R	
	1,6		11.2012		24.5201-0280.3	331569	LATIGUILLO	46 21 072 11R	
	1,6 16V		04.2015		24.5201-0280.3	331569	LATIGUILLO	46 21 072 11R	



Denominación

Ref. OE correspondientes a las referencias ATE



Referencia anterior / varios

FIAT

500 (07-)	1,2 i		01.2010		24.3728-0536.2	590536	CABLE DE EMBRAGUE	1735312 , AS51-7K553-AA , 55226950	
	1,2 LPG		12.2010		24.3728-0536.2	590536	CABLE DE EMBRAGUE	1735312 , AS51-7K553-AA , 55226950	
500C (09-)	1,2		01.2010		24.3728-0536.2	590536	CABLE DE EMBRAGUE	1735312 , AS51-7K553-AA , 55226950	
500X (14-)	1,4 4x4		09.2014		24.0128-0292.1	428292	DISCO DE FRENO	51963548 , 51937304	
	1,6		09.2014		24.0128-0292.1	428292	DISCO DE FRENO	51963548 , 51937304	
			11.2014		24.0128-0292.1	428292	DISCO DE FRENO	51963548 , 51937304	
	2,0 D MultiJet 4x4		09.2014		24.0128-0292.1	428292	DISCO DE FRENO	51963548 , 51937304	
PANDA (12-)	1,2		02.2012		24.3728-0536.2	590536	CABLE DE EMBRAGUE	1735312 , AS51-7K553-AA , 55226950	
	1,2 LPG		02.2012		24.3728-0536.2	590536	CABLE DE EMBRAGUE	1735312 , AS51-7K553-AA , 55226950	



Denominación

Ref. OE correspondientes a las referencias ATE



Referencia anterior / varios

FORD

C-MAX I (07-10)	1,6 i 16V		03.2007	10.2010	24.9145-0004.2	399008	HYDRAULIC CONTROL UNI	BRYV-43-7A0 , 8M51-2B373-AA , 1692659	
	1,6 TDCi		03.2007	10.2010	24.9145-0004.2	399008	HYDRAULIC CONTROL UNI	BRYV-43-7A0 , 8M51-2B373-AA , 1692659	
	1,8 i 16V		03.2007	10.2010	24.9145-0004.2	399008	HYDRAULIC CONTROL UNI	BRYV-43-7A0 , 8M51-2B373-AA , 1692659	
	1,8 TDCi		03.2007	10.2010	24.9145-0004.2	399008	HYDRAULIC CONTROL UNI	BRYV-43-7A0 , 8M51-2B373-AA , 1692659	
	2,0 i 16V		03.2007	10.2010	24.9145-0004.2	399008	HYDRAULIC CONTROL UNI	BRYV-43-7A0 , 8M51-2B373-AA , 1692659	
	2,0 TDCi		03.2007	10.2010	24.9145-0004.2	399008	HYDRAULIC CONTROL UNI	BRYV-43-7A0 , 8M51-2B373-AA , 1692659	
			02.2008	10.2010	24.9145-0004.2	399008	HYDRAULIC CONTROL UNI	BRYV-43-7A0 , 8M51-2B373-AA , 1692659	
FOCUS C-MAX (03-07)	1,6 i 16V		08.2003	03.2007	24.9145-0004.2	399008	HYDRAULIC CONTROL UNI	BRYV-43-7A0 , 8M51-2B373-AA , 1692659	
	1,6 TDCi		08.2003	03.2007	24.9145-0004.2	399008	HYDRAULIC CONTROL UNI	BRYV-43-7A0 , 8M51-2B373-AA , 1692659	
			01.2005	03.2007	24.9145-0004.2	399008	HYDRAULIC CONTROL UNI	BRYV-43-7A0 , 8M51-2B373-AA , 1692659	
	1,6 Ti VCT		08.2004	03.2007	24.9145-0004.2	399008	HYDRAULIC CONTROL UNI	BRYV-43-7A0 , 8M51-2B373-AA , 1692659	
	1,8 i 16V		08.2003	03.2007	24.9145-0004.2	399008	HYDRAULIC CONTROL UNI	BRYV-43-7A0 , 8M51-2B373-AA , 1692659	
			04.2004	03.2007	24.9145-0004.2	399008	HYDRAULIC CONTROL UNI	BRYV-43-7A0 , 8M51-2B373-AA , 1692659	
	1,8 TDCi		01.2005	03.2007	24.9145-0004.2	399008	HYDRAULIC CONTROL UNI	BRYV-43-7A0 , 8M51-2B373-AA , 1692659	



Denominación

Ref. OE correspondientes a las referencias ATE



Referencia anterior / varios

FORD

Modelo	Motor	Fecha inicio	Fecha fin	Código ATE	Código OE	Denominación	Ref. OE correspondientes a las referencias ATE	Referencia anterior / varios
FOCUS C-MAX (03-07)	2,0 i 16V	04.2004	03.2007	24.9145-0004.2	399008	HYDRAULIC CONTROL UNI	BRYV-43-7A0 , 8M51-2B373-AA , 1692659	
	2,0 TDCi	08.2003	03.2007	24.9145-0004.2	399008	HYDRAULIC CONTROL UNI	BRYV-43-7A0 , 8M51-2B373-AA , 1692659	
FOCUS II (05-11)	1,4 i 16V	10.2004	02.2011	24.9145-0004.2	399008	HYDRAULIC CONTROL UNI	BRYV-43-7A0 , 8M51-2B373-AA , 1692659	
	1,6 i 16V	10.2004	02.2011	24.9145-0004.2	399008	HYDRAULIC CONTROL UNI	BRYV-43-7A0 , 8M51-2B373-AA , 1692659	
	1,6 TDCi	01.2005	02.2011	24.9145-0004.2	399008	HYDRAULIC CONTROL UNI	BRYV-43-7A0 , 8M51-2B373-AA , 1692659	
		10.2004	02.2011	24.9145-0004.2	399008	HYDRAULIC CONTROL UNI	BRYV-43-7A0 , 8M51-2B373-AA , 1692659	
	1,6 Ti VCT	10.2004	02.2011	24.9145-0004.2	399008	HYDRAULIC CONTROL UNI	BRYV-43-7A0 , 8M51-2B373-AA , 1692659	
	1,8 i 16V	01.2006	02.2011	24.9145-0004.2	399008	HYDRAULIC CONTROL UNI	BRYV-43-7A0 , 8M51-2B373-AA , 1692659	
	1,8 TDCi	01.2005	02.2011	24.9145-0004.2	399008	HYDRAULIC CONTROL UNI	BRYV-43-7A0 , 8M51-2B373-AA , 1692659	
	2,0 i 16V	10.2004	02.2011	24.9145-0004.2	399008	HYDRAULIC CONTROL UNI	BRYV-43-7A0 , 8M51-2B373-AA , 1692659	
	2,0 TDCi	10.2004	02.2011	24.9145-0004.2	399008	HYDRAULIC CONTROL UNI	BRYV-43-7A0 , 8M51-2B373-AA , 1692659	
		02.2008	02.2011	24.9145-0004.2	399008	HYDRAULIC CONTROL UNI	BRYV-43-7A0 , 8M51-2B373-AA , 1692659	
	2,5 ST	10.2005	02.2011	24.9145-0004.2	399008	HYDRAULIC CONTROL UNI	BRYV-43-7A0 , 8M51-2B373-AA , 1692659	
GALAXY III (15-)	1,5 EcoBoost	04.2015		13.0460-7313.2	607313	PASTILLAS DE FRENO	DG9C-2K021-EC , 1860105	ver figura
	2,0 EcoBoost	04.2015		13.0460-7313.2	607313	PASTILLAS DE FRENO	DG9C-2K021-EC , 1860105	ver figura



Denominación

Ref. OE correspondientes a las referencias ATE



Referencia anterior / varios

FORD

Modelo	Motor	Fecha inicio	Fecha fin	Código ATE	Código OE	Denominación	Ref. OE correspondientes a las referencias ATE	Referencia anterior / varios
GALAXY III (15-)	2,0 TDCi	04.2015		13.0460-7313.2	607313	PASTILLAS DE FRENO	DG9C-2K021-EC , 1860105	ver figura
	2,0 TDCi 4x4	05.2015		13.0460-7313.2	607313	PASTILLAS DE FRENO	DG9C-2K021-EC , 1860105	ver figura
	2,0 TDCi Bi-Turbo	04.2015		13.0460-7313.2	607313	PASTILLAS DE FRENO	DG9C-2K021-EC , 1860105	ver figura
KA II (08-)	1,2 i 16V	01.2010		24.3728-0536.2	590536	CABLE DE EMBRAGUE	1735312 , AS51-7K553-AA , 55226950	
KUGA I (08-12)	2,0 TDCi	04.2008	12.2012	24.9145-0004.2	399008	HYDRAULIC CONTROL UNI	BRYV-43-7A0 , 8M51-2B373-AA , 1692659	
		03.2010	12.2012	24.9145-0004.2	399008	HYDRAULIC CONTROL UNI	BRYV-43-7A0 , 8M51-2B373-AA , 1692659	
	2,0 TDCi 4x4	04.2008	12.2012	24.9145-0004.2	399008	HYDRAULIC CONTROL UNI	BRYV-43-7A0 , 8M51-2B373-AA , 1692659	
		03.2010	12.2012	24.9145-0004.2	399008	HYDRAULIC CONTROL UNI	BRYV-43-7A0 , 8M51-2B373-AA , 1692659	
	2,5 i	03.2009	12.2012	24.9145-0004.2	399008	HYDRAULIC CONTROL UNI	BRYV-43-7A0 , 8M51-2B373-AA , 1692659	
	2,5 i 4x4	11.2008	12.2012	24.9145-0004.2	399008	HYDRAULIC CONTROL UNI	BRYV-43-7A0 , 8M51-2B373-AA , 1692659	
MONDEO V (14-)	1,5 EcoBoost	10.2014	01.2015	13.0460-7313.2	607313	PASTILLAS DE FRENO	DG9C-2K021-EC , 1860105	ver figura
	1,6 TDCi	10.2014	01.2015	13.0460-7313.2	607313	PASTILLAS DE FRENO	DG9C-2K021-EC , 1860105	ver figura
	2,0 EcoBoost	10.2014	01.2015	13.0460-7313.2	607313	PASTILLAS DE FRENO	DG9C-2K021-EC , 1860105	ver figura
	2,0 Hybrid	10.2014	01.2015	13.0460-7313.2	607313	PASTILLAS DE FRENO	DG9C-2K021-EC , 1860105	ver figura
	2,0 TDCi	10.2014	01.2015	13.0460-7313.2	607313	PASTILLAS DE FRENO	DG9C-2K021-EC , 1860105	ver figura
S-MAX II (15-)	1,5 EcoBoost	02.2015		13.0460-7313.2	607313	PASTILLAS DE FRENO	DG9C-2K021-EC , 1860105	ver figura
	2,0 EcoBoost	02.2015		13.0460-7313.2	607313	PASTILLAS DE FRENO	DG9C-2K021-EC , 1860105	ver figura
	2,0 TDCi	02.2015		13.0460-7313.2	607313	PASTILLAS DE FRENO	DG9C-2K021-EC , 1860105	ver figura



Denominación

Ref. OE correspondientes a las referencias ATE

Referencia anterior / varios

FORD

S-MAX II (15-)	2,0 TDCi 4x4		02.2015		13.0460-7313.2	607313	PASTILLAS DE FRENO	DG9C-2K021-EC , 1860105	ver figura
	2,0 TDCi Bi-Turbo		02.2015		13.0460-7313.2	607313	PASTILLAS DE FRENO	DG9C-2K021-EC , 1860105	ver figura

HONDA

ACCORD VIII Kombi (08-15)	2,0 VTEC (CW1)		07.2008	06.2015	13.0460-7291.2	607291	PASTILLAS DE FRENO	45022-TL1-G01 , 45022-TL1-G00	ver figura
	2,2 i-DTEC (CW3)		07.2008	06.2015	13.0460-7291.2	607291	PASTILLAS DE FRENO	45022-TL1-G01 , 45022-TL1-G00	ver figura
	2,4 VTEC (CW2)		07.2008	06.2015	13.0460-7291.2	607291	PASTILLAS DE FRENO	45022-TL1-G01 , 45022-TL1-G00	ver figura
ACCORD VIII Limousine (08-15)	2,0 VTEC (CU1)		07.2008	06.2015	13.0460-7291.2	607291	PASTILLAS DE FRENO	45022-TL1-G01 , 45022-TL1-G00	ver figura
	2,2 i-DTEC (CU3)		07.2008	06.2015	13.0460-7291.2	607291	PASTILLAS DE FRENO	45022-TL1-G01 , 45022-TL1-G00	ver figura
	2,4 VTEC (CU2)		07.2008	06.2015	13.0460-7291.2	607291	PASTILLAS DE FRENO	45022-TL1-G01 , 45022-TL1-G00	ver figura

JAGUAR

XJ (NAW,NBW) (97-03)	XJ8 3,2	DI	07.1997	05.2003	11.9601-9781.2	220991	PINZA DE GARRA	JLM 21470 , JLM 11717	
	XJ8 4,0	DI	07.1997	05.2003	11.9601-9781.2	220991	PINZA DE GARRA	JLM 21470 , JLM 11717	
		DI	10.1997	05.2003	11.9601-9781.2	220991	PINZA DE GARRA	JLM 21470 , JLM 11717	



					Denominación	Ref. OE correspondientes a las referencias ATE	 Referencia anterior / varios
--	--	--	--	--	---------------------	---	---

JEEP

RENEGADE (BU) (14-)	1,4		07.2014		24.0128-0292.1	428292	DISCO DE FRENO	51963548 , 51937304	
	1,4 4x4		07.2014		24.0128-0292.1	428292	DISCO DE FRENO	51963548 , 51937304	
	1,6		07.2014		24.0128-0292.1	428292	DISCO DE FRENO	51963548 , 51937304	
	2,0 CRD 4x4		07.2014		24.0128-0292.1	428292	DISCO DE FRENO	51963548 , 51937304	

LANCIA

YPSILON / Chrysler Ypsilon (11-)	1,2		05.2011		24.3728-0536.2	590536	CABLE DE EMBRAGUE	1735312 , AS51-7K553-AA , 55226950	
	1,2 Bifuel		04.2015		24.3728-0536.2	590536	CABLE DE EMBRAGUE	1735312 , AS51-7K553-AA , 55226950	
			05.2011		24.3728-0536.2	590536	CABLE DE EMBRAGUE	1735312 , AS51-7K553-AA , 55226950	



Denominación

Ref. OE correspondientes a las referencias ATE

Referencia anterior / varios

MERCEDES BENZ

Clase E (S211) Break (03-09)	E 240 4-matic	DI	07.2003	10.2009	24.3601-9770.5	240696	PINZA DE GARRA	A 002 420 63 83 , 002 420 63 83	
		DD	07.2003	10.2009	24.3601-9769.5	240695	PINZA DE GARRA	A 002 420 64 83 , 002 420 64 83	
	E 280 4-matic	DI	05.2005	10.2009	24.3601-9770.5	240696	PINZA DE GARRA	A 002 420 63 83 , 002 420 63 83	
		DD	05.2005	10.2009	24.3601-9769.5	240695	PINZA DE GARRA	A 002 420 64 83 , 002 420 64 83	
	E 280 CDI 4-matic	DI	05.2005	10.2009	24.3601-9770.5	240696	PINZA DE GARRA	A 002 420 63 83 , 002 420 63 83	
		DD	05.2005	10.2009	24.3601-9769.5	240695	PINZA DE GARRA	A 002 420 64 83 , 002 420 64 83	
	E 320 4-matic	DI	07.2003	10.2009	24.3601-9770.5	240696	PINZA DE GARRA	A 002 420 63 83 , 002 420 63 83	
		DD	07.2003	10.2009	24.3601-9769.5	240695	PINZA DE GARRA	A 002 420 64 83 , 002 420 64 83	
	E 320 CDI 4-matic	DI	05.2005	10.2009	24.3601-9770.5	240696	PINZA DE GARRA	A 002 420 63 83 , 002 420 63 83	
		DD	05.2005	10.2009	24.3601-9769.5	240695	PINZA DE GARRA	A 002 420 64 83 , 002 420 64 83	
	E 350 4-matic	DI	12.2004	10.2009	24.3601-9770.5	240696	PINZA DE GARRA	A 002 420 63 83 , 002 420 63 83	
		DD	12.2004	10.2009	24.3601-9769.5	240695	PINZA DE GARRA	A 002 420 64 83 , 002 420 64 83	
	Clase E (W211) Berlina (02-09)	E 240 4-matic	DI	03.2003	02.2009	24.3601-9770.5	240696	PINZA DE GARRA	A 002 420 63 83 , 002 420 63 83
			DD	03.2003	02.2009	24.3601-9769.5	240695	PINZA DE GARRA	A 002 420 64 83 , 002 420 64 83



Denominación

Ref. OE correspondientes a las referencias ATE



Referencia anterior / varios

MERCEDES BENZ

Clase E (W211) Berlina (02-09)	E 280 4-matic	DI	05.2005	02.2009	24.3601-9770.5	240696	PINZA DE GARRA	A 002 420 63 83 , 002 420 63 83	
		DD	05.2005	02.2009	24.3601-9769.5	240695	PINZA DE GARRA	A 002 420 64 83 , 002 420 64 83	
	E 280 CDI 4-matic	DI	03.2005	02.2009	24.3601-9770.5	240696	PINZA DE GARRA	A 002 420 63 83 , 002 420 63 83	
		DD	03.2005	02.2009	24.3601-9769.5	240695	PINZA DE GARRA	A 002 420 64 83 , 002 420 64 83	
	E 320 4-matic	DI	03.2003	02.2009	24.3601-9770.5	240696	PINZA DE GARRA	A 002 420 63 83 , 002 420 63 83	
		DD	03.2003	02.2009	24.3601-9769.5	240695	PINZA DE GARRA	A 002 420 64 83 , 002 420 64 83	
	E 320 CDI 4-matic	DI	03.2005	02.2009	24.3601-9770.5	240696	PINZA DE GARRA	A 002 420 63 83 , 002 420 63 83	
		DD	03.2005	02.2009	24.3601-9769.5	240695	PINZA DE GARRA	A 002 420 64 83 , 002 420 64 83	
	E 350 4-matic	DI	12.2004	02.2009	24.3601-9770.5	240696	PINZA DE GARRA	A 002 420 63 83 , 002 420 63 83	
		DD	12.2004	02.2009	24.3601-9769.5	240695	PINZA DE GARRA	A 002 420 64 83 , 002 420 64 83	
Clase S (W220) (98-06)	S 350 4-matic	DI	06.2003	03.2006	24.3601-9770.5	240696	PINZA DE GARRA	A 002 420 63 83 , 002 420 63 83	
		DD	06.2003	03.2006	24.3601-9769.5	240695	PINZA DE GARRA	A 002 420 64 83 , 002 420 64 83	
Furgoneta (BM 901/902) SPRINTER (95-)	208 CDI	DI	04.2000	05.2006	24.3601-8514.5	240688	PINZA DE GARRA	2D0 615 124 , A 901 420 47 01 , A 901 420 42 01 , A 901 420 40 01 , A 002 420 61 83 , 901 420 47 01 , 002 420 61 83 , 901 420 42 01 , 901 420 40 01	11.3601-8514.2



Denominación

Ref. OE correspondientes a las referencias ATE



Referencia anterior / varios

MERCEDES BENZ

Furgoneta (BM 901/902) SPRINTER (95-)	208 D	DI	02.1995	05.2006	24.3601-8514.5	240688	PINZA DE GARRA	2D0 615 124 , A 901 420 47 01 , A 901 420 42 01 , A 901 420 40 01 , A 002 420 61 83 , 901 420 47 01 , 002 420 61 83 , 901 420 42 01 , 901 420 40 01	11.3601-8514.2
	210 D	DI	01.1997	05.2006	24.3601-8514.5	240688	PINZA DE GARRA	2D0 615 124 , A 901 420 47 01 , A 901 420 42 01 , A 901 420 40 01 , A 002 420 61 83 , 901 420 47 01 , 002 420 61 83 , 901 420 42 01 , 901 420 40 01	11.3601-8514.2
	211 CDI	DI	04.2000	05.2006	24.3601-8514.5	240688	PINZA DE GARRA	2D0 615 124 , A 901 420 47 01 , A 901 420 42 01 , A 901 420 40 01 , A 002 420 61 83 , 901 420 47 01 , 002 420 61 83 , 901 420 42 01 , 901 420 40 01	11.3601-8514.2
	212 D	DI	02.1995	05.2006	24.3601-8514.5	240688	PINZA DE GARRA	2D0 615 124 , A 901 420 47 01 , A 901 420 42 01 , A 901 420 40 01 , A 002 420 61 83 , 901 420 47 01 , 002 420 61 83 , 901 420 42 01 , 901 420 40 01	11.3601-8514.2
	213 CDI	DI	04.2000	05.2006	24.3601-8514.5	240688	PINZA DE GARRA	2D0 615 124 , A 901 420 47 01 , A 901 420 42 01 , A 901 420 40 01 , A 002 420 61 83 , 901 420 47 01 , 002 420 61 83 , 901 420 42 01 , 901 420 40 01	11.3601-8514.2
	214	DI	02.1995	05.2006	24.3601-8514.5	240688	PINZA DE GARRA	2D0 615 124 , A 901 420 47 01 , A 901 420 42 01 , A 901 420 40 01 , A 002 420 61 83 , 901 420 47 01 , 002 420 61 83 , 901 420 42 01 , 901 420 40 01	11.3601-8514.2



Denominación

Ref. OE correspondientes a las referencias ATE

Referencia anterior / varios

MERCEDES BENZ

Furgoneta (BM 901/902) SPRINTER (95-)	214	DI	04.2000	05.2006	24.3601-8514.5	240688	PINZA DE GARRA	2D0 615 124 , A 901 420 47 01 , A 901 420 42 01 , A 901 420 40 01 , A 002 420 61 83 , 901 420 47 01 , 002 420 61 83 , 901 420 42 01 , 901 420 40 01	11.3601-8514.2
	216 CDI	DI	04.2000	05.2006	24.3601-8514.5	240688	PINZA DE GARRA	2D0 615 124 , A 901 420 47 01 , A 901 420 42 01 , A 901 420 40 01 , A 002 420 61 83 , 901 420 47 01 , 002 420 61 83 , 901 420 42 01 , 901 420 40 01	11.3601-8514.2
Furgoneta (BM 903/904) SPRINTER (95-)	308 CDI	DI	04.2000	05.2006	24.3601-8514.5	240688	PINZA DE GARRA	2D0 615 124 , A 901 420 47 01 , A 901 420 42 01 , A 901 420 40 01 , A 002 420 61 83 , 901 420 47 01 , 002 420 61 83 , 901 420 42 01 , 901 420 40 01	11.3601-8514.2
	308 D	DI	02.1995	05.2006	24.3601-8514.5	240688	PINZA DE GARRA	2D0 615 124 , A 901 420 47 01 , A 901 420 42 01 , A 901 420 40 01 , A 002 420 61 83 , 901 420 47 01 , 002 420 61 83 , 901 420 42 01 , 901 420 40 01	11.3601-8514.2
	310 D	DI	02.1995	05.2006	24.3601-8514.5	240688	PINZA DE GARRA	2D0 615 124 , A 901 420 47 01 , A 901 420 42 01 , A 901 420 40 01 , A 002 420 61 83 , 901 420 47 01 , 002 420 61 83 , 901 420 42 01 , 901 420 40 01	11.3601-8514.2
	311 CDI	DI	04.2000	05.2006	24.3601-8514.5	240688	PINZA DE GARRA	2D0 615 124 , A 901 420 47 01 , A 901 420 42 01 , A 901 420 40 01 , A 002 420 61 83 , 901 420 47 01 , 002 420 61 83 , 901 420 42 01 , 901 420 40 01	11.3601-8514.2



Denominación

Ref. OE correspondientes a las referencias ATE

Referencia anterior / varios

MERCEDES BENZ

Furgoneta (BM 903/904) SPRINTER (95-)	312 D	DI	02.1995	05.2006	24.3601-8514.5	240688	PINZA DE GARRA	2D0 615 124 , A 901 420 47 01 , A 901 420 42 01 , A 901 420 40 01 , A 002 420 61 83 , 901 420 47 01 , 002 420 61 83 , 901 420 42 01 , 901 420 40 01	11.3601-8514.2
	313 CDI	DI	04.2000	05.2006	24.3601-8514.5	240688	PINZA DE GARRA	2D0 615 124 , A 901 420 47 01 , A 901 420 42 01 , A 901 420 40 01 , A 002 420 61 83 , 901 420 47 01 , 002 420 61 83 , 901 420 42 01 , 901 420 40 01	11.3601-8514.2
	314	DI	02.1995	05.2006	24.3601-8514.5	240688	PINZA DE GARRA	2D0 615 124 , A 901 420 47 01 , A 901 420 42 01 , A 901 420 40 01 , A 002 420 61 83 , 901 420 47 01 , 002 420 61 83 , 901 420 42 01 , 901 420 40 01	11.3601-8514.2
		DI	04.2000	05.2006	24.3601-8514.5	240688	PINZA DE GARRA	2D0 615 124 , A 901 420 47 01 , A 901 420 42 01 , A 901 420 40 01 , A 002 420 61 83 , 901 420 47 01 , 002 420 61 83 , 901 420 42 01 , 901 420 40 01	11.3601-8514.2
	316 CDI	DI	04.2000	05.2006	24.3601-8514.5	240688	PINZA DE GARRA	2D0 615 124 , A 901 420 47 01 , A 901 420 42 01 , A 901 420 40 01 , A 002 420 61 83 , 901 420 47 01 , 002 420 61 83 , 901 420 42 01 , 901 420 40 01	11.3601-8514.2
	408 CDI	DI	04.2000	05.2006	24.3601-8514.5	240688	PINZA DE GARRA	2D0 615 124 , A 901 420 47 01 , A 901 420 42 01 , A 901 420 40 01 , A 002 420 61 83 , 901 420 47 01 , 002 420 61 83 , 901 420 42 01 , 901 420 40 01	11.3601-8514.2



Denominación

Ref. OE correspondientes a las referencias ATE

Referencia anterior / varios

MERCEDES BENZ

Furgoneta (BM 903/904) SPRINTER (95-)	408 D	DI	06.1995	05.2006	24.3601-8514.5	240688	PINZA DE GARRA	2D0 615 124 , A 901 420 47 01 , A 901 420 42 01 , A 901 420 40 01 , A 002 420 61 83 , 901 420 47 01 , 002 420 61 83 , 901 420 42 01 , 901 420 40 01	11.3601-8514.2
	410 D	DI	09.1996	05.2006	24.3601-8514.5	240688	PINZA DE GARRA	2D0 615 124 , A 901 420 47 01 , A 901 420 42 01 , A 901 420 40 01 , A 002 420 61 83 , 901 420 47 01 , 002 420 61 83 , 901 420 42 01 , 901 420 40 01	11.3601-8514.2
	411 CDI	DI	04.2000	05.2006	24.3601-8514.5	240688	PINZA DE GARRA	2D0 615 124 , A 901 420 47 01 , A 901 420 42 01 , A 901 420 40 01 , A 002 420 61 83 , 901 420 47 01 , 002 420 61 83 , 901 420 42 01 , 901 420 40 01	11.3601-8514.2
	412 D	DI	06.1995	05.2006	24.3601-8514.5	240688	PINZA DE GARRA	2D0 615 124 , A 901 420 47 01 , A 901 420 42 01 , A 901 420 40 01 , A 002 420 61 83 , 901 420 47 01 , 002 420 61 83 , 901 420 42 01 , 901 420 40 01	11.3601-8514.2
	413 CDI	DI	04.2000	05.2006	24.3601-8514.5	240688	PINZA DE GARRA	2D0 615 124 , A 901 420 47 01 , A 901 420 42 01 , A 901 420 40 01 , A 002 420 61 83 , 901 420 47 01 , 002 420 61 83 , 901 420 42 01 , 901 420 40 01	11.3601-8514.2
	414	DI	04.2000	05.2006	24.3601-8514.5	240688	PINZA DE GARRA	2D0 615 124 , A 901 420 47 01 , A 901 420 42 01 , A 901 420 40 01 , A 002 420 61 83 , 901 420 47 01 , 002 420 61 83 , 901 420 42 01 , 901 420 40 01	11.3601-8514.2



Denominación

Ref. OE correspondientes a las referencias ATE

Referencia anterior / varios

MERCEDES BENZ

Furgoneta (BM 903/904) SPRINTER (95-)	414	DI	06.1995	05.2006	24.3601-8514.5	240688	PINZA DE GARRA	2D0 615 124 , A 901 420 47 01 , A 901 420 42 01 , A 901 420 40 01 , A 002 420 61 83 , 901 420 47 01 , 002 420 61 83 , 901 420 42 01 , 901 420 40 01	11.3601-8514.2
	416 CDI	DI	04.2000	05.2006	24.3601-8514.5	240688	PINZA DE GARRA	2D0 615 124 , A 901 420 47 01 , A 901 420 42 01 , A 901 420 40 01 , A 002 420 61 83 , 901 420 47 01 , 002 420 61 83 , 901 420 42 01 , 901 420 40 01	11.3601-8514.2
VITO (BM638) (96-03)	108 CDI	DI	03.1999	08.2003	24.3601-8514.5	240688	PINZA DE GARRA	2D0 615 124 , A 901 420 47 01 , A 901 420 42 01 , A 901 420 40 01 , A 002 420 61 83 , 901 420 47 01 , 002 420 61 83 , 901 420 42 01 , 901 420 40 01	11.3601-8514.2
	108 D	DI	03.1996	08.2003	24.3601-8514.5	240688	PINZA DE GARRA	2D0 615 124 , A 901 420 47 01 , A 901 420 42 01 , A 901 420 40 01 , A 002 420 61 83 , 901 420 47 01 , 002 420 61 83 , 901 420 42 01 , 901 420 40 01	11.3601-8514.2
	110 CDI	DI	03.1999	08.2003	24.3601-8514.5	240688	PINZA DE GARRA	2D0 615 124 , A 901 420 47 01 , A 901 420 42 01 , A 901 420 40 01 , A 002 420 61 83 , 901 420 47 01 , 002 420 61 83 , 901 420 42 01 , 901 420 40 01	11.3601-8514.2
	110 D	DI	03.1996	08.2003	24.3601-8514.5	240688	PINZA DE GARRA	2D0 615 124 , A 901 420 47 01 , A 901 420 42 01 , A 901 420 40 01 , A 002 420 61 83 , 901 420 47 01 , 002 420 61 83 , 901 420 42 01 , 901 420 40 01	11.3601-8514.2



Denominación

Ref. OE correspondientes a las referencias ATE

Referencia anterior / varios

MERCEDES BENZ

VITO (BM638) (96-03)	112 CDI	DI	03.1999	08.2003	24.3601-8514.5	240688	PINZA DE GARRA	2D0 615 124 , A 901 420 47 01 , A 901 420 42 01 , A 901 420 40 01 , A 002 420 61 83 , 901 420 47 01 , 002 420 61 83 , 901 420 42 01 , 901 420 40 01	11.3601-8514.2
	113	DI	03.1996	08.2003	24.3601-8514.5	240688	PINZA DE GARRA	2D0 615 124 , A 901 420 47 01 , A 901 420 42 01 , A 901 420 40 01 , A 002 420 61 83 , 901 420 47 01 , 002 420 61 83 , 901 420 42 01 , 901 420 40 01	11.3601-8514.2
	114	DI	12.1996	08.2003	24.3601-8514.5	240688	PINZA DE GARRA	2D0 615 124 , A 901 420 47 01 , A 901 420 42 01 , A 901 420 40 01 , A 002 420 61 83 , 901 420 47 01 , 002 420 61 83 , 901 420 42 01 , 901 420 40 01	11.3601-8514.2
Clase V (BM638) (96-03)	V 200	DI	09.1996	08.2003	24.3601-8514.5	240688	PINZA DE GARRA	2D0 615 124 , A 901 420 47 01 , A 901 420 42 01 , A 901 420 40 01 , A 002 420 61 83 , 901 420 47 01 , 002 420 61 83 , 901 420 42 01 , 901 420 40 01	11.3601-8514.2
	V 200 CDI	DI	03.1999	08.2003	24.3601-8514.5	240688	PINZA DE GARRA	2D0 615 124 , A 901 420 47 01 , A 901 420 42 01 , A 901 420 40 01 , A 002 420 61 83 , 901 420 47 01 , 002 420 61 83 , 901 420 42 01 , 901 420 40 01	11.3601-8514.2
	V 220 CDI	DI	03.1999	08.2003	24.3601-8514.5	240688	PINZA DE GARRA	2D0 615 124 , A 901 420 47 01 , A 901 420 42 01 , A 901 420 40 01 , A 002 420 61 83 , 901 420 47 01 , 002 420 61 83 , 901 420 42 01 , 901 420 40 01	11.3601-8514.2



Denominación

Ref. OE correspondientes a las referencias ATE

Referencia anterior / varios

MERCEDES BENZ

Clase V (BM638) (96-03)	V 230	DI	09.1996	08.2003	24.3601-8514.5	240688	PINZA DE GARRA	2D0 615 124 , A 901 420 47 01 , A 901 420 42 01 , A 901 420 40 01 , A 002 420 61 83 , 901 420 47 01 , 002 420 61 83 , 901 420 42 01 , 901 420 40 01	11.3601-8514.2
	V 230 TD	DI	09.1996	08.2003	24.3601-8514.5	240688	PINZA DE GARRA	2D0 615 124 , A 901 420 47 01 , A 901 420 42 01 , A 901 420 40 01 , A 002 420 61 83 , 901 420 47 01 , 002 420 61 83 , 901 420 42 01 , 901 420 40 01	11.3601-8514.2
	V 280	DI	09.1997	08.2003	24.3601-8514.5	240688	PINZA DE GARRA	2D0 615 124 , A 901 420 47 01 , A 901 420 42 01 , A 901 420 40 01 , A 002 420 61 83 , 901 420 47 01 , 002 420 61 83 , 901 420 42 01 , 901 420 40 01	11.3601-8514.2



Denominación

Ref. OE correspondientes a las referencias ATE

Referencia anterior / varios

MINI

F54 Clubman (15-)	One		11.2015		13.0470-2795.2	LD2795	CERAMIC PAST. DE FRENO	34 10 6 863 292 , 34 11 6 860 016	
	One D		11.2015		13.0470-2795.2	LD2795	CERAMIC PAST. DE FRENO	34 10 6 863 292 , 34 11 6 860 016	
F55 (14-)	Cooper		10.2014		13.0470-2795.2	LD2795	CERAMIC PAST. DE FRENO	34 10 6 863 292 , 34 11 6 860 016	
	Cooper D		10.2014		13.0470-2795.2	LD2795	CERAMIC PAST. DE FRENO	34 10 6 863 292 , 34 11 6 860 016	
	One		10.2014		13.0470-2795.2	LD2795	CERAMIC PAST. DE FRENO	34 10 6 863 292 , 34 11 6 860 016	
	One D		10.2014		13.0470-2795.2	LD2795	CERAMIC PAST. DE FRENO	34 10 6 863 292 , 34 11 6 860 016	
	One First		03.2015		13.0470-2795.2	LD2795	CERAMIC PAST. DE FRENO	34 10 6 863 292 , 34 11 6 860 016	
F56 (13-)	Cooper		11.2013		13.0470-2795.2	LD2795	CERAMIC PAST. DE FRENO	34 10 6 863 292 , 34 11 6 860 016	
	Cooper D		11.2013		13.0470-2795.2	LD2795	CERAMIC PAST. DE FRENO	34 10 6 863 292 , 34 11 6 860 016	
	One		06.2014		13.0470-2795.2	LD2795	CERAMIC PAST. DE FRENO	34 10 6 863 292 , 34 11 6 860 016	
			11.2013		13.0470-2795.2	LD2795	CERAMIC PAST. DE FRENO	34 10 6 863 292 , 34 11 6 860 016	
	One D		11.2013		13.0470-2795.2	LD2795	CERAMIC PAST. DE FRENO	34 10 6 863 292 , 34 11 6 860 016	
F57 Cabrio (15-)	Cooper		11.2015		13.0470-2795.2	LD2795	CERAMIC PAST. DE FRENO	34 10 6 863 292 , 34 11 6 860 016	
	Cooper D		11.2015		13.0470-2795.2	LD2795	CERAMIC PAST. DE FRENO	34 10 6 863 292 , 34 11 6 860 016	



					Denominación	Ref. OE correspondientes a las referencias ATE	 Referencia anterior / varios
---	---	---	--	---	---------------------	---	---

MINI

F57 Cabrio (15-)	One		03.2016		13.0470-2795.2	LD2795	CERAMIC PAST. DE FRENO	34 10 6 863 292 , 34 11 6 860 016	
------------------	-----	--	---------	--	----------------	--------	------------------------	-----------------------------------	--



Denominación

Ref. OE correspondientes a las referencias ATE

Referencia anterior / varios

PEUGEOT

Modelo	Motor	Fecha	Referencia ATE	Referencia OE	Denominación	Ref. OE correspondientes a las referencias ATE	Referencia anterior / varios
308 II (T9) (13-)	1,2 THP 110	11.2013	13.0460-3869.2	603869	PASTILLAS DE FRENO	16 106 992 80	ver figura
	1,2 THP 130	11.2013	13.0460-3869.2	603869	PASTILLAS DE FRENO	16 106 992 80	ver figura
	1,2 VTi 82	09.2013	13.0460-3869.2	603869	PASTILLAS DE FRENO	16 106 992 80	ver figura
	1,6 GT 205	06.2014	13.0460-3869.2	603869	PASTILLAS DE FRENO	16 106 992 80	ver figura
	1,6 GTi 250	08.2015	13.0460-3869.2	603869	PASTILLAS DE FRENO	16 106 992 80	ver figura
	1,6 GTi 270	06.2015	13.0460-3869.2	603869	PASTILLAS DE FRENO	16 106 992 80	ver figura
	1,6 HDi 100	04.2014	13.0460-3869.2	603869	PASTILLAS DE FRENO	16 106 992 80	ver figura
	1,6 HDi 115	09.2013	13.0460-3869.2	603869	PASTILLAS DE FRENO	16 106 992 80	ver figura
	1,6 HDi 120	11.2013	13.0460-3869.2	603869	PASTILLAS DE FRENO	16 106 992 80	ver figura
	1,6 HDi 92	09.2013	13.0460-3869.2	603869	PASTILLAS DE FRENO	16 106 992 80	ver figura
	1,6 THP 125	09.2013	13.0460-3869.2	603869	PASTILLAS DE FRENO	16 106 992 80	ver figura
	1,6 THP 150	03.2014	13.0460-3869.2	603869	PASTILLAS DE FRENO	16 106 992 80	ver figura
	1,6 THP 155	09.2013	13.0460-3869.2	603869	PASTILLAS DE FRENO	16 106 992 80	ver figura
	1,6 THP 163	06.2014	13.0460-3869.2	603869	PASTILLAS DE FRENO	16 106 992 80	ver figura
	1,6 VTi	03.2014	13.0460-3869.2	603869	PASTILLAS DE FRENO	16 106 992 80	ver figura
	2,0 GT HDi 180	06.2014	13.0460-3869.2	603869	PASTILLAS DE FRENO	16 106 992 80	ver figura
	2,0 HDi 150	11.2013	13.0460-3869.2	603869	PASTILLAS DE FRENO	16 106 992 80	ver figura
308 II SW (T9) (14-)	1,2 e-THP	03.2014	13.0460-3869.2	603869	PASTILLAS DE FRENO	16 106 992 80	ver figura
		08.2014	13.0460-3869.2	603869	PASTILLAS DE FRENO	16 106 992 80	ver figura
	1,6 BlueHDi	03.2014	13.0460-3869.2	603869	PASTILLAS DE FRENO	16 106 992 80	ver figura
	1,6 e-HDi	03.2014	13.0460-3869.2	603869	PASTILLAS DE FRENO	16 106 992 80	ver figura



					Denominación	Ref. OE correspondientes a las referencias ATE	Referencia anterior / varios
--	--	--	--	--	---------------------	---	-------------------------------------

PEUGEOT

Modelo	Motor	Fecha	Referencia ATE	Referencia OE	Denominación	Ref. OE correspondientes a las referencias ATE	Referencia anterior / varios
308 II SW (T9) (14-)	1,6 GT 205	06.2014	13.0460-3869.2	603869	PASTILLAS DE FRENO	16 106 992 80	ver figura
	1,6 HDi	03.2014	13.0460-3869.2	603869	PASTILLAS DE FRENO	16 106 992 80	ver figura
	1,6 THP	03.2014	13.0460-3869.2	603869	PASTILLAS DE FRENO	16 106 992 80	ver figura
	1,6 THP 125	03.2014	13.0460-3869.2	603869	PASTILLAS DE FRENO	16 106 992 80	ver figura
	1,6 THP 150	03.2014	13.0460-3869.2	603869	PASTILLAS DE FRENO	16 106 992 80	ver figura
	1,6 THP 163	06.2014	13.0460-3869.2	603869	PASTILLAS DE FRENO	16 106 992 80	ver figura
	1,6 VTi	03.2014	13.0460-3869.2	603869	PASTILLAS DE FRENO	16 106 992 80	ver figura
	2,0 BlueHDi	03.2014	13.0460-3869.2	603869	PASTILLAS DE FRENO	16 106 992 80	ver figura
	2,0 BlueHDi 180	06.2014	13.0460-3869.2	603869	PASTILLAS DE FRENO	16 106 992 80	ver figura
	2,0 GT HDi 180	06.2014	13.0460-3869.2	603869	PASTILLAS DE FRENO	16 106 992 80	ver figura



Denominación

Ref. OE correspondientes a las referencias ATE



Referencia anterior / varios

RENAULT

LOGAN II (L52) (13-)	1,2		11.2013		24.5201-0280.3	331569	LATIGUILLO	46 21 072 11R	
	1,5 dCi		12.2013		24.5201-0280.3	331569	LATIGUILLO	46 21 072 11R	
	1,6		04.2014		24.5201-0280.3	331569	LATIGUILLO	46 21 072 11R	
LOGAN II Kombi (L52) (13-)	1,2 16V		12.2013		24.5201-0280.3	331569	LATIGUILLO	46 21 072 11R	
	1,2 16V LPG		12.2013		24.5201-0280.3	331569	LATIGUILLO	46 21 072 11R	
	1,5 dCi		12.2013		24.5201-0280.3	331569	LATIGUILLO	46 21 072 11R	
	1,6		12.2013		24.5201-0280.3	331569	LATIGUILLO	46 21 072 11R	
SANDERO II (13-)	1,2 16V		12.2013		24.5201-0280.3	331569	LATIGUILLO	46 21 072 11R	
	1,2 16V LPG		12.2013		24.5201-0280.3	331569	LATIGUILLO	46 21 072 11R	
	1,5 dCi		12.2013		24.5201-0280.3	331569	LATIGUILLO	46 21 072 11R	
	1,6		04.2014		24.5201-0280.3	331569	LATIGUILLO	46 21 072 11R	
			11.2013		24.5201-0280.3	331569	LATIGUILLO	46 21 072 11R	
THALIA III / SYMBOL (L8_) (13-)	0,9 TCe		11.2012		24.5201-0280.3	331569	LATIGUILLO	46 21 072 11R	
	1,2 16V		12.2013		24.5201-0280.3	331569	LATIGUILLO	46 21 072 11R	
	1,5 dCi		12.2013		24.5201-0280.3	331569	LATIGUILLO	46 21 072 11R	



Denominación

Ref. OE correspondientes a las referencias ATE

Referencia anterior / varios

SEAT

Modelo	Motor	TI	Desde	Hasta	Ref. ATE	Ref. OE	Denominación	Ref. OE correspondientes a las referencias ATE	Referencia anterior / varios
ALTEA (5P1) (04-15)	1,2 TSI		04.2010		24.9145-0001.2	399005	HYDRAULIC CONTROL UNI	1K0 698 517 B	
	1,4 i 16V		05.2006		24.9145-0001.2	399005	HYDRAULIC CONTROL UNI	1K0 698 517 B	
	1,4 TSI		11.2007		24.9145-0001.2	399005	HYDRAULIC CONTROL UNI	1K0 698 517 B	
	1,6 i 16V		03.2004		24.9145-0001.2	399005	HYDRAULIC CONTROL UNI	1K0 698 517 B	
	1,6 LPG		09.2009		24.9145-0001.2	399005	HYDRAULIC CONTROL UNI	1K0 698 517 B	
	1,6 TDI		10.2009		24.9145-0001.2	399005	HYDRAULIC CONTROL UNI	1K0 698 517 B	
	1,8 TFSI		01.2007		24.9145-0001.2	399005	HYDRAULIC CONTROL UNI	1K0 698 517 B	
	1,9 TDI		03.2004		24.9145-0001.2	399005	HYDRAULIC CONTROL UNI	1K0 698 517 B	
	2,0 FSI		03.2004		24.9145-0001.2	399005	HYDRAULIC CONTROL UNI	1K0 698 517 B	
	2,0 TDI		03.2006		24.9145-0001.2	399005	HYDRAULIC CONTROL UNI	1K0 698 517 B	
			03.2004		24.9145-0001.2	399005	HYDRAULIC CONTROL UNI	1K0 698 517 B	
	2,0 TFSI		03.2006		24.9145-0001.2	399005	HYDRAULIC CONTROL UNI	1K0 698 517 B	
CORDOBA III (6L2) (02-09)	1,2 i	TI	10.2002	06.2009	24.3344-1709.5	240810	PINZA DE GARRA	6Q0 615 423 B , 6Q0 615 423 A	24.3344-1709.7
	1,4 i 16V	TI	10.2002	06.2009	24.3344-1709.5	240810	PINZA DE GARRA	6Q0 615 423 B , 6Q0 615 423 A	24.3344-1709.7
	1,4 TDI	TI	10.2002	06.2009	24.3344-1709.5	240810	PINZA DE GARRA	6Q0 615 423 B , 6Q0 615 423 A	24.3344-1709.7
	1,6 i 16V	TI	02.2003	06.2009	24.3344-1709.5	240810	PINZA DE GARRA	6Q0 615 423 B , 6Q0 615 423 A	24.3344-1709.7
	1,9 SDI	TI	10.2002	06.2009	24.3344-1709.5	240810	PINZA DE GARRA	6Q0 615 423 B , 6Q0 615 423 A	24.3344-1709.7
	1,9 TDI	TI	10.2002	06.2009	24.3344-1709.5	240810	PINZA DE GARRA	6Q0 615 423 B , 6Q0 615 423 A	24.3344-1709.7



Denominación

Ref. OE correspondientes a las referencias ATE



Referencia anterior / varios

SEAT

Modelo	Motor	TI	10.2002	06.2009	24.3344-1709.5	240810	Denominación	Ref. OE correspondientes a las referencias ATE	Referencia anterior / varios
CORDOBA III (6L2) (02-09)	2,0 i 16V	TI	10.2002	06.2009	24.3344-1709.5	240810	PINZA DE GARRA	6Q0 615 423 B , 6Q0 615 423 A	24.3344-1709.7
EXEO / ST (09-13)	1,6		04.2009	06.2013	11.0230-0807.1	260134	CALIPER MOUNT. BRACKET	4F0 615 125	
	1,8 T		04.2009	06.2013	11.0230-0807.1	260134	CALIPER MOUNT. BRACKET	4F0 615 125	
	1,8 TSI		09.2010	06.2013	11.0230-0807.1	260134	CALIPER MOUNT. BRACKET	4F0 615 125	
			05.2010	06.2013	11.0230-0807.1	260134	CALIPER MOUNT. BRACKET	4F0 615 125	
	2,0 TDI		04.2009	06.2013	11.0230-0807.1	260134	CALIPER MOUNT. BRACKET	4F0 615 125	
	2,0 TFSI		04.2009	06.2013	11.0230-0807.1	260134	CALIPER MOUNT. BRACKET	4F0 615 125	
IBIZA IV (6L1) (02-10)	1,2	TI	06.2007	05.2008	24.3344-1709.5	240810	PINZA DE GARRA	6Q0 615 423 B , 6Q0 615 423 A	24.3344-1709.7
	1,2 i	TI	02.2002	02.2010	24.3344-1709.5	240810	PINZA DE GARRA	6Q0 615 423 B , 6Q0 615 423 A	24.3344-1709.7
	1,2 i 12V	TI	05.2006	02.2010	24.3344-1709.5	240810	PINZA DE GARRA	6Q0 615 423 B , 6Q0 615 423 A	24.3344-1709.7
	1,4 i 16V	TI	05.2006	02.2010	24.3344-1709.5	240810	PINZA DE GARRA	6Q0 615 423 B , 6Q0 615 423 A	24.3344-1709.7
		TI	02.2002	02.2010	24.3344-1709.5	240810	PINZA DE GARRA	6Q0 615 423 B , 6Q0 615 423 A	24.3344-1709.7
	1,4 TDI	TI	05.2005	02.2010	24.3344-1709.5	240810	PINZA DE GARRA	6Q0 615 423 B , 6Q0 615 423 A	24.3344-1709.7
		TI	02.2002	02.2010	24.3344-1709.5	240810	PINZA DE GARRA	6Q0 615 423 B , 6Q0 615 423 A	24.3344-1709.7
	1,6 i 16V	TI	02.2003	02.2010	24.3344-1709.5	240810	PINZA DE GARRA	6Q0 615 423 B , 6Q0 615 423 A	24.3344-1709.7
	1,8 T Cupra R	TI	01.2004	02.2010	24.3344-1709.5	240810	PINZA DE GARRA	6Q0 615 423 B , 6Q0 615 423 A	24.3344-1709.7



Denominación

Ref. OE correspondientes a las referencias ATE

Referencia anterior / varios

SEAT

Modelo	Motor	TI	12.2003	02.2010	24.3344-1709.5	240810	Denominación	Ref. OE correspondientes a las referencias ATE	Referencia anterior / varios
IBIZA IV (6L1) (02-10)	1,8 T FR	TI	12.2003	02.2010	24.3344-1709.5	240810	PINZA DE GARRA	6Q0 615 423 B , 6Q0 615 423 A	24.3344-1709.7
	1,9 SDI	TI	02.2002	02.2010	24.3344-1709.5	240810	PINZA DE GARRA	6Q0 615 423 B , 6Q0 615 423 A	24.3344-1709.7
	1,9 TDI	TI	02.2002	02.2010	24.3344-1709.5	240810	PINZA DE GARRA	6Q0 615 423 B , 6Q0 615 423 A	24.3344-1709.7
	1,9 TDI Cupra R	TI	03.2004	02.2008	24.3344-1709.5	240810	PINZA DE GARRA	6Q0 615 423 B , 6Q0 615 423 A	24.3344-1709.7
	2	TI	04.2002	02.2010	24.3344-1709.5	240810	PINZA DE GARRA	6Q0 615 423 B , 6Q0 615 423 A	24.3344-1709.7
IBIZA V (6J/6P) / ST / SC (08-17)	1,4 TSI	TI	06.2009		24.3344-1709.5	240810	PINZA DE GARRA	6Q0 615 423 B , 6Q0 615 423 A	24.3344-1709.7
	1,4 TSI FR	TI	12.2013		24.3344-1709.5	240810	PINZA DE GARRA	6Q0 615 423 B , 6Q0 615 423 A	24.3344-1709.7
LEON II (1P1) (05-12)	1,2 TSI		02.2010	10.2012	24.9145-0001.2	399005	HYDRAULIC CONTROL UNI	1K0 698 517 B	
	1,4 i 16V		06.2006	10.2012	24.9145-0001.2	399005	HYDRAULIC CONTROL UNI	1K0 698 517 B	
	1,4 TSI		11.2007	10.2012	24.9145-0001.2	399005	HYDRAULIC CONTROL UNI	1K0 698 517 B	
	1,6 i		08.2005	10.2012	24.9145-0001.2	399005	HYDRAULIC CONTROL UNI	1K0 698 517 B	
	1,6 LPG / Multifuel		12.2009	10.2012	24.9145-0001.2	399005	HYDRAULIC CONTROL UNI	1K0 698 517 B	
	1,6 TDI		11.2010	10.2012	24.9145-0001.2	399005	HYDRAULIC CONTROL UNI	1K0 698 517 B	
	1,6 TDI Ecomotive		02.2010	10.2012	24.9145-0001.2	399005	HYDRAULIC CONTROL UNI	1K0 698 517 B	
	1,8 TSI		06.2007	10.2012	24.9145-0001.2	399005	HYDRAULIC CONTROL UNI	1K0 698 517 B	
	1,9 TDI		08.2005	10.2012	24.9145-0001.2	399005	HYDRAULIC CONTROL UNI	1K0 698 517 B	
	2,0 Cupra R		11.2006	10.2012	24.9145-0001.2	399005	HYDRAULIC CONTROL UNI	1K0 698 517 B	
	2,0 FSI		08.2005	10.2012	24.9145-0001.2	399005	HYDRAULIC CONTROL UNI	1K0 698 517 B	



Denominación

Ref. OE correspondientes a las referencias ATE



Referencia anterior / varios

SEAT

Modelo	Motor	Fecha inicio	Fecha fin	Ref. ATE	Ref. OE	Denominación	Ref. OE correspondientes a las referencias ATE	Referencia anterior / varios
LEON II (1P1) (05-12)	2,0 TDI	02.2006	10.2012	24.9145-0001.2	399005	HYDRAULIC CONTROL UNI	1K0 698 517 B	
		08.2005	10.2012	24.9145-0001.2	399005	HYDRAULIC CONTROL UNI	1K0 698 517 B	
	2,0 TFSI	08.2005	10.2012	24.9145-0001.2	399005	HYDRAULIC CONTROL UNI	1K0 698 517 B	
		09.2005	10.2012	24.9145-0001.2	399005	HYDRAULIC CONTROL UNI	1K0 698 517 B	
		11.2006	10.2012	24.9145-0001.2	399005	HYDRAULIC CONTROL UNI	1K0 698 517 B	
TOLEDO III (5P2) (05-09)	1,4 16V	05.2006	03.2009	24.9145-0001.2	399005	HYDRAULIC CONTROL UNI	1K0 698 517 B	
		11.2007	03.2009	24.9145-0001.2	399005	HYDRAULIC CONTROL UNI	1K0 698 517 B	
	1,6 i 16V	10.2004	03.2009	24.9145-0001.2	399005	HYDRAULIC CONTROL UNI	1K0 698 517 B	
	1,8 TFSI	01.2007	03.2009	24.9145-0001.2	399005	HYDRAULIC CONTROL UNI	1K0 698 517 B	
	1,9 TDI	10.2004	03.2009	24.9145-0001.2	399005	HYDRAULIC CONTROL UNI	1K0 698 517 B	
	2,0 FSI	10.2004	03.2009	24.9145-0001.2	399005	HYDRAULIC CONTROL UNI	1K0 698 517 B	
	2,0 TDI	01.2006	03.2009	24.9145-0001.2	399005	HYDRAULIC CONTROL UNI	1K0 698 517 B	
		10.2004	03.2009	24.9145-0001.2	399005	HYDRAULIC CONTROL UNI	1K0 698 517 B	
	2,0 TFSI	11.2005	03.2009	24.9145-0001.2	399005	HYDRAULIC CONTROL UNI	1K0 698 517 B	



Denominación

Ref. OE correspondientes a las referencias ATE



Referencia anterior / varios

SKODA

OCTAVIA II (1Z) (04-13)	1,4 i 16V	06.2004	12.2008	24.9145-0001.2	399005	HYDRAULIC CONTROL UNI	1K0 698 517 B
	1,4 TSI	11.2008	12.2008	24.9145-0001.2	399005	HYDRAULIC CONTROL UNI	1K0 698 517 B
	1,6 FSI	06.2004	12.2008	24.9145-0001.2	399005	HYDRAULIC CONTROL UNI	1K0 698 517 B
	1,6 i 16V	06.2004	12.2008	24.9145-0001.2	399005	HYDRAULIC CONTROL UNI	1K0 698 517 B
	1,8 TSI	06.2007	12.2008	24.9145-0001.2	399005	HYDRAULIC CONTROL UNI	1K0 698 517 B
	1,8 TSI 4x4	11.2008	12.2008	24.9145-0001.2	399005	HYDRAULIC CONTROL UNI	1K0 698 517 B
	1,9 TDI	06.2004	12.2008	24.9145-0001.2	399005	HYDRAULIC CONTROL UNI	1K0 698 517 B
	1,9 TDI 4x4	11.2004	12.2008	24.9145-0001.2	399005	HYDRAULIC CONTROL UNI	1K0 698 517 B
	2,0 FSI	11.2004	12.2008	24.9145-0001.2	399005	HYDRAULIC CONTROL UNI	1K0 698 517 B
	2,0 FSI 4x4	11.2004	12.2008	24.9145-0001.2	399005	HYDRAULIC CONTROL UNI	1K0 698 517 B
	2,0 RS	10.2005	12.2008	24.9145-0001.2	399005	HYDRAULIC CONTROL UNI	1K0 698 517 B
	2,0 TDI	06.2004	12.2008	24.9145-0001.2	399005	HYDRAULIC CONTROL UNI	1K0 698 517 B
	2,0 TDI 4x4	07.2006	12.2008	24.9145-0001.2	399005	HYDRAULIC CONTROL UNI	1K0 698 517 B
	2,0 TDI RS	04.2006	12.2008	24.9145-0001.2	399005	HYDRAULIC CONTROL UNI	1K0 698 517 B
OCTAVIA III (5E) (12-)	1,0 TSI	05.2016		13.0470-2621.2	LD2621	CERAMIC PAST. DE FRENO	3C0 698 451 C , 1K0 698 451 K , 1K0 698 451 E , 3C0 698 451 A , 1K0 698 451 B
	1,2 TSI	02.2013		13.0470-2621.2	LD2621	CERAMIC PAST. DE FRENO	3C0 698 451 C , 1K0 698 451 K , 1K0 698 451 E , 3C0 698 451 A , 1K0 698 451 B
		05.2015		13.0470-2621.2	LD2621	CERAMIC PAST. DE FRENO	3C0 698 451 C , 1K0 698 451 K , 1K0 698 451 E , 3C0 698 451 A , 1K0 698 451 B



Denominación

Ref. OE correspondientes a las referencias ATE

Referencia anterior / varios

SKODA

OCTAVIA III (5E) (12-)	1,4 TSI		05.2015		13.0470-2621.2	LD2621	CERAMIC PAST. DE FRENO	3C0 698 451 C , 1K0 698 451 K , 1K0 698 451 E , 3C0 698 451 A , 1K0 698 451 B	
			11.2012		13.0470-2621.2	LD2621	CERAMIC PAST. DE FRENO	3C0 698 451 C , 1K0 698 451 K , 1K0 698 451 E , 3C0 698 451 A , 1K0 698 451 B	
	1,4 TSI G-TEC		11.2013		13.0470-2621.2	LD2621	CERAMIC PAST. DE FRENO	3C0 698 451 C , 1K0 698 451 K , 1K0 698 451 E , 3C0 698 451 A , 1K0 698 451 B	
	1,6		01.2014		13.0470-2621.2	LD2621	CERAMIC PAST. DE FRENO	3C0 698 451 C , 1K0 698 451 K , 1K0 698 451 E , 3C0 698 451 A , 1K0 698 451 B	
	1,6 TDI		02.2017		13.0470-2621.2	LD2621	CERAMIC PAST. DE FRENO	3C0 698 451 C , 1K0 698 451 K , 1K0 698 451 E , 3C0 698 451 A , 1K0 698 451 B	
			02.2013		13.0470-2621.2	LD2621	CERAMIC PAST. DE FRENO	3C0 698 451 C , 1K0 698 451 K , 1K0 698 451 E , 3C0 698 451 A , 1K0 698 451 B	
	1,6 TDI 4x4		05.2015		13.0470-2621.2	LD2621	CERAMIC PAST. DE FRENO	3C0 698 451 C , 1K0 698 451 K , 1K0 698 451 E , 3C0 698 451 A , 1K0 698 451 B	
			11.2012		13.0470-2621.2	LD2621	CERAMIC PAST. DE FRENO	3C0 698 451 C , 1K0 698 451 K , 1K0 698 451 E , 3C0 698 451 A , 1K0 698 451 B	
	1,8 TSI		11.2012		13.0470-2621.2	LD2621	CERAMIC PAST. DE FRENO	3C0 698 451 C , 1K0 698 451 K , 1K0 698 451 E , 3C0 698 451 A , 1K0 698 451 B	
	1,8 TSI 4x4		11.2012		13.0470-2621.2	LD2621	CERAMIC PAST. DE FRENO	3C0 698 451 C , 1K0 698 451 K , 1K0 698 451 E , 3C0 698 451 A , 1K0 698 451 B	
	2,0 TDI		11.2012		13.0470-2621.2	LD2621	CERAMIC PAST. DE FRENO	3C0 698 451 C , 1K0 698 451 K , 1K0 698 451 E , 3C0 698 451 A , 1K0 698 451 B	



Denominación

Ref. OE correspondientes a las referencias ATE



Referencia anterior / varios

SKODA

OCTAVIA III (5E) (12-)	2,0 TDI		05.2013		13.0470-2621.2	LD2621	CERAMIC PAST. DE FRENO	3C0 698 451 C , 1K0 698 451 K , 1K0 698 451 E , 3C0 698 451 A , 1K0 698 451 B	
			02.2013		13.0470-2621.2	LD2621	CERAMIC PAST. DE FRENO	3C0 698 451 C , 1K0 698 451 K , 1K0 698 451 E , 3C0 698 451 A , 1K0 698 451 B	
	2,0 TDI 4x4		09.2014		13.0470-2621.2	LD2621	CERAMIC PAST. DE FRENO	3C0 698 451 C , 1K0 698 451 K , 1K0 698 451 E , 3C0 698 451 A , 1K0 698 451 B	
			11.2012		13.0470-2621.2	LD2621	CERAMIC PAST. DE FRENO	3C0 698 451 C , 1K0 698 451 K , 1K0 698 451 E , 3C0 698 451 A , 1K0 698 451 B	
	2,0 TSI RS		02.2017		13.0470-2621.2	LD2621	CERAMIC PAST. DE FRENO	3C0 698 451 C , 1K0 698 451 K , 1K0 698 451 E , 3C0 698 451 A , 1K0 698 451 B	
			05.2013		13.0470-2621.2	LD2621	CERAMIC PAST. DE FRENO	3C0 698 451 C , 1K0 698 451 K , 1K0 698 451 E , 3C0 698 451 A , 1K0 698 451 B	
			05.2015		13.0470-2621.2	LD2621	CERAMIC PAST. DE FRENO	3C0 698 451 C , 1K0 698 451 K , 1K0 698 451 E , 3C0 698 451 A , 1K0 698 451 B	
SUPERB II (08-15)	1,4 TSI		08.2008	02.2015	11.0230-0663.1	260131	CALIPER MOUNT. BRACKET	1K0 615 125 B	
	1,6 TDI		09.2010	02.2015	11.0230-0663.1	260131	CALIPER MOUNT. BRACKET	1K0 615 125 B	
	1,8 TFSI		08.2008	02.2015	11.0230-0663.1	260131	CALIPER MOUNT. BRACKET	1K0 615 125 B	
	1,8 TSI 4x4		10.2008	02.2015	11.0230-0663.1	260131	CALIPER MOUNT. BRACKET	1K0 615 125 B	
	1,9 TDI		08.2008	02.2015	11.0230-0663.1	260131	CALIPER MOUNT. BRACKET	1K0 615 125 B	
	2,0 TDI		08.2008	02.2015	11.0230-0663.1	260131	CALIPER MOUNT. BRACKET	1K0 615 125 B	
	2,0 TDI 4x4		10.2008	02.2015	11.0230-0663.1	260131	CALIPER MOUNT. BRACKET	1K0 615 125 B	
	2,0 TSI		05.2010	02.2015	11.0230-0663.1	260131	CALIPER MOUNT. BRACKET	1K0 615 125 B	



				Denominación	Ref. OE correspondientes a las referencias ATE	 Referencia anterior / varios
--	--	--	--	---------------------	---	---

SKODA

Modelo	Motor	Fecha 1	Fecha 2	Ref. 1	Ref. 2	Denominación	Ref. OE correspondientes a las referencias ATE	Referencia anterior / varios
SUPERB II (08-15)	3,6 FSI V6 4x4	11.2008	02.2015	11.0230-0663.1	260131	CALIPER MOUNT. BRACKET	1K0 615 125 B	
SUPERB II Combi (09-15)	1,4 TSI	11.2009	02.2015	11.0230-0663.1	260131	CALIPER MOUNT. BRACKET	1K0 615 125 B	
	1,6 TDI	09.2010	02.2015	11.0230-0663.1	260131	CALIPER MOUNT. BRACKET	1K0 615 125 B	
	1,8 TSI	11.2009	02.2015	11.0230-0663.1	260131	CALIPER MOUNT. BRACKET	1K0 615 125 B	
	1,8 TSI 4x4	11.2009	02.2015	11.0230-0663.1	260131	CALIPER MOUNT. BRACKET	1K0 615 125 B	
	1,9 TDI	10.2009	02.2015	11.0230-0663.1	260131	CALIPER MOUNT. BRACKET	1K0 615 125 B	
	2,0 TDI	11.2009	02.2015	11.0230-0663.1	260131	CALIPER MOUNT. BRACKET	1K0 615 125 B	
	2,0 TDI 4x4	11.2009	02.2015	11.0230-0663.1	260131	CALIPER MOUNT. BRACKET	1K0 615 125 B	
	2,0 TSI	05.2010	02.2015	11.0230-0663.1	260131	CALIPER MOUNT. BRACKET	1K0 615 125 B	
	3,6 V6 4x4	11.2009	02.2015	11.0230-0663.1	260131	CALIPER MOUNT. BRACKET	1K0 615 125 B	



Denominación

Ref. OE correspondientes a las referencias ATE



Referencia anterior / varios

VOLKSWAGEN

Modelo	Motor	Fecha 1	Fecha 2	Código 1	Código 2	Denominación	Ref. OE
AMAROK (10-)	2,0 BiTDI	11.2011		03.2126-5132.3	011012	TANDEM MASTER CYLINDE	2H0 611 019
		09.2010		03.2126-5132.3	011012	TANDEM MASTER CYLINDE	2H0 611 019
	2,0 BiTDI 4motion	09.2010		03.2126-5132.3	011012	TANDEM MASTER CYLINDE	2H0 611 019
	2,0 TDI	07.2012		03.2126-5132.3	011012	TANDEM MASTER CYLINDE	2H0 611 019
		09.2010		03.2126-5132.3	011012	TANDEM MASTER CYLINDE	2H0 611 019
	2,0 TDI 4motion	06.2012		03.2126-5132.3	011012	TANDEM MASTER CYLINDE	2H0 611 019
		09.2010		03.2126-5132.3	011012	TANDEM MASTER CYLINDE	2H0 611 019
		11.2011		03.2126-5132.3	011012	TANDEM MASTER CYLINDE	2H0 611 019
	2,0 TSI	12.2010		03.2126-5132.3	011012	TANDEM MASTER CYLINDE	2H0 611 019
	3,0 TDI 4motion	09.2016		03.2126-5132.3	011012	TANDEM MASTER CYLINDE	2H0 611 019
	06.2016		03.2126-5132.3	011012	TANDEM MASTER CYLINDE	2H0 611 019	
CADDY III (04-15)	1,2 TSI	09.2010	12.2010	24.9145-0001.2	399005	HYDRAULIC CONTROL UNI	1K0 698 517 B
	1,4	02.2004	12.2010	24.9145-0001.2	399005	HYDRAULIC CONTROL UNI	1K0 698 517 B
	1,4 16V	05.2006	12.2010	24.9145-0001.2	399005	HYDRAULIC CONTROL UNI	1K0 698 517 B
	1,6	04.2004	12.2010	24.9145-0001.2	399005	HYDRAULIC CONTROL UNI	1K0 698 517 B
	1,6 TDI	08.2010	12.2010	24.9145-0001.2	399005	HYDRAULIC CONTROL UNI	1K0 698 517 B
	1,9 TDI	09.2005	12.2010	24.9145-0001.2	399005	HYDRAULIC CONTROL UNI	1K0 698 517 B
		02.2004	12.2010	24.9145-0001.2	399005	HYDRAULIC CONTROL UNI	1K0 698 517 B
	1,9 TDI 4motion	05.2008	12.2010	24.9145-0001.2	399005	HYDRAULIC CONTROL UNI	1K0 698 517 B
	2,0 Eco Fuel	04.2006	12.2010	24.9145-0001.2	399005	HYDRAULIC CONTROL UNI	1K0 698 517 B
	2,0 SDI	02.2004	12.2010	24.9145-0001.2	399005	HYDRAULIC CONTROL UNI	1K0 698 517 B



Denominación

Ref. OE correspondientes a las referencias ATE



Referencia anterior / varios

VOLKSWAGEN

Modelo	Motor	Fecha 1	Fecha 2	Ref. 1	Ref. 2	Denominación	Ref. OE correspondientes a las referencias ATE	
CADDY III (04-15)	2,0 TDI	09.2007	12.2010	24.9145-0001.2	399005	HYDRAULIC CONTROL UNI	1K0 698 517 B	
		10.2010	12.2010	24.9145-0001.2	399005	HYDRAULIC CONTROL UNI	1K0 698 517 B	
	2,0 TDI 4motion	10.2010	12.2010	24.9145-0001.2	399005	HYDRAULIC CONTROL UNI	1K0 698 517 B	
EOS (06-)	1,4 TSI	05.2008		11.0230-0663.1	260131	CALIPER MOUNT. BRACKET	1K0 615 125 B	
		10.2007		11.0230-0663.1	260131	CALIPER MOUNT. BRACKET	1K0 615 125 B	
		10.2007	12.2008	24.9145-0001.2	399005	HYDRAULIC CONTROL UNI	1K0 698 517 B	
		05.2008	12.2008	24.9145-0001.2	399005	HYDRAULIC CONTROL UNI	1K0 698 517 B	
		1,6 FSI	05.2006		11.0230-0663.1	260131	CALIPER MOUNT. BRACKET	1K0 615 125 B
			05.2006	12.2008	24.9145-0001.2	399005	HYDRAULIC CONTROL UNI	1K0 698 517 B
	2,0 FSI	05.2006		11.0230-0663.1	260131	CALIPER MOUNT. BRACKET	1K0 615 125 B	
		05.2006	12.2008	24.9145-0001.2	399005	HYDRAULIC CONTROL UNI	1K0 698 517 B	
	2,0 TDI	11.2010		11.0230-0663.1	260131	CALIPER MOUNT. BRACKET	1K0 615 125 B	
		05.2006		11.0230-0663.1	260131	CALIPER MOUNT. BRACKET	1K0 615 125 B	
		05.2006	12.2008	24.9145-0001.2	399005	HYDRAULIC CONTROL UNI	1K0 698 517 B	
	2,0 TDI 16V	05.2008		11.0230-0663.1	260131	CALIPER MOUNT. BRACKET	1K0 615 125 B	
		05.2008	12.2008	24.9145-0001.2	399005	HYDRAULIC CONTROL UNI	1K0 698 517 B	
	2,0 TFSI	05.2006		11.0230-0663.1	260131	CALIPER MOUNT. BRACKET	1K0 615 125 B	
		05.2006	12.2008	24.9145-0001.2	399005	HYDRAULIC CONTROL UNI	1K0 698 517 B	
	2,0 TSI	11.2009		11.0230-0663.1	260131	CALIPER MOUNT. BRACKET	1K0 615 125 B	
	3,2 V6	05.2006		11.0230-0663.1	260131	CALIPER MOUNT. BRACKET	1K0 615 125 B	
		05.2006	12.2008	24.9145-0001.2	399005	HYDRAULIC CONTROL UNI	1K0 698 517 B	



Denominación

Ref. OE correspondientes a las referencias ATE



Referencia anterior / varios

VOLKSWAGEN

Modelo	Motor	Fecha 1	Fecha 2	Ref. 1	Ref. 2	Denominación	Ref. OE correspondientes a las referencias ATE	Referencia anterior / varios
EOS (06-)	3,6 V6	05.2009		11.0230-0663.1	260131	CALIPER MOUNT. BRACKET	1K0 615 125 B	
GOLF Plus (05-14)	1,4 16V	01.2005	12.2008	24.9145-0001.2	399005	HYDRAULIC CONTROL UNI	1K0 698 517 B	
	1,4 FSI	07.2005	12.2008	24.9145-0001.2	399005	HYDRAULIC CONTROL UNI	1K0 698 517 B	
	1,4 TSI	06.2008	12.2008	24.9145-0001.2	399005	HYDRAULIC CONTROL UNI	1K0 698 517 B	
		05.2006	12.2008	24.9145-0001.2	399005	HYDRAULIC CONTROL UNI	1K0 698 517 B	
		06.2007	12.2008	24.9145-0001.2	399005	HYDRAULIC CONTROL UNI	1K0 698 517 B	
	1,6	05.2005	12.2008	24.9145-0001.2	399005	HYDRAULIC CONTROL UNI	1K0 698 517 B	
	1,6 FSI	01.2005	12.2008	24.9145-0001.2	399005	HYDRAULIC CONTROL UNI	1K0 698 517 B	
	1,9 TDI	01.2005	12.2008	24.9145-0001.2	399005	HYDRAULIC CONTROL UNI	1K0 698 517 B	
		05.2005	12.2008	24.9145-0001.2	399005	HYDRAULIC CONTROL UNI	1K0 698 517 B	
		2,0 FSI	05.2005	12.2008	24.9145-0001.2	399005	HYDRAULIC CONTROL UNI	1K0 698 517 B
	2,0 TDI	05.2005	12.2008	24.9145-0001.2	399005	HYDRAULIC CONTROL UNI	1K0 698 517 B	
		01.2005	12.2008	24.9145-0001.2	399005	HYDRAULIC CONTROL UNI	1K0 698 517 B	
GOLF V (03-08)	1,4 16V	10.2003	09.2008	24.9145-0001.2	399005	HYDRAULIC CONTROL UNI	1K0 698 517 B	
	1,4 FSI	10.2003	09.2008	24.9145-0001.2	399005	HYDRAULIC CONTROL UNI	1K0 698 517 B	
	1,4 TSI	05.2006	09.2008	24.9145-0001.2	399005	HYDRAULIC CONTROL UNI	1K0 698 517 B	
		05.2007	09.2008	24.9145-0001.2	399005	HYDRAULIC CONTROL UNI	1K0 698 517 B	
		11.2005	09.2008	24.9145-0001.2	399005	HYDRAULIC CONTROL UNI	1K0 698 517 B	
	1,6 16V	01.2004	09.2008	24.9145-0001.2	399005	HYDRAULIC CONTROL UNI	1K0 698 517 B	
	1,6 FSI	10.2003	09.2008	24.9145-0001.2	399005	HYDRAULIC CONTROL UNI	1K0 698 517 B	
	1,8 GTI	08.2006	09.2008	24.9145-0001.2	399005	HYDRAULIC CONTROL UNI	1K0 698 517 B	



Denominación

Ref. OE correspondientes a las referencias ATE



Referencia anterior / varios

VOLKSWAGEN

Modelo	Motor	Fecha 1	Fecha 2	Ref. 1	Ref. 2	Ref. 3	Denominación	Ref. OE correspondientes a las referencias ATE	Referencia anterior / varios
GOLF V (03-08)	1,9 TDI	10.2003	09.2008	24.9145-0001.2	399005		HYDRAULIC CONTROL UNI	1K0 698 517 B	
		05.2004	09.2008	24.9145-0001.2	399005		HYDRAULIC CONTROL UNI	1K0 698 517 B	
	1,9 TDI 4motion	08.2004	09.2008	24.9145-0001.2	399005		HYDRAULIC CONTROL UNI	1K0 698 517 B	
	2	08.2006	09.2008	24.9145-0001.2	399005		HYDRAULIC CONTROL UNI	1K0 698 517 B	
	2,0 FSI	10.2003	09.2008	24.9145-0001.2	399005		HYDRAULIC CONTROL UNI	1K0 698 517 B	
	2,0 FSI 4motion	08.2004	09.2008	24.9145-0001.2	399005		HYDRAULIC CONTROL UNI	1K0 698 517 B	
	2,0 GTI	09.2006	09.2008	24.9145-0001.2	399005		HYDRAULIC CONTROL UNI	1K0 698 517 B	
		09.2004	09.2008	24.9145-0001.2	399005		HYDRAULIC CONTROL UNI	1K0 698 517 B	
	2,0 SDI	01.2004	09.2008	24.9145-0001.2	399005		HYDRAULIC CONTROL UNI	1K0 698 517 B	
	2,0 TDI	11.2005	09.2008	24.9145-0001.2	399005		HYDRAULIC CONTROL UNI	1K0 698 517 B	
GOLF V Variant (07-09)		10.2003	09.2008	24.9145-0001.2	399005		HYDRAULIC CONTROL UNI	1K0 698 517 B	
	2,0 TDI 4motion	08.2004	09.2008	24.9145-0001.2	399005		HYDRAULIC CONTROL UNI	1K0 698 517 B	
	3,2 R32	11.2005	09.2008	24.9145-0001.2	399005		HYDRAULIC CONTROL UNI	1K0 698 517 B	
	1,4	06.2007	06.2009	24.9145-0001.2	399005		HYDRAULIC CONTROL UNI	1K0 698 517 B	
	1,4 TSI	05.2007	06.2009	24.9145-0001.2	399005		HYDRAULIC CONTROL UNI	1K0 698 517 B	
		06.2007	06.2009	24.9145-0001.2	399005		HYDRAULIC CONTROL UNI	1K0 698 517 B	
		07.2008	06.2009	24.9145-0001.2	399005		HYDRAULIC CONTROL UNI	1K0 698 517 B	
	1,6	05.2007	06.2009	24.9145-0001.2	399005		HYDRAULIC CONTROL UNI	1K0 698 517 B	
	1,9 TDI	05.2007	06.2009	24.9145-0001.2	399005		HYDRAULIC CONTROL UNI	1K0 698 517 B	
	1,9 TDI 4motion	12.2007	06.2009	24.9145-0001.2	399005		HYDRAULIC CONTROL UNI	1K0 698 517 B	
	06.2007	06.2009	24.9145-0001.2	399005		HYDRAULIC CONTROL UNI	1K0 698 517 B		



Denominación

Ref. OE correspondientes a las referencias ATE



Referencia anterior / varios

VOLKSWAGEN

Modelo	Motor	Info	05.2007	06.2009	24.9145-0001.2	399005	Denominación	Ref. OE correspondientes a las referencias ATE	Referencia anterior / varios
GOLF V Variant (07-09)	2,0 TDI						HYDRAULIC CONTROL UNI	1K0 698 517 B	
JETTA V (05-10)	1,4 TSI		05.2007	10.2010	24.9145-0001.2	399005	HYDRAULIC CONTROL UNI	1K0 698 517 B	
			06.2006	10.2010	24.9145-0001.2	399005	HYDRAULIC CONTROL UNI	1K0 698 517 B	
			07.2008	10.2010	24.9145-0001.2	399005	HYDRAULIC CONTROL UNI	1K0 698 517 B	
	1,6 FSI		08.2005	10.2010	24.9145-0001.2	399005	HYDRAULIC CONTROL UNI	1K0 698 517 B	
	1,6 i 16V		08.2005	10.2010	24.9145-0001.2	399005	HYDRAULIC CONTROL UNI	1K0 698 517 B	
	1,6 TDI		06.2009	10.2010	24.9145-0001.2	399005	HYDRAULIC CONTROL UNI	1K0 698 517 B	
	1,9 TDI		08.2005	10.2010	24.9145-0001.2	399005	HYDRAULIC CONTROL UNI	1K0 698 517 B	
	2,0 FSI		08.2005	10.2010	24.9145-0001.2	399005	HYDRAULIC CONTROL UNI	1K0 698 517 B	
	2,0 TDI		06.2006	10.2010	24.9145-0001.2	399005	HYDRAULIC CONTROL UNI	1K0 698 517 B	
			09.2005	10.2010	24.9145-0001.2	399005	HYDRAULIC CONTROL UNI	1K0 698 517 B	
			08.2005	10.2010	24.9145-0001.2	399005	HYDRAULIC CONTROL UNI	1K0 698 517 B	
	2,0 TFSI		10.2005	10.2010	24.9145-0001.2	399005	HYDRAULIC CONTROL UNI	1K0 698 517 B	
	2,5 FSI		07.2008	10.2010	24.9145-0001.2	399005	HYDRAULIC CONTROL UNI	1K0 698 517 B	
LT/LT 4x4 (96-06)	LT 28	DI	05.1996	07.2006	24.3601-8514.5	240688	PINZA DE GARRA	2D0 615 124 , A 901 420 47 01 , A 901 420 42 01 , A 901 420 40 01 , A 002 420 61 83 , 901 420 47 01 , 002 420 61 83 , 901 420 42 01 , 901 420 40 01	11.3601-8514.2
	LT 35	DI	05.1996	07.2006	24.3601-8514.5	240688	PINZA DE GARRA	2D0 615 124 , A 901 420 47 01 , A 901 420 42 01 , A 901 420 40 01 , A 002 420 61 83 , 901 420 47 01 , 002 420 61 83 , 901 420 42 01 , 901 420 40 01	11.3601-8514.2



Denominación

Ref. OE correspondientes a las referencias ATE

Referencia anterior / varios

VOLKSWAGEN

PASSAT / PASSAT VARIANT (10-14)	1,4 TSI		11.2012	10.2014	13.0470-2621.2	LD2621	CERAMIC PAST. DE FRENO	3C0 698 451 C , 1K0 698 451 K , 1K0 698 451 E , 3C0 698 451 A , 1K0 698 451 B	
			08.2010	10.2014	13.0470-2621.2	LD2621	CERAMIC PAST. DE FRENO	3C0 698 451 C , 1K0 698 451 K , 1K0 698 451 E , 3C0 698 451 A , 1K0 698 451 B	
	1,6 TDI		08.2010	10.2014	13.0470-2621.2	LD2621	CERAMIC PAST. DE FRENO	3C0 698 451 C , 1K0 698 451 K , 1K0 698 451 E , 3C0 698 451 A , 1K0 698 451 B	
	1,8 TSI		08.2010	10.2014	13.0470-2621.2	LD2621	CERAMIC PAST. DE FRENO	3C0 698 451 C , 1K0 698 451 K , 1K0 698 451 E , 3C0 698 451 A , 1K0 698 451 B	
	2,0 TDI		08.2010	10.2014	13.0470-2621.2	LD2621	CERAMIC PAST. DE FRENO	3C0 698 451 C , 1K0 698 451 K , 1K0 698 451 E , 3C0 698 451 A , 1K0 698 451 B	
			12.2012	10.2014	13.0470-2621.2	LD2621	CERAMIC PAST. DE FRENO	3C0 698 451 C , 1K0 698 451 K , 1K0 698 451 E , 3C0 698 451 A , 1K0 698 451 B	
	2,0 TDI 4motion		01.2013	10.2014	13.0470-2621.2	LD2621	CERAMIC PAST. DE FRENO	3C0 698 451 C , 1K0 698 451 K , 1K0 698 451 E , 3C0 698 451 A , 1K0 698 451 B	
			08.2010	10.2014	13.0470-2621.2	LD2621	CERAMIC PAST. DE FRENO	3C0 698 451 C , 1K0 698 451 K , 1K0 698 451 E , 3C0 698 451 A , 1K0 698 451 B	
	2,0 TSI		11.2010	10.2014	13.0470-2621.2	LD2621	CERAMIC PAST. DE FRENO	3C0 698 451 C , 1K0 698 451 K , 1K0 698 451 E , 3C0 698 451 A , 1K0 698 451 B	
	3,6 FSI 4motion		01.2011	10.2014	13.0470-2621.2	LD2621	CERAMIC PAST. DE FRENO	3C0 698 451 C , 1K0 698 451 K , 1K0 698 451 E , 3C0 698 451 A , 1K0 698 451 B	
PASSAT ALLTRACK (12-14)	1,8 TSI		01.2012		13.0470-2621.2	LD2621	CERAMIC PAST. DE FRENO	3C0 698 451 C , 1K0 698 451 K , 1K0 698 451 E , 3C0 698 451 A , 1K0 698 451 B	



Denominación

Ref. OE correspondientes a las referencias ATE



Referencia anterior / varios

VOLKSWAGEN

PASSAT ALLTRACK (12-14)	2,0 TDI		01.2012		13.0470-2621.2	LD2621	CERAMIC PAST. DE FRENO	3C0 698 451 C , 1K0 698 451 K , 1K0 698 451 E , 3C0 698 451 A , 1K0 698 451 B	
	2,0 TDI 4motion		01.2012		13.0470-2621.2	LD2621	CERAMIC PAST. DE FRENO	3C0 698 451 C , 1K0 698 451 K , 1K0 698 451 E , 3C0 698 451 A , 1K0 698 451 B	
			01.2013		13.0470-2621.2	LD2621	CERAMIC PAST. DE FRENO	3C0 698 451 C , 1K0 698 451 K , 1K0 698 451 E , 3C0 698 451 A , 1K0 698 451 B	
	2,0 TSI 4motion		01.2012		13.0470-2621.2	LD2621	CERAMIC PAST. DE FRENO	3C0 698 451 C , 1K0 698 451 K , 1K0 698 451 E , 3C0 698 451 A , 1K0 698 451 B	
PASSAT CC (08-11)	1,4 TSI MultiFuel		01.2011	09.2011	11.0230-0663.1	260131	CALIPER MOUNT. BRACKET	1K0 615 125 B	
			01.2011	09.2011	13.0470-2621.2	LD2621	CERAMIC PAST. DE FRENO	3C0 698 451 C , 1K0 698 451 K , 1K0 698 451 E , 3C0 698 451 A , 1K0 698 451 B	
	1,8 TSI		04.2008	09.2011	11.0230-0663.1	260131	CALIPER MOUNT. BRACKET	1K0 615 125 B	
			04.2008	09.2011	13.0470-2621.2	LD2621	CERAMIC PAST. DE FRENO	3C0 698 451 C , 1K0 698 451 K , 1K0 698 451 E , 3C0 698 451 A , 1K0 698 451 B	
	2,0 TDI		04.2008	09.2011	11.0230-0663.1	260131	CALIPER MOUNT. BRACKET	1K0 615 125 B	
			06.2008	09.2011	11.0230-0663.1	260131	CALIPER MOUNT. BRACKET	1K0 615 125 B	
			06.2008	09.2011	13.0470-2621.2	LD2621	CERAMIC PAST. DE FRENO	3C0 698 451 C , 1K0 698 451 K , 1K0 698 451 E , 3C0 698 451 A , 1K0 698 451 B	
			04.2008	09.2011	13.0470-2621.2	LD2621	CERAMIC PAST. DE FRENO	3C0 698 451 C , 1K0 698 451 K , 1K0 698 451 E , 3C0 698 451 A , 1K0 698 451 B	
	2,0 TDI 4motion		08.2009	09.2011	11.0230-0663.1	260131	CALIPER MOUNT. BRACKET	1K0 615 125 B	
			11.2009	09.2011	11.0230-0663.1	260131	CALIPER MOUNT. BRACKET	1K0 615 125 B	



Denominación

Ref. OE correspondientes a las referencias ATE



Referencia anterior / varios

VOLKSWAGEN

Modelo	Motor	Fecha inicio	Fecha fin	Código ATE	Código OE	Denominación	Ref. OE correspondientes a las referencias ATE	Referencia anterior / varios
PASSAT CC (08-11)	2,0 TDI 4motion	11.2009	09.2011	13.0470-2621.2	LD2621	CERAMIC PAST. DE FRENO	3C0 698 451 C, 1K0 698 451 K, 1K0 698 451 E, 3C0 698 451 A, 1K0 698 451 B	
		08.2009	09.2011	13.0470-2621.2	LD2621	CERAMIC PAST. DE FRENO	3C0 698 451 C, 1K0 698 451 K, 1K0 698 451 E, 3C0 698 451 A, 1K0 698 451 B	
	2,0 TSI	04.2008	09.2011	11.0230-0663.1	260131	CALIPER MOUNT. BRACKET	1K0 615 125 B	
		04.2008	09.2011	13.0470-2621.2	LD2621	CERAMIC PAST. DE FRENO	3C0 698 451 C, 1K0 698 451 K, 1K0 698 451 E, 3C0 698 451 A, 1K0 698 451 B	
	3,6 FSI 4motion	04.2008	09.2011	11.0230-0663.1	260131	CALIPER MOUNT. BRACKET	1K0 615 125 B	
		04.2008	09.2011	13.0470-2621.2	LD2621	CERAMIC PAST. DE FRENO	3C0 698 451 C, 1K0 698 451 K, 1K0 698 451 E, 3C0 698 451 A, 1K0 698 451 B	
PASSAT CC (11-)	1,4 TSI	05.2015		13.0470-2621.2	LD2621	CERAMIC PAST. DE FRENO	3C0 698 451 C, 1K0 698 451 K, 1K0 698 451 E, 3C0 698 451 A, 1K0 698 451 B	
		11.2011		13.0470-2621.2	LD2621	CERAMIC PAST. DE FRENO	3C0 698 451 C, 1K0 698 451 K, 1K0 698 451 E, 3C0 698 451 A, 1K0 698 451 B	
	1,8 TSI	11.2011		13.0470-2621.2	LD2621	CERAMIC PAST. DE FRENO	3C0 698 451 C, 1K0 698 451 K, 1K0 698 451 E, 3C0 698 451 A, 1K0 698 451 B	
	2,0 TDI	11.2011		13.0470-2621.2	LD2621	CERAMIC PAST. DE FRENO	3C0 698 451 C, 1K0 698 451 K, 1K0 698 451 E, 3C0 698 451 A, 1K0 698 451 B	
		05.2015		13.0470-2621.2	LD2621	CERAMIC PAST. DE FRENO	3C0 698 451 C, 1K0 698 451 K, 1K0 698 451 E, 3C0 698 451 A, 1K0 698 451 B	
		12.2012		13.0470-2621.2	LD2621	CERAMIC PAST. DE FRENO	3C0 698 451 C, 1K0 698 451 K, 1K0 698 451 E, 3C0 698 451 A, 1K0 698 451 B	



Denominación

Ref. OE correspondientes a las referencias ATE



Referencia anterior / varios

VOLKSWAGEN

PASSAT CC (11-)	2,0 TDI 4motion		11.2011		13.0470-2621.2	LD2621	CERAMIC PAST. DE FRENO	3C0 698 451 C , 1K0 698 451 K , 1K0 698 451 E , 3C0 698 451 A , 1K0 698 451 B	
			12.2012		13.0470-2621.2	LD2621	CERAMIC PAST. DE FRENO	3C0 698 451 C , 1K0 698 451 K , 1K0 698 451 E , 3C0 698 451 A , 1K0 698 451 B	
	2,0 TSI		11.2011		13.0470-2621.2	LD2621	CERAMIC PAST. DE FRENO	3C0 698 451 C , 1K0 698 451 K , 1K0 698 451 E , 3C0 698 451 A , 1K0 698 451 B	
	3,6 V6 4motion		11.2011		13.0470-2621.2	LD2621	CERAMIC PAST. DE FRENO	3C0 698 451 C , 1K0 698 451 K , 1K0 698 451 E , 3C0 698 451 A , 1K0 698 451 B	
PASSAT Limousine (05-10)	1,4 TSI		10.2007	07.2010	11.0230-0663.1	260131	CALIPER MOUNT. BRACKET	1K0 615 125 B	
			10.2007	07.2010	13.0470-2621.2	LD2621	CERAMIC PAST. DE FRENO	3C0 698 451 C , 1K0 698 451 K , 1K0 698 451 E , 3C0 698 451 A , 1K0 698 451 B	
	1,6		03.2005	07.2010	11.0230-0663.1	260131	CALIPER MOUNT. BRACKET	1K0 615 125 B	
			03.2005	07.2010	13.0470-2621.2	LD2621	CERAMIC PAST. DE FRENO	3C0 698 451 C , 1K0 698 451 K , 1K0 698 451 E , 3C0 698 451 A , 1K0 698 451 B	
	1,6 FSI		03.2005	07.2010	11.0230-0663.1	260131	CALIPER MOUNT. BRACKET	1K0 615 125 B	
			03.2005	07.2010	13.0470-2621.2	LD2621	CERAMIC PAST. DE FRENO	3C0 698 451 C , 1K0 698 451 K , 1K0 698 451 E , 3C0 698 451 A , 1K0 698 451 B	
	1,6 TDI		08.2009	07.2010	11.0230-0663.1	260131	CALIPER MOUNT. BRACKET	1K0 615 125 B	
			08.2009	07.2010	13.0470-2621.2	LD2621	CERAMIC PAST. DE FRENO	3C0 698 451 C , 1K0 698 451 K , 1K0 698 451 E , 3C0 698 451 A , 1K0 698 451 B	
	1,8 TSI		11.2009	07.2010	11.0230-0663.1	260131	CALIPER MOUNT. BRACKET	1K0 615 125 B	
			10.2007	07.2010	11.0230-0663.1	260131	CALIPER MOUNT. BRACKET	1K0 615 125 B	



Denominación

Ref. OE correspondientes a las referencias ATE



Referencia anterior / varios

VOLKSWAGEN

PASSAT Limousine (05-10)	1,8 TSI		10.2007	07.2010	13.0470-2621.2	LD2621	CERAMIC PAST. DE FRENO	3C0 698 451 C , 1K0 698 451 K , 1K0 698 451 E , 3C0 698 451 A , 1K0 698 451 B	
			11.2009	07.2010	13.0470-2621.2	LD2621	CERAMIC PAST. DE FRENO	3C0 698 451 C , 1K0 698 451 K , 1K0 698 451 E , 3C0 698 451 A , 1K0 698 451 B	
	1,9 TDI		03.2005	07.2010	11.0230-0663.1	260131	CALIPER MOUNT. BRACKET	1K0 615 125 B	
			03.2005	07.2010	13.0470-2621.2	LD2621	CERAMIC PAST. DE FRENO	3C0 698 451 C , 1K0 698 451 K , 1K0 698 451 E , 3C0 698 451 A , 1K0 698 451 B	
	2,0 FSI		03.2005	07.2010	11.0230-0663.1	260131	CALIPER MOUNT. BRACKET	1K0 615 125 B	
			03.2005	07.2010	13.0470-2621.2	LD2621	CERAMIC PAST. DE FRENO	3C0 698 451 C , 1K0 698 451 K , 1K0 698 451 E , 3C0 698 451 A , 1K0 698 451 B	
	2,0 FSI 4motion		03.2005	07.2010	11.0230-0663.1	260131	CALIPER MOUNT. BRACKET	1K0 615 125 B	
			03.2005	07.2010	13.0470-2621.2	LD2621	CERAMIC PAST. DE FRENO	3C0 698 451 C , 1K0 698 451 K , 1K0 698 451 E , 3C0 698 451 A , 1K0 698 451 B	
	2,0 TDI		08.2005	07.2010	11.0230-0663.1	260131	CALIPER MOUNT. BRACKET	1K0 615 125 B	
			03.2005	07.2010	11.0230-0663.1	260131	CALIPER MOUNT. BRACKET	1K0 615 125 B	
			08.2005	07.2010	13.0470-2621.2	LD2621	CERAMIC PAST. DE FRENO	3C0 698 451 C , 1K0 698 451 K , 1K0 698 451 E , 3C0 698 451 A , 1K0 698 451 B	
			03.2005	07.2010	13.0470-2621.2	LD2621	CERAMIC PAST. DE FRENO	3C0 698 451 C , 1K0 698 451 K , 1K0 698 451 E , 3C0 698 451 A , 1K0 698 451 B	
	2,0 TDI 16V		03.2005	07.2010	11.0230-0663.1	260131	CALIPER MOUNT. BRACKET	1K0 615 125 B	
			03.2005	07.2010	13.0470-2621.2	LD2621	CERAMIC PAST. DE FRENO	3C0 698 451 C , 1K0 698 451 K , 1K0 698 451 E , 3C0 698 451 A , 1K0 698 451 B	



Denominación

Ref. OE correspondientes a las referencias ATE



Referencia anterior / varios

VOLKSWAGEN

PASSAT Limousine (05-10)	2,0 TDI 4motion		05.2009	07.2010	11.0230-0663.1	260131	CALIPER MOUNT. BRACKET	1K0 615 125 B	
			03.2005	07.2010	11.0230-0663.1	260131	CALIPER MOUNT. BRACKET	1K0 615 125 B	
			03.2005	07.2010	13.0470-2621.2	LD2621	CERAMIC PAST. DE FRENO	3C0 698 451 C , 1K0 698 451 K , 1K0 698 451 E , 3C0 698 451 A , 1K0 698 451 B	
			05.2009	07.2010	13.0470-2621.2	LD2621	CERAMIC PAST. DE FRENO	3C0 698 451 C , 1K0 698 451 K , 1K0 698 451 E , 3C0 698 451 A , 1K0 698 451 B	
	3,2 V6 FSI 4motion		09.2005	07.2010	11.0230-0663.1	260131	CALIPER MOUNT. BRACKET	1K0 615 125 B	
			09.2005	07.2010	13.0470-2621.2	LD2621	CERAMIC PAST. DE FRENO	3C0 698 451 C , 1K0 698 451 K , 1K0 698 451 E , 3C0 698 451 A , 1K0 698 451 B	
	3,6 R36		04.2007	07.2010	11.0230-0663.1	260131	CALIPER MOUNT. BRACKET	1K0 615 125 B	
			04.2007	07.2010	13.0470-2621.2	LD2621	CERAMIC PAST. DE FRENO	3C0 698 451 C , 1K0 698 451 K , 1K0 698 451 E , 3C0 698 451 A , 1K0 698 451 B	
PASSAT Variant (05-10)	1,4 TSI		10.2007	07.2010	11.0230-0663.1	260131	CALIPER MOUNT. BRACKET	1K0 615 125 B	
			10.2007	07.2010	13.0470-2621.2	LD2621	CERAMIC PAST. DE FRENO	3C0 698 451 C , 1K0 698 451 K , 1K0 698 451 E , 3C0 698 451 A , 1K0 698 451 B	
	1,6		07.2005	07.2010	11.0230-0663.1	260131	CALIPER MOUNT. BRACKET	1K0 615 125 B	
			07.2005	07.2010	13.0470-2621.2	LD2621	CERAMIC PAST. DE FRENO	3C0 698 451 C , 1K0 698 451 K , 1K0 698 451 E , 3C0 698 451 A , 1K0 698 451 B	
	1,6 FSI		07.2005	07.2010	11.0230-0663.1	260131	CALIPER MOUNT. BRACKET	1K0 615 125 B	
			07.2005	07.2010	13.0470-2621.2	LD2621	CERAMIC PAST. DE FRENO	3C0 698 451 C , 1K0 698 451 K , 1K0 698 451 E , 3C0 698 451 A , 1K0 698 451 B	
	1,6 TDI		08.2009	07.2010	11.0230-0663.1	260131	CALIPER MOUNT. BRACKET	1K0 615 125 B	



Denominación

Ref. OE correspondientes a las referencias ATE



Referencia anterior / varios

VOLKSWAGEN

PASSAT Variant (05-10)	1,6 TDI		08.2009	07.2010	13.0470-2621.2	LD2621	CERAMIC PAST. DE FRENO	3C0 698 451 C , 1K0 698 451 K , 1K0 698 451 E , 3C0 698 451 A , 1K0 698 451 B	
	1,8 TSI		10.2007	07.2010	11.0230-0663.1	260131	CALIPER MOUNT. BRACKET	1K0 615 125 B	
			11.2009	07.2010	11.0230-0663.1	260131	CALIPER MOUNT. BRACKET	1K0 615 125 B	
			11.2009	07.2010	13.0470-2621.2	LD2621	CERAMIC PAST. DE FRENO	3C0 698 451 C , 1K0 698 451 K , 1K0 698 451 E , 3C0 698 451 A , 1K0 698 451 B	
			10.2007	07.2010	13.0470-2621.2	LD2621	CERAMIC PAST. DE FRENO	3C0 698 451 C , 1K0 698 451 K , 1K0 698 451 E , 3C0 698 451 A , 1K0 698 451 B	
	1,9 TDI		07.2005	07.2010	11.0230-0663.1	260131	CALIPER MOUNT. BRACKET	1K0 615 125 B	
			07.2005	07.2010	13.0470-2621.2	LD2621	CERAMIC PAST. DE FRENO	3C0 698 451 C , 1K0 698 451 K , 1K0 698 451 E , 3C0 698 451 A , 1K0 698 451 B	
	2,0 FSI		07.2005	07.2010	11.0230-0663.1	260131	CALIPER MOUNT. BRACKET	1K0 615 125 B	
			07.2005	07.2010	13.0470-2621.2	LD2621	CERAMIC PAST. DE FRENO	3C0 698 451 C , 1K0 698 451 K , 1K0 698 451 E , 3C0 698 451 A , 1K0 698 451 B	
	2,0 FSI 4motion		09.2005	07.2010	11.0230-0663.1	260131	CALIPER MOUNT. BRACKET	1K0 615 125 B	
			09.2005	07.2010	13.0470-2621.2	LD2621	CERAMIC PAST. DE FRENO	3C0 698 451 C , 1K0 698 451 K , 1K0 698 451 E , 3C0 698 451 A , 1K0 698 451 B	
	2,0 TDI		07.2005	07.2010	11.0230-0663.1	260131	CALIPER MOUNT. BRACKET	1K0 615 125 B	
			11.2005	07.2010	11.0230-0663.1	260131	CALIPER MOUNT. BRACKET	1K0 615 125 B	
			11.2005	07.2010	13.0470-2621.2	LD2621	CERAMIC PAST. DE FRENO	3C0 698 451 C , 1K0 698 451 K , 1K0 698 451 E , 3C0 698 451 A , 1K0 698 451 B	



Denominación

Ref. OE correspondientes a las referencias ATE



Referencia anterior / varios

VOLKSWAGEN

Modelo	Motor	Info	Desde	Hasta	ATE Ref.	ATE Ref.	Denominación	Ref. OE correspondientes a las referencias ATE	Referencia anterior / varios
PASSAT Variant (05-10)	2,0 TDI		07.2005	07.2010	13.0470-2621.2	LD2621	CERAMIC PAST. DE FRENO	3C0 698 451 C , 1K0 698 451 K , 1K0 698 451 E , 3C0 698 451 A , 1K0 698 451 B	
	2,0 TDI 16V		08.2005	07.2010	11.0230-0663.1	260131	CALIPER MOUNT. BRACKET	1K0 615 125 B	
			08.2005	07.2010	13.0470-2621.2	LD2621	CERAMIC PAST. DE FRENO	3C0 698 451 C , 1K0 698 451 K , 1K0 698 451 E , 3C0 698 451 A , 1K0 698 451 B	
	2,0 TDI 4motion		05.2009	07.2010	11.0230-0663.1	260131	CALIPER MOUNT. BRACKET	1K0 615 125 B	
			09.2005	07.2010	11.0230-0663.1	260131	CALIPER MOUNT. BRACKET	1K0 615 125 B	
			05.2009	07.2010	13.0470-2621.2	LD2621	CERAMIC PAST. DE FRENO	3C0 698 451 C , 1K0 698 451 K , 1K0 698 451 E , 3C0 698 451 A , 1K0 698 451 B	
			09.2005	07.2010	13.0470-2621.2	LD2621	CERAMIC PAST. DE FRENO	3C0 698 451 C , 1K0 698 451 K , 1K0 698 451 E , 3C0 698 451 A , 1K0 698 451 B	
	2,0 TFSI		07.2005	07.2010	11.0230-0663.1	260131	CALIPER MOUNT. BRACKET	1K0 615 125 B	
			07.2005	07.2010	13.0470-2621.2	LD2621	CERAMIC PAST. DE FRENO	3C0 698 451 C , 1K0 698 451 K , 1K0 698 451 E , 3C0 698 451 A , 1K0 698 451 B	
	3,2 V6 FSI 4motion		11.2005	07.2010	11.0230-0663.1	260131	CALIPER MOUNT. BRACKET	1K0 615 125 B	
			11.2005	07.2010	13.0470-2621.2	LD2621	CERAMIC PAST. DE FRENO	3C0 698 451 C , 1K0 698 451 K , 1K0 698 451 E , 3C0 698 451 A , 1K0 698 451 B	
	3,6 R36		04.2007	07.2010	11.0230-0663.1	260131	CALIPER MOUNT. BRACKET	1K0 615 125 B	
			04.2007	07.2010	13.0470-2621.2	LD2621	CERAMIC PAST. DE FRENO	3C0 698 451 C , 1K0 698 451 K , 1K0 698 451 E , 3C0 698 451 A , 1K0 698 451 B	
POLO IV (02-09)	1,2	TI	11.2001	05.2009	24.3344-1709.5	240810	PINZA DE GARRA	6Q0 615 423 B , 6Q0 615 423 A	24.3344-1709.7



Denominación

Ref. OE correspondientes a las referencias ATE



Referencia anterior / varios

VOLKSWAGEN

Modelo	Motor	TI	04.2007	05.2009	24.3344-1709.5	240810	PINZA DE GARRA	6Q0 615 423 B , 6Q0 615 423 A	24.3344-1709.7
POLO IV (02-09)	1,2	TI	04.2007	05.2009	24.3344-1709.5	240810	PINZA DE GARRA	6Q0 615 423 B , 6Q0 615 423 A	24.3344-1709.7
	1,4 16V	TI	05.2006	05.2009	24.3344-1709.5	240810	PINZA DE GARRA	6Q0 615 423 B , 6Q0 615 423 A	24.3344-1709.7
		TI	11.2001	05.2009	24.3344-1709.5	240810	PINZA DE GARRA	6Q0 615 423 B , 6Q0 615 423 A	24.3344-1709.7
	1,4 FSI	TI	11.2001	05.2009	24.3344-1709.5	240810	PINZA DE GARRA	6Q0 615 423 B , 6Q0 615 423 A	24.3344-1709.7
	1,4 TDI	TI	11.2001	05.2009	24.3344-1709.5	240810	PINZA DE GARRA	6Q0 615 423 B , 6Q0 615 423 A	24.3344-1709.7
	1,6 16V	TI	05.2006	05.2009	24.3344-1709.5	240810	PINZA DE GARRA	6Q0 615 423 B , 6Q0 615 423 A	24.3344-1709.7
	1,8 GTI	TI	06.2006	05.2009	24.3344-1709.5	240810	PINZA DE GARRA	6Q0 615 423 B , 6Q0 615 423 A	24.3344-1709.7
		TI	09.2005	05.2009	24.3344-1709.5	240810	PINZA DE GARRA	6Q0 615 423 B , 6Q0 615 423 A	24.3344-1709.7
	1,9 TDI	TI	10.2003	05.2009	24.3344-1709.5	240810	PINZA DE GARRA	6Q0 615 423 B , 6Q0 615 423 A	24.3344-1709.7
		TI	11.2001	05.2009	24.3344-1709.5	240810	PINZA DE GARRA	6Q0 615 423 B , 6Q0 615 423 A	24.3344-1709.7
	2	TI	04.2002	05.2009	24.3344-1709.5	240810	PINZA DE GARRA	6Q0 615 423 B , 6Q0 615 423 A	24.3344-1709.7
TOUAREG I (03-10)	2,5 R5 TDI		01.2003	03.2010	11.0230-0811.1	260137	CALIPER MOUNT. BRACKET	7L6 615 425 , 7L6 615 425 A	
	3,0 V6 TDI		11.2004	03.2010	11.0230-0811.1	260137	CALIPER MOUNT. BRACKET	7L6 615 425 , 7L6 615 425 A	
			10.2007	03.2010	11.0230-0811.1	260137	CALIPER MOUNT. BRACKET	7L6 615 425 , 7L6 615 425 A	
	3,2 V6		11.2002	12.2005	11.0230-0811.1	260137	CALIPER MOUNT. BRACKET	7L6 615 425 , 7L6 615 425 A	
	3,6 V6 FSI		01.2006	03.2010	11.0230-0811.1	260137	CALIPER MOUNT. BRACKET	7L6 615 425 , 7L6 615 425 A	



Denominación

Ref. OE correspondientes a las referencias ATE



Referencia anterior / varios

VOLKSWAGEN

Modelo	Motor	Fecha 1	Fecha 2	Código 1	Código 2	Denominación	Ref. OE correspondientes a las referencias ATE
TOUAREG I (03-10)	4,2 V8	12.2002	11.2006	11.0230-0811.1	260137	CALIPER MOUNT. BRACKET	7L6 615 425 , 7L6 615 425 A
	4,2 V8 FSI	12.2006	03.2010	11.0230-0811.1	260137	CALIPER MOUNT. BRACKET	7L6 615 425 , 7L6 615 425 A
	5,0 TDI R50	01.2008	03.2010	11.0230-0811.1	260137	CALIPER MOUNT. BRACKET	7L6 615 425 , 7L6 615 425 A
	5,0 V10 TDI	11.2002	03.2010	11.0230-0811.1	260137	CALIPER MOUNT. BRACKET	7L6 615 425 , 7L6 615 425 A
	6,0 W12	08.2004	11.2006	11.0230-0811.1	260137	CALIPER MOUNT. BRACKET	7L6 615 425 , 7L6 615 425 A
TOURAN I (03-15)	1,2 TSI	05.2010	12.2010	24.9145-0001.2	399005	HYDRAULIC CONTROL UNI	1K0 698 517 B
	1,4 TSI	11.2006	12.2010	24.9145-0001.2	399005	HYDRAULIC CONTROL UNI	1K0 698 517 B
		09.2006	12.2010	24.9145-0001.2	399005	HYDRAULIC CONTROL UNI	1K0 698 517 B
	1,4 TSI EcoFuel	05.2009	12.2010	24.9145-0001.2	399005	HYDRAULIC CONTROL UNI	1K0 698 517 B
	1,6	07.2003	12.2010	24.9145-0001.2	399005	HYDRAULIC CONTROL UNI	1K0 698 517 B
	1,6 FSI	02.2003	12.2010	24.9145-0001.2	399005	HYDRAULIC CONTROL UNI	1K0 698 517 B
	1,6 TDI	05.2010	12.2010	24.9145-0001.2	399005	HYDRAULIC CONTROL UNI	1K0 698 517 B
	1,9 TDI	11.2004	12.2010	24.9145-0001.2	399005	HYDRAULIC CONTROL UNI	1K0 698 517 B
		08.2003	12.2010	24.9145-0001.2	399005	HYDRAULIC CONTROL UNI	1K0 698 517 B
		02.2003	12.2010	24.9145-0001.2	399005	HYDRAULIC CONTROL UNI	1K0 698 517 B
	2,0 Eco Fuel	02.2006	12.2010	24.9145-0001.2	399005	HYDRAULIC CONTROL UNI	1K0 698 517 B
	2,0 FSI	10.2003	12.2010	24.9145-0001.2	399005	HYDRAULIC CONTROL UNI	1K0 698 517 B
		10.2004	12.2010	24.9145-0001.2	399005	HYDRAULIC CONTROL UNI	1K0 698 517 B
	2,0 TDI	02.2003	12.2010	24.9145-0001.2	399005	HYDRAULIC CONTROL UNI	1K0 698 517 B
		02.2006	12.2010	24.9145-0001.2	399005	HYDRAULIC CONTROL UNI	1K0 698 517 B
		08.2003	12.2010	24.9145-0001.2	399005	HYDRAULIC CONTROL UNI	1K0 698 517 B



Denominación

Ref. OE correspondientes a las referencias ATE

Referencia anterior / varios

VOLKSWAGEN

TRANSPORTER (T5) BUS / MULTIVAN / KASTEN (03-)	1,9 TDI		04.2003		11.0230-0811.1	260137	CALIPER MOUNT. BRACKET	7L6 615 425 , 7L6 615 425 A	
			06.2006		11.0230-0811.1	260137	CALIPER MOUNT. BRACKET	7L6 615 425 , 7L6 615 425 A	
			01.2006		11.0230-0811.1	260137	CALIPER MOUNT. BRACKET	7L6 615 425 , 7L6 615 425 A	
	2		06.2003		11.0230-0811.1	260137	CALIPER MOUNT. BRACKET	7L6 615 425 , 7L6 615 425 A	
	2,5 TDI		02.2003		11.0230-0811.1	260137	CALIPER MOUNT. BRACKET	7L6 615 425 , 7L6 615 425 A	
	2,5 TDI 4motion		07.2004		11.0230-0811.1	260137	CALIPER MOUNT. BRACKET	7L6 615 425 , 7L6 615 425 A	
	3,2 V6		02.2003		11.0230-0811.1	260137	CALIPER MOUNT. BRACKET	7L6 615 425 , 7L6 615 425 A	
	3,2 V6 4motion		07.2004		11.0230-0811.1	260137	CALIPER MOUNT. BRACKET	7L6 615 425 , 7L6 615 425 A	
TRANSPORTER (T5) PRITSCHKE / FAHRGESTELL (03-)	1,9 TDI		01.2006		11.0230-0811.1	260137	CALIPER MOUNT. BRACKET	7L6 615 425 , 7L6 615 425 A	
			04.2003		11.0230-0811.1	260137	CALIPER MOUNT. BRACKET	7L6 615 425 , 7L6 615 425 A	
			06.2006		11.0230-0811.1	260137	CALIPER MOUNT. BRACKET	7L6 615 425 , 7L6 615 425 A	
	2		06.2003		11.0230-0811.1	260137	CALIPER MOUNT. BRACKET	7L6 615 425 , 7L6 615 425 A	
	2,5 TDI		02.2003		11.0230-0811.1	260137	CALIPER MOUNT. BRACKET	7L6 615 425 , 7L6 615 425 A	
	2,5 TDI 4motion		07.2004		11.0230-0811.1	260137	CALIPER MOUNT. BRACKET	7L6 615 425 , 7L6 615 425 A	
	3,2 V6		08.2003		11.0230-0811.1	260137	CALIPER MOUNT. BRACKET	7L6 615 425 , 7L6 615 425 A	
			02.2004		11.0230-0811.1	260137	CALIPER MOUNT. BRACKET	7L6 615 425 , 7L6 615 425 A	



Denominación

Ref. OE correspondientes a las referencias ATE



Referencia anterior / varios

VOLVO

Modelo	Motor	Fecha 1	Fecha 2	Ref. 1	Ref. 2	Ref. 3	Denominación	Ref. OE	Referencia anterior / varios
C30 Coupe (06-12)	1,6	09.2006	12.2012	24.9145-0005.2	399009		HYDRAULIC CONTROL UNI	36001319	
	1,6 D	09.2006	12.2012	24.9145-0005.2	399009		HYDRAULIC CONTROL UNI	36001319	
	1,6 D Efficiency	09.2008	12.2012	24.9145-0005.2	399009		HYDRAULIC CONTROL UNI	36001319	
	1,6 D2	10.2010	12.2012	24.9145-0005.2	399009		HYDRAULIC CONTROL UNI	36001319	
	1,8	09.2006	12.2012	24.9145-0005.2	399009		HYDRAULIC CONTROL UNI	36001319	
	1,8 FlexiFuel	04.2007	12.2012	24.9145-0005.2	399009		HYDRAULIC CONTROL UNI	36001319	
	2	09.2006	12.2012	24.9145-0005.2	399009		HYDRAULIC CONTROL UNI	36001319	
	2,0 D	09.2006	12.2012	24.9145-0005.2	399009		HYDRAULIC CONTROL UNI	36001319	
	2,0 D3	10.2010		24.9145-0005.2	399009		HYDRAULIC CONTROL UNI	36001319	
		10.2010	12.2012	24.9145-0005.2	399009		HYDRAULIC CONTROL UNI	36001319	
	2,0 D4	10.2010		24.9145-0005.2	399009		HYDRAULIC CONTROL UNI	36001319	
		10.2010	12.2012	24.9145-0005.2	399009		HYDRAULIC CONTROL UNI	36001319	
	2,4 D5	10.2006	12.2012	24.9145-0005.2	399009		HYDRAULIC CONTROL UNI	36001319	
		09.2006	12.2012	24.9145-0005.2	399009		HYDRAULIC CONTROL UNI	36001319	
	2,4 i	09.2006	12.2012	24.9145-0005.2	399009		HYDRAULIC CONTROL UNI	36001319	
	2,5 T5	03.2007	12.2012	24.9145-0005.2	399009		HYDRAULIC CONTROL UNI	36001319	
		09.2006	12.2012	24.9145-0005.2	399009		HYDRAULIC CONTROL UNI	36001319	
	Electric	12.2010	12.2012	24.9145-0005.2	399009		HYDRAULIC CONTROL UNI	36001319	
C70 II Cabrio (06-13)	2,0 D	06.2008		24.9145-0005.2	399009		HYDRAULIC CONTROL UNI	36001319	
			07.2013	24.9145-0005.2	399009		HYDRAULIC CONTROL UNI	36001319	
	2,0 D3	10.2010		24.9145-0005.2	399009		HYDRAULIC CONTROL UNI	36001319	



Denominación

Ref. OE correspondientes a las referencias ATE



Referencia anterior / varios

VOLVO

Modelo	Motor	Fecha 1	Fecha 2	Ref. OE	Ref. ATE	Denominación	Ref. OE correspondientes a las referencias ATE	Referencia anterior / varios	
C70 II Cabrio (06-13)	2,0 D4	10.2010		24.9145-0005.2	399009	HYDRAULIC CONTROL UNI	36001319		
	2,4	03.2006		24.9145-0005.2	399009	HYDRAULIC CONTROL UNI	36001319		
			07.2013	24.9145-0005.2	399009	HYDRAULIC CONTROL UNI	36001319		
	2,4 D	03.2007		24.9145-0005.2	399009	HYDRAULIC CONTROL UNI	36001319		
			07.2013	24.9145-0005.2	399009	HYDRAULIC CONTROL UNI	36001319		
	2,4 D5		07.2013	24.9145-0005.2	399009	HYDRAULIC CONTROL UNI	36001319		
			03.2006		24.9145-0005.2	399009	HYDRAULIC CONTROL UNI	36001319	
	2,4 i	03.2006		24.9145-0005.2	399009	HYDRAULIC CONTROL UNI	36001319		
			07.2013	24.9145-0005.2	399009	HYDRAULIC CONTROL UNI	36001319		
	2,5 T5	03.2006		24.9145-0005.2	399009	HYDRAULIC CONTROL UNI	36001319		
		03.2007		24.9145-0005.2	399009	HYDRAULIC CONTROL UNI	36001319		
		07.2013	24.9145-0005.2	399009	HYDRAULIC CONTROL UNI	36001319			
S40 II (04-12)	1,6 D	01.2005	05.2012	24.9145-0005.2	399009	HYDRAULIC CONTROL UNI	36001319		
		04.2007	05.2012	24.9145-0005.2	399009	HYDRAULIC CONTROL UNI	36001319		
	1,6 i	01.2005	05.2012	24.9145-0005.2	399009	HYDRAULIC CONTROL UNI	36001319		
	1,8	04.2004	05.2012	24.9145-0005.2	399009	HYDRAULIC CONTROL UNI	36001319		
	1,8 FlexiFuel	04.2007	05.2012	24.9145-0005.2	399009	HYDRAULIC CONTROL UNI	36001319		
	2,0 D	01.2004	05.2012	24.9145-0005.2	399009	HYDRAULIC CONTROL UNI	36001319		
	2,0 D4	07.2005	05.2012	24.9145-0005.2	399009	HYDRAULIC CONTROL UNI	36001319		
	2,0 FlexiFuel	10.2006	05.2012	24.9145-0005.2	399009	HYDRAULIC CONTROL UNI	36001319		
2,0 i	10.2006	05.2012	24.9145-0005.2	399009	HYDRAULIC CONTROL UNI	36001319			



Denominación

Ref. OE correspondientes a las referencias ATE



Referencia anterior / varios

VOLVO

Modelo	Motor	Fecha 1	Fecha 2	Part No 1	Part No 2	Denominación	Ref. OE	
S40 II (04-12)	2,4	01.2004	05.2012	24.9145-0005.2	399009	HYDRAULIC CONTROL UNI	36001319	
	2,4 4X4	08.2006	05.2012	24.9145-0005.2	399009	HYDRAULIC CONTROL UNI	36001319	
	2,4 D5	03.2006	05.2012	24.9145-0005.2	399009	HYDRAULIC CONTROL UNI	36001319	
	2,5 T5	01.2004	05.2012	24.9145-0005.2	399009	HYDRAULIC CONTROL UNI	36001319	
			03.2007	05.2012	24.9145-0005.2	399009	HYDRAULIC CONTROL UNI	36001319
V40 (12-)	D2	09.2012		03.2125-5016.3	011010	TANDEM MASTER CYLINDE	36002135	
	D3	09.2012		03.2125-5016.3	011010	TANDEM MASTER CYLINDE	36002135	
	D4	09.2012		03.2125-5016.3	011010	TANDEM MASTER CYLINDE	36002135	
	T3 GTDi	09.2012		03.2125-5016.3	011010	TANDEM MASTER CYLINDE	36002135	
	T4	04.2013		03.2125-5016.3	011010	TANDEM MASTER CYLINDE	36002135	
			04.2014		03.2125-5016.3	011010	TANDEM MASTER CYLINDE	36002135
	T4 GTDi	09.2012		03.2125-5016.3	011010	TANDEM MASTER CYLINDE	36002135	
V50 (04-12)	1,6 D		05.2012	24.9145-0005.2	399009	HYDRAULIC CONTROL UNI	36001319	
		01.2005		24.9145-0005.2	399009	HYDRAULIC CONTROL UNI	36001319	
		01.2005	05.2012	24.9145-0005.2	399009	HYDRAULIC CONTROL UNI	36001319	
		04.2007		24.9145-0005.2	399009	HYDRAULIC CONTROL UNI	36001319	
		04.2007	05.2012	24.9145-0005.2	399009	HYDRAULIC CONTROL UNI	36001319	
	1,6 D2	01.2010		24.9145-0005.2	399009	HYDRAULIC CONTROL UNI	36001319	
			05.2012	24.9145-0005.2	399009	HYDRAULIC CONTROL UNI	36001319	
		01.2010	05.2012	24.9145-0005.2	399009	HYDRAULIC CONTROL UNI	36001319	
	1,6 i	01.2005		24.9145-0005.2	399009	HYDRAULIC CONTROL UNI	36001319	



Denominación

Ref. OE correspondientes a las referencias ATE



Referencia anterior / varios

VOLVO

V50 (04-12)	1,6 i			05.2012	24.9145-0005.2	399009	HYDRAULIC CONTROL UNI	36001319	
			01.2005	05.2012	24.9145-0005.2	399009	HYDRAULIC CONTROL UNI	36001319	
	1,8		04.2004	05.2012	24.9145-0005.2	399009	HYDRAULIC CONTROL UNI	36001319	
				05.2012	24.9145-0005.2	399009	HYDRAULIC CONTROL UNI	36001319	
			04.2004		24.9145-0005.2	399009	HYDRAULIC CONTROL UNI	36001319	
	1,8 FlexiFuel		04.2007		24.9145-0005.2	399009	HYDRAULIC CONTROL UNI	36001319	
				05.2012	24.9145-0005.2	399009	HYDRAULIC CONTROL UNI	36001319	
			04.2007	05.2012	24.9145-0005.2	399009	HYDRAULIC CONTROL UNI	36001319	
	2,0 D		04.2004	05.2012	24.9145-0005.2	399009	HYDRAULIC CONTROL UNI	36001319	
			04.2004		24.9145-0005.2	399009	HYDRAULIC CONTROL UNI	36001319	
				05.2012	24.9145-0005.2	399009	HYDRAULIC CONTROL UNI	36001319	
	2,0 D3		10.2010	05.2012	24.9145-0005.2	399009	HYDRAULIC CONTROL UNI	36001319	
			10.2010		24.9145-0005.2	399009	HYDRAULIC CONTROL UNI	36001319	
				05.2012	24.9145-0005.2	399009	HYDRAULIC CONTROL UNI	36001319	
	2,0 D4		10.2010		24.9145-0005.2	399009	HYDRAULIC CONTROL UNI	36001319	
				05.2012	24.9145-0005.2	399009	HYDRAULIC CONTROL UNI	36001319	
			10.2010	05.2012	24.9145-0005.2	399009	HYDRAULIC CONTROL UNI	36001319	
	2,0 FlexiFuel		01.2010	05.2012	24.9145-0005.2	399009	HYDRAULIC CONTROL UNI	36001319	
			01.2010		24.9145-0005.2	399009	HYDRAULIC CONTROL UNI	36001319	
				05.2012	24.9145-0005.2	399009	HYDRAULIC CONTROL UNI	36001319	
	2,0 i		10.2006		24.9145-0005.2	399009	HYDRAULIC CONTROL UNI	36001319	



Denominación

Ref. OE correspondientes a las referencias ATE



Referencia anterior / varios

VOLVO

V50 (04-12)	2,0 i			05.2012	24.9145-0005.2	399009	HYDRAULIC CONTROL UNI	36001319	
			10.2006	05.2012	24.9145-0005.2	399009	HYDRAULIC CONTROL UNI	36001319	
	2,4		04.2004		24.9145-0005.2	399009	HYDRAULIC CONTROL UNI	36001319	
				05.2012	24.9145-0005.2	399009	HYDRAULIC CONTROL UNI	36001319	
			04.2004	05.2012	24.9145-0005.2	399009	HYDRAULIC CONTROL UNI	36001319	
	2,4 AWD		08.2006		24.9145-0005.2	399009	HYDRAULIC CONTROL UNI	36001319	
				05.2012	24.9145-0005.2	399009	HYDRAULIC CONTROL UNI	36001319	
			08.2006	05.2012	24.9145-0005.2	399009	HYDRAULIC CONTROL UNI	36001319	
	2,4 D5		03.2006	05.2012	24.9145-0005.2	399009	HYDRAULIC CONTROL UNI	36001319	
				05.2012	24.9145-0005.2	399009	HYDRAULIC CONTROL UNI	36001319	
			03.2006		24.9145-0005.2	399009	HYDRAULIC CONTROL UNI	36001319	
	2,4 Tdi		05.2007	05.2012	24.9145-0005.2	399009	HYDRAULIC CONTROL UNI	36001319	
			05.2007		24.9145-0005.2	399009	HYDRAULIC CONTROL UNI	36001319	
				05.2012	24.9145-0005.2	399009	HYDRAULIC CONTROL UNI	36001319	
	2,5 T5		04.2004		24.9145-0005.2	399009	HYDRAULIC CONTROL UNI	36001319	
			04.2004	05.2012	24.9145-0005.2	399009	HYDRAULIC CONTROL UNI	36001319	
				05.2012	24.9145-0005.2	399009	HYDRAULIC CONTROL UNI	36001319	
			03.2007		24.9145-0005.2	399009	HYDRAULIC CONTROL UNI	36001319	
			03.2007	05.2012	24.9145-0005.2	399009	HYDRAULIC CONTROL UNI	36001319	
	2,5 T5 AWD		04.2004	05.2012	24.9145-0005.2	399009	HYDRAULIC CONTROL UNI	36001319	
			03.2007		24.9145-0005.2	399009	HYDRAULIC CONTROL UNI	36001319	



					Denominación	Ref. OE correspondientes a las referencias ATE	 Referencia anterior / varios
---	---	---	--	---	---------------------	---	--

VOLVO

V50 (04-12)	2,5 T5 AWD		04.2004		24.9145-0005.2	399009	HYDRAULIC CONTROL UNI	36001319	
				05.2012	24.9145-0005.2	399009	HYDRAULIC CONTROL UNI	36001319	
			03.2007	05.2012	24.9145-0005.2	399009	HYDRAULIC CONTROL UNI	36001319	
XC90 (14-)	2,0 D5 AWD		09.2014		24.0120-0247.1	420247	DISCO DE FRENO	31400779	
	2,0 T5 AWD		06.2015		24.0120-0247.1	420247	DISCO DE FRENO	31400779	
	2,0 T6 AWD		09.2014		24.0120-0247.1	420247	DISCO DE FRENO	31400779	
	2,0 T8 Hybrid		09.2014		24.0120-0247.1	420247	DISCO DE FRENO	31400779	
	D5 AWD		09.2014		24.0120-0247.1	420247	DISCO DE FRENO	31400779	

13.0460-7313.2 607313

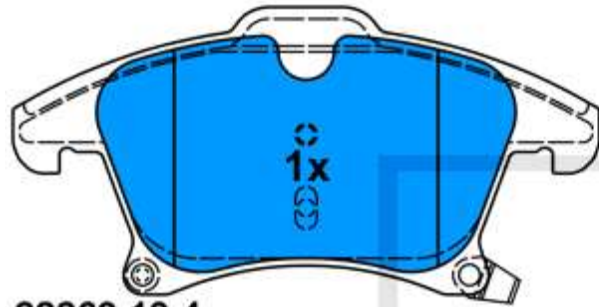

22269 19,4

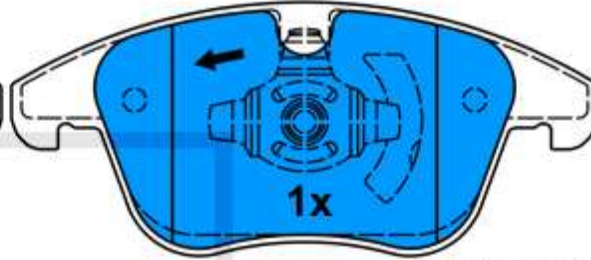

25592 20,3

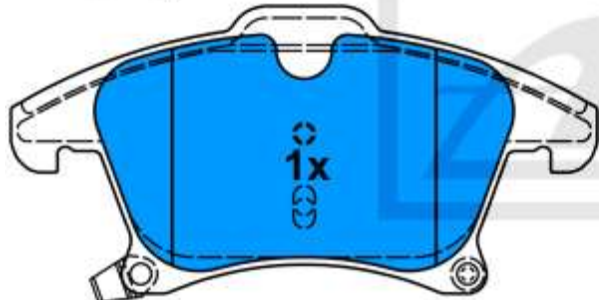

22270 19,4

155,7 x 76,0

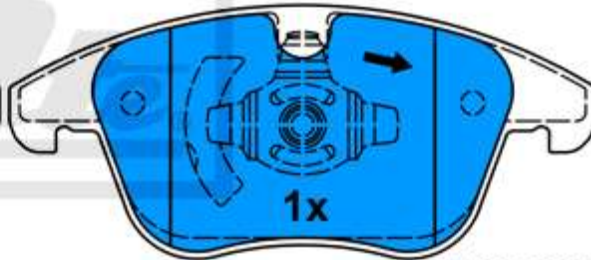

25593 20,3

155,1 x 66,7

Aplicación:

FORD GALAXY III (15-)
FORD MONDEO V (14-)
FORD S-MAX II (15-)

13.0460-3869.2 603869

Aplicación:

PEUGEOT 308 II (T9) (13-)
PEUGEOT 308 II SW (T9) (14-)

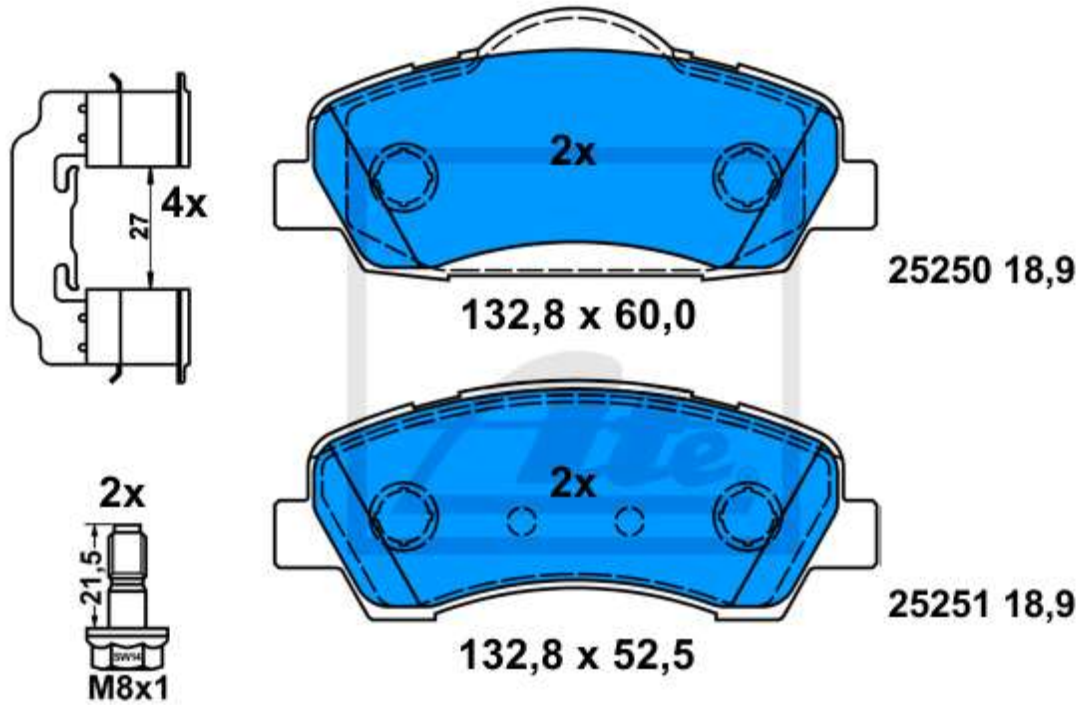

13.0460-7291.2 607291

Aplicación:

HONDA ACCORD VIII Kombi (08-15)
HONDA ACCORD VIII Limousine (08-15)

