



Nuevas referencias en almacén

Por aplicación

07/2017

www.ate.de





Denominación

Ref. OE correspondientes a las referencias ATE



Referencia anterior / varios

ALFA ROMEO

147 (01-10)	1,6 i 16V T,Spark			10.2010	28.0462-2145.1	BAR221	DISCO DE FRENO	5 69 086 , 95511282 , 71711447 , 71711434 , 60815938 , 60813443 , 60801722 , 52015291 , 51996238 , 51990127 , 71739567 , 71739568 , 60699518 , 60578093 , 60658565 , 82427592 , 82450539 , 60622077 , 60571548 , 60569163	
			01.2001	10.2010	28.0462-2145.1	BAR221	DISCO DE FRENO	5 69 086 , 95511282 , 71711447 , 71711434 , 60815938 , 60813443 , 60801722 , 52015291 , 51996238 , 51990127 , 71739567 , 71739568 , 60699518 , 60578093 , 60658565 , 82427592 , 82450539 , 60622077 , 60571548 , 60569163	
	1,9 JTD		01.2001	10.2010	28.0462-2145.1	BAR221	DISCO DE FRENO	5 69 086 , 95511282 , 71711447 , 71711434 , 60815938 , 60813443 , 60801722 , 52015291 , 51996238 , 51990127 , 71739567 , 71739568 , 60699518 , 60578093 , 60658565 , 82427592 , 82450539 , 60622077 , 60571548 , 60569163	
			06.2003	10.2010	28.0462-2145.1	BAR221	DISCO DE FRENO	5 69 086 , 95511282 , 71711447 , 71711434 , 60815938 , 60813443 , 60801722 , 52015291 , 51996238 , 51990127 , 71739567 , 71739568 , 60699518 , 60578093 , 60658565 , 82427592 , 82450539 , 60622077 , 60571548 , 60569163	



Denominación

Ref. OE
correspondientes
a las referencias
ATE



Referencia anterior /
varios

ALFA ROMEO

147 (01-10)	1,9 JTD 16V		11.2002	10.2010	28.0462-2145.1	BAR221	DISCO DE FRENO	5 69 086 , 95511282 , 71711447 , 71711434 , 60815938 , 60813443 , 60801722 , 52015291 , 51996238 , 51990127 , 71739567 , 71739568 , 60699518 , 60578093 , 60658565 , 82427592 , 82450539 , 60622077 , 60571548 , 60569163	
	1,9 JTDM 16V		07.2005	10.2010	28.0462-2145.1	BAR221	DISCO DE FRENO	5 69 086 , 95511282 , 71711447 , 71711434 , 60815938 , 60813443 , 60801722 , 52015291 , 51996238 , 51990127 , 71739567 , 71739568 , 60699518 , 60578093 , 60658565 , 82427592 , 82450539 , 60622077 , 60571548 , 60569163	
	1,9 JTDM 8V		07.2005	10.2010	28.0462-2145.1	BAR221	DISCO DE FRENO	5 69 086 , 95511282 , 71711447 , 71711434 , 60815938 , 60813443 , 60801722 , 52015291 , 51996238 , 51990127 , 71739567 , 71739568 , 60699518 , 60578093 , 60658565 , 82427592 , 82450539 , 60622077 , 60571548 , 60569163	
	2,0 i 16V T,Spark		01.2001	10.2010	28.0462-2145.1	BAR221	DISCO DE FRENO	5 69 086 , 95511282 , 71711447 , 71711434 , 60815938 , 60813443 , 60801722 , 52015291 , 51996238 , 51990127 , 71739567 , 71739568 , 60699518 , 60578093 , 60658565 , 82427592 , 82450539 , 60622077 , 60571548 , 60569163	



Denominación

Ref. OE correspondientes a las referencias ATE



Referencia anterior / varios

ALFA ROMEO

Modelo	Motor	Fecha 1	Fecha 2	Código 1	Código 2	Denominación	Referencias OE	Referencia anterior / varios
156 (97-05)	1,8 i 16V T,Spark	10.1997	07.2005	28.0462-2145.1	BAR221	DISCO DE FRENO	5 69 086 , 95511282 , 71711447 , 71711434 , 60815938 , 60813443 , 60801722 , 52015291 , 51996238 , 51990127 , 71739567 , 71739568 , 60699518 , 60578093 , 60658565 , 82427592 , 82450539 , 60622077 , 60571548 , 60569163	
	1,9 JTD 16V	11.2002	07.2005	28.0462-2145.1	BAR221	DISCO DE FRENO	5 69 086 , 95511282 , 71711447 , 71711434 , 60815938 , 60813443 , 60801722 , 52015291 , 51996238 , 51990127 , 71739567 , 71739568 , 60699518 , 60578093 , 60658565 , 82427592 , 82450539 , 60622077 , 60571548 , 60569163	
	2,0 16V T,Spark	10.1997	07.2005	28.0462-2145.1	BAR221	DISCO DE FRENO	5 69 086 , 95511282 , 71711447 , 71711434 , 60815938 , 60813443 , 60801722 , 52015291 , 51996238 , 51990127 , 71739567 , 71739568 , 60699518 , 60578093 , 60658565 , 82427592 , 82450539 , 60622077 , 60571548 , 60569163	
	2,0 JTS	03.2002	07.2005	28.0462-2145.1	BAR221	DISCO DE FRENO	5 69 086 , 95511282 , 71711447 , 71711434 , 60815938 , 60813443 , 60801722 , 52015291 , 51996238 , 51990127 , 71739567 , 71739568 , 60699518 , 60578093 , 60658565 , 82427592 , 82450539 , 60622077 , 60571548 , 60569163	



					Denominación	Ref. OE correspondientes a las referencias ATE	 Referencia anterior / varios
---	---	---	--	---	---------------------	---	---

ALFA ROMEO

156 (97-05)	2,4 JTD		10.1997	10.2000	28.0462-2145.1	BAR221	DISCO DE FRENO	5 69 086 , 95511282 , 71711447 , 71711434 , 60815938 , 60813443 , 60801722 , 52015291 , 51996238 , 51990127 , 71739567 , 71739568 , 60699518 , 60578093 , 60658565 , 82427592 , 82450539 , 60622077 , 60571548 , 60569163	
			03.2002	07.2005	28.0462-2145.1	BAR221	DISCO DE FRENO	5 69 086 , 95511282 , 71711447 , 71711434 , 60815938 , 60813443 , 60801722 , 52015291 , 51996238 , 51990127 , 71739567 , 71739568 , 60699518 , 60578093 , 60658565 , 82427592 , 82450539 , 60622077 , 60571548 , 60569163	
			10.2000	07.2005	28.0462-2145.1	BAR221	DISCO DE FRENO	5 69 086 , 95511282 , 71711447 , 71711434 , 60815938 , 60813443 , 60801722 , 52015291 , 51996238 , 51990127 , 71739567 , 71739568 , 60699518 , 60578093 , 60658565 , 82427592 , 82450539 , 60622077 , 60571548 , 60569163	
			10.2003	07.2005	28.0462-2145.1	BAR221	DISCO DE FRENO	5 69 086 , 95511282 , 71711447 , 71711434 , 60815938 , 60813443 , 60801722 , 52015291 , 51996238 , 51990127 , 71739567 , 71739568 , 60699518 , 60578093 , 60658565 , 82427592 , 82450539 , 60622077 , 60571548 , 60569163	



Denominación

Ref. OE
correspondientes
a las referencias
ATE

Referencia anterior /
varios

ALFA ROMEO

Modelo	Motor	Fecha 1	Fecha 2	Código 1	Código 2	Denominación	Referencias
156 (97-05)	2,5 V6 24V	10.1997	07.2005	28.0462-2145.1	BAR221	DISCO DE FRENO	5 69 086 , 95511282 , 71711447 , 71711434 , 60815938 , 60813443 , 60801722 , 52015291 , 51996238 , 51990127 , 71739567 , 71739568 , 60699518 , 60578093 , 60658565 , 82427592 , 82450539 , 60622077 , 60571548 , 60569163
164 (92-98)	2,0 T,Spark	09.1991	09.1998	28.0461-0190.1	BAR101	DISCO DE FRENO	60801753 , 60801390 , 16420.26100.01/00 , 46831042 , 46758715 , 60801755 , 82434070 , 82433859 , 82394418
	2,0 Turbo	09.1991	09.1998	28.0462-2145.1	BAR221	DISCO DE FRENO	5 69 086 , 95511282 , 71711447 , 71711434 , 60815938 , 60813443 , 60801722 , 52015291 , 51996238 , 51990127 , 71739567 , 71739568 , 60699518 , 60578093 , 60658565 , 82427592 , 82450539 , 60622077 , 60571548 , 60569163
GT (04-10)	1,8 TS	11.2003	07.2010	28.0462-2145.1	BAR221	DISCO DE FRENO	5 69 086 , 95511282 , 71711447 , 71711434 , 60815938 , 60813443 , 60801722 , 52015291 , 51996238 , 51990127 , 71739567 , 71739568 , 60699518 , 60578093 , 60658565 , 82427592 , 82450539 , 60622077 , 60571548 , 60569163



Denominación

Ref. OE correspondientes a las referencias ATE



Referencia anterior / varios

ALFA ROMEO

Modelo	Motor	Fecha 1	Fecha 2	Código 1	Código 2	Denominación	Ref. OE correspondientes a las referencias ATE	Referencia anterior / varios
GT (04-10)	1,9 JTD	05.2008	07.2010	28.0462-2145.1	BAR221	DISCO DE FRENO	5 69 086 , 95511282 , 71711447 , 71711434 , 60815938 , 60813443 , 60801722 , 52015291 , 51996238 , 51990127 , 71739567 , 71739568 , 60699518 , 60578093 , 60658565 , 82427592 , 82450539 , 60622077 , 60571548 , 60569163	
		11.2003	07.2010	28.0462-2145.1	BAR221	DISCO DE FRENO	5 69 086 , 95511282 , 71711447 , 71711434 , 60815938 , 60813443 , 60801722 , 52015291 , 51996238 , 51990127 , 71739567 , 71739568 , 60699518 , 60578093 , 60658565 , 82427592 , 82450539 , 60622077 , 60571548 , 60569163	
	2,0 JTS	11.2003	07.2010	28.0462-2145.1	BAR221	DISCO DE FRENO	5 69 086 , 95511282 , 71711447 , 71711434 , 60815938 , 60813443 , 60801722 , 52015291 , 51996238 , 51990127 , 71739567 , 71739568 , 60699518 , 60578093 , 60658565 , 82427592 , 82450539 , 60622077 , 60571548 , 60569163	
GTV (95-05)	2,0 i V6 Turbo	05.1995	12.2005	28.0462-2145.1	BAR221	DISCO DE FRENO	5 69 086 , 95511282 , 71711447 , 71711434 , 60815938 , 60813443 , 60801722 , 52015291 , 51996238 , 51990127 , 71739567 , 71739568 , 60699518 , 60578093 , 60658565 , 82427592 , 82450539 , 60622077 , 60571548 , 60569163	



				Denominación	Ref. OE correspondientes a las referencias ATE	 Referencia anterior / varios
---	---	--	---	---------------------	---	---

ALFA ROMEO

SPIDER (95-05)	2,0 i V6 Turbo		05.1998	12.2005	28.0462-2145.1	BAR221	DISCO DE FRENO	5 69 086 , 95511282 , 71711447 , 71711434 , 60815938 , 60813443 , 60801722 , 52015291 , 51996238 , 51990127 , 71739567 , 71739568 , 60699518 , 60578093 , 60658565 , 82427592 , 82450539 , 60622077 , 60571548 , 60569163	
----------------	----------------	--	---------	---------	----------------	--------	----------------	--	--



Denominación

Ref. OE correspondientes a las referencias ATE

Referencia anterior / varios

AUDI

Audi Model	Motor	Year	Start	End	Part No.	ATE Ref.	Denominación	Ref. OE correspondientes a las referencias ATE	Referencia anterior / varios
A2 (00-05)	1,4 TDI	TD	11.2003	07.2005	24.3344-1710.5	240811	PINZA DE GARRA	6Q0 615 424 B , 6Q0 615 424 A	
	1,6 FSI	TD	05.2002	07.2005	24.3344-1710.5	240811	PINZA DE GARRA	6Q0 615 424 B , 6Q0 615 424 A	
A3 / A3 (8P) Sportback (03-13)	1,2 TSI	TI	04.2010	08.2013	24.3414-1709.5	240834	PINZA DE GARRA	1K0 615 423 M , 1K0 615 423 H , 1K0 615 423 C , 1K0 615 423	24.3414-1709.7
		TD	04.2010	08.2013	24.3414-1710.5	240835	PINZA DE GARRA	1K0 615 424 M , 1K0 615 424 H , 1K0 615 424 C , 1K0 615 424	24.3414-1710.7-
	1,4 TFSI	TI	07.2007	08.2013	24.3414-1709.5	240834	PINZA DE GARRA	1K0 615 423 M , 1K0 615 423 H , 1K0 615 423 C , 1K0 615 423	24.3414-1709.7
		TD	07.2007	08.2013	24.3414-1710.5	240835	PINZA DE GARRA	1K0 615 424 M , 1K0 615 424 H , 1K0 615 424 C , 1K0 615 424	24.3414-1710.7-
	1,6	TI	05.2003	08.2013	24.3414-1709.5	240834	PINZA DE GARRA	1K0 615 423 M , 1K0 615 423 H , 1K0 615 423 C , 1K0 615 423	24.3414-1709.7
		TD	05.2003	08.2013	24.3414-1710.5	240835	PINZA DE GARRA	1K0 615 424 M , 1K0 615 424 H , 1K0 615 424 C , 1K0 615 424	24.3414-1710.7-
	1,6 FSI	TD	08.2003	08.2013	24.3414-1710.5	240835	PINZA DE GARRA	1K0 615 424 M , 1K0 615 424 H , 1K0 615 424 C , 1K0 615 424	24.3414-1710.7-
		TI	08.2003	08.2013	24.3414-1709.5	240834	PINZA DE GARRA	1K0 615 423 M , 1K0 615 423 H , 1K0 615 423 C , 1K0 615 423	24.3414-1709.7
	1,6 TDI	TI	05.2009	08.2013	24.3414-1709.5	240834	PINZA DE GARRA	1K0 615 423 M , 1K0 615 423 H , 1K0 615 423 C , 1K0 615 423	24.3414-1709.7



Denominación

Ref. OE correspondientes a las referencias ATE

Referencia anterior / varios

AUDI

A3 / A3 (8P) Sportback (03-13)	1,6 TDI	TD	05.2009	08.2013	24.3414-1710.5	240835	PINZA DE GARRA	1K0 615 424 M , 1K0 615 424 H , 1K0 615 424 C , 1K0 615 424	24.3414-1710.7-
	1,8 TFSI	TI	01.2007	08.2013	24.3414-1709.5	240834	PINZA DE GARRA	1K0 615 423 M , 1K0 615 423 H , 1K0 615 423 C , 1K0 615 423	24.3414-1709.7
		TD	01.2007	08.2013	24.3414-1710.5	240835	PINZA DE GARRA	1K0 615 424 M , 1K0 615 424 H , 1K0 615 424 C , 1K0 615 424	24.3414-1710.7-
	1,8 TFSI quattro	TI	05.2008	08.2013	24.3414-1709.5	240834	PINZA DE GARRA	1K0 615 423 M , 1K0 615 423 H , 1K0 615 423 C , 1K0 615 423	24.3414-1709.7
		TD	05.2008	08.2013	24.3414-1710.5	240835	PINZA DE GARRA	1K0 615 424 M , 1K0 615 424 H , 1K0 615 424 C , 1K0 615 424	24.3414-1710.7-
	1,9 TDI	TD	06.2003	08.2013	24.3414-1710.5	240835	PINZA DE GARRA	1K0 615 424 M , 1K0 615 424 H , 1K0 615 424 C , 1K0 615 424	24.3414-1710.7-
		TI	06.2003	08.2013	24.3414-1709.5	240834	PINZA DE GARRA	1K0 615 423 M , 1K0 615 423 H , 1K0 615 423 C , 1K0 615 423	24.3414-1709.7
	2,0 FSI	TD	05.2003	08.2013	24.3414-1710.5	240835	PINZA DE GARRA	1K0 615 424 M , 1K0 615 424 H , 1K0 615 424 C , 1K0 615 424	24.3414-1710.7-
		TI	05.2003	08.2013	24.3414-1709.5	240834	PINZA DE GARRA	1K0 615 423 M , 1K0 615 423 H , 1K0 615 423 C , 1K0 615 423	24.3414-1709.7
	2,0 TDI	TI	05.2003	08.2013	24.3414-1709.5	240834	PINZA DE GARRA	1K0 615 423 M , 1K0 615 423 H , 1K0 615 423 C , 1K0 615 423	24.3414-1709.7
		TI	03.2006	08.2013	24.3414-1709.5	240834	PINZA DE GARRA	1K0 615 423 M , 1K0 615 423 H , 1K0 615 423 C , 1K0 615 423	24.3414-1709.7



Denominación

Ref. OE correspondientes a las referencias ATE

Referencia anterior / varios

AUDI

A3 / A3 (8P) Sportback (03-13)	2,0 TDI	TD	05.2003	08.2013	24.3414-1710.5	240835	PINZA DE GARRA	1K0 615 424 M , 1K0 615 424 H , 1K0 615 424 C , 1K0 615 424	24.3414-1710.7-
		TI	06.2006	06.2008	24.3414-1709.5	240834	PINZA DE GARRA	1K0 615 423 M , 1K0 615 423 H , 1K0 615 423 C , 1K0 615 423	24.3414-1709.7
		TD	06.2006	06.2008	24.3414-1710.5	240835	PINZA DE GARRA	1K0 615 424 M , 1K0 615 424 H , 1K0 615 424 C , 1K0 615 424	24.3414-1710.7-
		TD	03.2006	08.2013	24.3414-1710.5	240835	PINZA DE GARRA	1K0 615 424 M , 1K0 615 424 H , 1K0 615 424 C , 1K0 615 424	24.3414-1710.7-
	2,0 TDI quattro	TD	05.2003	08.2013	24.3414-1710.5	240835	PINZA DE GARRA	1K0 615 424 M , 1K0 615 424 H , 1K0 615 424 C , 1K0 615 424	24.3414-1710.7-
		TD	08.2004	08.2013	24.3414-1710.5	240835	PINZA DE GARRA	1K0 615 424 M , 1K0 615 424 H , 1K0 615 424 C , 1K0 615 424	24.3414-1710.7-
		TI	08.2004	08.2013	24.3414-1709.5	240834	PINZA DE GARRA	1K0 615 423 M , 1K0 615 423 H , 1K0 615 423 C , 1K0 615 423	24.3414-1709.7
		TI	05.2003	08.2013	24.3414-1709.5	240834	PINZA DE GARRA	1K0 615 423 M , 1K0 615 423 H , 1K0 615 423 C , 1K0 615 423	24.3414-1709.7
		TI	03.2006	08.2013	24.3414-1709.5	240834	PINZA DE GARRA	1K0 615 423 M , 1K0 615 423 H , 1K0 615 423 C , 1K0 615 423	24.3414-1709.7
		TD	03.2006	08.2013	24.3414-1710.5	240835	PINZA DE GARRA	1K0 615 424 M , 1K0 615 424 H , 1K0 615 424 C , 1K0 615 424	24.3414-1710.7-
	2,0 TFSI	TD	06.2004	08.2013	24.3414-1710.5	240835	PINZA DE GARRA	1K0 615 424 M , 1K0 615 424 H , 1K0 615 424 C , 1K0 615 424	24.3414-1710.7-



Denominación

Ref. OE correspondientes a las referencias ATE



Referencia anterior / varios

AUDI

A3 / A3 (8P) Sportback (03-13)	2,0 TFSI	TI	06.2004	08.2013	24.3414-1709.5	240834	PINZA DE GARRA	1K0 615 423 M , 1K0 615 423 H , 1K0 615 423 C , 1K0 615 423	24.3414-1709.7
	2,0 TFSI quattro	TD	06.2004	08.2013	24.3414-1710.5	240835	PINZA DE GARRA	1K0 615 424 M , 1K0 615 424 H , 1K0 615 424 C , 1K0 615 424	24.3414-1710.7-
		TI	06.2004	08.2013	24.3414-1709.5	240834	PINZA DE GARRA	1K0 615 423 M , 1K0 615 423 H , 1K0 615 423 C , 1K0 615 423	24.3414-1709.7
	3,2 quattro	TD	07.2003	08.2013	24.3414-1710.5	240835	PINZA DE GARRA	1K0 615 424 M , 1K0 615 424 H , 1K0 615 424 C , 1K0 615 424	24.3414-1710.7-
		TI	07.2003	08.2013	24.3414-1709.5	240834	PINZA DE GARRA	1K0 615 423 M , 1K0 615 423 H , 1K0 615 423 C , 1K0 615 423	24.3414-1709.7
A6 (4G2/C7) Limousine (11-)	1,8 TFSI	DD	09.2014		24.3601-1732.5	240805	PINZA DE GARRA	4G0 615 124 C , 4G0 615 124	
		DI	09.2014		24.3601-1731.5	240804	PINZA DE GARRA	4G0 615 123 C , 4G0 615 123	
		TI	09.2014		24.6243-1723.5	240798	PINZA DE GARRA	4G0 615 403 A	
	2,0 TDI	DD	09.2014		24.3601-1732.5	240805	PINZA DE GARRA	4G0 615 124 C , 4G0 615 124	
		DD	04.2011		24.3601-1732.5	240805	PINZA DE GARRA	4G0 615 124 C , 4G0 615 124	
		DD	01.2012		24.3601-1732.5	240805	PINZA DE GARRA	4G0 615 124 C , 4G0 615 124	
		DI	01.2012		24.3601-1731.5	240804	PINZA DE GARRA	4G0 615 123 C , 4G0 615 123	
		DI	04.2011		24.3601-1731.5	240804	PINZA DE GARRA	4G0 615 123 C , 4G0 615 123	
		DI	09.2014		24.3601-1731.5	240804	PINZA DE GARRA	4G0 615 123 C , 4G0 615 123	
		TI	01.2012		24.6243-1723.5	240798	PINZA DE GARRA	4G0 615 403 A	
		TI	04.2011		24.6243-1723.5	240798	PINZA DE GARRA	4G0 615 403 A	



Denominación

Ref. OE correspondientes a las referencias ATE

Referencia anterior / varios

AUDI

Audi Model	Engine	Code	Date	ATE Part No.	ATE Ref.	Denominación	Ref. OE correspondientes a las referencias ATE	Referencia anterior / varios
A6 (4G2/C7) Limousine (11-)	2,0 TDI	TI	09.2014	24.6243-1723.5	240798	PINZA DE GARRA	4G0 615 403 A	
	2,0 TDI quattro	TI	04.2015	24.6243-1723.5	240798	PINZA DE GARRA	4G0 615 403 A	
		DD	04.2015	24.3601-1732.5	240805	PINZA DE GARRA	4G0 615 124 C , 4G0 615 124	
		DI	04.2015	24.3601-1731.5	240804	PINZA DE GARRA	4G0 615 123 C , 4G0 615 123	
	2,0 TDI ultra	DI	11.2013	24.3601-1731.5	240804	PINZA DE GARRA	4G0 615 123 C , 4G0 615 123	
		TI	11.2013	24.6243-1723.5	240798	PINZA DE GARRA	4G0 615 403 A	
		DD	11.2013	24.3601-1732.5	240805	PINZA DE GARRA	4G0 615 124 C , 4G0 615 124	
	2,0 TFSI	DI	09.2014	24.3601-1731.5	240804	PINZA DE GARRA	4G0 615 123 C , 4G0 615 123	
		DD	09.2014	24.3601-1732.5	240805	PINZA DE GARRA	4G0 615 124 C , 4G0 615 124	
		TI	04.2011	24.6243-1723.5	240798	PINZA DE GARRA	4G0 615 403 A	
		TI	05.2013	24.6243-1723.5	240798	PINZA DE GARRA	4G0 615 403 A	
		TI	09.2014	24.6243-1723.5	240798	PINZA DE GARRA	4G0 615 403 A	
		DI	05.2013	24.3601-1731.5	240804	PINZA DE GARRA	4G0 615 123 C , 4G0 615 123	
		DD	04.2011	24.3601-1732.5	240805	PINZA DE GARRA	4G0 615 124 C , 4G0 615 124	
		DD	05.2013	24.3601-1732.5	240805	PINZA DE GARRA	4G0 615 124 C , 4G0 615 124	
		DI	04.2011	24.3601-1731.5	240804	PINZA DE GARRA	4G0 615 123 C , 4G0 615 123	
	2,0 TFSI hybrid	DD	11.2011	24.3601-1732.5	240805	PINZA DE GARRA	4G0 615 124 C , 4G0 615 124	
		TI	11.2011	24.6243-1723.5	240798	PINZA DE GARRA	4G0 615 403 A	
		DI	11.2011	24.3601-1731.5	240804	PINZA DE GARRA	4G0 615 123 C , 4G0 615 123	
	2,0 TFSI quattro	DD	05.2014	24.3601-1732.5	240805	PINZA DE GARRA	4G0 615 124 C , 4G0 615 124	
		DI	05.2014	24.3601-1731.5	240804	PINZA DE GARRA	4G0 615 123 C , 4G0 615 123	



Denominación

Ref. OE correspondientes a las referencias ATE

Referencia anterior / varios

AUDI

Modelo	Motor	DI	Fecha	Ref. ATE	Ref. OE	Denominación	Ref. OE correspondientes a las referencias ATE	Referencia anterior / varios
A6 (4G2/C7) Limousine (11-)	2,0 TFSI quattro	DI	05.2013	24.3601-1731.5	240804	PINZA DE GARRA	4G0 615 123 C , 4G0 615 123	
		DI	05.2012	24.3601-1731.5	240804	PINZA DE GARRA	4G0 615 123 C , 4G0 615 123	
		TI	05.2014	24.6243-1723.5	240798	PINZA DE GARRA	4G0 615 403 A	
		TI	05.2012	24.6243-1723.5	240798	PINZA DE GARRA	4G0 615 403 A	
		TI	05.2013	24.6243-1723.5	240798	PINZA DE GARRA	4G0 615 403 A	
	2,8 FSI	DD	05.2013	24.3601-1732.5	240805	PINZA DE GARRA	4G0 615 124 C , 4G0 615 124	
		DD	05.2012	24.3601-1732.5	240805	PINZA DE GARRA	4G0 615 124 C , 4G0 615 124	
		DI	04.2011	24.3601-1731.5	240804	PINZA DE GARRA	4G0 615 123 C , 4G0 615 123	
		DD	04.2011	24.3601-1732.5	240805	PINZA DE GARRA	4G0 615 124 C , 4G0 615 124	
		TI	04.2011	24.6243-1723.5	240798	PINZA DE GARRA	4G0 615 403 A	
2,8 FSI quattro	DD	09.2014	24.3601-1732.5	240805	PINZA DE GARRA	4G0 615 124 C , 4G0 615 124		
	DI	09.2014	24.3601-1731.5	240804	PINZA DE GARRA	4G0 615 123 C , 4G0 615 123		
	DI	04.2011	24.3601-1731.5	240804	PINZA DE GARRA	4G0 615 123 C , 4G0 615 123		
	DD	04.2011	24.3601-1732.5	240805	PINZA DE GARRA	4G0 615 124 C , 4G0 615 124		
	TI	04.2011	24.6243-1723.5	240798	PINZA DE GARRA	4G0 615 403 A		
	TI	09.2014	24.6243-1723.5	240798	PINZA DE GARRA	4G0 615 403 A		
3,0 TDI	DD	09.2014	24.3601-1732.5	240805	PINZA DE GARRA	4G0 615 124 C , 4G0 615 124		
	DI	09.2014	24.3601-1731.5	240804	PINZA DE GARRA	4G0 615 123 C , 4G0 615 123		
	DI	04.2011	24.3601-1731.5	240804	PINZA DE GARRA	4G0 615 123 C , 4G0 615 123		
	DD	04.2011	24.3601-1732.5	240805	PINZA DE GARRA	4G0 615 124 C , 4G0 615 124		
	TI	09.2014	24.6243-1723.5	240798	PINZA DE GARRA	4G0 615 403 A		



Denominación

Ref. OE correspondientes a las referencias ATE

Referencia anterior / varios

AUDI

Audi Model	Engine	TI	DI	DD	ATE Part No.	ATE Ref.	Denominación	Ref. OE correspondientes a las referencias ATE	Referencia anterior / varios
A6 (4G2/C7) Limousine (11-)	3,0 TDI	TI	04.2011		24.6243-1723.5	240798	PINZA DE GARRA	4G0 615 403 A	
	3,0 TDI quattro	DI	09.2014		24.3601-1731.5	240804	PINZA DE GARRA	4G0 615 123 C , 4G0 615 123	
		TI	09.2014		24.6243-1723.5	240798	PINZA DE GARRA	4G0 615 403 A	
		TI	05.2013		24.6243-1723.5	240798	PINZA DE GARRA	4G0 615 403 A	
		DI	12.2011		24.3601-1731.5	240804	PINZA DE GARRA	4G0 615 123 C , 4G0 615 123	
		DI	04.2011		24.3601-1731.5	240804	PINZA DE GARRA	4G0 615 123 C , 4G0 615 123	
		DI	05.2013		24.3601-1731.5	240804	PINZA DE GARRA	4G0 615 123 C , 4G0 615 123	
		TI	04.2011		24.6243-1723.5	240798	PINZA DE GARRA	4G0 615 403 A	
		DD	05.2013		24.3601-1732.5	240805	PINZA DE GARRA	4G0 615 124 C , 4G0 615 124	
		TI	12.2011		24.6243-1723.5	240798	PINZA DE GARRA	4G0 615 403 A	
		DD	09.2014		24.3601-1732.5	240805	PINZA DE GARRA	4G0 615 124 C , 4G0 615 124	
		DD	04.2011		24.3601-1732.5	240805	PINZA DE GARRA	4G0 615 124 C , 4G0 615 124	
		DD	12.2011		24.3601-1732.5	240805	PINZA DE GARRA	4G0 615 124 C , 4G0 615 124	
	3,0 TFSI quattro	TI	04.2011		24.6243-1723.5	240798	PINZA DE GARRA	4G0 615 403 A	
		DI	04.2011		24.3601-1731.5	240804	PINZA DE GARRA	4G0 615 123 C , 4G0 615 123	
		DD	04.2011		24.3601-1732.5	240805	PINZA DE GARRA	4G0 615 124 C , 4G0 615 124	
		DD	09.2014		24.3601-1732.5	240805	PINZA DE GARRA	4G0 615 124 C , 4G0 615 124	
		DI	09.2014		24.3601-1731.5	240804	PINZA DE GARRA	4G0 615 123 C , 4G0 615 123	
		TI	09.2014		24.6243-1723.5	240798	PINZA DE GARRA	4G0 615 403 A	
	S6	TI	10.2014		24.6243-1723.5	240798	PINZA DE GARRA	4G0 615 403 A	
		DI	10.2014		24.3601-1731.5	240804	PINZA DE GARRA	4G0 615 123 C , 4G0 615 123	



Denominación

Ref. OE correspondientes a las referencias ATE

Referencia anterior / varios

AUDI

Modelo	Motor	TI	Fecha	Ref. ATE	Ref. OE	Denominación	Ref. OE correspondientes a las referencias ATE	Referencia anterior / varios
A6 (4G2/C7) Limousine (11-)	S6	TI	04.2012	24.6243-1723.5	240798	PINZA DE GARRA	4G0 615 403 A	
		DD	10.2014	24.3601-1732.5	240805	PINZA DE GARRA	4G0 615 124 C , 4G0 615 124	
		DD	04.2012	24.3601-1732.5	240805	PINZA DE GARRA	4G0 615 124 C , 4G0 615 124	
		DI	04.2012	24.3601-1731.5	240804	PINZA DE GARRA	4G0 615 123 C , 4G0 615 123	
A6 (4G5/C7) Avant (11-)	1,8 TFSI	DI	09.2014	24.3601-1731.5	240804	PINZA DE GARRA	4G0 615 123 C , 4G0 615 123	
		TI	09.2014	24.6243-1723.5	240798	PINZA DE GARRA	4G0 615 403 A	
	2,0 TDI	DD	09.2014	24.3601-1732.5	240805	PINZA DE GARRA	4G0 615 124 C , 4G0 615 124	
		TI	09.2014	24.6243-1723.5	240798	PINZA DE GARRA	4G0 615 403 A	
		TI	09.2011	24.6243-1723.5	240798	PINZA DE GARRA	4G0 615 403 A	
		TI	01.2012	24.6243-1723.5	240798	PINZA DE GARRA	4G0 615 403 A	
		DI	09.2011	24.3601-1731.5	240804	PINZA DE GARRA	4G0 615 123 C , 4G0 615 123	
		DI	09.2014	24.3601-1731.5	240804	PINZA DE GARRA	4G0 615 123 C , 4G0 615 123	
		DD	09.2011	24.3601-1732.5	240805	PINZA DE GARRA	4G0 615 124 C , 4G0 615 124	
		DD	09.2014	24.3601-1732.5	240805	PINZA DE GARRA	4G0 615 124 C , 4G0 615 124	
2,0 TDI quattro	DD	01.2012	24.3601-1732.5	240805	PINZA DE GARRA	4G0 615 124 C , 4G0 615 124		
	DI	01.2012	24.3601-1731.5	240804	PINZA DE GARRA	4G0 615 123 C , 4G0 615 123		
	DD	04.2015	24.3601-1732.5	240805	PINZA DE GARRA	4G0 615 124 C , 4G0 615 124		
	TI	04.2015	24.6243-1723.5	240798	PINZA DE GARRA	4G0 615 403 A		
2,0 TDI ultra	DI	04.2015	24.3601-1731.5	240804	PINZA DE GARRA	4G0 615 123 C , 4G0 615 123		
	TI	11.2013	24.6243-1723.5	240798	PINZA DE GARRA	4G0 615 403 A		
	DD	11.2013	24.3601-1732.5	240805	PINZA DE GARRA	4G0 615 124 C , 4G0 615 124		



Denominación

Ref. OE correspondientes a las referencias ATE

Referencia anterior / varios

AUDI

Audi Model	Engine	Type	Start Date	ATE Part No.	ATE Part No.	Denominación	Ref. OE correspondientes a las referencias ATE	Referencia anterior / varios
A6 (4G5/C7) Avant (11-)	2,0 TDI ultra	DI	11.2013	24.3601-1731.5	240804	PINZA DE GARRA	4G0 615 123 C , 4G0 615 123	
	2,0 TFSI	TI	06.2011	24.6243-1723.5	240798	PINZA DE GARRA	4G0 615 403 A	
		TI	09.2014	24.6243-1723.5	240798	PINZA DE GARRA	4G0 615 403 A	
		DI	06.2011	24.3601-1731.5	240804	PINZA DE GARRA	4G0 615 123 C , 4G0 615 123	
		DI	09.2014	24.3601-1731.5	240804	PINZA DE GARRA	4G0 615 123 C , 4G0 615 123	
		DD	06.2011	24.3601-1732.5	240805	PINZA DE GARRA	4G0 615 124 C , 4G0 615 124	
		DD	09.2014	24.3601-1732.5	240805	PINZA DE GARRA	4G0 615 124 C , 4G0 615 124	
	2,0 TFSI quattro	TI	05.2015	24.6243-1723.5	240798	PINZA DE GARRA	4G0 615 403 A	
		DI	05.2015	24.3601-1731.5	240804	PINZA DE GARRA	4G0 615 123 C , 4G0 615 123	
		DD	05.2015	24.3601-1732.5	240805	PINZA DE GARRA	4G0 615 124 C , 4G0 615 124	
	2,8 FSI	TI	09.2011	24.6243-1723.5	240798	PINZA DE GARRA	4G0 615 403 A	
		DI	09.2011	24.3601-1731.5	240804	PINZA DE GARRA	4G0 615 123 C , 4G0 615 123	
		DD	09.2011	24.3601-1732.5	240805	PINZA DE GARRA	4G0 615 124 C , 4G0 615 124	
	2,8 FSI quattro	TI	09.2014	24.6243-1723.5	240798	PINZA DE GARRA	4G0 615 403 A	
		TI	09.2011	24.6243-1723.5	240798	PINZA DE GARRA	4G0 615 403 A	
		DI	09.2011	24.3601-1731.5	240804	PINZA DE GARRA	4G0 615 123 C , 4G0 615 123	
		DD	09.2014	24.3601-1732.5	240805	PINZA DE GARRA	4G0 615 124 C , 4G0 615 124	
		DD	09.2011	24.3601-1732.5	240805	PINZA DE GARRA	4G0 615 124 C , 4G0 615 124	
		DI	09.2014	24.3601-1731.5	240804	PINZA DE GARRA	4G0 615 123 C , 4G0 615 123	
	3,0 TDI	DD	09.2014	24.3601-1732.5	240805	PINZA DE GARRA	4G0 615 124 C , 4G0 615 124	
		TI	09.2014	24.6243-1723.5	240798	PINZA DE GARRA	4G0 615 403 A	



Denominación

Ref. OE correspondientes a las referencias ATE

Referencia anterior / varios

AUDI

Audi Model	Engine	Code	Date	Part No.	ATE No.	Denominación	Ref. OE correspondientes a las referencias ATE	Referencia anterior / varios
A6 (4G5/C7) Avant (11-)	3,0 TDI	TI	09.2011	24.6243-1723.5	240798	PINZA DE GARRA	4G0 615 403 A	
		DD	09.2011	24.3601-1732.5	240805	PINZA DE GARRA	4G0 615 124 C , 4G0 615 124	
		DI	09.2014	24.3601-1731.5	240804	PINZA DE GARRA	4G0 615 123 C , 4G0 615 123	
		DI	09.2011	24.3601-1731.5	240804	PINZA DE GARRA	4G0 615 123 C , 4G0 615 123	
	3,0 TDI quattro	DI	09.2011	24.3601-1731.5	240804	PINZA DE GARRA	4G0 615 123 C , 4G0 615 123	
		TI	09.2014	24.6243-1723.5	240798	PINZA DE GARRA	4G0 615 403 A	
		TI	09.2011	24.6243-1723.5	240798	PINZA DE GARRA	4G0 615 403 A	
		TI	12.2011	24.6243-1723.5	240798	PINZA DE GARRA	4G0 615 403 A	
		DI	09.2014	24.3601-1731.5	240804	PINZA DE GARRA	4G0 615 123 C , 4G0 615 123	
		DD	12.2011	24.3601-1732.5	240805	PINZA DE GARRA	4G0 615 124 C , 4G0 615 124	
		DD	09.2014	24.3601-1732.5	240805	PINZA DE GARRA	4G0 615 124 C , 4G0 615 124	
		DD	09.2011	24.3601-1732.5	240805	PINZA DE GARRA	4G0 615 124 C , 4G0 615 124	
		DI	12.2011	24.3601-1731.5	240804	PINZA DE GARRA	4G0 615 123 C , 4G0 615 123	
	3,0 TFSI quattro	DD	09.2014	24.3601-1732.5	240805	PINZA DE GARRA	4G0 615 124 C , 4G0 615 124	
		DI	09.2011	24.3601-1731.5	240804	PINZA DE GARRA	4G0 615 123 C , 4G0 615 123	
		DI	09.2014	24.3601-1731.5	240804	PINZA DE GARRA	4G0 615 123 C , 4G0 615 123	
		TI	09.2014	24.6243-1723.5	240798	PINZA DE GARRA	4G0 615 403 A	
		TI	09.2011	24.6243-1723.5	240798	PINZA DE GARRA	4G0 615 403 A	
		DD	09.2011	24.3601-1732.5	240805	PINZA DE GARRA	4G0 615 124 C , 4G0 615 124	
	S6	TI	09.2014	24.6243-1723.5	240798	PINZA DE GARRA	4G0 615 403 A	
		TI	04.2012	24.6243-1723.5	240798	PINZA DE GARRA	4G0 615 403 A	



Denominación

Ref. OE correspondientes a las referencias ATE

Referencia anterior / varios

AUDI

Modelo	Motor	TI	Fecha	Ref. ATE	Ref. OE	Denominación	Ref. OE correspondientes a las referencias ATE	Referencia anterior / varios
A6 (4G5/C7) Avant (11-)	S6	DI	04.2012	24.3601-1731.5	240804	PINZA DE GARRA	4G0 615 123 C , 4G0 615 123	
		DD	09.2014	24.3601-1732.5	240805	PINZA DE GARRA	4G0 615 124 C , 4G0 615 124	
		DD	04.2012	24.3601-1732.5	240805	PINZA DE GARRA	4G0 615 124 C , 4G0 615 124	
		DI	09.2014	24.3601-1731.5	240804	PINZA DE GARRA	4G0 615 123 C , 4G0 615 123	
A6 Allroad (12-)	3,0 TDI quattro	TI	01.2012	24.6243-1723.5	240798	PINZA DE GARRA	4G0 615 403 A	
		TI	09.2014	24.6243-1723.5	240798	PINZA DE GARRA	4G0 615 403 A	
		TI	11.2015	24.6243-1723.5	240798	PINZA DE GARRA	4G0 615 403 A	
	3,0 TFSI quattro	TI	01.2012	24.6243-1723.5	240798	PINZA DE GARRA	4G0 615 403 A	
TI		09.2014	24.6243-1723.5	240798	PINZA DE GARRA	4G0 615 403 A		
A7 Sportback (10-)	1,8 TFSI	TI	04.2015	24.6243-1723.5	240798	PINZA DE GARRA	4G0 615 403 A	
		DD	04.2015	24.3601-1732.5	240805	PINZA DE GARRA	4G0 615 124 C , 4G0 615 124	
		DI	04.2015	24.3601-1731.5	240804	PINZA DE GARRA	4G0 615 123 C , 4G0 615 123	
	2,0 TFSI	TI	09.2014	24.6243-1723.5	240798	PINZA DE GARRA	4G0 615 403 A	
		DD	09.2014	24.3601-1732.5	240805	PINZA DE GARRA	4G0 615 124 C , 4G0 615 124	
	2,0 TFSI quattro	DI	09.2014	24.3601-1731.5	240804	PINZA DE GARRA	4G0 615 123 C , 4G0 615 123	
		TI	05.2015	24.6243-1723.5	240798	PINZA DE GARRA	4G0 615 403 A	
		DD	05.2015	24.3601-1732.5	240805	PINZA DE GARRA	4G0 615 124 C , 4G0 615 124	
		DI	05.2015	24.3601-1731.5	240804	PINZA DE GARRA	4G0 615 123 C , 4G0 615 123	
2,8 FSI	DI	05.2011	24.3601-1731.5	240804	PINZA DE GARRA	4G0 615 123 C , 4G0 615 123		
	DD	05.2011	24.3601-1732.5	240805	PINZA DE GARRA	4G0 615 124 C , 4G0 615 124		
	TI	05.2011	24.6243-1723.5	240798	PINZA DE GARRA	4G0 615 403 A		



Denominación

Ref. OE correspondientes a las referencias ATE

Referencia anterior / varios

AUDI

Audi Model	Engine	Code	Date	ATE Part No.	ATE Ref.	Denominación	Ref. OE correspondientes a las referencias ATE	Referencia anterior / varios
A7 Sportback (10-)	2,8 FSI quattro	DD	07.2010	24.3601-1732.5	240805	PINZA DE GARRA	4G0 615 124 C , 4G0 615 124	
		DI	07.2010	24.3601-1731.5	240804	PINZA DE GARRA	4G0 615 123 C , 4G0 615 123	
		TI	07.2010	24.6243-1723.5	240798	PINZA DE GARRA	4G0 615 403 A	
	3,0 TDI	DI	11.2015	24.3601-1731.5	240804	PINZA DE GARRA	4G0 615 123 C , 4G0 615 123	
		TI	11.2015	24.6243-1723.5	240798	PINZA DE GARRA	4G0 615 403 A	
		TI	11.2010	24.6243-1723.5	240798	PINZA DE GARRA	4G0 615 403 A	
		DD	11.2015	24.3601-1732.5	240805	PINZA DE GARRA	4G0 615 124 C , 4G0 615 124	
		DD	11.2010	24.3601-1732.5	240805	PINZA DE GARRA	4G0 615 124 C , 4G0 615 124	
		DI	11.2010	24.3601-1731.5	240804	PINZA DE GARRA	4G0 615 123 C , 4G0 615 123	
	3,0 TDI quattro	DD	11.2011	24.3601-1732.5	240805	PINZA DE GARRA	4G0 615 124 C , 4G0 615 124	
		TI	05.2013	24.6243-1723.5	240798	PINZA DE GARRA	4G0 615 403 A	
		TI	05.2014	24.6243-1723.5	240798	PINZA DE GARRA	4G0 615 403 A	
		TI	07.2010	24.6243-1723.5	240798	PINZA DE GARRA	4G0 615 403 A	
		TI	08.2014	24.6243-1723.5	240798	PINZA DE GARRA	4G0 615 403 A	
		TI	11.2011	24.6243-1723.5	240798	PINZA DE GARRA	4G0 615 403 A	
		TI	11.2015	24.6243-1723.5	240798	PINZA DE GARRA	4G0 615 403 A	
		DD	05.2013	24.3601-1732.5	240805	PINZA DE GARRA	4G0 615 124 C , 4G0 615 124	
		DD	05.2014	24.3601-1732.5	240805	PINZA DE GARRA	4G0 615 124 C , 4G0 615 124	
		DD	07.2010	24.3601-1732.5	240805	PINZA DE GARRA	4G0 615 124 C , 4G0 615 124	
		DD	08.2014	24.3601-1732.5	240805	PINZA DE GARRA	4G0 615 124 C , 4G0 615 124	
		DI	05.2013	24.3601-1731.5	240804	PINZA DE GARRA	4G0 615 123 C , 4G0 615 123	



Denominación

Ref. OE correspondientes a las referencias ATE

Referencia anterior / varios

AUDI

Audi Model	Engine	Code	Year	ATE Part No.	ATE Part No.	Denominación	Ref. OE correspondientes a las referencias ATE	Referencia anterior / varios
A7 Sportback (10-)	3,0 TDI quattro	DI	05.2014	24.3601-1731.5	240804	PINZA DE GARRA	4G0 615 123 C , 4G0 615 123	
		DI	07.2010	24.3601-1731.5	240804	PINZA DE GARRA	4G0 615 123 C , 4G0 615 123	
		DI	08.2014	24.3601-1731.5	240804	PINZA DE GARRA	4G0 615 123 C , 4G0 615 123	
		DI	11.2011	24.3601-1731.5	240804	PINZA DE GARRA	4G0 615 123 C , 4G0 615 123	
		DI	11.2015	24.3601-1731.5	240804	PINZA DE GARRA	4G0 615 123 C , 4G0 615 123	
		DD	11.2015	24.3601-1732.5	240805	PINZA DE GARRA	4G0 615 124 C , 4G0 615 124	
		TI	05.2014	24.6243-1723.5	240798	PINZA DE GARRA	4G0 615 403 A	
		DD	05.2014	24.3601-1732.5	240805	PINZA DE GARRA	4G0 615 124 C , 4G0 615 124	
	3,0 TDI ultra	DI	05.2014	24.3601-1731.5	240804	PINZA DE GARRA	4G0 615 123 C , 4G0 615 123	
		TI	05.2014	24.6243-1723.5	240798	PINZA DE GARRA	4G0 615 403 A	
		DD	07.2010	24.3601-1732.5	240805	PINZA DE GARRA	4G0 615 124 C , 4G0 615 124	
	3,0 TFSI quattro	TI	07.2010	24.6243-1723.5	240798	PINZA DE GARRA	4G0 615 403 A	
		DD	05.2014	24.3601-1732.5	240805	PINZA DE GARRA	4G0 615 124 C , 4G0 615 124	
		DI	07.2010	24.3601-1731.5	240804	PINZA DE GARRA	4G0 615 123 C , 4G0 615 123	
		DI	05.2014	24.3601-1731.5	240804	PINZA DE GARRA	4G0 615 123 C , 4G0 615 123	
		DI	10.2011	24.3601-1731.5	240804	PINZA DE GARRA	4G0 615 123 C , 4G0 615 123	
		DI	05.2014	24.3601-1731.5	240804	PINZA DE GARRA	4G0 615 123 C , 4G0 615 123	
	S7	TI	10.2011	24.6243-1723.5	240798	PINZA DE GARRA	4G0 615 403 A	
		DD	10.2011	24.3601-1732.5	240805	PINZA DE GARRA	4G0 615 124 C , 4G0 615 124	
		DD	05.2014	24.3601-1732.5	240805	PINZA DE GARRA	4G0 615 124 C , 4G0 615 124	
		TI	05.2014	24.6243-1723.5	240798	PINZA DE GARRA	4G0 615 403 A	



Denominación

Ref. OE correspondientes a las referencias ATE

Referencia anterior / varios

AUDI

Q5 (08-16)	2,0 TDI	DI	09.2015		24.3601-1729.5	240802	PINZA DE GARRA	8K0 615 123 J , 8K0 615 123 D , 8K0 615 123 E	
		DI	08.2009		24.3601-1729.5	240802	PINZA DE GARRA	8K0 615 123 J , 8K0 615 123 D , 8K0 615 123 E	
		DI	07.2011	05.2012	24.3601-1729.5	240802	PINZA DE GARRA	8K0 615 123 J , 8K0 615 123 D , 8K0 615 123 E	
		DI	08.2009	06.2011	24.3601-1729.5	240802	PINZA DE GARRA	8K0 615 123 J , 8K0 615 123 D , 8K0 615 123 E	
		DD	05.2013		24.3601-1730.5	240803	PINZA DE GARRA	8K0 615 124 J , 8K0 615 124 D , 8K0 615 124 E	
		DI	05.2013		24.3601-1729.5	240802	PINZA DE GARRA	8K0 615 123 J , 8K0 615 123 D , 8K0 615 123 E	
		DD	08.2009	06.2011	24.3601-1730.5	240803	PINZA DE GARRA	8K0 615 124 J , 8K0 615 124 D , 8K0 615 124 E	
		DD	07.2011	05.2012	24.3601-1730.5	240803	PINZA DE GARRA	8K0 615 124 J , 8K0 615 124 D , 8K0 615 124 E	
		DD	09.2015		24.3601-1730.5	240803	PINZA DE GARRA	8K0 615 124 J , 8K0 615 124 D , 8K0 615 124 E	
		DD	08.2009		24.3601-1730.5	240803	PINZA DE GARRA	8K0 615 124 J , 8K0 615 124 D , 8K0 615 124 E	
	2,0 TDI quattro	DD	03.2009	06.2011	24.3601-1730.5	240803	PINZA DE GARRA	8K0 615 124 J , 8K0 615 124 D , 8K0 615 124 E	
		DD	08.2009	06.2011	24.3601-1730.5	240803	PINZA DE GARRA	8K0 615 124 J , 8K0 615 124 D , 8K0 615 124 E	
		DI	05.2013		24.3601-1729.5	240802	PINZA DE GARRA	8K0 615 123 J , 8K0 615 123 D , 8K0 615 123 E	
		DI	08.2009		24.3601-1729.5	240802	PINZA DE GARRA	8K0 615 123 J , 8K0 615 123 D , 8K0 615 123 E	



Denominación

Ref. OE correspondientes a las referencias ATE

Referencia anterior / varios

AUDI

Q5 (08-16)	2,0 TDI quattro	DI	09.2012		24.3601-1729.5	240802	PINZA DE GARRA	8K0 615 123 J , 8K0 615 123 D , 8K0 615 123 E	
		DI	07.2011	05.2012	24.3601-1729.5	240802	PINZA DE GARRA	8K0 615 123 J , 8K0 615 123 D , 8K0 615 123 E	
		DI	03.2009	06.2011	24.3601-1729.5	240802	PINZA DE GARRA	8K0 615 123 J , 8K0 615 123 D , 8K0 615 123 E	
		DI	08.2009	06.2011	24.3601-1729.5	240802	PINZA DE GARRA	8K0 615 123 J , 8K0 615 123 D , 8K0 615 123 E	
		DD	09.2012		24.3601-1730.5	240803	PINZA DE GARRA	8K0 615 124 J , 8K0 615 124 D , 8K0 615 124 E	
		DD	08.2009		24.3601-1730.5	240803	PINZA DE GARRA	8K0 615 124 J , 8K0 615 124 D , 8K0 615 124 E	
		DD	03.2009		24.3601-1730.5	240803	PINZA DE GARRA	8K0 615 124 J , 8K0 615 124 D , 8K0 615 124 E	
		DI	03.2009		24.3601-1729.5	240802	PINZA DE GARRA	8K0 615 123 J , 8K0 615 123 D , 8K0 615 123 E	
		DD	05.2013		24.3601-1730.5	240803	PINZA DE GARRA	8K0 615 124 J , 8K0 615 124 D , 8K0 615 124 E	
		DD	07.2011	05.2012	24.3601-1730.5	240803	PINZA DE GARRA	8K0 615 124 J , 8K0 615 124 D , 8K0 615 124 E	
	2,0 TFSI hybr,quattro	DI	06.2011	06.2011	24.3601-1729.5	240802	PINZA DE GARRA	8K0 615 123 J , 8K0 615 123 D , 8K0 615 123 E	
		DD	06.2011	06.2011	24.3601-1730.5	240803	PINZA DE GARRA	8K0 615 124 J , 8K0 615 124 D , 8K0 615 124 E	
		DD	06.2011		24.3601-1730.5	240803	PINZA DE GARRA	8K0 615 124 J , 8K0 615 124 D , 8K0 615 124 E	
		DI	06.2011		24.3601-1729.5	240802	PINZA DE GARRA	8K0 615 123 J , 8K0 615 123 D , 8K0 615 123 E	



Denominación

Ref. OE correspondientes a las referencias ATE



Referencia anterior / varios

AUDI

Q5 (08-16)	2,0 TFSI hybr,quattro	DI	07.2011	05.2012	24.3601-1729.5	240802	PINZA DE GARRA	8K0 615 123 J , 8K0 615 123 D , 8K0 615 123 E	
		DD	07.2011	05.2012	24.3601-1730.5	240803	PINZA DE GARRA	8K0 615 124 J , 8K0 615 124 D , 8K0 615 124 E	
	2,0 TFSI quattro	DD	09.2012		24.3601-1730.5	240803	PINZA DE GARRA	8K0 615 124 J , 8K0 615 124 D , 8K0 615 124 E	
		DI	09.2012		24.3601-1729.5	240802	PINZA DE GARRA	8K0 615 123 J , 8K0 615 123 D , 8K0 615 123 E	
		DI	03.2009	06.2011	24.3601-1729.5	240802	PINZA DE GARRA	8K0 615 123 J , 8K0 615 123 D , 8K0 615 123 E	
		DI	07.2011	05.2012	24.3601-1729.5	240802	PINZA DE GARRA	8K0 615 123 J , 8K0 615 123 D , 8K0 615 123 E	
		DD	03.2009		24.3601-1730.5	240803	PINZA DE GARRA	8K0 615 124 J , 8K0 615 124 D , 8K0 615 124 E	
		DD	05.2013		24.3601-1730.5	240803	PINZA DE GARRA	8K0 615 124 J , 8K0 615 124 D , 8K0 615 124 E	
		DD	08.2015		24.3601-1730.5	240803	PINZA DE GARRA	8K0 615 124 J , 8K0 615 124 D , 8K0 615 124 E	
		DD	07.2011	05.2012	24.3601-1730.5	240803	PINZA DE GARRA	8K0 615 124 J , 8K0 615 124 D , 8K0 615 124 E	
		DD	03.2009	06.2011	24.3601-1730.5	240803	PINZA DE GARRA	8K0 615 124 J , 8K0 615 124 D , 8K0 615 124 E	
		DD	08.2009	06.2011	24.3601-1730.5	240803	PINZA DE GARRA	8K0 615 124 J , 8K0 615 124 D , 8K0 615 124 E	
		DI	08.2009	06.2011	24.3601-1729.5	240802	PINZA DE GARRA	8K0 615 123 J , 8K0 615 123 D , 8K0 615 123 E	
		DI	08.2015		24.3601-1729.5	240802	PINZA DE GARRA	8K0 615 123 J , 8K0 615 123 D , 8K0 615 123 E	



Denominación

Ref. OE correspondientes a las referencias ATE

Referencia anterior / varios

AUDI

Q5 (08-16)	2,0 TFSI quattro	DI	08.2009		24.3601-1729.5	240802	PINZA DE GARRA	8K0 615 123 J , 8K0 615 123 D , 8K0 615 123 E	
		DI	05.2013		24.3601-1729.5	240802	PINZA DE GARRA	8K0 615 123 J , 8K0 615 123 D , 8K0 615 123 E	
		DI	03.2009		24.3601-1729.5	240802	PINZA DE GARRA	8K0 615 123 J , 8K0 615 123 D , 8K0 615 123 E	
		DD	08.2009		24.3601-1730.5	240803	PINZA DE GARRA	8K0 615 124 J , 8K0 615 124 D , 8K0 615 124 E	
	3,0 TDI quattro	DD	09.2012		24.3601-1730.5	240803	PINZA DE GARRA	8K0 615 124 J , 8K0 615 124 D , 8K0 615 124 E	
		DD	03.2009		24.3601-1730.5	240803	PINZA DE GARRA	8K0 615 124 J , 8K0 615 124 D , 8K0 615 124 E	
		DI	03.2009	06.2011	24.3601-1729.5	240802	PINZA DE GARRA	8K0 615 123 J , 8K0 615 123 D , 8K0 615 123 E	
		DI	03.2009		24.3601-1729.5	240802	PINZA DE GARRA	8K0 615 123 J , 8K0 615 123 D , 8K0 615 123 E	
		DD	11.2013		24.3601-1730.5	240803	PINZA DE GARRA	8K0 615 124 J , 8K0 615 124 D , 8K0 615 124 E	
		DD	03.2009	06.2011	24.3601-1730.5	240803	PINZA DE GARRA	8K0 615 124 J , 8K0 615 124 D , 8K0 615 124 E	
		DI	07.2011	05.2012	24.3601-1729.5	240802	PINZA DE GARRA	8K0 615 123 J , 8K0 615 123 D , 8K0 615 123 E	
		DI	09.2012		24.3601-1729.5	240802	PINZA DE GARRA	8K0 615 123 J , 8K0 615 123 D , 8K0 615 123 E	
		DI	11.2013		24.3601-1729.5	240802	PINZA DE GARRA	8K0 615 123 J , 8K0 615 123 D , 8K0 615 123 E	
		DD	07.2011	05.2012	24.3601-1730.5	240803	PINZA DE GARRA	8K0 615 124 J , 8K0 615 124 D , 8K0 615 124 E	



Denominación

Ref. OE correspondientes a las referencias ATE



Referencia anterior / varios

AUDI

Modelo	Motor	DD	09.2012	06.2011	24.3601-1730.5	240803	PINZA DE GARRA	8K0 615 124 J , 8K0 615 124 D , 8K0 615 124 E	
Q5 (08-16)	3,0 TFSI quattro	DI	09.2012		24.3601-1729.5	240802	PINZA DE GARRA	8K0 615 123 J , 8K0 615 123 D , 8K0 615 123 E	
		DI	03.2009	06.2011	24.3601-1730.5	240803	PINZA DE GARRA	8K0 615 124 J , 8K0 615 124 D , 8K0 615 124 E	
		DI	03.2009	06.2011	24.3601-1729.5	240802	PINZA DE GARRA	8K0 615 123 J , 8K0 615 123 D , 8K0 615 123 E	
		DI	07.2011	05.2012	24.3601-1729.5	240802	PINZA DE GARRA	8K0 615 123 J , 8K0 615 123 D , 8K0 615 123 E	
		DI	03.2009		24.3601-1729.5	240802	PINZA DE GARRA	8K0 615 123 J , 8K0 615 123 D , 8K0 615 123 E	
		DD	07.2011	05.2012	24.3601-1730.5	240803	PINZA DE GARRA	8K0 615 124 J , 8K0 615 124 D , 8K0 615 124 E	
		DD	03.2009		24.3601-1730.5	240803	PINZA DE GARRA	8K0 615 124 J , 8K0 615 124 D , 8K0 615 124 E	
TT Coupe (06-14)	2,0 quattro	TI	05.2008	06.2014	24.3414-1709.5	240834	PINZA DE GARRA	1K0 615 423 M , 1K0 615 423 H , 1K0 615 423 C , 1K0 615 423	24.3414-1709.7
		TD	05.2008	06.2014	24.3414-1710.5	240835	PINZA DE GARRA	1K0 615 424 M , 1K0 615 424 H , 1K0 615 424 C , 1K0 615 424	24.3414-1710.7-
		TI	06.2008	06.2014	24.3414-1709.5	240834	PINZA DE GARRA	1K0 615 423 M , 1K0 615 423 H , 1K0 615 423 C , 1K0 615 423	24.3414-1709.7
		TD	06.2008	06.2014	24.3414-1710.5	240835	PINZA DE GARRA	1K0 615 424 M , 1K0 615 424 H , 1K0 615 424 C , 1K0 615 424	24.3414-1710.7-
		TI	05.2008	06.2014	24.3414-1709.5	240834	PINZA DE GARRA	1K0 615 423 M , 1K0 615 423 H , 1K0 615 423 C , 1K0 615 423	24.3414-1709.7



Denominación







Ref. OE correspondientes a las referencias ATE

Referencia anterior / varios

AUDI

TT Coupe (06-14)	2,0 TFSI quattro	TI	05.2010	06.2014	24.3414-1709.5	240834	PINZA DE GARRA	1K0 615 423 M , 1K0 615 423 H , 1K0 615 423 C , 1K0 615 423	24.3414-1709.7
		TD	05.2010	06.2014	24.3414-1710.5	240835	PINZA DE GARRA	1K0 615 424 M , 1K0 615 424 H , 1K0 615 424 C , 1K0 615 424	24.3414-1710.7-
		TD	05.2008	06.2014	24.3414-1710.5	240835	PINZA DE GARRA	1K0 615 424 M , 1K0 615 424 H , 1K0 615 424 C , 1K0 615 424	24.3414-1710.7-
	3,2 quattro	TI	07.2006	06.2014	24.3414-1709.5	240834	PINZA DE GARRA	1K0 615 423 M , 1K0 615 423 H , 1K0 615 423 C , 1K0 615 423	24.3414-1709.7
		TD	07.2006	06.2014	24.3414-1710.5	240835	PINZA DE GARRA	1K0 615 424 M , 1K0 615 424 H , 1K0 615 424 C , 1K0 615 424	24.3414-1710.7-
TT Roadster (07-14)	2,0 quattro	TD	05.2008	06.2014	24.3414-1710.5	240835	PINZA DE GARRA	1K0 615 424 M , 1K0 615 424 H , 1K0 615 424 C , 1K0 615 424	24.3414-1710.7-
		TI	05.2008	06.2014	24.3414-1709.5	240834	PINZA DE GARRA	1K0 615 423 M , 1K0 615 423 H , 1K0 615 423 C , 1K0 615 423	24.3414-1709.7
	2,0 TDI quattro	TI	06.2008	06.2014	24.3414-1709.5	240834	PINZA DE GARRA	1K0 615 423 M , 1K0 615 423 H , 1K0 615 423 C , 1K0 615 423	24.3414-1709.7
		TD	06.2008	06.2014	24.3414-1710.5	240835	PINZA DE GARRA	1K0 615 424 M , 1K0 615 424 H , 1K0 615 424 C , 1K0 615 424	24.3414-1710.7-
	2,0 TFSI quattro	TI	05.2010	06.2014	24.3414-1709.5	240834	PINZA DE GARRA	1K0 615 423 M , 1K0 615 423 H , 1K0 615 423 C , 1K0 615 423	24.3414-1709.7
		TD	05.2005	06.2014	24.3414-1710.5	240835	PINZA DE GARRA	1K0 615 424 M , 1K0 615 424 H , 1K0 615 424 C , 1K0 615 424	24.3414-1710.7-



					Denominación	Ref. OE correspondientes a las referencias ATE	 Referencia anterior / varios
---	---	---	--	---	---------------------	---	--

AUDI

Modelo	Motor	TD	05.2010	06.2014	24.3414-1710.5	240835	PINZA DE GARRA	1K0 615 424 M , 1K0 615 424 H , 1K0 615 424 C , 1K0 615 424	24.3414-1710.7-
TT Roadster (07-14)	2,0 TFSI quattro	TD	05.2010	06.2014	24.3414-1710.5	240835	PINZA DE GARRA	1K0 615 424 M , 1K0 615 424 H , 1K0 615 424 C , 1K0 615 424	24.3414-1710.7-
		TI	05.2005	06.2014	24.3414-1709.5	240834	PINZA DE GARRA	1K0 615 423 M , 1K0 615 423 H , 1K0 615 423 C , 1K0 615 423	24.3414-1709.7
	3,2 quattro	TI	02.2007	06.2014	24.3414-1709.5	240834	PINZA DE GARRA	1K0 615 423 M , 1K0 615 423 H , 1K0 615 423 C , 1K0 615 423	24.3414-1709.7
		TD	02.2007	06.2014	24.3414-1710.5	240835	PINZA DE GARRA	1K0 615 424 M , 1K0 615 424 H , 1K0 615 424 C , 1K0 615 424	24.3414-1710.7-



Denominación

Ref. OE correspondientes a las referencias ATE

Referencia anterior / varios

BMW

Modelo	Motor	Fecha	Referencia	ATE	Denominación	Ref. OE correspondientes a las referencias ATE	Referencia anterior / varios
2er Reihe/F45 Active Tourer (14-)	214 d	03.2015	13.0460-7315.2	607315	PASTILLAS DE FRENO	34 21 6 859 917	ver figura
		03.2015	13.0470-7315.2	LD7315	CERAMIC PAST. DE FRENO	34 21 6 859 917	
	216 d	10.2014	13.0460-7315.2	607315	PASTILLAS DE FRENO	34 21 6 859 917	ver figura
		10.2014	13.0470-7315.2	LD7315	CERAMIC PAST. DE FRENO	34 21 6 859 917	
	216 i	11.2015	13.0460-7315.2	607315	PASTILLAS DE FRENO	34 21 6 859 917	ver figura
		11.2015	13.0470-7315.2	LD7315	CERAMIC PAST. DE FRENO	34 21 6 859 917	
	218 d	10.2014	13.0460-7315.2	607315	PASTILLAS DE FRENO	34 21 6 859 917	ver figura
		09.2014	13.0460-7315.2	607315	PASTILLAS DE FRENO	34 21 6 859 917	ver figura
		09.2014	13.0470-7315.2	LD7315	CERAMIC PAST. DE FRENO	34 21 6 859 917	
		10.2014	13.0470-7315.2	LD7315	CERAMIC PAST. DE FRENO	34 21 6 859 917	
		11.2015	13.0460-7315.2	607315	PASTILLAS DE FRENO	34 21 6 859 917	ver figura
	218 d xDrive	11.2015	13.0460-7315.2	607315	PASTILLAS DE FRENO	34 21 6 859 917	ver figura
		11.2015	13.0470-7315.2	LD7315	CERAMIC PAST. DE FRENO	34 21 6 859 917	
	218 i	10.2014	13.0460-7315.2	607315	PASTILLAS DE FRENO	34 21 6 859 917	ver figura
		10.2014	13.0470-7315.2	LD7315	CERAMIC PAST. DE FRENO	34 21 6 859 917	
	220 d	11.2014	13.0460-7315.2	607315	PASTILLAS DE FRENO	34 21 6 859 917	ver figura
		10.2014	13.0460-7315.2	607315	PASTILLAS DE FRENO	34 21 6 859 917	ver figura
		10.2014	13.0470-7315.2	LD7315	CERAMIC PAST. DE FRENO	34 21 6 859 917	
		11.2014	13.0470-7315.2	LD7315	CERAMIC PAST. DE FRENO	34 21 6 859 917	
		11.2014	13.0470-7315.2	LD7315	CERAMIC PAST. DE FRENO	34 21 6 859 917	
	220 d xDrive	11.2014	13.0460-7315.2	607315	PASTILLAS DE FRENO	34 21 6 859 917	ver figura
		10.2014	13.0460-7315.2	607315	PASTILLAS DE FRENO	34 21 6 859 917	ver figura
		10.2014	13.0470-7315.2	LD7315	CERAMIC PAST. DE FRENO	34 21 6 859 917	



Denominación

Ref. OE correspondientes a las referencias ATE



Referencia anterior / varios

BMW

Modelo	Motor	Fecha	Parte	Denominación	Ref. OE	Referencia anterior / varios
2er Reihe/F45 Active Tourer (14-)	220 d xDrive	11.2014	LD7315	CERAMIC PAST. DE FRENO	34 21 6 859 917	
	220 i	10.2014	607315	PASTILLAS DE FRENO	34 21 6 859 917	ver figura
		11.2014	607315	PASTILLAS DE FRENO	34 21 6 859 917	ver figura
		10.2014	LD7315	CERAMIC PAST. DE FRENO	34 21 6 859 917	
		11.2014	LD7315	CERAMIC PAST. DE FRENO	34 21 6 859 917	
	225 i	10.2014	607315	PASTILLAS DE FRENO	34 21 6 859 917	ver figura
		10.2014	LD7315	CERAMIC PAST. DE FRENO	34 21 6 859 917	
	225 i xDrive	10.2014	607315	PASTILLAS DE FRENO	34 21 6 859 917	ver figura
		10.2014	LD7315	CERAMIC PAST. DE FRENO	34 21 6 859 917	
	225 xe xDrive	03.2016	607315	PASTILLAS DE FRENO	34 21 6 859 917	ver figura
		03.2016	LD7315	CERAMIC PAST. DE FRENO	34 21 6 859 917	
	214 d	03.2015	607315	PASTILLAS DE FRENO	34 21 6 859 917	ver figura
		03.2015	LD7315	CERAMIC PAST. DE FRENO	34 21 6 859 917	
	216 d	03.2015	607315	PASTILLAS DE FRENO	34 21 6 859 917	ver figura
		03.2015	LD7315	CERAMIC PAST. DE FRENO	34 21 6 859 917	
	216 i	07.2015	607315	PASTILLAS DE FRENO	34 21 6 859 917	ver figura
		07.2015	LD7315	CERAMIC PAST. DE FRENO	34 21 6 859 917	
	218 d	03.2015	607315	PASTILLAS DE FRENO	34 21 6 859 917	ver figura
		03.2015	LD7315	CERAMIC PAST. DE FRENO	34 21 6 859 917	
	218 d xDrive	03.2015	607315	PASTILLAS DE FRENO	34 21 6 859 917	ver figura
		03.2015	LD7315	CERAMIC PAST. DE FRENO	34 21 6 859 917	



Denominación

Ref. OE correspondientes a las referencias ATE



Referencia anterior / varios

BMW

Modelo	Motor	Fecha	Parte	ATE Ref.	Denominación	Ref. OE	Referencia anterior / varios
2er Reihe/F46 Gran Tourer (15-)	218 i	03.2015		13.0460-7315.2	607315	PASTILLAS DE FRENO	34 21 6 859 917
		03.2015		13.0470-7315.2	LD7315	CERAMIC PAST. DE FRENO	34 21 6 859 917
220 d		07.2015		13.0460-7315.2	607315	PASTILLAS DE FRENO	34 21 6 859 917
		07.2015		13.0470-7315.2	LD7315	CERAMIC PAST. DE FRENO	34 21 6 859 917
220 d xDrive		03.2015		13.0460-7315.2	607315	PASTILLAS DE FRENO	34 21 6 859 917
		03.2015		13.0470-7315.2	LD7315	CERAMIC PAST. DE FRENO	34 21 6 859 917
220 i		03.2015		13.0460-7315.2	607315	PASTILLAS DE FRENO	34 21 6 859 917
		03.2015		13.0470-7315.2	LD7315	CERAMIC PAST. DE FRENO	34 21 6 859 917
i3/I01 (13-)	Electric	07.2013		13.0460-7315.2	607315	PASTILLAS DE FRENO	34 21 6 859 917
		07.2013		13.0470-7315.2	LD7315	CERAMIC PAST. DE FRENO	34 21 6 859 917
Electric Rex		07.2013		13.0460-7315.2	607315	PASTILLAS DE FRENO	34 21 6 859 917
		07.2013		13.0470-7315.2	LD7315	CERAMIC PAST. DE FRENO	34 21 6 859 917
X1/F48 (15-)	sDrive 16d	09.2015		13.0460-7315.2	607315	PASTILLAS DE FRENO	34 21 6 859 917
		09.2015		13.0470-7315.2	LD7315	CERAMIC PAST. DE FRENO	34 21 6 859 917
sDrive 18d		09.2015		13.0460-7315.2	607315	PASTILLAS DE FRENO	34 21 6 859 917
		09.2015		13.0470-7315.2	LD7315	CERAMIC PAST. DE FRENO	34 21 6 859 917
sDrive 18i		09.2015		13.0460-7315.2	607315	PASTILLAS DE FRENO	34 21 6 859 917
		09.2015		13.0470-7315.2	LD7315	CERAMIC PAST. DE FRENO	34 21 6 859 917
sDrive 20d		11.2015		13.0460-7315.2	607315	PASTILLAS DE FRENO	34 21 6 859 917
		11.2015		13.0470-7315.2	LD7315	CERAMIC PAST. DE FRENO	34 21 6 859 917
sDrive 20i		09.2015		13.0460-7315.2	607315	PASTILLAS DE FRENO	34 21 6 859 917



Denominación

Ref. OE correspondientes a las referencias ATE









Referencia anterior / varios

BMW

Modelo	Motor	Fecha	Fecha	Código	Código	Denominación	Ref. OE correspondientes a las referencias ATE	Referencia anterior / varios	
X1/F48 (15-)	sDrive 20i	09.2015		13.0470-7315.2	LD7315	CERAMIC PAST. DE FRENO	34 21 6 859 917		
	xDrive 18d	09.2015		13.0460-7315.2	607315	PASTILLAS DE FRENO	34 21 6 859 917	ver figura	
		09.2015		13.0470-7315.2	LD7315	CERAMIC PAST. DE FRENO	34 21 6 859 917		
	xDrive 20d	09.2015		13.0460-7315.2	607315	PASTILLAS DE FRENO	34 21 6 859 917	ver figura	
		11.2015		13.0460-7315.2	607315	PASTILLAS DE FRENO	34 21 6 859 917	ver figura	
		11.2015		13.0470-7315.2	LD7315	CERAMIC PAST. DE FRENO	34 21 6 859 917		
		09.2015		13.0470-7315.2	LD7315	CERAMIC PAST. DE FRENO	34 21 6 859 917		
	xDrive 20i	09.2015		13.0460-7315.2	607315	PASTILLAS DE FRENO	34 21 6 859 917	ver figura	
		09.2015		13.0470-7315.2	LD7315	CERAMIC PAST. DE FRENO	34 21 6 859 917		
	xDrive 25d	09.2015		13.0460-7315.2	607315	PASTILLAS DE FRENO	34 21 6 859 917	ver figura	
		09.2015		13.0470-7315.2	LD7315	CERAMIC PAST. DE FRENO	34 21 6 859 917		
	xDrive 25i	09.2015		13.0460-7315.2	607315	PASTILLAS DE FRENO	34 21 6 859 917	ver figura	
		09.2015		13.0470-7315.2	LD7315	CERAMIC PAST. DE FRENO	34 21 6 859 917		
X5/E53 (00-07)	3,0 d	05.2001	09.2003	24.5169-0480.3	331508	LATIGUILLO	34 30 1 166 118	83.6150-0481.3	
		10.2003	12.2006	24.5169-0480.3	331508	LATIGUILLO	34 30 1 166 118	83.6150-0481.3	
	3,0 i	04.2000	12.2006	24.5169-0480.3	331508	LATIGUILLO	34 30 1 166 118	83.6150-0481.3	
	4,4 i	04.2000	09.2003	24.5169-0480.3	331508	LATIGUILLO	34 30 1 166 118	83.6150-0481.3	
		10.2003	12.2006	24.5169-0480.3	331508	LATIGUILLO	34 30 1 166 118	83.6150-0481.3	
	4,6 iS	12.2001	09.2003	24.5169-0480.3	331508	LATIGUILLO	34 30 1 166 118	83.6150-0481.3	
	4,8 iS	03.2004	12.2006	24.5169-0480.3	331508	LATIGUILLO	34 30 1 166 118	83.6150-0481.3	
Z3/E36 (95-02)	1,8	TD	10.1995	10.1998	24.3361-8506.5	240634	PINZA DE GARRA	34 21 1 164 398	11.3361-8506.2-



					Denominación	Ref. OE correspondientes a las referencias ATE	 Referencia anterior / varios
---	---	---	--	---	---------------------	---	--

BMW

Z3/E36 (95-02)									
	1,9	TD	10.1995	12.2002	24.3361-8506.5	240634	PINZA DE GARRA	34 21 1 164 398	11.3361-8506.2-
	2	TD	04.1999	08.2000	24.3361-8506.5	240634	PINZA DE GARRA	34 21 1 164 398	11.3361-8506.2-
	2,2	TD	10.2000	12.2002	24.3361-8506.5	240634	PINZA DE GARRA	34 21 1 164 398	11.3361-8506.2-
	2,8 Coupe	TD	07.1997	06.2000	24.3361-8506.5	240634	PINZA DE GARRA	34 21 1 164 398	11.3361-8506.2-
	2,8 Roadster	TD	05.1997	06.2000	24.3361-8506.5	240634	PINZA DE GARRA	34 21 1 164 398	11.3361-8506.2-
	3,0 Coupe	TD	06.2000	12.2002	24.3361-8506.5	240634	PINZA DE GARRA	34 21 1 164 398	11.3361-8506.2-
	3,0 Roadster	TD	06.2000	12.2002	24.3361-8506.5	240634	PINZA DE GARRA	34 21 1 164 398	11.3361-8506.2-



Denominación

Ref. OE correspondientes a las referencias ATE

Referencia anterior / varios

CHEVROLET

Modelo	Motor	DI	03.2005	12.2010	24.3541-1859.5	240735	Denominación	Ref. OE correspondientes a las referencias ATE	Referencia anterior / varios
LACETTI (05-10)	1,4 i 16V	DI	03.2005	12.2010	24.3541-1859.5	240735	PINZA DE GARRA	96549788	
		DD	03.2005	12.2010	24.3541-1860.5	240736	PINZA DE GARRA	96549789	
	1,6 i 16V	DI	03.2005	12.2010	24.3541-1859.5	240735	PINZA DE GARRA	96549788	
		DD	03.2005	12.2010	24.3541-1860.5	240736	PINZA DE GARRA	96549789	
	1,8 i 16V	DD	08.2005	12.2010	24.3541-1860.5	240736	PINZA DE GARRA	96549789	
		DD	05.2003	12.2010	24.3541-1860.5	240736	PINZA DE GARRA	96549789	
		DI	05.2003	12.2010	24.3541-1859.5	240735	PINZA DE GARRA	96549788	
		DI	08.2005	12.2010	24.3541-1859.5	240735	PINZA DE GARRA	96549788	
	2,0 TDCi	DI	01.2007	12.2010	24.3541-1859.5	240735	PINZA DE GARRA	96549788	
		DD	01.2007	12.2010	24.3541-1860.5	240736	PINZA DE GARRA	96549789	
NUBIRA (05-10)	1,4 i 16V	DD	01.2006	12.2010	24.3541-1860.5	240736	PINZA DE GARRA	96549789	
		DD	01.2005	12.2010	24.3541-1860.5	240736	PINZA DE GARRA	96549789	
		DI	01.2005	12.2010	24.3541-1859.5	240735	PINZA DE GARRA	96549788	
		DI	01.2006	12.2010	24.3541-1859.5	240735	PINZA DE GARRA	96549788	
	1,5 i 16V	DD	01.2005	12.2010	24.3541-1860.5	240736	PINZA DE GARRA	96549789	
		DI	01.2005	12.2010	24.3541-1859.5	240735	PINZA DE GARRA	96549788	
	1,6 i 16V	DD	03.2005	12.2010	24.3541-1860.5	240736	PINZA DE GARRA	96549789	
		DI	03.2005	12.2010	24.3541-1859.5	240735	PINZA DE GARRA	96549788	
		DI	01.2010	12.2010	24.3541-1859.5	240735	PINZA DE GARRA	96549788	
		DD	01.2010	12.2010	24.3541-1860.5	240736	PINZA DE GARRA	96549789	
	1,8 i 16V	DD	03.2005	12.2010	24.3541-1860.5	240736	PINZA DE GARRA	96549789	



Denominación

Ref. OE correspondientes a las referencias ATE

Referencia anterior / varios

CHEVROLET

Modelo	Motor	DD	08.2005	12.2010	24.3541-1860.5	240736	PINZA DE GARRA	96549789	
NUBIRA (05-10)	1,8 i 16V	DI	03.2005	12.2010	24.3541-1859.5	240735	PINZA DE GARRA	96549788	
		DI	08.2005	12.2010	24.3541-1859.5	240735	PINZA DE GARRA	96549788	
	2,0 i 16V	DI	01.2005	12.2010	24.3541-1859.5	240735	PINZA DE GARRA	96549788	
		DD	01.2005	12.2010	24.3541-1860.5	240736	PINZA DE GARRA	96549789	
	2,0 TCDi	DI	01.2005	12.2010	24.3541-1859.5	240735	PINZA DE GARRA	96549788	
		DD	01.2005	12.2010	24.3541-1860.5	240736	PINZA DE GARRA	96549789	

CITROEN

Modelo	Motor	DD	06.2005	04.2014	28.0462-0180.1	BAR201	DISCO DE FRENO	43512-0H020 , 43512-0H010 , 4249 94 , 4249 54 , 4246 F0 , 4249 55 , 4246 J0	
C1 (05-14)	1		06.2005	04.2014	28.0462-0180.1	BAR201	DISCO DE FRENO	43512-0H020 , 43512-0H010 , 4249 94 , 4249 54 , 4246 F0 , 4249 55 , 4246 J0	
	1,4 HDi		06.2005	12.2008	28.0462-0180.1	BAR201	DISCO DE FRENO	43512-0H020 , 43512-0H010 , 4249 94 , 4249 54 , 4246 F0 , 4249 55 , 4246 J0	
C1 (14-)	1,0 VTi 68		04.2014		28.0462-0180.1	BAR201	DISCO DE FRENO	43512-0H020 , 43512-0H010 , 4249 94 , 4249 54 , 4246 F0 , 4249 55 , 4246 J0	
	1,2 VTi 82		04.2014		28.0462-0180.1	BAR201	DISCO DE FRENO	43512-0H020 , 43512-0H010 , 4249 94 , 4249 54 , 4246 F0 , 4249 55 , 4246 J0	



	i				Denominación	Ref. OE correspondientes a las referencias ATE	i Referencia anterior / varios
--	----------	--	--	--	---------------------	---	--

Classic PKW

ALFA ROMEO 164 (87-91)	2,0 T,Spark		09.1987	08.1991	28.0461-0190.1	BAR101	DISCO DE FRENO	60801753 , 60801390 , 16420.26100.01/00 , 46831042 , 46758715 , 60801755 , 82434070 , 82433859 , 82394418	
	2,0 Turbo		09.1987	08.1991	28.0462-2145.1	BAR221	DISCO DE FRENO	5 69 086 , 95511282 , 71711447 , 71711434 , 60815938 , 60813443 , 60801722 , 52015291 , 51996238 , 51990127 , 71739567 , 71739568 , 60699518 , 60578093 , 60658565 , 82427592 , 82450539 , 60622077 , 60571548 , 60569163	
	2,5 TD		09.1987	08.1991	28.0462-2145.1	BAR221	DISCO DE FRENO	5 69 086 , 95511282 , 71711447 , 71711434 , 60815938 , 60813443 , 60801722 , 52015291 , 51996238 , 51990127 , 71739567 , 71739568 , 60699518 , 60578093 , 60658565 , 82427592 , 82450539 , 60622077 , 60571548 , 60569163	
	3,0 i V6		09.1987	08.1991	28.0462-2145.1	BAR221	DISCO DE FRENO	5 69 086 , 95511282 , 71711447 , 71711434 , 60815938 , 60813443 , 60801722 , 52015291 , 51996238 , 51990127 , 71739567 , 71739568 , 60699518 , 60578093 , 60658565 , 82427592 , 82450539 , 60622077 , 60571548 , 60569163	



Denominación

Ref. OE correspondientes a las referencias ATE



Referencia anterior / varios

Classic PKW

ALFA ROMEO 164 (87-91)	3,0 i V6 Q,V,		07.1990	08.1991	28.0462-2145.1	BAR221	DISCO DE FRENO	5 69 086 , 95511282 , 71711447 , 71711434 , 60815938 , 60813443 , 60801722 , 52015291 , 51996238 , 51990127 , 71739567 , 71739568 , 60699518 , 60578093 , 60658565 , 82427592 , 82450539 , 60622077 , 60571548 , 60569163	
FIAT CROMA (85-90)	1,6		12.1985	10.1990	28.0461-0190.1	BAR101	DISCO DE FRENO	60801753 , 60801390 , 16420.26100.01/00 , 46831042 , 46758715 , 60801755 , 82434070 , 82433859 , 82394418	
	1,9 TD		12.1988	10.1990	28.0461-0190.1	BAR101	DISCO DE FRENO	60801753 , 60801390 , 16420.26100.01/00 , 46831042 , 46758715 , 60801755 , 82434070 , 82433859 , 82394418	
	2		12.1985	10.1990	28.0461-0190.1	BAR101	DISCO DE FRENO	60801753 , 60801390 , 16420.26100.01/00 , 46831042 , 46758715 , 60801755 , 82434070 , 82433859 , 82394418	
	2,0 i,e,		12.1985	10.1990	28.0462-2145.1	BAR221	DISCO DE FRENO	5 69 086 , 95511282 , 71711447 , 71711434 , 60815938 , 60813443 , 60801722 , 52015291 , 51996238 , 51990127 , 71739567 , 71739568 , 60699518 , 60578093 , 60658565 , 82427592 , 82450539 , 60622077 , 60571548 , 60569163	
			12.1985	10.1990	28.0461-0190.1	BAR101	DISCO DE FRENO	60801753 , 60801390 , 16420.26100.01/00 , 46831042 , 46758715 , 60801755 , 82434070 , 82433859 , 82394418	



Denominación

Ref. OE correspondientes a las referencias ATE



Referencia anterior / varios

Classic PKW

Modelo	Motor	12.1985	10.1990	28.0462-2145.1	BAR221	DISCO DE FRENO	5 69 086 , 95511282 , 71711447 , 71711434 , 60815938 , 60813443 , 60801722 , 52015291 , 51996238 , 51990127 , 71739567 , 71739568 , 60699518 , 60578093 , 60658565 , 82427592 , 82450539 , 60622077 , 60571548 , 60569163
FIAT CROMA (85-90)	2,0 i,e,Turbo	12.1985	10.1990	28.0461-0190.1	BAR101	DISCO DE FRENO	60801753 , 60801390 , 16420.26100.01/00 , 46831042 , 46758715 , 60801755 , 82434070 , 82433859 , 82394418
	2,5 D	12.1985	10.1990	28.0461-0190.1	BAR101	DISCO DE FRENO	60801753 , 60801390 , 16420.26100.01/00 , 46831042 , 46758715 , 60801755 , 82434070 , 82433859 , 82394418
	2,5 TD	12.1985	10.1990	28.0461-0190.1	BAR101	DISCO DE FRENO	60801753 , 60801390 , 16420.26100.01/00 , 46831042 , 46758715 , 60801755 , 82434070 , 82433859 , 82394418
FIAT CROMA (91-96)	1,6	11.1990	12.1992	28.0461-0190.1	BAR101	DISCO DE FRENO	60801753 , 60801390 , 16420.26100.01/00 , 46831042 , 46758715 , 60801755 , 82434070 , 82433859 , 82394418
	1,9 TD	11.1990	10.1996	28.0461-0190.1	BAR101	DISCO DE FRENO	60801753 , 60801390 , 16420.26100.01/00 , 46831042 , 46758715 , 60801755 , 82434070 , 82433859 , 82394418



Denominación

Ref. OE correspondientes a las referencias ATE



Referencia anterior / varios

Classic PKW

Modelo	Motor	11.1990	12.1992	28.0461-0190.1	BAR101	DISCO DE FRENO	60801753, 60801390, 16420.26100.01/00, 46831042, 46758715, 60801755, 82434070, 82433859, 82394418
FIAT CROMA (91-96)	2	11.1990	12.1992	28.0461-0190.1	BAR101	DISCO DE FRENO	60801753, 60801390, 16420.26100.01/00, 46831042, 46758715, 60801755, 82434070, 82433859, 82394418
	2,0 i,e,	11.1990	10.1996	28.0462-2145.1	BAR221	DISCO DE FRENO	5 69 086, 95511282, 71711447, 71711434, 60815938, 60813443, 60801722, 52015291, 51996238, 51990127, 71739567, 71739568, 60699518, 60578093, 60658565, 82427592, 82450539, 60622077, 60571548, 60569163
		11.1990	10.1996	28.0461-0190.1	BAR101	DISCO DE FRENO	60801753, 60801390, 16420.26100.01/00, 46831042, 46758715, 60801755, 82434070, 82433859, 82394418
	2,0 i,e, 16V	12.1992	10.1996	28.0461-0190.1	BAR101	DISCO DE FRENO	60801753, 60801390, 16420.26100.01/00, 46831042, 46758715, 60801755, 82434070, 82433859, 82394418
	2,0 i,e, Turbo	11.1990	10.1996	28.0461-0190.1	BAR101	DISCO DE FRENO	60801753, 60801390, 16420.26100.01/00, 46831042, 46758715, 60801755, 82434070, 82433859, 82394418
		11.1990	10.1996	28.0462-2145.1	BAR221	DISCO DE FRENO	5 69 086, 95511282, 71711447, 71711434, 60815938, 60813443, 60801722, 52015291, 51996238, 51990127, 71739567, 71739568, 60699518, 60578093, 60658565, 82427592, 82450539, 60622077, 60571548, 60569163



					Denominación	Ref. OE correspondientes a las referencias ATE	Referencia anterior / varios
--	--	--	--	--	---------------------	---	-------------------------------------

Classic PKW

FIAT CROMA (91-96)	2,5 i,e, V6		04.1993	10.1996	28.0461-0190.1	BAR101	DISCO DE FRENO	60801753 , 60801390 , 16420.26100.01/00 , 46831042 , 46758715 , 60801755 , 82434070 , 82433859 , 82394418	
	2,5 TD		11.1990	10.1996	28.0461-0190.1	BAR101	DISCO DE FRENO	60801753 , 60801390 , 16420.26100.01/00 , 46831042 , 46758715 , 60801755 , 82434070 , 82433859 , 82394418	
FORD MONDEO I (93-96)	1,6 i 16V		01.1993	09.1996	28.0462-0146.1	BAR201	DISCO DE FRENO	4115996 , 1025911 , 5026786	
	1,8 i 16V		01.1993	09.1996	28.0462-0146.1	BAR201	DISCO DE FRENO	4115996 , 1025911 , 5026786	
	1,8 TD		01.1993	09.1996	28.0462-0146.1	BAR201	DISCO DE FRENO	4115996 , 1025911 , 5026786	
	2,0 i 16V		01.1993	09.1996	28.0462-0146.1	BAR201	DISCO DE FRENO	4115996 , 1025911 , 5026786	
	2,0 i 16V 4x4		04.1993	09.1996	28.0462-0146.1	BAR201	DISCO DE FRENO	4115996 , 1025911 , 5026786	
	2,5 i 24V		08.1994	09.1996	28.0462-0146.1	BAR201	DISCO DE FRENO	4115996 , 1025911 , 5026786	
LANCIA THEMA (84-88)	2,0 i,e,		10.1984	01.1989	28.0462-2145.1	BAR221	DISCO DE FRENO	5 69 086 , 95511282 , 71711447 , 71711434 , 60815938 , 60813443 , 60801722 , 52015291 , 51996238 , 51990127 , 71739567 , 71739568 , 60699518 , 60578093 , 60658565 , 82427592 , 82450539 , 60622077 , 60571548 , 60569163	
			10.1984	01.1989	28.0461-0190.1	BAR101	DISCO DE FRENO	60801753 , 60801390 , 16420.26100.01/00 , 46831042 , 46758715 , 60801755 , 82434070 , 82433859 , 82394418	



	i				Denominación	Ref. OE correspondientes a las referencias ATE	i Referencia anterior / varios
--	----------	--	--	--	---------------------	---	--

Classic PKW

LANCIA THEMA (84-88)	2,0 i,e, Turbo		10.1984	01.1989	28.0462-2145.1	BAR221	DISCO DE FRENO	5 69 086 , 95511282 , 71711447 , 71711434 , 60815938 , 60813443 , 60801722 , 52015291 , 51996238 , 51990127 , 71739567 , 71739568 , 60699518 , 60578093 , 60658565 , 82427592 , 82450539 , 60622077 , 60571548 , 60569163	
			10.1984	01.1989	28.0461-0190.1	BAR101	DISCO DE FRENO	60801753 , 60801390 , 16420.26100.01/00 , 46831042 , 46758715 , 60801755 , 82434070 , 82433859 , 82394418	
	2,5 TD		10.1984	01.1989	28.0461-0190.1	BAR101	DISCO DE FRENO	60801753 , 60801390 , 16420.26100.01/00 , 46831042 , 46758715 , 60801755 , 82434070 , 82433859 , 82394418	
	2,8 i,e, V6		10.1984	01.1989	28.0462-2145.1	BAR221	DISCO DE FRENO	5 69 086 , 95511282 , 71711447 , 71711434 , 60815938 , 60813443 , 60801722 , 52015291 , 51996238 , 51990127 , 71739567 , 71739568 , 60699518 , 60578093 , 60658565 , 82427592 , 82450539 , 60622077 , 60571548 , 60569163	
			10.1984	01.1989	28.0461-0190.1	BAR101	DISCO DE FRENO	60801753 , 60801390 , 16420.26100.01/00 , 46831042 , 46758715 , 60801755 , 82434070 , 82433859 , 82394418	



Denominación

Ref. OE correspondientes a las referencias ATE



Referencia anterior / varios

Classic PKW

Modelo	Motor	Fecha inicio	Fecha fin	Código ATE	Referencia ATE	Denominación	Ref. OE correspondientes a las referencias ATE	Referencia anterior / varios
LANCIA THEMA (84-88)	2,9 i,e, 8,32	09.1987	01.1989	28.0462-2145.1	BAR221	DISCO DE FRENO	5 69 086 , 95511282 , 71711447 , 71711434 , 60815938 , 60813443 , 60801722 , 52015291 , 51996238 , 51990127 , 71739567 , 71739568 , 60699518 , 60578093 , 60658565 , 82427592 , 82450539 , 60622077 , 60571548 , 60569163	
LANCIA THEMA (89-92)	2,0 i,e,	02.1989	09.1992	28.0461-0190.1	BAR101	DISCO DE FRENO	60801753 , 60801390 , 16420.26100.01/00 , 46831042 , 46758715 , 60801755 , 82434070 , 82433859 , 82394418	
		02.1989	09.1992	28.0462-2145.1	BAR221	DISCO DE FRENO	5 69 086 , 95511282 , 71711447 , 71711434 , 60815938 , 60813443 , 60801722 , 52015291 , 51996238 , 51990127 , 71739567 , 71739568 , 60699518 , 60578093 , 60658565 , 82427592 , 82450539 , 60622077 , 60571548 , 60569163	
	2,0 i,e, 16V	10.1989	09.1992	28.0462-2145.1	BAR221	DISCO DE FRENO	5 69 086 , 95511282 , 71711447 , 71711434 , 60815938 , 60813443 , 60801722 , 52015291 , 51996238 , 51990127 , 71739567 , 71739568 , 60699518 , 60578093 , 60658565 , 82427592 , 82450539 , 60622077 , 60571548 , 60569163	
		10.1989	09.1992	28.0461-0190.1	BAR101	DISCO DE FRENO	60801753 , 60801390 , 16420.26100.01/00 , 46831042 , 46758715 , 60801755 , 82434070 , 82433859 , 82394418	



Denominación

Ref. OE correspondientes a las referencias ATE



Referencia anterior / varios

Classic PKW

Modelo	Motor	Desde	Hasta	Código ATE	Denominación	Referencias OE	Referencia anterior / varios
LANCIA THEMA (89-92)	2,0 i,e, 16V Turbo	10.1989	09.1992	28.0461-0190.1	BAR101	DISCO DE FRENO	60801753 , 60801390 , 16420.26100.01/00 , 46831042 , 46758715 , 60801755 , 82434070 , 82433859 , 82394418
		10.1989	09.1992	28.0462-2145.1	BAR221	DISCO DE FRENO	5 69 086 , 95511282 , 71711447 , 71711434 , 60815938 , 60813443 , 60801722 , 52015291 , 51996238 , 51990127 , 71739567 , 71739568 , 60699518 , 60578093 , 60658565 , 82427592 , 82450539 , 60622077 , 60571548 , 60569163
	2,0 i,e, Turbo	02.1989	09.1992	28.0461-0190.1	BAR101	DISCO DE FRENO	60801753 , 60801390 , 16420.26100.01/00 , 46831042 , 46758715 , 60801755 , 82434070 , 82433859 , 82394418
		02.1989	09.1992	28.0462-2145.1	BAR221	DISCO DE FRENO	5 69 086 , 95511282 , 71711447 , 71711434 , 60815938 , 60813443 , 60801722 , 52015291 , 51996238 , 51990127 , 71739567 , 71739568 , 60699518 , 60578093 , 60658565 , 82427592 , 82450539 , 60622077 , 60571548 , 60569163
	2,5 TD	02.1989	09.1992	28.0461-0190.1	BAR101	DISCO DE FRENO	60801753 , 60801390 , 16420.26100.01/00 , 46831042 , 46758715 , 60801755 , 82434070 , 82433859 , 82394418



Denominación

Ref. OE correspondientes a las referencias ATE



Referencia anterior / varios

Classic PKW

Modelo	Motor	02.1989	09.1992	28.0462-2145.1	BAR221	DISCO DE FRENO	5 69 086 , 95511282 , 71711447 , 71711434 , 60815938 , 60813443 , 60801722 , 52015291 , 51996238 , 51990127 , 71739567 , 71739568 , 60699518 , 60578093 , 60658565 , 82427592 , 82450539 , 60622077 , 60571548 , 60569163
LANCIA THEMA (89-92)	2,8 i,e, V6	02.1989	09.1992	28.0462-2145.1	BAR221	DISCO DE FRENO	5 69 086 , 95511282 , 71711447 , 71711434 , 60815938 , 60813443 , 60801722 , 52015291 , 51996238 , 51990127 , 71739567 , 71739568 , 60699518 , 60578093 , 60658565 , 82427592 , 82450539 , 60622077 , 60571548 , 60569163
		02.1989	09.1992	28.0461-0190.1	BAR101	DISCO DE FRENO	60801753 , 60801390 , 16420.26100.01/00 , 46831042 , 46758715 , 60801755 , 82434070 , 82433859 , 82394418
	2,9 i,e, 8,32	02.1989	09.1992	28.0462-2145.1	BAR221	DISCO DE FRENO	5 69 086 , 95511282 , 71711447 , 71711434 , 60815938 , 60813443 , 60801722 , 52015291 , 51996238 , 51990127 , 71739567 , 71739568 , 60699518 , 60578093 , 60658565 , 82427592 , 82450539 , 60622077 , 60571548 , 60569163
LANCIA THEMA (92-94)	2,0 i,e,	10.1992	12.1994	28.0461-0190.1	BAR101	DISCO DE FRENO	60801753 , 60801390 , 16420.26100.01/00 , 46831042 , 46758715 , 60801755 , 82434070 , 82433859 , 82394418
	2,0 i,e, 16V	10.1992	12.1994	28.0462-2145.1	BAR221	DISCO DE FRENO	5 69 086 , 95511282 , 71711447 , 71711434 , 60815938 , 60813443 , 60801722 , 52015291 , 51996238 , 51990127 , 71739567 , 71739568 , 60699518 , 60578093 , 60658565 , 82427592 , 82450539 , 60622077 , 60571548 , 60569163



Denominación

Ref. OE correspondientes a las referencias ATE



Referencia anterior / varios

Classic PKW

Modelo	Motor	10.1992	12.1994	28.0461-0190.1	BAR101	DISCO DE FRENO	60801753, 60801390, 16420.26100.01/00, 46831042, 46758715, 60801755, 82434070, 82433859, 82394418
LANCIA THEMA (92-94)	2,0 i,e, 16V						
	2,0 i,e, 16V Turbo						
				28.0462-2145.1	BAR221	DISCO DE FRENO	5 69 086, 95511282, 71711447, 71711434, 60815938, 60813443, 60801722, 52015291, 51996238, 51990127, 71739567, 71739568, 60699518, 60578093, 60658565, 82427592, 82450539, 60622077, 60571548, 60569163
	2,5 TD						
	3,0 i,e, V6						
				28.0462-2145.1	BAR221	DISCO DE FRENO	5 69 086, 95511282, 71711447, 71711434, 60815938, 60813443, 60801722, 52015291, 51996238, 51990127, 71739567, 71739568, 60699518, 60578093, 60658565, 82427592, 82450539, 60622077, 60571548, 60569163



					Denominación	Ref. OE correspondientes a las referencias ATE	Referencia anterior / varios
--	--	--	--	--	---------------------	---	-------------------------------------

Classic PKW

NISSAN 200 SX (S13) (88-94)	1,8 i Turbo		10.1991	03.1994	28.0462-2179.1	BAR221	DISCO DE FRENO	40206-2F501 , 40206-55F03 , 40206-55F01 , 40206-2F500	
-----------------------------	-------------	--	---------	---------	----------------	--------	----------------	---	--

DAEWOO

GENTRA (13-)	1,5	DI	06.2013		24.3541-1859.5	240735	PINZA DE GARRA	96549788	
		DD	06.2013		24.3541-1860.5	240736	PINZA DE GARRA	96549789	
LACETTI (04-05)	1,4 i 16V	DI	06.2002	12.2004	24.3541-1859.5	240735	PINZA DE GARRA	96549788	
		DI	02.2004	02.2005	24.3541-1859.5	240735	PINZA DE GARRA	96549788	
		DD	06.2002	12.2004	24.3541-1860.5	240736	PINZA DE GARRA	96549789	
		DD	02.2004	02.2005	24.3541-1860.5	240736	PINZA DE GARRA	96549789	
	1,6 i 16V	DD	02.2004	02.2005	24.3541-1860.5	240736	PINZA DE GARRA	96549789	
		DI	02.2004	02.2005	24.3541-1859.5	240735	PINZA DE GARRA	96549788	
	1,8 i 16V	DD	02.2004	02.2005	24.3541-1860.5	240736	PINZA DE GARRA	96549789	
		DI	02.2004	02.2005	24.3541-1859.5	240735	PINZA DE GARRA	96549788	
LACETTI (99-03)	1,6	DD	06.2002	07.2003	24.3541-1860.5	240736	PINZA DE GARRA	96549789	
		DI	06.2002	07.2003	24.3541-1859.5	240735	PINZA DE GARRA	96549788	
NUBIRA (99-05)	1,4 i 16V	DD	10.2003	12.2004	24.3541-1860.5	240736	PINZA DE GARRA	96549789	
		DI	10.2003	12.2004	24.3541-1859.5	240735	PINZA DE GARRA	96549788	
	2,0 CDX	DD	01.2003	07.2003	24.3541-1860.5	240736	PINZA DE GARRA	96549789	
		DI	01.2003	07.2003	24.3541-1859.5	240735	PINZA DE GARRA	96549788	



Denominación

Ref. OE correspondientes a las referencias ATE

Referencia anterior / varios

FIAT

Modelo	Motor	Fecha	Referencia	ATE	Denominación	Ref. OE correspondientes a las referencias ATE	Referencia anterior / varios
500 (07-)	0,9	07.2010	03.0521-0520.3	690112	ATE TOPKIT		
		09.2012	03.0521-0520.3	690112	ATE TOPKIT		
	1,2 i	06.2010	03.0521-0520.3	690112	ATE TOPKIT		
	1,2 LPG	12.2010	03.0521-0520.3	690112	ATE TOPKIT		
	1,3 D Multijet	06.2016	03.0521-0520.3	690112	ATE TOPKIT		
		06.2010	03.0521-0520.3	690112	ATE TOPKIT		
500 C Cabrio (09-)	0,9	06.2010	03.0521-0520.3	690112	ATE TOPKIT		
	1,2	06.2010	03.0521-0520.3	690112	ATE TOPKIT		
	1,3 D Multijet	06.2010	03.0521-0520.3	690112	ATE TOPKIT		
BRAVO (07-)	1,4 16V	04.2008	28.0461-0190.1	BAR101	DISCO DE FRENO	60801753 , 60801390 , 16420.26100.01/00 , 46831042 , 46758715 , 60801755 , 82434070 , 82433859 , 82394418	
	1,4 i 16V	04.2007	28.0461-0190.1	BAR101	DISCO DE FRENO	60801753 , 60801390 , 16420.26100.01/00 , 46831042 , 46758715 , 60801755 , 82434070 , 82433859 , 82394418	
	1,4 LPG	11.2009	28.0461-0190.1	BAR101	DISCO DE FRENO	60801753 , 60801390 , 16420.26100.01/00 , 46831042 , 46758715 , 60801755 , 82434070 , 82433859 , 82394418	
	1,4 T-Jet	09.2007	28.0461-0190.1	BAR101	DISCO DE FRENO	60801753 , 60801390 , 16420.26100.01/00 , 46831042 , 46758715 , 60801755 , 82434070 , 82433859 , 82394418	



Denominación

Ref. OE correspondientes a las referencias ATE



Referencia anterior / varios

FIAT

BRAVO (07-)	1,6 D Multijet		03.2008		28.0461-0190.1	BAR101	DISCO DE FRENO	60801753 , 60801390 , 16420.26100.01/00 , 46831042 , 46758715 , 60801755 , 82434070 , 82433859 , 82394418	
	1,9 D Multijet		04.2007	12.2008	28.0461-0190.1	BAR101	DISCO DE FRENO	60801753 , 60801390 , 16420.26100.01/00 , 46831042 , 46758715 , 60801755 , 82434070 , 82433859 , 82394418	
			04.2007		28.0461-0190.1	BAR101	DISCO DE FRENO	60801753 , 60801390 , 16420.26100.01/00 , 46831042 , 46758715 , 60801755 , 82434070 , 82433859 , 82394418	
	2,0 D Multijet		09.2008		28.0461-0190.1	BAR101	DISCO DE FRENO	60801753 , 60801390 , 16420.26100.01/00 , 46831042 , 46758715 , 60801755 , 82434070 , 82433859 , 82394418	
DOBLO (10-)	1,3 D Multijet		02.2010		28.0462-2145.1	BAR221	DISCO DE FRENO	5 69 086 , 95511282 , 71711447 , 71711434 , 60815938 , 60813443 , 60801722 , 52015291 , 51996238 , 51990127 , 71739567 , 71739568 , 60699518 , 60578093 , 60658565 , 82427592 , 82450539 , 60622077 , 60571548 , 60569163	
	1,4		02.2010		28.0462-2145.1	BAR221	DISCO DE FRENO	5 69 086 , 95511282 , 71711447 , 71711434 , 60815938 , 60813443 , 60801722 , 52015291 , 51996238 , 51990127 , 71739567 , 71739568 , 60699518 , 60578093 , 60658565 , 82427592 , 82450539 , 60622077 , 60571548 , 60569163	



Denominación

Ref. OE correspondientes a las referencias ATE



Referencia anterior / varios

FIAT

Modelo	Cilindrada	Fecha	Código	Referencia	Denominación	Ref. OE correspondientes a las referencias ATE	Referencia anterior / varios
DOBLO (10-)	1,4	10.2011		28.0462-2145.1	BAR221 DISCO DE FRENO	5 69 086 , 95511282 , 71711447 , 71711434 , 60815938 , 60813443 , 60801722 , 52015291 , 51996238 , 51990127 , 71739567 , 71739568 , 60699518 , 60578093 , 60658565 , 82427592 , 82450539 , 60622077 , 60571548 , 60569163	
	1,4 Natural Power	02.2010		28.0462-2145.1	BAR221 DISCO DE FRENO	5 69 086 , 95511282 , 71711447 , 71711434 , 60815938 , 60813443 , 60801722 , 52015291 , 51996238 , 51990127 , 71739567 , 71739568 , 60699518 , 60578093 , 60658565 , 82427592 , 82450539 , 60622077 , 60571548 , 60569163	
	1,6 D Multijet	02.2010		28.0462-2145.1	BAR221 DISCO DE FRENO	5 69 086 , 95511282 , 71711447 , 71711434 , 60815938 , 60813443 , 60801722 , 52015291 , 51996238 , 51990127 , 71739567 , 71739568 , 60699518 , 60578093 , 60658565 , 82427592 , 82450539 , 60622077 , 60571548 , 60569163	
		03.2015		28.0462-2145.1	BAR221 DISCO DE FRENO	5 69 086 , 95511282 , 71711447 , 71711434 , 60815938 , 60813443 , 60801722 , 52015291 , 51996238 , 51990127 , 71739567 , 71739568 , 60699518 , 60578093 , 60658565 , 82427592 , 82450539 , 60622077 , 60571548 , 60569163	



Denominación

Ref. OE correspondientes a las referencias ATE

Referencia anterior / varios

FIAT

Modelo	Motor	Fecha 1	Fecha 2	Código 1	Código 2	Denominación	Ref. OE correspondientes a las referencias ATE	Referencia anterior / varios
DOBLO (10-)	2,0 D Multijet	02.2010		28.0462-2145.1	BAR221	DISCO DE FRENO	5 69 086 , 95511282 , 71711447 , 71711434 , 60815938 , 60813443 , 60801722 , 52015291 , 51996238 , 51990127 , 71739567 , 71739568 , 60699518 , 60578093 , 60658565 , 82427592 , 82450539 , 60622077 , 60571548 , 60569163	
LINEA (07-11)	1,4 T-Jet	07.2007	05.2011	28.0461-0190.1	BAR101	DISCO DE FRENO	60801753 , 60801390 , 16420.26100.01/00 , 46831042 , 46758715 , 60801755 , 82434070 , 82433859 , 82394418	
	1,6	07.2008	05.2011	28.0461-0190.1	BAR101	DISCO DE FRENO	60801753 , 60801390 , 16420.26100.01/00 , 46831042 , 46758715 , 60801755 , 82434070 , 82433859 , 82394418	
	1,6 D Multijet	01.2009	05.2011	28.0461-0190.1	BAR101	DISCO DE FRENO	60801753 , 60801390 , 16420.26100.01/00 , 46831042 , 46758715 , 60801755 , 82434070 , 82433859 , 82394418	
	1,9 16V	07.2008	05.2011	28.0461-0190.1	BAR101	DISCO DE FRENO	60801753 , 60801390 , 16420.26100.01/00 , 46831042 , 46758715 , 60801755 , 82434070 , 82433859 , 82394418	
MULTIPLA (98-10)	1,6	09.2000	06.2010	28.0461-0190.1	BAR101	DISCO DE FRENO	60801753 , 60801390 , 16420.26100.01/00 , 46831042 , 46758715 , 60801755 , 82434070 , 82433859 , 82394418	



Denominación

Ref. OE correspondientes a las referencias ATE



Referencia anterior / varios

FIAT

MULTIPLA (98-10)	1,6 16V		04.2002	06.2010	28.0461-0190.1	BAR101	DISCO DE FRENO	60801753 , 60801390 , 16420.26100.01/00 , 46831042 , 46758715 , 60801755 , 82434070 , 82433859 , 82394418	
	1,6 16V Bipower		04.1999	06.2010	28.0461-0190.1	BAR101	DISCO DE FRENO	60801753 , 60801390 , 16420.26100.01/00 , 46831042 , 46758715 , 60801755 , 82434070 , 82433859 , 82394418	
	1,6 16V Bluepower		04.1999	06.2010	28.0461-0190.1	BAR101	DISCO DE FRENO	60801753 , 60801390 , 16420.26100.01/00 , 46831042 , 46758715 , 60801755 , 82434070 , 82433859 , 82394418	
	1,9 JTD		04.2002	06.2010	28.0461-0190.1	BAR101	DISCO DE FRENO	60801753 , 60801390 , 16420.26100.01/00 , 46831042 , 46758715 , 60801755 , 82434070 , 82433859 , 82394418	
PANDA (03-13)	1,1		06.2010	06.2013	03.0521-0520.3	690112	ATE TOPKIT		
	1,2		06.2010	06.2013	03.0521-0520.3	690112	ATE TOPKIT		
	1,3 D Multijet		06.2010	06.2013	03.0521-0520.3	690112	ATE TOPKIT		
	1,3 JTD		06.2010	06.2013	03.0521-0520.3	690112	ATE TOPKIT		
PANDA (12-)	0,9		02.2012		03.0521-0620.3	690111	ATE TOPKIT		
	0,9 Natural Power		02.2012		03.0521-0620.3	690111	ATE TOPKIT		
			07.2012		03.0521-0620.3	690111	ATE TOPKIT		
	1,2		02.2012		03.0521-0620.3	690111	ATE TOPKIT		
	1,2 LPG		02.2012		03.0521-0620.3	690111	ATE TOPKIT		
	1,3 D Multijet		04.2015		03.0521-0620.3	690111	ATE TOPKIT		
			02.2012		03.0521-0620.3	690111	ATE TOPKIT		



Denominación

Ref. OE correspondientes a las referencias ATE



Referencia anterior / varios

FIAT

Modelo	Motor	02.2002	03.2008	28.0461-0190.1	BAR101	Denominación	Ref. OE correspondientes a las referencias ATE	Referencia anterior / varios
STILO / STILO Multi Wagon (01-08)	1,2 i 16V			28.0461-0190.1	BAR101	DISCO DE FRENO	60801753 , 60801390 , 16420.26100.01/00 , 46831042 , 46758715 , 60801755 , 82434070 , 82433859 , 82394418	
	1,4 i 16V	01.2004	03.2008	28.0461-0190.1	BAR101	DISCO DE FRENO	60801753 , 60801390 , 16420.26100.01/00 , 46831042 , 46758715 , 60801755 , 82434070 , 82433859 , 82394418	
	1,6 16V	04.2005	03.2008	28.0461-0190.1	BAR101	DISCO DE FRENO	60801753 , 60801390 , 16420.26100.01/00 , 46831042 , 46758715 , 60801755 , 82434070 , 82433859 , 82394418	
		10.2001	03.2008	28.0461-0190.1	BAR101	DISCO DE FRENO	60801753 , 60801390 , 16420.26100.01/00 , 46831042 , 46758715 , 60801755 , 82434070 , 82433859 , 82394418	
	1,8 16V	10.2001	03.2008	28.0461-0190.1	BAR101	DISCO DE FRENO	60801753 , 60801390 , 16420.26100.01/00 , 46831042 , 46758715 , 60801755 , 82434070 , 82433859 , 82394418	
	1,9 D Multijet	09.2005	03.2008	28.0461-0190.1	BAR101	DISCO DE FRENO	60801753 , 60801390 , 16420.26100.01/00 , 46831042 , 46758715 , 60801755 , 82434070 , 82433859 , 82394418	
	1,9 JTD	10.2001	03.2008	28.0461-0190.1	BAR101	DISCO DE FRENO	60801753 , 60801390 , 16420.26100.01/00 , 46831042 , 46758715 , 60801755 , 82434070 , 82433859 , 82394418	



Denominación

Ref. OE correspondientes a las referencias ATE



Referencia anterior / varios

FIAT

Modelo	Motor	02.2002	03.2008	28.0461-0190.1	BAR101	DISCO DE FRENO	60801753 , 60801390 , 16420.26100.01/00 , 46831042 , 46758715 , 60801755 , 82434070 , 82433859 , 82394418
STILO / STILO Multi Wagon (01-08)	1,9 JTD						
		01.2004	03.2008	28.0461-0190.1	BAR101	DISCO DE FRENO	60801753 , 60801390 , 16420.26100.01/00 , 46831042 , 46758715 , 60801755 , 82434070 , 82433859 , 82394418
	2,4 20V	10.2001	03.2008	28.0461-0190.1	BAR101	DISCO DE FRENO	60801753 , 60801390 , 16420.26100.01/00 , 46831042 , 46758715 , 60801755 , 82434070 , 82433859 , 82394418
TIPO (15-)	1,3 D Multijet	10.2015		28.0462-2145.1	BAR221	DISCO DE FRENO	5 69 086 , 95511282 , 71711447 , 71711434 , 60815938 , 60813443 , 60801722 , 52015291 , 51996238 , 51990127 , 71739567 , 71739568 , 60699518 , 60578093 , 60658565 , 82427592 , 82450539 , 60622077 , 60571548 , 60569163
	1,4	10.2015		28.0462-2145.1	BAR221	DISCO DE FRENO	5 69 086 , 95511282 , 71711447 , 71711434 , 60815938 , 60813443 , 60801722 , 52015291 , 51996238 , 51990127 , 71739567 , 71739568 , 60699518 , 60578093 , 60658565 , 82427592 , 82450539 , 60622077 , 60571548 , 60569163



Denominación

Ref. OE correspondientes a las referencias ATE



Referencia anterior / varios

FIAT

TIPO (15-)								
1,4		03.2016		28.0462-2145.1	BAR221	DISCO DE FRENO	5 69 086 , 95511282 , 71711447 , 71711434 , 60815938 , 60813443 , 60801722 , 52015291 , 51996238 , 51990127 , 71739567 , 71739568 , 60699518 , 60578093 , 60658565 , 82427592 , 82450539 , 60622077 , 60571548 , 60569163	
1,6		10.2015		28.0462-2145.1	BAR221	DISCO DE FRENO	5 69 086 , 95511282 , 71711447 , 71711434 , 60815938 , 60813443 , 60801722 , 52015291 , 51996238 , 51990127 , 71739567 , 71739568 , 60699518 , 60578093 , 60658565 , 82427592 , 82450539 , 60622077 , 60571548 , 60569163	
1,6 D Multijet		10.2015		28.0462-2145.1	BAR221	DISCO DE FRENO	5 69 086 , 95511282 , 71711447 , 71711434 , 60815938 , 60813443 , 60801722 , 52015291 , 51996238 , 51990127 , 71739567 , 71739568 , 60699518 , 60578093 , 60658565 , 82427592 , 82450539 , 60622077 , 60571548 , 60569163	



Denominación

Ref. OE correspondientes a las referencias ATE

Referencia anterior / varios

FORD

Modelo	Motor	Fecha inicio	Fecha fin	Código ATE	Denominación	Ref. OE correspondientes a las referencias ATE	Referencia anterior / varios
COUGAR (98-01)	2,0 i 16V	09.1998	12.2001	28.0462-0146.1	BAR201	DISCO DE FRENO	4115996 , 1025911 , 5026786
	2,5 i V6	09.1998	12.2001	28.0462-0146.1	BAR201	DISCO DE FRENO	4115996 , 1025911 , 5026786
FOCUS II (05-11)	2,5 RS	01.2009	02.2011	28.0461-1145.1	BAR111	DISCO DE FRENO	LR027123 , 6G91-2A315-BA , 1385590 , 1405500 , 1379931
	2,5 RS 500	05.2010	02.2011	28.0461-1145.1	BAR111	DISCO DE FRENO	LR027123 , 6G91-2A315-BA , 1385590 , 1405500 , 1379931
GALAXY II (06-)	1,6 EcoBoost	02.2011		28.0461-1145.1	BAR111	DISCO DE FRENO	LR027123 , 6G91-2A315-BA , 1385590 , 1405500 , 1379931
	1,6 TDCi	02.2011		28.0461-1145.1	BAR111	DISCO DE FRENO	LR027123 , 6G91-2A315-BA , 1385590 , 1405500 , 1379931
	1,8 TDCi	04.2006		28.0461-1145.1	BAR111	DISCO DE FRENO	LR027123 , 6G91-2A315-BA , 1385590 , 1405500 , 1379931
	2,0 Flexifuel	05.2006		28.0461-1145.1	BAR111	DISCO DE FRENO	LR027123 , 6G91-2A315-BA , 1385590 , 1405500 , 1379931
	2,0 i 16V	04.2006		28.0461-1145.1	BAR111	DISCO DE FRENO	LR027123 , 6G91-2A315-BA , 1385590 , 1405500 , 1379931
	2,0 SCTi EcoBoost	03.2010		28.0461-1145.1	BAR111	DISCO DE FRENO	LR027123 , 6G91-2A315-BA , 1385590 , 1405500 , 1379931
	2,0 TDCi	03.2010		28.0461-1145.1	BAR111	DISCO DE FRENO	LR027123 , 6G91-2A315-BA , 1385590 , 1405500 , 1379931
		04.2006		28.0461-1145.1	BAR111	DISCO DE FRENO	LR027123 , 6G91-2A315-BA , 1385590 , 1405500 , 1379931
		05.2006		28.0461-1145.1	BAR111	DISCO DE FRENO	LR027123 , 6G91-2A315-BA , 1385590 , 1405500 , 1379931
		10.2007		28.0461-1145.1	BAR111	DISCO DE FRENO	LR027123 , 6G91-2A315-BA , 1385590 , 1405500 , 1379931
	2,2 TDCi	04.2008		28.0461-1145.1	BAR111	DISCO DE FRENO	LR027123 , 6G91-2A315-BA , 1385590 , 1405500 , 1379931



Denominación

Ref. OE correspondientes a las referencias ATE



Referencia anterior / varios

FORD

Modelo	Motor	Fecha inicio	Fecha fin	Código ATE	Referencia ATE	Denominación	Ref. OE correspondientes a las referencias ATE
GALAXY II (06-)	2,2 TDCi	07.2010		28.0461-1145.1	BAR111	DISCO DE FRENO	LR027123 , 6G91-2A315-BA , 1385590 , 1405500 , 1379931
	2,3 i 16V	07.2007		28.0461-1145.1	BAR111	DISCO DE FRENO	LR027123 , 6G91-2A315-BA , 1385590 , 1405500 , 1379931
KA II (08-)	1,2 i 16V	06.2010		03.0521-0520.3	690112	ATE TOPKIT	
	1,3 TDCi	06.2010		03.0521-0520.3	690112	ATE TOPKIT	
KUGA I (08-12)	2,0 TDCi	04.2008	12.2012	28.0461-1145.1	BAR111	DISCO DE FRENO	LR027123 , 6G91-2A315-BA , 1385590 , 1405500 , 1379931
		03.2010	12.2012	28.0461-1145.1	BAR111	DISCO DE FRENO	LR027123 , 6G91-2A315-BA , 1385590 , 1405500 , 1379931
	2,0 TDCi 4x4	03.2010	12.2012	28.0461-1145.1	BAR111	DISCO DE FRENO	LR027123 , 6G91-2A315-BA , 1385590 , 1405500 , 1379931
		04.2008	12.2012	28.0461-1145.1	BAR111	DISCO DE FRENO	LR027123 , 6G91-2A315-BA , 1385590 , 1405500 , 1379931
	2,5 i	03.2009	12.2012	28.0461-1145.1	BAR111	DISCO DE FRENO	LR027123 , 6G91-2A315-BA , 1385590 , 1405500 , 1379931
	2,5 i 4x4	11.2008	12.2012	28.0461-1145.1	BAR111	DISCO DE FRENO	LR027123 , 6G91-2A315-BA , 1385590 , 1405500 , 1379931
MONDEO II (96-00)	1,6 i 16V	10.1996	09.2000	28.0462-0146.1	BAR201	DISCO DE FRENO	4115996 , 1025911 , 5026786
	1,8 i 16V	10.1996	09.2000	28.0462-0146.1	BAR201	DISCO DE FRENO	4115996 , 1025911 , 5026786
	1,8 TD	10.1996	09.2000	28.0462-0146.1	BAR201	DISCO DE FRENO	4115996 , 1025911 , 5026786
	2,0 i 16V	10.1996	09.2000	28.0462-0146.1	BAR201	DISCO DE FRENO	4115996 , 1025911 , 5026786
	2,5 i 24V	10.1996	09.2000	28.0462-0146.1	BAR201	DISCO DE FRENO	4115996 , 1025911 , 5026786
	2,5 ST 200	05.1999	09.2000	28.0462-0146.1	BAR201	DISCO DE FRENO	4115996 , 1025911 , 5026786
MONDEO IV (07-14)	1,6 EcoBoost	02.2011	09.2014	28.0461-1145.1	BAR111	DISCO DE FRENO	LR027123 , 6G91-2A315-BA , 1385590 , 1405500 , 1379931



Denominación

Ref. OE correspondientes a las referencias ATE



Referencia anterior / varios

FORD

Modelo	Motor	Fecha inicio	Fecha fin	Código ATE	Referencia ATE	Denominación	Ref. OE correspondientes a las referencias ATE	Referencia anterior / varios
MONDEO IV (07-14)	1,6 TDCi	02.2011	09.2014	28.0461-1145.1	BAR111	DISCO DE FRENO	LR027123 , 6G91-2A315-BA , 1385590 , 1405500 , 1379931	
	1,6 Ti VCT	07.2010	09.2014	28.0461-1145.1	BAR111	DISCO DE FRENO	LR027123 , 6G91-2A315-BA , 1385590 , 1405500 , 1379931	
		04.2007	09.2014	28.0461-1145.1	BAR111	DISCO DE FRENO	LR027123 , 6G91-2A315-BA , 1385590 , 1405500 , 1379931	
	1,8 TDCi	04.2007	09.2014	28.0461-1145.1	BAR111	DISCO DE FRENO	LR027123 , 6G91-2A315-BA , 1385590 , 1405500 , 1379931	
		06.2007	09.2014	28.0461-1145.1	BAR111	DISCO DE FRENO	LR027123 , 6G91-2A315-BA , 1385590 , 1405500 , 1379931	
	2,0 EcoBoost	07.2010	09.2014	28.0461-1145.1	BAR111	DISCO DE FRENO	LR027123 , 6G91-2A315-BA , 1385590 , 1405500 , 1379931	
	2,0 Flexifuel	03.2007	09.2014	28.0461-1145.1	BAR111	DISCO DE FRENO	LR027123 , 6G91-2A315-BA , 1385590 , 1405500 , 1379931	
	2,0 i 16V	04.2007	09.2014	28.0461-1145.1	BAR111	DISCO DE FRENO	LR027123 , 6G91-2A315-BA , 1385590 , 1405500 , 1379931	
	2,0 LPG	07.2009	09.2014	28.0461-1145.1	BAR111	DISCO DE FRENO	LR027123 , 6G91-2A315-BA , 1385590 , 1405500 , 1379931	
	2,0 SCTi	03.2010	09.2014	28.0461-1145.1	BAR111	DISCO DE FRENO	LR027123 , 6G91-2A315-BA , 1385590 , 1405500 , 1379931	
	2,0 TDCi	03.2010	09.2014	28.0461-1145.1	BAR111	DISCO DE FRENO	LR027123 , 6G91-2A315-BA , 1385590 , 1405500 , 1379931	
		04.2007	09.2014	28.0461-1145.1	BAR111	DISCO DE FRENO	LR027123 , 6G91-2A315-BA , 1385590 , 1405500 , 1379931	
		10.2007	09.2014	28.0461-1145.1	BAR111	DISCO DE FRENO	LR027123 , 6G91-2A315-BA , 1385590 , 1405500 , 1379931	
		03.2007	09.2014	28.0461-1145.1	BAR111	DISCO DE FRENO	LR027123 , 6G91-2A315-BA , 1385590 , 1405500 , 1379931	



Denominación

Ref. OE correspondientes a las referencias ATE

Referencia anterior / varios

FORD

Modelo	Motor	Fecha inicio	Fecha fin	Código ATE	Código OE	Denominación	Ref. OE correspondientes a las referencias ATE	Referencia anterior / varios
MONDEO IV (07-14)	2,2 TDCi	11.2010	09.2014	28.0461-1145.1	BAR111	DISCO DE FRENO	LR027123 , 6G91-2A315-BA , 1385590 , 1405500 , 1379931	
		04.2008	09.2014	28.0461-1145.1	BAR111	DISCO DE FRENO	LR027123 , 6G91-2A315-BA , 1385590 , 1405500 , 1379931	
	2,3 i 16V	07.2007	09.2014	28.0461-1145.1	BAR111	DISCO DE FRENO	LR027123 , 6G91-2A315-BA , 1385590 , 1405500 , 1379931	
	2,5 i 20V	04.2007	09.2014	28.0461-1145.1	BAR111	DISCO DE FRENO	LR027123 , 6G91-2A315-BA , 1385590 , 1405500 , 1379931	
RANGER (11-)	2,2 TDCi	05.2015		24.3220-1749.3	020589	CILINDRO DE RUEDA	AB31-2261-AA , 1717333	
		11.2011		24.3220-1749.3	020589	CILINDRO DE RUEDA	AB31-2261-AA , 1717333	
	2,2 TDCi 4x4	11.2011		24.3220-1749.3	020589	CILINDRO DE RUEDA	AB31-2261-AA , 1717333	
		05.2015		24.3220-1749.3	020589	CILINDRO DE RUEDA	AB31-2261-AA , 1717333	
	3,2 TDCi 4x4	11.2011		24.3220-1749.3	020589	CILINDRO DE RUEDA	AB31-2261-AA , 1717333	
SCORPIO / GRANADA (GB) (95-98)	2,0 i Kombi	10.1994	08.1998	28.0462-0146.1	BAR201	DISCO DE FRENO	4115996 , 1025911 , 5026786	
	2,3 i 16V Kombi	05.1996	08.1998	28.0462-0146.1	BAR201	DISCO DE FRENO	4115996 , 1025911 , 5026786	
	2,5 TD Kombi	10.1994	08.1998	28.0462-0146.1	BAR201	DISCO DE FRENO	4115996 , 1025911 , 5026786	
	2,9 i Kombi	01.1995	08.1998	28.0462-0146.1	BAR201	DISCO DE FRENO	4115996 , 1025911 , 5026786	
S-MAX (06-)	1,6 EcoBoost	02.2011		28.0461-1145.1	BAR111	DISCO DE FRENO	LR027123 , 6G91-2A315-BA , 1385590 , 1405500 , 1379931	
	1,6 TDCi	02.2011		28.0461-1145.1	BAR111	DISCO DE FRENO	LR027123 , 6G91-2A315-BA , 1385590 , 1405500 , 1379931	
	1,8 TDCi	01.2007		28.0461-1145.1	BAR111	DISCO DE FRENO	LR027123 , 6G91-2A315-BA , 1385590 , 1405500 , 1379931	
		04.2006		28.0461-1145.1	BAR111	DISCO DE FRENO	LR027123 , 6G91-2A315-BA , 1385590 , 1405500 , 1379931	



Denominación

Ref. OE correspondientes a las referencias ATE



Referencia anterior / varios

FORD

S-MAX (06-)	2,0 EcoBoost		07.2010		28.0461-1145.1	BAR111	DISCO DE FRENO	LR027123 , 6G91-2A315-BA , 1385590 , 1405500 , 1379931	
	2,0 i 16V		04.2006		28.0461-1145.1	BAR111	DISCO DE FRENO	LR027123 , 6G91-2A315-BA , 1385590 , 1405500 , 1379931	
	2,0 SCTi EcoBoost		03.2010		28.0461-1145.1	BAR111	DISCO DE FRENO	LR027123 , 6G91-2A315-BA , 1385590 , 1405500 , 1379931	
	2,0 TDCi		05.2006		28.0461-1145.1	BAR111	DISCO DE FRENO	LR027123 , 6G91-2A315-BA , 1385590 , 1405500 , 1379931	
			04.2006		28.0461-1145.1	BAR111	DISCO DE FRENO	LR027123 , 6G91-2A315-BA , 1385590 , 1405500 , 1379931	
			10.2007		28.0461-1145.1	BAR111	DISCO DE FRENO	LR027123 , 6G91-2A315-BA , 1385590 , 1405500 , 1379931	
			03.2010		28.0461-1145.1	BAR111	DISCO DE FRENO	LR027123 , 6G91-2A315-BA , 1385590 , 1405500 , 1379931	
	2,2 TDCi		04.2008		28.0461-1145.1	BAR111	DISCO DE FRENO	LR027123 , 6G91-2A315-BA , 1385590 , 1405500 , 1379931	
			07.2010		28.0461-1145.1	BAR111	DISCO DE FRENO	LR027123 , 6G91-2A315-BA , 1385590 , 1405500 , 1379931	
	2,3 i 16V		07.2007		28.0461-1145.1	BAR111	DISCO DE FRENO	LR027123 , 6G91-2A315-BA , 1385590 , 1405500 , 1379931	
	2,5 ST		04.2006		28.0461-1145.1	BAR111	DISCO DE FRENO	LR027123 , 6G91-2A315-BA , 1385590 , 1405500 , 1379931	
TRANSIT (00-06)	2,0 DI		08.2000	04.2006	28.0462-4167.1	BAR241	DISCO DE FRENO	1C1J-1125-A2D , 1C1J-1125-A1D , 1C1J-1125-AD , 1C1J-1125-AC , 1C1J-1125-AB , 1C1W-1125-AB , 1738807 , 1568654 , 1520371 , 1473008 , 1456667 , 4395257 , 4041427	



Denominación

Ref. OE correspondientes a las referencias ATE



Referencia anterior / varios

FORD

Modelo	Motor	Fecha inicio	Fecha fin	Código ATE	Referencia ATE	Denominación	Ref. OE correspondientes a las referencias ATE	Referencia anterior / varios
TRANSIT (00-06)	2,0 TDCi	08.2002	04.2006	28.0462-4167.1	BAR241	DISCO DE FRENO	1C1J-1125-A2D , 1C1J-1125-A1D , 1C1J-1125-AD , 1C1J-1125-AC , 1C1J-1125-AB , 1C1W-1125-AB , 1738807 , 1568654 , 1520371 , 1473008 , 1456667 , 4395257 , 4041427	
	2,3 i 16V	04.2001	04.2006	28.0462-4167.1	BAR241	DISCO DE FRENO	1C1J-1125-A2D , 1C1J-1125-A1D , 1C1J-1125-AD , 1C1J-1125-AC , 1C1J-1125-AB , 1C1W-1125-AB , 1738807 , 1568654 , 1520371 , 1473008 , 1456667 , 4395257 , 4041427	
	2,4 DI	01.2000	04.2006	28.0462-4167.1	BAR241	DISCO DE FRENO	1C1J-1125-A2D , 1C1J-1125-A1D , 1C1J-1125-AD , 1C1J-1125-AC , 1C1J-1125-AB , 1C1W-1125-AB , 1738807 , 1568654 , 1520371 , 1473008 , 1456667 , 4395257 , 4041427	
	2,4 TDCi	03.2004	04.2006	28.0462-4167.1	BAR241	DISCO DE FRENO	1C1J-1125-A2D , 1C1J-1125-A1D , 1C1J-1125-AD , 1C1J-1125-AC , 1C1J-1125-AB , 1C1W-1125-AB , 1738807 , 1568654 , 1520371 , 1473008 , 1456667 , 4395257 , 4041427	
	2,4 TDE	11.2001	04.2006	28.0462-4167.1	BAR241	DISCO DE FRENO	1C1J-1125-A2D , 1C1J-1125-A1D , 1C1J-1125-AD , 1C1J-1125-AC , 1C1J-1125-AB , 1C1W-1125-AB , 1738807 , 1568654 , 1520371 , 1473008 , 1456667 , 4395257 , 4041427	



	i				Denominación	Ref. OE correspondientes a las referencias ATE	i Referencia anterior / varios
--	----------	--	--	--	---------------------	---	--

HONDA

Modelo	Motor	TI	Fecha	Part. 1	Part. 2	Denominación	Ref. OE correspondientes a las referencias ATE
JAZZ (08-15)	1,2 i-VTEC	TI	01.2009	24.5278-0254.3	331471	LATIGUILLO	01468-TF0-G00
	1,3 Hybrid	TI	04.2011	24.5278-0254.3	331471	LATIGUILLO	01468-TF0-G00
	1,4 Flexfuel	TI	11.2008	24.5278-0254.3	331471	LATIGUILLO	01468-TF0-G00
	1,4 i 16V		07.2008	24.0109-0178.1	409178	DISCO DE FRENO	42510-T5B-950 , 42510-TF0-000
		TI	01.2009	24.5278-0254.3	331471	LATIGUILLO	01468-TF0-G00
		TI	11.2008	24.5278-0254.3	331471	LATIGUILLO	01468-TF0-G00
	1,5 Flexfuel	TI	01.2009	24.5278-0254.3	331471	LATIGUILLO	01468-TF0-G00
	1,5 i 16V	TI	01.2009	24.5278-0254.3	331471	LATIGUILLO	01468-TF0-G00
JAZZ (15-)	1,3 i-VTEC		09.2015	24.0109-0178.1	409178	DISCO DE FRENO	42510-T5B-950 , 42510-TF0-000



Denominación

Ref. OE correspondientes a las referencias ATE

Referencia anterior / varios

HYUNDAI

i30 (07-11)	1,4 16V	TI	10.2007	10.2011	24.5294-0293.3	331515	LATIGUILLO	58737-2L700	
	1,6 16V	TI	02.2008	10.2011	24.5294-0293.3	331515	LATIGUILLO	58737-2L700	
		TI	10.2007	10.2011	24.5294-0293.3	331515	LATIGUILLO	58737-2L700	
	1,6 CRDi	TI	02.2008	10.2011	24.5294-0293.3	331515	LATIGUILLO	58737-2L700	
		TI	10.2007	10.2011	24.5294-0293.3	331515	LATIGUILLO	58737-2L700	
	2,0 16V	TI	10.2007	10.2011	24.5294-0293.3	331515	LATIGUILLO	58737-2L700	
	2,0 CRDi	TI	02.2008	10.2011	24.5294-0293.3	331515	LATIGUILLO	58737-2L700	
		TI	10.2007	10.2011	24.5294-0293.3	331515	LATIGUILLO	58737-2L700	
i30 CW Kombi (08-12)	1,4 16V	TI	02.2008	06.2012	24.5294-0293.3	331515	LATIGUILLO	58737-2L700	
		TI	11.2009	06.2012	24.5294-0293.3	331515	LATIGUILLO	58737-2L700	
	1,6 16V	TI	01.2010	06.2012	24.5294-0293.3	331515	LATIGUILLO	58737-2L700	
		TI	02.2008	06.2012	24.5294-0293.3	331515	LATIGUILLO	58737-2L700	
	1,6 CRDi	TI	02.2008	06.2012	24.5294-0293.3	331515	LATIGUILLO	58737-2L700	
	2,0 16V	TI	02.2008	06.2012	24.5294-0293.3	331515	LATIGUILLO	58737-2L700	
	2,0 CRDi	TI	02.2008	06.2012	24.5294-0293.3	331515	LATIGUILLO	58737-2L700	
		TI	01.2010	06.2012	24.5294-0293.3	331515	LATIGUILLO	58737-2L700	



Denominación

Ref. OE correspondientes a las referencias ATE



Referencia anterior / varios

JAGUAR

XF (CC9) (08-)	2,0 16V		06.2012		24.8190-0960.2	620960	CONTACTO DE DESGASTE	C2D 2976	
	2,2 D		03.2012		24.8190-0960.2	620960	CONTACTO DE DESGASTE	C2D 2976	
			04.2011		24.8190-0960.2	620960	CONTACTO DE DESGASTE	C2D 2976	
			05.2011		24.8190-0960.2	620960	CONTACTO DE DESGASTE	C2D 2976	
	2,7 D				24.8190-0960.2	620960	CONTACTO DE DESGASTE	C2D 2976	
			03.2008		24.8190-0960.2	620960	CONTACTO DE DESGASTE	C2D 2976	
	3,0 D				24.8190-0960.2	620960	CONTACTO DE DESGASTE	C2D 2976	
			03.2009		24.8190-0960.2	620960	CONTACTO DE DESGASTE	C2D 2976	
	3,0 V6		03.2012		24.8190-0960.2	620960	CONTACTO DE DESGASTE	C2D 2976	
					24.8190-0960.2	620960	CONTACTO DE DESGASTE	C2D 2976	
			03.2008		24.8190-0960.2	620960	CONTACTO DE DESGASTE	C2D 2976	
	3,0 V6 AWD		10.2012		24.8190-0960.2	620960	CONTACTO DE DESGASTE	C2D 2976	
	4,2 V8		03.2008		24.8190-0960.2	620960	CONTACTO DE DESGASTE	C2D 2976	
			07.2009		24.8190-0960.2	620960	CONTACTO DE DESGASTE	C2D 2976	
					24.8190-0960.2	620960	CONTACTO DE DESGASTE	C2D 2976	
	4,2 V8 Kompressor				24.8190-0960.2	620960	CONTACTO DE DESGASTE	C2D 2976	
			03.2008		24.8190-0960.2	620960	CONTACTO DE DESGASTE	C2D 2976	
	5,0 V8				24.8190-0960.2	620960	CONTACTO DE DESGASTE	C2D 2976	
			03.2009		24.8190-0960.2	620960	CONTACTO DE DESGASTE	C2D 2976	
	5,0 V8 Kompressor				24.8190-0960.2	620960	CONTACTO DE DESGASTE	C2D 2976	
			01.2009		24.8190-0960.2	620960	CONTACTO DE DESGASTE	C2D 2976	



Denominación

Ref. OE correspondientes a las referencias ATE

Referencia anterior / varios

JAGUAR

Modelo	Motor	Fecha	Fecha	Código	Código	Denominación	Ref. OE
XF (CC9) (08-)	5,0 V8 Kompressor	03.2009		24.8190-0960.2	620960	CONTACTO DE DESGASTE	C2D 2976
	5,0 XFR-S	10.2012		24.8190-0960.2	620960	CONTACTO DE DESGASTE	C2D 2976
XF Sportbrake (CC9) (12-)	2,2 D	09.2012		24.8190-0960.2	620960	CONTACTO DE DESGASTE	C2D 2976
	3,0 D	09.2012		24.8190-0960.2	620960	CONTACTO DE DESGASTE	C2D 2976
	5,0 XFR-S	02.2014		24.8190-0960.2	620960	CONTACTO DE DESGASTE	C2D 2976
XJ (X350,X358) (03-09)	XJ6 2,7 D		03.2009	24.8190-0960.2	620960	CONTACTO DE DESGASTE	C2D 2976
XJ (X351) (09-)	2,0 16V	05.2012		24.8190-0960.2	620960	CONTACTO DE DESGASTE	C2D 2976
	3,0 V6	01.2011		24.8190-0960.2	620960	CONTACTO DE DESGASTE	C2D 2976
		03.2012		24.8190-0960.2	620960	CONTACTO DE DESGASTE	C2D 2976
	3,0 V6 AWD	10.2012		24.8190-0960.2	620960	CONTACTO DE DESGASTE	C2D 2976
	3,0 V6 D	04.2015		24.8190-0960.2	620960	CONTACTO DE DESGASTE	C2D 2976
		10.2009		24.8190-0960.2	620960	CONTACTO DE DESGASTE	C2D 2976
	5,0 V8	10.2009		24.8190-0960.2	620960	CONTACTO DE DESGASTE	C2D 2976
XK8 CABRIOLE (06-)	5,0 XKR			24.8190-0960.2	620960	CONTACTO DE DESGASTE	C2D 2976
		01.2009		24.8190-0960.2	620960	CONTACTO DE DESGASTE	C2D 2976
	5,0 XKR-S	01.2011		24.8190-0960.2	620960	CONTACTO DE DESGASTE	C2D 2976
XK Coupe (06-)	5,0 XKR			24.8190-0960.2	620960	CONTACTO DE DESGASTE	C2D 2976
		01.2009		24.8190-0960.2	620960	CONTACTO DE DESGASTE	C2D 2976
		09.2010		24.8190-0960.2	620960	CONTACTO DE DESGASTE	C2D 2976
	5,0 XKR-S	01.2011		24.8190-0960.2	620960	CONTACTO DE DESGASTE	C2D 2976



Denominación

Ref. OE correspondientes a las referencias ATE



Referencia anterior / varios

JEEP

Modelo	Motor	Fecha inicio	Fecha fin	Código ATE	Código OE	Denominación	Referencias OE	Referencia anterior / varios
CHEROKEE (KJ) (01-08)	2,4 16V	09.2001	01.2008	24.3220-1751.3	020590	CILINDRO DE RUEDA	0 5066 158AA , 5066 158AA	
	2,4 16V Laredo	10.2001	09.2004	24.3220-1751.3	020590	CILINDRO DE RUEDA	0 5066 158AA , 5066 158AA	
	2,5 CRD	09.2001	01.2008	24.3220-1751.3	020590	CILINDRO DE RUEDA	0 5066 158AA , 5066 158AA	
	2,8 CRD	11.2004	01.2008	24.3220-1751.3	020590	CILINDRO DE RUEDA	0 5066 158AA , 5066 158AA	
	3,7 V6	09.2001	01.2008	24.3220-1751.3	020590	CILINDRO DE RUEDA	0 5066 158AA , 5066 158AA	
		08.2003	01.2008	24.3220-1751.3	020590	CILINDRO DE RUEDA	0 5066 158AA , 5066 158AA	
	3,7 V6 Laredo	10.2001	09.2004	24.3220-1751.3	020590	CILINDRO DE RUEDA	0 5066 158AA , 5066 158AA	
GRAND CHEROKEE IV (WK) (10-)	3,0 CRD V6 4x4	02.2011		24.0114-0120.1	414120	DISCO DE FRENO	0 5212 4763AB , 5212 4763AB	
	3,6 V6 4x4	11.2010		24.0114-0120.1	414120	DISCO DE FRENO	0 5212 4763AB , 5212 4763AB	
	3,6 V6 FlexFuel 4x4	11.2010		24.0114-0120.1	414120	DISCO DE FRENO	0 5212 4763AB , 5212 4763AB	
	5,7 V8 4x4	11.2010		24.0114-0120.1	414120	DISCO DE FRENO	0 5212 4763AB , 5212 4763AB	
	6,4 SRT8 4x4	03.2011		24.0114-0120.1	414120	DISCO DE FRENO	0 5212 4763AB , 5212 4763AB	



					Denominación	Ref. OE correspondientes a las referencias ATE		Referencia anterior / varios
--	--	--	--	--	---------------------	---	--	-------------------------------------

KIA

Modelo	Motor	Desde	Hasta	ATE Ref.	ATE Ref.	Denominación	Ref. OE correspondientes a las referencias ATE	Referencia anterior / varios
SPORTAGE (94-03)	2,0 i 16V	10.1999	08.2003	24.3220-1752.3	020591	CILINDRO DE RUEDA	0K045-26-610	
		10.2000	08.2003	24.3220-1752.3	020591	CILINDRO DE RUEDA	0K045-26-610	
	2,0 i 16V 4WD	10.2000	08.2003	24.3220-1752.3	020591	CILINDRO DE RUEDA	0K045-26-610	
		10.1999	08.2003	24.3220-1752.3	020591	CILINDRO DE RUEDA	0K045-26-610	
	2,0 TDi 4WD	10.1997	08.2003	24.3220-1752.3	020591	CILINDRO DE RUEDA	0K045-26-610	



Denominación

Ref. OE correspondientes a las referencias ATE

Referencia anterior / varios

LANCIA

Modelo	Motor	Fecha	Referencia	Parte	Denominación	Ref. OE correspondientes a las referencias ATE	Referencia anterior / varios
DELTA / Chrysler Delta (08-)	1,4 16V	07.2010	28.0461-0190.1	BAR101	DISCO DE FRENO	60801753 , 60801390 , 16420.26100.01/00 , 46831042 , 46758715 , 60801755 , 82434070 , 82433859 , 82394418	
		08.2008	28.0461-0190.1	BAR101	DISCO DE FRENO	60801753 , 60801390 , 16420.26100.01/00 , 46831042 , 46758715 , 60801755 , 82434070 , 82433859 , 82394418	
	1,4 16V Turbo	08.2008	28.0461-0190.1	BAR101	DISCO DE FRENO	60801753 , 60801390 , 16420.26100.01/00 , 46831042 , 46758715 , 60801755 , 82434070 , 82433859 , 82394418	
	1,4 Bifuel	07.2011	28.0461-0190.1	BAR101	DISCO DE FRENO	60801753 , 60801390 , 16420.26100.01/00 , 46831042 , 46758715 , 60801755 , 82434070 , 82433859 , 82394418	
	1,6 D Multijet	08.2008	28.0461-0190.1	BAR101	DISCO DE FRENO	60801753 , 60801390 , 16420.26100.01/00 , 46831042 , 46758715 , 60801755 , 82434070 , 82433859 , 82394418	
		04.2011	28.0461-0190.1	BAR101	DISCO DE FRENO	60801753 , 60801390 , 16420.26100.01/00 , 46831042 , 46758715 , 60801755 , 82434070 , 82433859 , 82394418	
	1,8 Di 16V	01.2009	28.0461-0190.1	BAR101	DISCO DE FRENO	60801753 , 60801390 , 16420.26100.01/00 , 46831042 , 46758715 , 60801755 , 82434070 , 82433859 , 82394418	



Denominación

Ref. OE correspondientes a las referencias ATE









Referencia anterior / varios

LANCIA

Modelo	Motor	Fecha inicio	Fecha fin	Código ATE	Referencia ATE	Denominación	Ref. OE correspondientes a las referencias ATE	Referencia anterior / varios
DELTA / Chrysler Delta (08-)	1,9 D Multijet	08.2008		28.0461-0190.1	BAR101	DISCO DE FRENO	60801753 , 60801390 , 16420.26100.01/00 , 46831042 , 46758715 , 60801755 , 82434070 , 82433859 , 82394418	
	2,0 D Multijet	08.2008		28.0461-0190.1	BAR101	DISCO DE FRENO	60801753 , 60801390 , 16420.26100.01/00 , 46831042 , 46758715 , 60801755 , 82434070 , 82433859 , 82394418	
LYBRA (99-05)	1,6	10.2000	10.2005	28.0461-0190.1	BAR101	DISCO DE FRENO	60801753 , 60801390 , 16420.26100.01/00 , 46831042 , 46758715 , 60801755 , 82434070 , 82433859 , 82394418	
	1,6 i 16V	10.1999	12.2005	28.0461-0190.1	BAR101	DISCO DE FRENO	60801753 , 60801390 , 16420.26100.01/00 , 46831042 , 46758715 , 60801755 , 82434070 , 82433859 , 82394418	
	1,8 i 16V	10.1999	12.2005	28.0461-0190.1	BAR101	DISCO DE FRENO	60801753 , 60801390 , 16420.26100.01/00 , 46831042 , 46758715 , 60801755 , 82434070 , 82433859 , 82394418	
	1,9 JTD	10.1999	12.2005	28.0461-0190.1	BAR101	DISCO DE FRENO	60801753 , 60801390 , 16420.26100.01/00 , 46831042 , 46758715 , 60801755 , 82434070 , 82433859 , 82394418	
	2,0 i 20V	10.1999	12.2005	28.0461-0190.1	BAR101	DISCO DE FRENO	60801753 , 60801390 , 16420.26100.01/00 , 46831042 , 46758715 , 60801755 , 82434070 , 82433859 , 82394418	



					Denominación	Ref. OE correspondientes a las referencias ATE	 Referencia anterior / varios
---	---	---	--	---	---------------------	---	--

LANCIA

Modelo	Motor	Fecha 1	Fecha 2	Part. 1	Part. 2	Denominación	Ref. OE correspondientes a las referencias ATE	Referencia anterior / varios
LYBRA (99-05)	2,4 20V	10.2001	12.2005	28.0461-0190.1	BAR101	DISCO DE FRENO	60801753 , 60801390 , 16420.26100.01/00 , 46831042 , 46758715 , 60801755 , 82434070 , 82433859 , 82394418	
	2,4 JTD	10.1999	12.2005	28.0461-0190.1	BAR101	DISCO DE FRENO	60801753 , 60801390 , 16420.26100.01/00 , 46831042 , 46758715 , 60801755 , 82434070 , 82433859 , 82394418	
YPSILON / Chrysler Ypsilon (11-)	0,9	12.2013		03.0521-0620.3	690111	ATE TOPKIT		
	0,9 Twinair	05.2011		03.0521-0620.3	690111	ATE TOPKIT		
	1,2	05.2011		03.0521-0620.3	690111	ATE TOPKIT		
	1,2 Bifuel	04.2015		03.0521-0620.3	690111	ATE TOPKIT		
		05.2011		03.0521-0620.3	690111	ATE TOPKIT		
	1,3 D Multijet	05.2011		03.0521-0620.3	690111	ATE TOPKIT		
		06.2016		03.0521-0620.3	690111	ATE TOPKIT		



					Denominación	Ref. OE correspondientes a las referencias ATE	Referencia anterior / varios
--	--	--	--	--	---------------------	---	-------------------------------------

LAND ROVER

RANGE ROVER EVOQUE (SAL) (11-)	2,0 16V 4x4		06.2011		28.0461-1145.1	BAR111	DISCO DE FRENO	LR027123 , 6G91-2A315-BA , 1385590 , 1405500 , 1379931	
	2,0 eD4		06.2015		28.0461-1145.1	BAR111	DISCO DE FRENO	LR027123 , 6G91-2A315-BA , 1385590 , 1405500 , 1379931	
	2,0 TD4 4x4		05.2015		28.0461-1145.1	BAR111	DISCO DE FRENO	LR027123 , 6G91-2A315-BA , 1385590 , 1405500 , 1379931	
			06.2015		28.0461-1145.1	BAR111	DISCO DE FRENO	LR027123 , 6G91-2A315-BA , 1385590 , 1405500 , 1379931	
	2,2 eD4		06.2011		28.0461-1145.1	BAR111	DISCO DE FRENO	LR027123 , 6G91-2A315-BA , 1385590 , 1405500 , 1379931	
	2,2 SD4 4x4		06.2011		28.0461-1145.1	BAR111	DISCO DE FRENO	LR027123 , 6G91-2A315-BA , 1385590 , 1405500 , 1379931	
	2,2 TD4 4x4		06.2011		28.0461-1145.1	BAR111	DISCO DE FRENO	LR027123 , 6G91-2A315-BA , 1385590 , 1405500 , 1379931	
RANGE ROVER EVOQUE Cabriolet (16-)	2,0 16V 4x4		02.2016		28.0461-1145.1	BAR111	DISCO DE FRENO	LR027123 , 6G91-2A315-BA , 1385590 , 1405500 , 1379931	
	2,0 TD4 4x4		02.2016		28.0461-1145.1	BAR111	DISCO DE FRENO	LR027123 , 6G91-2A315-BA , 1385590 , 1405500 , 1379931	

LEXUS

GX 470 (URJ15) (09-)	4,7 V8		01.2010		24.0132-0174.1	432174	DISCO DE FRENO	43512-60190	
			11.2009		24.0132-0174.1	432174	DISCO DE FRENO	43512-60190	



Denominación

Ref. OE correspondientes a las referencias ATE



Referencia anterior / varios

MINI

F54 Clubman (15-)	Cooper		07.2015		13.0460-7315.2	607315	PASTILLAS DE FRENO	34 21 6 859 917	ver figura
			07.2015		13.0470-7315.2	LD7315	CERAMIC PAST. DE FRENO	34 21 6 859 917	
	Cooper D		07.2015		13.0460-7315.2	607315	PASTILLAS DE FRENO	34 21 6 859 917	ver figura
			07.2015		13.0470-7315.2	LD7315	CERAMIC PAST. DE FRENO	34 21 6 859 917	
	Cooper S		07.2015		13.0460-7315.2	607315	PASTILLAS DE FRENO	34 21 6 859 917	ver figura
			07.2015		13.0470-7315.2	LD7315	CERAMIC PAST. DE FRENO	34 21 6 859 917	
	Cooper SD		11.2015		13.0460-7315.2	607315	PASTILLAS DE FRENO	34 21 6 859 917	ver figura
			11.2015		13.0470-7315.2	LD7315	CERAMIC PAST. DE FRENO	34 21 6 859 917	
	Cooper SDX All4		01.2016		13.0460-7315.2	607315	PASTILLAS DE FRENO	34 21 6 859 917	ver figura
			01.2016		13.0470-7315.2	LD7315	CERAMIC PAST. DE FRENO	34 21 6 859 917	
	Cooper SX All4		01.2016		13.0460-7315.2	607315	PASTILLAS DE FRENO	34 21 6 859 917	ver figura
			01.2016		13.0470-7315.2	LD7315	CERAMIC PAST. DE FRENO	34 21 6 859 917	
	John Cooper Works		11.2015		13.0460-7315.2	607315	PASTILLAS DE FRENO	34 21 6 859 917	ver figura
			11.2015		13.0470-7315.2	LD7315	CERAMIC PAST. DE FRENO	34 21 6 859 917	
	One		11.2015		13.0460-7315.2	607315	PASTILLAS DE FRENO	34 21 6 859 917	ver figura
			11.2015		13.0470-7315.2	LD7315	CERAMIC PAST. DE FRENO	34 21 6 859 917	
	One D		11.2015		13.0460-7315.2	607315	PASTILLAS DE FRENO	34 21 6 859 917	ver figura
			11.2015		13.0470-7315.2	LD7315	CERAMIC PAST. DE FRENO	34 21 6 859 917	
F60 Countryman (17-)	Cooper		10.2016		13.0460-7315.2	607315	PASTILLAS DE FRENO	34 21 6 859 917	ver figura
			10.2016		13.0470-7315.2	LD7315	CERAMIC PAST. DE FRENO	34 21 6 859 917	
	Cooper All4		10.2016		13.0460-7315.2	607315	PASTILLAS DE FRENO	34 21 6 859 917	ver figura



					Denominación	Ref. OE correspondientes a las referencias ATE	Referencia anterior / varios
--	--	--	--	--	---------------------	---	-------------------------------------

MINI

F60 Countryman (17-)	Cooper All4		10.2016		13.0470-7315.2	LD7315	CERAMIC PAST. DE FRENO	34 21 6 859 917	
	Cooper D		10.2016		13.0460-7315.2	607315	PASTILLAS DE FRENO	34 21 6 859 917	ver figura
			10.2016		13.0470-7315.2	LD7315	CERAMIC PAST. DE FRENO	34 21 6 859 917	
	Cooper D All4		10.2016		13.0460-7315.2	607315	PASTILLAS DE FRENO	34 21 6 859 917	ver figura
			10.2016		13.0470-7315.2	LD7315	CERAMIC PAST. DE FRENO	34 21 6 859 917	
	Cooper S		10.2016		13.0460-7315.2	607315	PASTILLAS DE FRENO	34 21 6 859 917	ver figura
			10.2016		13.0470-7315.2	LD7315	CERAMIC PAST. DE FRENO	34 21 6 859 917	
	Cooper S All4		10.2016		13.0460-7315.2	607315	PASTILLAS DE FRENO	34 21 6 859 917	ver figura
			10.2016		13.0470-7315.2	LD7315	CERAMIC PAST. DE FRENO	34 21 6 859 917	
	Cooper SD		10.2016		13.0460-7315.2	607315	PASTILLAS DE FRENO	34 21 6 859 917	ver figura
			10.2016		13.0470-7315.2	LD7315	CERAMIC PAST. DE FRENO	34 21 6 859 917	
	Cooper SD All4		10.2016		13.0460-7315.2	607315	PASTILLAS DE FRENO	34 21 6 859 917	ver figura
			10.2016		13.0470-7315.2	LD7315	CERAMIC PAST. DE FRENO	34 21 6 859 917	



Denominación

Ref. OE correspondientes a las referencias ATE



Referencia anterior / varios

NISSAN

Modelo	Motor	Fecha inicio	Fecha fin	Código ATE	Referencia ATE	Denominación	Ref. OE correspondientes a las referencias ATE	Referencia anterior / varios
ALMERA (N16) (00-06)	1,5 dCi	01.2003	11.2006	28.0462-2179.1	BAR221	DISCO DE FRENO	40206-2F501 , 40206-55F03 , 40206-55F01 , 40206-2F500	
	1,5 i	02.2000	11.2006	28.0462-2179.1	BAR221	DISCO DE FRENO	40206-2F501 , 40206-55F03 , 40206-55F01 , 40206-2F500	
		10.2002	11.2006	28.0462-2179.1	BAR221	DISCO DE FRENO	40206-2F501 , 40206-55F03 , 40206-55F01 , 40206-2F500	
		03.2000	03.2001	28.0462-2179.1	BAR221	DISCO DE FRENO	40206-2F501 , 40206-55F03 , 40206-55F01 , 40206-2F500	
	1,8 i	10.2002	11.2006	28.0462-2179.1	BAR221	DISCO DE FRENO	40206-2F501 , 40206-55F03 , 40206-55F01 , 40206-2F500	
		03.2000	03.2001	28.0462-2179.1	BAR221	DISCO DE FRENO	40206-2F501 , 40206-55F03 , 40206-55F01 , 40206-2F500	
		02.2000	11.2006	28.0462-2179.1	BAR221	DISCO DE FRENO	40206-2F501 , 40206-55F03 , 40206-55F01 , 40206-2F500	
	2,2 dCi	09.2003	11.2006	28.0462-2179.1	BAR221	DISCO DE FRENO	40206-2F501 , 40206-55F03 , 40206-55F01 , 40206-2F500	
	2,2 Di	03.2000	03.2001	28.0462-2179.1	BAR221	DISCO DE FRENO	40206-2F501 , 40206-55F03 , 40206-55F01 , 40206-2F500	
		02.2000	11.2006	28.0462-2179.1	BAR221	DISCO DE FRENO	40206-2F501 , 40206-55F03 , 40206-55F01 , 40206-2F500	
LEAF (EM61) (10-)	Electric	11.2010		24.0128-0268.1	428268	DISCO DE FRENO	40206-3NL0A , 40206-3NA0A	
NV 200 (M20) Kasten (10-)	e-NV	05.2014		24.0128-0268.1	428268	DISCO DE FRENO	40206-3NL0A , 40206-3NA0A	
NV 200 EVALIA (M20) Bus (10-)		07.2014		24.0128-0268.1	428268	DISCO DE FRENO	40206-3NL0A , 40206-3NA0A	
PRIMERA (P11E) Berlina (96-02)	1,6 i 16V	06.1999	02.2002	28.0462-2179.1	BAR221	DISCO DE FRENO	40206-2F501 , 40206-55F03 , 40206-55F01 , 40206-2F500	
	1,8 i 16V	06.1999	02.2002	28.0462-2179.1	BAR221	DISCO DE FRENO	40206-2F501 , 40206-55F03 , 40206-55F01 , 40206-2F500	



Denominación

Ref. OE correspondientes a las referencias ATE

Referencia anterior / varios

NISSAN

Modelo	Motor	Fecha inicio	Fecha fin	Código OE	Código ATE	Denominación	Ref. OE correspondientes a las referencias ATE	Referencia anterior / varios
PRIMERA (P11E) Berlina (96-02)	2,0 i 16V	06.1996	02.2002	28.0462-2179.1	BAR221	DISCO DE FRENO	40206-2F501 , 40206-55F03 , 40206-55F01 , 40206-2F500	
		06.1999	02.2002	28.0462-2179.1	BAR221	DISCO DE FRENO	40206-2F501 , 40206-55F03 , 40206-55F01 , 40206-2F500	
	2,0 TD	06.1999	02.2002	28.0462-2179.1	BAR221	DISCO DE FRENO	40206-2F501 , 40206-55F03 , 40206-55F01 , 40206-2F500	
PRIMERA (W11) Break (98-02)	1,6 i 16V	04.1998	02.2002	28.0462-2179.1	BAR221	DISCO DE FRENO	40206-2F501 , 40206-55F03 , 40206-55F01 , 40206-2F500	
	1,8 i 16V	08.1999	02.2002	28.0462-2179.1	BAR221	DISCO DE FRENO	40206-2F501 , 40206-55F03 , 40206-55F01 , 40206-2F500	
	2,0 i 16V	08.1999	02.2002	28.0462-2179.1	BAR221	DISCO DE FRENO	40206-2F501 , 40206-55F03 , 40206-55F01 , 40206-2F500	
		04.1998	02.2002	28.0462-2179.1	BAR221	DISCO DE FRENO	40206-2F501 , 40206-55F03 , 40206-55F01 , 40206-2F500	
	2,0 TD	04.1998	02.2002	28.0462-2179.1	BAR221	DISCO DE FRENO	40206-2F501 , 40206-55F03 , 40206-55F01 , 40206-2F500	



Denominación

Ref. OE correspondientes a las referencias ATE

Referencia anterior / varios

OPEL

Modelo	Motor	Fecha	Ref. ATE	Denominación	Ref. OE correspondientes	Referencia anterior / varios
AGILA / Vauxhall Agila Mk I (00-07)	1	07.2007	28.0461-7106.1	BAR171 DISCO DE FRENO	55311-84E01, 55311-86G02, 5531186G02, 47 07 288, 93179462, 93176389, 47 06 749	
	1,0 12V	07.2007	28.0461-7106.1	BAR171 DISCO DE FRENO	55311-84E01, 55311-86G02, 5531186G02, 47 07 288, 93179462, 93176389, 47 06 749	
	1,2 16V	07.2007	28.0461-7106.1	BAR171 DISCO DE FRENO	55311-84E01, 55311-86G02, 5531186G02, 47 07 288, 93179462, 93176389, 47 06 749	
	1,2 16V Twinport	07.2007	28.0461-7106.1	BAR171 DISCO DE FRENO	55311-84E01, 55311-86G02, 5531186G02, 47 07 288, 93179462, 93176389, 47 06 749	
	1,3 CDTI	07.2007	28.0461-7106.1	BAR171 DISCO DE FRENO	55311-84E01, 55311-86G02, 5531186G02, 47 07 288, 93179462, 93176389, 47 06 749	
AGILA / Vauxhall Agila Mk II (08-)	1	01.2008	28.0462-0211.1	BAR202 DISCO DE FRENO	55311-62J00, 95513700, 93194988, 47 00 455, 47 10 944, 93192978, 47 08 241	
		07.2011	28.0462-0211.1	BAR202 DISCO DE FRENO	55311-62J00, 95513700, 93194988, 47 00 455, 47 10 944, 93192978, 47 08 241	
	1,2	01.2008	28.0462-0211.1	BAR202 DISCO DE FRENO	55311-62J00, 95513700, 93194988, 47 00 455, 47 10 944, 93192978, 47 08 241	
		11.2010	28.0462-0211.1	BAR202 DISCO DE FRENO	55311-62J00, 95513700, 93194988, 47 00 455, 47 10 944, 93192978, 47 08 241	



Denominación

Ref. OE correspondientes a las referencias ATE

Referencia anterior / varios

OPEL

Modelo	Motor		Fecha inicio	Fecha fin	Código ATE	Código OE	Denominación	Referencias OE	Referencia anterior / varios
AGILA / Vauxhall Agila Mk II (08-)	1,3 CDTI		01.2008		28.0462-0211.1	BAR202	DISCO DE FRENO	55311-62J00 , 95513700 , 93194988 , 47 00 455 , 47 10 944 , 93192978 , 47 08 241	
ASTRA H / GTC / Vauxhall Astra Mk V (04-10)	1,2	TD	08.2005	11.2010	24.3387-1702.5	240827	PINZA DE GARRA	93179159 , 5 42 106	
	1,3 CDTI	TD	08.2005	11.2010	24.3387-1702.5	240827	PINZA DE GARRA	93179159 , 5 42 106	
	1,4	TD	01.2004	11.2010	24.3387-1702.5	240827	PINZA DE GARRA	93179159 , 5 42 106	
	1,6	TD	01.2004	11.2010	24.3387-1702.5	240827	PINZA DE GARRA	93179159 , 5 42 106	
		TD	01.2007	11.2010	24.3387-1702.5	240827	PINZA DE GARRA	93179159 , 5 42 106	
	1,6 Turbo	TD	01.2007	11.2010	24.3387-1702.5	240827	PINZA DE GARRA	93179159 , 5 42 106	
	1,7 CDTI	TD	04.2007	11.2010	24.3387-1702.5	240827	PINZA DE GARRA	93179159 , 5 42 106	
		TD	01.2004	11.2010	24.3387-1702.5	240827	PINZA DE GARRA	93179159 , 5 42 106	
	1,8	TD	01.2006	11.2010	24.3387-1702.5	240827	PINZA DE GARRA	93179159 , 5 42 106	
		TD	01.2004	11.2010	24.3387-1702.5	240827	PINZA DE GARRA	93179159 , 5 42 106	
	1,9 CDTI	TD	09.2005	11.2010	24.3387-1702.5	240827	PINZA DE GARRA	93179159 , 5 42 106	
		TD	09.2004	11.2010	24.3387-1702.5	240827	PINZA DE GARRA	93179159 , 5 42 106	
	2,0 Turbo	TD	09.2004	11.2010	24.3387-1702.5	240827	PINZA DE GARRA	93179159 , 5 42 106	
		TD	01.2004	11.2010	24.3387-1702.5	240827	PINZA DE GARRA	93179159 , 5 42 106	
ASTRA H Caravan/Vau. Astra MKV Estate (04-10)	1,2	TD	08.2005	11.2010	24.3387-1702.5	240827	PINZA DE GARRA	93179159 , 5 42 106	
	1,3 CDTI	TD	08.2005	11.2010	24.3387-1702.5	240827	PINZA DE GARRA	93179159 , 5 42 106	
	1,4	TD	08.2004	11.2010	24.3387-1702.5	240827	PINZA DE GARRA	93179159 , 5 42 106	
	1,6	TD	01.2007	11.2010	24.3387-1702.5	240827	PINZA DE GARRA	93179159 , 5 42 106	



Denominación

Ref. OE correspondientes a las referencias ATE

Referencia anterior / varios

OPEL

Modelo	Motor	TD	08.2004	11.2010	24.3387-1702.5	240827	Denominación	Ref. OE correspondientes a las referencias ATE	Referencia anterior / varios
ASTRA H Caravan/Vau. Astra MKV Estate (04-10)	1,6						PINZA DE GARRA	93179159 , 5 42 106	
	1,6 LPG						PINZA DE GARRA	93179159 , 5 42 106	
	1,6 Turbo						PINZA DE GARRA	93179159 , 5 42 106	
	1,7 CDTI						PINZA DE GARRA	93179159 , 5 42 106	
							PINZA DE GARRA	93179159 , 5 42 106	
	1,7 TD						PINZA DE GARRA	93179159 , 5 42 106	
	1,8						PINZA DE GARRA	93179159 , 5 42 106	
							PINZA DE GARRA	93179159 , 5 42 106	
	1,9 CDTI						PINZA DE GARRA	93179159 , 5 42 106	
							PINZA DE GARRA	93179159 , 5 42 106	
							PINZA DE GARRA	93179159 , 5 42 106	
	2,0 Turbo						PINZA DE GARRA	93179159 , 5 42 106	
							PINZA DE GARRA	93179159 , 5 42 106	
ASTRA H TwinTop (06-10)	1,6						PINZA DE GARRA	93179159 , 5 42 106	
							PINZA DE GARRA	93179159 , 5 42 106	
	1,6 Turbo						PINZA DE GARRA	93179159 , 5 42 106	
	1,8						PINZA DE GARRA	93179159 , 5 42 106	
	1,9 CDTI						PINZA DE GARRA	93179159 , 5 42 106	
	2,0 Turbo						PINZA DE GARRA	93179159 , 5 42 106	
COMBO / Vauxhall Combo (01-11)	1,3 CDTI						PINZA DE GARRA	93179159 , 5 42 106	
	1,4 16V						PINZA DE GARRA	93179159 , 5 42 106	



					Denominación	Ref. OE correspondientes a las referencias ATE	 Referencia anterior / varios
--	--	--	--	--	---------------------	---	---

OPEL

COMBO / Vauxhall Combo (01-11)	1,6	TD	10.2001	10.2011	24.3387-1702.5	240827	PINZA DE GARRA	93179159 , 5 42 106	
	1,6 CNG	TD	04.2005	10.2011	24.3387-1702.5	240827	PINZA DE GARRA	93179159 , 5 42 106	
	1,7 CDTI 16V	TD	06.2004	10.2011	24.3387-1702.5	240827	PINZA DE GARRA	93179159 , 5 42 106	
	1,7 DI 16V	TD	10.2001	10.2011	24.3387-1702.5	240827	PINZA DE GARRA	93179159 , 5 42 106	
	1,7 DTI 16V	TD	10.2001	10.2011	24.3387-1702.5	240827	PINZA DE GARRA	93179159 , 5 42 106	
COMBO D / Vauxhall Combo D (11-)	1,3 CDTi		03.2016		28.0462-2145.1	BAR221	DISCO DE FRENO	5 69 086 , 95511282 , 71711447 , 71711434 , 60815938 , 60813443 , 60801722 , 52015291 , 51996238 , 51990127 , 71739567 , 71739568 , 60699518 , 60578093 , 60658565 , 82427592 , 82450539 , 60622077 , 60571548 , 60569163	
			11.2011		28.0462-2145.1	BAR221	DISCO DE FRENO	5 69 086 , 95511282 , 71711447 , 71711434 , 60815938 , 60813443 , 60801722 , 52015291 , 51996238 , 51990127 , 71739567 , 71739568 , 60699518 , 60578093 , 60658565 , 82427592 , 82450539 , 60622077 , 60571548 , 60569163	
			03.2015		28.0462-2145.1	BAR221	DISCO DE FRENO	5 69 086 , 95511282 , 71711447 , 71711434 , 60815938 , 60813443 , 60801722 , 52015291 , 51996238 , 51990127 , 71739567 , 71739568 , 60699518 , 60578093 , 60658565 , 82427592 , 82450539 , 60622077 , 60571548 , 60569163	



Denominación

Ref. OE correspondientes a las referencias ATE



Referencia anterior / varios

OPEL

Modelo	Motor	Fecha	Referencia	ATE	Denominación	Ref. OE correspondientes a las referencias ATE	Referencia anterior / varios
COMBO D / Vauxhall Combo D (11-)	1,4	11.2011	28.0462-2145.1	BAR221	DISCO DE FRENO	5 69 086 , 95511282 , 71711447 , 71711434 , 60815938 , 60813443 , 60801722 , 52015291 , 51996238 , 51990127 , 71739567 , 71739568 , 60699518 , 60578093 , 60658565 , 82427592 , 82450539 , 60622077 , 60571548 , 60569163	
	1,4 CNG	11.2011	28.0462-2145.1	BAR221	DISCO DE FRENO	5 69 086 , 95511282 , 71711447 , 71711434 , 60815938 , 60813443 , 60801722 , 52015291 , 51996238 , 51990127 , 71739567 , 71739568 , 60699518 , 60578093 , 60658565 , 82427592 , 82450539 , 60622077 , 60571548 , 60569163	
	1,6 CDTi	03.2015	28.0462-2145.1	BAR221	DISCO DE FRENO	5 69 086 , 95511282 , 71711447 , 71711434 , 60815938 , 60813443 , 60801722 , 52015291 , 51996238 , 51990127 , 71739567 , 71739568 , 60699518 , 60578093 , 60658565 , 82427592 , 82450539 , 60622077 , 60571548 , 60569163	
		11.2011	28.0462-2145.1	BAR221	DISCO DE FRENO	5 69 086 , 95511282 , 71711447 , 71711434 , 60815938 , 60813443 , 60801722 , 52015291 , 51996238 , 51990127 , 71739567 , 71739568 , 60699518 , 60578093 , 60658565 , 82427592 , 82450539 , 60622077 , 60571548 , 60569163	



Denominación

Ref. OE correspondientes a las referencias ATE

Referencia anterior / varios

OPEL

Modelo	Motor	Denominación	Ref. OE correspondientes a las referencias ATE	Referencia anterior / varios
COMBO D / Vauxhall Combo D (11-)	2,0 CDTi	DISCO DE FRENO	5 69 086 , 95511282 , 71711447 , 71711434 , 60815938 , 60813443 , 60801722 , 52015291 , 51996238 , 51990127 , 71739567 , 71739568 , 60699518 , 60578093 , 60658565 , 82427592 , 82450539 , 60622077 , 60571548 , 60569163	
MERIVA A / Vauxhall Meriva Mk I (03-10)	1,3 CDTi	PINZA DE GARRA	93179159 , 5 42 106	
		PINZA DE GARRA	93179159 , 5 42 106	
	1,4 16V	PINZA DE GARRA	93179159 , 5 42 106	
	1,4 LPG	PINZA DE GARRA	93179159 , 5 42 106	
	1,6	PINZA DE GARRA	93179159 , 5 42 106	
	1,6 16V	PINZA DE GARRA	93179159 , 5 42 106	
	1,7 CDTi	PINZA DE GARRA	93179159 , 5 42 106	
		PINZA DE GARRA	93179159 , 5 42 106	
	1,7 DTI	PINZA DE GARRA	93179159 , 5 42 106	
	1,7 DTI 16V	PINZA DE GARRA	93179159 , 5 42 106	
	1,8 16V	PINZA DE GARRA	93179159 , 5 42 106	



Denominación

Ref. OE correspondientes a las referencias ATE

Referencia anterior / varios

PEUGEOT

107 (05-14)	1		06.2005	05.2014	28.0462-0180.1	BAR201	DISCO DE FRENO	43512-0H020 , 43512-0H010 , 4249 94 , 4249 54 , 4246 F0 , 4249 55 , 4246 J0	
	1,4 HDi		06.2005	05.2014	28.0462-0180.1	BAR201	DISCO DE FRENO	43512-0H020 , 43512-0H010 , 4249 94 , 4249 54 , 4246 F0 , 4249 55 , 4246 J0	
108 (14-)	1,0 68 VTi		05.2014		28.0462-0180.1	BAR201	DISCO DE FRENO	43512-0H020 , 43512-0H010 , 4249 94 , 4249 54 , 4246 F0 , 4249 55 , 4246 J0	
	1,2 82 VTi		05.2014		28.0462-0180.1	BAR201	DISCO DE FRENO	43512-0H020 , 43512-0H010 , 4249 94 , 4249 54 , 4246 F0 , 4249 55 , 4246 J0	
508 SW (10-)	2,0 HDi 180		04.2014		24.0112-0216.1	412216	DISCO DE FRENO	96 839 932 80	

RENAULT

MASTER II Bus (JD_) (06-10)	2,5 dCi		08.2006	12.2010	24.5134-0469.3	331479	LATIGUILLO	82 00 673 552	
MASTER II Kasten (FD_) (06-10)			08.2006	12.2010	24.5134-0469.3	331479	LATIGUILLO	82 00 673 552	
MASTER II Pritsche/Fahrgestell (ED/HD/UD_) (06-10)			08.2006	12.2010	24.5134-0469.3	331479	LATIGUILLO	82 00 673 552	



Denominación

Ref. OE correspondientes a las referencias ATE

Referencia anterior / varios

SEAT

Modelo	Motor	TI	Fecha	Ref. ATE	Ref. OE	Denominación	Ref. OE correspondientes a las referencias ATE	Referencia anterior / varios
ALTEA (5P1) (04-15)	1,2 TSI	TI	04.2010	24.3414-1709.5	240834	PINZA DE GARRA	1K0 615 423 M , 1K0 615 423 H , 1K0 615 423 C , 1K0 615 423	24.3414-1709.7
		TD	04.2010	24.3414-1710.5	240835	PINZA DE GARRA	1K0 615 424 M , 1K0 615 424 H , 1K0 615 424 C , 1K0 615 424	24.3414-1710.7-
	1,4 i 16V	TD	05.2006	24.3414-1710.5	240835	PINZA DE GARRA	1K0 615 424 M , 1K0 615 424 H , 1K0 615 424 C , 1K0 615 424	24.3414-1710.7-
		TI	05.2006	24.3414-1709.5	240834	PINZA DE GARRA	1K0 615 423 M , 1K0 615 423 H , 1K0 615 423 C , 1K0 615 423	24.3414-1709.7
	1,4 TSI	TI	11.2007	24.3414-1709.5	240834	PINZA DE GARRA	1K0 615 423 M , 1K0 615 423 H , 1K0 615 423 C , 1K0 615 423	24.3414-1709.7
		TD	11.2007	24.3414-1710.5	240835	PINZA DE GARRA	1K0 615 424 M , 1K0 615 424 H , 1K0 615 424 C , 1K0 615 424	24.3414-1710.7-
	1,6 i 16V	TI	03.2004	24.3414-1709.5	240834	PINZA DE GARRA	1K0 615 423 M , 1K0 615 423 H , 1K0 615 423 C , 1K0 615 423	24.3414-1709.7
		TD	03.2004	24.3414-1710.5	240835	PINZA DE GARRA	1K0 615 424 M , 1K0 615 424 H , 1K0 615 424 C , 1K0 615 424	24.3414-1710.7-
	1,6 LPG	TI	09.2009	24.3414-1709.5	240834	PINZA DE GARRA	1K0 615 423 M , 1K0 615 423 H , 1K0 615 423 C , 1K0 615 423	24.3414-1709.7
		TD	09.2009	24.3414-1710.5	240835	PINZA DE GARRA	1K0 615 424 M , 1K0 615 424 H , 1K0 615 424 C , 1K0 615 424	24.3414-1710.7-
	1,6 TDI	TD	10.2009	24.3414-1710.5	240835	PINZA DE GARRA	1K0 615 424 M , 1K0 615 424 H , 1K0 615 424 C , 1K0 615 424	24.3414-1710.7-



Denominación

Ref. OE correspondientes a las referencias ATE

Referencia anterior / varios

SEAT

ALTEA (5P1) (04-15)	1,6 TDI	TI	10.2009		24.3414-1709.5	240834	PINZA DE GARRA	1K0 615 423 M , 1K0 615 423 H , 1K0 615 423 C , 1K0 615 423	24.3414-1709.7
	1,8 TFSI	TD	01.2007		24.3414-1710.5	240835	PINZA DE GARRA	1K0 615 424 M , 1K0 615 424 H , 1K0 615 424 C , 1K0 615 424	24.3414-1710.7-
		TI	01.2007		24.3414-1709.5	240834	PINZA DE GARRA	1K0 615 423 M , 1K0 615 423 H , 1K0 615 423 C , 1K0 615 423	24.3414-1709.7
	1,9 TDI	TD	03.2004		24.3414-1710.5	240835	PINZA DE GARRA	1K0 615 424 M , 1K0 615 424 H , 1K0 615 424 C , 1K0 615 424	24.3414-1710.7-
		TI	03.2004		24.3414-1709.5	240834	PINZA DE GARRA	1K0 615 423 M , 1K0 615 423 H , 1K0 615 423 C , 1K0 615 423	24.3414-1709.7
	2,0 FSI	TD	03.2004		24.3414-1710.5	240835	PINZA DE GARRA	1K0 615 424 M , 1K0 615 424 H , 1K0 615 424 C , 1K0 615 424	24.3414-1710.7-
		TI	03.2004		24.3414-1709.5	240834	PINZA DE GARRA	1K0 615 423 M , 1K0 615 423 H , 1K0 615 423 C , 1K0 615 423	24.3414-1709.7
	2,0 TDI	TD	03.2004		24.3414-1710.5	240835	PINZA DE GARRA	1K0 615 424 M , 1K0 615 424 H , 1K0 615 424 C , 1K0 615 424	24.3414-1710.7-
		TD	03.2006		24.3414-1710.5	240835	PINZA DE GARRA	1K0 615 424 M , 1K0 615 424 H , 1K0 615 424 C , 1K0 615 424	24.3414-1710.7-
		TI	03.2006		24.3414-1709.5	240834	PINZA DE GARRA	1K0 615 423 M , 1K0 615 423 H , 1K0 615 423 C , 1K0 615 423	24.3414-1709.7
		TI	03.2004		24.3414-1709.5	240834	PINZA DE GARRA	1K0 615 423 M , 1K0 615 423 H , 1K0 615 423 C , 1K0 615 423	24.3414-1709.7



Denominación

Ref. OE correspondientes a las referencias ATE

Referencia anterior / varios

SEAT

Modelo	Motor	Transmisión	Fecha inicio	Fecha fin	Código 1	Código 2	Denominación	Ref. OE correspondientes a las referencias ATE	Referencia anterior / varios
ALTEA (5P1) (04-15)	2,0 TFSI	TD	03.2006		24.3414-1710.5	240835	PINZA DE GARRA	1K0 615 424 M , 1K0 615 424 H , 1K0 615 424 C , 1K0 615 424	24.3414-1710.7-
		TI	03.2006		24.3414-1709.5	240834	PINZA DE GARRA	1K0 615 423 M , 1K0 615 423 H , 1K0 615 423 C , 1K0 615 423	24.3414-1709.7
CORDOBA III (6L2) (02-09)	1,2 i	TD	10.2002	06.2009	24.3344-1710.5	240811	PINZA DE GARRA	6Q0 615 424 B , 6Q0 615 424 A	
	1,4 i 16V	TD	10.2002	06.2009	24.3344-1710.5	240811	PINZA DE GARRA	6Q0 615 424 B , 6Q0 615 424 A	
	1,4 TDI	TD	10.2002	06.2009	24.3344-1710.5	240811	PINZA DE GARRA	6Q0 615 424 B , 6Q0 615 424 A	
	1,6 i 16V	TD	02.2003	06.2009	24.3344-1710.5	240811	PINZA DE GARRA	6Q0 615 424 B , 6Q0 615 424 A	
	1,9 SDI	TD	10.2002	06.2009	24.3344-1710.5	240811	PINZA DE GARRA	6Q0 615 424 B , 6Q0 615 424 A	
	1,9 TDI	TD	10.2002	06.2009	24.3344-1710.5	240811	PINZA DE GARRA	6Q0 615 424 B , 6Q0 615 424 A	
	2,0 i 16V	TD	10.2002	06.2009	24.3344-1710.5	240811	PINZA DE GARRA	6Q0 615 424 B , 6Q0 615 424 A	
IBIZA IV (6L1) (02-10)	1,2	TD	06.2007	05.2008	24.3344-1710.5	240811	PINZA DE GARRA	6Q0 615 424 B , 6Q0 615 424 A	
	1,2 i	TD	02.2002	02.2010	24.3344-1710.5	240811	PINZA DE GARRA	6Q0 615 424 B , 6Q0 615 424 A	
	1,2 i 12V	TD	05.2006	02.2010	24.3344-1710.5	240811	PINZA DE GARRA	6Q0 615 424 B , 6Q0 615 424 A	
	1,4 i 16V	TD	02.2002	02.2010	24.3344-1710.5	240811	PINZA DE GARRA	6Q0 615 424 B , 6Q0 615 424 A	
		TD	05.2006	02.2010	24.3344-1710.5	240811	PINZA DE GARRA	6Q0 615 424 B , 6Q0 615 424 A	



Denominación

Ref. OE correspondientes a las referencias ATE

Referencia anterior / varios

SEAT

Modelo	Motor	Transmisión	Fecha inicio	Fecha fin	Código ATE	Código OE	Denominación	Ref. OE correspondientes a las referencias ATE	Referencia anterior / varios
IBIZA IV (6L1) (02-10)	1,4 TDI	TD	05.2005	02.2010	24.3344-1710.5	240811	PINZA DE GARRA	6Q0 615 424 B , 6Q0 615 424 A	
		TD	02.2002	02.2010	24.3344-1710.5	240811	PINZA DE GARRA	6Q0 615 424 B , 6Q0 615 424 A	
	1,6 i 16V	TD	02.2003	02.2010	24.3344-1710.5	240811	PINZA DE GARRA	6Q0 615 424 B , 6Q0 615 424 A	
	1,8 T Cupra R	TD	01.2004	02.2010	24.3344-1710.5	240811	PINZA DE GARRA	6Q0 615 424 B , 6Q0 615 424 A	
	1,8 T FR	TD	12.2003	02.2010	24.3344-1710.5	240811	PINZA DE GARRA	6Q0 615 424 B , 6Q0 615 424 A	
	1,9 SDI	TD	02.2002	02.2010	24.3344-1710.5	240811	PINZA DE GARRA	6Q0 615 424 B , 6Q0 615 424 A	
	1,9 TDI	TD	02.2002	02.2010	24.3344-1710.5	240811	PINZA DE GARRA	6Q0 615 424 B , 6Q0 615 424 A	
	1,9 TDI Cupra R	TD	03.2004	02.2008	24.3344-1710.5	240811	PINZA DE GARRA	6Q0 615 424 B , 6Q0 615 424 A	
	2	TD	04.2002	02.2010	24.3344-1710.5	240811	PINZA DE GARRA	6Q0 615 424 B , 6Q0 615 424 A	
IBIZA V (6J/6P) / ST / SC (08-17)	1,4 TSI	TD	06.2009		24.3344-1710.5	240811	PINZA DE GARRA	6Q0 615 424 B , 6Q0 615 424 A	
	1,4 TSI FR	TD	12.2013		24.3344-1710.5	240811	PINZA DE GARRA	6Q0 615 424 B , 6Q0 615 424 A	
LEON II (1P1) (05-12)	1,2 TSI	TD	02.2010	10.2012	24.3414-1710.5	240835	PINZA DE GARRA	1K0 615 424 M , 1K0 615 424 H , 1K0 615 424 C , 1K0 615 424	24.3414-1710.7-
		TI	02.2010	10.2012	24.3414-1709.5	240834	PINZA DE GARRA	1K0 615 423 M , 1K0 615 423 H , 1K0 615 423 C , 1K0 615 423	24.3414-1709.7



Denominación

Ref. OE correspondientes a las referencias ATE

Referencia anterior / varios

SEAT

Modelo	Motor	Transmisión	Fecha inicio	Fecha fin	Referencia ATE	Referencia OE	Denominación	Ref. OE correspondientes a las referencias ATE	Referencia anterior / varios
LEON II (1P1) (05-12)	1,4 i 16V	TD	06.2006	10.2012	24.3414-1710.5	240835	PINZA DE GARRA	1K0 615 424 M , 1K0 615 424 H , 1K0 615 424 C , 1K0 615 424	24.3414-1710.7-
		TI	06.2006	10.2012	24.3414-1709.5	240834	PINZA DE GARRA	1K0 615 423 M , 1K0 615 423 H , 1K0 615 423 C , 1K0 615 423	24.3414-1709.7
	1,4 TSI	TI	11.2007	10.2012	24.3414-1709.5	240834	PINZA DE GARRA	1K0 615 423 M , 1K0 615 423 H , 1K0 615 423 C , 1K0 615 423	24.3414-1709.7
		TD	11.2007	10.2012	24.3414-1710.5	240835	PINZA DE GARRA	1K0 615 424 M , 1K0 615 424 H , 1K0 615 424 C , 1K0 615 424	24.3414-1710.7-
	1,6 i	TI	08.2005	10.2012	24.3414-1709.5	240834	PINZA DE GARRA	1K0 615 423 M , 1K0 615 423 H , 1K0 615 423 C , 1K0 615 423	24.3414-1709.7
		TD	08.2005	10.2012	24.3414-1710.5	240835	PINZA DE GARRA	1K0 615 424 M , 1K0 615 424 H , 1K0 615 424 C , 1K0 615 424	24.3414-1710.7-
	1,6 LPG / Multifuel	TD	12.2009	10.2012	24.3414-1710.5	240835	PINZA DE GARRA	1K0 615 424 M , 1K0 615 424 H , 1K0 615 424 C , 1K0 615 424	24.3414-1710.7-
		TI	12.2009	10.2012	24.3414-1709.5	240834	PINZA DE GARRA	1K0 615 423 M , 1K0 615 423 H , 1K0 615 423 C , 1K0 615 423	24.3414-1709.7
	1,6 TDI	TD	11.2010	10.2012	24.3414-1710.5	240835	PINZA DE GARRA	1K0 615 424 M , 1K0 615 424 H , 1K0 615 424 C , 1K0 615 424	24.3414-1710.7-
		TI	11.2010	10.2012	24.3414-1709.5	240834	PINZA DE GARRA	1K0 615 423 M , 1K0 615 423 H , 1K0 615 423 C , 1K0 615 423	24.3414-1709.7
	1,6 TDI Ecomotive	TD	02.2010	10.2012	24.3414-1710.5	240835	PINZA DE GARRA	1K0 615 424 M , 1K0 615 424 H , 1K0 615 424 C , 1K0 615 424	24.3414-1710.7-



Denominación

Ref. OE correspondientes a las referencias ATE

Referencia anterior / varios

SEAT

Modelo	Motor	TI	02.2010	10.2012	24.3414-1709.5	240834	Denominación	Ref. OE correspondientes a las referencias ATE	Referencia anterior / varios
LEON II (1P1) (05-12)	1,6 TDI Ecomotive	TI	02.2010	10.2012	24.3414-1709.5	240834	PINZA DE GARRA	1K0 615 423 M , 1K0 615 423 H , 1K0 615 423 C , 1K0 615 423	24.3414-1709.7
	1,8 TSI	TD	06.2007	10.2012	24.3414-1710.5	240835	PINZA DE GARRA	1K0 615 424 M , 1K0 615 424 H , 1K0 615 424 C , 1K0 615 424	24.3414-1710.7-
		TI	06.2007	10.2012	24.3414-1709.5	240834	PINZA DE GARRA	1K0 615 423 M , 1K0 615 423 H , 1K0 615 423 C , 1K0 615 423	24.3414-1709.7
	1,9 TDI	TD	08.2005	10.2012	24.3414-1710.5	240835	PINZA DE GARRA	1K0 615 424 M , 1K0 615 424 H , 1K0 615 424 C , 1K0 615 424	24.3414-1710.7-
		TI	08.2005	10.2012	24.3414-1709.5	240834	PINZA DE GARRA	1K0 615 423 M , 1K0 615 423 H , 1K0 615 423 C , 1K0 615 423	24.3414-1709.7
	2,0 Cupra R	TI	11.2006	10.2012	24.3414-1709.5	240834	PINZA DE GARRA	1K0 615 423 M , 1K0 615 423 H , 1K0 615 423 C , 1K0 615 423	24.3414-1709.7
		TD	11.2006	10.2012	24.3414-1710.5	240835	PINZA DE GARRA	1K0 615 424 M , 1K0 615 424 H , 1K0 615 424 C , 1K0 615 424	24.3414-1710.7-
	2,0 FSI	TD	08.2005	10.2012	24.3414-1710.5	240835	PINZA DE GARRA	1K0 615 424 M , 1K0 615 424 H , 1K0 615 424 C , 1K0 615 424	24.3414-1710.7-
		TI	08.2005	10.2012	24.3414-1709.5	240834	PINZA DE GARRA	1K0 615 423 M , 1K0 615 423 H , 1K0 615 423 C , 1K0 615 423	24.3414-1709.7
	2,0 TDI	TD	02.2006	10.2012	24.3414-1710.5	240835	PINZA DE GARRA	1K0 615 424 M , 1K0 615 424 H , 1K0 615 424 C , 1K0 615 424	24.3414-1710.7-
		TD	08.2005	10.2012	24.3414-1710.5	240835	PINZA DE GARRA	1K0 615 424 M , 1K0 615 424 H , 1K0 615 424 C , 1K0 615 424	24.3414-1710.7-



Denominación

Ref. OE correspondientes a las referencias ATE



Referencia anterior / varios

SEAT

Modelo	Motor	Transmisión	Fecha inicio	Fecha fin	Referencia anterior	Referencia actual	Denominación	Ref. OE correspondientes a las referencias ATE	Referencia anterior / varios
LEON II (1P1) (05-12)	2,0 TDI	TI	02.2006	10.2012	24.3414-1709.5	240834	PINZA DE GARRA	1K0 615 423 M , 1K0 615 423 H , 1K0 615 423 C , 1K0 615 423	24.3414-1709.7
		TI	08.2005	10.2012	24.3414-1709.5	240834	PINZA DE GARRA	1K0 615 423 M , 1K0 615 423 H , 1K0 615 423 C , 1K0 615 423	24.3414-1709.7
	2,0 TFSI	TD	09.2005	10.2012	24.3414-1710.5	240835	PINZA DE GARRA	1K0 615 424 M , 1K0 615 424 H , 1K0 615 424 C , 1K0 615 424	24.3414-1710.7-
		TD	08.2005	10.2012	24.3414-1710.5	240835	PINZA DE GARRA	1K0 615 424 M , 1K0 615 424 H , 1K0 615 424 C , 1K0 615 424	24.3414-1710.7-
		TD	11.2006	10.2012	24.3414-1710.5	240835	PINZA DE GARRA	1K0 615 424 M , 1K0 615 424 H , 1K0 615 424 C , 1K0 615 424	24.3414-1710.7-
		TI	08.2005	10.2012	24.3414-1709.5	240834	PINZA DE GARRA	1K0 615 423 M , 1K0 615 423 H , 1K0 615 423 C , 1K0 615 423	24.3414-1709.7
		TI	09.2005	10.2012	24.3414-1709.5	240834	PINZA DE GARRA	1K0 615 423 M , 1K0 615 423 H , 1K0 615 423 C , 1K0 615 423	24.3414-1709.7
		TI	11.2006	10.2012	24.3414-1709.5	240834	PINZA DE GARRA	1K0 615 423 M , 1K0 615 423 H , 1K0 615 423 C , 1K0 615 423	24.3414-1709.7
LEON III (5F) / SC / ST (12-)	1,0 TSI	TD	05.2015		24.3384-1760.5	240801	PINZA DE GARRA	5Q0 615 424 A	
		TI	05.2015		24.3384-1759.5	240800	PINZA DE GARRA	5Q0 615 423 A	
	1,2 TSI	TI	04.2014		24.3384-1759.5	240800	PINZA DE GARRA	5Q0 615 423 A	
		TD	04.2014		24.3384-1760.5	240801	PINZA DE GARRA	5Q0 615 424 A	
		TD	09.2012		24.3384-1760.5	240801	PINZA DE GARRA	5Q0 615 424 A	
		TI	09.2012		24.3384-1759.5	240800	PINZA DE GARRA	5Q0 615 423 A	



Denominación

Ref. OE correspondientes a las referencias ATE

Referencia anterior / varios

SEAT

Modelo	Motor	Transmisión	Fecha	Ref. ATE	Ref. OE	Denominación	Ref. OE correspondientes a las referencias ATE	Referencia anterior / varios
LEON III (5F) / SC / ST (12-)	1,4 TGI	TI	10.2013	24.3384-1759.5	240800	PINZA DE GARRA	5Q0 615 423 A	
		TD	10.2013	24.3384-1760.5	240801	PINZA DE GARRA	5Q0 615 424 A	
	1,4 TSI	TD	09.2012	24.3384-1760.5	240801	PINZA DE GARRA	5Q0 615 424 A	
		TI	05.2014	24.3384-1759.5	240800	PINZA DE GARRA	5Q0 615 423 A	
		TD	05.2014	24.3384-1760.5	240801	PINZA DE GARRA	5Q0 615 424 A	
		TI	09.2012	24.3384-1759.5	240800	PINZA DE GARRA	5Q0 615 423 A	
		TI	09.2013	24.3384-1759.5	240800	PINZA DE GARRA	5Q0 615 423 A	
	1,6 TDI	TI	01.2017	24.3384-1759.5	240800	PINZA DE GARRA	5Q0 615 423 A	
		TI	09.2012	24.3384-1759.5	240800	PINZA DE GARRA	5Q0 615 423 A	
		TD	09.2012	24.3384-1760.5	240801	PINZA DE GARRA	5Q0 615 424 A	
		TD	01.2017	24.3384-1760.5	240801	PINZA DE GARRA	5Q0 615 424 A	
		TD	09.2013	24.3384-1760.5	240801	PINZA DE GARRA	5Q0 615 424 A	
	1,6 TDI 4Drive	TD	11.2014	24.3384-1760.5	240801	PINZA DE GARRA	5Q0 615 424 A	
		TD	04.2014	24.3384-1760.5	240801	PINZA DE GARRA	5Q0 615 424 A	
		TI	04.2014	24.3384-1759.5	240800	PINZA DE GARRA	5Q0 615 423 A	
		TI	11.2014	24.3384-1759.5	240800	PINZA DE GARRA	5Q0 615 423 A	
	1,8 TSI	TD	09.2012	24.3384-1760.5	240801	PINZA DE GARRA	5Q0 615 424 A	
		TI	09.2012	24.3384-1759.5	240800	PINZA DE GARRA	5Q0 615 423 A	
	1,8 TSI 4Drive	TI	11.2014	24.3384-1759.5	240800	PINZA DE GARRA	5Q0 615 423 A	
		TD	11.2014	24.3384-1760.5	240801	PINZA DE GARRA	5Q0 615 424 A	
	2,0 Cupra	TD	10.2013	24.3384-1760.5	240801	PINZA DE GARRA	5Q0 615 424 A	



Denominación

Ref. OE correspondientes a las referencias ATE

Referencia anterior / varios

SEAT

LEON III (5F) / SC / ST (12-)	2,0 Cupra	TI	10.2013		24.3384-1759.5	240800	PINZA DE GARRA	5Q0 615 423 A	
	2,0 TDI	TI	09.2012		24.3384-1759.5	240800	PINZA DE GARRA	5Q0 615 423 A	
		TD	09.2012		24.3384-1760.5	240801	PINZA DE GARRA	5Q0 615 424 A	
		TD	05.2013		24.3384-1760.5	240801	PINZA DE GARRA	5Q0 615 424 A	
		TI	05.2013		24.3384-1759.5	240800	PINZA DE GARRA	5Q0 615 423 A	
	2,0 TDI 4Drive	TI	04.2014		24.3384-1759.5	240800	PINZA DE GARRA	5Q0 615 423 A	
		TI	11.2014		24.3384-1759.5	240800	PINZA DE GARRA	5Q0 615 423 A	
		TD	11.2014		24.3384-1760.5	240801	PINZA DE GARRA	5Q0 615 424 A	
		TD	04.2014		24.3384-1760.5	240801	PINZA DE GARRA	5Q0 615 424 A	
LEON III (5F) ST X-Perience (14-)	1,6 TDI	TI	09.2014		24.3384-1759.5	240800	PINZA DE GARRA	5Q0 615 423 A	
		TD	09.2014		24.3384-1760.5	240801	PINZA DE GARRA	5Q0 615 424 A	
	1,8 TSI	TI	09.2014		24.3384-1759.5	240800	PINZA DE GARRA	5Q0 615 423 A	
		TD	09.2014		24.3384-1760.5	240801	PINZA DE GARRA	5Q0 615 424 A	
	2,0 TDI	TD	09.2014		24.3384-1760.5	240801	PINZA DE GARRA	5Q0 615 424 A	
		TI	09.2014		24.3384-1759.5	240800	PINZA DE GARRA	5Q0 615 423 A	
TOLEDO III (5P2) (05-09)	1,4 16V	TD	05.2006	03.2009	24.3414-1710.5	240835	PINZA DE GARRA	1K0 615 424 M , 1K0 615 424 H , 1K0 615 424 C , 1K0 615 424	24.3414-1710.7-
		TI	05.2006	03.2009	24.3414-1709.5	240834	PINZA DE GARRA	1K0 615 423 M , 1K0 615 423 H , 1K0 615 423 C , 1K0 615 423	24.3414-1709.7
	1,4 TSI	TI	11.2007	03.2009	24.3414-1709.5	240834	PINZA DE GARRA	1K0 615 423 M , 1K0 615 423 H , 1K0 615 423 C , 1K0 615 423	24.3414-1709.7



Denominación

Ref. OE correspondientes a las referencias ATE

Referencia anterior / varios

SEAT

Modelo	Motor	Transmisión	Fecha 1	Fecha 2	Ref. 1	Ref. 2	Denominación	Ref. OE correspondientes a las referencias ATE	Referencia anterior / varios
TOLEDO III (5P2) (05-09)	1,4 TSI	TD	11.2007	03.2009	24.3414-1710.5	240835	PINZA DE GARRA	1K0 615 424 M , 1K0 615 424 H , 1K0 615 424 C , 1K0 615 424	24.3414-1710.7-
	1,6 i 16V	TD	10.2004	03.2009	24.3414-1710.5	240835	PINZA DE GARRA	1K0 615 424 M , 1K0 615 424 H , 1K0 615 424 C , 1K0 615 424	24.3414-1710.7-
		TI	10.2004	03.2009	24.3414-1709.5	240834	PINZA DE GARRA	1K0 615 423 M , 1K0 615 423 H , 1K0 615 423 C , 1K0 615 423	24.3414-1709.7
	1,8 TFSI	TD	01.2007	03.2009	24.3414-1710.5	240835	PINZA DE GARRA	1K0 615 424 M , 1K0 615 424 H , 1K0 615 424 C , 1K0 615 424	24.3414-1710.7-
		TI	01.2007	03.2009	24.3414-1709.5	240834	PINZA DE GARRA	1K0 615 423 M , 1K0 615 423 H , 1K0 615 423 C , 1K0 615 423	24.3414-1709.7
	1,9 TDI	TD	10.2004	03.2009	24.3414-1710.5	240835	PINZA DE GARRA	1K0 615 424 M , 1K0 615 424 H , 1K0 615 424 C , 1K0 615 424	24.3414-1710.7-
		TI	10.2004	03.2009	24.3414-1709.5	240834	PINZA DE GARRA	1K0 615 423 M , 1K0 615 423 H , 1K0 615 423 C , 1K0 615 423	24.3414-1709.7
	2,0 FSI	TI	10.2004	03.2009	24.3414-1709.5	240834	PINZA DE GARRA	1K0 615 423 M , 1K0 615 423 H , 1K0 615 423 C , 1K0 615 423	24.3414-1709.7
		TD	10.2004	03.2009	24.3414-1710.5	240835	PINZA DE GARRA	1K0 615 424 M , 1K0 615 424 H , 1K0 615 424 C , 1K0 615 424	24.3414-1710.7-
	2,0 TDI	TI	01.2006	03.2009	24.3414-1709.5	240834	PINZA DE GARRA	1K0 615 423 M , 1K0 615 423 H , 1K0 615 423 C , 1K0 615 423	24.3414-1709.7
		TI	10.2004	03.2009	24.3414-1709.5	240834	PINZA DE GARRA	1K0 615 423 M , 1K0 615 423 H , 1K0 615 423 C , 1K0 615 423	24.3414-1709.7



Denominación

Ref. OE correspondientes a las referencias ATE



Referencia anterior / varios

SEAT

Modelo	Motor	Transmisión	Desde	Hasta	Referencia ATE	Referencia OE	Denominación	Ref. OE correspondientes a las referencias ATE	Referencia anterior / varios
TOLEDO III (5P2) (05-09)	2,0 TDI	TD	01.2006	03.2009	24.3414-1710.5	240835	PINZA DE GARRA	1K0 615 424 M , 1K0 615 424 H , 1K0 615 424 C , 1K0 615 424	24.3414-1710.7-
		TD	10.2004	03.2009	24.3414-1710.5	240835	PINZA DE GARRA	1K0 615 424 M , 1K0 615 424 H , 1K0 615 424 C , 1K0 615 424	24.3414-1710.7-
	2,0 TFSI	TD	11.2005	03.2009	24.3414-1710.5	240835	PINZA DE GARRA	1K0 615 424 M , 1K0 615 424 H , 1K0 615 424 C , 1K0 615 424	24.3414-1710.7-
		TI	11.2005	03.2009	24.3414-1709.5	240834	PINZA DE GARRA	1K0 615 423 M , 1K0 615 423 H , 1K0 615 423 C , 1K0 615 423	24.3414-1709.7



Denominación

Ref. OE correspondientes a las referencias ATE

Referencia anterior / varios

SKODA

OCTAVIA II (1Z) (04-13)	1,2 TSI	TI	02.2010	01.2013	24.3414-1709.5	240834	PINZA DE GARRA	1K0 615 423 M , 1K0 615 423 H , 1K0 615 423 C , 1K0 615 423	24.3414-1709.7
		TD	02.2010	01.2013	24.3414-1710.5	240835	PINZA DE GARRA	1K0 615 424 M , 1K0 615 424 H , 1K0 615 424 C , 1K0 615 424	24.3414-1710.7-
	1,4 i 16V	TD	06.2004	01.2013	24.3414-1710.5	240835	PINZA DE GARRA	1K0 615 424 M , 1K0 615 424 H , 1K0 615 424 C , 1K0 615 424	24.3414-1710.7-
		TI	06.2004	01.2013	24.3414-1709.5	240834	PINZA DE GARRA	1K0 615 423 M , 1K0 615 423 H , 1K0 615 423 C , 1K0 615 423	24.3414-1709.7
	1,4 TSI	TD	11.2008	01.2013	24.3414-1710.5	240835	PINZA DE GARRA	1K0 615 424 M , 1K0 615 424 H , 1K0 615 424 C , 1K0 615 424	24.3414-1710.7-
		TI	11.2008	01.2013	24.3414-1709.5	240834	PINZA DE GARRA	1K0 615 423 M , 1K0 615 423 H , 1K0 615 423 C , 1K0 615 423	24.3414-1709.7
	1,6	TI	09.2009	01.2013	24.3414-1709.5	240834	PINZA DE GARRA	1K0 615 423 M , 1K0 615 423 H , 1K0 615 423 C , 1K0 615 423	24.3414-1709.7
		TD	09.2009	01.2013	24.3414-1710.5	240835	PINZA DE GARRA	1K0 615 424 M , 1K0 615 424 H , 1K0 615 424 C , 1K0 615 424	24.3414-1710.7-
	1,6 FSI	TI	06.2004	01.2013	24.3414-1709.5	240834	PINZA DE GARRA	1K0 615 423 M , 1K0 615 423 H , 1K0 615 423 C , 1K0 615 423	24.3414-1709.7
		TD	06.2004	01.2013	24.3414-1710.5	240835	PINZA DE GARRA	1K0 615 424 M , 1K0 615 424 H , 1K0 615 424 C , 1K0 615 424	24.3414-1710.7-
	1,6 i 16V	TD	06.2004	01.2013	24.3414-1710.5	240835	PINZA DE GARRA	1K0 615 424 M , 1K0 615 424 H , 1K0 615 424 C , 1K0 615 424	24.3414-1710.7-



Denominación

Ref. OE correspondientes a las referencias ATE



Referencia anterior / varios

SKODA

OCTAVIA II (1Z) (04-13)	1,6 i 16V	TI	06.2004	01.2013	24.3414-1709.5	240834	PINZA DE GARRA	1K0 615 423 M , 1K0 615 423 H , 1K0 615 423 C , 1K0 615 423	24.3414-1709.7
	1,6 TDI	TI	06.2009	01.2013	24.3414-1709.5	240834	PINZA DE GARRA	1K0 615 423 M , 1K0 615 423 H , 1K0 615 423 C , 1K0 615 423	24.3414-1709.7
		TD	06.2009	01.2013	24.3414-1710.5	240835	PINZA DE GARRA	1K0 615 424 M , 1K0 615 424 H , 1K0 615 424 C , 1K0 615 424	24.3414-1710.7-
	1,6 TDI 4x4	TI	06.2009	01.2013	24.3414-1709.5	240834	PINZA DE GARRA	1K0 615 423 M , 1K0 615 423 H , 1K0 615 423 C , 1K0 615 423	24.3414-1709.7
		TD	06.2009	01.2013	24.3414-1710.5	240835	PINZA DE GARRA	1K0 615 424 M , 1K0 615 424 H , 1K0 615 424 C , 1K0 615 424	24.3414-1710.7-
	1,8 TSI	TI	06.2007	01.2013	24.3414-1709.5	240834	PINZA DE GARRA	1K0 615 423 M , 1K0 615 423 H , 1K0 615 423 C , 1K0 615 423	24.3414-1709.7
		TD	06.2007	01.2013	24.3414-1710.5	240835	PINZA DE GARRA	1K0 615 424 M , 1K0 615 424 H , 1K0 615 424 C , 1K0 615 424	24.3414-1710.7-
	1,8 TSI 4x4	TI	11.2008	01.2013	24.3414-1709.5	240834	PINZA DE GARRA	1K0 615 423 M , 1K0 615 423 H , 1K0 615 423 C , 1K0 615 423	24.3414-1709.7
		TD	11.2008	01.2013	24.3414-1710.5	240835	PINZA DE GARRA	1K0 615 424 M , 1K0 615 424 H , 1K0 615 424 C , 1K0 615 424	24.3414-1710.7-
	1,9 TDI	TI	06.2004	01.2013	24.3414-1709.5	240834	PINZA DE GARRA	1K0 615 423 M , 1K0 615 423 H , 1K0 615 423 C , 1K0 615 423	24.3414-1709.7
		TD	06.2004	01.2013	24.3414-1710.5	240835	PINZA DE GARRA	1K0 615 424 M , 1K0 615 424 H , 1K0 615 424 C , 1K0 615 424	24.3414-1710.7-



Denominación

Ref. OE correspondientes a las referencias ATE

Referencia anterior / varios

SKODA

OCTAVIA II (1Z) (04-13)	1,9 TDI 4x4	TD	11.2004	01.2013	24.3414-1710.5	240835	PINZA DE GARRA	1K0 615 424 M , 1K0 615 424 H , 1K0 615 424 C , 1K0 615 424	24.3414-1710.7-
		TI	11.2004	01.2013	24.3414-1709.5	240834	PINZA DE GARRA	1K0 615 423 M , 1K0 615 423 H , 1K0 615 423 C , 1K0 615 423	24.3414-1709.7
	2,0 FSI	TD	11.2004	01.2013	24.3414-1710.5	240835	PINZA DE GARRA	1K0 615 424 M , 1K0 615 424 H , 1K0 615 424 C , 1K0 615 424	24.3414-1710.7-
		TI	11.2004	01.2013	24.3414-1709.5	240834	PINZA DE GARRA	1K0 615 423 M , 1K0 615 423 H , 1K0 615 423 C , 1K0 615 423	24.3414-1709.7
	2,0 FSI 4x4	TD	11.2004	01.2013	24.3414-1710.5	240835	PINZA DE GARRA	1K0 615 424 M , 1K0 615 424 H , 1K0 615 424 C , 1K0 615 424	24.3414-1710.7-
		TI	11.2004	01.2013	24.3414-1709.5	240834	PINZA DE GARRA	1K0 615 423 M , 1K0 615 423 H , 1K0 615 423 C , 1K0 615 423	24.3414-1709.7
	2,0 TDI	TD	06.2004	01.2013	24.3414-1710.5	240835	PINZA DE GARRA	1K0 615 424 M , 1K0 615 424 H , 1K0 615 424 C , 1K0 615 424	24.3414-1710.7-
		TD	03.2010	01.2013	24.3414-1710.5	240835	PINZA DE GARRA	1K0 615 424 M , 1K0 615 424 H , 1K0 615 424 C , 1K0 615 424	24.3414-1710.7-
		TI	06.2004	01.2013	24.3414-1709.5	240834	PINZA DE GARRA	1K0 615 423 M , 1K0 615 423 H , 1K0 615 423 C , 1K0 615 423	24.3414-1709.7
		TI	03.2010	01.2013	24.3414-1709.5	240834	PINZA DE GARRA	1K0 615 423 M , 1K0 615 423 H , 1K0 615 423 C , 1K0 615 423	24.3414-1709.7
	2,0 TDi 4x4	TD	05.2011	01.2013	24.3414-1710.5	240835	PINZA DE GARRA	1K0 615 424 M , 1K0 615 424 H , 1K0 615 424 C , 1K0 615 424	24.3414-1710.7-



Denominación

Ref. OE correspondientes a las referencias ATE



Referencia anterior / varios

SKODA

Modelo	Motor	TI	07.2006	01.2013	24.3414-1709.5	240834	PINZA DE GARRA	1K0 615 423 M , 1K0 615 423 H , 1K0 615 423 C , 1K0 615 423	24.3414-1709.7
OCTAVIA II (1Z) (04-13)	2,0 TDI 4x4	TI	07.2006	01.2013	24.3414-1709.5	240834	PINZA DE GARRA	1K0 615 423 M , 1K0 615 423 H , 1K0 615 423 C , 1K0 615 423	24.3414-1709.7
		TD	07.2006	01.2013	24.3414-1710.5	240835	PINZA DE GARRA	1K0 615 424 M , 1K0 615 424 H , 1K0 615 424 C , 1K0 615 424	24.3414-1710.7-
		TI	05.2011	01.2013	24.3414-1709.5	240834	PINZA DE GARRA	1K0 615 423 M , 1K0 615 423 H , 1K0 615 423 C , 1K0 615 423	24.3414-1709.7
OCTAVIA III (5E) (12-)	1,0 TSI	TD	05.2016		24.3384-1760.5	240801	PINZA DE GARRA	5Q0 615 424 A	
		TI	05.2016		24.3384-1759.5	240800	PINZA DE GARRA	5Q0 615 423 A	
	1,2 TSI	TD	02.2013		24.3384-1760.5	240801	PINZA DE GARRA	5Q0 615 424 A	
		TD	05.2015		24.3384-1760.5	240801	PINZA DE GARRA	5Q0 615 424 A	
		TI	02.2013		24.3384-1759.5	240800	PINZA DE GARRA	5Q0 615 423 A	
		TI	05.2015		24.3384-1759.5	240800	PINZA DE GARRA	5Q0 615 423 A	
	1,4 TSI	TD	05.2015		24.3384-1760.5	240801	PINZA DE GARRA	5Q0 615 424 A	
		TI	11.2012		24.3384-1759.5	240800	PINZA DE GARRA	5Q0 615 423 A	
		TI	05.2015		24.3384-1759.5	240800	PINZA DE GARRA	5Q0 615 423 A	
		TD	11.2012		24.3384-1760.5	240801	PINZA DE GARRA	5Q0 615 424 A	
	1,4 TSI G-TEC	TI	11.2013		24.3384-1759.5	240800	PINZA DE GARRA	5Q0 615 423 A	
		TD	11.2013		24.3384-1760.5	240801	PINZA DE GARRA	5Q0 615 424 A	
	1,6	TD	01.2014		24.3384-1760.5	240801	PINZA DE GARRA	5Q0 615 424 A	
		TI	01.2014		24.3384-1759.5	240800	PINZA DE GARRA	5Q0 615 423 A	
	1,6 TDI	TD	02.2013		24.3384-1760.5	240801	PINZA DE GARRA	5Q0 615 424 A	



Denominación

Ref. OE correspondientes a las referencias ATE

Referencia anterior / varios

SKODA

OCTAVIA III (5E) (12-)	1,6 TDI	TI	02.2013		24.3384-1759.5	240800	PINZA DE GARRA	5Q0 615 423 A	
	1,6 TDI 4x4	TI	05.2015		24.3384-1759.5	240800	PINZA DE GARRA	5Q0 615 423 A	
		TI	11.2012		24.3384-1759.5	240800	PINZA DE GARRA	5Q0 615 423 A	
		TD	05.2015		24.3384-1760.5	240801	PINZA DE GARRA	5Q0 615 424 A	
		TD	11.2012		24.3384-1760.5	240801	PINZA DE GARRA	5Q0 615 424 A	
	1,8 TSI	TI	11.2012		24.3384-1759.5	240800	PINZA DE GARRA	5Q0 615 423 A	
		TD	11.2012		24.3384-1760.5	240801	PINZA DE GARRA	5Q0 615 424 A	
	1,8 TSI 4x4	TI	11.2012		24.3384-1759.5	240800	PINZA DE GARRA	5Q0 615 423 A	
		TD	11.2012		24.3384-1760.5	240801	PINZA DE GARRA	5Q0 615 424 A	
	2,0 TDI	TD	02.2013		24.3384-1760.5	240801	PINZA DE GARRA	5Q0 615 424 A	
		TD	11.2012		24.3384-1760.5	240801	PINZA DE GARRA	5Q0 615 424 A	
		TI	02.2013		24.3384-1759.5	240800	PINZA DE GARRA	5Q0 615 423 A	
		TI	05.2013		24.3384-1759.5	240800	PINZA DE GARRA	5Q0 615 423 A	
		TI	11.2012		24.3384-1759.5	240800	PINZA DE GARRA	5Q0 615 423 A	
		TD	05.2013		24.3384-1760.5	240801	PINZA DE GARRA	5Q0 615 424 A	
	2,0 TDI 4x4	TI	09.2014		24.3384-1759.5	240800	PINZA DE GARRA	5Q0 615 423 A	
		TD	09.2014		24.3384-1760.5	240801	PINZA DE GARRA	5Q0 615 424 A	
		TD	11.2012		24.3384-1760.5	240801	PINZA DE GARRA	5Q0 615 424 A	
		TI	11.2012		24.3384-1759.5	240800	PINZA DE GARRA	5Q0 615 423 A	
	2,0 TSI RS	TD	05.2013		24.3384-1760.5	240801	PINZA DE GARRA	5Q0 615 424 A	
		TD	05.2015		24.3384-1760.5	240801	PINZA DE GARRA	5Q0 615 424 A	



Denominación

Ref. OE correspondientes a las referencias ATE

Referencia anterior / varios

SKODA

Modelo	Motor	TI	05.2015	05.2013	24.3384-1759.5	240800	PINZA DE GARRA	5Q0 615 423 A	
OCTAVIA III (5E) (12-)	2,0 TSI RS	TI	05.2015		24.3384-1759.5	240800	PINZA DE GARRA	5Q0 615 423 A	
		TI	05.2013		24.3384-1759.5	240800	PINZA DE GARRA	5Q0 615 423 A	
SUPERB II (08-15)	1,4 TSI	TD	08.2008	02.2015	24.3414-1710.5	240835	PINZA DE GARRA	1K0 615 424 M, 1K0 615 424 H, 1K0 615 424 C, 1K0 615 424	24.3414-1710.7-
		TI	08.2008	02.2015	24.3414-1709.5	240834	PINZA DE GARRA	1K0 615 423 M, 1K0 615 423 H, 1K0 615 423 C, 1K0 615 423	24.3414-1709.7
	1,6 TDI	TD	09.2010	02.2015	24.3414-1710.5	240835	PINZA DE GARRA	1K0 615 424 M, 1K0 615 424 H, 1K0 615 424 C, 1K0 615 424	24.3414-1710.7-
		TI	09.2010	02.2015	24.3414-1709.5	240834	PINZA DE GARRA	1K0 615 423 M, 1K0 615 423 H, 1K0 615 423 C, 1K0 615 423	24.3414-1709.7
	1,8 TFSI	TI	08.2008	02.2015	24.3414-1709.5	240834	PINZA DE GARRA	1K0 615 423 M, 1K0 615 423 H, 1K0 615 423 C, 1K0 615 423	24.3414-1709.7
		TD	08.2008	02.2015	24.3414-1710.5	240835	PINZA DE GARRA	1K0 615 424 M, 1K0 615 424 H, 1K0 615 424 C, 1K0 615 424	24.3414-1710.7-
	1,9 TDI	TI	08.2008	02.2015	24.3414-1709.5	240834	PINZA DE GARRA	1K0 615 423 M, 1K0 615 423 H, 1K0 615 423 C, 1K0 615 423	24.3414-1709.7
		TD	08.2008	02.2015	24.3414-1710.5	240835	PINZA DE GARRA	1K0 615 424 M, 1K0 615 424 H, 1K0 615 424 C, 1K0 615 424	24.3414-1710.7-
	2,0 TDI	TD	08.2008	02.2015	24.3414-1710.5	240835	PINZA DE GARRA	1K0 615 424 M, 1K0 615 424 H, 1K0 615 424 C, 1K0 615 424	24.3414-1710.7-
		TI	08.2008	02.2015	24.3414-1709.5	240834	PINZA DE GARRA	1K0 615 423 M, 1K0 615 423 H, 1K0 615 423 C, 1K0 615 423	24.3414-1709.7



Denominación

Ref. OE correspondientes a las referencias ATE



Referencia anterior / varios

SKODA

Modelo	Motor	Transmisión	Fecha inicio	Fecha fin	Referencia ATE	Código ATE	Denominación	Ref. OE correspondientes a las referencias ATE	Referencia anterior / varios
SUPERB II (08-15)	2,0 TSI	TD	05.2010	02.2015	24.3414-1710.5	240835	PINZA DE GARRA	1K0 615 424 M , 1K0 615 424 H , 1K0 615 424 C , 1K0 615 424	24.3414-1710.7-
		TI	05.2010	02.2015	24.3414-1709.5	240834	PINZA DE GARRA	1K0 615 423 M , 1K0 615 423 H , 1K0 615 423 C , 1K0 615 423	24.3414-1709.7
SUPERB II Combi (09-15)	1,4 TSI	TI	11.2009	02.2015	24.3414-1709.5	240834	PINZA DE GARRA	1K0 615 423 M , 1K0 615 423 H , 1K0 615 423 C , 1K0 615 423	24.3414-1709.7
		TD	11.2009	02.2015	24.3414-1710.5	240835	PINZA DE GARRA	1K0 615 424 M , 1K0 615 424 H , 1K0 615 424 C , 1K0 615 424	24.3414-1710.7-
	1,6 TDI	TI	09.2010	02.2015	24.3414-1709.5	240834	PINZA DE GARRA	1K0 615 423 M , 1K0 615 423 H , 1K0 615 423 C , 1K0 615 423	24.3414-1709.7
		TD	09.2010	02.2015	24.3414-1710.5	240835	PINZA DE GARRA	1K0 615 424 M , 1K0 615 424 H , 1K0 615 424 C , 1K0 615 424	24.3414-1710.7-
	1,8 TSI	TD	11.2009	02.2015	24.3414-1710.5	240835	PINZA DE GARRA	1K0 615 424 M , 1K0 615 424 H , 1K0 615 424 C , 1K0 615 424	24.3414-1710.7-
		TI	11.2009	02.2015	24.3414-1709.5	240834	PINZA DE GARRA	1K0 615 423 M , 1K0 615 423 H , 1K0 615 423 C , 1K0 615 423	24.3414-1709.7
	1,8 TSI 4x4	TI	11.2009	02.2015	24.3414-1709.5	240834	PINZA DE GARRA	1K0 615 423 M , 1K0 615 423 H , 1K0 615 423 C , 1K0 615 423	24.3414-1709.7
		TD	11.2009	02.2015	24.3414-1710.5	240835	PINZA DE GARRA	1K0 615 424 M , 1K0 615 424 H , 1K0 615 424 C , 1K0 615 424	24.3414-1710.7-
	1,9 TDI	TI	10.2009	02.2015	24.3414-1709.5	240834	PINZA DE GARRA	1K0 615 423 M , 1K0 615 423 H , 1K0 615 423 C , 1K0 615 423	24.3414-1709.7



Denominación

Ref. OE correspondientes a las referencias ATE

Referencia anterior / varios

SKODA

SUPERB II Combi (09-15)	1,9 TDI	TD	10.2009	02.2015	24.3414-1710.5	240835	PINZA DE GARRA	1K0 615 424 M , 1K0 615 424 H , 1K0 615 424 C , 1K0 615 424	24.3414-1710.7-
	2,0 TDI	TD	11.2009	02.2015	24.3414-1710.5	240835	PINZA DE GARRA	1K0 615 424 M , 1K0 615 424 H , 1K0 615 424 C , 1K0 615 424	24.3414-1710.7-
		TI	11.2009	02.2015	24.3414-1709.5	240834	PINZA DE GARRA	1K0 615 423 M , 1K0 615 423 H , 1K0 615 423 C , 1K0 615 423	24.3414-1709.7
	2,0 TDI 4x4	TI	11.2009	02.2015	24.3414-1709.5	240834	PINZA DE GARRA	1K0 615 423 M , 1K0 615 423 H , 1K0 615 423 C , 1K0 615 423	24.3414-1709.7
		TD	11.2009	02.2015	24.3414-1710.5	240835	PINZA DE GARRA	1K0 615 424 M , 1K0 615 424 H , 1K0 615 424 C , 1K0 615 424	24.3414-1710.7-
	2,0 TSI	TI	05.2010	02.2015	24.3414-1709.5	240834	PINZA DE GARRA	1K0 615 423 M , 1K0 615 423 H , 1K0 615 423 C , 1K0 615 423	24.3414-1709.7
		TD	05.2010	02.2015	24.3414-1710.5	240835	PINZA DE GARRA	1K0 615 424 M , 1K0 615 424 H , 1K0 615 424 C , 1K0 615 424	24.3414-1710.7-
	3,6 V6 4x4	TD	11.2009	02.2015	24.3414-1710.5	240835	PINZA DE GARRA	1K0 615 424 M , 1K0 615 424 H , 1K0 615 424 C , 1K0 615 424	24.3414-1710.7-
		TI	11.2009	02.2015	24.3414-1709.5	240834	PINZA DE GARRA	1K0 615 423 M , 1K0 615 423 H , 1K0 615 423 C , 1K0 615 423	24.3414-1709.7
YETI (09-)	1,2 TSI	TD	09.2009		24.3414-1710.5	240835	PINZA DE GARRA	1K0 615 424 M , 1K0 615 424 H , 1K0 615 424 C , 1K0 615 424	24.3414-1710.7-
		TI	09.2009		24.3414-1709.5	240834	PINZA DE GARRA	1K0 615 423 M , 1K0 615 423 H , 1K0 615 423 C , 1K0 615 423	24.3414-1709.7



Denominación

Ref. OE correspondientes a las referencias ATE



Referencia anterior / varios

SKODA

Modelo	Motor	Transmisión	Fecha	Referencia ATE	Referencia OE	Denominación	Ref. OE correspondientes a las referencias ATE	Referencia anterior / varios
YETI (09-)	1,4 TSI	TD	06.2010	24.3414-1710.5	240835	PINZA DE GARRA	1K0 615 424 M , 1K0 615 424 H , 1K0 615 424 C , 1K0 615 424	24.3414-1710.7-
		TI	06.2010	24.3414-1709.5	240834	PINZA DE GARRA	1K0 615 423 M , 1K0 615 423 H , 1K0 615 423 C , 1K0 615 423	24.3414-1709.7
	1,6 TDI	TD	11.2010	24.3414-1710.5	240835	PINZA DE GARRA	1K0 615 424 M , 1K0 615 424 H , 1K0 615 424 C , 1K0 615 424	24.3414-1710.7-
		TI	11.2010	24.3414-1709.5	240834	PINZA DE GARRA	1K0 615 423 M , 1K0 615 423 H , 1K0 615 423 C , 1K0 615 423	24.3414-1709.7
	1,8 TSI 4x4	TI	05.2009	24.3414-1709.5	240834	PINZA DE GARRA	1K0 615 423 M , 1K0 615 423 H , 1K0 615 423 C , 1K0 615 423	24.3414-1709.7
		TI	11.2009	24.3414-1709.5	240834	PINZA DE GARRA	1K0 615 423 M , 1K0 615 423 H , 1K0 615 423 C , 1K0 615 423	24.3414-1709.7
		TD	11.2009	24.3414-1710.5	240835	PINZA DE GARRA	1K0 615 424 M , 1K0 615 424 H , 1K0 615 424 C , 1K0 615 424	24.3414-1710.7-
		TD	05.2009	24.3414-1710.5	240835	PINZA DE GARRA	1K0 615 424 M , 1K0 615 424 H , 1K0 615 424 C , 1K0 615 424	24.3414-1710.7-
	2,0 TDI	TD	11.2011	24.3414-1710.5	240835	PINZA DE GARRA	1K0 615 424 M , 1K0 615 424 H , 1K0 615 424 C , 1K0 615 424	24.3414-1710.7-
		TD	11.2009	24.3414-1710.5	240835	PINZA DE GARRA	1K0 615 424 M , 1K0 615 424 H , 1K0 615 424 C , 1K0 615 424	24.3414-1710.7-
		TI	11.2011	24.3414-1709.5	240834	PINZA DE GARRA	1K0 615 423 M , 1K0 615 423 H , 1K0 615 423 C , 1K0 615 423	24.3414-1709.7



Denominación

Ref. OE correspondientes a las referencias ATE



Referencia anterior / varios

SKODA

YETI (09-)	2,0 TDI	TI	11.2009		24.3414-1709.5	240834	PINZA DE GARRA	1K0 615 423 M , 1K0 615 423 H , 1K0 615 423 C , 1K0 615 423	24.3414-1709.7
	2,0 TDI 4x4	TI	11.2009		24.3414-1709.5	240834	PINZA DE GARRA	1K0 615 423 M , 1K0 615 423 H , 1K0 615 423 C , 1K0 615 423	24.3414-1709.7
		TD	05.2009		24.3414-1710.5	240835	PINZA DE GARRA	1K0 615 424 M , 1K0 615 424 H , 1K0 615 424 C , 1K0 615 424	24.3414-1710.7-
		TD	11.2009		24.3414-1710.5	240835	PINZA DE GARRA	1K0 615 424 M , 1K0 615 424 H , 1K0 615 424 C , 1K0 615 424	24.3414-1710.7-
		TI	05.2009		24.3414-1709.5	240834	PINZA DE GARRA	1K0 615 423 M , 1K0 615 423 H , 1K0 615 423 C , 1K0 615 423	24.3414-1709.7

SUBARU

JUSTY (G3X) (03-07)	1,3 i 16V 4WD		09.2003	08.2007	28.0461-7106.1	BAR171	DISCO DE FRENO	55311-84E01 , 55311-86G02 , 5531186G02 , 47 07 288 , 93179462 , 93176389 , 47 06 749	
	1,5 i 16V 4WD		09.2003	08.2007	28.0461-7106.1	BAR171	DISCO DE FRENO	55311-84E01 , 55311-86G02 , 5531186G02 , 47 07 288 , 93179462 , 93176389 , 47 06 749	
OUTBACK (09-)	2,5 16V 4x4		01.2013		24.0118-0159.1	418159	DISCO DE FRENO	26310AA151	



Denominación

Ref. OE correspondientes a las referencias ATE



Referencia anterior / varios

SUZUKI

Modelo	Motor	Fecha inicio	Fecha fin	Código ATE	Referencia ATE	Denominación	Ref. OE correspondientes a las referencias ATE	Referencia anterior / varios
IGNIS II (03-12)	1,3 DDiS	09.2003	12.2012	28.0461-7106.1	BAR171	DISCO DE FRENO	55311-84E01, 55311-86G02, 5531186G02, 47 07 288, 93179462, 93176389, 47 06 749	
	1,3 i 16V	09.2003	12.2012	28.0461-7106.1	BAR171	DISCO DE FRENO	55311-84E01, 55311-86G02, 5531186G02, 47 07 288, 93179462, 93176389, 47 06 749	
	1,3 i 16V 4x4	09.2003	12.2012	28.0461-7106.1	BAR171	DISCO DE FRENO	55311-84E01, 55311-86G02, 5531186G02, 47 07 288, 93179462, 93176389, 47 06 749	
	1,5 i 16V	09.2003	12.2012	28.0461-7106.1	BAR171	DISCO DE FRENO	55311-84E01, 55311-86G02, 5531186G02, 47 07 288, 93179462, 93176389, 47 06 749	
	1,5 i 16V 4x4	09.2003	12.2012	28.0461-7106.1	BAR171	DISCO DE FRENO	55311-84E01, 55311-86G02, 5531186G02, 47 07 288, 93179462, 93176389, 47 06 749	
SPLASH (08-)	1,0 12V	01.2008		28.0462-0211.1	BAR202	DISCO DE FRENO	55311-62J00, 95513700, 93194988, 47 00 455, 47 10 944, 93192978, 47 08 241	
		06.2011		28.0462-0211.1	BAR202	DISCO DE FRENO	55311-62J00, 95513700, 93194988, 47 00 455, 47 10 944, 93192978, 47 08 241	
	1,2 16V	01.2008		28.0462-0211.1	BAR202	DISCO DE FRENO	55311-62J00, 95513700, 93194988, 47 00 455, 47 10 944, 93192978, 47 08 241	
	1,2 VVT	09.2010		28.0462-0211.1	BAR202	DISCO DE FRENO	55311-62J00, 95513700, 93194988, 47 00 455, 47 10 944, 93192978, 47 08 241	



Denominación

Ref. OE correspondientes a las referencias ATE



Referencia anterior / varios

SUZUKI

SPLASH (08-)	1,2 VVT		06.2011		28.0462-0211.1	BAR202	DISCO DE FRENO	55311-62J00 , 95513700 , 93194988 , 47 00 455 , 47 10 944 , 93192978 , 47 08 241	
			08.2012		28.0462-0211.1	BAR202	DISCO DE FRENO	55311-62J00 , 95513700 , 93194988 , 47 00 455 , 47 10 944 , 93192978 , 47 08 241	
	1,3 CDTi		01.2008		28.0462-0211.1	BAR202	DISCO DE FRENO	55311-62J00 , 95513700 , 93194988 , 47 00 455 , 47 10 944 , 93192978 , 47 08 241	
SWIFT III (05-10)	1,3 16V		02.2005	09.2010	28.0462-0211.1	BAR202	DISCO DE FRENO	55311-62J00 , 95513700 , 93194988 , 47 00 455 , 47 10 944 , 93192978 , 47 08 241	
	1,3 16V 4x4		02.2005	09.2010	28.0462-0211.1	BAR202	DISCO DE FRENO	55311-62J00 , 95513700 , 93194988 , 47 00 455 , 47 10 944 , 93192978 , 47 08 241	
			01.2006	09.2010	28.0462-0211.1	BAR202	DISCO DE FRENO	55311-62J00 , 95513700 , 93194988 , 47 00 455 , 47 10 944 , 93192978 , 47 08 241	
	1,3 DDiS		08.2005	09.2010	28.0462-0211.1	BAR202	DISCO DE FRENO	55311-62J00 , 95513700 , 93194988 , 47 00 455 , 47 10 944 , 93192978 , 47 08 241	
			08.2005	09.2007	28.0462-0211.1	BAR202	DISCO DE FRENO	55311-62J00 , 95513700 , 93194988 , 47 00 455 , 47 10 944 , 93192978 , 47 08 241	
	1,5 16V 4x4		02.2005	09.2010	28.0462-0211.1	BAR202	DISCO DE FRENO	55311-62J00 , 95513700 , 93194988 , 47 00 455 , 47 10 944 , 93192978 , 47 08 241	



Denominación

Ref. OE correspondientes a las referencias ATE



Referencia anterior / varios

SUZUKI

Modelo	Motor								
SWIFT III (05-10)	1,5 VVTi		02.2005	09.2010	28.0462-0211.1	BAR202	DISCO DE FRENO	55311-62J00 , 95513700 , 93194988 , 47 00 455 , 47 10 944 , 93192978 , 47 08 241	
VITARA (89-98)	1,6	TI	02.1993	01.1995	24.3223-1716.3	020592	CILINDRO DE RUEDA	53402-56B00	
		TD	02.1993	01.1995	24.3223-1717.3	020593	CILINDRO DE RUEDA	53401-56B00	
	1,6 Cabrio	TD	02.1993	01.1995	24.3223-1717.3	020593	CILINDRO DE RUEDA	53401-56B00	
		TI	02.1993	01.1995	24.3223-1716.3	020592	CILINDRO DE RUEDA	53402-56B00	
	1,6 i 16V	TD	02.1993	01.1995	24.3223-1717.3	020593	CILINDRO DE RUEDA	53401-56B00	
		TI	02.1993	01.1995	24.3223-1716.3	020592	CILINDRO DE RUEDA	53402-56B00	
	2,0 i V6	TD	12.1994	03.1998	24.3223-1717.3	020593	CILINDRO DE RUEDA	53401-56B00	
		TI	12.1994	03.1998	24.3223-1716.3	020592	CILINDRO DE RUEDA	53402-56B00	
WAGON R+ (00-08)	1,0 i 12V		06.2004	04.2008	28.0461-7106.1	BAR171	DISCO DE FRENO	55311-84E01 , 55311-86G02 , 5531186G02 , 47 07 288 , 93179462 , 93176389 , 47 06 749	
	1,2 i 16V		06.2004	04.2008	28.0461-7106.1	BAR171	DISCO DE FRENO	55311-84E01 , 55311-86G02 , 5531186G02 , 47 07 288 , 93179462 , 93176389 , 47 06 749	
	1,3 DDiS		09.2003	04.2008	28.0461-7106.1	BAR171	DISCO DE FRENO	55311-84E01 , 55311-86G02 , 5531186G02 , 47 07 288 , 93179462 , 93176389 , 47 06 749	
	1,3 i 16V		09.2003	04.2008	28.0461-7106.1	BAR171	DISCO DE FRENO	55311-84E01 , 55311-86G02 , 5531186G02 , 47 07 288 , 93179462 , 93176389 , 47 06 749	



Denominación

Ref. OE correspondientes a las referencias ATE



Referencia anterior / varios

SUZUKI

Modelo	Motor	Fecha 1	Fecha 2	Código 1	Código 2	Denominación	Referencias OE	Referencia anterior / varios
WAGON R+ (00-08)	1,3 i 16V	08.2001	04.2008	28.0461-7106.1	BAR171	DISCO DE FRENO	55311-84E01 , 55311-86G02 , 5531186G02 , 47 07 288 , 93179462 , 93176389 , 47 06 749	
			04.2008	28.0461-7106.1	BAR171	DISCO DE FRENO	55311-84E01 , 55311-86G02 , 5531186G02 , 47 07 288 , 93179462 , 93176389 , 47 06 749	
	1,3 i 16V 4WD	09.2003	04.2008	28.0461-7106.1	BAR171	DISCO DE FRENO	55311-84E01 , 55311-86G02 , 5531186G02 , 47 07 288 , 93179462 , 93176389 , 47 06 749	
			12.2004	28.0461-7106.1	BAR171	DISCO DE FRENO	55311-84E01 , 55311-86G02 , 5531186G02 , 47 07 288 , 93179462 , 93176389 , 47 06 749	



Denominación

Ref. OE correspondientes a las referencias ATE



Referencia anterior / varios

TOYOTA

Modelo	Motor	TD	03.2007	09.2012	24.5275-0341.3	331382	Denominación	Ref. OE correspondientes a las referencias ATE	Referencia anterior / varios
AURIS (06-12)	2,2 D-4D						LATIGUILLO	90947-W2017	
AVENSIS (09-)	1,6 i 16V						LATIGUILLO	90947-W2017	
	1,8 i 16V						LATIGUILLO	90947-W2017	
	2,0 D-4D						LATIGUILLO	90947-W2017	
							LATIGUILLO	90947-W2017	
	2,0 i 16V						LATIGUILLO	90947-W2017	
	2,2 D-4D						LATIGUILLO	90947-W2017	
AYGO (05-14)	1,0 i 12V						DISCO DE FRENO	43512-0H020 , 43512-0H010 , 4249 94 , 4249 54 , 4246 F0 , 4249 55 , 4246 J0	
	1,0 i 12V GPL						DISCO DE FRENO	43512-0H020 , 43512-0H010 , 4249 94 , 4249 54 , 4246 F0 , 4249 55 , 4246 J0	
	1,4 HDi						DISCO DE FRENO	43512-0H020 , 43512-0H010 , 4249 94 , 4249 54 , 4246 F0 , 4249 55 , 4246 J0	
AYGO (14-)	1,0 12V						DISCO DE FRENO	43512-0H020 , 43512-0H010 , 4249 94 , 4249 54 , 4246 F0 , 4249 55 , 4246 J0	
	1,2						DISCO DE FRENO	43512-0H020 , 43512-0H010 , 4249 94 , 4249 54 , 4246 F0 , 4249 55 , 4246 J0	
HIACE (06-)	2,5 D-4D						CILINDRO DE RUEDA	47550-35260 , 47550-30140 , 47550-26130	
	2,5 D-4D 4x4						CILINDRO DE RUEDA	47550-35260 , 47550-30140 , 47550-26130	
HIACE (95-06)	2,0 (KLH12)						CILINDRO DE RUEDA	47550-35260 , 47550-30140 , 47550-26130	



Denominación

Ref. OE correspondientes a las referencias ATE



Referencia anterior / varios

TOYOTA

Modelo	Motor	Fecha inicio	Fecha fin	Código ATE	Código OE	Denominación	Referencias OE correspondientes	Referencia anterior / varios
HIACE (95-06)	2,4 (RCH12/22)	08.1995	07.1996	24.3225-1705.3	020594	CILINDRO DE RUEDA	47550-35260 , 47550-30140 , 47550-26130	
		08.1996	04.1998	24.3225-1705.3	020594	CILINDRO DE RUEDA	47550-35260 , 47550-30140 , 47550-26130	
	2,4 4WD (RCH18/28)	08.1995	04.1998	24.3225-1705.3	020594	CILINDRO DE RUEDA	47550-35260 , 47550-30140 , 47550-26130	
	2,4 D (LXH12/18)	08.1995	07.1996	24.3225-1705.3	020594	CILINDRO DE RUEDA	47550-35260 , 47550-30140 , 47550-26130	
		08.1996	08.2001	24.3225-1705.3	020594	CILINDRO DE RUEDA	47550-35260 , 47550-30140 , 47550-26130	
	2,4 TD (LXH12/22)	08.1995	07.1996	24.3225-1705.3	020594	CILINDRO DE RUEDA	47550-35260 , 47550-30140 , 47550-26130	
		08.1996	08.2001	24.3225-1705.3	020594	CILINDRO DE RUEDA	47550-35260 , 47550-30140 , 47550-26130	
	2,4 TD 4WD (LXH18/28)	08.1995	08.2001	24.3225-1705.3	020594	CILINDRO DE RUEDA	47550-35260 , 47550-30140 , 47550-26130	
	2,5 D-4D (KLH1/2)	11.2001	08.2006	24.3225-1705.3	020594	CILINDRO DE RUEDA	47550-35260 , 47550-30140 , 47550-26130	
	2,5 D-4D 4WD (KLH1/2)	08.2001	08.2004	24.3225-1705.3	020594	CILINDRO DE RUEDA	47550-35260 , 47550-30140 , 47550-26130	
		11.2001	08.2006	24.3225-1705.3	020594	CILINDRO DE RUEDA	47550-35260 , 47550-30140 , 47550-26130	
	2,7 (RCH13/23)	04.1998	06.2006	24.3225-1705.3	020594	CILINDRO DE RUEDA	47550-35260 , 47550-30140 , 47550-26130	
	2,7 4WD (RCH19/29)	04.1998	06.2006	24.3225-1705.3	020594	CILINDRO DE RUEDA	47550-35260 , 47550-30140 , 47550-26130	
	3,0 D (RCH13)	08.2001	10.2003	24.3225-1705.3	020594	CILINDRO DE RUEDA	47550-35260 , 47550-30140 , 47550-26130	



Denominación

Ref. OE correspondientes a las referencias ATE

Referencia anterior / varios

TOYOTA

HILUX (97-05)	2,4 D		11.1998	01.2002	24.3225-1705.3	020594	CILINDRO DE RUEDA	47550-35260 , 47550-30140 , 47550-26130	
			08.1997	10.1998	24.3225-1705.3	020594	CILINDRO DE RUEDA	47550-35260 , 47550-30140 , 47550-26130	
	2,5 D-4D		11.2001	07.2005	24.3225-1705.3	020594	CILINDRO DE RUEDA	47550-35260 , 47550-30140 , 47550-26130	
LAND CRUISER 150 (10-)	2,7 4WD		01.2010		24.0132-0174.1	432174	DISCO DE FRENO	43512-60190	
	2,8 D-4D		06.2015		24.0132-0174.1	432174	DISCO DE FRENO	43512-60190	
	3,0 D-4D		03.2010		24.0132-0174.1	432174	DISCO DE FRENO	43512-60190	
			01.2010		24.0132-0174.1	432174	DISCO DE FRENO	43512-60190	
	3,0 TDi		01.2010		24.0132-0174.1	432174	DISCO DE FRENO	43512-60190	
	4,0 V6 Dual VVTi		01.2010		24.0132-0174.1	432174	DISCO DE FRENO	43512-60190	
	4,0 V6 VVTi		01.2010		24.0132-0174.1	432174	DISCO DE FRENO	43512-60190	
MR2 (00-07)	1,8 VVTi (ZZW30)		01.2000	06.2007	28.0462-0175.1	BAR201	DISCO DE FRENO	43512-0D050 , 43512-17120 , 43512-17131 , 43512-17130 , 43512-52040 , 43512-52090	
YARIS (99-05)	1,0 i 16V		08.1999	03.2003	28.0462-0175.1	BAR201	DISCO DE FRENO	43512-0D050 , 43512-17120 , 43512-17131 , 43512-17130 , 43512-52040 , 43512-52090	
			04.2003	08.2005	28.0462-0175.1	BAR201	DISCO DE FRENO	43512-0D050 , 43512-17120 , 43512-17131 , 43512-17130 , 43512-52040 , 43512-52090	
	1,3 i 16V		09.1999	10.2004	28.0462-0175.1	BAR201	DISCO DE FRENO	43512-0D050 , 43512-17120 , 43512-17131 , 43512-17130 , 43512-52040 , 43512-52090	



Denominación

Ref. OE correspondientes a las referencias ATE

Referencia anterior / varios

TOYOTA

Modelo	Motor	Fecha inicio	Fecha fin	Código ATE	Referencia ATE	Denominación	Ref. OE correspondientes a las referencias ATE	Referencia anterior / varios
YARIS (99-05)	1,3 i 16V	04.2002	08.2005	28.0462-0175.1	BAR201	DISCO DE FRENO	43512-0D050 , 43512-17120 , 43512-17131 , 43512-17130 , 43512-52040 , 43512-52090	
	1,4 D-4D	12.2001	08.2005	28.0462-0175.1	BAR201	DISCO DE FRENO	43512-0D050 , 43512-17120 , 43512-17131 , 43512-17130 , 43512-52040 , 43512-52090	
	1,5 VVTi Sport	01.2003	08.2005	28.0462-0175.1	BAR201	DISCO DE FRENO	43512-0D050 , 43512-17120 , 43512-17131 , 43512-17130 , 43512-52040 , 43512-52090	
		04.2001	03.2003	28.0462-0175.1	BAR201	DISCO DE FRENO	43512-0D050 , 43512-17120 , 43512-17131 , 43512-17130 , 43512-52040 , 43512-52090	
	1,5 VVTi Turbo Sport	04.2003	10.2004	28.0462-0175.1	BAR201	DISCO DE FRENO	43512-0D050 , 43512-17120 , 43512-17131 , 43512-17130 , 43512-52040 , 43512-52090	
YARIS VERSO (99-05)	1,3	11.1999	03.2003	28.0462-0175.1	BAR201	DISCO DE FRENO	43512-0D050 , 43512-17120 , 43512-17131 , 43512-17130 , 43512-52040 , 43512-52090	
		01.2003	09.2005	28.0462-0175.1	BAR201	DISCO DE FRENO	43512-0D050 , 43512-17120 , 43512-17131 , 43512-17130 , 43512-52040 , 43512-52090	
	1,4 D-4D	12.2001	09.2005	28.0462-0175.1	BAR201	DISCO DE FRENO	43512-0D050 , 43512-17120 , 43512-17131 , 43512-17130 , 43512-52040 , 43512-52090	
	1,5	05.2003	09.2005	28.0462-0175.1	BAR201	DISCO DE FRENO	43512-0D050 , 43512-17120 , 43512-17131 , 43512-17130 , 43512-52040 , 43512-52090	



					Denominación	Ref. OE correspondientes a las referencias ATE	 Referencia anterior / varios
---	---	---	--	---	---------------------	---	---

TOYOTA

YARIS VERSO (99-05)	1,5		03.2000	03.2003	28.0462-0175.1	BAR201	DISCO DE FRENO	43512-0D050 , 43512-17120 , 43512-17131 , 43512-17130 , 43512-52040 , 43512-52090	
	1,5 4WD		03.2000	09.2005	28.0462-0175.1	BAR201	DISCO DE FRENO	43512-0D050 , 43512-17120 , 43512-17131 , 43512-17130 , 43512-52040 , 43512-52090	



Denominación

Ref. OE correspondientes a las referencias ATE



Referencia anterior / varios

VOLKSWAGEN

EOS (06-)									
	1,4 TSI	TD	05.2008		24.3414-1710.5	240835	PINZA DE GARRA	1K0 615 424 M , 1K0 615 424 H , 1K0 615 424 C , 1K0 615 424	24.3414-1710.7-
		TD	10.2007		24.3414-1710.5	240835	PINZA DE GARRA	1K0 615 424 M , 1K0 615 424 H , 1K0 615 424 C , 1K0 615 424	24.3414-1710.7-
		TI	10.2007		24.3414-1709.5	240834	PINZA DE GARRA	1K0 615 423 M , 1K0 615 423 H , 1K0 615 423 C , 1K0 615 423	24.3414-1709.7
		TI	05.2008		24.3414-1709.5	240834	PINZA DE GARRA	1K0 615 423 M , 1K0 615 423 H , 1K0 615 423 C , 1K0 615 423	24.3414-1709.7
	1,6 FSI	TD	05.2006		24.3414-1710.5	240835	PINZA DE GARRA	1K0 615 424 M , 1K0 615 424 H , 1K0 615 424 C , 1K0 615 424	24.3414-1710.7-
		TI	05.2006		24.3414-1709.5	240834	PINZA DE GARRA	1K0 615 423 M , 1K0 615 423 H , 1K0 615 423 C , 1K0 615 423	24.3414-1709.7
	2,0 FSI	TD	05.2006		24.3414-1710.5	240835	PINZA DE GARRA	1K0 615 424 M , 1K0 615 424 H , 1K0 615 424 C , 1K0 615 424	24.3414-1710.7-
		TI	05.2006		24.3414-1709.5	240834	PINZA DE GARRA	1K0 615 423 M , 1K0 615 423 H , 1K0 615 423 C , 1K0 615 423	24.3414-1709.7
	2,0 TDI	TI	11.2010		24.3414-1709.5	240834	PINZA DE GARRA	1K0 615 423 M , 1K0 615 423 H , 1K0 615 423 C , 1K0 615 423	24.3414-1709.7
		TD	05.2006		24.3414-1710.5	240835	PINZA DE GARRA	1K0 615 424 M , 1K0 615 424 H , 1K0 615 424 C , 1K0 615 424	24.3414-1710.7-
		TI	05.2006		24.3414-1709.5	240834	PINZA DE GARRA	1K0 615 423 M , 1K0 615 423 H , 1K0 615 423 C , 1K0 615 423	24.3414-1709.7



Denominación

Ref. OE correspondientes a las referencias ATE



Referencia anterior / varios

VOLKSWAGEN

EOS (06-)	2,0 TDI	TD	11.2010		24.3414-1710.5	240835	PINZA DE GARRA	1K0 615 424 M , 1K0 615 424 H , 1K0 615 424 C , 1K0 615 424	24.3414-1710.7-
	2,0 TDI 16V	TD	05.2008		24.3414-1710.5	240835	PINZA DE GARRA	1K0 615 424 M , 1K0 615 424 H , 1K0 615 424 C , 1K0 615 424	24.3414-1710.7-
		TI	05.2008		24.3414-1709.5	240834	PINZA DE GARRA	1K0 615 423 M , 1K0 615 423 H , 1K0 615 423 C , 1K0 615 423	24.3414-1709.7
	2,0 TFSI	TD	05.2006		24.3414-1710.5	240835	PINZA DE GARRA	1K0 615 424 M , 1K0 615 424 H , 1K0 615 424 C , 1K0 615 424	24.3414-1710.7-
		TI	05.2006		24.3414-1709.5	240834	PINZA DE GARRA	1K0 615 423 M , 1K0 615 423 H , 1K0 615 423 C , 1K0 615 423	24.3414-1709.7
	2,0 TSI	TI	11.2009		24.3414-1709.5	240834	PINZA DE GARRA	1K0 615 423 M , 1K0 615 423 H , 1K0 615 423 C , 1K0 615 423	24.3414-1709.7
		TD	11.2009		24.3414-1710.5	240835	PINZA DE GARRA	1K0 615 424 M , 1K0 615 424 H , 1K0 615 424 C , 1K0 615 424	24.3414-1710.7-
	3,2 V6	TI	05.2006		24.3414-1709.5	240834	PINZA DE GARRA	1K0 615 423 M , 1K0 615 423 H , 1K0 615 423 C , 1K0 615 423	24.3414-1709.7
		TD	05.2006		24.3414-1710.5	240835	PINZA DE GARRA	1K0 615 424 M , 1K0 615 424 H , 1K0 615 424 C , 1K0 615 424	24.3414-1710.7-
	3,6 V6	TD	05.2009		24.3414-1710.5	240835	PINZA DE GARRA	1K0 615 424 M , 1K0 615 424 H , 1K0 615 424 C , 1K0 615 424	24.3414-1710.7-
		TI	05.2009		24.3414-1709.5	240834	PINZA DE GARRA	1K0 615 423 M , 1K0 615 423 H , 1K0 615 423 C , 1K0 615 423	24.3414-1709.7



Denominación

Ref. OE correspondientes a las referencias ATE

Referencia anterior / varios

VOLKSWAGEN

GOLF Plus (05-14)	1,2 TSI	TI	08.2009	01.2014	24.3414-1709.5	240834	PINZA DE GARRA	1K0 615 423 M , 1K0 615 423 H , 1K0 615 423 C , 1K0 615 423	24.3414-1709.7
		TD	08.2009	01.2014	24.3414-1710.5	240835	PINZA DE GARRA	1K0 615 424 M , 1K0 615 424 H , 1K0 615 424 C , 1K0 615 424	24.3414-1710.7-
	1,4 16V	TD	01.2005	01.2014	24.3414-1710.5	240835	PINZA DE GARRA	1K0 615 424 M , 1K0 615 424 H , 1K0 615 424 C , 1K0 615 424	24.3414-1710.7-
		TI	01.2005	01.2014	24.3414-1709.5	240834	PINZA DE GARRA	1K0 615 423 M , 1K0 615 423 H , 1K0 615 423 C , 1K0 615 423	24.3414-1709.7
	1,4 FSI	TI	07.2005	01.2014	24.3414-1709.5	240834	PINZA DE GARRA	1K0 615 423 M , 1K0 615 423 H , 1K0 615 423 C , 1K0 615 423	24.3414-1709.7
		TD	07.2005	01.2014	24.3414-1710.5	240835	PINZA DE GARRA	1K0 615 424 M , 1K0 615 424 H , 1K0 615 424 C , 1K0 615 424	24.3414-1710.7-
	1,4 TSI	TD	06.2008	01.2014	24.3414-1710.5	240835	PINZA DE GARRA	1K0 615 424 M , 1K0 615 424 H , 1K0 615 424 C , 1K0 615 424	24.3414-1710.7-
		TD	06.2007	01.2014	24.3414-1710.5	240835	PINZA DE GARRA	1K0 615 424 M , 1K0 615 424 H , 1K0 615 424 C , 1K0 615 424	24.3414-1710.7-
		TI	06.2008	01.2014	24.3414-1709.5	240834	PINZA DE GARRA	1K0 615 423 M , 1K0 615 423 H , 1K0 615 423 C , 1K0 615 423	24.3414-1709.7
		TI	05.2006	01.2014	24.3414-1709.5	240834	PINZA DE GARRA	1K0 615 423 M , 1K0 615 423 H , 1K0 615 423 C , 1K0 615 423	24.3414-1709.7
		TD	05.2006	01.2014	24.3414-1710.5	240835	PINZA DE GARRA	1K0 615 424 M , 1K0 615 424 H , 1K0 615 424 C , 1K0 615 424	24.3414-1710.7-



Denominación

Ref. OE correspondientes a las referencias ATE



Referencia anterior / varios

VOLKSWAGEN

GOLF Plus (05-14)	1,4 TSI	TI	06.2007	01.2014	24.3414-1709.5	240834	PINZA DE GARRA	1K0 615 423 M , 1K0 615 423 H , 1K0 615 423 C , 1K0 615 423	24.3414-1709.7
	1,6	TI	05.2005	01.2014	24.3414-1709.5	240834	PINZA DE GARRA	1K0 615 423 M , 1K0 615 423 H , 1K0 615 423 C , 1K0 615 423	24.3414-1709.7
		TD	05.2005	01.2014	24.3414-1710.5	240835	PINZA DE GARRA	1K0 615 424 M , 1K0 615 424 H , 1K0 615 424 C , 1K0 615 424	24.3414-1710.7-
	1,6 BiFuel	TI	05.2009	01.2014	24.3414-1709.5	240834	PINZA DE GARRA	1K0 615 423 M , 1K0 615 423 H , 1K0 615 423 C , 1K0 615 423	24.3414-1709.7
		TD	05.2009	01.2014	24.3414-1710.5	240835	PINZA DE GARRA	1K0 615 424 M , 1K0 615 424 H , 1K0 615 424 C , 1K0 615 424	24.3414-1710.7-
	1,6 FSI	TI	01.2005	01.2014	24.3414-1709.5	240834	PINZA DE GARRA	1K0 615 423 M , 1K0 615 423 H , 1K0 615 423 C , 1K0 615 423	24.3414-1709.7
		TD	01.2005	01.2014	24.3414-1710.5	240835	PINZA DE GARRA	1K0 615 424 M , 1K0 615 424 H , 1K0 615 424 C , 1K0 615 424	24.3414-1710.7-
	1,6 TDI	TD	02.2009	01.2014	24.3414-1710.5	240835	PINZA DE GARRA	1K0 615 424 M , 1K0 615 424 H , 1K0 615 424 C , 1K0 615 424	24.3414-1710.7-
		TI	02.2009	01.2014	24.3414-1709.5	240834	PINZA DE GARRA	1K0 615 423 M , 1K0 615 423 H , 1K0 615 423 C , 1K0 615 423	24.3414-1709.7
	1,9 TDI	TD	01.2005	01.2014	24.3414-1710.5	240835	PINZA DE GARRA	1K0 615 424 M , 1K0 615 424 H , 1K0 615 424 C , 1K0 615 424	24.3414-1710.7-
		TI	01.2005	01.2014	24.3414-1709.5	240834	PINZA DE GARRA	1K0 615 423 M , 1K0 615 423 H , 1K0 615 423 C , 1K0 615 423	24.3414-1709.7



Denominación

Ref. OE correspondientes a las referencias ATE



Referencia anterior / varios

VOLKSWAGEN

GOLF Plus (05-14)	1,9 TDI	TD	05.2005	01.2014	24.3414-1710.5	240835	PINZA DE GARRA	1K0 615 424 M , 1K0 615 424 H , 1K0 615 424 C , 1K0 615 424	24.3414-1710.7-
		TI	05.2005	01.2014	24.3414-1709.5	240834	PINZA DE GARRA	1K0 615 423 M , 1K0 615 423 H , 1K0 615 423 C , 1K0 615 423	24.3414-1709.7
	2,0 FSI	TD	05.2005	01.2014	24.3414-1710.5	240835	PINZA DE GARRA	1K0 615 424 M , 1K0 615 424 H , 1K0 615 424 C , 1K0 615 424	24.3414-1710.7-
		TI	05.2005	01.2014	24.3414-1709.5	240834	PINZA DE GARRA	1K0 615 423 M , 1K0 615 423 H , 1K0 615 423 C , 1K0 615 423	24.3414-1709.7
	2,0 TDI	TD	01.2005	01.2014	24.3414-1710.5	240835	PINZA DE GARRA	1K0 615 424 M , 1K0 615 424 H , 1K0 615 424 C , 1K0 615 424	24.3414-1710.7-
		TI	01.2005	01.2014	24.3414-1709.5	240834	PINZA DE GARRA	1K0 615 423 M , 1K0 615 423 H , 1K0 615 423 C , 1K0 615 423	24.3414-1709.7
		TI	05.2005	01.2014	24.3414-1709.5	240834	PINZA DE GARRA	1K0 615 423 M , 1K0 615 423 H , 1K0 615 423 C , 1K0 615 423	24.3414-1709.7
		TD	05.2005	01.2014	24.3414-1710.5	240835	PINZA DE GARRA	1K0 615 424 M , 1K0 615 424 H , 1K0 615 424 C , 1K0 615 424	24.3414-1710.7-
GOLF V (03-08)	1,4 16V	TD	10.2003	09.2008	24.3414-1710.5	240835	PINZA DE GARRA	1K0 615 424 M , 1K0 615 424 H , 1K0 615 424 C , 1K0 615 424	24.3414-1710.7-
		TI	10.2003	09.2008	24.3414-1709.5	240834	PINZA DE GARRA	1K0 615 423 M , 1K0 615 423 H , 1K0 615 423 C , 1K0 615 423	24.3414-1709.7
	1,4 FSI	TD	10.2003	09.2008	24.3414-1710.5	240835	PINZA DE GARRA	1K0 615 424 M , 1K0 615 424 H , 1K0 615 424 C , 1K0 615 424	24.3414-1710.7-



Denominación

Ref. OE correspondientes a las referencias ATE

Referencia anterior / varios

VOLKSWAGEN

GOLF V (03-08)	1,4 FSI	TI	10.2003	09.2008	24.3414-1709.5	240834	PINZA DE GARRA	1K0 615 423 M , 1K0 615 423 H , 1K0 615 423 C , 1K0 615 423	24.3414-1709.7
	1,4 TSI	TD	05.2006	09.2008	24.3414-1710.5	240835	PINZA DE GARRA	1K0 615 424 M , 1K0 615 424 H , 1K0 615 424 C , 1K0 615 424	24.3414-1710.7-
		TD	05.2007	09.2008	24.3414-1710.5	240835	PINZA DE GARRA	1K0 615 424 M , 1K0 615 424 H , 1K0 615 424 C , 1K0 615 424	24.3414-1710.7-
		TI	11.2005	09.2008	24.3414-1709.5	240834	PINZA DE GARRA	1K0 615 423 M , 1K0 615 423 H , 1K0 615 423 C , 1K0 615 423	24.3414-1709.7
		TI	05.2007	09.2008	24.3414-1709.5	240834	PINZA DE GARRA	1K0 615 423 M , 1K0 615 423 H , 1K0 615 423 C , 1K0 615 423	24.3414-1709.7
		TI	05.2006	09.2008	24.3414-1709.5	240834	PINZA DE GARRA	1K0 615 423 M , 1K0 615 423 H , 1K0 615 423 C , 1K0 615 423	24.3414-1709.7
		TD	11.2005	09.2008	24.3414-1710.5	240835	PINZA DE GARRA	1K0 615 424 M , 1K0 615 424 H , 1K0 615 424 C , 1K0 615 424	24.3414-1710.7-
	1,6 16V	TD	01.2004	09.2008	24.3414-1710.5	240835	PINZA DE GARRA	1K0 615 424 M , 1K0 615 424 H , 1K0 615 424 C , 1K0 615 424	24.3414-1710.7-
		TI	01.2004	09.2008	24.3414-1709.5	240834	PINZA DE GARRA	1K0 615 423 M , 1K0 615 423 H , 1K0 615 423 C , 1K0 615 423	24.3414-1709.7
	1,6 FSI	TD	10.2003	09.2008	24.3414-1710.5	240835	PINZA DE GARRA	1K0 615 424 M , 1K0 615 424 H , 1K0 615 424 C , 1K0 615 424	24.3414-1710.7-
		TI	10.2003	09.2008	24.3414-1709.5	240834	PINZA DE GARRA	1K0 615 423 M , 1K0 615 423 H , 1K0 615 423 C , 1K0 615 423	24.3414-1709.7



Denominación

Ref. OE correspondientes a las referencias ATE



Referencia anterior / varios

VOLKSWAGEN

GOLF V (03-08)	1,9 TDI	TD	05.2004	09.2008	24.3414-1710.5	240835	PINZA DE GARRA	1K0 615 424 M , 1K0 615 424 H , 1K0 615 424 C , 1K0 615 424	24.3414-1710.7-
		TD	10.2003	09.2008	24.3414-1710.5	240835	PINZA DE GARRA	1K0 615 424 M , 1K0 615 424 H , 1K0 615 424 C , 1K0 615 424	24.3414-1710.7-
		TI	10.2003	09.2008	24.3414-1709.5	240834	PINZA DE GARRA	1K0 615 423 M , 1K0 615 423 H , 1K0 615 423 C , 1K0 615 423	24.3414-1709.7
		TI	05.2004	09.2008	24.3414-1709.5	240834	PINZA DE GARRA	1K0 615 423 M , 1K0 615 423 H , 1K0 615 423 C , 1K0 615 423	24.3414-1709.7
	1,9 TDI 4motion	TD	08.2004	09.2008	24.3414-1710.5	240835	PINZA DE GARRA	1K0 615 424 M , 1K0 615 424 H , 1K0 615 424 C , 1K0 615 424	24.3414-1710.7-
		TI	08.2004	09.2008	24.3414-1709.5	240834	PINZA DE GARRA	1K0 615 423 M , 1K0 615 423 H , 1K0 615 423 C , 1K0 615 423	24.3414-1709.7
	2,0 FSI	TD	10.2003	09.2008	24.3414-1710.5	240835	PINZA DE GARRA	1K0 615 424 M , 1K0 615 424 H , 1K0 615 424 C , 1K0 615 424	24.3414-1710.7-
		TI	10.2003	09.2008	24.3414-1709.5	240834	PINZA DE GARRA	1K0 615 423 M , 1K0 615 423 H , 1K0 615 423 C , 1K0 615 423	24.3414-1709.7
	2,0 FSI 4motion	TD	08.2004	09.2008	24.3414-1710.5	240835	PINZA DE GARRA	1K0 615 424 M , 1K0 615 424 H , 1K0 615 424 C , 1K0 615 424	24.3414-1710.7-
		TI	08.2004	09.2008	24.3414-1709.5	240834	PINZA DE GARRA	1K0 615 423 M , 1K0 615 423 H , 1K0 615 423 C , 1K0 615 423	24.3414-1709.7
	2,0 GTI	TD	09.2004	09.2008	24.3414-1710.5	240835	PINZA DE GARRA	1K0 615 424 M , 1K0 615 424 H , 1K0 615 424 C , 1K0 615 424	24.3414-1710.7-



Denominación

Ref. OE correspondientes a las referencias ATE

Referencia anterior / varios

VOLKSWAGEN

GOLF V (03-08)	2,0 GTI	TD	09.2006	09.2008	24.3414-1710.5	240835	PINZA DE GARRA	1K0 615 424 M , 1K0 615 424 H , 1K0 615 424 C , 1K0 615 424	24.3414-1710.7-
		TI	09.2006	09.2008	24.3414-1709.5	240834	PINZA DE GARRA	1K0 615 423 M , 1K0 615 423 H , 1K0 615 423 C , 1K0 615 423	24.3414-1709.7
		TI	09.2004	09.2008	24.3414-1709.5	240834	PINZA DE GARRA	1K0 615 423 M , 1K0 615 423 H , 1K0 615 423 C , 1K0 615 423	24.3414-1709.7
	2,0 SDI	TD	01.2004	09.2008	24.3414-1710.5	240835	PINZA DE GARRA	1K0 615 424 M , 1K0 615 424 H , 1K0 615 424 C , 1K0 615 424	24.3414-1710.7-
		TI	01.2004	09.2008	24.3414-1709.5	240834	PINZA DE GARRA	1K0 615 423 M , 1K0 615 423 H , 1K0 615 423 C , 1K0 615 423	24.3414-1709.7
	2,0 TDI	TD	10.2003	09.2008	24.3414-1710.5	240835	PINZA DE GARRA	1K0 615 424 M , 1K0 615 424 H , 1K0 615 424 C , 1K0 615 424	24.3414-1710.7-
		TD	11.2005	09.2008	24.3414-1710.5	240835	PINZA DE GARRA	1K0 615 424 M , 1K0 615 424 H , 1K0 615 424 C , 1K0 615 424	24.3414-1710.7-
		TI	10.2003	09.2008	24.3414-1709.5	240834	PINZA DE GARRA	1K0 615 423 M , 1K0 615 423 H , 1K0 615 423 C , 1K0 615 423	24.3414-1709.7
		TI	11.2005	09.2008	24.3414-1709.5	240834	PINZA DE GARRA	1K0 615 423 M , 1K0 615 423 H , 1K0 615 423 C , 1K0 615 423	24.3414-1709.7
	2,0 TDI 4motion	TD	08.2004	09.2008	24.3414-1710.5	240835	PINZA DE GARRA	1K0 615 424 M , 1K0 615 424 H , 1K0 615 424 C , 1K0 615 424	24.3414-1710.7-
		TI	08.2004	09.2008	24.3414-1709.5	240834	PINZA DE GARRA	1K0 615 423 M , 1K0 615 423 H , 1K0 615 423 C , 1K0 615 423	24.3414-1709.7



Denominación

Ref. OE correspondientes a las referencias ATE

Referencia anterior / varios

VOLKSWAGEN

GOLF V (03-08)	3,2 R32	TD	11.2005	09.2008	24.3414-1710.5	240835	PINZA DE GARRA	1K0 615 424 M , 1K0 615 424 H , 1K0 615 424 C , 1K0 615 424	24.3414-1710.7-
		TI	11.2005	09.2008	24.3414-1709.5	240834	PINZA DE GARRA	1K0 615 423 M , 1K0 615 423 H , 1K0 615 423 C , 1K0 615 423	24.3414-1709.7
GOLF V Variant (07-09)	1,4	TD	06.2007	06.2009	24.3414-1710.5	240835	PINZA DE GARRA	1K0 615 424 M , 1K0 615 424 H , 1K0 615 424 C , 1K0 615 424	24.3414-1710.7-
		TI	06.2007	06.2009	24.3414-1709.5	240834	PINZA DE GARRA	1K0 615 423 M , 1K0 615 423 H , 1K0 615 423 C , 1K0 615 423	24.3414-1709.7
	1,4 TSI	TD	05.2007	06.2009	24.3414-1710.5	240835	PINZA DE GARRA	1K0 615 424 M , 1K0 615 424 H , 1K0 615 424 C , 1K0 615 424	24.3414-1710.7-
		TD	07.2008	06.2009	24.3414-1710.5	240835	PINZA DE GARRA	1K0 615 424 M , 1K0 615 424 H , 1K0 615 424 C , 1K0 615 424	24.3414-1710.7-
		TD	06.2007	06.2009	24.3414-1710.5	240835	PINZA DE GARRA	1K0 615 424 M , 1K0 615 424 H , 1K0 615 424 C , 1K0 615 424	24.3414-1710.7-
		TI	05.2007	06.2009	24.3414-1709.5	240834	PINZA DE GARRA	1K0 615 423 M , 1K0 615 423 H , 1K0 615 423 C , 1K0 615 423	24.3414-1709.7
		TI	06.2007	06.2009	24.3414-1709.5	240834	PINZA DE GARRA	1K0 615 423 M , 1K0 615 423 H , 1K0 615 423 C , 1K0 615 423	24.3414-1709.7
		TI	07.2008	06.2009	24.3414-1709.5	240834	PINZA DE GARRA	1K0 615 423 M , 1K0 615 423 H , 1K0 615 423 C , 1K0 615 423	24.3414-1709.7
	1,6	TD	05.2007	06.2009	24.3414-1710.5	240835	PINZA DE GARRA	1K0 615 424 M , 1K0 615 424 H , 1K0 615 424 C , 1K0 615 424	24.3414-1710.7-



Denominación

Ref. OE correspondientes a las referencias ATE



Referencia anterior / varios

VOLKSWAGEN

GOLF V Variant (07-09)	1,6	TI	05.2007	06.2009	24.3414-1709.5	240834	PINZA DE GARRA	1K0 615 423 M , 1K0 615 423 H , 1K0 615 423 C , 1K0 615 423	24.3414-1709.7
	1,9 TDI	TD	05.2007	06.2009	24.3414-1710.5	240835	PINZA DE GARRA	1K0 615 424 M , 1K0 615 424 H , 1K0 615 424 C , 1K0 615 424	24.3414-1710.7-
		TI	05.2007	06.2009	24.3414-1709.5	240834	PINZA DE GARRA	1K0 615 423 M , 1K0 615 423 H , 1K0 615 423 C , 1K0 615 423	24.3414-1709.7
	1,9 TDI 4motion	TD	12.2007	06.2009	24.3414-1710.5	240835	PINZA DE GARRA	1K0 615 424 M , 1K0 615 424 H , 1K0 615 424 C , 1K0 615 424	24.3414-1710.7-
		TI	12.2007	06.2009	24.3414-1709.5	240834	PINZA DE GARRA	1K0 615 423 M , 1K0 615 423 H , 1K0 615 423 C , 1K0 615 423	24.3414-1709.7
	2	TD	06.2007	06.2009	24.3414-1710.5	240835	PINZA DE GARRA	1K0 615 424 M , 1K0 615 424 H , 1K0 615 424 C , 1K0 615 424	24.3414-1710.7-
		TI	06.2007	06.2009	24.3414-1709.5	240834	PINZA DE GARRA	1K0 615 423 M , 1K0 615 423 H , 1K0 615 423 C , 1K0 615 423	24.3414-1709.7
	2,0 TDI	TD	05.2007	06.2009	24.3414-1710.5	240835	PINZA DE GARRA	1K0 615 424 M , 1K0 615 424 H , 1K0 615 424 C , 1K0 615 424	24.3414-1710.7-
		TI	05.2007	06.2009	24.3414-1709.5	240834	PINZA DE GARRA	1K0 615 423 M , 1K0 615 423 H , 1K0 615 423 C , 1K0 615 423	24.3414-1709.7
GOLF VI (08-)	1,2 TSI	TD	05.2009	10.2009	24.3414-1710.5	240835	PINZA DE GARRA	1K0 615 424 M , 1K0 615 424 H , 1K0 615 424 C , 1K0 615 424	24.3414-1710.7-
		TI	05.2009	10.2009	24.3414-1709.5	240834	PINZA DE GARRA	1K0 615 423 M , 1K0 615 423 H , 1K0 615 423 C , 1K0 615 423	24.3414-1709.7



Denominación

Ref. OE correspondientes a las referencias ATE

Referencia anterior / varios

VOLKSWAGEN

GOLF VI (08-)	1,4	TD	10.2008	10.2009	24.3414-1710.5	240835	PINZA DE GARRA	1K0 615 424 M , 1K0 615 424 H , 1K0 615 424 C , 1K0 615 424	24.3414-1710.7-
		TI	10.2008	10.2009	24.3414-1709.5	240834	PINZA DE GARRA	1K0 615 423 M , 1K0 615 423 H , 1K0 615 423 C , 1K0 615 423	24.3414-1709.7
	1,4 TSI	TD	10.2008	10.2009	24.3414-1710.5	240835	PINZA DE GARRA	1K0 615 424 M , 1K0 615 424 H , 1K0 615 424 C , 1K0 615 424	24.3414-1710.7-
		TI	10.2008	10.2009	24.3414-1709.5	240834	PINZA DE GARRA	1K0 615 423 M , 1K0 615 423 H , 1K0 615 423 C , 1K0 615 423	24.3414-1709.7
	1,6	TD	10.2008	10.2009	24.3414-1710.5	240835	PINZA DE GARRA	1K0 615 424 M , 1K0 615 424 H , 1K0 615 424 C , 1K0 615 424	24.3414-1710.7-
		TI	10.2008	10.2009	24.3414-1709.5	240834	PINZA DE GARRA	1K0 615 423 M , 1K0 615 423 H , 1K0 615 423 C , 1K0 615 423	24.3414-1709.7
	1,6 BiFuel	TD	03.2009	10.2009	24.3414-1710.5	240835	PINZA DE GARRA	1K0 615 424 M , 1K0 615 424 H , 1K0 615 424 C , 1K0 615 424	24.3414-1710.7-
		TI	03.2009	10.2009	24.3414-1709.5	240834	PINZA DE GARRA	1K0 615 423 M , 1K0 615 423 H , 1K0 615 423 C , 1K0 615 423	24.3414-1709.7
	1,6 TDI	TD	02.2009	10.2009	24.3414-1710.5	240835	PINZA DE GARRA	1K0 615 424 M , 1K0 615 424 H , 1K0 615 424 C , 1K0 615 424	24.3414-1710.7-
		TI	02.2009	10.2009	24.3414-1709.5	240834	PINZA DE GARRA	1K0 615 423 M , 1K0 615 423 H , 1K0 615 423 C , 1K0 615 423	24.3414-1709.7
	1,8 TSI	TD	06.2009	10.2009	24.3414-1710.5	240835	PINZA DE GARRA	1K0 615 424 M , 1K0 615 424 H , 1K0 615 424 C , 1K0 615 424	24.3414-1710.7-



Denominación

Ref. OE correspondientes a las referencias ATE



Referencia anterior / varios

VOLKSWAGEN

Modelo	Motor	TI	Inicio	Fin	ATE Ref. 1	ATE Ref. 2	Denominación	Ref. OE correspondientes a las referencias ATE	Referencia anterior / varios
GOLF VI (08-)	1,8 TSI	TI	06.2009	10.2009	24.3414-1709.5	240834	PINZA DE GARRA	1K0 615 423 M , 1K0 615 423 H , 1K0 615 423 C , 1K0 615 423	24.3414-1709.7
	2,0 GTi	TD	04.2009	10.2009	24.3414-1710.5	240835	PINZA DE GARRA	1K0 615 424 M , 1K0 615 424 H , 1K0 615 424 C , 1K0 615 424	24.3414-1710.7-
		TI	04.2009	10.2009	24.3414-1709.5	240834	PINZA DE GARRA	1K0 615 423 M , 1K0 615 423 H , 1K0 615 423 C , 1K0 615 423	24.3414-1709.7
	2,0 TDI	TD	04.2009	10.2009	24.3414-1710.5	240835	PINZA DE GARRA	1K0 615 424 M , 1K0 615 424 H , 1K0 615 424 C , 1K0 615 424	24.3414-1710.7-
		TD	10.2008	10.2009	24.3414-1710.5	240835	PINZA DE GARRA	1K0 615 424 M , 1K0 615 424 H , 1K0 615 424 C , 1K0 615 424	24.3414-1710.7-
		TI	04.2009	10.2009	24.3414-1709.5	240834	PINZA DE GARRA	1K0 615 423 M , 1K0 615 423 H , 1K0 615 423 C , 1K0 615 423	24.3414-1709.7
		TI	10.2008	10.2009	24.3414-1709.5	240834	PINZA DE GARRA	1K0 615 423 M , 1K0 615 423 H , 1K0 615 423 C , 1K0 615 423	24.3414-1709.7
	2,0 TDI 4motion	TD	10.2008	10.2009	24.3414-1710.5	240835	PINZA DE GARRA	1K0 615 424 M , 1K0 615 424 H , 1K0 615 424 C , 1K0 615 424	24.3414-1710.7-
		TI	10.2008	10.2009	24.3414-1709.5	240834	PINZA DE GARRA	1K0 615 423 M , 1K0 615 423 H , 1K0 615 423 C , 1K0 615 423	24.3414-1709.7
GOLF VI Variant (09-)	1,2 TSI	TD	08.2009		24.3414-1710.5	240835	PINZA DE GARRA	1K0 615 424 M , 1K0 615 424 H , 1K0 615 424 C , 1K0 615 424	24.3414-1710.7-
		TI	08.2009		24.3414-1709.5	240834	PINZA DE GARRA	1K0 615 423 M , 1K0 615 423 H , 1K0 615 423 C , 1K0 615 423	24.3414-1709.7



Denominación

Ref. OE correspondientes a las referencias ATE



Referencia anterior / varios

VOLKSWAGEN

GOLF VI Variant (09-)	1,4	TD	07.2009		24.3414-1710.5	240835	PINZA DE GARRA	1K0 615 424 M , 1K0 615 424 H , 1K0 615 424 C , 1K0 615 424	24.3414-1710.7-
		TI	07.2009		24.3414-1709.5	240834	PINZA DE GARRA	1K0 615 423 M , 1K0 615 423 H , 1K0 615 423 C , 1K0 615 423	24.3414-1709.7
	1,4 TSI	TD	07.2009		24.3414-1710.5	240835	PINZA DE GARRA	1K0 615 424 M , 1K0 615 424 H , 1K0 615 424 C , 1K0 615 424	24.3414-1710.7-
		TI	07.2009		24.3414-1709.5	240834	PINZA DE GARRA	1K0 615 423 M , 1K0 615 423 H , 1K0 615 423 C , 1K0 615 423	24.3414-1709.7
	1,6	TD	07.2009		24.3414-1710.5	240835	PINZA DE GARRA	1K0 615 424 M , 1K0 615 424 H , 1K0 615 424 C , 1K0 615 424	24.3414-1710.7-
		TI	07.2009		24.3414-1709.5	240834	PINZA DE GARRA	1K0 615 423 M , 1K0 615 423 H , 1K0 615 423 C , 1K0 615 423	24.3414-1709.7
	1,6 MultiFuel	TD	07.2009		24.3414-1710.5	240835	PINZA DE GARRA	1K0 615 424 M , 1K0 615 424 H , 1K0 615 424 C , 1K0 615 424	24.3414-1710.7-
		TI	07.2009		24.3414-1709.5	240834	PINZA DE GARRA	1K0 615 423 M , 1K0 615 423 H , 1K0 615 423 C , 1K0 615 423	24.3414-1709.7
	1,6 TDI	TD	07.2009		24.3414-1710.5	240835	PINZA DE GARRA	1K0 615 424 M , 1K0 615 424 H , 1K0 615 424 C , 1K0 615 424	24.3414-1710.7-
		TI	07.2009		24.3414-1709.5	240834	PINZA DE GARRA	1K0 615 423 M , 1K0 615 423 H , 1K0 615 423 C , 1K0 615 423	24.3414-1709.7
	1,6 TDI 4motion	TD	07.2009		24.3414-1710.5	240835	PINZA DE GARRA	1K0 615 424 M , 1K0 615 424 H , 1K0 615 424 C , 1K0 615 424	24.3414-1710.7-



Denominación

Ref. OE correspondientes a las referencias ATE



Referencia anterior / varios

VOLKSWAGEN

GOLF VI Variant (09-)	1,6 TDI 4motion	TI	07.2009		24.3414-1709.5	240834	PINZA DE GARRA	1K0 615 423 M , 1K0 615 423 H , 1K0 615 423 C , 1K0 615 423	24.3414-1709.7
	2	TD	07.2009		24.3414-1710.5	240835	PINZA DE GARRA	1K0 615 424 M , 1K0 615 424 H , 1K0 615 424 C , 1K0 615 424	24.3414-1710.7-
		TI	07.2009		24.3414-1709.5	240834	PINZA DE GARRA	1K0 615 423 M , 1K0 615 423 H , 1K0 615 423 C , 1K0 615 423	24.3414-1709.7
	2,0 TDI	TD	07.2009		24.3414-1710.5	240835	PINZA DE GARRA	1K0 615 424 M , 1K0 615 424 H , 1K0 615 424 C , 1K0 615 424	24.3414-1710.7-
		TI	07.2009		24.3414-1709.5	240834	PINZA DE GARRA	1K0 615 423 M , 1K0 615 423 H , 1K0 615 423 C , 1K0 615 423	24.3414-1709.7
JETTA V (05-10)	1,4 TSI	TD	05.2007	10.2010	24.3414-1710.5	240835	PINZA DE GARRA	1K0 615 424 M , 1K0 615 424 H , 1K0 615 424 C , 1K0 615 424	24.3414-1710.7-
		TD	06.2006	10.2010	24.3414-1710.5	240835	PINZA DE GARRA	1K0 615 424 M , 1K0 615 424 H , 1K0 615 424 C , 1K0 615 424	24.3414-1710.7-
		TI	06.2006	10.2010	24.3414-1709.5	240834	PINZA DE GARRA	1K0 615 423 M , 1K0 615 423 H , 1K0 615 423 C , 1K0 615 423	24.3414-1709.7
		TI	05.2007	10.2010	24.3414-1709.5	240834	PINZA DE GARRA	1K0 615 423 M , 1K0 615 423 H , 1K0 615 423 C , 1K0 615 423	24.3414-1709.7
		TI	07.2008	10.2010	24.3414-1709.5	240834	PINZA DE GARRA	1K0 615 423 M , 1K0 615 423 H , 1K0 615 423 C , 1K0 615 423	24.3414-1709.7
		TD	07.2008	10.2010	24.3414-1710.5	240835	PINZA DE GARRA	1K0 615 424 M , 1K0 615 424 H , 1K0 615 424 C , 1K0 615 424	24.3414-1710.7-



Denominación

Ref. OE correspondientes a las referencias ATE



Referencia anterior / varios

VOLKSWAGEN

Modelo	Motor	Config	Fecha 1	Fecha 2	Ref. 1	Ref. 2	Denominación	Ref. OE correspondientes a las referencias ATE	Referencia anterior / varios
JETTA V (05-10)	1,6 FSI	TD	08.2005	10.2010	24.3414-1710.5	240835	PINZA DE GARRA	1K0 615 424 M , 1K0 615 424 H , 1K0 615 424 C , 1K0 615 424	24.3414-1710.7-
		TI	08.2005	10.2010	24.3414-1709.5	240834	PINZA DE GARRA	1K0 615 423 M , 1K0 615 423 H , 1K0 615 423 C , 1K0 615 423	24.3414-1709.7
	1,6 i 16V	TD	08.2005	10.2010	24.3414-1710.5	240835	PINZA DE GARRA	1K0 615 424 M , 1K0 615 424 H , 1K0 615 424 C , 1K0 615 424	24.3414-1710.7-
		TI	08.2005	10.2010	24.3414-1709.5	240834	PINZA DE GARRA	1K0 615 423 M , 1K0 615 423 H , 1K0 615 423 C , 1K0 615 423	24.3414-1709.7
	1,6 TDI	TD	06.2009	10.2010	24.3414-1710.5	240835	PINZA DE GARRA	1K0 615 424 M , 1K0 615 424 H , 1K0 615 424 C , 1K0 615 424	24.3414-1710.7-
		TI	06.2009	10.2010	24.3414-1709.5	240834	PINZA DE GARRA	1K0 615 423 M , 1K0 615 423 H , 1K0 615 423 C , 1K0 615 423	24.3414-1709.7
	1,9 TDI	TD	08.2005	10.2010	24.3414-1710.5	240835	PINZA DE GARRA	1K0 615 424 M , 1K0 615 424 H , 1K0 615 424 C , 1K0 615 424	24.3414-1710.7-
		TI	08.2005	10.2010	24.3414-1709.5	240834	PINZA DE GARRA	1K0 615 423 M , 1K0 615 423 H , 1K0 615 423 C , 1K0 615 423	24.3414-1709.7
	2,0 FSI	TD	08.2005	10.2010	24.3414-1710.5	240835	PINZA DE GARRA	1K0 615 424 M , 1K0 615 424 H , 1K0 615 424 C , 1K0 615 424	24.3414-1710.7-
		TI	08.2005	10.2010	24.3414-1709.5	240834	PINZA DE GARRA	1K0 615 423 M , 1K0 615 423 H , 1K0 615 423 C , 1K0 615 423	24.3414-1709.7
	2,0 TDI	TD	06.2006	10.2010	24.3414-1710.5	240835	PINZA DE GARRA	1K0 615 424 M , 1K0 615 424 H , 1K0 615 424 C , 1K0 615 424	24.3414-1710.7-



Denominación

Ref. OE correspondientes a las referencias ATE



Referencia anterior / varios

VOLKSWAGEN

Modelo	Motor	TD	09.2005	10.2010	24.3414-1710.5	240835	Denominación	Ref. OE correspondientes a las referencias ATE	Referencia anterior / varios
JETTA V (05-10)	2,0 TDI	TD	09.2005	10.2010	24.3414-1710.5	240835	PINZA DE GARRA	1K0 615 424 M , 1K0 615 424 H , 1K0 615 424 C , 1K0 615 424	24.3414-1710.7-
		TD	08.2005	10.2010	24.3414-1710.5	240835	PINZA DE GARRA	1K0 615 424 M , 1K0 615 424 H , 1K0 615 424 C , 1K0 615 424	24.3414-1710.7-
		TI	09.2005	10.2010	24.3414-1709.5	240834	PINZA DE GARRA	1K0 615 423 M , 1K0 615 423 H , 1K0 615 423 C , 1K0 615 423	24.3414-1709.7
		TI	08.2005	10.2010	24.3414-1709.5	240834	PINZA DE GARRA	1K0 615 423 M , 1K0 615 423 H , 1K0 615 423 C , 1K0 615 423	24.3414-1709.7
		TI	06.2006	10.2010	24.3414-1709.5	240834	PINZA DE GARRA	1K0 615 423 M , 1K0 615 423 H , 1K0 615 423 C , 1K0 615 423	24.3414-1709.7
	2,0 TFSI	TD	10.2005	10.2010	24.3414-1710.5	240835	PINZA DE GARRA	1K0 615 424 M , 1K0 615 424 H , 1K0 615 424 C , 1K0 615 424	24.3414-1710.7-
		TI	10.2005	10.2010	24.3414-1709.5	240834	PINZA DE GARRA	1K0 615 423 M , 1K0 615 423 H , 1K0 615 423 C , 1K0 615 423	24.3414-1709.7
	2,5 FSI	TD	07.2008	10.2010	24.3414-1710.5	240835	PINZA DE GARRA	1K0 615 424 M , 1K0 615 424 H , 1K0 615 424 C , 1K0 615 424	24.3414-1710.7-
		TI	07.2008	10.2010	24.3414-1709.5	240834	PINZA DE GARRA	1K0 615 423 M , 1K0 615 423 H , 1K0 615 423 C , 1K0 615 423	24.3414-1709.7
POLO IV (02-09)	1,2	TD	11.2001	05.2009	24.3344-1710.5	240811	PINZA DE GARRA	6Q0 615 424 B , 6Q0 615 424 A	
		TD	04.2007	05.2009	24.3344-1710.5	240811	PINZA DE GARRA	6Q0 615 424 B , 6Q0 615 424 A	
	1,4 16V	TD	05.2006	05.2009	24.3344-1710.5	240811	PINZA DE GARRA	6Q0 615 424 B , 6Q0 615 424 A	



Denominación

Ref. OE correspondientes a las referencias ATE

Referencia anterior / varios

VOLKSWAGEN

Modelo	Motor	Transmisión	Fecha inicio	Fecha fin	Código ATE	Código OE	Denominación	Ref. OE correspondientes a las referencias ATE	Referencia anterior / varios
POLO IV (02-09)	1,4 16V	TD	11.2001	05.2009	24.3344-1710.5	240811	PINZA DE GARRA	6Q0 615 424 B , 6Q0 615 424 A	
	1,4 FSI	TD	11.2001	05.2009	24.3344-1710.5	240811	PINZA DE GARRA	6Q0 615 424 B , 6Q0 615 424 A	
	1,4 TDI	TD	11.2001	05.2009	24.3344-1710.5	240811	PINZA DE GARRA	6Q0 615 424 B , 6Q0 615 424 A	
	1,6 16V	TD	05.2006	05.2009	24.3344-1710.5	240811	PINZA DE GARRA	6Q0 615 424 B , 6Q0 615 424 A	
	1,8 GTI	TD	09.2005	05.2009	24.3344-1710.5	240811	PINZA DE GARRA	6Q0 615 424 B , 6Q0 615 424 A	
		TD	06.2006	05.2009	24.3344-1710.5	240811	PINZA DE GARRA	6Q0 615 424 B , 6Q0 615 424 A	
	1,9 TDI	TD	10.2003	05.2009	24.3344-1710.5	240811	PINZA DE GARRA	6Q0 615 424 B , 6Q0 615 424 A	
		TD	11.2001	05.2009	24.3344-1710.5	240811	PINZA DE GARRA	6Q0 615 424 B , 6Q0 615 424 A	
	2	TD	04.2002	05.2009	24.3344-1710.5	240811	PINZA DE GARRA	6Q0 615 424 B , 6Q0 615 424 A	
SCIROCCO (08-)	1,4 TSI	TD	09.2008		24.3414-1710.5	240835	PINZA DE GARRA	1K0 615 424 M , 1K0 615 424 H , 1K0 615 424 C , 1K0 615 424	24.3414-1710.7-
		TI	09.2008		24.3414-1709.5	240834	PINZA DE GARRA	1K0 615 423 M , 1K0 615 423 H , 1K0 615 423 C , 1K0 615 423	24.3414-1709.7
		TI	11.2013		24.3414-1709.5	240834	PINZA DE GARRA	1K0 615 423 M , 1K0 615 423 H , 1K0 615 423 C , 1K0 615 423	24.3414-1709.7
		TD	11.2013		24.3414-1710.5	240835	PINZA DE GARRA	1K0 615 424 M , 1K0 615 424 H , 1K0 615 424 C , 1K0 615 424	24.3414-1710.7-



Denominación

Ref. OE correspondientes a las referencias ATE

Referencia anterior / varios

VOLKSWAGEN

Modelo	Motor	Transmisión	Fecha	Referencia ATE	Referencia OE	Denominación	Ref. OE correspondientes a las referencias ATE	Referencia anterior / varios
SCIROCCO (08-)	1,4 TSI	TD	08.2008	24.3414-1710.5	240835	PINZA DE GARRA	1K0 615 424 M , 1K0 615 424 H , 1K0 615 424 C , 1K0 615 424	24.3414-1710.7-
		TI	08.2008	24.3414-1709.5	240834	PINZA DE GARRA	1K0 615 423 M , 1K0 615 423 H , 1K0 615 423 C , 1K0 615 423	24.3414-1709.7
	2,0 R	TI	11.2009	24.3414-1709.5	240834	PINZA DE GARRA	1K0 615 423 M , 1K0 615 423 H , 1K0 615 423 C , 1K0 615 423	24.3414-1709.7
		TI	08.2014	24.3414-1709.5	240834	PINZA DE GARRA	1K0 615 423 M , 1K0 615 423 H , 1K0 615 423 C , 1K0 615 423	24.3414-1709.7
		TD	11.2009	24.3414-1710.5	240835	PINZA DE GARRA	1K0 615 424 M , 1K0 615 424 H , 1K0 615 424 C , 1K0 615 424	24.3414-1710.7-
		TD	08.2014	24.3414-1710.5	240835	PINZA DE GARRA	1K0 615 424 M , 1K0 615 424 H , 1K0 615 424 C , 1K0 615 424	24.3414-1710.7-
	2,0 TDI	TD	10.2008	24.3414-1710.5	240835	PINZA DE GARRA	1K0 615 424 M , 1K0 615 424 H , 1K0 615 424 C , 1K0 615 424	24.3414-1710.7-
		TD	05.2009	24.3414-1710.5	240835	PINZA DE GARRA	1K0 615 424 M , 1K0 615 424 H , 1K0 615 424 C , 1K0 615 424	24.3414-1710.7-
		TD	01.2013	24.3414-1710.5	240835	PINZA DE GARRA	1K0 615 424 M , 1K0 615 424 H , 1K0 615 424 C , 1K0 615 424	24.3414-1710.7-
		TD	11.2013	24.3414-1710.5	240835	PINZA DE GARRA	1K0 615 424 M , 1K0 615 424 H , 1K0 615 424 C , 1K0 615 424	24.3414-1710.7-
		TI	11.2013	24.3414-1709.5	240834	PINZA DE GARRA	1K0 615 423 M , 1K0 615 423 H , 1K0 615 423 C , 1K0 615 423	24.3414-1709.7



Denominación

Ref. OE correspondientes a las referencias ATE

Referencia anterior / varios

VOLKSWAGEN

SCIROCCO (08-)	2,0 TDI	TI	05.2009		24.3414-1709.5	240834	PINZA DE GARRA	1K0 615 423 M , 1K0 615 423 H , 1K0 615 423 C , 1K0 615 423	24.3414-1709.7
		TI	10.2008		24.3414-1709.5	240834	PINZA DE GARRA	1K0 615 423 M , 1K0 615 423 H , 1K0 615 423 C , 1K0 615 423	24.3414-1709.7
		TI	01.2013		24.3414-1709.5	240834	PINZA DE GARRA	1K0 615 423 M , 1K0 615 423 H , 1K0 615 423 C , 1K0 615 423	24.3414-1709.7
	2,0 TSI	TI	11.2013		24.3414-1709.5	240834	PINZA DE GARRA	1K0 615 423 M , 1K0 615 423 H , 1K0 615 423 C , 1K0 615 423	24.3414-1709.7
		TD	08.2008		24.3414-1710.5	240835	PINZA DE GARRA	1K0 615 424 M , 1K0 615 424 H , 1K0 615 424 C , 1K0 615 424	24.3414-1710.7-
		TD	11.2013		24.3414-1710.5	240835	PINZA DE GARRA	1K0 615 424 M , 1K0 615 424 H , 1K0 615 424 C , 1K0 615 424	24.3414-1710.7-
		TI	11.2009		24.3414-1709.5	240834	PINZA DE GARRA	1K0 615 423 M , 1K0 615 423 H , 1K0 615 423 C , 1K0 615 423	24.3414-1709.7
		TD	11.2009		24.3414-1710.5	240835	PINZA DE GARRA	1K0 615 424 M , 1K0 615 424 H , 1K0 615 424 C , 1K0 615 424	24.3414-1710.7-
		TI	08.2008		24.3414-1709.5	240834	PINZA DE GARRA	1K0 615 423 M , 1K0 615 423 H , 1K0 615 423 C , 1K0 615 423	24.3414-1709.7
TOURAN I (03-15)	1,2 TSI	TI	05.2010		24.3414-1709.5	240834	PINZA DE GARRA	1K0 615 423 M , 1K0 615 423 H , 1K0 615 423 C , 1K0 615 423	24.3414-1709.7
		TD	05.2010		24.3414-1710.5	240835	PINZA DE GARRA	1K0 615 424 M , 1K0 615 424 H , 1K0 615 424 C , 1K0 615 424	24.3414-1710.7-



Denominación

Ref. OE correspondientes a las referencias ATE

Referencia anterior / varios

VOLKSWAGEN

Modelo	Motor	TI	Fecha	Ref. ATE	Ref. OE	Denominación	Ref. OE correspondientes a las referencias ATE	Referencia anterior / varios
TOURAN I (03-15)	1,4 TSI	TI	09.2006	24.3414-1709.5	240834	PINZA DE GARRA	1K0 615 423 M , 1K0 615 423 H , 1K0 615 423 C , 1K0 615 423	24.3414-1709.7
		TI	11.2006	24.3414-1709.5	240834	PINZA DE GARRA	1K0 615 423 M , 1K0 615 423 H , 1K0 615 423 C , 1K0 615 423	24.3414-1709.7
		TD	11.2006	24.3414-1710.5	240835	PINZA DE GARRA	1K0 615 424 M , 1K0 615 424 H , 1K0 615 424 C , 1K0 615 424	24.3414-1710.7-
		TD	09.2006	24.3414-1710.5	240835	PINZA DE GARRA	1K0 615 424 M , 1K0 615 424 H , 1K0 615 424 C , 1K0 615 424	24.3414-1710.7-
	1,4 TSI EcoFuel	TD	05.2009	24.3414-1710.5	240835	PINZA DE GARRA	1K0 615 424 M , 1K0 615 424 H , 1K0 615 424 C , 1K0 615 424	24.3414-1710.7-
		TI	05.2009	24.3414-1709.5	240834	PINZA DE GARRA	1K0 615 423 M , 1K0 615 423 H , 1K0 615 423 C , 1K0 615 423	24.3414-1709.7
	1,6	TD	07.2003	24.3414-1710.5	240835	PINZA DE GARRA	1K0 615 424 M , 1K0 615 424 H , 1K0 615 424 C , 1K0 615 424	24.3414-1710.7-
		TI	07.2003	24.3414-1709.5	240834	PINZA DE GARRA	1K0 615 423 M , 1K0 615 423 H , 1K0 615 423 C , 1K0 615 423	24.3414-1709.7
	1,6 FSI	TD	02.2003	24.3414-1710.5	240835	PINZA DE GARRA	1K0 615 424 M , 1K0 615 424 H , 1K0 615 424 C , 1K0 615 424	24.3414-1710.7-
		TI	02.2003	24.3414-1709.5	240834	PINZA DE GARRA	1K0 615 423 M , 1K0 615 423 H , 1K0 615 423 C , 1K0 615 423	24.3414-1709.7
	1,6 TDI	TD	05.2010	24.3414-1710.5	240835	PINZA DE GARRA	1K0 615 424 M , 1K0 615 424 H , 1K0 615 424 C , 1K0 615 424	24.3414-1710.7-



Denominación

Ref. OE correspondientes a las referencias ATE



Referencia anterior / varios

VOLKSWAGEN

Modelo	Motor	Transmisión	Fecha	Ref. ATE	Ref. OE	Denominación	Ref. OE correspondientes a las referencias ATE	Referencia anterior / varios
TOURAN I (03-15)	1,6 TDI	TI	05.2010	24.3414-1709.5	240834	PINZA DE GARRA	1K0 615 423 M , 1K0 615 423 H , 1K0 615 423 C , 1K0 615 423	24.3414-1709.7
	1,9 TDI	TD	11.2004	24.3414-1710.5	240835	PINZA DE GARRA	1K0 615 424 M , 1K0 615 424 H , 1K0 615 424 C , 1K0 615 424	24.3414-1710.7-
		TI	08.2003	24.3414-1709.5	240834	PINZA DE GARRA	1K0 615 423 M , 1K0 615 423 H , 1K0 615 423 C , 1K0 615 423	24.3414-1709.7
		TI	02.2003	24.3414-1709.5	240834	PINZA DE GARRA	1K0 615 423 M , 1K0 615 423 H , 1K0 615 423 C , 1K0 615 423	24.3414-1709.7
		TD	08.2003	24.3414-1710.5	240835	PINZA DE GARRA	1K0 615 424 M , 1K0 615 424 H , 1K0 615 424 C , 1K0 615 424	24.3414-1710.7-
		TI	11.2004	24.3414-1709.5	240834	PINZA DE GARRA	1K0 615 423 M , 1K0 615 423 H , 1K0 615 423 C , 1K0 615 423	24.3414-1709.7
		TD	02.2003	24.3414-1710.5	240835	PINZA DE GARRA	1K0 615 424 M , 1K0 615 424 H , 1K0 615 424 C , 1K0 615 424	24.3414-1710.7-
	2,0 Eco Fuel	TD	02.2006	24.3414-1710.5	240835	PINZA DE GARRA	1K0 615 424 M , 1K0 615 424 H , 1K0 615 424 C , 1K0 615 424	24.3414-1710.7-
		TI	02.2006	24.3414-1709.5	240834	PINZA DE GARRA	1K0 615 423 M , 1K0 615 423 H , 1K0 615 423 C , 1K0 615 423	24.3414-1709.7
	2,0 FSI	TD	10.2003	24.3414-1710.5	240835	PINZA DE GARRA	1K0 615 424 M , 1K0 615 424 H , 1K0 615 424 C , 1K0 615 424	24.3414-1710.7-
		TD	10.2004	24.3414-1710.5	240835	PINZA DE GARRA	1K0 615 424 M , 1K0 615 424 H , 1K0 615 424 C , 1K0 615 424	24.3414-1710.7-



Denominación

Ref. OE correspondientes a las referencias ATE



Referencia anterior / varios

VOLKSWAGEN

Modelo	Motor	TI	Fecha	Ref. ATE	Ref. OE	Denominación	Ref. OE correspondientes a las referencias ATE	Referencia anterior / varios
TOURAN I (03-15)	2,0 FSI	TI	10.2003	24.3414-1709.5	240834	PINZA DE GARRA	1K0 615 423 M , 1K0 615 423 H , 1K0 615 423 C , 1K0 615 423	24.3414-1709.7
		TI	10.2004	24.3414-1709.5	240834	PINZA DE GARRA	1K0 615 423 M , 1K0 615 423 H , 1K0 615 423 C , 1K0 615 423	24.3414-1709.7
	2,0 TDI	TI	02.2003	24.3414-1709.5	240834	PINZA DE GARRA	1K0 615 423 M , 1K0 615 423 H , 1K0 615 423 C , 1K0 615 423	24.3414-1709.7
		TD	02.2003	24.3414-1710.5	240835	PINZA DE GARRA	1K0 615 424 M , 1K0 615 424 H , 1K0 615 424 C , 1K0 615 424	24.3414-1710.7-
		TI	08.2003	24.3414-1709.5	240834	PINZA DE GARRA	1K0 615 423 M , 1K0 615 423 H , 1K0 615 423 C , 1K0 615 423	24.3414-1709.7
		TD	02.2006	24.3414-1710.5	240835	PINZA DE GARRA	1K0 615 424 M , 1K0 615 424 H , 1K0 615 424 C , 1K0 615 424	24.3414-1710.7-
		TD	08.2003	24.3414-1710.5	240835	PINZA DE GARRA	1K0 615 424 M , 1K0 615 424 H , 1K0 615 424 C , 1K0 615 424	24.3414-1710.7-
		TI	02.2006	24.3414-1709.5	240834	PINZA DE GARRA	1K0 615 423 M , 1K0 615 423 H , 1K0 615 423 C , 1K0 615 423	24.3414-1709.7



Denominación

Ref. OE correspondientes a las referencias ATE

Referencia anterior / varios

VOLVO

V40 (12-)	D2		02.2015		24.0125-0203.1	425203	DISCO DE FRENO	31341642 , 31381374	
			09.2012		24.0125-0203.1	425203	DISCO DE FRENO	31341642 , 31381374	
	D3		09.2012		24.0125-0203.1	425203	DISCO DE FRENO	31341642 , 31381374	
	D4		05.2014		24.0125-0203.1	425203	DISCO DE FRENO	31341642 , 31381374	
			09.2012		24.0125-0203.1	425203	DISCO DE FRENO	31341642 , 31381374	
	T2		02.2015		24.0125-0203.1	425203	DISCO DE FRENO	31341642 , 31381374	
	T3		02.2015		24.0125-0203.1	425203	DISCO DE FRENO	31341642 , 31381374	
	T3 GTDi		09.2012		24.0125-0203.1	425203	DISCO DE FRENO	31341642 , 31381374	
	T4		08.2015		24.0125-0203.1	425203	DISCO DE FRENO	31341642 , 31381374	
	T4 GTDi		09.2012		24.0125-0203.1	425203	DISCO DE FRENO	31341642 , 31381374	
	T5		03.2013		24.0125-0203.1	425203	DISCO DE FRENO	31341642 , 31381374	
			05.2014		24.0125-0203.1	425203	DISCO DE FRENO	31341642 , 31381374	
	T5 AWD		05.2014		24.0125-0203.1	425203	DISCO DE FRENO	31341642 , 31381374	
			03.2013		24.0125-0203.1	425203	DISCO DE FRENO	31341642 , 31381374	

13.0460-7315.2 607315

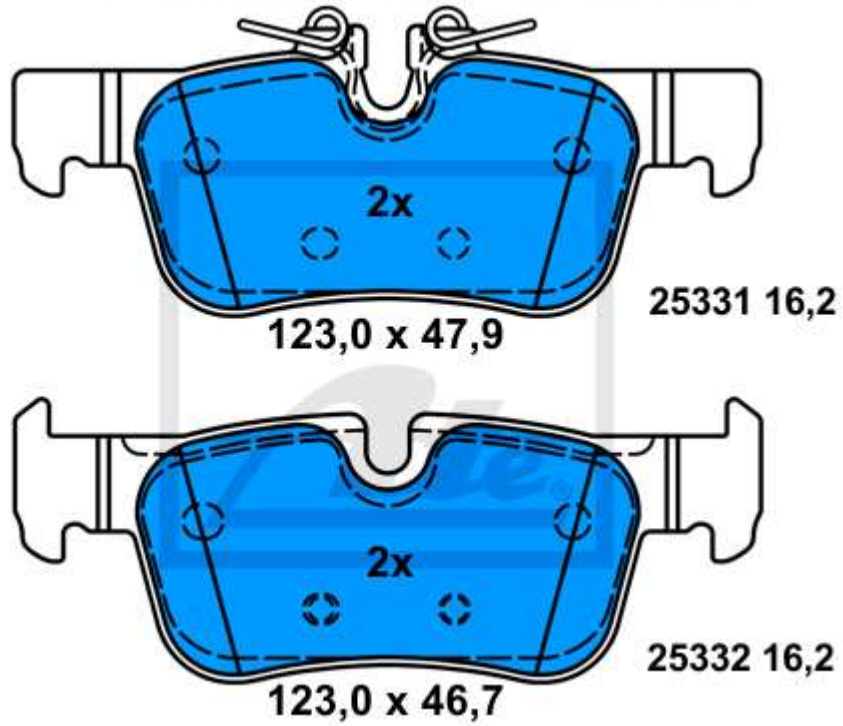

Aplicación:

BMW 2er Reihe/F45 Active Tourer (14-)
BMW 2er Reihe/F46 Gran Tourer (15-)
MINI F54 Clubman (15-)
MINI F60 Countryman (17-)
BMW i3/i01 (13-)
BMW X1/F48 (15-)