

# When it comes to braking, we give our all. And more.

High-quality spare parts  
and services for the  
entire brake system



**Brakethrough Technology**



# Always looking ahead

We are brake specialists, but we're also acceleration experts, because we regularly introduce ground-breaking developments. We want to make the best better and focus on the future for our partners. This is what ATE stands for: Brakethrough Technology.

## Contents

The brake specialist	4
Our programme	6
ATE quality	8
Wear parts	10
Hydraulic parts	18
Brake fluids	22
Electronic components	24
Clutch parts	26
ATE Classic	28
Tools	32
Services	34

The brake specialist

# Trailblazing



## Innovation as a tradition

We've been working with brake systems for more than 100 years. We have brought numerous innovations to the market – from the hydraulic brake to ABS. And we keep going too ...

As part of the Continental Group, one of the largest international automotive suppliers, we have expertise in the entire automotive sector. We can draw on a global network, in which more than 200,000 people are already working today on the solutions of tomorrow. With our extensive product range and additional know-how, like that of the electronics and mechatronics specialist VDO, we are a truly reliable partner for workshops and the automotive industry – today and in the future. Whether it's for OE or for spare parts and services.

1906

Alfred Teves founds the company as a general representative for automotive accessories and presents his products at the IAA.



1926

The Adler Standard 6 is the first car on the continent to drive with a hydraulic braking system, the ATE Lockheed brake.



1951

Teves launches the ATE T50 vacuum brake booster – the Bendix Hydrovac system.

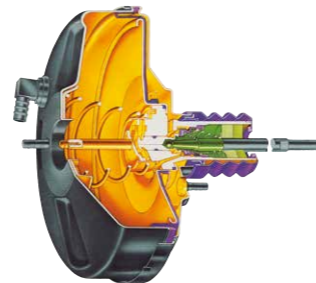

1972

New in serial production – the floating brake calliper in the Audi 80 and the ATE T52 vacuum booster, the first product completely developed by Teves KG.

1980

Teves develops the first production-ready anti-lock braking system – the ABS MK II. The first floating brake calliper in a new design, FN for short, is fitted as standard in the Ford Escort.



1992

The Automotive Stability Management System ASMS is marketed. Today it is known almost everywhere in the world – as ESP®.

1996

A ground-breaking invention – the ATE PowerDisc with patented multifunction groove minimises dust fading and is extremely durable thanks to its score-free abrasion.



2010

Premiere for the innovative, low-dust ATE Ceramic brake pads and for ATE Classic, the spare parts programme for vintage and classic cars.





# We offer more

Our programme

## From one source

ATE spare parts fit perfectly – individually and one with another. And there's more – our tools and numerous services are also tailored to exactly match our products. This lightens your workload, and you can be sure that everything is exactly the way you want it to be – perfect.

Whether it comes to performance, comfort or suitability for daily use, we have the right product for you – and it's always top quality. We also offer you much more than the standard market products – pre-assembled kits, for example, a recycling deposit system for brake callipers or the ATE Classic programme with spare parts for vintage and classic cars.

We also develop brakes for vehicle manufacturers' small production batches and special vehicles, including sports cars, light vehicles, motorcycles, industrial vehicles and agricultural vehicles.

Our product range at a glance:

- | Disc brakes
- | Drum brakes
- | Brake fluids
- | Hydraulic parts
- | Clutch parts
- | Electronic components
- | ATE Classic for classic cars
- | Special tools
- | Comprehensive services



# First-class

ATE quality

## Better is better

When it comes to quality, “very good” is simply not good enough for us. We meet high standards of quality management – and ATE even exceeds the European safety standard ECE-R90. We also perform many additional tests, including wear and thermal performance.

Sustainability is also important to us: we convert the compounds for ATE brake pads to copper-free materials and opt for low abrasion with ATE Ceramic. We only use environmentally friendly material for the coating of brake discs – and we remanufacture products like brake callipers.

## Original? Yes – and safe

For us, quality is not only a key issue during product development and before delivery – after purchase, a two-stage security label lets you check if you have an original ATE product at any time – the tesa Priospot.

Its predecessor, the tesa Holospot®, still offers a very high level of security – but the tesa Priospot® takes security to an entirely new level. With its range of inspection and security mechanisms, this holographic technology cannot be faked and prevents even the label itself from being copied.

The second stage is a Data Matrix code known as the MAPP code. Its last four digits are shown in the Holospot® or Priospot® – for absolute maximum security.

The code can be checked on the ATE website by scanner or by manual input and immediately shows whether or not the part is an original. Verification can also be performed via smartphone if appropriate software like the ATE app is used.

Multi-stage ATE security label with Data Matrix code (centre) and tesa Priospot® (top right).



We are committed to MAPP – Manufacturers against Product Piracy.



To online verification and app download:  
[www.ate-brakes.com/original](http://www.ate-brakes.com/original)



## More tests: ATE brake pads

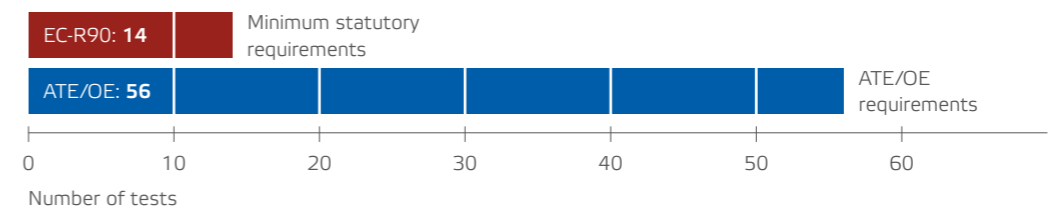



# The safe way

## Wear parts

As specialists for brake systems, we know the high-level requirements of big car brands and their drivers – and this is also shown by the high quality of our wear parts. Our brake pads, brake discs and drum brakes are the premium choice – they are durable, reliable and matched to interact with one another. Our broad market coverage says it all – ATE is the brake specialist!

# Brake pads

## A class of their own



### ATE Original brake pads

Other manufacturers use ten different compounds for their brake pads. We use more than 150 – and our internal tests are far more stringent than required by the regulations. That’s why we offer the optimum brake pad for every type of vehicle – with 98 per cent coverage in Europe, mainly with original equipment manufacturer compounds. So motorists can rely on maximum safety and maximum comfort. There is only one original.

Learn more on our website at [www.ate-brakes.com/originalpad](http://www.ate-brakes.com/originalpad)

### ATE Ceramic brake pads

A clean solution. The innovative ATE Ceramic formula produces very few abraded particles, and they have hardly any adhesive characteristics. This means that hardly any brake dust settles and shiny wheel rims retain their lustre much longer. Ceramic brake pads are as safe as conventional pads, are particularly durable and ideal when used in combination with the coated ATE brake discs. Yet another advantage? They can be easily installed instead of the usual brake pads.

Learn more on our website at [www.ate-brakes.com/ceramic](http://www.ate-brakes.com/ceramic)

### Braking behaviour of ATE Original brake pads

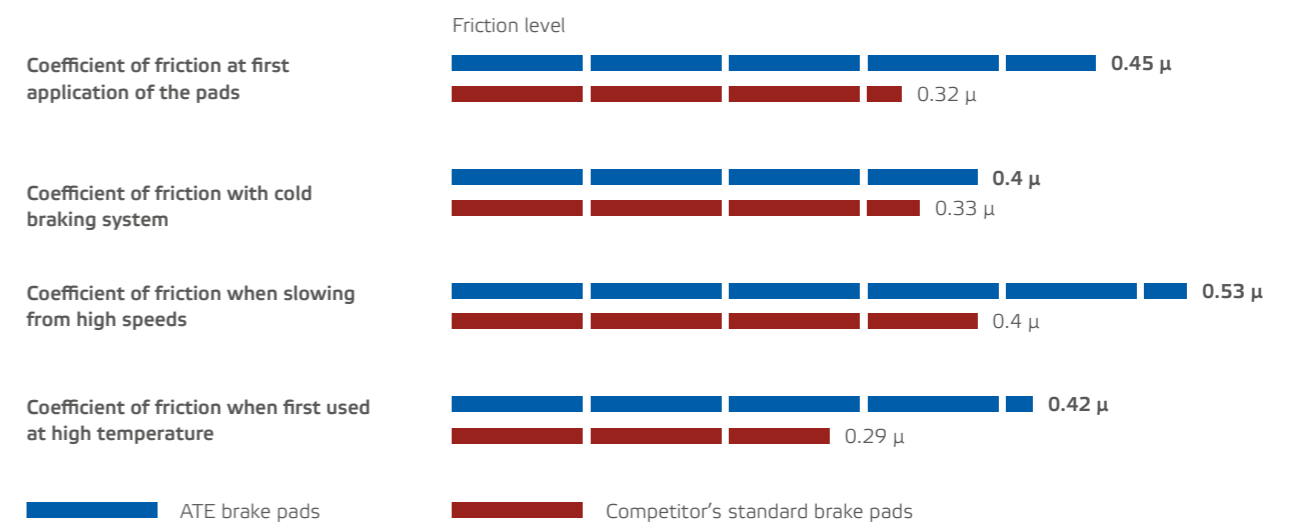

# Brake discs

## The right one for every requirement



### Everything for optimal braking performance

There are so many different vehicle models and requirements – and ATE has the right brake disc for each one. Precisely manufactured from excellent OEM materials, the quality of which already surpasses the ECE-R90 standard throughout most of our portfolio. It just couldn't get any better.

### ATE PowerDisc

Sporty looks, innovative technology and it's an ATE invention – the PowerDisc with patented multifunction groove ensures safe braking even in wet conditions and in critical situations. Dirt and gases are removed, reducing fading and preventing scoring, and the amount of wear is revealed by just a glance at the groove. The ATE PowerDisc is easy to install and perfect in combination with ATE Original brake pads.



You'll find more details about the ATE PowerDisc on our website at [www.ate.de/powerdisc](http://www.ate.de/powerdisc)



### Original ATE brake discs

ATE brake discs are packed full of sophisticated technology, high-quality materials and our entire expertise. They correspond exactly to the brake discs originally installed by the manufacturer. Whether smooth, perforated or grooved, high-carbon, one-piece, pinned or riveted and with or without wheel bearings – we always have the right solution for safe and comfortable braking. With the matching brake pad too. One good combination, for example – our coated brake discs and the low-dust ATE Ceramic brake pads, or our Original brake pads of course. Original ATE brake discs are available in 98 per cent of European countries and are also available with wheel bearings or – if prescribed by the vehicle manufacturer – with fixing screws.



Coated brake disc with fixing screws



Coated two-piece brake disc



Brake discs with wheel



# Drum brakes

## Each one fits the other

### Far above the standard

High-quality materials, careful manufacturing, numerous tests: our spare parts for drum brakes far exceed the legal requirements of the ECE-R90 standard. ATE brake drums and brake shoes are sturdy, durable and effectively protected against corrosion.

Another advantage of our precise production: the components fit together exactly and are properly seated right away. This saves time and stress during installation and ensures maximum safety.

All drum brake spare parts can be found in our catalogue of wear parts or at [www.ate-brakes.com/drumbrakes](http://www.ate-brakes.com/drumbrakes)

### TopKits

It doesn't get much faster than this! With the ATE TopKits, you can save up to 30 minutes of working time per vehicle – pre-assembled parts make the installation completely safe and convenient. The complete set contains everything necessary for replacing drum brake shoes, including wheel cylinders, pre-adjusted sets of brake shoes and screws. Everything can be conveniently ordered under one single part number. First-class service can be so easy.



### Brake drums

ATE brake drums offer first-class, uniform cast iron quality, an optimally rough surface and the best possible thermal conductivity. The drums' true running is always exact and all major functions are extensively tested. ATE brake drums are available for models with integrated wheel bearings and are also offered by vehicle manufacturers.



### Drum brake shoes

ATE drum brake shoes meet higher requirements than the vehicle makers demand. In combination with ATE brake drums, they provide the best performance right from the start – and thanks to the seamless powder coating of the drum brake shoes, corrosion doesn't have a chance, not even in extreme conditions.





# Everything flows

## Hydraulic parts

The smooth interaction of all the components is crucial in brake hydraulics. All ATE parts come from one source – so they fit together perfectly. Not only that – the quality and availability are always top class.

# Hydraulic parts

## Reliable in every detail



### Brake callipers

ATE brake callipers are tough – and innovative materials, cutting-edge technologies and extensive testing make sure they stay that way. That's why we are the European leader in fixed and floating brake callipers made of cast iron with nodular graphite. Many ATE brake callipers are ideal for remanufacturing and we exploit this to the full – our remanufactured callipers are sustainable and meet the same rigorous safety standards as new products.

We also simplify the installation procedure. Our brake callipers are supplied ready to install, and the right tools, repair kits and other accessories are always available.

Find out more about the brake calliper deposit system at [www.ate.de/calliper](http://www.ate.de/calliper)

### Master brake cylinders

Trendsetting – the new generation of plunger tandem master cylinders is compact and lightweight, robust and durable – ideal for the demanding requirements of advanced control functions such as ABS, ESP® and TCS.



### Wheel cylinders

OEM quality tested under extreme conditions, corrosion-resistant and light: ATE wheel cylinders meet the highest standards and are available for virtually all major vehicle brands in Europe.



### Brake force reducing valves

The load-sensitive twin regulators are made from an extruded aluminium section – so they are compact and up to 50 per cent lighter. The structure of the control cells is uniform thanks to a modular system.



### Brake boosters

ATE brake boosters originate from serial production, so they are always guaranteed to be state-of-the-art. Original accessories such as travel sensors and check valves are also available separately.



### Brake hoses

We rely on the latest technology when we develop and manufacture ATE brake hoses. That's why they are extremely stress-resistant and safe and cope easily with pressure, heat, fuel or oil.



A full overview is available in our Hydraulic catalogue or at [www.ate-brakes.com/hydraulic](http://www.ate-brakes.com/hydraulic)



# More than safe

## Brake fluids

ATE has the optimal brake fluid for every vehicle model and every driving style – and all our fluids leave the legal and technical standards far behind. Our highlight for electronic braking systems – the ATE SL.6. The low-viscosity texture ensures a quick response from ABS or ESP® at low temperatures, guaranteeing maximum safety.

### The properties of ATE brake fluids

	Boiling point	Wet boiling point	Viscosity at -40 °C	Replacement interval
<b>ATE G DOT 3</b>	min. 245 °C	min. 150 °C	max. 1,500 mm <sup>2</sup> /s	up to 1 year
<b>ATE SL DOT 4</b>	min. 260 °C	min. 165 °C	max. 1,400 mm <sup>2</sup> /s	up to 1 year
<b>ATE SL.6 DOT 4</b> Ideal for ESP®, ABS, ASR	min. 265 °C	min. 175 °C	max. 700 mm <sup>2</sup> /s	up to 2 years
<b>ATE TYP 200 DOT 4</b> Racing quality	min. 280 °C	min. 198 °C	max. 1,400 mm <sup>2</sup> /s	up to 3 years

### ESP® response times

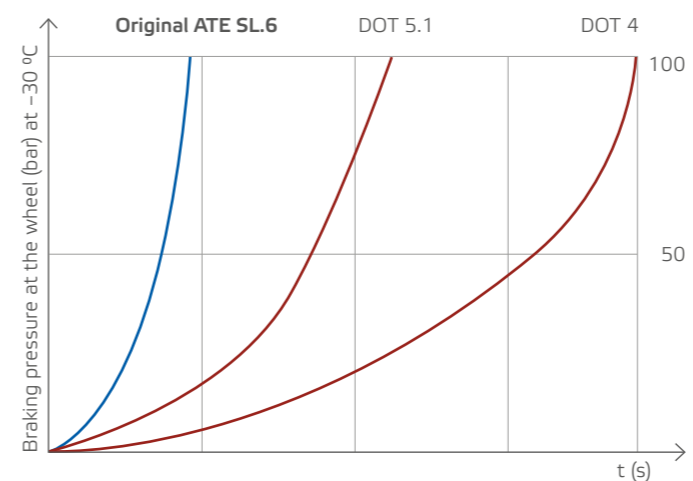

### Service equipment



Of course we also offer devices for the testing, bleeding and disposal of brake fluids. The devices work accurately and reliably, are easy to use and their technology is state-of-the-art.

Please go to our website to learn more about ATE brake fluids and service equipment:  
[www.ate-brakes.com/brakefluid](http://www.ate-brakes.com/brakefluid) or [www.ate-info.de](http://www.ate-info.de)

# Highly precise



## Electronic components

ATE sensors are installed by all vehicle manufacturers worldwide and we are one of the leading manufacturers in the field of electronic braking systems. So it follows that we also offer wheel speed sensors for ABS electronic brake systems as spare parts – with an extensive programme and the original equipment quality our customers expect from us.

## Wheel speed sensors

Our active and passive wheel speed sensors provide reliable measurements, making a valuable contribution to safety. They are available for a wide range of different vehicle models.

We also offer services that make workshop tasks easier, such as special training courses on modern electronic braking systems, appropriate diagnostic equipment for fault analyses and repair tools.

Learn more about our sensors and services on our website at [www.ate-brakes.com/electronic](http://www.ate-brakes.com/electronic)

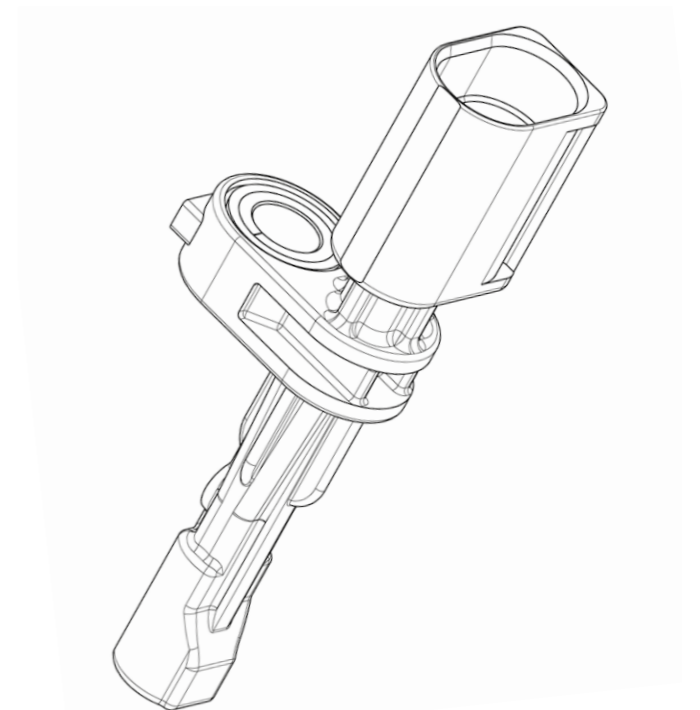

# Small Robust Solid

## Clutch parts

Original equipment quality down to the smallest detail. ATE clutch parts are high-grade, durable and totally reliable, because our careful production processes prevent premature wear – and because all our components complement one another perfectly, the comfort in clutch operation is optimal.



## Master and slave cylinders

Thanks to special manufacturing techniques, our master and slave cylinders are compact, lightweight and easy to install. They ensure that the clutch functions smoothly and continuously.



## Clutch cables

Whether they are self-adjusting or manual adjustment models, ATE clutch cables are durable and well protected against rust. The programme covers a wide range of European vehicle models.

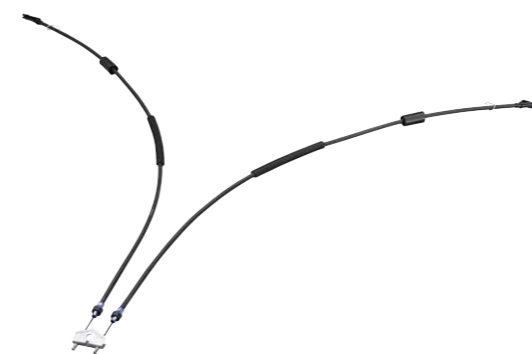

## Handbrake cables

ATE handbrake cables are robust, resistant to corrosion and maintenance free. Their customised production guarantees safety and perfect functioning.



## ATE Classic

In 1926 we introduced the classic ATE Lockheed brake system to the market – it was the first hydraulic brake on the continent to go into serial production and was installed in the Adler Standard 6. And ATE still loves vintage and classic cars today. The proof lies in our unique range of spare parts and services for cars that are older than 20 years.

# It runs and runs

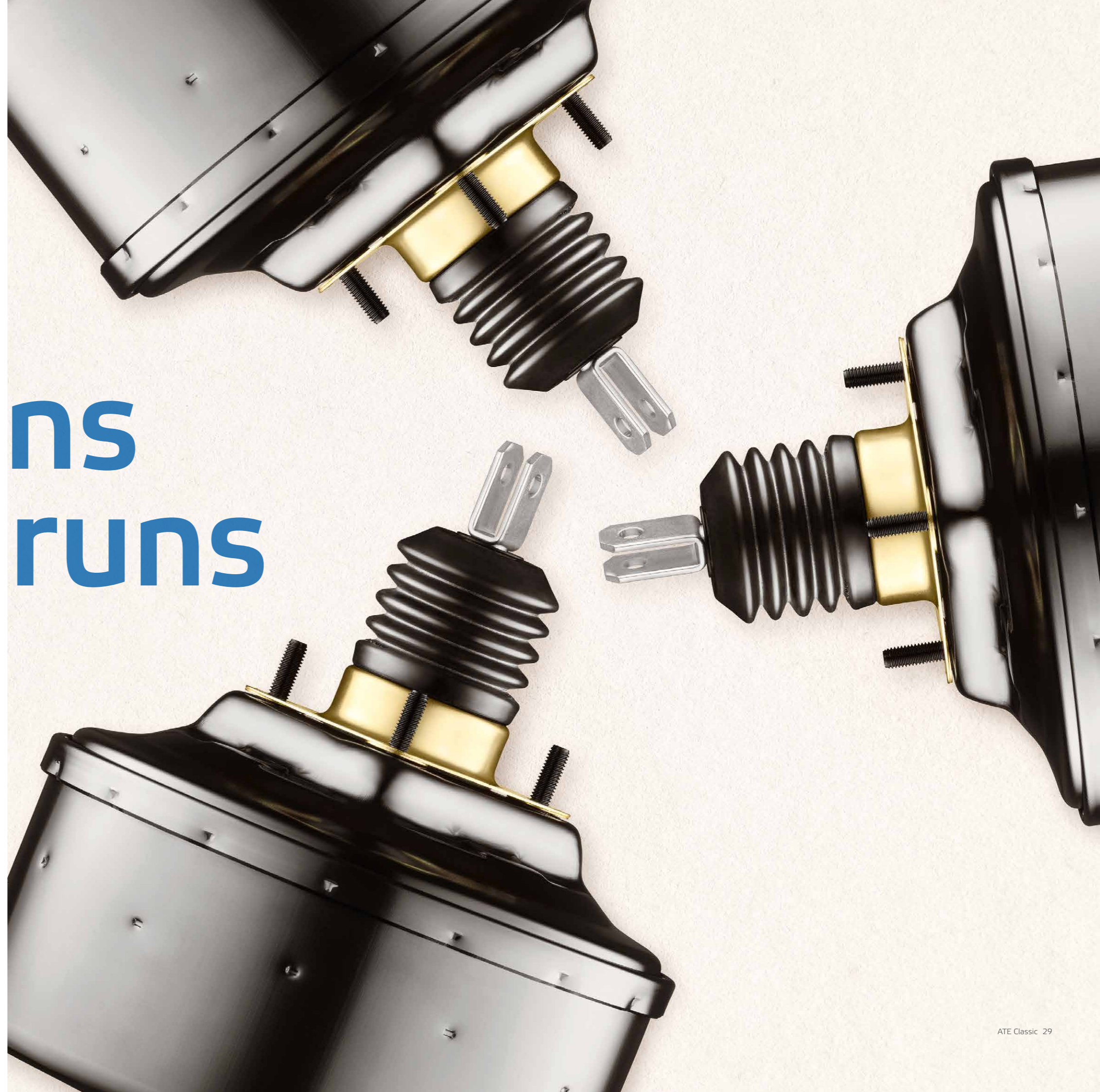

# ATE Classic

## Brakes for vintage and classic cars



### Everything for classic cars

We want vintage and classic car owners to enjoy their vehicles for a long time – and to make sure that they always brake safely. That's why we offer more than 1,300 mechanical and hydraulic parts for brake repairs that remain true to the original – in original equipment quality and usually available at short notice.

And there's more ... in our ATE Classic training courses we teach participants about the maintenance, repair, modification and optimisation of older brake systems – and all the courses are practically oriented. In this way, we provide support for workshops, enabling them to always offer their customers the best professional service for classic cars.

### ATE Classic PartFinder

Whether roadster or saloon, whether from 1952 or 1982, our online database makes it easy for you to find the right spare part for vintage and classic cars. Just enter the vehicle data or the dimensions of the original parts and the search can start.

### Individual guidance

We will also provide you with personal help. If you still can't find an ATE Original part in the PartFinder or Classic catalogue, you can send us an inquiry by e-mail. We'll try to find the part for you – and if we can't, we'll be glad to recommend suitable alternatives for you.

You can find out more about ATE Classic on our website at [www.ate-brakes.com/classic](http://www.ate-brakes.com/classic)

The contact form for individual queries is also available here.

The ATE Classic catalogue and PartFinder give you an overview of ATE Classic replacement parts.

Hotline: +49 1805 221242



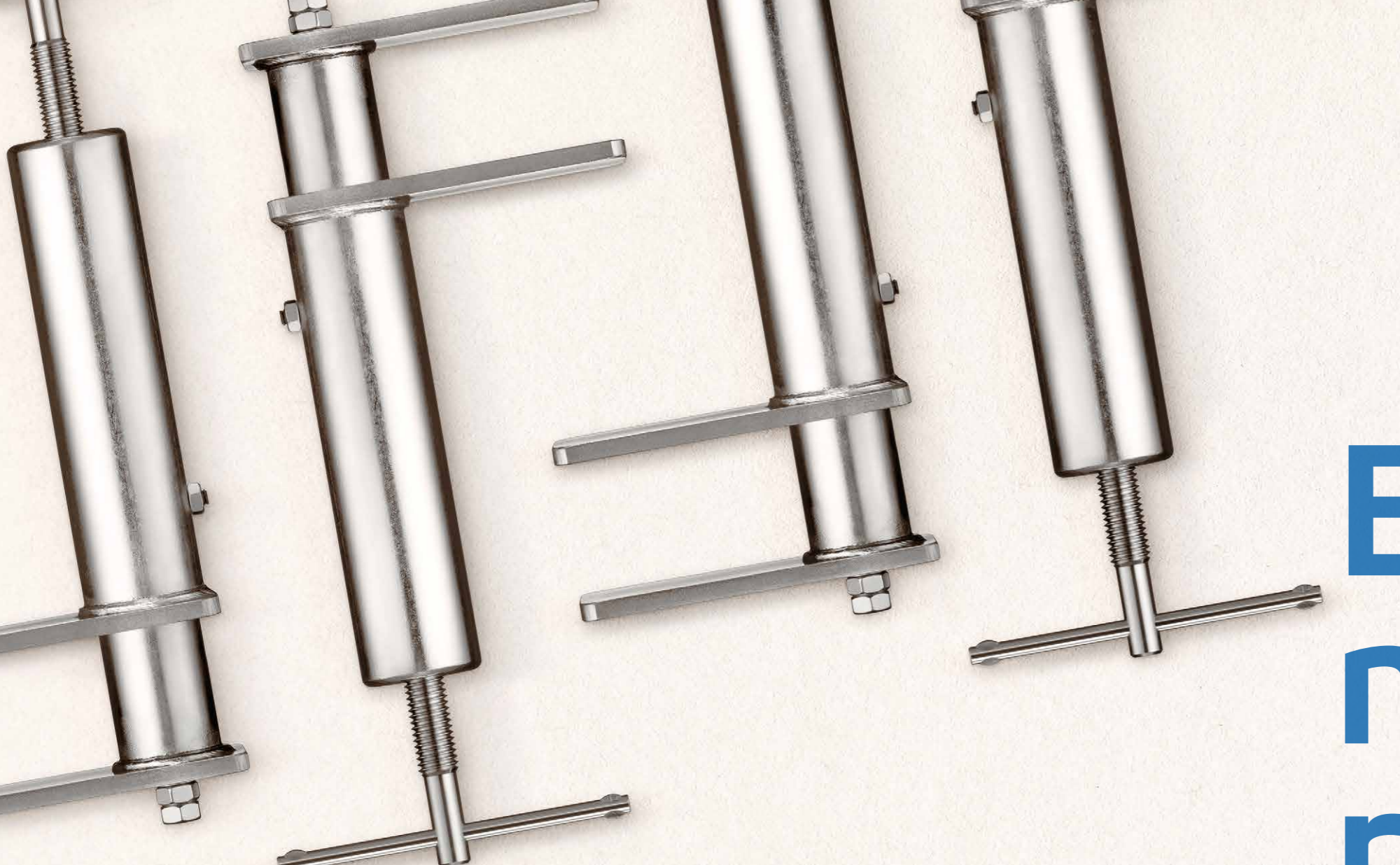

# Every move is right

## Tools

It's not just our brake components that match one another precisely, we also offer the perfect tools – and it goes without saying that our quality is always first-class. You get everything from one source, so you can work reliably and fast. When it comes to vehicle electronics, VDO spare parts and services are also the perfect complement.

### Testing and inspection devices

Whether you're testing brake fluid, sensors or other components, ATE devices and their matching tools are accurate and reliable – and that makes brake diagnosis much easier.

### Brake bleeding devices

Bleeding brakes quickly and effectively: you can choose from different units for different vehicle models and braking systems – and integrated exhaust extraction systems are also available.

### Disposal devices

To dispose of used brake fluid in an environmentally-friendly and cost-effective way, it must first be sorted into different types. That's no problem with our disposal systems.

### Special brake tools

At ATE, you'll find everything you need for the installation and maintenance of different brake components – all in top quality and exactly tailored to suit their purpose.

### Bundled know-how

All the important tools for professional brake service in one place, clearly arranged and ready for use – the workshop trolley is equipped with special ATE tools and offers more additional space.



All the details can be found on our website and in the ATE tool catalogue at [www.ate-info.de](http://www.ate-info.de)



# With word and deed

## Services

First-class products aren't everything – because it's your professional work that makes our ATE quality perfect. We support you with comprehensive brake maintenance and repair services, including personal counselling, professional training courses and our successful Workshop Concept.

### Online services

At [www.ate-brakes.com](http://www.ate-brakes.com), you'll find everything about our products and services, plus special offers such as the PartnerFinder and the online parts catalogue. The ATE app is also available for download. With this app, you can find spare parts, easily verify whether or not the item you have bought is a real Original spare part ... and lots more.

### Detailed information

Our current catalogue with all our replacement parts is available in printed form, on a CD-ROM or online as a download – and we constantly update them all. If you have specific questions, just call the ATE Technical Hotline – our experts will be ready to give you advice or help you via e-mail.

### Training

Always at the cutting edge – our practical training courses provide the latest know-how on various topics. Our offer ranges from information events on technical and product-related training to business topics. Individual coaching is also possible.

### Sales support

Drum up some business. In addition to many other items, we offer you signs and office equipment for your workshop, attractive marketing materials, a diverse selection of advertising materials and high-quality work clothing. All this contributes to a professional appearance and to your business success.

### Workshop Concept

Offer your customers even more professional service – as an ATE BrakeCenter. With this partnership, you will especially profit from our know-how and our comprehensive support – and you will remain an independent workshop. You can also draw upon the knowledge of VDO Electronics.

Do you want to know more about our services?  
Visit our website at [www.ate-brakes.com/service](http://www.ate-brakes.com/service) or ask for our service brochure.

**ATE – A Trademark of the  
Continental Group**

Continental Aftermarket GmbH  
Guerickestraße 7  
60488 Frankfurt

Telephone: +49 69 7603-1  
Fax: +49 69 761061

[www.ate-brakes.com](http://www.ate-brakes.com)

