

New partnumbers on stock
according to applications









11/2012



www.ate.de



					Description	OE numbers per ATE pn.	 e.g. replaced pn. / miscellaneous
---	---	---	---	---	--------------------	-------------------------------	--

ALFA ROMEO

Model	Engine	Side	Year	Part No.	ATE No.	Description	OE numbers	Notes
MITO (08-)	0,9	RL	07.2011	24.3727-0579.2	580579	HANDBRAKE CABLE	51844531 , 55700929 , 55704104	
	1,3 JTDM	RL	01.2011	24.3727-0579.2	580579	HANDBRAKE CABLE	51844531 , 55700929 , 55704104	
		RL	08.2008	24.3727-0579.2	580579	HANDBRAKE CABLE	51844531 , 55700929 , 55704104	
		RL	10.2009	24.3727-0579.2	580579	HANDBRAKE CABLE	51844531 , 55700929 , 55704104	
	1,4	RL	08.2008	24.3727-0579.2	580579	HANDBRAKE CABLE	51844531 , 55700929 , 55704104	
	1,4 Bifuel	RL	07.2011	24.3727-0579.2	580579	HANDBRAKE CABLE	51844531 , 55700929 , 55704104	
	1,4 i 16V	RL	05.2011	24.3727-0579.2	580579	HANDBRAKE CABLE	51844531 , 55700929 , 55704104	
		RL	08.2008	24.3727-0579.2	580579	HANDBRAKE CABLE	51844531 , 55700929 , 55704104	
	1,4 TB	RL	09.2009	24.3727-0579.2	580579	HANDBRAKE CABLE	51844531 , 55700929 , 55704104	
		RL	10.2009	24.3727-0579.2	580579	HANDBRAKE CABLE	51844531 , 55700929 , 55704104	
		RL	08.2008	24.3727-0579.2	580579	HANDBRAKE CABLE	51844531 , 55700929 , 55704104	
	1,4 Turbo	RL	09.2008	24.3727-0579.2	580579	HANDBRAKE CABLE	51844531 , 55700929 , 55704104	
	1,6 JTD	RL	08.2008	24.3727-0579.2	580579	HANDBRAKE CABLE	51844531 , 55700929 , 55704104	

New partnumbers on stock - according to applications

11/2012



				Description	OE numbers per ATE pn.	 e.g. replaced pn. / miscellaneous
--	--	--	--	--------------------	-------------------------------	---------------------------------------







ALFA ROMEO

MITO (08-)	1,6 JTDM	RL	09.2008		24.3727-0579.2	580579	HANDBRAKE CABLE	51844531 , 55700929 , 55704104	
------------	----------	----	---------	--	----------------	--------	-----------------	--------------------------------	--

New partnumbers on stock - according to applications

11/2012



					Description	OE numbers per ATE pn.	 e.g. replaced pn. / miscellaneous
---	---	---	---	---	--------------------	-------------------------------	--







BMW

5 series/E39 (96-03)	520 d	RL	04.2000	07.2003	24.3727-0247.2	580247	HANDBRAKE CABLE	34 41 1 162 998 , 34 40 1 166 234	24.3727-0225.2
	520 d Touring	RL	04.2000	07.2003	24.3727-0247.2	580247	HANDBRAKE CABLE	34 41 1 162 998 , 34 40 1 166 234	24.3727-0225.2
	520 i	RL	03.1996	07.2003	24.3727-0247.2	580247	HANDBRAKE CABLE	34 41 1 162 998 , 34 40 1 166 234	24.3727-0225.2
	520 i Touring	RL	05.1997	07.2003	24.3727-0247.2	580247	HANDBRAKE CABLE	34 41 1 162 998 , 34 40 1 166 234	24.3727-0225.2
	523 i	RL	12.1995	09.2000	24.3727-0247.2	580247	HANDBRAKE CABLE	34 41 1 162 998 , 34 40 1 166 234	24.3727-0225.2
	523 i Touring	RL	05.1997	09.2000	24.3727-0247.2	580247	HANDBRAKE CABLE	34 41 1 162 998 , 34 40 1 166 234	24.3727-0225.2
	525 d	RL	04.2000	07.2003	24.3727-0247.2	580247	HANDBRAKE CABLE	34 41 1 162 998 , 34 40 1 166 234	24.3727-0225.2
	525 d Touring	RL	04.2000	07.2003	24.3727-0247.2	580247	HANDBRAKE CABLE	34 41 1 162 998 , 34 40 1 166 234	24.3727-0225.2
	525 i	RL	10.2000	07.2003	24.3727-0247.2	580247	HANDBRAKE CABLE	34 41 1 162 998 , 34 40 1 166 234	24.3727-0225.2
	525 i Touring	RL	10.2000	07.2003	24.3727-0247.2	580247	HANDBRAKE CABLE	34 41 1 162 998 , 34 40 1 166 234	24.3727-0225.2
	525 td	RL	01.1997	09.2000	24.3727-0247.2	580247	HANDBRAKE CABLE	34 41 1 162 998 , 34 40 1 166 234	24.3727-0225.2
	525 tds	RL	02.1996	09.2000	24.3727-0247.2	580247	HANDBRAKE CABLE	34 41 1 162 998 , 34 40 1 166 234	24.3727-0225.2
	525 tds Touring	RL	06.1998	09.2000	24.3727-0247.2	580247	HANDBRAKE CABLE	34 41 1 162 998 , 34 40 1 166 234	24.3727-0225.2

New partnumbers on stock - according to applications

11/2012



					Description	OE numbers per ATE pn.	 e.g. replaced pn. / miscellaneous
---	---	---	---	---	--------------------	-------------------------------	---

BMW

5 series/E39 (96-03)	528 i	RL	12.1995	09.2000	24.3727-0247.2	580247	HANDBRAKE CABLE	34 41 1 162 998 , 34 40 1 166 234	24.3727-0225.2
	528 i Touring	RL	05.1997	09.2000	24.3727-0247.2	580247	HANDBRAKE CABLE	34 41 1 162 998 , 34 40 1 166 234	24.3727-0225.2
	530 d	RL	09.1998	07.2003	24.3727-0247.2	580247	HANDBRAKE CABLE	34 41 1 162 998 , 34 40 1 166 234	24.3727-0225.2
	530 d Touring	RL	09.1998	07.2003	24.3727-0247.2	580247	HANDBRAKE CABLE	34 41 1 162 998 , 34 40 1 166 234	24.3727-0225.2
	530 i	RL	10.2000	07.2003	24.3727-0247.2	580247	HANDBRAKE CABLE	34 41 1 162 998 , 34 40 1 166 234	24.3727-0225.2
	530 i Touring	RL	10.2000	07.2003	24.3727-0247.2	580247	HANDBRAKE CABLE	34 41 1 162 998 , 34 40 1 166 234	24.3727-0225.2
	535 i	RL	05.1996	07.2003	24.3727-0247.2	580247	HANDBRAKE CABLE	34 41 1 162 998 , 34 40 1 166 234	24.3727-0225.2
	540 i	RL	05.1996	07.2003	24.3727-0247.2	580247	HANDBRAKE CABLE	34 41 1 162 998 , 34 40 1 166 234	24.3727-0225.2
	540 i Touring	RL	05.1997	07.2003	24.3727-0247.2	580247	HANDBRAKE CABLE	34 41 1 162 998 , 34 40 1 166 234	24.3727-0225.2
	M5	RL	10.1998	07.2003	24.3727-0247.2	580247	HANDBRAKE CABLE	34 41 1 162 998 , 34 40 1 166 234	24.3727-0225.2
Z4 Roadster/E89 (09-)	sDrive 20i		09.2011		24.0120-0226.1	420226	BRAKE DISC	34 21 6 782 605	
	sDrive 23i		01.2009		24.0120-0226.1	420226	BRAKE DISC	34 21 6 782 605	
	sDrive 28i		09.2011		24.0120-0226.1	420226	BRAKE DISC	34 21 6 782 605	
			09.2011		24.0124-0242.2	424242	Bremsscheibe 2-Teilig	34 11 6 782 601 , 34 11 6 794 427	
	sDrive 30i		01.2009		24.0120-0226.1	420226	BRAKE DISC	34 21 6 782 605	

New partnumbers on stock - according to applications

11/2012



					Description	OE numbers per ATE pn.	 e.g. replaced pn. / miscellaneous
--	--	--	--	--	--------------------	-------------------------------	---------------------------------------

BMW

Z4 Roadster/E89 (09-)	sDrive 30i		01.2009		24.0124-0242.2	424242	Bremsscheibe 2-Teilig	34 11 6 782 601 , 34 11 6 794 427	
-----------------------	------------	--	---------	--	----------------	--------	-----------------------	-----------------------------------	--

CITROEN

C6 (05-)	2,2 HDi	FL	06.2006		24.5161-0315.3	331186	BRAKE HOSE	4806 F9	
		FR	06.2006		24.5161-0316.3	331187	BRAKE HOSE	4806 G0	
	2,7 HDi	FR	09.2005		24.5161-0316.3	331187	BRAKE HOSE	4806 G0	
		FL	09.2005		24.5161-0315.3	331186	BRAKE HOSE	4806 F9	
	3,0 V6	FL	09.2005		24.5161-0315.3	331186	BRAKE HOSE	4806 F9	
		FR	09.2005		24.5161-0316.3	331187	BRAKE HOSE	4806 G0	
JUMPY (07-)	1,6 HDi 90		01.2007		24.0225-4021.1	480311	BRAKE DRUM	1401417180 , 4247 51 , 4247 56 , 1400178980	

New partnumbers on stock - according to applications

11/2012



					Description	OE numbers per ATE pn.	 e.g. replaced pn. / miscellaneous
--	--	--	--	--	--------------------	-------------------------------	---------------------------------------

Classic PKW

MERCEDES BENZ (R129) SL-Class (89-93)	300 SL	FL	06.1989	07.1993	24.9442-8003.5	230053	FIXED CALIPER	000 420 79 83 , 129 420 00 83	13.4421-8003.2
	300 SL 24	FL	06.1989	07.1993	24.9442-8003.5	230053	FIXED CALIPER	000 420 79 83 , 129 420 00 83	13.4421-8003.2
	500 SL	FL	06.1989	07.1993	24.9442-8003.5	230053	FIXED CALIPER	000 420 79 83 , 129 420 00 83	13.4421-8003.2
MERCEDES BENZ (W124) E-Class (85-93)	500 E	FL	01.1991		24.9442-8003.5	230053	FIXED CALIPER	000 420 79 83 , 129 420 00 83	13.4421-8003.2
MERCEDES BENZ (W201) 190-190 E 2,6 (82-93)	190 E 2,5 16V Evolut,	FL	03.1989	05.1993	24.9442-8003.5	230053	FIXED CALIPER	000 420 79 83 , 129 420 00 83	13.4421-8003.2
MERCEDES BENZ G-Class (W460) (79-93)	200 GE	FL	05.1986		13.4441-8015.2	210263	FIXED CALIPER	003 421 41 98 , 003 421 43 98 , 003 421 49 98 , 002 421 38 98 , 004 421 82 98 , 007 421 15 98 , 006 421 29 98	13.4441-8015.3-
	230 G	FL	02.1979	08.1985	13.4441-8015.2	210263	FIXED CALIPER	003 421 41 98 , 003 421 43 98 , 003 421 49 98 , 002 421 38 98 , 004 421 82 98 , 007 421 15 98 , 006 421 29 98	13.4441-8015.3-
	230 GE	FL	04.1982		13.4441-8015.2	210263	FIXED CALIPER	003 421 41 98 , 003 421 43 98 , 003 421 49 98 , 002 421 38 98 , 004 421 82 98 , 007 421 15 98 , 006 421 29 98	13.4441-8015.3-
	240 GD	FL	02.1979		13.4441-8015.2	210263	FIXED CALIPER	003 421 41 98 , 003 421 43 98 , 003 421 49 98 , 002 421 38 98 , 004 421 82 98 , 007 421 15 98 , 006 421 29 98	13.4441-8015.3-
	250 GD	FL	08.1987		13.4441-8015.2	210263	FIXED CALIPER	003 421 41 98 , 003 421 43 98 , 003 421 49 98 , 002 421 38 98 , 004 421 82 98 , 007 421 15 98 , 006 421 29 98	13.4441-8015.3-

New partnumbers on stock - according to applications

11/2012



					Description	OE numbers per ATE pn.	 e.g. replaced pn. / miscellaneous
--	--	--	--	--	--------------------	-------------------------------	---------------------------------------

Classic PKW

MERCEDES BENZ G-Class (W460) (79-93)	280 GE	FL	02.1979		13.4441-8015.2	210263	FIXED CALIPER	003 421 41 98 , 003 421 43 98 , 003 421 49 98 , 002 421 38 98 , 004 421 82 98 , 007 421 15 98 , 006 421 29 98	13.4441-8015.3-
	300 GD	FL	02.1979		13.4441-8015.2	210263	FIXED CALIPER	003 421 41 98 , 003 421 43 98 , 003 421 49 98 , 002 421 38 98 , 004 421 82 98 , 007 421 15 98 , 006 421 29 98	13.4441-8015.3-
MERCEDES BENZ Transporter (BM 601) 207 D-210 D	207 D	FL	05.1977		13.4441-8015.2	210263	FIXED CALIPER	003 421 41 98 , 003 421 43 98 , 003 421 49 98 , 002 421 38 98 , 004 421 82 98 , 007 421 15 98 , 006 421 29 98	13.4441-8015.3-
	208	FL	05.1977		13.4441-8015.2	210263	FIXED CALIPER	003 421 41 98 , 003 421 43 98 , 003 421 49 98 , 002 421 38 98 , 004 421 82 98 , 007 421 15 98 , 006 421 29 98	13.4441-8015.3-
	208 D	FL	09.1988		13.4441-8015.2	210263	FIXED CALIPER	003 421 41 98 , 003 421 43 98 , 003 421 49 98 , 002 421 38 98 , 004 421 82 98 , 007 421 15 98 , 006 421 29 98	13.4441-8015.3-
	209 D	FL	05.1977		13.4441-8015.2	210263	FIXED CALIPER	003 421 41 98 , 003 421 43 98 , 003 421 49 98 , 002 421 38 98 , 004 421 82 98 , 007 421 15 98 , 006 421 29 98	13.4441-8015.3-
	210	FL	05.1977		13.4441-8015.2	210263	FIXED CALIPER	003 421 41 98 , 003 421 43 98 , 003 421 49 98 , 002 421 38 98 , 004 421 82 98 , 007 421 15 98 , 006 421 29 98	13.4441-8015.3-
	210 D	FL	09.1988		13.4441-8015.2	210263	FIXED CALIPER	003 421 41 98 , 003 421 43 98 , 003 421 49 98 , 002 421 38 98 , 004 421 82 98 , 007 421 15 98 , 006 421 29 98	13.4441-8015.3-

New partnumbers on stock - according to applications

11/2012



					Description	OE numbers per ATE pn.	 e.g. replaced pn. / miscellaneous
--	--	--	--	--	--------------------	-------------------------------	---------------------------------------

Classic PKW

MERCEDES BENZ Transporter (BM 602) 307 D-310 D	307 D	FL	05.1977		13.4441-8015.2	210263	FIXED CALIPER	003 421 41 98 , 003 421 43 98 , 003 421 49 98 , 002 421 38 98 , 004 421 82 98 , 007 421 15 98 , 006 421 29 98	13.4441-8015.3-
	308	FL	05.1977		13.4441-8015.2	210263	FIXED CALIPER	003 421 41 98 , 003 421 43 98 , 003 421 49 98 , 002 421 38 98 , 004 421 82 98 , 007 421 15 98 , 006 421 29 98	13.4441-8015.3-
	308 D	FL	09.1988		13.4441-8015.2	210263	FIXED CALIPER	003 421 41 98 , 003 421 43 98 , 003 421 49 98 , 002 421 38 98 , 004 421 82 98 , 007 421 15 98 , 006 421 29 98	13.4441-8015.3-
	309 D	FL	05.1977		13.4441-8015.2	210263	FIXED CALIPER	003 421 41 98 , 003 421 43 98 , 003 421 49 98 , 002 421 38 98 , 004 421 82 98 , 007 421 15 98 , 006 421 29 98	13.4441-8015.3-
	310	FL	05.1977		13.4441-8015.2	210263	FIXED CALIPER	003 421 41 98 , 003 421 43 98 , 003 421 49 98 , 002 421 38 98 , 004 421 82 98 , 007 421 15 98 , 006 421 29 98	13.4441-8015.3-
	310 D	FL	09.1988		13.4441-8015.2	210263	FIXED CALIPER	003 421 41 98 , 003 421 43 98 , 003 421 49 98 , 002 421 38 98 , 004 421 82 98 , 007 421 15 98 , 006 421 29 98	13.4441-8015.3-
MERCEDES BENZ Transporter (BM 611) 407 D-410 D	407 D	FL	06.1981		13.4441-8015.2	210263	FIXED CALIPER	003 421 41 98 , 003 421 43 98 , 003 421 49 98 , 002 421 38 98 , 004 421 82 98 , 007 421 15 98 , 006 421 29 98	13.4441-8015.3-
	408 D	FL	10.1988		13.4441-8015.2	210263	FIXED CALIPER	003 421 41 98 , 003 421 43 98 , 003 421 49 98 , 002 421 38 98 , 004 421 82 98 , 007 421 15 98 , 006 421 29 98	13.4441-8015.3-

New partnumbers on stock - according to applications

11/2012



				Description	OE numbers per ATE pn.	 e.g. replaced pn. / miscellaneous
--	--	--	--	--------------------	-------------------------------	---------------------------------------

Classic PKW

MERCEDES BENZ Transporter (BM 611) 407 D-410 D	409 D	FL	06.1981		13.4441-8015.2	210263	FIXED CALIPER	003 421 41 98 , 003 421 43 98 , 003 421 49 98 , 002 421 38 98 , 004 421 82 98 , 007 421 15 98 , 006 421 29 98	13.4441-8015.3-
	410	FL	06.1981		13.4441-8015.2	210263	FIXED CALIPER	003 421 41 98 , 003 421 43 98 , 003 421 49 98 , 002 421 38 98 , 004 421 82 98 , 007 421 15 98 , 006 421 29 98	13.4441-8015.3-
	410 D	FL	11.1988		13.4441-8015.2	210263	FIXED CALIPER	003 421 41 98 , 003 421 43 98 , 003 421 49 98 , 002 421 38 98 , 004 421 82 98 , 007 421 15 98 , 006 421 29 98	13.4441-8015.3-

New partnumbers on stock - according to applications

11/2012



					Description	OE numbers per ATE pn.	 e.g. replaced pn. / miscellaneous
--	--	--	--	--	--------------------	-------------------------------	---------------------------------------

FIAT

GRANDE PUNTO (06-11)	1,2 i	RL	10.2005	01.2011	24.3727-0575.2	580575	HANDBRAKE CABLE	55700928 , 55704107	
		RR	10.2005	01.2011	24.3727-0576.2	580576	HANDBRAKE CABLE	55700926 , 55704105	
	1,3 JTD	RR	10.2005	01.2011	24.3727-0578.2	580578	HANDBRAKE CABLE	55701946 , 55704106	
		RL	10.2005	01.2011	24.3727-0577.2	580577	HANDBRAKE CABLE	55701942 , 55704108	
	1,4 Abarth	RL	12.2007	01.2011	24.3727-0579.2	580579	HANDBRAKE CABLE	51844531 , 55700929 , 55704104	
	1,4 bivalent CNG	RR	10.2008	01.2011	24.3727-0578.2	580578	HANDBRAKE CABLE	55701946 , 55704106	
		RL	10.2008	01.2011	24.3727-0577.2	580577	HANDBRAKE CABLE	55701942 , 55704108	
	1,4 i	RL	10.2005	01.2011	24.3727-0577.2	580577	HANDBRAKE CABLE	55701942 , 55704108	
		RR	10.2005	01.2011	24.3727-0578.2	580578	HANDBRAKE CABLE	55701946 , 55704106	
	1,4 i 16V	RR	10.2005	01.2011	24.3727-0578.2	580578	HANDBRAKE CABLE	55701946 , 55704106	
		RL	10.2005	01.2011	24.3727-0577.2	580577	HANDBRAKE CABLE	55701942 , 55704108	
	1,4 i 16V Turbo	RL	07.2007	01.2011	24.3727-0579.2	580579	HANDBRAKE CABLE	51844531 , 55700929 , 55704104	
	1,4 i Turbo Abarth	RL	10.2007	01.2011	24.3727-0579.2	580579	HANDBRAKE CABLE	51844531 , 55700929 , 55704104	
	1,4 LPG	RL	12.2008	01.2011	24.3727-0577.2	580577	HANDBRAKE CABLE	55701942 , 55704108	
		RR	12.2008	01.2011	24.3727-0578.2	580578	HANDBRAKE CABLE	55701946 , 55704106	
	1,4 Natural Power	RR	07.2008	01.2011	24.3727-0578.2	580578	HANDBRAKE CABLE	55701946 , 55704106	
		RL	07.2008	01.2011	24.3727-0577.2	580577	HANDBRAKE CABLE	55701942 , 55704108	
	1,6 D Multijet	RL	07.2008	01.2011	24.3727-0579.2	580579	HANDBRAKE CABLE	51844531 , 55700929 , 55704104	

New partnumbers on stock - according to applications

11/2012



					Description	OE numbers per ATE pn.	 e.g. replaced pn. / miscellaneous
--	--	--	--	--	--------------------	-------------------------------	---------------------------------------

FIAT

GRANDE PUNTO (06-11)	1,9 JTD	RL	10.2005	01.2011	24.3727-0579.2	580579	HANDBRAKE CABLE	51844531 , 55700929 , 55704104	
		RL	02.2006	01.2011	24.3727-0579.2	580579	HANDBRAKE CABLE	51844531 , 55700929 , 55704104	
PUNTO / PUNTO EVO (09-)	0,9 Twinair Turbo	RR	03.2012		24.3727-0576.2	580576	HANDBRAKE CABLE	55700926 , 55704105	
		RL	03.2012		24.3727-0575.2	580575	HANDBRAKE CABLE	55700928 , 55704107	
	1,2	RL	10.2009		24.3727-0579.2	580579	HANDBRAKE CABLE	51844531 , 55700929 , 55704104	
		RL	10.2009		24.3727-0575.2	580575	HANDBRAKE CABLE	55700928 , 55704107	
		RR	10.2009		24.3727-0576.2	580576	HANDBRAKE CABLE	55700926 , 55704105	
	1,3 D Multijet	RL	10.2009		24.3727-0579.2	580579	HANDBRAKE CABLE	51844531 , 55700929 , 55704104	
		RR	10.2009		24.3727-0578.2	580578	HANDBRAKE CABLE	55701946 , 55704106	
		RL	10.2009		24.3727-0577.2	580577	HANDBRAKE CABLE	55701942 , 55704108	
	1,4	RL	10.2009		24.3727-0579.2	580579	HANDBRAKE CABLE	51844531 , 55700929 , 55704104	
		RL	10.2009		24.3727-0577.2	580577	HANDBRAKE CABLE	55701942 , 55704108	
		RR	10.2009		24.3727-0578.2	580578	HANDBRAKE CABLE	55701946 , 55704106	
	1,4 16V	RR	10.2009		24.3727-0578.2	580578	HANDBRAKE CABLE	55701946 , 55704106	
		RL	10.2009		24.3727-0579.2	580579	HANDBRAKE CABLE	51844531 , 55700929 , 55704104	
		RL	10.2009		24.3727-0577.2	580577	HANDBRAKE CABLE	55701942 , 55704108	

New partnumbers on stock - according to applications

11/2012



					Description	OE numbers per ATE pn.	 e.g. replaced pn. / miscellaneous
--	--	--	--	--	--------------------	-------------------------------	---------------------------------------

FIAT

PUNTO / PUNTO EVO (09-)	1,4 Abarth	RL	10.2009		24.3727-0579.2	580579	HANDBRAKE CABLE	51844531 , 55700929 , 55704104	
	1,4 LPG	RL	06.2009		24.3727-0579.2	580579	HANDBRAKE CABLE	51844531 , 55700929 , 55704104	
	1,4 MultiAir	RL	03.2012		24.3727-0579.2	580579	HANDBRAKE CABLE	51844531 , 55700929 , 55704104	
		RR	03.2012		24.3727-0578.2	580578	HANDBRAKE CABLE	55701946 , 55704106	
		RL	03.2012		24.3727-0577.2	580577	HANDBRAKE CABLE	55701942 , 55704108	
	1,4 Natural Power	RL	10.2009		24.3727-0579.2	580579	HANDBRAKE CABLE	51844531 , 55700929 , 55704104	
	1,6 D Multijet	RL	10.2009		24.3727-0579.2	580579	HANDBRAKE CABLE	51844531 , 55700929 , 55704104	
	2,0 Abarth	RL	10.2009		24.3727-0579.2	580579	HANDBRAKE CABLE	51844531 , 55700929 , 55704104	
SCUDO (07-)	1,6 JTD		01.2007		24.0225-4021.1	480311	BRAKE DRUM	1401417180 , 4247 51 , 4247 56 , 1400178980	
	2,0 D Multijet		07.2010		24.0225-4021.1	480311	BRAKE DRUM	1401417180 , 4247 51 , 4247 56 , 1400178980	

New partnumbers on stock - according to applications

11/2012



					Description	OE numbers per ATE pn.	 e.g. replaced pn. / miscellaneous
--	--	--	--	--	--------------------	-------------------------------	---------------------------------------







HYUNDAI

Model	Engine	Side	Start	End	ATE PN	ATE PN	Description	OE numbers	Notes
ELANTRA (00-06)	1,6 i 16V	RL	09.2003	05.2006	24.3727-3112.2	583112	HANDBRAKE CABLE	59760-2D340 , 59760-2D350	
		RR	11.2003	05.2006	24.3727-3113.2	583113	HANDBRAKE CABLE	59770-2D340 , 59770-2D350	
	RR	09.2003	05.2006	24.3727-3113.2	583113	HANDBRAKE CABLE	59770-2D340 , 59770-2D350		
	RL	11.2003	05.2006	24.3727-3112.2	583112	HANDBRAKE CABLE	59760-2D340 , 59760-2D350		
	1,8 i 16V	RR	11.2003	05.2006	24.3727-3113.2	583113	HANDBRAKE CABLE	59770-2D340 , 59770-2D350	
		RR	06.2004	05.2006	24.3727-3113.2	583113	HANDBRAKE CABLE	59770-2D340 , 59770-2D350	
	RL	06.2004	05.2006	24.3727-3112.2	583112	HANDBRAKE CABLE	59760-2D340 , 59760-2D350		
	RL	11.2003	05.2006	24.3727-3112.2	583112	HANDBRAKE CABLE	59760-2D340 , 59760-2D350		
	2,0 CRDi	RR	11.2003	05.2006	24.3727-3113.2	583113	HANDBRAKE CABLE	59770-2D340 , 59770-2D350	
		RL	11.2003	05.2006	24.3727-3112.2	583112	HANDBRAKE CABLE	59760-2D340 , 59760-2D350	
	2,0 i 16V	RL	10.2003	05.2006	24.3727-3112.2	583112	HANDBRAKE CABLE	59760-2D340 , 59760-2D350	
		RR	11.2003	05.2006	24.3727-3113.2	583113	HANDBRAKE CABLE	59770-2D340 , 59770-2D350	
	RR	10.2003	05.2006	24.3727-3113.2	583113	HANDBRAKE CABLE	59770-2D340 , 59770-2D350		
	RL	11.2003	05.2006	24.3727-3112.2	583112	HANDBRAKE CABLE	59760-2D340 , 59760-2D350		
i20 (08-)	1,2 16V		09.2008		03.0137-3026.2	653026	BRAKE SHOE SET	58350-1JA30 , 58305-2KA00	
	1,4 16V		09.2008		03.0137-3026.2	653026	BRAKE SHOE SET	58350-1JA30 , 58305-2KA00	
	1,4 CRDi		09.2008		03.0137-3026.2	653026	BRAKE SHOE SET	58350-1JA30 , 58305-2KA00	
	1,6 16V		09.2008		03.0137-3026.2	653026	BRAKE SHOE SET	58350-1JA30 , 58305-2KA00	
	1,6 CRDi		09.2008		03.0137-3026.2	653026	BRAKE SHOE SET	58350-1JA30 , 58305-2KA00	

New partnumbers on stock - according to applications

11/2012



					Description	OE numbers per ATE pn.	 e.g. replaced pn. / miscellaneous
---	---	---	---	---	--------------------	-------------------------------	--

HYUNDAI

SANTA FE (CM) (06-)	2,2 CRDi		03.2006		24.0111-0146.1	411146	BRAKE DISC	58411-2B000	
	2,2 CRDi 4x4		03.2006		24.0111-0146.1	411146	BRAKE DISC	58411-2B000	
	2,7 i V6		03.2006		24.0111-0146.1	411146	BRAKE DISC	58411-2B000	
	2,7 i V6 4x4		03.2006		24.0111-0146.1	411146	BRAKE DISC	58411-2B000	

JEEP

GRAND CHEROKEE IV (WK) (10-)	3,0 CRD V6		02.2011		13.0460-7282.2	607282	BRAKE PADS	6805 2370AA , 6805 2369AA , 006 420 38 20 , 006 420 39 20	see drawing
	3,6 V6		11.2010		13.0460-7282.2	607282	BRAKE PADS	6805 2370AA , 6805 2369AA , 006 420 38 20 , 006 420 39 20	see drawing
	3,6 V6 4x4		11.2010		13.0460-7282.2	607282	BRAKE PADS	6805 2370AA , 6805 2369AA , 006 420 38 20 , 006 420 39 20	see drawing
	5,7 V8		11.2010		13.0460-7282.2	607282	BRAKE PADS	6805 2370AA , 6805 2369AA , 006 420 38 20 , 006 420 39 20	see drawing
	6,4 SRT8		03.2011		13.0460-7282.2	607282	BRAKE PADS	6805 2370AA , 6805 2369AA , 006 420 38 20 , 006 420 39 20	see drawing

New partnumbers on stock - according to applications

11/2012



	i				Description	OE numbers per ATE pn.	i e.g. replaced pn. / miscellaneous
--	----------	--	--	--	--------------------	-------------------------------	---

KIA

Model	Engine	Start	End	ATE PN	ATE PN	Description	OE numbers
RIO I (DC) (00-05)	1,3 i	08.2000	06.2002	24.0220-0006.1	480309	BRAKE DRUM	0K30A-26-251A, 0K30C-26-250A, 0K30A-26-250A
	1,5 i 16V	08.2000	06.2002	24.0220-0006.1	480309	BRAKE DRUM	0K30A-26-251A, 0K30C-26-250A, 0K30A-26-250A
SOUL (09-)	1,6 CRDi	02.2009		03.0137-3026.2	653026	BRAKE SHOE SET	58350-1JA30, 58305-2KA00
	1,6 CVT	02.2009		03.0137-3026.2	653026	BRAKE SHOE SET	58350-1JA30, 58305-2KA00
	1,6 i 16V	02.2009		03.0137-3026.2	653026	BRAKE SHOE SET	58350-1JA30, 58305-2KA00

New partnumbers on stock - according to applications

11/2012



					Description	OE numbers per ATE pn.	 e.g. replaced pn. / miscellaneous
--	--	--	--	--	--------------------	-------------------------------	---------------------------------------







MERCEDES BENZ

CL-Class (C216) Coupe (06-)	CL 500	RR	07.2006		11.9426-9960.2	220802	FIST CALIPER	221 423 04 81	
	CL 500 4-Matic	RR	03.2008		11.9426-9960.2	220802	FIST CALIPER	221 423 04 81	
	CL 500 BlueEfficiency	RR	10.2010		11.9426-9960.2	220802	FIST CALIPER	221 423 04 81	
CLS-Klasse (C218) Coupe (10-)	CLS 500	RR	11.2010		11.9426-9960.2	220802	FIST CALIPER	221 423 04 81	
	CLS 500 4matic	RR	11.2010		11.9426-9960.2	220802	FIST CALIPER	221 423 04 81	
CLS-Class (C219) Coupe (04-10)	CLS 500	RR	04.2006	10.2010	11.9426-9960.2	220802	FIST CALIPER	221 423 04 81	
CLS-Klasse (X218) Shooting Brake (12-)		RR	09.2012		11.9426-9960.2	220802	FIST CALIPER	221 423 04 81	
	CLS 500 4matic	RR	09.2012		11.9426-9960.2	220802	FIST CALIPER	221 423 04 81	
E-Class (S212) Estate (09-)	E 500	RR	09.2011		11.9426-9960.2	220802	FIST CALIPER	221 423 04 81	
		RR	11.2009		11.9426-9960.2	220802	FIST CALIPER	221 423 04 81	
	E 500 4-Matic	RR	09.2011		11.9426-9960.2	220802	FIST CALIPER	221 423 04 81	
E-Class (W212) Saloon (09-)	E 500	RR	09.2011		11.9426-9960.2	220802	FIST CALIPER	221 423 04 81	
		RR	03.2009		11.9426-9960.2	220802	FIST CALIPER	221 423 04 81	
	E 500 4-Matic	RR	09.2011		11.9426-9960.2	220802	FIST CALIPER	221 423 04 81	
		RR	03.2009		11.9426-9960.2	220802	FIST CALIPER	221 423 04 81	
GL-Klasse (X166) (12-)	GL 350 BT 4Matic		07.2012		13.0460-7282.2	607282	BRAKE PADS	6805 2370AA , 6805 2369AA , 006 420 38 20 , 006 420 39 20	see drawing
M-Klasse (W166) (11-)	ML 250 CDI BT 4matic		06.2011		13.0460-7282.2	607282	BRAKE PADS	6805 2370AA , 6805 2369AA , 006 420 38 20 , 006 420 39 20	see drawing

New partnumbers on stock - according to applications

11/2012



					Description	OE numbers per ATE pn.	 e.g. replaced pn. / miscellaneous
---	---	---	---	---	--------------------	-------------------------------	--

MERCEDES BENZ

M-Klasse (W166) (11-)	ML 350 BE 4matic		06.2011		13.0460-7282.2	607282	BRAKE PADS	6805 2370AA , 6805 2369AA , 006 420 38 20 , 006 420 39 20	see drawing
	ML 350 BT 4matic		06.2011		13.0460-7282.2	607282	BRAKE PADS	6805 2370AA , 6805 2369AA , 006 420 38 20 , 006 420 39 20	see drawing
	ML 350 CDI 4matic		06.2011		13.0460-7282.2	607282	BRAKE PADS	6805 2370AA , 6805 2369AA , 006 420 38 20 , 006 420 39 20	see drawing
	ML 400 Hybrid 4matic		02.2012		13.0460-7282.2	607282	BRAKE PADS	6805 2370AA , 6805 2369AA , 006 420 38 20 , 006 420 39 20	see drawing
S-Class (W221) (06-)	S 250 CDI	RR	01.2011		11.9426-9960.2	220802	FIST CALIPER	221 423 04 81	
	S 400 Hybrid	RR	06.2009		11.9426-9960.2	220802	FIST CALIPER	221 423 04 81	
	S 420 CDI	RR	04.2006		11.9426-9960.2	220802	FIST CALIPER	221 423 04 81	
	S 450	RR	04.2006		11.9426-9960.2	220802	FIST CALIPER	221 423 04 81	
	S 450 4-Matic	RR	04.2006		11.9426-9960.2	220802	FIST CALIPER	221 423 04 81	
	S 500	RR	12.2005		11.9426-9960.2	220802	FIST CALIPER	221 423 04 81	
	S 500 4-Matic	RR	04.2006		11.9426-9960.2	220802	FIST CALIPER	221 423 04 81	
SL-Class (R129) (93-01)	SL 280	FL		09.2001	24.9442-8003.5	230053	FIXED CALIPER	000 420 79 83 , 129 420 00 83	13.4421-8003.2
		FL	08.1993		24.9442-8003.5	230053	FIXED CALIPER	000 420 79 83 , 129 420 00 83	13.4421-8003.2
	SL 320	FL	05.1998		24.9442-8003.5	230053	FIXED CALIPER	000 420 79 83 , 129 420 00 83	13.4421-8003.2

New partnumbers on stock - according to applications

11/2012



					Description	OE numbers per ATE pn.	 e.g. replaced pn. / miscellaneous
--	--	--	--	--	--------------------	-------------------------------	---------------------------------------







MERCEDES BENZ

Model	Part Number	Side	Start Date	End Date	ATE Part Number	Description	OE Numbers	ATE Part Number	
SL-Class (R129) (93-01)	SL 320	FL	08.1993		24.9442-8003.5	230053	FIXED CALIPER	000 420 79 83 , 129 420 00 83	13.4421-8003.2
	SL 500	FL	08.1993		24.9442-8003.5	230053	FIXED CALIPER	000 420 79 83 , 129 420 00 83	13.4421-8003.2
	SL 60 AMG	FL	05.1994		24.9442-8003.5	230053	FIXED CALIPER	000 420 79 83 , 129 420 00 83	13.4421-8003.2
SL-Klasse (R230) (01-11)	SL 280	RR	11.2007	11.2011	11.9426-9960.2	220802	FIST CALIPER	221 423 04 81	

New partnumbers on stock - according to applications

11/2012



					Description	OE numbers per ATE pn.	 e.g. replaced pn. / miscellaneous
---	---	---	---	---	--------------------	-------------------------------	--

MG

ZT Saloon (01-05)	1,8 16V (160)	RR	06.2001	12.2005	11.9361-9962.2	220856	FIST CALIPER	SOB100030 , GBC90194	
		RL	06.2001	12.2005	11.9361-9961.2	220855	FIST CALIPER	SOB100020 , GBC90196	
	1,8 T 16V (160)	RR	01.2003	12.2005	11.9361-9962.2	220856	FIST CALIPER	SOB100030 , GBC90194	
		RL	01.2003	12.2005	11.9361-9961.2	220855	FIST CALIPER	SOB100020 , GBC90196	
	2,0 CDTi	RR	11.2002	12.2005	11.9361-9962.2	220856	FIST CALIPER	SOB100030 , GBC90194	
		RL	06.2002	09.2003	11.9361-9961.2	220855	FIST CALIPER	SOB100020 , GBC90196	
		RR	06.2002	09.2003	11.9361-9962.2	220856	FIST CALIPER	SOB100030 , GBC90194	
		RL	11.2002	12.2005	11.9361-9961.2	220855	FIST CALIPER	SOB100020 , GBC90196	
	2,5 V6 (180)	RR	01.2003	12.2005	11.9361-9962.2	220856	FIST CALIPER	SOB100030 , GBC90194	
		RL	01.2003	12.2005	11.9361-9961.2	220855	FIST CALIPER	SOB100020 , GBC90196	
	2,5 V6 (190)	RL	06.2001	12.2005	11.9361-9961.2	220855	FIST CALIPER	SOB100020 , GBC90196	
		RR	06.2001	12.2005	11.9361-9962.2	220856	FIST CALIPER	SOB100030 , GBC90194	
ZT-T Estate (01-05)	1,8 16V (160)	RL	10.2001	12.2005	11.9361-9961.2	220855	FIST CALIPER	SOB100020 , GBC90196	
		RR	10.2001	12.2005	11.9361-9962.2	220856	FIST CALIPER	SOB100030 , GBC90194	
	1,8 T 16V (160)	RL	01.2003	12.2005	11.9361-9961.2	220855	FIST CALIPER	SOB100020 , GBC90196	
		RR	01.2003	12.2005	11.9361-9962.2	220856	FIST CALIPER	SOB100030 , GBC90194	
	2,0 CDTi	RL	11.2002	12.2005	11.9361-9961.2	220855	FIST CALIPER	SOB100020 , GBC90196	
		RR	06.2002	09.2003	11.9361-9962.2	220856	FIST CALIPER	SOB100030 , GBC90194	
		RR	11.2002	12.2005	11.9361-9962.2	220856	FIST CALIPER	SOB100030 , GBC90194	

New partnumbers on stock - according to applications

11/2012



					Description	OE numbers per ATE pn.	 e.g. replaced pn. / miscellaneous
--	--	--	--	--	--------------------	-------------------------------	---------------------------------------

MG

ZT-T Estate (01-05)	2,0 CDTi	RL	06.2002	09.2003	11.9361-9961.2	220855	FIST CALIPER	SOB100020 , GBC90196	
	2,5 V6 (180)	RL	01.2003	12.2005	11.9361-9961.2	220855	FIST CALIPER	SOB100020 , GBC90196	
		RR	01.2003	12.2005	11.9361-9962.2	220856	FIST CALIPER	SOB100030 , GBC90194	
	2,5 V6 (190)	RR	10.2001	12.2005	11.9361-9962.2	220856	FIST CALIPER	SOB100030 , GBC90194	
		RL	10.2001	12.2005	11.9361-9961.2	220855	FIST CALIPER	SOB100020 , GBC90196	





NISSAN

ALMERA TINO (V10M) (00-05)	1,6 i 16V	RR	08.2000	11.2005	24.3727-1735.2	581735	HANDBRAKE CABLE	36530-BU80A , 36530-BU000	
		RL	08.2000	11.2005	24.3727-1734.2	581734	HANDBRAKE CABLE	36531-BU80A , 36531-BU000	
	1,8 i 16V	RL	12.2002	11.2005	24.3727-1734.2	581734	HANDBRAKE CABLE	36531-BU80A , 36531-BU000	
		RR	08.2000	11.2005	24.3727-1735.2	581735	HANDBRAKE CABLE	36530-BU80A , 36530-BU000	
		RR	12.2002	11.2005	24.3727-1735.2	581735	HANDBRAKE CABLE	36530-BU80A , 36530-BU000	
		RL	08.2000	11.2005	24.3727-1734.2	581734	HANDBRAKE CABLE	36531-BU80A , 36531-BU000	
	2,0 i 16V	RL	08.2000	08.2003	24.3727-1734.2	581734	HANDBRAKE CABLE	36531-BU80A , 36531-BU000	
		RR	08.2000	08.2003	24.3727-1735.2	581735	HANDBRAKE CABLE	36530-BU80A , 36530-BU000	
	2,2 dCi	RL	09.2003	11.2005	24.3727-1734.2	581734	HANDBRAKE CABLE	36531-BU80A , 36531-BU000	
		RR	09.2003	11.2005	24.3727-1735.2	581735	HANDBRAKE CABLE	36530-BU80A , 36530-BU000	
	2,2 Di	RR	08.2000	08.2003	24.3727-1735.2	581735	HANDBRAKE CABLE	36530-BU80A , 36530-BU000	
		RL	08.2000	08.2003	24.3727-1734.2	581734	HANDBRAKE CABLE	36531-BU80A , 36531-BU000	

New partnumbers on stock - according to applications

11/2012



	i				Description	OE numbers per ATE pn.	i e.g. replaced pn. / miscellaneous
---	----------	---	---	---	--------------------	-------------------------------	---







OPEL

CALIBRA / Vauxhall Calibra (89-97)	2,0 Turbo	FR	03.1992		24.3541-8086.5	240526	FIST CALIPER	5 42 100 , 90443868 , 4482543	11.3541-8086.2
	2,5	FR	02.1993		24.3541-8086.5	240526	FIST CALIPER	5 42 100 , 90443868 , 4482543	11.3541-8086.2
VECTRA A / Vauxhall Cavalier (89-95)	2,0 Turbo	FR	03.1992	08.1995	24.3541-8086.5	240526	FIST CALIPER	5 42 100 , 90443868 , 4482543	11.3541-8086.2
	2,5 i	FR	02.1993	08.1995	24.3541-8086.5	240526	FIST CALIPER	5 42 100 , 90443868 , 4482543	11.3541-8086.2

New partnumbers on stock - according to applications

11/2012



					Description	OE numbers per ATE pn.	 e.g. replaced pn. / miscellaneous
---	---	---	---	---	--------------------	-------------------------------	--







PEUGEOT

407 Coupe (05-11)	2,2 16V	FL	10.2005		24.5161-0315.3	331186	BRAKE HOSE	4806 F9	
		FR	10.2005		24.5161-0316.3	331187	BRAKE HOSE	4806 G0	
	2,7 HDi	FR	10.2005		24.5161-0316.3	331187	BRAKE HOSE	4806 G0	
		FL	10.2005		24.5161-0315.3	331186	BRAKE HOSE	4806 F9	
	3,0 V6	FL	10.2005		24.5161-0315.3	331186	BRAKE HOSE	4806 F9	
		FR	10.2005		24.5161-0316.3	331187	BRAKE HOSE	4806 G0	
407 Limousine (04-11)	1,6 HDi 110	FL			24.5161-0315.3	331186	BRAKE HOSE	4806 F9	
		FR			24.5161-0316.3	331187	BRAKE HOSE	4806 G0	
	1,8 16V	FL			24.5161-0315.3	331186	BRAKE HOSE	4806 F9	
		FL	09.2005		24.5161-0315.3	331186	BRAKE HOSE	4806 F9	
		FR	09.2005		24.5161-0316.3	331187	BRAKE HOSE	4806 G0	
		FR			24.5161-0316.3	331187	BRAKE HOSE	4806 G0	
	2,0 16V	FR	09.2005		24.5161-0316.3	331187	BRAKE HOSE	4806 G0	
		FL	09.2005		24.5161-0315.3	331186	BRAKE HOSE	4806 F9	
		FL			24.5161-0315.3	331186	BRAKE HOSE	4806 F9	
		FR			24.5161-0316.3	331187	BRAKE HOSE	4806 G0	
	2,0 Bioflex	FR			24.5161-0316.3	331187	BRAKE HOSE	4806 G0	
		FL			24.5161-0315.3	331186	BRAKE HOSE	4806 F9	
	2,0 HDi 135	FR			24.5161-0316.3	331187	BRAKE HOSE	4806 G0	

New partnumbers on stock - according to applications

11/2012



					Description	OE numbers per ATE pn.	 e.g. replaced pn. / miscellaneous
---	---	---	---	---	--------------------	-------------------------------	--

PEUGEOT

407 Limousine (04-11)	2,0 HDi 135	FL			24.5161-0315.3	331186	BRAKE HOSE	4806 F9	
	2,0 HDi 140	FR			24.5161-0316.3	331187	BRAKE HOSE	4806 G0	
		FL			24.5161-0315.3	331186	BRAKE HOSE	4806 F9	
	2,2 16V	FL	09.2005		24.5161-0315.3	331186	BRAKE HOSE	4806 F9	
		FL			24.5161-0315.3	331186	BRAKE HOSE	4806 F9	
		FR	09.2005		24.5161-0316.3	331187	BRAKE HOSE	4806 G0	
		FR			24.5161-0316.3	331187	BRAKE HOSE	4806 G0	
	2,2 HDi	FR	06.2008		24.5161-0316.3	331187	BRAKE HOSE	4806 G0	
		FL	06.2008		24.5161-0315.3	331186	BRAKE HOSE	4806 F9	
	2,2 HDi 170	FR	05.2006		24.5161-0316.3	331187	BRAKE HOSE	4806 G0	
		FL	05.2006		24.5161-0315.3	331186	BRAKE HOSE	4806 F9	
	2,7 HDi	FL	10.2005		24.5161-0315.3	331186	BRAKE HOSE	4806 F9	
		FR	10.2005		24.5161-0316.3	331187	BRAKE HOSE	4806 G0	
	3,0 V6	FL			24.5161-0315.3	331186	BRAKE HOSE	4806 F9	
		FR			24.5161-0316.3	331187	BRAKE HOSE	4806 G0	
407 SW (04-11)	1,6 HDi 110	FL			24.5161-0315.3	331186	BRAKE HOSE	4806 F9	
		FR			24.5161-0316.3	331187	BRAKE HOSE	4806 G0	
	1,8 16V	FL			24.5161-0315.3	331186	BRAKE HOSE	4806 F9	
		FL	09.2005		24.5161-0315.3	331186	BRAKE HOSE	4806 F9	

New partnumbers on stock - according to applications

11/2012



					Description	OE numbers per ATE pn.	 e.g. replaced pn. / miscellaneous
--	--	--	--	--	--------------------	-------------------------------	---------------------------------------

PEUGEOT

407 SW (04-11)	1,8 16V	FR			24.5161-0316.3	331187	BRAKE HOSE	4806 G0	
		FR	09.2005		24.5161-0316.3	331187	BRAKE HOSE	4806 G0	
	2,0 16V	FL	09.2005		24.5161-0315.3	331186	BRAKE HOSE	4806 F9	
		FR			24.5161-0316.3	331187	BRAKE HOSE	4806 G0	
		FR	09.2005		24.5161-0316.3	331187	BRAKE HOSE	4806 G0	
		FL			24.5161-0315.3	331186	BRAKE HOSE	4806 F9	
	2,0 BioFlex	FR			24.5161-0316.3	331187	BRAKE HOSE	4806 G0	
		FL			24.5161-0315.3	331186	BRAKE HOSE	4806 F9	
	2,0 HDi 135	FR			24.5161-0316.3	331187	BRAKE HOSE	4806 G0	
		FL			24.5161-0315.3	331186	BRAKE HOSE	4806 F9	
	2,0 HDi 140	FR			24.5161-0316.3	331187	BRAKE HOSE	4806 G0	
		FL			24.5161-0315.3	331186	BRAKE HOSE	4806 F9	
	2,2 16V	FL	09.2005		24.5161-0315.3	331186	BRAKE HOSE	4806 F9	
		FR			24.5161-0316.3	331187	BRAKE HOSE	4806 G0	
		FR	09.2005		24.5161-0316.3	331187	BRAKE HOSE	4806 G0	
		FL			24.5161-0315.3	331186	BRAKE HOSE	4806 F9	
	2,2 HDi	FL			24.5161-0315.3	331186	BRAKE HOSE	4806 F9	
		FR			24.5161-0316.3	331187	BRAKE HOSE	4806 G0	
	2,2 HDi 170	FL	05.2006		24.5161-0315.3	331186	BRAKE HOSE	4806 F9	

New partnumbers on stock - according to applications

11/2012



					Description	OE numbers per ATE pn.	 e.g. replaced pn. / miscellaneous
--	--	--	--	--	--------------------	-------------------------------	---------------------------------------

PEUGEOT

407 SW (04-11)	2,2 HDi 170	FR	05.2006		24.5161-0316.3	331187	BRAKE HOSE	4806 G0	
	2,7 HDi	FR	10.2005		24.5161-0316.3	331187	BRAKE HOSE	4806 G0	
		FL	10.2005		24.5161-0315.3	331186	BRAKE HOSE	4806 F9	
	3,0 V6	FR			24.5161-0316.3	331187	BRAKE HOSE	4806 G0	
		FL			24.5161-0315.3	331186	BRAKE HOSE	4806 F9	
508 (10-)	1,6 HDi		11.2010		13.0460-7278.2	607278	BRAKE PADS	4254 A8	see drawing
			02.2012		13.0460-7278.2	607278	BRAKE PADS	4254 A8	see drawing
	1,6 THP		11.2010		13.0460-7278.2	607278	BRAKE PADS	4254 A8	see drawing
	1,6 VTi		11.2010		13.0460-7278.2	607278	BRAKE PADS	4254 A8	see drawing
	2,0 HDi		11.2010		13.0460-7278.2	607278	BRAKE PADS	4254 A8	see drawing
	2,0 HDi AWC		11.2010		13.0460-7278.2	607278	BRAKE PADS	4254 A8	see drawing
	2,2 HDi		11.2010		13.0460-7278.2	607278	BRAKE PADS	4254 A8	see drawing
508 SW (10-)	1,6 HDi		02.2012		13.0460-7278.2	607278	BRAKE PADS	4254 A8	see drawing
			11.2010		13.0460-7278.2	607278	BRAKE PADS	4254 A8	see drawing
	1,6 THP		11.2010		13.0460-7278.2	607278	BRAKE PADS	4254 A8	see drawing
	1,6 VTi		11.2010		13.0460-7278.2	607278	BRAKE PADS	4254 A8	see drawing
	2,0 HDi		11.2010		13.0460-7278.2	607278	BRAKE PADS	4254 A8	see drawing
	2,2 HDi		11.2010		13.0460-7278.2	607278	BRAKE PADS	4254 A8	see drawing
EXPERT Tepee (07-)	1,6 HDi 90		01.2007		24.0225-4021.1	480311	BRAKE DRUM	1401417180 , 4247 51 , 4247 56 , 1400178980	



				<p>Description</p>	<p>OE numbers per ATE pn.</p>	 <p>e.g. replaced pn. / miscellaneous</p>
--	--	--	--	--------------------	-----------------------------------	--

PEUGEOT

New partnumbers on stock - according to applications

11/2012



					Description	OE numbers per ATE pn.	 e.g. replaced pn. / miscellaneous
--	--	--	--	--	--------------------	-------------------------------	---------------------------------------

PORSCHE

CAYENNE I (03-10)	3,0 TDI		02.2009	04.2010	13.0460-4852.2	604852	BRAKE PADS	7L0 698 151 M , 7L0 698 151 N , 7P0 698 151 , 7P0 698 151 B , 7P6 698 151 , 7P6 698 151 B , 7P0 698 151 C , 955 351 939 61 , 955 351 939 62 , 955 351 939 63	see drawing
	3,2		08.2003	04.2010	13.0460-4852.2	604852	BRAKE PADS	7L0 698 151 M , 7L0 698 151 N , 7P0 698 151 , 7P0 698 151 B , 7P6 698 151 , 7P6 698 151 B , 7P0 698 151 C , 955 351 939 61 , 955 351 939 62 , 955 351 939 63	see drawing
			10.2003	12.2006	13.0460-4852.2	604852	BRAKE PADS	7L0 698 151 M , 7L0 698 151 N , 7P0 698 151 , 7P0 698 151 B , 7P6 698 151 , 7P6 698 151 B , 7P0 698 151 C , 955 351 939 61 , 955 351 939 62 , 955 351 939 63	see drawing
	3,6		01.2007	04.2010	13.0460-4852.2	604852	BRAKE PADS	7L0 698 151 M , 7L0 698 151 N , 7P0 698 151 , 7P0 698 151 B , 7P6 698 151 , 7P6 698 151 B , 7P0 698 151 C , 955 351 939 61 , 955 351 939 62 , 955 351 939 63	see drawing
	GTS 4,8		10.2007	04.2010	13.0460-4852.2	604852	BRAKE PADS	7L0 698 151 M , 7L0 698 151 N , 7P0 698 151 , 7P0 698 151 B , 7P6 698 151 , 7P6 698 151 B , 7P0 698 151 C , 955 351 939 61 , 955 351 939 62 , 955 351 939 63	see drawing
	S 4,5		08.2002	12.2006	13.0460-4852.2	604852	BRAKE PADS	7L0 698 151 M , 7L0 698 151 N , 7P0 698 151 , 7P0 698 151 B , 7P6 698 151 , 7P6 698 151 B , 7P0 698 151 C , 955 351 939 61 , 955 351 939 62 , 955 351 939 63	see drawing

New partnumbers on stock - according to applications

11/2012



					Description	OE numbers per ATE pn.	 e.g. replaced pn. / miscellaneous
--	--	--	--	--	--------------------	-------------------------------	---------------------------------------







PORSCHE

CAYENNE I (03-10)	S 4,8		01.2007	04.2010	13.0460-4852.2	604852	BRAKE PADS	7L0 698 151 M , 7L0 698 151 N , 7P0 698 151 , 7P0 698 151 B , 7P6 698 151 , 7P6 698 151 B , 7P0 698 151 C , 955 351 939 61 , 955 351 939 62 , 955 351 939 63	see drawing
	Turbo 4,5		09.2002	12.2006	13.0460-4852.2	604852	BRAKE PADS	7L0 698 151 M , 7L0 698 151 N , 7P0 698 151 , 7P0 698 151 B , 7P6 698 151 , 7P6 698 151 B , 7P0 698 151 C , 955 351 939 61 , 955 351 939 62 , 955 351 939 63	see drawing
	Turbo 4,8		01.2007	04.2010	13.0460-4852.2	604852	BRAKE PADS	7L0 698 151 M , 7L0 698 151 N , 7P0 698 151 , 7P0 698 151 B , 7P6 698 151 , 7P6 698 151 B , 7P0 698 151 C , 955 351 939 61 , 955 351 939 62 , 955 351 939 63	see drawing
	Turbo S 4,5		01.2004	04.2010	13.0460-4852.2	604852	BRAKE PADS	7L0 698 151 M , 7L0 698 151 N , 7P0 698 151 , 7P0 698 151 B , 7P6 698 151 , 7P6 698 151 B , 7P0 698 151 C , 955 351 939 61 , 955 351 939 62 , 955 351 939 63	see drawing
	Turbo S 4,8		02.2007	04.2010	13.0460-4852.2	604852	BRAKE PADS	7L0 698 151 M , 7L0 698 151 N , 7P0 698 151 , 7P0 698 151 B , 7P6 698 151 , 7P6 698 151 B , 7P0 698 151 C , 955 351 939 61 , 955 351 939 62 , 955 351 939 63	see drawing
			08.2008	04.2010	13.0460-4852.2	604852	BRAKE PADS	7L0 698 151 M , 7L0 698 151 N , 7P0 698 151 , 7P0 698 151 B , 7P6 698 151 , 7P6 698 151 B , 7P0 698 151 C , 955 351 939 61 , 955 351 939 62 , 955 351 939 63	see drawing

New partnumbers on stock - according to applications

11/2012



					Description	OE numbers per ATE pn.	 e.g. replaced pn. / miscellaneous
---	---	---	---	---	--------------------	-------------------------------	--

PORSCHE

CAYENNE II (10-)	3,0 D		06.2010		24.8190-0015.2	620015	WEAR INDICATOR	7P0 907 637 C , 958 612 365 50	
			06.2010		24.8190-0014.2	620014	WEAR INDICATOR	7P0 907 637 A , 958 612 365 00	
	3,6		06.2010		24.8190-0015.2	620015	WEAR INDICATOR	7P0 907 637 C , 958 612 365 50	
			06.2010		24.8190-0014.2	620014	WEAR INDICATOR	7P0 907 637 A , 958 612 365 00	
	4,8 Turbo		06.2010		24.8190-0014.2	620014	WEAR INDICATOR	7P0 907 637 A , 958 612 365 00	
			06.2010		24.8190-0015.2	620015	WEAR INDICATOR	7P0 907 637 C , 958 612 365 50	
	GTS 4,8		04.2012		24.8190-0014.2	620014	WEAR INDICATOR	7P0 907 637 A , 958 612 365 00	
			04.2012		24.8190-0015.2	620015	WEAR INDICATOR	7P0 907 637 C , 958 612 365 50	
	S 4,8		06.2010		24.8190-0015.2	620015	WEAR INDICATOR	7P0 907 637 C , 958 612 365 50	
			06.2010		24.8190-0014.2	620014	WEAR INDICATOR	7P0 907 637 A , 958 612 365 00	
	S Hybrid 3,0		06.2010		24.8190-0015.2	620015	WEAR INDICATOR	7P0 907 637 C , 958 612 365 50	
			06.2010		24.8190-0014.2	620014	WEAR INDICATOR	7P0 907 637 A , 958 612 365 00	
PANAMERA (10-)	3,0 D		08.2011		24.8190-0014.2	620014	WEAR INDICATOR	7P0 907 637 A , 958 612 365 00	

New partnumbers on stock - according to applications

11/2012



					Description	OE numbers per ATE pn.	 e.g. replaced pn. / miscellaneous
--	--	--	--	--	--------------------	-------------------------------	---------------------------------------

PORSCHE

PANAMERA (10-)	3,6		05.2010		24.8190-0014.2	620014	WEAR INDICATOR	7P0 907 637 A , 958 612 365 00	
	3,6 4		05.2010		24.8190-0014.2	620014	WEAR INDICATOR	7P0 907 637 A , 958 612 365 00	
	4,8 4S		09.2009		13.0460-4852.2	604852	BRAKE PADS	7L0 698 151 M , 7L0 698 151 N , 7P0 698 151 , 7P0 698 151 B , 7P6 698 151 , 7P6 698 151 B , 7P0 698 151 C , 955 351 939 61 , 955 351 939 62 , 955 351 939 63	see drawing
	4,8 GTS		01.2012		13.0460-4852.2	604852	BRAKE PADS	7L0 698 151 M , 7L0 698 151 N , 7P0 698 151 , 7P0 698 151 B , 7P6 698 151 , 7P6 698 151 B , 7P0 698 151 C , 955 351 939 61 , 955 351 939 62 , 955 351 939 63	see drawing
	4,8 S		09.2009		13.0460-4852.2	604852	BRAKE PADS	7L0 698 151 M , 7L0 698 151 N , 7P0 698 151 , 7P0 698 151 B , 7P6 698 151 , 7P6 698 151 B , 7P0 698 151 C , 955 351 939 61 , 955 351 939 62 , 955 351 939 63	see drawing
	4,8 Turbo		09.2009		13.0460-4852.2	604852	BRAKE PADS	7L0 698 151 M , 7L0 698 151 N , 7P0 698 151 , 7P0 698 151 B , 7P6 698 151 , 7P6 698 151 B , 7P0 698 151 C , 955 351 939 61 , 955 351 939 62 , 955 351 939 63	see drawing
	4,8 Turbo S		05.2011		13.0460-4852.2	604852	BRAKE PADS	7L0 698 151 M , 7L0 698 151 N , 7P0 698 151 , 7P0 698 151 B , 7P6 698 151 , 7P6 698 151 B , 7P0 698 151 C , 955 351 939 61 , 955 351 939 62 , 955 351 939 63	see drawing

New partnumbers on stock - according to applications

11/2012



					Description	OE numbers per ATE pn.	 e.g. replaced pn. / miscellaneous
--	--	--	--	--	--------------------	-------------------------------	---------------------------------------

RENAULT

Model	Engine	RR	09.2008		24.3727-1088.2	581088	HANDBRAKE CABLE	36 53 0JY 00A
KOLEOS (HY0_) (08-)	2,0 dCi	RR	09.2008		24.3727-1088.2	581088	HANDBRAKE CABLE	36 53 0JY 00A
		RL	09.2008		24.3727-1087.2	581087	HANDBRAKE CABLE	36 53 1JY 00A
	2,0 dCi 4x4	RR	09.2008		24.3727-1088.2	581088	HANDBRAKE CABLE	36 53 0JY 00A
		RL	09.2008		24.3727-1087.2	581087	HANDBRAKE CABLE	36 53 1JY 00A
	2,5 16V	RL	09.2008		24.3727-1087.2	581087	HANDBRAKE CABLE	36 53 1JY 00A
		RR	09.2008		24.3727-1088.2	581088	HANDBRAKE CABLE	36 53 0JY 00A
	2,5 16V 4x4	RL	09.2008		24.3727-1087.2	581087	HANDBRAKE CABLE	36 53 1JY 00A
		RR	09.2008		24.3727-1088.2	581088	HANDBRAKE CABLE	36 53 0JY 00A
LAGUNA II Grandtour (KG_) (01-07)	1,6 16V		03.2001	06.2007	13.0470-7158.2	LD7158	CERAMIC BRAKE PADS	77 01 206 599 , 77 01 208 182 , 77 01 209 809
	1,6 FlexFuel		06.2001	10.2003	13.0470-7158.2	LD7158	CERAMIC BRAKE PADS	77 01 206 599 , 77 01 208 182 , 77 01 209 809
	1,8 16V (O4/O6/OV)		03.2001	06.2007	13.0470-7158.2	LD7158	CERAMIC BRAKE PADS	77 01 206 599 , 77 01 208 182 , 77 01 209 809
	1,8 16V (OB/OC/OM)		03.2001	06.2007	13.0470-7158.2	LD7158	CERAMIC BRAKE PADS	77 01 206 599 , 77 01 208 182 , 77 01 209 809
	1,8 16V (OJ)		03.2001	06.2007	13.0470-7158.2	LD7158	CERAMIC BRAKE PADS	77 01 206 599 , 77 01 208 182 , 77 01 209 809
	1,9 dCi		03.2001	06.2007	13.0470-7158.2	LD7158	CERAMIC BRAKE PADS	77 01 206 599 , 77 01 208 182 , 77 01 209 809
			01.2005	06.2007	13.0470-7158.2	LD7158	CERAMIC BRAKE PADS	77 01 206 599 , 77 01 208 182 , 77 01 209 809
			05.2005	06.2007	13.0470-7158.2	LD7158	CERAMIC BRAKE PADS	77 01 206 599 , 77 01 208 182 , 77 01 209 809

New partnumbers on stock - according to applications

11/2012



					Description	OE numbers per ATE pn.	 e.g. replaced pn. / miscellaneous
--	--	--	--	--	--------------------	-------------------------------	---------------------------------------

RENAULT

Model	Engine	Start	End	ATE Part No.	ATE Part No.	Description	OE numbers	Notes
LAGUNA II Grandtour (KG_) (01-07)	1,9 dCi (08/10)	03.2004	06.2007	13.0470-7158.2	LD7158	CERAMIC BRAKE PADS	77 01 206 599 , 77 01 208 182 , 77 01 209 809	
	1,9 dCi (OE)	06.2001	06.2007	13.0470-7158.2	LD7158	CERAMIC BRAKE PADS	77 01 206 599 , 77 01 208 182 , 77 01 209 809	
	1,9 dCi (OG)	03.2001	06.2007	13.0470-7158.2	LD7158	CERAMIC BRAKE PADS	77 01 206 599 , 77 01 208 182 , 77 01 209 809	
	1,9 dCi (OR)	10.2001	06.2007	13.0470-7158.2	LD7158	CERAMIC BRAKE PADS	77 01 206 599 , 77 01 208 182 , 77 01 209 809	
	2,0 16V (OO/OK/OW)	08.2002	06.2007	13.0470-7158.2	LD7158	CERAMIC BRAKE PADS	77 01 206 599 , 77 01 208 182 , 77 01 209 809	
	2,0 16V IDE (ON/OP)	04.2001	06.2007	13.0470-7158.2	LD7158	CERAMIC BRAKE PADS	77 01 206 599 , 77 01 208 182 , 77 01 209 809	
	2,2 dCi	05.2005	06.2007	13.0470-7158.2	LD7158	CERAMIC BRAKE PADS	77 01 206 599 , 77 01 208 182 , 77 01 209 809	
		10.2001	11.2001	13.0470-7158.2	LD7158	CERAMIC BRAKE PADS	77 01 206 599 , 77 01 208 182 , 77 01 209 809	
LAGUNA II Saloon (BG_) (01-07)	1,6 16V	03.2001	06.2007	13.0470-7158.2	LD7158	CERAMIC BRAKE PADS	77 01 206 599 , 77 01 208 182 , 77 01 209 809	
		02.2005	06.2007	13.0470-7158.2	LD7158	CERAMIC BRAKE PADS	77 01 206 599 , 77 01 208 182 , 77 01 209 809	
	1,8 16V (O4/O6/OV)	03.2001	06.2007	13.0470-7158.2	LD7158	CERAMIC BRAKE PADS	77 01 206 599 , 77 01 208 182 , 77 01 209 809	
	1,8 16V (OB/OC/OM)	03.2001	06.2007	13.0470-7158.2	LD7158	CERAMIC BRAKE PADS	77 01 206 599 , 77 01 208 182 , 77 01 209 809	
	1,8 16V (OJ)	03.2001	06.2007	13.0470-7158.2	LD7158	CERAMIC BRAKE PADS	77 01 206 599 , 77 01 208 182 , 77 01 209 809	

New partnumbers on stock - according to applications

11/2012



					Description	OE numbers per ATE pn.	 e.g. replaced pn. / miscellaneous
--	--	--	--	--	--------------------	-------------------------------	---------------------------------------

RENAULT

Model	Engine	Start	End	Part No.	ATE No.	Description	OE numbers	Notes
LAGUNA II Saloon (BG_) (01-07)	1,9 dCi	03.2001	06.2007	13.0470-7158.2	LD7158	CERAMIC BRAKE PADS	77 01 206 599 , 77 01 208 182 , 77 01 209 809	
		01.2005	06.2007	13.0470-7158.2	LD7158	CERAMIC BRAKE PADS	77 01 206 599 , 77 01 208 182 , 77 01 209 809	
		05.2005	06.2007	13.0470-7158.2	LD7158	CERAMIC BRAKE PADS	77 01 206 599 , 77 01 208 182 , 77 01 209 809	
	1,9 dCi (08/10)	03.2004	06.2007	13.0470-7158.2	LD7158	CERAMIC BRAKE PADS	77 01 206 599 , 77 01 208 182 , 77 01 209 809	
	1,9 dCi (OE)	06.2001	06.2007	13.0470-7158.2	LD7158	CERAMIC BRAKE PADS	77 01 206 599 , 77 01 208 182 , 77 01 209 809	
	1,9 dCi (OG)	03.2001	06.2007	13.0470-7158.2	LD7158	CERAMIC BRAKE PADS	77 01 206 599 , 77 01 208 182 , 77 01 209 809	
	1,9 dCi (OR)	10.2001	06.2007	13.0470-7158.2	LD7158	CERAMIC BRAKE PADS	77 01 206 599 , 77 01 208 182 , 77 01 209 809	
	2,0 16V (OO/OK/OW)	08.2002	06.2007	13.0470-7158.2	LD7158	CERAMIC BRAKE PADS	77 01 206 599 , 77 01 208 182 , 77 01 209 809	
	2,0 16V IDE (ON/OP)	04.2001	06.2007	13.0470-7158.2	LD7158	CERAMIC BRAKE PADS	77 01 206 599 , 77 01 208 182 , 77 01 209 809	
	2,2 dCi	10.2001	11.2001	13.0470-7158.2	LD7158	CERAMIC BRAKE PADS	77 01 206 599 , 77 01 208 182 , 77 01 209 809	
		05.2005	06.2007	13.0470-7158.2	LD7158	CERAMIC BRAKE PADS	77 01 206 599 , 77 01 208 182 , 77 01 209 809	

New partnumbers on stock - according to applications

11/2012



					Description	OE numbers per ATE pn.	 e.g. replaced pn. / miscellaneous
--	--	--	--	--	--------------------	-------------------------------	---------------------------------------

ROVER

75 series (RX) (04-)	1,8	RL	04.2004		11.9361-9961.2	220855	FIST CALIPER	SOB100020 , GBC90196	
		RR	04.2004		11.9361-9962.2	220856	FIST CALIPER	SOB100030 , GBC90194	
	1,8 Turbo	RL	04.2004		11.9361-9961.2	220855	FIST CALIPER	SOB100020 , GBC90196	
		RR	04.2004		11.9361-9962.2	220856	FIST CALIPER	SOB100030 , GBC90194	
	2,0 CDTI	RR	04.2004		11.9361-9962.2	220856	FIST CALIPER	SOB100030 , GBC90194	
		RL	04.2004		11.9361-9961.2	220855	FIST CALIPER	SOB100020 , GBC90196	
	2,5 V6	RR	04.2004		11.9361-9962.2	220856	FIST CALIPER	SOB100030 , GBC90194	
		RL	04.2004		11.9361-9961.2	220855	FIST CALIPER	SOB100020 , GBC90196	
75 series (RJ) (99-04)	1,8	RL	02.1999	05.2004	11.9361-9961.2	220855	FIST CALIPER	SOB100020 , GBC90196	
		RR	02.1999	05.2004	11.9361-9962.2	220856	FIST CALIPER	SOB100030 , GBC90194	
	1,8 Turbo	RL	05.2003	05.2004	11.9361-9961.2	220855	FIST CALIPER	SOB100020 , GBC90196	
		RR	05.2003	05.2004	11.9361-9962.2	220856	FIST CALIPER	SOB100030 , GBC90194	
	2,0 CDT	RL	02.1999	05.2004	11.9361-9961.2	220855	FIST CALIPER	SOB100020 , GBC90196	
		RR	02.1999	05.2004	11.9361-9962.2	220856	FIST CALIPER	SOB100030 , GBC90194	
	2,0 CDTI	RL	02.2003	05.2004	11.9361-9961.2	220855	FIST CALIPER	SOB100020 , GBC90196	
		RR	02.2003	05.2004	11.9361-9962.2	220856	FIST CALIPER	SOB100030 , GBC90194	
	2,0 V6	RR	02.1999	05.2004	11.9361-9962.2	220856	FIST CALIPER	SOB100030 , GBC90194	
		RL	02.1999	05.2004	11.9361-9961.2	220855	FIST CALIPER	SOB100020 , GBC90196	
	2,5 V6	RL	02.1999	10.2001	11.9361-9961.2	220855	FIST CALIPER	SOB100020 , GBC90196	

New partnumbers on stock - according to applications

11/2012



					Description	OE numbers per ATE pn.	 e.g. replaced pn. / miscellaneous
--	--	--	--	--	--------------------	-------------------------------	---------------------------------------

ROVER

75 series (RJ) (99-04)	2,5 V6	RR	08.2001	05.2004	11.9361-9962.2	220856	FIST CALIPER	SOB100030 , GBC90194	
		RR	02.1999	10.2001	11.9361-9962.2	220856	FIST CALIPER	SOB100030 , GBC90194	
		RL	08.2001	05.2004	11.9361-9961.2	220855	FIST CALIPER	SOB100020 , GBC90196	

SAAB

900 (94-98)	2,0 16V Turbo	FR	09.1993	08.1996	24.3541-8086.5	240526	FIST CALIPER	5 42 100 , 90443868 , 4482543	11.3541-8086.2
	2,0 i	FR	09.1993	08.1996	24.3541-8086.5	240526	FIST CALIPER	5 42 100 , 90443868 , 4482543	11.3541-8086.2
	2,3 16V	FR	09.1993	08.1996	24.3541-8086.5	240526	FIST CALIPER	5 42 100 , 90443868 , 4482543	11.3541-8086.2
	2,5 V6	FR	09.1993	08.1996	24.3541-8086.5	240526	FIST CALIPER	5 42 100 , 90443868 , 4482543	11.3541-8086.2







SUZUKI

SWIFT III (05-)	1,3 16V	RL	02.2005		24.3727-2005.2	582005	HANDBRAKE CABLE	54402-62J00	
	1,3 16V 4x4	RL	01.2006		24.3727-2005.2	582005	HANDBRAKE CABLE	54402-62J00	
		RL	02.2005		24.3727-2005.2	582005	HANDBRAKE CABLE	54402-62J00	
	1,3 DDiS	RL	08.2005		24.3727-2005.2	582005	HANDBRAKE CABLE	54402-62J00	
		RL	08.2005	09.2007	24.3727-2005.2	582005	HANDBRAKE CABLE	54402-62J00	
	1,5 16V 4x4	RL	02.2005		24.3727-2005.2	582005	HANDBRAKE CABLE	54402-62J00	
	1,5 VVTi	RL	02.2005		24.3727-2005.2	582005	HANDBRAKE CABLE	54402-62J00	

New partnumbers on stock - according to applications

11/2012



					Description	OE numbers per ATE pn.	 e.g. replaced pn. / miscellaneous
---	---	---	---	---	--------------------	-------------------------------	--

TOYOTA

COROLLA VERSO (04-)	1,6 VVTi (ZNR10)	RR	05.2004		24.3727-1940.2	581940	HANDBRAKE CABLE	46420-0F010	
		RL	05.2004		24.3727-1939.2	581939	HANDBRAKE CABLE	46430-0F010	
	1,8 VVTi (ZNR11)	RL	05.2004		24.3727-1939.2	581939	HANDBRAKE CABLE	46430-0F010	
		RR	05.2004		24.3727-1940.2	581940	HANDBRAKE CABLE	46420-0F010	
	2,0 D-4D (CUR10)	RL	05.2004	08.2005	24.3727-1939.2	581939	HANDBRAKE CABLE	46430-0F010	
		RR	05.2004	08.2005	24.3727-1940.2	581940	HANDBRAKE CABLE	46420-0F010	
	2,2 D-4D (AUR10)	RR	09.2005		24.3727-1940.2	581940	HANDBRAKE CABLE	46420-0F010	
		RL	09.2005		24.3727-1939.2	581939	HANDBRAKE CABLE	46430-0F010	
VERSO (09-)	1,6 16V		02.2009		13.0460-3854.2	603854	BRAKE PADS	04466-0F010	see drawing
	1,8 16V		02.2009		13.0460-3854.2	603854	BRAKE PADS	04466-0F010	see drawing
	2,0 D-4D		02.2009		13.0460-3854.2	603854	BRAKE PADS	04466-0F010	see drawing
	2,2 D-4D		02.2009		13.0460-3854.2	603854	BRAKE PADS	04466-0F010	see drawing
	2,2 D-CAT		02.2009		13.0460-3854.2	603854	BRAKE PADS	04466-0F010	see drawing

New partnumbers on stock - according to applications

11/2012



					Description	OE numbers per ATE pn.	 e.g. replaced pn. / miscellaneous
--	--	--	--	--	--------------------	-------------------------------	---------------------------------------

VOLKSWAGEN

LT/- 4x4 (75-96)	LT 40	FR	08.1978	07.1996	13.9571-0042.2	210260	FIXED CALIPER	81.50804.6009 , 291 615 108 , 291 615 108 B	13.2571-8016.2
		FL	08.1978	07.1996	13.9571-0041.2	210259	FIXED CALIPER	81.50804.6010 , 291 615 107 , 291 615 107 B	13.2571-8015.2
	LT 45	FL	08.1978	07.1996	13.9571-0041.2	210259	FIXED CALIPER	81.50804.6010 , 291 615 107 , 291 615 107 B	13.2571-8015.2
		FR	08.1978	07.1996	13.9571-0042.2	210260	FIXED CALIPER	81.50804.6009 , 291 615 108 , 291 615 108 B	13.2571-8016.2
	LT 50	FR	12.1982	07.1996	13.9571-0042.2	210260	FIXED CALIPER	81.50804.6009 , 291 615 108 , 291 615 108 B	13.2571-8016.2
		FL	12.1982	07.1996	13.9571-0041.2	210259	FIXED CALIPER	81.50804.6010 , 291 615 107 , 291 615 107 B	13.2571-8015.2
	LT 55	FR	08.1985	07.1996	13.9571-0042.2	210260	FIXED CALIPER	81.50804.6009 , 291 615 108 , 291 615 108 B	13.2571-8016.2
		FL	08.1985	07.1996	13.9571-0041.2	210259	FIXED CALIPER	81.50804.6010 , 291 615 107 , 291 615 107 B	13.2571-8015.2
TOUAREG I (03-10)	2,5 R5 TDI		01.2003	03.2010	13.0460-4852.2	604852	BRAKE PADS	7L0 698 151 M , 7L0 698 151 N , 7P0 698 151 , 7P0 698 151 B , 7P6 698 151 , 7P6 698 151 B , 7P0 698 151 C , 955 351 939 61 , 955 351 939 62 , 955 351 939 63	see drawing
	3,0 V6 TDI		10.2007	03.2010	13.0460-4852.2	604852	BRAKE PADS	7L0 698 151 M , 7L0 698 151 N , 7P0 698 151 , 7P0 698 151 B , 7P6 698 151 , 7P6 698 151 B , 7P0 698 151 C , 955 351 939 61 , 955 351 939 62 , 955 351 939 63	see drawing

New partnumbers on stock - according to applications

11/2012



					Description	OE numbers per ATE pn.	 e.g. replaced pn. / miscellaneous
--	--	--	--	--	--------------------	-------------------------------	---------------------------------------

VOLKSWAGEN

TOUAREG I (03-10)	3,0 V6 TDI		11.2004	03.2010	13.0460-4852.2	604852	BRAKE PADS	7L0 698 151 M , 7L0 698 151 N , 7P0 698 151 , 7P0 698 151 B , 7P6 698 151 , 7P6 698 151 B , 7P0 698 151 C , 955 351 939 61 , 955 351 939 62 , 955 351 939 63	see drawing
	3,6 V6 FSI		01.2006	03.2010	13.0460-4852.2	604852	BRAKE PADS	7L0 698 151 M , 7L0 698 151 N , 7P0 698 151 , 7P0 698 151 B , 7P6 698 151 , 7P6 698 151 B , 7P0 698 151 C , 955 351 939 61 , 955 351 939 62 , 955 351 939 63	see drawing
	4,2 V8 FSI		12.2006	03.2010	13.0460-4852.2	604852	BRAKE PADS	7L0 698 151 M , 7L0 698 151 N , 7P0 698 151 , 7P0 698 151 B , 7P6 698 151 , 7P6 698 151 B , 7P0 698 151 C , 955 351 939 61 , 955 351 939 62 , 955 351 939 63	see drawing
	5,0 TDI R50		01.2008	03.2010	13.0460-4852.2	604852	BRAKE PADS	7L0 698 151 M , 7L0 698 151 N , 7P0 698 151 , 7P0 698 151 B , 7P6 698 151 , 7P6 698 151 B , 7P0 698 151 C , 955 351 939 61 , 955 351 939 62 , 955 351 939 63	see drawing
	5,0 V10 TDI		11.2002	03.2010	13.0460-4852.2	604852	BRAKE PADS	7L0 698 151 M , 7L0 698 151 N , 7P0 698 151 , 7P0 698 151 B , 7P6 698 151 , 7P6 698 151 B , 7P0 698 151 C , 955 351 939 61 , 955 351 939 62 , 955 351 939 63	see drawing
TOUAREG II (10-)	3,0 V6 TDI		05.2011		13.0460-4852.2	604852	BRAKE PADS	7L0 698 151 M , 7L0 698 151 N , 7P0 698 151 , 7P0 698 151 B , 7P6 698 151 , 7P6 698 151 B , 7P0 698 151 C , 955 351 939 61 , 955 351 939 62 , 955 351 939 63	see drawing

New partnumbers on stock - according to applications

11/2012



					Description	OE numbers per ATE pn.	 e.g. replaced pn. / miscellaneous
--	--	--	--	--	--------------------	-------------------------------	---------------------------------------

VOLKSWAGEN

TOUAREG II (10-)	3,0 V6 TDI		04.2010		13.0460-4852.2	604852	BRAKE PADS	7L0 698 151 M , 7L0 698 151 N , 7P0 698 151 , 7P0 698 151 B , 7P6 698 151 , 7P6 698 151 B , 7P0 698 151 C , 955 351 939 61 , 955 351 939 62 , 955 351 939 63	see drawing
			04.2010		24.8190-0013.2	620013	WEAR INDICATOR	7P0 907 637	
			04.2011		24.8190-0015.2	620015	WEAR INDICATOR	7P0 907 637 C , 958 612 365 50	
			04.2010		24.8190-0015.2	620015	WEAR INDICATOR	7P0 907 637 C , 958 612 365 50	
			04.2010	10.2011	24.8190-0013.2	620013	WEAR INDICATOR	7P0 907 637	
			11.2011		24.8190-0013.2	620013	WEAR INDICATOR	7P0 907 637	
			05.2011		24.8190-0015.2	620015	WEAR INDICATOR	7P0 907 637 C , 958 612 365 50	
			05.2011		24.8190-0013.2	620013	WEAR INDICATOR	7P0 907 637	
			05.2011	10.2011	24.8190-0013.2	620013	WEAR INDICATOR	7P0 907 637	
			05.2011		24.8190-0014.2	620014	WEAR INDICATOR	7P0 907 637 A , 958 612 365 00	
			04.2010		24.8190-0014.2	620014	WEAR INDICATOR	7P0 907 637 A , 958 612 365 00	
	3,0 V6 TSI Hybrid		04.2010		13.0460-4852.2	604852	BRAKE PADS	7L0 698 151 M , 7L0 698 151 N , 7P0 698 151 , 7P0 698 151 B , 7P6 698 151 , 7P6 698 151 B , 7P0 698 151 C , 955 351 939 61 , 955 351 939 62 , 955 351 939 63	see drawing

New partnumbers on stock - according to applications

11/2012



					Description	OE numbers per ATE pn.	 e.g. replaced pn. / miscellaneous
--	--	--	--	--	--------------------	-------------------------------	---------------------------------------







VOLKSWAGEN

TOUAREG II (10-)	3,0 V6 TSI Hybrid		04.2010		24.8190-0014.2	620014	WEAR INDICATOR	7P0 907 637 A , 958 612 365 00	
			04.2010	10.2011	24.8190-0013.2	620013	WEAR INDICATOR	7P0 907 637	
			04.2010		24.8190-0013.2	620013	WEAR INDICATOR	7P0 907 637	
			04.2010		24.8190-0015.2	620015	WEAR INDICATOR	7P0 907 637 C , 958 612 365 50	
			11.2011		24.8190-0013.2	620013	WEAR INDICATOR	7P0 907 637	
	3,6 V6 FSI		04.2010		13.0460-4852.2	604852	BRAKE PADS	7L0 698 151 M , 7L0 698 151 N , 7P0 698 151 , 7P0 698 151 B , 7P6 698 151 , 7P6 698 151 B , 7P0 698 151 C , 955 351 939 61 , 955 351 939 62 , 955 351 939 63	see drawing
			04.2010		24.8190-0013.2	620013	WEAR INDICATOR	7P0 907 637	
			11.2011		24.8190-0013.2	620013	WEAR INDICATOR	7P0 907 637	
			04.2010	10.2011	24.8190-0013.2	620013	WEAR INDICATOR	7P0 907 637	
			04.2010		24.8190-0014.2	620014	WEAR INDICATOR	7P0 907 637 A , 958 612 365 00	
			04.2010		24.8190-0015.2	620015	WEAR INDICATOR	7P0 907 637 C , 958 612 365 50	
	4,2 V8 FSI		01.2011		13.0460-4852.2	604852	BRAKE PADS	7L0 698 151 M , 7L0 698 151 N , 7P0 698 151 , 7P0 698 151 B , 7P6 698 151 , 7P6 698 151 B , 7P0 698 151 C , 955 351 939 61 , 955 351 939 62 , 955 351 939 63	see drawing
			01.2011		24.8190-0014.2	620014	WEAR INDICATOR	7P0 907 637 A , 958 612 365 00	

New partnumbers on stock - according to applications

11/2012



					Description	OE numbers per ATE pn.	 e.g. replaced pn. / miscellaneous
---	---	---	---	---	--------------------	-------------------------------	--

VOLKSWAGEN

Model	Engine	Start Date	End Date	ATE Part No.	ATE Part No.	Description	OE numbers	Notes
TOUAREG II (10-)	4,2 V8 FSI	01.2011	10.2011	24.8190-0013.2	620013	WEAR INDICATOR	7P0 907 637	
		11.2011		24.8190-0013.2	620013	WEAR INDICATOR	7P0 907 637	
		01.2011		24.8190-0013.2	620013	WEAR INDICATOR	7P0 907 637	
		01.2011		24.8190-0015.2	620015	WEAR INDICATOR	7P0 907 637 C , 958 612 365 50	
		04.2010		13.0460-4852.2	604852	BRAKE PADS	7L0 698 151 M , 7L0 698 151 N , 7P0 698 151 , 7P0 698 151 B , 7P6 698 151 , 7P6 698 151 B , 7P0 698 151 C , 955 351 939 61 , 955 351 939 62 , 955 351 939 63	see drawing
		04.2010	10.2011	24.8190-0013.2	620013	WEAR INDICATOR	7P0 907 637	
		11.2011		24.8190-0013.2	620013	WEAR INDICATOR	7P0 907 637	
		04.2010		24.8190-0013.2	620013	WEAR INDICATOR	7P0 907 637	
		04.2010		24.8190-0014.2	620014	WEAR INDICATOR	7P0 907 637 A , 958 612 365 00	
		04.2010		24.8190-0015.2	620015	WEAR INDICATOR	7P0 907 637 C , 958 612 365 50	



13.0460-4852.2 604852

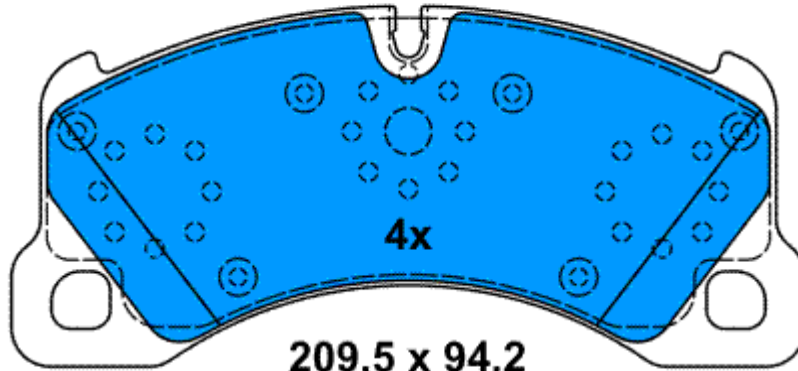

24553 15,8

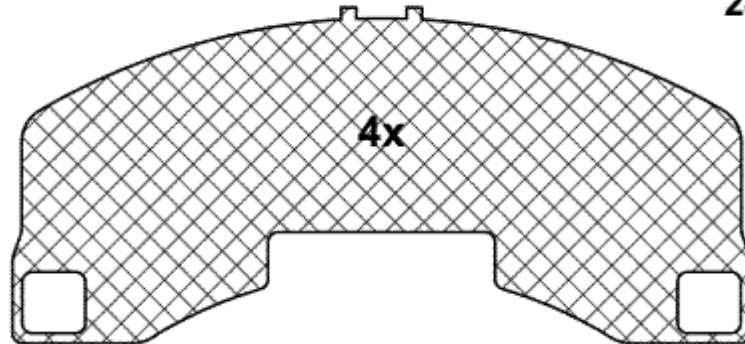

Applications:

- PORSCHE CAYENNE I (03-10)
- PORSCHE PANAMERA (10-)
- VOLKSWAGEN TOUAREG I (03-10)
- VOLKSWAGEN TOUAREG II (10-)



13.0460-7278.2 607278

Applications:

PEUGEOT 508 (10-)
PEUGEOT 508 SW (10-)

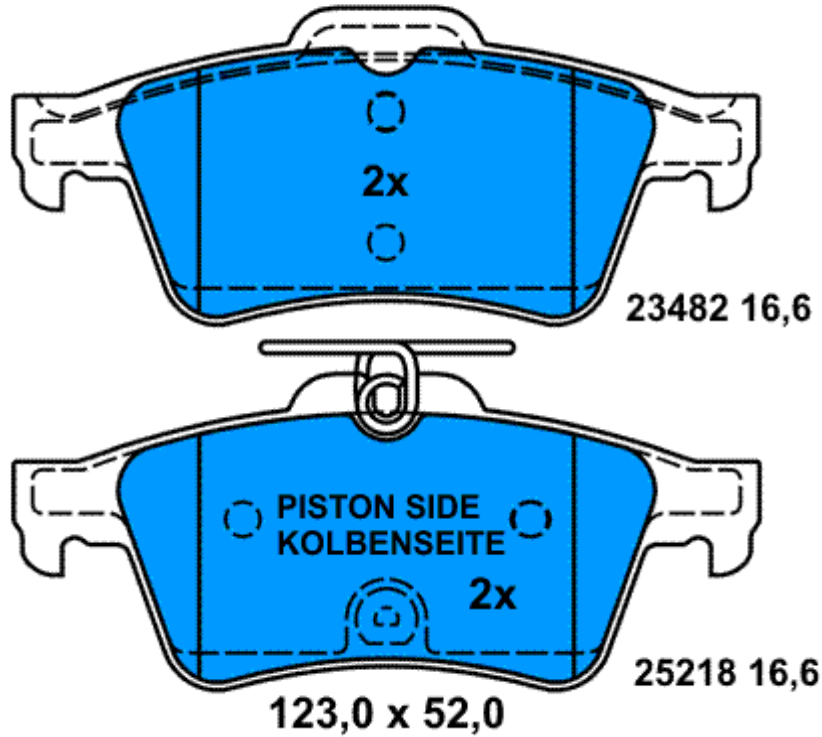



13.0460-7282.2 607282

Applications:

- MERCEDES BENZ GL-Klasse (X166) (12-)
- JEEP GRAND CHEROKEE IV (WK) (10-)
- MERCEDES BENZ M-Klasse (W166) (11-)



25192 21,3

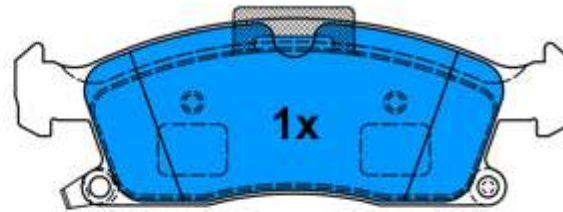

25190 21,3

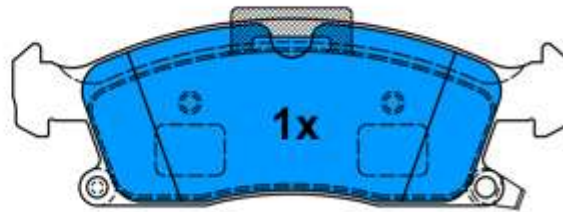

25191 21,3

193,1 x 64,1



13.0460-3854.2 603854

Applications:
TOYOTA VERSO (09-)

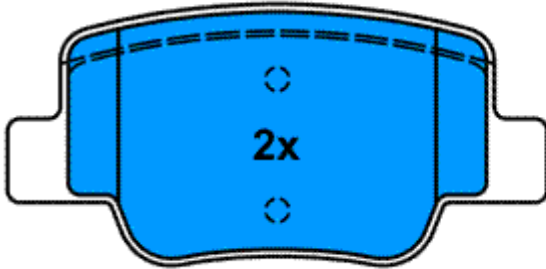

24926 16,5

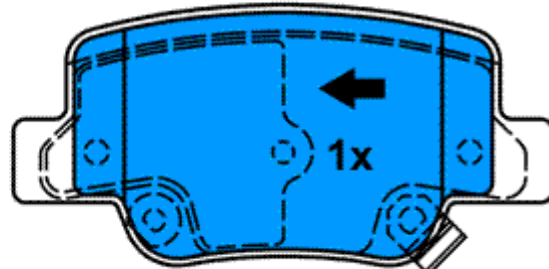

24927 17,1

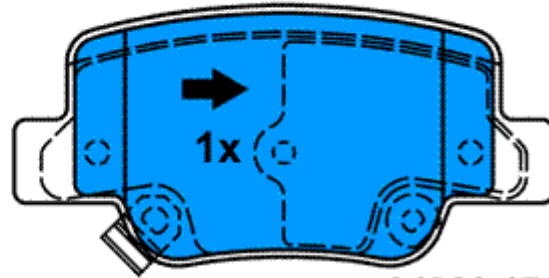
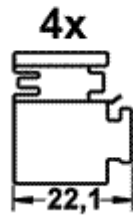
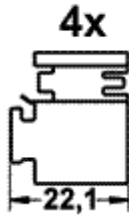

24928 17,1

101,8 x 48,7