

Nuevas referencias en almacén

Por aplicación

09/2008



www.ate.de









					Denominación	Ref. OE correspondientes a las referencias ATE		Referencia anterior / varios
--	--	--	--	--	--------------	------------------------------------------------	--	------------------------------

ALFA ROMEO

156 (97-05)	1,6 i 16V T,Spark		10.1997	07.2005	24.5112-0437.3	330886	LATIGUILLO	46556045 , 51700558	
	1,8 i 16V T,Spark		10.1997	07.2005	24.5112-0437.3	330886	LATIGUILLO	46556045 , 51700558	
	1,9 JTD		10.1997	07.2005	24.5112-0437.3	330886	LATIGUILLO	46556045 , 51700558	
	1,9 JTD 16V		11.2002	07.2005	24.5112-0437.3	330886	LATIGUILLO	46556045 , 51700558	
	2,0 i 16V T,Spark		10.1997	07.2005	24.5112-0437.3	330886	LATIGUILLO	46556045 , 51700558	
	2,0 JTS		03.2002	07.2005	24.5112-0437.3	330886	LATIGUILLO	46556045 , 51700558	
	2,4 JTD		10.2000	07.2005	24.5112-0437.3	330886	LATIGUILLO	46556045 , 51700558	
			10.1997	10.2000	24.5112-0437.3	330886	LATIGUILLO	46556045 , 51700558	
	2,5 i V6		10.1997	07.2005	24.5112-0437.3	330886	LATIGUILLO	46556045 , 51700558	
GT (04-)	1,8 TS		11.2003		24.5112-0437.3	330886	LATIGUILLO	46556045 , 51700558	
	1,9 JTD		11.2003		24.5112-0437.3	330886	LATIGUILLO	46556045 , 51700558	
	2,0 JTS		11.2003		24.5112-0437.3	330886	LATIGUILLO	46556045 , 51700558	
	3,2 i V6		11.2003		24.5112-0437.3	330886	LATIGUILLO	46556045 , 51700558	









					Denominación	Ref. OE correspondientes a las referencias ATE	 Referencia anterior / varios
-----------------------------------------------------------------------------------	-----------------------------------------------------------------------------------	-----------------------------------------------------------------------------------	-------------------------------------------------------------------------------------	-------------------------------------------------------------------------------------	--------------	------------------------------------------------	---------------------------------------------------------------------------------------------------------------------

AUDI

A3 / A3 Sportback (03-)	1,4 TFSI	TI	07.2007		24.3384-1755.7	220635	PINZA DE GARRA	1K0 615 423 D , 1K0 615 423 J , 1K0 615 423 A	
		TD	07.2007		24.3414-1710.7	220632	PINZA DE GARRA	1K0 615 424 C , 1K0 615 424 H , 1K0 615 424 F , 1K0 615 424	
		TI	07.2007		24.3414-1709.7	220631	PINZA DE GARRA	1K0 615 423 C , 1K0 615 423 H , 1K0 615 423 F , 1K0 615 423	
		TD	07.2007		24.3384-1756.7	220636	PINZA DE GARRA	1K0 615 424 D , 1K0 615 424 J , 1K0 615 424 A	
			07.2007		24.0325-0158.1	525158	POWER-DISC	1K0 615 301 AA	
	1,6	TD	05.2003		24.3384-1756.7	220636	PINZA DE GARRA	1K0 615 424 D , 1K0 615 424 J , 1K0 615 424 A	
		TI	05.2003		24.3384-1755.7	220635	PINZA DE GARRA	1K0 615 423 D , 1K0 615 423 J , 1K0 615 423 A	
		TD	05.2003		24.3414-1710.7	220632	PINZA DE GARRA	1K0 615 424 C , 1K0 615 424 H , 1K0 615 424 F , 1K0 615 424	
		TI	05.2003		24.3414-1709.7	220631	PINZA DE GARRA	1K0 615 423 C , 1K0 615 423 H , 1K0 615 423 F , 1K0 615 423	
			05.2003		24.0325-0158.1	525158	POWER-DISC	1K0 615 301 AA	
	1,6 FSI	TD	08.2003		24.3384-1756.7	220636	PINZA DE GARRA	1K0 615 424 D , 1K0 615 424 J , 1K0 615 424 A	
		TI	08.2003		24.3384-1755.7	220635	PINZA DE GARRA	1K0 615 423 D , 1K0 615 423 J , 1K0 615 423 A	









					Denominación	Ref. OE correspondientes a las referencias ATE	 Referencia anterior / varios
-----------------------------------------------------------------------------------	-----------------------------------------------------------------------------------	-----------------------------------------------------------------------------------	-------------------------------------------------------------------------------------	-------------------------------------------------------------------------------------	--------------	------------------------------------------------	---------------------------------------------------------------------------------------------------------------------

AUDI

A3 / A3 Sportback (03-)	1,6 FSI	TI	08.2003		24.3414-1709.7	220631	PINZA DE GARRA	1K0 615 423 C , 1K0 615 423 H , 1K0 615 423 F , 1K0 615 423	
		TD	08.2003		24.3414-1710.7	220632	PINZA DE GARRA	1K0 615 424 C , 1K0 615 424 H , 1K0 615 424 F , 1K0 615 424	
			08.2003		24.0325-0158.1	525158	POWER-DISC	1K0 615 301 AA	
	1,8 TFSI	TD	01.2007		24.3384-1756.7	220636	PINZA DE GARRA	1K0 615 424 D , 1K0 615 424 J , 1K0 615 424 A	
		TI	01.2007		24.3384-1755.7	220635	PINZA DE GARRA	1K0 615 423 D , 1K0 615 423 J , 1K0 615 423 A	
		TI	01.2007		24.3414-1709.7	220631	PINZA DE GARRA	1K0 615 423 C , 1K0 615 423 H , 1K0 615 423 F , 1K0 615 423	
		TD	01.2007		24.3414-1710.7	220632	PINZA DE GARRA	1K0 615 424 C , 1K0 615 424 H , 1K0 615 424 F , 1K0 615 424	
			01.2007		24.0325-0158.1	525158	POWER-DISC	1K0 615 301 AA	
	1,8 TFSI Quattro	TD	05.2008		24.3414-1710.7	220632	PINZA DE GARRA	1K0 615 424 C , 1K0 615 424 H , 1K0 615 424 F , 1K0 615 424	
		TI	05.2008		24.3414-1709.7	220631	PINZA DE GARRA	1K0 615 423 C , 1K0 615 423 H , 1K0 615 423 F , 1K0 615 423	
			05.2008		24.0325-0158.1	525158	POWER-DISC	1K0 615 301 AA	
	1,9 TDI	TD	06.2003		24.3384-1756.7	220636	PINZA DE GARRA	1K0 615 424 D , 1K0 615 424 J , 1K0 615 424 A	



					Denominación	Ref. OE correspondientes a las referencias ATE	 Referencia anterior / varios
-----------------------------------------------------------------------------------	-----------------------------------------------------------------------------------	-----------------------------------------------------------------------------------	-------------------------------------------------------------------------------------	-------------------------------------------------------------------------------------	--------------	------------------------------------------------	---------------------------------------------------------------------------------------------------------------------

AUDI

A3 / A3 Sportback (03-)	1,9 TDI	TI	06.2003		24.3414-1709.7	220631	PINZA DE GARRA	1K0 615 423 C , 1K0 615 423 H , 1K0 615 423 F , 1K0 615 423	
		TD	06.2003		24.3414-1710.7	220632	PINZA DE GARRA	1K0 615 424 C , 1K0 615 424 H , 1K0 615 424 F , 1K0 615 424	
		TI	06.2003		24.3384-1755.7	220635	PINZA DE GARRA	1K0 615 423 D , 1K0 615 423 J , 1K0 615 423 A	
			06.2003		24.0325-0158.1	525158	POWER-DISC	1K0 615 301 AA	
	2,0 FSI	TD	05.2003		24.3384-1756.7	220636	PINZA DE GARRA	1K0 615 424 D , 1K0 615 424 J , 1K0 615 424 A	
		TD	05.2003		24.3414-1710.7	220632	PINZA DE GARRA	1K0 615 424 C , 1K0 615 424 H , 1K0 615 424 F , 1K0 615 424	
		TI	05.2003		24.3384-1755.7	220635	PINZA DE GARRA	1K0 615 423 D , 1K0 615 423 J , 1K0 615 423 A	
		TI	05.2003		24.3414-1709.7	220631	PINZA DE GARRA	1K0 615 423 C , 1K0 615 423 H , 1K0 615 423 F , 1K0 615 423	
			05.2003		24.0325-0158.1	525158	POWER-DISC	1K0 615 301 AA	
	2,0 TDI	TI	03.2006		24.3414-1709.7	220631	PINZA DE GARRA	1K0 615 423 C , 1K0 615 423 H , 1K0 615 423 F , 1K0 615 423	
		TD	03.2006		24.3384-1756.7	220636	PINZA DE GARRA	1K0 615 424 D , 1K0 615 424 J , 1K0 615 424 A	
		TD	05.2003		24.3414-1710.7	220632	PINZA DE GARRA	1K0 615 424 C , 1K0 615 424 H , 1K0 615 424 F , 1K0 615 424	



					Denominación	Ref. OE correspondientes a las referencias ATE		Referencia anterior / varios
--	--	--	--	--	--------------	------------------------------------------------	--	------------------------------

AUDI

A3 / A3 Sportback (03-)	2,0 TDI	TI	03.2006		24.3384-1755.7	220635	PINZA DE GARRA	1K0 615 423 D , 1K0 615 423 J , 1K0 615 423 A	
		TI	05.2003		24.3414-1709.7	220631	PINZA DE GARRA	1K0 615 423 C , 1K0 615 423 H , 1K0 615 423 F , 1K0 615 423	
		TD	05.2003		24.3384-1756.7	220636	PINZA DE GARRA	1K0 615 424 D , 1K0 615 424 J , 1K0 615 424 A	
		TI	05.2003		24.3384-1755.7	220635	PINZA DE GARRA	1K0 615 423 D , 1K0 615 423 J , 1K0 615 423 A	
		TD	03.2006		24.3414-1710.7	220632	PINZA DE GARRA	1K0 615 424 C , 1K0 615 424 H , 1K0 615 424 F , 1K0 615 424	
			03.2006		24.0325-0158.1	525158	POWER-DISC	1K0 615 301 AA	
			05.2003		24.0325-0158.1	525158	POWER-DISC	1K0 615 301 AA	
	2,0 TDI Quattro	TI	03.2006		24.3414-1709.7	220631	PINZA DE GARRA	1K0 615 423 C , 1K0 615 423 H , 1K0 615 423 F , 1K0 615 423	
		TI	05.2003		24.3414-1709.7	220631	PINZA DE GARRA	1K0 615 423 C , 1K0 615 423 H , 1K0 615 423 F , 1K0 615 423	
		TI	08.2004		24.3414-1709.7	220631	PINZA DE GARRA	1K0 615 423 C , 1K0 615 423 H , 1K0 615 423 F , 1K0 615 423	
		TD	03.2006		24.3414-1710.7	220632	PINZA DE GARRA	1K0 615 424 C , 1K0 615 424 H , 1K0 615 424 F , 1K0 615 424	
		TD	05.2003		24.3414-1710.7	220632	PINZA DE GARRA	1K0 615 424 C , 1K0 615 424 H , 1K0 615 424 F , 1K0 615 424	



					Denominación	Ref. OE correspondientes a las referencias ATE		Referencia anterior / varios
--	--	--	--	--	--------------	------------------------------------------------	--	------------------------------

AUDI

A3 / A3 Sportback (03-)	2,0 TDI Quattro	TD	08.2004		24.3414-1710.7	220632	PINZA DE GARRA	1K0 615 424 C , 1K0 615 424 H , 1K0 615 424 F , 1K0 615 424	
			08.2004		24.0325-0158.1	525158	POWER-DISC	1K0 615 301 AA	
			05.2003		24.0325-0158.1	525158	POWER-DISC	1K0 615 301 AA	
			03.2006		24.0325-0158.1	525158	POWER-DISC	1K0 615 301 AA	
	2,0 TFSI	TD	06.2004		24.3384-1756.7	220636	PINZA DE GARRA	1K0 615 424 D , 1K0 615 424 J , 1K0 615 424 A	
		TD	06.2004		24.3414-1710.7	220632	PINZA DE GARRA	1K0 615 424 C , 1K0 615 424 H , 1K0 615 424 F , 1K0 615 424	
		TI	06.2004		24.3414-1709.7	220631	PINZA DE GARRA	1K0 615 423 C , 1K0 615 423 H , 1K0 615 423 F , 1K0 615 423	
		TI	06.2004		24.3384-1755.7	220635	PINZA DE GARRA	1K0 615 423 D , 1K0 615 423 J , 1K0 615 423 A	
			06.2004		24.0325-0158.1	525158	POWER-DISC	1K0 615 301 AA	
	2,0 TFSI Quattro	TD	06.2004		24.3414-1710.7	220632	PINZA DE GARRA	1K0 615 424 C , 1K0 615 424 H , 1K0 615 424 F , 1K0 615 424	
		TI	06.2004		24.3414-1709.7	220631	PINZA DE GARRA	1K0 615 423 C , 1K0 615 423 H , 1K0 615 423 F , 1K0 615 423	
			06.2004		24.0325-0158.1	525158	POWER-DISC	1K0 615 301 AA	
	3,2 Quattro		07.2003		24.0325-0158.1	525158	POWER-DISC	1K0 615 301 AA	
A3 Cabrio (08-)	1,8 TFSI	TD	04.2008		24.3384-1756.7	220636	PINZA DE GARRA	1K0 615 424 D , 1K0 615 424 J , 1K0 615 424 A	



					Denominación	Ref. OE correspondientes a las referencias ATE		Referencia anterior / varios
--	--	--	--	--	--------------	------------------------------------------------	--	------------------------------

AUDI

A3 Cabrio (08-)	1,8 TFSI	TI	04.2008		24.3384-1755.7	220635	PINZA DE GARRA	1K0 615 423 D , 1K0 615 423 J , 1K0 615 423 A	
	1,9 TDI	TI	04.2008		24.3384-1755.7	220635	PINZA DE GARRA	1K0 615 423 D , 1K0 615 423 J , 1K0 615 423 A	
		TD	04.2008		24.3384-1756.7	220636	PINZA DE GARRA	1K0 615 424 D , 1K0 615 424 J , 1K0 615 424 A	
	2,0 TDI	TI	04.2008		24.3384-1755.7	220635	PINZA DE GARRA	1K0 615 423 D , 1K0 615 423 J , 1K0 615 423 A	
		TD	04.2008		24.3384-1756.7	220636	PINZA DE GARRA	1K0 615 424 D , 1K0 615 424 J , 1K0 615 424 A	
	2,0 TFSI	TD	04.2008		24.3384-1756.7	220636	PINZA DE GARRA	1K0 615 424 D , 1K0 615 424 J , 1K0 615 424 A	
		TI	04.2008		24.3384-1755.7	220635	PINZA DE GARRA	1K0 615 423 D , 1K0 615 423 J , 1K0 615 423 A	
A4 (B5) (95-01)	1,6		11.1994		83.7812-0180.3	330854	LATIGUILLO	8D0 611 775 E , 4E0 611 775 F , 8E0 611 775	83.6212-0180.3
				04.2001	83.7812-0180.3	330854	LATIGUILLO	8D0 611 775 E , 4E0 611 775 F , 8E0 611 775	83.6212-0180.3
	1,8		11.1994		83.7812-0180.3	330854	LATIGUILLO	8D0 611 775 E , 4E0 611 775 F , 8E0 611 775	83.6212-0180.3
				04.2001	83.7812-0180.3	330854	LATIGUILLO	8D0 611 775 E , 4E0 611 775 F , 8E0 611 775	83.6212-0180.3
	1,8 T		05.1995		83.7812-0180.3	330854	LATIGUILLO	8D0 611 775 E , 4E0 611 775 F , 8E0 611 775	83.6212-0180.3
				04.2001	83.7812-0180.3	330854	LATIGUILLO	8D0 611 775 E , 4E0 611 775 F , 8E0 611 775	83.6212-0180.3



					Denominación	Ref. OE correspondientes a las referencias ATE		Referencia anterior / varios
--	--	--	--	--	--------------	------------------------------------------------	--	------------------------------

AUDI

A4 (B5) (95-01)	1,9 TDI		01.1998	04.2001	83.7812-0180.3	330854	LATIGUILLO	8D0 611 775 E , 4E0 611 775 F , 8E0 611 775	83.6212-0180.3
				04.2001	83.7812-0180.3	330854	LATIGUILLO	8D0 611 775 E , 4E0 611 775 F , 8E0 611 775	83.6212-0180.3
			03.1996		83.7812-0180.3	330854	LATIGUILLO	8D0 611 775 E , 4E0 611 775 F , 8E0 611 775	83.6212-0180.3
			02.1996		83.7812-0180.3	330854	LATIGUILLO	8D0 611 775 E , 4E0 611 775 F , 8E0 611 775	83.6212-0180.3
			01.1995		83.7812-0180.3	330854	LATIGUILLO	8D0 611 775 E , 4E0 611 775 F , 8E0 611 775	83.6212-0180.3
	2,4		07.1995		83.7812-0180.3	330854	LATIGUILLO	8D0 611 775 E , 4E0 611 775 F , 8E0 611 775	83.6212-0180.3
				07.1997	83.7812-0180.3	330854	LATIGUILLO	8D0 611 775 E , 4E0 611 775 F , 8E0 611 775	83.6212-0180.3
			08.1997	04.2001	83.7812-0180.3	330854	LATIGUILLO	8D0 611 775 E , 4E0 611 775 F , 8E0 611 775	83.6212-0180.3
	2,5 TDI		08.1997	04.2001	83.7812-0180.3	330854	LATIGUILLO	8D0 611 775 E , 4E0 611 775 F , 8E0 611 775	83.6212-0180.3
	2,6		11.1994		83.7812-0180.3	330854	LATIGUILLO	8D0 611 775 E , 4E0 611 775 F , 8E0 611 775	83.6212-0180.3
				04.2001	83.7812-0180.3	330854	LATIGUILLO	8D0 611 775 E , 4E0 611 775 F , 8E0 611 775	83.6212-0180.3
	2,8		11.1994		83.7812-0180.3	330854	LATIGUILLO	8D0 611 775 E , 4E0 611 775 F , 8E0 611 775	83.6212-0180.3
				04.2001	83.7812-0180.3	330854	LATIGUILLO	8D0 611 775 E , 4E0 611 775 F , 8E0 611 775	83.6212-0180.3



					Denominación	Ref. OE correspondientes a las referencias ATE		Referencia anterior / varios
--	--	--	--	--	--------------	------------------------------------------------	--	------------------------------

AUDI

A4 (B5) (95-01)	2,8			07.1997	83.7812-0180.3	330854	LATIGUILLO	8D0 611 775 E , 4E0 611 775 F , 8E0 611 775	83.6212-0180.3
			03.1996		83.7812-0180.3	330854	LATIGUILLO	8D0 611 775 E , 4E0 611 775 F , 8E0 611 775	83.6212-0180.3
	S4 2,7		10.1997	04.2001	24.0330-0113.1	530113	POWER-DISC	8E0 615 301 AD , 8D0 615 301 M , 8D0 615 301 K	
A4 (B6/B7) (01-08)	1,6		12.2000		24.0330-0113.1	530113	POWER-DISC	8E0 615 301 AD , 8D0 615 301 M , 8D0 615 301 K	
	1,8 T		11.2002		24.0330-0113.1	530113	POWER-DISC	8E0 615 301 AD , 8D0 615 301 M , 8D0 615 301 K	
			12.2000		24.0330-0113.1	530113	POWER-DISC	8E0 615 301 AD , 8D0 615 301 M , 8D0 615 301 K	
			07.2001		24.0330-0113.1	530113	POWER-DISC	8E0 615 301 AD , 8D0 615 301 M , 8D0 615 301 K	
			07.2002		24.0330-0113.1	530113	POWER-DISC	8E0 615 301 AD , 8D0 615 301 M , 8D0 615 301 K	
	1,8 T Quattro		07.2001		24.0330-0113.1	530113	POWER-DISC	8E0 615 301 AD , 8D0 615 301 M , 8D0 615 301 K	
			07.2002		24.0330-0113.1	530113	POWER-DISC	8E0 615 301 AD , 8D0 615 301 M , 8D0 615 301 K	
			11.2002		24.0330-0113.1	530113	POWER-DISC	8E0 615 301 AD , 8D0 615 301 M , 8D0 615 301 K	
			12.2000		24.0330-0113.1	530113	POWER-DISC	8E0 615 301 AD , 8D0 615 301 M , 8D0 615 301 K	
	1,9 TDI		06.2004		24.0330-0113.1	530113	POWER-DISC	8E0 615 301 AD , 8D0 615 301 M , 8D0 615 301 K	



					Denominación	Ref. OE correspondientes a las referencias ATE		Referencia anterior / varios
--	--	--	--	--	--------------	------------------------------------------------	--	------------------------------

AUDI

A4 (B6/B7) (01-08)	1,9 TDI		12.2000		24.0330-0113.1	530113	POWER-DISC	8E0 615 301 AD , 8D0 615 301 M , 8D0 615 301 K	
			04.2001		24.0330-0113.1	530113	POWER-DISC	8E0 615 301 AD , 8D0 615 301 M , 8D0 615 301 K	
	1,9 TDI Quattro		12.2000		24.0330-0113.1	530113	POWER-DISC	8E0 615 301 AD , 8D0 615 301 M , 8D0 615 301 K	
	2		12.2000		24.0330-0113.1	530113	POWER-DISC	8E0 615 301 AD , 8D0 615 301 M , 8D0 615 301 K	
	2,0 FSI		07.2002		24.0330-0113.1	530113	POWER-DISC	8E0 615 301 AD , 8D0 615 301 M , 8D0 615 301 K	
	2,0 TDI		06.2006		24.0330-0113.1	530113	POWER-DISC	8E0 615 301 AD , 8D0 615 301 M , 8D0 615 301 K	
			11.2004		24.0330-0113.1	530113	POWER-DISC	8E0 615 301 AD , 8D0 615 301 M , 8D0 615 301 K	
	2,0 TDI Quattro		01.2006		24.0330-0113.1	530113	POWER-DISC	8E0 615 301 AD , 8D0 615 301 M , 8D0 615 301 K	
			06.2006		24.0330-0113.1	530113	POWER-DISC	8E0 615 301 AD , 8D0 615 301 M , 8D0 615 301 K	
	2,0 TFSI		11.2004		24.0330-0113.1	530113	POWER-DISC	8E0 615 301 AD , 8D0 615 301 M , 8D0 615 301 K	
			06.2005		24.0330-0113.1	530113	POWER-DISC	8E0 615 301 AD , 8D0 615 301 M , 8D0 615 301 K	
	2,0 TFSI Quattro		11.2004		24.0330-0113.1	530113	POWER-DISC	8E0 615 301 AD , 8D0 615 301 M , 8D0 615 301 K	
			06.2005		24.0330-0113.1	530113	POWER-DISC	8E0 615 301 AD , 8D0 615 301 M , 8D0 615 301 K	



					Denominación	Ref. OE correspondientes a las referencias ATE		Referencia anterior / varios
--	--	--	--	--	--------------	------------------------------------------------	--	------------------------------

AUDI

A4 (B6/B7) (01-08)	2,4		09.2001		24.0330-0113.1	530113	POWER-DISC	8E0 615 301 AD , 8D0 615 301 M , 8D0 615 301 K	
	2,5 TDI		12.2000		24.0330-0113.1	530113	POWER-DISC	8E0 615 301 AD , 8D0 615 301 M , 8D0 615 301 K	
	2,5 TDI Quattro		12.2000		24.0330-0113.1	530113	POWER-DISC	8E0 615 301 AD , 8D0 615 301 M , 8D0 615 301 K	
	2,7 TDI		01.2006		24.0330-0113.1	530113	POWER-DISC	8E0 615 301 AD , 8D0 615 301 M , 8D0 615 301 K	
	3		12.2000		24.0330-0113.1	530113	POWER-DISC	8E0 615 301 AD , 8D0 615 301 M , 8D0 615 301 K	
	3,0 Quattro		12.2000		24.0330-0113.1	530113	POWER-DISC	8E0 615 301 AD , 8D0 615 301 M , 8D0 615 301 K	
	3,0 TDI Quattro		11.2004		24.0330-0113.1	530113	POWER-DISC	8E0 615 301 AD , 8D0 615 301 M , 8D0 615 301 K	
			01.2006		24.0330-0113.1	530113	POWER-DISC	8E0 615 301 AD , 8D0 615 301 M , 8D0 615 301 K	
	3,2 FSI		01.2005		24.0330-0113.1	530113	POWER-DISC	8E0 615 301 AD , 8D0 615 301 M , 8D0 615 301 K	
	3,2 FSI Quattro		01.2005		24.0330-0113.1	530113	POWER-DISC	8E0 615 301 AD , 8D0 615 301 M , 8D0 615 301 K	
A4 CABRIOLE (02-)	1,8 T		04.2002		24.0330-0113.1	530113	POWER-DISC	8E0 615 301 AD , 8D0 615 301 M , 8D0 615 301 K	
	1,8 T Quattro		05.2003		24.0330-0113.1	530113	POWER-DISC	8E0 615 301 AD , 8D0 615 301 M , 8D0 615 301 K	
	2		05.2004		24.0330-0113.1	530113	POWER-DISC	8E0 615 301 AD , 8D0 615 301 M , 8D0 615 301 K	



					Denominación	Ref. OE correspondientes a las referencias ATE		Referencia anterior / varios
--	--	--	--	--	--------------	------------------------------------------------	--	------------------------------

AUDI

A4 CABRIOLE (02-)	2,0 TDI		10.2005		24.0330-0113.1	530113	POWER-DISC	8E0 615 301 AD , 8D0 615 301 M , 8D0 615 301 K	
	2,0 TFSI		01.2006		24.0330-0113.1	530113	POWER-DISC	8E0 615 301 AD , 8D0 615 301 M , 8D0 615 301 K	
			10.2005		24.0330-0113.1	530113	POWER-DISC	8E0 615 301 AD , 8D0 615 301 M , 8D0 615 301 K	
	2,4		04.2002		24.0330-0113.1	530113	POWER-DISC	8E0 615 301 AD , 8D0 615 301 M , 8D0 615 301 K	
	2,5 TDI		08.2002		24.0330-0113.1	530113	POWER-DISC	8E0 615 301 AD , 8D0 615 301 M , 8D0 615 301 K	
	2,7 TDI		06.2006		24.0330-0113.1	530113	POWER-DISC	8E0 615 301 AD , 8D0 615 301 M , 8D0 615 301 K	
	3		04.2002		24.0330-0113.1	530113	POWER-DISC	8E0 615 301 AD , 8D0 615 301 M , 8D0 615 301 K	
	3,0 Quattro		05.2003		24.0330-0113.1	530113	POWER-DISC	8E0 615 301 AD , 8D0 615 301 M , 8D0 615 301 K	
	3,0 TDI Quattro		10.2005		24.0330-0113.1	530113	POWER-DISC	8E0 615 301 AD , 8D0 615 301 M , 8D0 615 301 K	
			01.2006		24.0330-0113.1	530113	POWER-DISC	8E0 615 301 AD , 8D0 615 301 M , 8D0 615 301 K	
	3,2 FSI		10.2005		24.0330-0113.1	530113	POWER-DISC	8E0 615 301 AD , 8D0 615 301 M , 8D0 615 301 K	
	3,2 FSI Quattro		10.2005		24.0330-0113.1	530113	POWER-DISC	8E0 615 301 AD , 8D0 615 301 M , 8D0 615 301 K	
A6 (C5) (97-05)	1,8 T		04.1997	01.2005	24.0330-0113.1	530113	POWER-DISC	8E0 615 301 AD , 8D0 615 301 M , 8D0 615 301 K	



					Denominación	Ref. OE correspondientes a las referencias ATE		Referencia anterior / varios
--	--	--	--	--	--------------	------------------------------------------------	--	------------------------------

AUDI

A6 (C5) (97-05)	1,8 T Quattro		06.2001	01.2005	24.0330-0113.1	530113	POWER-DISC	8E0 615 301 AD , 8D0 615 301 M , 8D0 615 301 K	
	2,4 Quattro		06.2001	01.2005	24.0330-0113.1	530113	POWER-DISC	8E0 615 301 AD , 8D0 615 301 M , 8D0 615 301 K	
	2,5 TDI		02.2000	01.2005	24.0330-0113.1	530113	POWER-DISC	8E0 615 301 AD , 8D0 615 301 M , 8D0 615 301 K	
			04.1997	01.2005	24.0330-0113.1	530113	POWER-DISC	8E0 615 301 AD , 8D0 615 301 M , 8D0 615 301 K	
			07.2002	01.2005	24.0330-0113.1	530113	POWER-DISC	8E0 615 301 AD , 8D0 615 301 M , 8D0 615 301 K	
	2,5 TDI Quattro		06.2001	01.2005	24.0330-0113.1	530113	POWER-DISC	8E0 615 301 AD , 8D0 615 301 M , 8D0 615 301 K	
	2,7 T		03.1998	01.2005	24.0330-0113.1	530113	POWER-DISC	8E0 615 301 AD , 8D0 615 301 M , 8D0 615 301 K	
	2,7 T Quattro		10.1997	01.2005	24.0330-0113.1	530113	POWER-DISC	8E0 615 301 AD , 8D0 615 301 M , 8D0 615 301 K	
	3		06.2001	01.2005	24.0330-0113.1	530113	POWER-DISC	8E0 615 301 AD , 8D0 615 301 M , 8D0 615 301 K	
	3,0 Quattro		06.2001	01.2005	24.0330-0113.1	530113	POWER-DISC	8E0 615 301 AD , 8D0 615 301 M , 8D0 615 301 K	
A6 (C6) Avant (05-)	S6		06.2005		24.0136-0107.1	436107	DISCO DE FRENO	4F0 615 301 J	
A6 (C6) Berlina (04-)			03.2006		24.0136-0107.1	436107	DISCO DE FRENO	4F0 615 301 J	
A6 Allroad (00-05)	2,5 TDI		05.2000	07.2005	24.0330-0113.1	530113	POWER-DISC	8E0 615 301 AD , 8D0 615 301 M , 8D0 615 301 K	
	2,7 T		05.2000	07.2005	24.0330-0113.1	530113	POWER-DISC	8E0 615 301 AD , 8D0 615 301 M , 8D0 615 301 K	



					Denominación	Ref. OE correspondientes a las referencias ATE		Referencia anterior / varios
--	--	--	--	--	--------------	------------------------------------------------	--	------------------------------

AUDI

A6 Allroad (00-05)	4,2		07.2002	07.2005	24.0330-0113.1	530113	POWER-DISC	8E0 615 301 AD , 8D0 615 301 M , 8D0 615 301 K	
A8 (03-)	2,8 FSI		08.2007		83.7812-0180.3	330854	LATIGUILLO	8D0 611 775 E , 4E0 611 775 F , 8E0 611 775	83.6212-0180.3
	3				83.7812-0180.3	330854	LATIGUILLO	8D0 611 775 E , 4E0 611 775 F , 8E0 611 775	83.6212-0180.3
			07.2003		83.7812-0180.3	330854	LATIGUILLO	8D0 611 775 E , 4E0 611 775 F , 8E0 611 775	83.6212-0180.3
	3,0 TDI Quattro				83.7812-0180.3	330854	LATIGUILLO	8D0 611 775 E , 4E0 611 775 F , 8E0 611 775	83.6212-0180.3
			11.2003		83.7812-0180.3	330854	LATIGUILLO	8D0 611 775 E , 4E0 611 775 F , 8E0 611 775	83.6212-0180.3
	3,2 FSI				83.7812-0180.3	330854	LATIGUILLO	8D0 611 775 E , 4E0 611 775 F , 8E0 611 775	83.6212-0180.3
			06.2005		83.7812-0180.3	330854	LATIGUILLO	8D0 611 775 E , 4E0 611 775 F , 8E0 611 775	83.6212-0180.3
	3,2 FSI Quattro		06.2005		83.7812-0180.3	330854	LATIGUILLO	8D0 611 775 E , 4E0 611 775 F , 8E0 611 775	83.6212-0180.3
					83.7812-0180.3	330854	LATIGUILLO	8D0 611 775 E , 4E0 611 775 F , 8E0 611 775	83.6212-0180.3
	3,7 Quattro		11.2002		83.7812-0180.3	330854	LATIGUILLO	8D0 611 775 E , 4E0 611 775 F , 8E0 611 775	83.6212-0180.3
					83.7812-0180.3	330854	LATIGUILLO	8D0 611 775 E , 4E0 611 775 F , 8E0 611 775	83.6212-0180.3
	4,0 TDI Quattro		03.2003		83.7812-0180.3	330854	LATIGUILLO	8D0 611 775 E , 4E0 611 775 F , 8E0 611 775	83.6212-0180.3



					Denominación	Ref. OE correspondientes a las referencias ATE		Referencia anterior / varios
--	--	--	--	--	--------------	------------------------------------------------	--	------------------------------

AUDI

A8 (03-)	4,0 TDI Quattro				83.7812-0180.3	330854	LATIGUILLO	8D0 611 775 E , 4E0 611 775 F , 8E0 611 775	83.6212-0180.3
	4,2 FSI Quattro		06.2006		83.7812-0180.3	330854	LATIGUILLO	8D0 611 775 E , 4E0 611 775 F , 8E0 611 775	83.6212-0180.3
					83.7812-0180.3	330854	LATIGUILLO	8D0 611 775 E , 4E0 611 775 F , 8E0 611 775	83.6212-0180.3
	4,2 Quattro		11.2002		83.7812-0180.3	330854	LATIGUILLO	8D0 611 775 E , 4E0 611 775 F , 8E0 611 775	83.6212-0180.3
					83.7812-0180.3	330854	LATIGUILLO	8D0 611 775 E , 4E0 611 775 F , 8E0 611 775	83.6212-0180.3
	4,2 TDI Quattro		07.2005		83.7812-0180.3	330854	LATIGUILLO	8D0 611 775 E , 4E0 611 775 F , 8E0 611 775	83.6212-0180.3
					83.7812-0180.3	330854	LATIGUILLO	8D0 611 775 E , 4E0 611 775 F , 8E0 611 775	83.6212-0180.3
	6,0 W12 Quattro				83.7812-0180.3	330854	LATIGUILLO	8D0 611 775 E , 4E0 611 775 F , 8E0 611 775	83.6212-0180.3
			02.2004		83.7812-0180.3	330854	LATIGUILLO	8D0 611 775 E , 4E0 611 775 F , 8E0 611 775	83.6212-0180.3
	S8				83.7812-0180.3	330854	LATIGUILLO	8D0 611 775 E , 4E0 611 775 F , 8E0 611 775	83.6212-0180.3
			06.2006		83.7812-0180.3	330854	LATIGUILLO	8D0 611 775 E , 4E0 611 775 F , 8E0 611 775	83.6212-0180.3
TT Coupe (06-)	2,0 TDI Quattro		06.2008		24.0325-0158.1	525158	POWER-DISC	1K0 615 301 AA	
	2,0 TFSI		07.2006		24.0325-0158.1	525158	POWER-DISC	1K0 615 301 AA	
	3,2 Quattro		07.2006		24.0325-0158.1	525158	POWER-DISC	1K0 615 301 AA	
TT Coupe (98-06)	1,8 T		09.2002	06.2006	24.3727-0189.2	580189	CABLE FRENO DE MANO	8N0 609 721 F	



	i			Denominación	Ref. OE correspondientes a las referencias ATE	i Referencia anterior / varios
--	----------	--	--	---------------------	-------------------------------------------------------	------------------------------------------







AUDI

TT Coupe (98-06)	1,8 T		09.2005	06.2006	24.3727-0189.2	580189	CABLE FRENO DE MANO	8N0 609 721 F	
			10.1998		24.3727-0190.2	580190	CABLE FRENO DE MANO	8N0 609 721 C	
				06.2006	24.3727-0189.2	580189	CABLE FRENO DE MANO	8N0 609 721 F	
TT Roadster (07-)	2,0 TDI Quattro		06.2008		24.0325-0158.1	525158	POWER-DISC	1K0 615 301 AA	
	2,0 TFSI		02.2007		24.0325-0158.1	525158	POWER-DISC	1K0 615 301 AA	
	3,2 Quattro		02.2007		24.0325-0158.1	525158	POWER-DISC	1K0 615 301 AA	
TT Roadster (99-06)	1,8 T			06.2006	24.3727-0189.2	580189	CABLE FRENO DE MANO	8N0 609 721 F	
			01.2001	06.2006	24.3727-0189.2	580189	CABLE FRENO DE MANO	8N0 609 721 F	
			09.2005	06.2006	24.3727-0189.2	580189	CABLE FRENO DE MANO	8N0 609 721 F	
			04.1999		24.3727-0190.2	580190	CABLE FRENO DE MANO	8N0 609 721 C	

Nuevas referencias en almacén - Por aplicación

09/2008



					Denominación	Ref. OE correspondientes a las referencias ATE	 Referencia anterior / varios
-----------------------------------------------------------------------------------	-----------------------------------------------------------------------------------	-----------------------------------------------------------------------------------	-------------------------------------------------------------------------------------	-------------------------------------------------------------------------------------	--------------	------------------------------------------------	------------------------------------------------------------------------------------------------------------------

BMW

Serie	Modelo	09.2004	09.2007	24.3727-0234.2	580234	Denominación	Ref. OE correspondientes a las referencias ATE
Serie 1/E81/E87 Berlina (04-)	116 i					CABLE FRENO DE MANO	34 40 6 760 443
						CABLE FRENO DE MANO	34 40 6 760 443
	118 d					CABLE FRENO DE MANO	34 40 6 760 443
						CABLE FRENO DE MANO	34 40 6 760 443
	118 i					CABLE FRENO DE MANO	34 40 6 760 443
						CABLE FRENO DE MANO	34 40 6 760 443
	120 d					CABLE FRENO DE MANO	34 40 6 760 443
						CABLE FRENO DE MANO	34 40 6 760 443
	120 i					CABLE FRENO DE MANO	34 40 6 760 443
						CABLE FRENO DE MANO	34 40 6 760 443
	123 d					CABLE FRENO DE MANO	34 40 6 760 443
						CABLE FRENO DE MANO	34 40 6 760 443
1er Reihe/E82 Coupe (07-)	120 d					CABLE FRENO DE MANO	34 40 6 760 443
						CABLE FRENO DE MANO	34 40 6 760 443
	125 i					CABLE FRENO DE MANO	34 40 6 760 443
						CABLE FRENO DE MANO	34 40 6 760 443
	135 i					CABLE FRENO DE MANO	34 40 6 760 443
						CABLE FRENO DE MANO	34 40 6 760 443
1er Reihe/E88 Cabrio (08-)	118 i					CABLE FRENO DE MANO	34 40 6 760 443
						CABLE FRENO DE MANO	34 40 6 760 443
	120 d					CABLE FRENO DE MANO	34 40 6 760 443
						CABLE FRENO DE MANO	34 40 6 760 443
	120 i					CABLE FRENO DE MANO	34 40 6 760 443

Nuevas referencias en almacén - Por aplicación

09/2008



					Denominación	Ref. OE correspondientes a las referencias ATE		Referencia anterior / varios
--	--	--	--	--	--------------	------------------------------------------------	--	------------------------------







BMW

Modelo	Motor	Fecha 1	Fecha 2	Ref. ATE	Ref. OE	Denominación	Ref. OE correspondientes a las referencias ATE	Referencia anterior / varios
1er Reihe/E88 Cabrio (08-)	125 i	03.2008		24.3727-0234.2	580234	CABLE FRENO DE MANO	34 40 6 760 443	
	135 i	03.2008		24.3727-0234.2	580234	CABLE FRENO DE MANO	34 40 6 760 443	
Serie 3/E90 Berlina (05-)	316 i	01.2005	08.2007	24.3727-0233.2	580233	CABLE FRENO DE MANO	34 40 6 760 444	
		09.2007		24.3727-0233.2	580233	CABLE FRENO DE MANO	34 40 6 760 444	
	318 d	09.2007		24.3727-0233.2	580233	CABLE FRENO DE MANO	34 40 6 760 444	
		09.2005	08.2007	24.3727-0233.2	580233	CABLE FRENO DE MANO	34 40 6 760 444	
	318 i	09.2007		24.3727-0233.2	580233	CABLE FRENO DE MANO	34 40 6 760 444	
		09.2005	08.2007	24.3727-0233.2	580233	CABLE FRENO DE MANO	34 40 6 760 444	
	320 d	09.2007		24.3727-0233.2	580233	CABLE FRENO DE MANO	34 40 6 760 444	
		12.2004	08.2007	24.3727-0233.2	580233	CABLE FRENO DE MANO	34 40 6 760 444	
	320 i	12.2004	08.2007	24.3727-0233.2	580233	CABLE FRENO DE MANO	34 40 6 760 444	
		09.2007		24.3727-0233.2	580233	CABLE FRENO DE MANO	34 40 6 760 444	
	320 si	06.2006		24.3727-0233.2	580233	CABLE FRENO DE MANO	34 40 6 760 444	
	325 d	09.2006		24.3727-0233.2	580233	CABLE FRENO DE MANO	34 40 6 760 444	
	325 i	12.2004		24.3727-0233.2	580233	CABLE FRENO DE MANO	34 40 6 760 444	
	325 xi	01.2005		24.3727-0233.2	580233	CABLE FRENO DE MANO	34 40 6 760 444	
	330 d	09.2005		24.3727-0233.2	580233	CABLE FRENO DE MANO	34 40 6 760 444	
	330 i	09.2007		24.3727-0233.2	580233	CABLE FRENO DE MANO	34 40 6 760 444	
		12.2004	08.2007	24.3727-0233.2	580233	CABLE FRENO DE MANO	34 40 6 760 444	

Nuevas referencias en almacén - Por aplicación

09/2008



					Denominación	Ref. OE correspondientes a las referencias ATE		Referencia anterior / varios
-----------------------------------------------------------------------------------	-----------------------------------------------------------------------------------	-----------------------------------------------------------------------------------	-------------------------------------------------------------------------------------	-------------------------------------------------------------------------------------	--------------	------------------------------------------------	-------------------------------------------------------------------------------------	------------------------------







BMW

Serie	Modelo								
Serie 3/E90 Berlina (05-)	330 xd		09.2005		24.3727-0233.2	580233	CABLE FRENO DE MANO	34 40 6 760 444	
	330 xi		09.2007		24.3727-0233.2	580233	CABLE FRENO DE MANO	34 40 6 760 444	
			01.2005	08.2007	24.3727-0233.2	580233	CABLE FRENO DE MANO	34 40 6 760 444	
	335 d		09.2006		24.3727-0233.2	580233	CABLE FRENO DE MANO	34 40 6 760 444	
	335 i		09.2006		24.3727-0233.2	580233	CABLE FRENO DE MANO	34 40 6 760 444	
	335 xi		03.2007		24.3727-0233.2	580233	CABLE FRENO DE MANO	34 40 6 760 444	
	M3		12.2007		24.3727-0233.2	580233	CABLE FRENO DE MANO	34 40 6 760 444	
		DD	12.2007		24.8190-0258.2	620258	CONTACTO DE DESGASTE	34 35 2 283 405	
		DI	12.2007		24.8190-0257.2	620257	CONTACTO DE DESGASTE	34 35 2 283 335	
Serie 3/E91 Touring (05-)	318 d		09.2007		24.3727-0233.2	580233	CABLE FRENO DE MANO	34 40 6 760 444	
			09.2005	08.2007	24.3727-0233.2	580233	CABLE FRENO DE MANO	34 40 6 760 444	
	318 i		09.2007		24.3727-0233.2	580233	CABLE FRENO DE MANO	34 40 6 760 444	
			01.2006	08.2007	24.3727-0233.2	580233	CABLE FRENO DE MANO	34 40 6 760 444	
	320 d		09.2007		24.3727-0233.2	580233	CABLE FRENO DE MANO	34 40 6 760 444	
			06.2005	08.2007	24.3727-0233.2	580233	CABLE FRENO DE MANO	34 40 6 760 444	
	320 i		09.2007		24.3727-0233.2	580233	CABLE FRENO DE MANO	34 40 6 760 444	
			06.2005	08.2007	24.3727-0233.2	580233	CABLE FRENO DE MANO	34 40 6 760 444	
	323 i		06.2005		24.3727-0233.2	580233	CABLE FRENO DE MANO	34 40 6 760 444	
	325 d		09.2006		24.3727-0233.2	580233	CABLE FRENO DE MANO	34 40 6 760 444	

Nuevas referencias en almacén - Por aplicación

09/2008



					Denominación	Ref. OE correspondientes a las referencias ATE	 Referencia anterior / varios
-----------------------------------------------------------------------------------	-----------------------------------------------------------------------------------	-----------------------------------------------------------------------------------	-------------------------------------------------------------------------------------	-------------------------------------------------------------------------------------	--------------	------------------------------------------------	------------------------------------------------------------------------------------------------------------------

BMW

Serie	Modelo	Fecha 1	Fecha 2	Ref. ATE	Ref. OE	Denominación	Ref. OE correspondientes a las referencias ATE	
Serie 3/E91 Touring (05-)	325 i	06.2005		24.3727-0233.2	580233	CABLE FRENO DE MANO	34 40 6 760 444	
	325 xi	06.2005		24.3727-0233.2	580233	CABLE FRENO DE MANO	34 40 6 760 444	
	330 d	06.2005		24.3727-0233.2	580233	CABLE FRENO DE MANO	34 40 6 760 444	
	330 i	09.2007		24.3727-0233.2	580233	CABLE FRENO DE MANO	34 40 6 760 444	
			06.2005	08.2007	24.3727-0233.2	580233	CABLE FRENO DE MANO	34 40 6 760 444
	330 xd	06.2005		24.3727-0233.2	580233	CABLE FRENO DE MANO	34 40 6 760 444	
	330 xi	09.2007		24.3727-0233.2	580233	CABLE FRENO DE MANO	34 40 6 760 444	
			06.2005	08.2007	24.3727-0233.2	580233	CABLE FRENO DE MANO	34 40 6 760 444
	335 d	09.2006		24.3727-0233.2	580233	CABLE FRENO DE MANO	34 40 6 760 444	
	335 i	09.2006		24.3727-0233.2	580233	CABLE FRENO DE MANO	34 40 6 760 444	
Serie 3/E92 Coupé (06-)	335 xi	03.2007		24.3727-0233.2	580233	CABLE FRENO DE MANO	34 40 6 760 444	
	320 d	03.2007		24.3727-0233.2	580233	CABLE FRENO DE MANO	34 40 6 760 444	
	320 i	03.2007		24.3727-0233.2	580233	CABLE FRENO DE MANO	34 40 6 760 444	
	323 i	09.2006		24.3727-0233.2	580233	CABLE FRENO DE MANO	34 40 6 760 444	
	325 d	03.2007		24.3727-0233.2	580233	CABLE FRENO DE MANO	34 40 6 760 444	
	325 i	09.2006		24.3727-0233.2	580233	CABLE FRENO DE MANO	34 40 6 760 444	
	325 xi	09.2006		24.3727-0233.2	580233	CABLE FRENO DE MANO	34 40 6 760 444	
	330 d	09.2006		24.3727-0233.2	580233	CABLE FRENO DE MANO	34 40 6 760 444	
330 i	09.2006		24.3727-0233.2	580233	CABLE FRENO DE MANO	34 40 6 760 444		

Nuevas referencias en almacén - Por aplicación

09/2008



					Denominación	Ref. OE correspondientes a las referencias ATE		Referencia anterior / varios
--	--	--	--	--	--------------	------------------------------------------------	--	------------------------------







BMW

Serie 3/E92 Coupé (06-)	330 xd		09.2006		24.3727-0233.2	580233	CABLE FRENO DE MANO	34 40 6 760 444	
	330 xi		09.2006		24.3727-0233.2	580233	CABLE FRENO DE MANO	34 40 6 760 444	
	335 d		09.2006		24.3727-0233.2	580233	CABLE FRENO DE MANO	34 40 6 760 444	
	335 i		09.2006		24.3727-0233.2	580233	CABLE FRENO DE MANO	34 40 6 760 444	
	335 xi		09.2007		24.3727-0233.2	580233	CABLE FRENO DE MANO	34 40 6 760 444	
	M3		03.2007		24.3727-0233.2	580233	CABLE FRENO DE MANO	34 40 6 760 444	
		DD	03.2007		24.8190-0258.2	620258	CONTACTO DE DESGASTE	34 35 2 283 405	
		DI	03.2007		24.8190-0257.2	620257	CONTACTO DE DESGASTE	34 35 2 283 335	
Serie 3/E93 Cabrióle (07-)	320 d		03.2008		24.3727-0233.2	580233	CABLE FRENO DE MANO	34 40 6 760 444	
	320 i		03.2007		24.3727-0233.2	580233	CABLE FRENO DE MANO	34 40 6 760 444	
	325 d		09.2007		24.3727-0233.2	580233	CABLE FRENO DE MANO	34 40 6 760 444	
	325 i		03.2007		24.3727-0233.2	580233	CABLE FRENO DE MANO	34 40 6 760 444	
	330 d		03.2007		24.3727-0233.2	580233	CABLE FRENO DE MANO	34 40 6 760 444	
	330 i		03.2007		24.3727-0233.2	580233	CABLE FRENO DE MANO	34 40 6 760 444	
	335 i		03.2007		24.3727-0233.2	580233	CABLE FRENO DE MANO	34 40 6 760 444	
	M3		03.2008		24.3727-0233.2	580233	CABLE FRENO DE MANO	34 40 6 760 444	
		DI	03.2008		24.8190-0257.2	620257	CONTACTO DE DESGASTE	34 35 2 283 335	
		DD	03.2008		24.8190-0258.2	620258	CONTACTO DE DESGASTE	34 35 2 283 405	
Serie 5/E60 Berlina (03-)	520 d	TD	07.2005		24.3727-0237.2	580237	CABLE FRENO DE MANO	34 40 6 761 098 , 34 40 6 770 602	

Nuevas referencias en almacén - Por aplicación

09/2008



					Denominación	Ref. OE correspondientes a las referencias ATE	 Referencia anterior / varios
-----------------------------------------------------------------------------------	-----------------------------------------------------------------------------------	-----------------------------------------------------------------------------------	-------------------------------------------------------------------------------------	-------------------------------------------------------------------------------------	--------------	------------------------------------------------	------------------------------------------------------------------------------------------------------------------







BMW

Serie	Modelo	Aplicación	Fecha	Fecha	Ref. ATE	Ref. OE	Denominación	Ref. OE correspondientes a las referencias ATE	Referencia anterior / varios	
Serie 5/E60 Berlina (03-)	520 d	TD	09.2007		24.3727-0237.2	580237	CABLE FRENO DE MANO	34 40 6 761 098 , 34 40 6 770 602		
		TI	07.2005		24.3727-0236.2	580236	CABLE FRENO DE MANO	34 40 6 761 097 , 34 40 6 770 603		
		TI	09.2007		24.3727-0236.2	580236	CABLE FRENO DE MANO	34 40 6 761 097 , 34 40 6 770 603		
				09.2007		24.0330-0173.1	530173	POWER-DISC	34 11 6 753 221 , 34 11 6 767 269	
				07.2005		24.0324-0181.1	524181	POWER-DISC	34 11 6 764 021	
				07.2005		24.0330-0173.1	530173	POWER-DISC	34 11 6 753 221 , 34 11 6 767 269	
	520 i	TI	07.2003	03.2005	24.3727-0236.2	580236	CABLE FRENO DE MANO	34 40 6 761 097 , 34 40 6 770 603		
		TD	07.2003	03.2005	24.3727-0237.2	580237	CABLE FRENO DE MANO	34 40 6 761 098 , 34 40 6 770 602		
				07.2003	03.2005	24.0324-0181.1	524181	POWER-DISC	34 11 6 764 021	
				07.2003	03.2005	24.0330-0173.1	530173	POWER-DISC	34 11 6 753 221 , 34 11 6 767 269	
	523 i	TI	03.2007		24.3727-0236.2	580236	CABLE FRENO DE MANO	34 40 6 761 097 , 34 40 6 770 603		
		TD	03.2007		24.3727-0237.2	580237	CABLE FRENO DE MANO	34 40 6 761 098 , 34 40 6 770 602		
				07.2005	03.2007	24.3727-0237.2	580237	CABLE FRENO DE MANO	34 40 6 761 098 , 34 40 6 770 602	
			07.2005	03.2007	24.3727-0236.2	580236	CABLE FRENO DE MANO	34 40 6 761 097 , 34 40 6 770 603		

Nuevas referencias en almacén - Por aplicación

09/2008



					Denominación	Ref. OE correspondientes a las referencias ATE	 Referencia anterior / varios
-----------------------------------------------------------------------------------	-----------------------------------------------------------------------------------	-----------------------------------------------------------------------------------	-------------------------------------------------------------------------------------	-------------------------------------------------------------------------------------	--------------	------------------------------------------------	---------------------------------------------------------------------------------------------------------------------

BMW

Serie 5/E60 Berlina (03-)	523 i		03.2007		24.0330-0173.1	530173	POWER-DISC	34 11 6 753 221 , 34 11 6 767 269	
			03.2007		24.0324-0181.1	524181	POWER-DISC	34 11 6 764 021	
			07.2005	03.2007	24.0324-0181.1	524181	POWER-DISC	34 11 6 764 021	
			07.2005	03.2007	24.0330-0173.1	530173	POWER-DISC	34 11 6 753 221 , 34 11 6 767 269	
	525 d	TI	10.2003	03.2007	24.3727-0236.2	580236	CABLE FRENO DE MANO	34 40 6 761 097 , 34 40 6 770 603	
		TI	03.2007		24.3727-0236.2	580236	CABLE FRENO DE MANO	34 40 6 761 097 , 34 40 6 770 603	
		TD	03.2007		24.3727-0237.2	580237	CABLE FRENO DE MANO	34 40 6 761 098 , 34 40 6 770 602	
		TD	10.2003	03.2007	24.3727-0237.2	580237	CABLE FRENO DE MANO	34 40 6 761 098 , 34 40 6 770 602	
			10.2003	03.2007	24.0324-0181.1	524181	POWER-DISC	34 11 6 764 021	
			03.2007		24.0330-0173.1	530173	POWER-DISC	34 11 6 753 221 , 34 11 6 767 269	
			10.2003	03.2007	24.0330-0173.1	530173	POWER-DISC	34 11 6 753 221 , 34 11 6 767 269	
	525 i	TI	07.2003	06.2005	24.3727-0236.2	580236	CABLE FRENO DE MANO	34 40 6 761 097 , 34 40 6 770 603	
		TI	07.2005		24.3727-0236.2	580236	CABLE FRENO DE MANO	34 40 6 761 097 , 34 40 6 770 603	
		TD	07.2003	06.2005	24.3727-0237.2	580237	CABLE FRENO DE MANO	34 40 6 761 098 , 34 40 6 770 602	

Nuevas referencias en almacén - Por aplicación

09/2008



					Denominación	Ref. OE correspondientes a las referencias ATE		Referencia anterior / varios
--	--	--	--	--	--------------	------------------------------------------------	--	------------------------------







BMW

Serie	Modelo	Tipo	Fecha 1	Fecha 2	Ref. ATE	Ref. OE	Denominación	Ref. OE correspondientes a las referencias ATE	Referencia anterior / varios
Serie 5/E60 Berlina (03-)	525 i	TD	07.2005		24.3727-0237.2	580237	CABLE FRENO DE MANO	34 40 6 761 098 , 34 40 6 770 602	
			03.2007		24.0330-0173.1	530173	POWER-DISC	34 11 6 753 221 , 34 11 6 767 269	
			07.2005	03.2007	24.0330-0173.1	530173	POWER-DISC	34 11 6 753 221 , 34 11 6 767 269	
			07.2003	06.2005	24.0324-0181.1	524181	POWER-DISC	34 11 6 764 021	
			03.2007		24.0324-0181.1	524181	POWER-DISC	34 11 6 764 021	
	525 xd	TI	03.2007		24.3727-0236.2	580236	CABLE FRENO DE MANO	34 40 6 761 097 , 34 40 6 770 603	
		TD	03.2007		24.3727-0237.2	580237	CABLE FRENO DE MANO	34 40 6 761 098 , 34 40 6 770 602	
			03.2007		24.0330-0173.1	530173	POWER-DISC	34 11 6 753 221 , 34 11 6 767 269	
	525 xi	TI	07.2005		24.3727-0236.2	580236	CABLE FRENO DE MANO	34 40 6 761 097 , 34 40 6 770 603	
		TD	07.2005		24.3727-0237.2	580237	CABLE FRENO DE MANO	34 40 6 761 098 , 34 40 6 770 602	
			07.2005		24.0330-0173.1	530173	POWER-DISC	34 11 6 753 221 , 34 11 6 767 269	
	530 d	TI	07.2003	08.2005	24.3727-0236.2	580236	CABLE FRENO DE MANO	34 40 6 761 097 , 34 40 6 770 603	
		TI	03.2007		24.3727-0236.2	580236	CABLE FRENO DE MANO	34 40 6 761 097 , 34 40 6 770 603	

Nuevas referencias en almacén - Por aplicación

09/2008



					Denominación	Ref. OE correspondientes a las referencias ATE	 Referencia anterior / varios
-----------------------------------------------------------------------------------	-----------------------------------------------------------------------------------	-----------------------------------------------------------------------------------	-------------------------------------------------------------------------------------	-------------------------------------------------------------------------------------	--------------	------------------------------------------------	------------------------------------------------------------------------------------------------------------------

BMW

Serie	Modelo	TI	07.2003	03.2007	24.3727-0236.2	580236	CABLE FRENO DE MANO	34 40 6 761 097 , 34 40 6 770 603	
Serie 5/E60 Berlina (03-)	530 d	TI	07.2003	03.2007	24.3727-0236.2	580236	CABLE FRENO DE MANO	34 40 6 761 097 , 34 40 6 770 603	
		TD	03.2007		24.3727-0237.2	580237	CABLE FRENO DE MANO	34 40 6 761 098 , 34 40 6 770 602	
		TD	07.2003	03.2007	24.3727-0237.2	580237	CABLE FRENO DE MANO	34 40 6 761 098 , 34 40 6 770 602	
		TD	07.2003	08.2005	24.3727-0237.2	580237	CABLE FRENO DE MANO	34 40 6 761 098 , 34 40 6 770 602	
			07.2003	08.2005	24.0330-0173.1	530173	POWER-DISC	34 11 6 753 221 , 34 11 6 767 269	
			07.2003	03.2007	24.0330-0173.1	530173	POWER-DISC	34 11 6 753 221 , 34 11 6 767 269	
			03.2007		24.0330-0173.1	530173	POWER-DISC	34 11 6 753 221 , 34 11 6 767 269	
	530 i	TD	03.2007		24.3727-0237.2	580237	CABLE FRENO DE MANO	34 40 6 761 098 , 34 40 6 770 602	
		TI	03.2007		24.3727-0236.2	580236	CABLE FRENO DE MANO	34 40 6 761 097 , 34 40 6 770 603	
		TD	07.2003	03.2005	24.3727-0237.2	580237	CABLE FRENO DE MANO	34 40 6 761 098 , 34 40 6 770 602	
		TI	07.2005	03.2007	24.3727-0236.2	580236	CABLE FRENO DE MANO	34 40 6 761 097 , 34 40 6 770 603	
		TI	07.2003	03.2005	24.3727-0236.2	580236	CABLE FRENO DE MANO	34 40 6 761 097 , 34 40 6 770 603	
		TD	07.2005	03.2007	24.3727-0237.2	580237	CABLE FRENO DE MANO	34 40 6 761 098 , 34 40 6 770 602	



					Denominación	Ref. OE correspondientes a las referencias ATE		Referencia anterior / varios
--	--	--	--	--	--------------	------------------------------------------------	--	------------------------------







BMW

Serie 5/E60 Berlina (03-)	530 i		07.2005	03.2007	24.0330-0173.1	530173	POWER-DISC	34 11 6 753 221 , 34 11 6 767 269	
			03.2007		24.0330-0173.1	530173	POWER-DISC	34 11 6 753 221 , 34 11 6 767 269	
			07.2003	03.2005	24.0330-0173.1	530173	POWER-DISC	34 11 6 753 221 , 34 11 6 767 269	
	530 xd	TD	03.2007		24.3727-0237.2	580237	CABLE FRENO DE MANO	34 40 6 761 098 , 34 40 6 770 602	
		TD	07.2005	03.2007	24.3727-0237.2	580237	CABLE FRENO DE MANO	34 40 6 761 098 , 34 40 6 770 602	
		TI	07.2005	03.2007	24.3727-0236.2	580236	CABLE FRENO DE MANO	34 40 6 761 097 , 34 40 6 770 603	
		TI	03.2007		24.3727-0236.2	580236	CABLE FRENO DE MANO	34 40 6 761 097 , 34 40 6 770 603	
			03.2007		24.0330-0173.1	530173	POWER-DISC	34 11 6 753 221 , 34 11 6 767 269	
			07.2005	03.2007	24.0330-0173.1	530173	POWER-DISC	34 11 6 753 221 , 34 11 6 767 269	
	530 xi	TD	07.2005	03.2007	24.3727-0237.2	580237	CABLE FRENO DE MANO	34 40 6 761 098 , 34 40 6 770 602	
		TI	07.2005	03.2007	24.3727-0236.2	580236	CABLE FRENO DE MANO	34 40 6 761 097 , 34 40 6 770 603	
		TI	03.2007		24.3727-0236.2	580236	CABLE FRENO DE MANO	34 40 6 761 097 , 34 40 6 770 603	
		TD	03.2007		24.3727-0237.2	580237	CABLE FRENO DE MANO	34 40 6 761 098 , 34 40 6 770 602	

Nuevas referencias en almacén - Por aplicación

09/2008



					Denominación	Ref. OE correspondientes a las referencias ATE	 Referencia anterior / varios
-----------------------------------------------------------------------------------	-----------------------------------------------------------------------------------	-----------------------------------------------------------------------------------	-------------------------------------------------------------------------------------	-------------------------------------------------------------------------------------	--------------	------------------------------------------------	------------------------------------------------------------------------------------------------------------------

BMW

Serie 5/E60 Berlina (03-)	530 xi		03.2007		24.0330-0173.1	530173	POWER-DISC	34 11 6 753 221 , 34 11 6 767 269	
			07.2005	03.2007	24.0330-0173.1	530173	POWER-DISC	34 11 6 753 221 , 34 11 6 767 269	
	535 d		09.2004	03.2007	24.0136-0106.2	436106	DISCO DE FRENO	34 11 6 766 871 , 34 11 6 779 467	
			03.2007		24.0136-0106.2	436106	DISCO DE FRENO	34 11 6 766 871 , 34 11 6 779 467	
		TI	03.2007		24.3727-0236.2	580236	CABLE FRENO DE MANO	34 40 6 761 097 , 34 40 6 770 603	
		TD	03.2007		24.3727-0237.2	580237	CABLE FRENO DE MANO	34 40 6 761 098 , 34 40 6 770 602	
		TI	09.2004	03.2007	24.3727-0236.2	580236	CABLE FRENO DE MANO	34 40 6 761 097 , 34 40 6 770 603	
		TD	09.2004	03.2007	24.3727-0237.2	580237	CABLE FRENO DE MANO	34 40 6 761 098 , 34 40 6 770 602	
	540 i		03.2007		24.0136-0106.2	436106	DISCO DE FRENO	34 11 6 766 871 , 34 11 6 779 467	
		TD	07.2005		24.3727-0237.2	580237	CABLE FRENO DE MANO	34 40 6 761 098 , 34 40 6 770 602	
		TI	07.2005		24.3727-0236.2	580236	CABLE FRENO DE MANO	34 40 6 761 097 , 34 40 6 770 603	
	545 i	TD	07.2003	08.2005	24.3727-0237.2	580237	CABLE FRENO DE MANO	34 40 6 761 098 , 34 40 6 770 602	
		TI	07.2003	08.2005	24.3727-0236.2	580236	CABLE FRENO DE MANO	34 40 6 761 097 , 34 40 6 770 603	



					Denominación	Ref. OE correspondientes a las referencias ATE		Referencia anterior / varios
--	--	--	--	--	--------------	------------------------------------------------	--	------------------------------

BMW

Serie 5/E60 Berlina (03-)	550 i		07.2005	03.2007	24.0136-0106.2	436106	DISCO DE FRENO	34 11 6 766 871 , 34 11 6 779 467	
			03.2007		24.0136-0106.2	436106	DISCO DE FRENO	34 11 6 766 871 , 34 11 6 779 467	
		TD	07.2005		24.3727-0237.2	580237	CABLE FRENO DE MANO	34 40 6 761 098 , 34 40 6 770 602	
		TI	07.2005		24.3727-0236.2	580236	CABLE FRENO DE MANO	34 40 6 761 097 , 34 40 6 770 603	
	M5	TI	09.2004		24.3727-0236.2	580236	CABLE FRENO DE MANO	34 40 6 761 097 , 34 40 6 770 603	
		TD	09.2004		24.3727-0237.2	580237	CABLE FRENO DE MANO	34 40 6 761 098 , 34 40 6 770 602	
Serie 5/E61 Touring (04-)	520 d	TI	09.2007		24.3727-0236.2	580236	CABLE FRENO DE MANO	34 40 6 761 097 , 34 40 6 770 603	
		TI	07.2005		24.3727-0236.2	580236	CABLE FRENO DE MANO	34 40 6 761 097 , 34 40 6 770 603	
		TD	09.2007		24.3727-0237.2	580237	CABLE FRENO DE MANO	34 40 6 761 098 , 34 40 6 770 602	
		TD	07.2005		24.3727-0237.2	580237	CABLE FRENO DE MANO	34 40 6 761 098 , 34 40 6 770 602	
			07.2005		24.0324-0181.1	524181	POWER-DISC	34 11 6 764 021	
			09.2007		24.0330-0173.1	530173	POWER-DISC	34 11 6 753 221 , 34 11 6 767 269	
			07.2005		24.0330-0173.1	530173	POWER-DISC	34 11 6 753 221 , 34 11 6 767 269	
	523 i	TD	07.2005	03.2007	24.3727-0237.2	580237	CABLE FRENO DE MANO	34 40 6 761 098 , 34 40 6 770 602	

Nuevas referencias en almacén - Por aplicación

09/2008



					Denominación	Ref. OE correspondientes a las referencias ATE		Referencia anterior / varios
--	--	--	--	--	--------------	------------------------------------------------	--	------------------------------

BMW

Serie 5/E61 Touring (04-)	523 i	TI	03.2007		24.3727-0236.2	580236	CABLE FRENO DE MANO	34 40 6 761 097 , 34 40 6 770 603	
		TD	03.2007		24.3727-0237.2	580237	CABLE FRENO DE MANO	34 40 6 761 098 , 34 40 6 770 602	
		TI	07.2005	03.2007	24.3727-0236.2	580236	CABLE FRENO DE MANO	34 40 6 761 097 , 34 40 6 770 603	
			03.2007		24.0330-0173.1	530173	POWER-DISC	34 11 6 753 221 , 34 11 6 767 269	
			07.2005	03.2007	24.0324-0181.1	524181	POWER-DISC	34 11 6 764 021	
			07.2005	03.2007	24.0330-0173.1	530173	POWER-DISC	34 11 6 753 221 , 34 11 6 767 269	
			03.2007		24.0324-0181.1	524181	POWER-DISC	34 11 6 764 021	
	525 d	TI	05.2004	03.2007	24.3727-0236.2	580236	CABLE FRENO DE MANO	34 40 6 761 097 , 34 40 6 770 603	
		TI	03.2007		24.3727-0236.2	580236	CABLE FRENO DE MANO	34 40 6 761 097 , 34 40 6 770 603	
		TD	03.2007		24.3727-0237.2	580237	CABLE FRENO DE MANO	34 40 6 761 098 , 34 40 6 770 602	
		TD	05.2004	03.2007	24.3727-0237.2	580237	CABLE FRENO DE MANO	34 40 6 761 098 , 34 40 6 770 602	
			05.2004	03.2007	24.0324-0181.1	524181	POWER-DISC	34 11 6 764 021	
			05.2004	03.2007	24.0330-0173.1	530173	POWER-DISC	34 11 6 753 221 , 34 11 6 767 269	
			03.2007		24.0330-0173.1	530173	POWER-DISC	34 11 6 753 221 , 34 11 6 767 269	



					Denominación	Ref. OE correspondientes a las referencias ATE		Referencia anterior / varios
--	--	--	--	--	--------------	------------------------------------------------	--	------------------------------

BMW

Serie 5/E61 Touring (04-)	525 i	TI	05.2004	03.2005	24.3727-0236.2	580236	CABLE FRENO DE MANO	34 40 6 761 097 , 34 40 6 770 603	
		TI	07.2005		24.3727-0236.2	580236	CABLE FRENO DE MANO	34 40 6 761 097 , 34 40 6 770 603	
		TD	07.2005		24.3727-0237.2	580237	CABLE FRENO DE MANO	34 40 6 761 098 , 34 40 6 770 602	
		TD	05.2004	03.2005	24.3727-0237.2	580237	CABLE FRENO DE MANO	34 40 6 761 098 , 34 40 6 770 602	
			07.2005	03.2007	24.0330-0173.1	530173	POWER-DISC	34 11 6 753 221 , 34 11 6 767 269	
			03.2007		24.0330-0173.1	530173	POWER-DISC	34 11 6 753 221 , 34 11 6 767 269	
			05.2004	03.2005	24.0330-0173.1	530173	POWER-DISC	34 11 6 753 221 , 34 11 6 767 269	
			03.2007		24.0324-0181.1	524181	POWER-DISC	34 11 6 764 021	
			05.2004	03.2005	24.0324-0181.1	524181	POWER-DISC	34 11 6 764 021	
	525 xd	TI	03.2007		24.3727-0236.2	580236	CABLE FRENO DE MANO	34 40 6 761 097 , 34 40 6 770 603	
		TD	03.2007		24.3727-0237.2	580237	CABLE FRENO DE MANO	34 40 6 761 098 , 34 40 6 770 602	
			03.2007		24.0330-0173.1	530173	POWER-DISC	34 11 6 753 221 , 34 11 6 767 269	
	525 xi	TI	07.2005		24.3727-0236.2	580236	CABLE FRENO DE MANO	34 40 6 761 097 , 34 40 6 770 603	
		TD	07.2005		24.3727-0237.2	580237	CABLE FRENO DE MANO	34 40 6 761 098 , 34 40 6 770 602	

Nuevas referencias en almacén - Por aplicación

09/2008



					Denominación	Ref. OE correspondientes a las referencias ATE		Referencia anterior / varios
--	--	--	--	--	--------------	------------------------------------------------	--	------------------------------

BMW

Serie 5/E61 Touring (04-)	525 xi		07.2005		24.0330-0173.1	530173	POWER-DISC	34 11 6 753 221 , 34 11 6 767 269	
	530 d	TI	05.2004	08.2005	24.3727-0236.2	580236	CABLE FRENO DE MANO	34 40 6 761 097 , 34 40 6 770 603	
		TD	07.2005	03.2007	24.3727-0237.2	580237	CABLE FRENO DE MANO	34 40 6 761 098 , 34 40 6 770 602	
		TD	05.2004	08.2005	24.3727-0237.2	580237	CABLE FRENO DE MANO	34 40 6 761 098 , 34 40 6 770 602	
		TD	03.2007		24.3727-0237.2	580237	CABLE FRENO DE MANO	34 40 6 761 098 , 34 40 6 770 602	
		TI	03.2007		24.3727-0236.2	580236	CABLE FRENO DE MANO	34 40 6 761 097 , 34 40 6 770 603	
		TI	07.2005	03.2007	24.3727-0236.2	580236	CABLE FRENO DE MANO	34 40 6 761 097 , 34 40 6 770 603	
			07.2005	03.2007	24.0330-0173.1	530173	POWER-DISC	34 11 6 753 221 , 34 11 6 767 269	
			03.2007		24.0330-0173.1	530173	POWER-DISC	34 11 6 753 221 , 34 11 6 767 269	
			05.2004	08.2005	24.0330-0173.1	530173	POWER-DISC	34 11 6 753 221 , 34 11 6 767 269	
	530 i	TI	03.2007		24.3727-0236.2	580236	CABLE FRENO DE MANO	34 40 6 761 097 , 34 40 6 770 603	
		TD	03.2007		24.3727-0237.2	580237	CABLE FRENO DE MANO	34 40 6 761 098 , 34 40 6 770 602	
		TD	07.2005	03.2007	24.3727-0237.2	580237	CABLE FRENO DE MANO	34 40 6 761 098 , 34 40 6 770 602	

Nuevas referencias en almacén - Por aplicación

09/2008



					Denominación	Ref. OE correspondientes a las referencias ATE		Referencia anterior / varios
--	--	--	--	--	--------------	------------------------------------------------	--	------------------------------







BMW

Serie	Modelo	TI	07.2005	03.2007	24.3727-0236.2	580236	Denominación	Ref. OE correspondientes a las referencias ATE	Referencia anterior / varios
Serie 5/E61 Touring (04-)	530 i	TI	07.2005	03.2007	24.3727-0236.2	580236	CABLE FRENO DE MANO	34 40 6 761 097 , 34 40 6 770 603	
			03.2007		24.0330-0173.1	530173	POWER-DISC	34 11 6 753 221 , 34 11 6 767 269	
			07.2005	03.2007	24.0330-0173.1	530173	POWER-DISC	34 11 6 753 221 , 34 11 6 767 269	
	530 xd	TI	07.2005	03.2007	24.3727-0236.2	580236	CABLE FRENO DE MANO	34 40 6 761 097 , 34 40 6 770 603	
		TI	03.2007		24.3727-0236.2	580236	CABLE FRENO DE MANO	34 40 6 761 097 , 34 40 6 770 603	
		TD	03.2007		24.3727-0237.2	580237	CABLE FRENO DE MANO	34 40 6 761 098 , 34 40 6 770 602	
		TD	07.2005	03.2007	24.3727-0237.2	580237	CABLE FRENO DE MANO	34 40 6 761 098 , 34 40 6 770 602	
			03.2007		24.0330-0173.1	530173	POWER-DISC	34 11 6 753 221 , 34 11 6 767 269	
			07.2005	03.2007	24.0330-0173.1	530173	POWER-DISC	34 11 6 753 221 , 34 11 6 767 269	
	530 xi	TD	03.2007		24.3727-0237.2	580237	CABLE FRENO DE MANO	34 40 6 761 098 , 34 40 6 770 602	
		TD	07.2005	03.2007	24.3727-0237.2	580237	CABLE FRENO DE MANO	34 40 6 761 098 , 34 40 6 770 602	
		TI	03.2007		24.3727-0236.2	580236	CABLE FRENO DE MANO	34 40 6 761 097 , 34 40 6 770 603	
		TI	07.2005	03.2007	24.3727-0236.2	580236	CABLE FRENO DE MANO	34 40 6 761 097 , 34 40 6 770 603	

Nuevas referencias en almacén - Por aplicación

09/2008



					Denominación	Ref. OE correspondientes a las referencias ATE	 Referencia anterior / varios
-----------------------------------------------------------------------------------	-----------------------------------------------------------------------------------	-----------------------------------------------------------------------------------	-------------------------------------------------------------------------------------	-------------------------------------------------------------------------------------	--------------	------------------------------------------------	------------------------------------------------------------------------------------------------------------------

BMW

Serie 5/E61 Touring (04-)	530 xi		07.2005	03.2007	24.0330-0173.1	530173	POWER-DISC	34 11 6 753 221 , 34 11 6 767 269	
			03.2007		24.0330-0173.1	530173	POWER-DISC	34 11 6 753 221 , 34 11 6 767 269	
	535 d		09.2004	03.2007	24.0136-0106.2	436106	DISCO DE FRENO	34 11 6 766 871 , 34 11 6 779 467	
			03.2007		24.0136-0106.2	436106	DISCO DE FRENO	34 11 6 766 871 , 34 11 6 779 467	
		TI	03.2007		24.3727-0236.2	580236	CABLE FRENO DE MANO	34 40 6 761 097 , 34 40 6 770 603	
		TI	09.2004	03.2007	24.3727-0236.2	580236	CABLE FRENO DE MANO	34 40 6 761 097 , 34 40 6 770 603	
		TD	09.2004	03.2007	24.3727-0237.2	580237	CABLE FRENO DE MANO	34 40 6 761 098 , 34 40 6 770 602	
		TD	03.2007		24.3727-0237.2	580237	CABLE FRENO DE MANO	34 40 6 761 098 , 34 40 6 770 602	
	545 i	TI	05.2004	08.2005	24.3727-0236.2	580236	CABLE FRENO DE MANO	34 40 6 761 097 , 34 40 6 770 603	
		TD	05.2004	08.2005	24.3727-0237.2	580237	CABLE FRENO DE MANO	34 40 6 761 098 , 34 40 6 770 602	
	550 i		07.2005	03.2007	24.0136-0106.2	436106	DISCO DE FRENO	34 11 6 766 871 , 34 11 6 779 467	
			03.2007		24.0136-0106.2	436106	DISCO DE FRENO	34 11 6 766 871 , 34 11 6 779 467	
		TI	07.2005		24.3727-0236.2	580236	CABLE FRENO DE MANO	34 40 6 761 097 , 34 40 6 770 603	



					Denominación	Ref. OE correspondientes a las referencias ATE		Referencia anterior / varios
--	--	--	--	--	--------------	------------------------------------------------	--	------------------------------







BMW

Serie 5/E61 Touring (04-)	550 i	TD	07.2005		24.3727-0237.2	580237	CABLE FRENO DE MANO	34 40 6 761 098 , 34 40 6 770 602	
	M5	TI	02.2007		24.3727-0236.2	580236	CABLE FRENO DE MANO	34 40 6 761 097 , 34 40 6 770 603	
		TD	02.2007		24.3727-0237.2	580237	CABLE FRENO DE MANO	34 40 6 761 098 , 34 40 6 770 602	
Serie 6/E63 Coupé (04-)	630 i		07.2004	08.2007	24.0330-0173.1	530173	POWER-DISC	34 11 6 753 221 , 34 11 6 767 269	
	635 d		09.2007		24.0136-0106.2	436106	DISCO DE FRENO	34 11 6 766 871 , 34 11 6 779 467	
	650 i		07.2005		24.0136-0106.2	436106	DISCO DE FRENO	34 11 6 766 871 , 34 11 6 779 467	
Serie 6/E64 Cabrióle (04-)	630 i		07.2004	08.2007	24.0330-0173.1	530173	POWER-DISC	34 11 6 753 221 , 34 11 6 767 269	
	635 d		09.2007		24.0136-0106.2	436106	DISCO DE FRENO	34 11 6 766 871 , 34 11 6 779 467	
	650 i		07.2005		24.0136-0106.2	436106	DISCO DE FRENO	34 11 6 766 871 , 34 11 6 779 467	
Serie 7/E38 (93-01)	725 tds	TI	05.1996	11.2001	24.3727-0232.2	580232	CABLE FRENO DE MANO	35 51 1 161 473	
	728 i	TI	07.1995	11.2001	24.3727-0232.2	580232	CABLE FRENO DE MANO	35 51 1 161 473	
	728 iL	TI	01.1996	11.2001	24.3727-0232.2	580232	CABLE FRENO DE MANO	35 51 1 161 473	
	730 d	TI	09.1998	11.2001	24.3727-0232.2	580232	CABLE FRENO DE MANO	35 51 1 161 473	
	730 i	TI	07.1993	11.2001	24.3727-0232.2	580232	CABLE FRENO DE MANO	35 51 1 161 473	
	730 iL	TI	05.1994	11.2001	24.3727-0232.2	580232	CABLE FRENO DE MANO	35 51 1 161 473	

Nuevas referencias en almacén - Por aplicación

09/2008



					Denominación	Ref. OE correspondientes a las referencias ATE		Referencia anterior / varios
-----------------------------------------------------------------------------------	-----------------------------------------------------------------------------------	-----------------------------------------------------------------------------------	-------------------------------------------------------------------------------------	-------------------------------------------------------------------------------------	--------------	------------------------------------------------	-------------------------------------------------------------------------------------	------------------------------

BMW

Serie	Modelo	TI	01.1996	11.2001	24.3727-0232.2	580232	Denominación	Ref. OE correspondientes a las referencias ATE	Referencia anterior / varios
Serie 7/E38 (93-01)	735 i	TI	01.1996	11.2001	24.3727-0232.2	580232	CABLE FRENO DE MANO	35 51 1 161 473	
	735 iL	TI	01.1996	11.2001	24.3727-0232.2	580232	CABLE FRENO DE MANO	35 51 1 161 473	
	740 d	TI	05.1999	11.2001	24.3727-0232.2	580232	CABLE FRENO DE MANO	35 51 1 161 473	
	740 i	TI	07.1993	11.2001	24.3727-0232.2	580232	CABLE FRENO DE MANO	35 51 1 161 473	
	740 iL	TI	05.1994	11.2001	24.3727-0232.2	580232	CABLE FRENO DE MANO	35 51 1 161 473	
	750 i	TI	11.1993	11.2001	24.3727-0232.2	580232	CABLE FRENO DE MANO	35 51 1 161 473	
	750 iL	TI	01.1994	11.2001	24.3727-0232.2	580232	CABLE FRENO DE MANO	35 51 1 161 473	
X3 (03-)	2,0 d	TI	08.2004		24.3727-0235.2	580235	CABLE FRENO DE MANO	34 40 3 400 795	
		TI	09.2007		24.3727-0235.2	580235	CABLE FRENO DE MANO	34 40 3 400 795	
	2,0 i	TI	07.2005		24.3727-0235.2	580235	CABLE FRENO DE MANO	34 40 3 400 795	
	2,5 i	TI	03.2004	08.2006	24.3727-0235.2	580235	CABLE FRENO DE MANO	34 40 3 400 795	
	2,5 si	TI	09.2006		24.3727-0235.2	580235	CABLE FRENO DE MANO	34 40 3 400 795	
	3,0 d	TI	10.2003	08.2006	24.3727-0235.2	580235	CABLE FRENO DE MANO	34 40 3 400 795	
		TI	01.2004		24.3727-0235.2	580235	CABLE FRENO DE MANO	34 40 3 400 795	
	3,0 i	TI	10.2003	08.2006	24.3727-0235.2	580235	CABLE FRENO DE MANO	34 40 3 400 795	
	3,0 sd	TI	09.2006		24.3727-0235.2	580235	CABLE FRENO DE MANO	34 40 3 400 795	
	3,0 si	TI	09.2006		24.3727-0235.2	580235	CABLE FRENO DE MANO	34 40 3 400 795	
X5 (07-)	3,0 sd		09.2007		13.0460-7239.2	607239	PASTILLAS DE FRENO	34 11 6 778 048	ver figura
			09.2007		24.8190-0255.2	620255	CONTACTO DE DESGASTE	34 35 6 773 008	



					Denominación	Ref. OE correspondientes a las referencias ATE		Referencia anterior / varios
--	--	--	--	--	--------------	------------------------------------------------	--	------------------------------





BMW

X5 (07-)	4,8 i		01.2007		13.0460-7239.2	607239	PASTILLAS DE FRENO	34 11 6 778 048	ver figura
			01.2007		24.8190-0255.2	620255	CONTACTO DE DESGASTE	34 35 6 773 008	
X6 (08-)	35 d		01.2008		13.0460-7239.2	607239	PASTILLAS DE FRENO	34 11 6 778 048	ver figura
			01.2008		24.8190-0255.2	620255	CONTACTO DE DESGASTE	34 35 6 773 008	
	35 i		01.2008		13.0460-7239.2	607239	PASTILLAS DE FRENO	34 11 6 778 048	ver figura
			01.2008		24.8190-0255.2	620255	CONTACTO DE DESGASTE	34 35 6 773 008	

CITROEN

JUMPER (06-)	2,2 HDi (12/14)		04.2006		24.0124-0208.1	424208	DISCO DE FRENO	4249 26 , 51728377 , 51740244 , 4249 27	
	2,2 HDi (16H)		04.2006		24.0124-0209.1	424209	DISCO DE FRENO	4249 35 , 51728378 , 51740247 , 4249 36	
			04.2006		24.0116-0125.1	416125	DISCO DE FRENO	4249 39 , 51749275 , 51740248 , 4249 40	
	3,0 HDi (12/14)		09.2006		24.0124-0208.1	424208	DISCO DE FRENO	4249 26 , 51728377 , 51740244 , 4249 27	
	3,0 HDi (16H)		04.2006		24.0116-0125.1	416125	DISCO DE FRENO	4249 39 , 51749275 , 51740248 , 4249 40	
			09.2006		24.0124-0209.1	424209	DISCO DE FRENO	4249 35 , 51728378 , 51740247 , 4249 36	



	i				Denominación	Ref. OE correspondientes a las referencias ATE	i Referencia anterior / varios
-----------------------------------------------------------------------------------	----------	-----------------------------------------------------------------------------------	-------------------------------------------------------------------------------------	-------------------------------------------------------------------------------------	---------------------	-------------------------------------------------------	------------------------------------------

DAEWOO

LANOS (97-02)	1,4 i		05.1997	12.2002	24.5233-0180.3	330888	LATIGUILLO	96215570	
	1,5 i		05.1997	12.2002	24.5233-0180.3	330888	LATIGUILLO	96215570	
	1,6 i 16V		05.1997	12.2002	24.5233-0180.3	330888	LATIGUILLO	96215570	
LEGANZA (97-02)	2,0 i 16V		06.1997	12.2002	24.0124-0723.1	424723	DISCO DE FRENO	96238673	
			07.2000	12.2002	24.0124-0723.1	424723	DISCO DE FRENO	96238673	
	2,2 i 16V		04.1999	12.2002	24.0124-0723.1	424723	DISCO DE FRENO	96238673	









					Denominación	Ref. OE correspondientes a las referencias ATE		Referencia anterior / varios
--	--	--	--	--	--------------	------------------------------------------------	--	------------------------------

FIAT

ALBEA (02-)	1,2 i		03.2002		13.0460-3849.2	603849	PASTILLAS DE FRENO	77363782	ver figura
	1,2 i 16V		03.2002		13.0460-3849.2	603849	PASTILLAS DE FRENO	77363782	ver figura
	1,3 JTD		03.2002		13.0460-3849.2	603849	PASTILLAS DE FRENO	77363782	ver figura
	1,4 i		03.2002		13.0460-3849.2	603849	PASTILLAS DE FRENO	77363782	ver figura
	1,6 i 16V		03.2002		13.0460-3849.2	603849	PASTILLAS DE FRENO	77363782	ver figura
DUCATO (06-)	2,2 JTD (Q11)		07.2006		24.0124-0208.1	424208	DISCO DE FRENO	4249 26 , 51728377 , 51740244 , 4249 27	
	2,2 JTD (Q15)		07.2006		24.0124-0208.1	424208	DISCO DE FRENO	4249 26 , 51728377 , 51740244 , 4249 27	
	2,2 JTD (Q17H)		07.2006		24.0116-0125.1	416125	DISCO DE FRENO	4249 39 , 51749275 , 51740248 , 4249 40	
			07.2006		24.0124-0209.1	424209	DISCO DE FRENO	4249 35 , 51728378 , 51740247 , 4249 36	
	2,3 JTD (Q11)		07.2006		24.0124-0208.1	424208	DISCO DE FRENO	4249 26 , 51728377 , 51740244 , 4249 27	
	2,3 JTD (Q15)		07.2006		24.0124-0208.1	424208	DISCO DE FRENO	4249 26 , 51728377 , 51740244 , 4249 27	
	2,3 JTD (Q17H)		07.2006		24.0124-0209.1	424209	DISCO DE FRENO	4249 35 , 51728378 , 51740247 , 4249 36	
			07.2006		24.0116-0125.1	416125	DISCO DE FRENO	4249 39 , 51749275 , 51740248 , 4249 40	
	3,0 JTD (Q11)		07.2006		24.0124-0208.1	424208	DISCO DE FRENO	4249 26 , 51728377 , 51740244 , 4249 27	
	3,0 JTD (Q15)		07.2006		24.0124-0208.1	424208	DISCO DE FRENO	4249 26 , 51728377 , 51740244 , 4249 27	



					Denominación	Ref. OE correspondientes a las referencias ATE	 Referencia anterior / varios
-----------------------------------------------------------------------------------	-----------------------------------------------------------------------------------	-----------------------------------------------------------------------------------	-------------------------------------------------------------------------------------	-------------------------------------------------------------------------------------	--------------	------------------------------------------------	------------------------------------------------------------------------------------------------------------------

FIAT

Modelo	Motor	Fecha 1	Fecha 2	Ref. ATE 1	Ref. ATE 2	Denominación	Ref. OE correspondientes a las referencias ATE
DUCATO (06-)	3,0 JTD (Q17H)	07.2006		24.0116-0125.1	416125	DISCO DE FRENO	4249 39 , 51749275 , 51740248 , 4249 40
		07.2006		24.0124-0209.1	424209	DISCO DE FRENO	4249 35 , 51728378 , 51740247 , 4249 36
GRANDE PUNTO (06-)	1,2 i	10.2006		24.0112-0184.1	412184	DISCO DE FRENO	93188916 , 55700918 , 55700398 , 5 69 022
IDEA (04-08)	1,2 i 16V	01.2004	02.2008	83.7201-9173.3	330868	LATIGUILLO	46834651
	1,3 JTD	01.2004	02.2008	83.7201-9173.3	330868	LATIGUILLO	46834651
		11.2005	02.2008	83.7201-9173.3	330868	LATIGUILLO	46834651
	1,4 i	11.2005	02.2008	83.7201-9173.3	330868	LATIGUILLO	46834651
	1,4 i 16V	01.2004	02.2008	83.7201-9173.3	330868	LATIGUILLO	46834651
	1,9 JTD	01.2004	02.2008	83.7201-9173.3	330868	LATIGUILLO	46834651
MULTIPLA (98-)	1,6 i 16V	02.1999		24.5112-0437.3	330886	LATIGUILLO	46556045 , 51700558
	1,9 JTD	02.1999		24.5112-0437.3	330886	LATIGUILLO	46556045 , 51700558
PANDA (03-)	1,1 i	09.2003		24.5112-0440.3	330887	LATIGUILLO	51718921
	1,2 bivalent CNG	01.2007		24.5112-0440.3	330887	LATIGUILLO	51718921
	1,2 i	09.2003		24.5112-0440.3	330887	LATIGUILLO	51718921
	1,3 JTD	06.2006		24.5112-0440.3	330887	LATIGUILLO	51718921
		09.2003		24.5112-0440.3	330887	LATIGUILLO	51718921
	1,4 i 16V	11.2006		24.5112-0440.3	330887	LATIGUILLO	51718921









					Denominación	Ref. OE correspondientes a las referencias ATE		Referencia anterior / varios
--	--	--	--	--	--------------	------------------------------------------------	--	------------------------------

FORD

C-MAX (07-)	1,6 i 16V		03.2007		24.3727-0659.2	580659	CABLE FRENO DE MANO	1323904 , 1319486 , 1355127 , 1416442 , 1490515	
	1,6 TDCi		03.2007		24.3727-0659.2	580659	CABLE FRENO DE MANO	1323904 , 1319486 , 1355127 , 1416442 , 1490515	
	1,8 i 16V		03.2007		24.3727-0659.2	580659	CABLE FRENO DE MANO	1323904 , 1319486 , 1355127 , 1416442 , 1490515	
	2,0 i 16V		03.2007		24.3727-0659.2	580659	CABLE FRENO DE MANO	1323904 , 1319486 , 1355127 , 1416442 , 1490515	
	2,0 TDCi		02.2008		24.3727-0659.2	580659	CABLE FRENO DE MANO	1323904 , 1319486 , 1355127 , 1416442 , 1490515	
			03.2007		24.3727-0659.2	580659	CABLE FRENO DE MANO	1323904 , 1319486 , 1355127 , 1416442 , 1490515	
FOCUS C-MAX (03-07)	1,6 i 16V		08.2003	03.2007	24.3727-0659.2	580659	CABLE FRENO DE MANO	1323904 , 1319486 , 1355127 , 1416442 , 1490515	
	1,6 TDCi		01.2005	03.2007	24.3727-0659.2	580659	CABLE FRENO DE MANO	1323904 , 1319486 , 1355127 , 1416442 , 1490515	
			08.2003	03.2007	24.3727-0659.2	580659	CABLE FRENO DE MANO	1323904 , 1319486 , 1355127 , 1416442 , 1490515	
	1,6 Ti VCT		08.2004	03.2007	24.3727-0659.2	580659	CABLE FRENO DE MANO	1323904 , 1319486 , 1355127 , 1416442 , 1490515	
	1,8 i 16V		08.2003	03.2007	24.3727-0659.2	580659	CABLE FRENO DE MANO	1323904 , 1319486 , 1355127 , 1416442 , 1490515	
			04.2004	03.2007	24.3727-0659.2	580659	CABLE FRENO DE MANO	1323904 , 1319486 , 1355127 , 1416442 , 1490515	
	1,8 TDCi		01.2005	03.2007	24.3727-0659.2	580659	CABLE FRENO DE MANO	1323904 , 1319486 , 1355127 , 1416442 , 1490515	



					Denominación	Ref. OE correspondientes a las referencias ATE	 Referencia anterior / varios
-----------------------------------------------------------------------------------	-----------------------------------------------------------------------------------	-----------------------------------------------------------------------------------	-------------------------------------------------------------------------------------	-------------------------------------------------------------------------------------	---------------------	-------------------------------------------------------	----------------------------------------------------------------------------------------------------------------------------

FORD

FOCUS C-MAX (03-07)	2,0 i 16V		04.2004	03.2007	24.3727-0659.2	580659	CABLE FRENO DE MANO	1323904 , 1319486 , 1355127 , 1416442 , 1490515	
	2,0 TDCi		08.2003	03.2007	24.3727-0659.2	580659	CABLE FRENO DE MANO	1323904 , 1319486 , 1355127 , 1416442 , 1490515	
FOCUS II (05-)	1,4 i 16V		10.2004		24.3727-0659.2	580659	CABLE FRENO DE MANO	1323904 , 1319486 , 1355127 , 1416442 , 1490515	
	1,6 i 16V		10.2004		24.3727-0659.2	580659	CABLE FRENO DE MANO	1323904 , 1319486 , 1355127 , 1416442 , 1490515	
	1,6 TDCi		01.2005		24.3727-0659.2	580659	CABLE FRENO DE MANO	1323904 , 1319486 , 1355127 , 1416442 , 1490515	
			10.2004		24.3727-0659.2	580659	CABLE FRENO DE MANO	1323904 , 1319486 , 1355127 , 1416442 , 1490515	
	1,6 Ti VCT		10.2004		24.3727-0659.2	580659	CABLE FRENO DE MANO	1323904 , 1319486 , 1355127 , 1416442 , 1490515	
	1,8 i 16V		01.2006		24.3727-0659.2	580659	CABLE FRENO DE MANO	1323904 , 1319486 , 1355127 , 1416442 , 1490515	
	1,8 TDCi		01.2005		24.3727-0659.2	580659	CABLE FRENO DE MANO	1323904 , 1319486 , 1355127 , 1416442 , 1490515	
	2,0 i 16V		10.2004		24.3727-0659.2	580659	CABLE FRENO DE MANO	1323904 , 1319486 , 1355127 , 1416442 , 1490515	
	2,0 TDCi		10.2004		24.3727-0659.2	580659	CABLE FRENO DE MANO	1323904 , 1319486 , 1355127 , 1416442 , 1490515	
	2,5 ST		10.2005		24.3727-0659.2	580659	CABLE FRENO DE MANO	1323904 , 1319486 , 1355127 , 1416442 , 1490515	



	i				Denominación	Ref. OE correspondientes a las referencias ATE	i Referencia anterior / varios
--	----------	--	--	--	---------------------	-------------------------------------------------------	------------------------------------------

HONDA

CR-V III (07-)	2,0 VTEC		01.2007		13.0460-5753.2	605753	PASTILLAS DE FRENO	45022-SWW-G01	ver figura
			01.2007		13.0460-5754.2	605754	PASTILLAS DE FRENO	43022-SWW-G01	ver figura
	2,2 CTDi		01.2007		13.0460-5754.2	605754	PASTILLAS DE FRENO	43022-SWW-G01	ver figura
			01.2007		13.0460-5753.2	605753	PASTILLAS DE FRENO	45022-SWW-G01	ver figura
S2000 (99-04)	2,0 VTEC (AP1)		06.1999	09.2004	24.0112-0707.1	412707	DISCO DE FRENO	42510-S2A-000	

Nuevas referencias en almacén - Por aplicación

09/2008









				Denominación	Ref. OE correspondientes a las referencias ATE		Referencia anterior / varios
--	--	--	--	--------------	------------------------------------------------	--	------------------------------

HYUNDAI

SANTA FE (01-06)	2,0 CRDi	TD	11.2003	02.2006	24.3727-3108.2	583108	CABLE FRENO DE MANO	59913-26150	
		TD	08.2001	07.2003	24.3727-3108.2	583108	CABLE FRENO DE MANO	59913-26150	
		TI	08.2001	07.2003	24.3727-3109.2	583109	CABLE FRENO DE MANO	59912-26150	
		TI	11.2003	02.2006	24.3727-3109.2	583109	CABLE FRENO DE MANO	59912-26150	
		TI	08.2003	02.2006	24.3727-3109.2	583109	CABLE FRENO DE MANO	59912-26150	
		TD	08.2003	02.2006	24.3727-3108.2	583108	CABLE FRENO DE MANO	59913-26150	
	2,0 CRDi 4x4	TI	08.2003	02.2006	24.3727-3109.2	583109	CABLE FRENO DE MANO	59912-26150	
		TI	11.2003	02.2006	24.3727-3109.2	583109	CABLE FRENO DE MANO	59912-26150	
		TI	04.2001	07.2003	24.3727-3109.2	583109	CABLE FRENO DE MANO	59912-26150	
		TD	04.2001	07.2003	24.3727-3108.2	583108	CABLE FRENO DE MANO	59913-26150	
		TD	11.2003	02.2006	24.3727-3108.2	583108	CABLE FRENO DE MANO	59913-26150	
		TD	08.2003	02.2006	24.3727-3108.2	583108	CABLE FRENO DE MANO	59913-26150	
	2,0 i 16V	TI	02.2001	02.2006	24.3727-3109.2	583109	CABLE FRENO DE MANO	59912-26150	
		TD	02.2001	02.2006	24.3727-3108.2	583108	CABLE FRENO DE MANO	59913-26150	
	2,4 i 16V	TD	02.2001	02.2006	24.3727-3108.2	583108	CABLE FRENO DE MANO	59913-26150	
		TI	02.2001	02.2006	24.3727-3109.2	583109	CABLE FRENO DE MANO	59912-26150	
	2,4 i 16V 4x4	TI	02.2001	02.2006	24.3727-3109.2	583109	CABLE FRENO DE MANO	59912-26150	
		TD	02.2001	02.2006	24.3727-3108.2	583108	CABLE FRENO DE MANO	59913-26150	
	2,7 i V6 4x4	TI	02.2001	02.2006	24.3727-3109.2	583109	CABLE FRENO DE MANO	59912-26150	



					Denominación	Ref. OE correspondientes a las referencias ATE		Referencia anterior / varios
-----------------------------------------------------------------------------------	-----------------------------------------------------------------------------------	-----------------------------------------------------------------------------------	-------------------------------------------------------------------------------------	-------------------------------------------------------------------------------------	--------------	------------------------------------------------	-------------------------------------------------------------------------------------	------------------------------

HYUNDAI

SANTA FE (01-06)	2,7 i V6 4x4	TD	02.2001	02.2006	24.3727-3108.2	583108	CABLE FRENO DE MANO	59913-26150	
------------------	--------------	----	---------	---------	----------------	--------	---------------------	-------------	--

INFINITI

FX35/FX45 (S50) (06-)	3,5 V6 4WD		07.2006		24.0116-0122.1	416122	DISCO DE FRENO	43206-CA000	
	4,5 V8 4WD		07.2006		24.0116-0122.1	416122	DISCO DE FRENO	43206-CA000	

Nuevas referencias en almacén - Por aplicación

09/2008



					Denominación	Ref. OE correspondientes a las referencias ATE		Referencia anterior / varios
--	--	--	--	--	--------------	------------------------------------------------	--	------------------------------

JEEP

CHEROKEE (KJ) (01-)	2,4		09.2001		24.0128-0708.1	428708	DISCO DE FRENO	5212 8247AA	
	2,5 CRD		09.2001		24.0128-0708.1	428708	DISCO DE FRENO	5212 8247AA	
	2,8 CRD		11.2002		24.0128-0708.1	428708	DISCO DE FRENO	5212 8247AA	
	3,7 V6		09.2001		24.0128-0708.1	428708	DISCO DE FRENO	5212 8247AA	
CHEROKEE(XJ)/WAGON.(XJ)/COMANCHE(MJ) (87-)	2,1 TD 4x4		01.1990	12.1990	24.0124-0702.1	424702	DISCO DE FRENO	5015 965AA , 5200 5000	
	2,5 i 4x4		01.1990	12.1990	24.0124-0702.1	424702	DISCO DE FRENO	5015 965AA , 5200 5000	
	2,5 TD 4x4		01.1990	12.1990	24.0124-0702.1	424702	DISCO DE FRENO	5015 965AA , 5200 5000	
	4,0 i 4x4		01.1990	12.1990	24.0124-0702.1	424702	DISCO DE FRENO	5015 965AA , 5200 5000	
WRANGLER I (YJ) (87-96)	2,5		01.1990	12.1993	24.0124-0702.1	424702	DISCO DE FRENO	5015 965AA , 5200 5000	
	4		01.1990	12.1993	24.0124-0702.1	424702	DISCO DE FRENO	5015 965AA , 5200 5000	
WRANGLER II (TJ) (96-)	2,4		11.2002		24.0124-0702.1	424702	DISCO DE FRENO	5015 965AA , 5200 5000	
	2,5		08.1996		24.0124-0702.1	424702	DISCO DE FRENO	5015 965AA , 5200 5000	
	4		06.1998		24.0124-0702.1	424702	DISCO DE FRENO	5015 965AA , 5200 5000	
			08.1996		24.0124-0702.1	424702	DISCO DE FRENO	5015 965AA , 5200 5000	
	4,0 Rubicon		08.2003		24.0124-0702.1	424702	DISCO DE FRENO	5015 965AA , 5200 5000	



	i			Denominación	Ref. OE correspondientes a las referencias ATE	i Referencia anterior / varios
--	----------	--	--	--------------	------------------------------------------------	------------------------------------------

KIA

RIO I (00-05)	1,3 i	TD	08.2000	02.2005	24.3727-3201.2	583201	CABLE FRENO DE MANO	OK30A-44-410H	
		TI	08.2000	02.2005	24.3727-3200.2	583200	CABLE FRENO DE MANO	OK30A-44-420H	
	1,5 i 16V	TI	09.2002	02.2005	24.3727-3200.2	583200	CABLE FRENO DE MANO	OK30A-44-420H	
		TI	08.2000	02.2005	24.3727-3200.2	583200	CABLE FRENO DE MANO	OK30A-44-420H	
		TD	08.2000	02.2005	24.3727-3201.2	583201	CABLE FRENO DE MANO	OK30A-44-410H	
		TD	09.2002	02.2005	24.3727-3201.2	583201	CABLE FRENO DE MANO	OK30A-44-410H	
SORENTO (02-)	2,4 i 16V		08.2002	11.2006	24.0120-0202.1	420202	DISCO DE FRENO	58411-3E300	
	2,5 CRDi		08.2002	11.2006	24.0120-0202.1	420202	DISCO DE FRENO	58411-3E300	
	3,5 i V6		08.2002		24.0120-0202.1	420202	DISCO DE FRENO	58411-3E300	



					Denominación	Ref. OE correspondientes a las referencias ATE		Referencia anterior / varios
--	--	--	--	--	--------------	------------------------------------------------	--	------------------------------







LANCIA

MUSA (04-)	1,3 JTD		10.2004		83.7201-9173.3	330868	LATIGUILLO	46834651	
			09.2006		83.7201-9173.3	330868	LATIGUILLO	46834651	
	1,4 i		07.2005		83.7201-9173.3	330868	LATIGUILLO	46834651	
	1,4 i 16V		10.2004		83.7201-9173.3	330868	LATIGUILLO	46834651	
	1,6 JTD		06.2008		83.7201-9173.3	330868	LATIGUILLO	46834651	
	1,9 JTD		10.2004		83.7201-9173.3	330868	LATIGUILLO	46834651	
YPSILON (03-)	1,2 i		06.2003		03.0520-7019.3	697019	ATE TOPKIT		
	1,2 i 16V		06.2003		03.0520-9320.3	699320	ATE TOPKIT		
	1,3 JTD		06.2003		03.0520-9320.3	699320	ATE TOPKIT		
			10.2006		03.0520-9320.3	699320	ATE TOPKIT		
	1,4 i		02.2006		03.0520-7019.3	697019	ATE TOPKIT		
	1,4 i 16V		06.2003		03.0520-9320.3	699320	ATE TOPKIT		

LAND ROVER

DISCOVERY III (04-)	4,4		10.2004		24.0120-0201.1	420201	DISCO DE FRENO	SDB000644 , SDB000645 , SDB000646	
RANGE ROVER SPORT (05-)	3,6 TD V8		04.2006		24.0120-0201.1	420201	DISCO DE FRENO	SDB000644 , SDB000645 , SDB000646	
	4,2 V8 Kompressor		02.2005		24.0120-0201.1	420201	DISCO DE FRENO	SDB000644 , SDB000645 , SDB000646	
	4,4 V8		02.2005		24.0120-0201.1	420201	DISCO DE FRENO	SDB000644 , SDB000645 , SDB000646	



					Denominación	Ref. OE correspondientes a las referencias ATE	 Referencia anterior / varios
-----------------------------------------------------------------------------------	-----------------------------------------------------------------------------------	-----------------------------------------------------------------------------------	-------------------------------------------------------------------------------------	-------------------------------------------------------------------------------------	---------------------	-------------------------------------------------------	-------------------------------------------------------------------------------------------------------------------------

MAZDA

5 (05-)	1,8 i 16V	TD	03.2005		24.3727-1820.2	581820	CABLE FRENO DE MANO	C236-44-410C , C236-44-410D , C236-44-410E	
	2,0 CITD	TD	03.2005		24.3727-1820.2	581820	CABLE FRENO DE MANO	C236-44-410C , C236-44-410D , C236-44-410E	
		TD	06.2005		24.3727-1820.2	581820	CABLE FRENO DE MANO	C236-44-410C , C236-44-410D , C236-44-410E	
	2,0 i 16V	TD	03.2005		24.3727-1820.2	581820	CABLE FRENO DE MANO	C236-44-410C , C236-44-410D , C236-44-410E	
PREMACY (05-)	1,8 i 16V	TD	03.2005		24.3727-1820.2	581820	CABLE FRENO DE MANO	C236-44-410C , C236-44-410D , C236-44-410E	
	2,0 CITD	TD	06.2005		24.3727-1820.2	581820	CABLE FRENO DE MANO	C236-44-410C , C236-44-410D , C236-44-410E	
		TD	03.2005		24.3727-1820.2	581820	CABLE FRENO DE MANO	C236-44-410C , C236-44-410D , C236-44-410E	
	2,0 i 16V	TD	03.2005		24.3727-1820.2	581820	CABLE FRENO DE MANO	C236-44-410C , C236-44-410D , C236-44-410E	

Nuevas referencias en almacén - Por aplicación

09/2008



					Denominación	Ref. OE correspondientes a las referencias ATE		Referencia anterior / varios
--	--	--	--	--	--------------	------------------------------------------------	--	------------------------------







MERCEDES BENZ

Clase	Modelo	Config	Fecha	Ref. ATE	Ref. OE	Denominación	Ref. OE correspondientes a las referencias ATE	Referencia anterior / varios
Clase A (W169) (04-)	A 150	TD	08.2004	24.3727-0451.2	580451	CABLE FRENO DE MANO	169 420 12 85	
		TI	08.2004	24.3727-0452.2	580452	CABLE FRENO DE MANO	169 420 11 85	
	A 160 CDI	TI	08.2004	24.3727-0452.2	580452	CABLE FRENO DE MANO	169 420 11 85	
		TD	08.2004	24.3727-0451.2	580451	CABLE FRENO DE MANO	169 420 12 85	
	A 170	TD	08.2004	24.3727-0451.2	580451	CABLE FRENO DE MANO	169 420 12 85	
		TI	08.2004	24.3727-0452.2	580452	CABLE FRENO DE MANO	169 420 11 85	
	A 180 CDI	TD	08.2004	24.3727-0451.2	580451	CABLE FRENO DE MANO	169 420 12 85	
		TI	08.2004	24.3727-0452.2	580452	CABLE FRENO DE MANO	169 420 11 85	
	A 200	TD	08.2004	24.3727-0451.2	580451	CABLE FRENO DE MANO	169 420 12 85	
		TI	08.2004	24.3727-0452.2	580452	CABLE FRENO DE MANO	169 420 11 85	
	A 200 CDI	TD	08.2004	24.3727-0451.2	580451	CABLE FRENO DE MANO	169 420 12 85	
		TI	08.2004	24.3727-0452.2	580452	CABLE FRENO DE MANO	169 420 11 85	
Clase B (W245) (05-)	A 200 Turbo	TI	03.2005	24.3727-0452.2	580452	CABLE FRENO DE MANO	169 420 11 85	
		TD	03.2005	24.3727-0451.2	580451	CABLE FRENO DE MANO	169 420 12 85	
	B 150	TD	04.2005	24.3727-0451.2	580451	CABLE FRENO DE MANO	169 420 12 85	
		TI	04.2005	24.3727-0452.2	580452	CABLE FRENO DE MANO	169 420 11 85	
	B 170	TD	04.2005	24.3727-0451.2	580451	CABLE FRENO DE MANO	169 420 12 85	
		TI	04.2005	24.3727-0452.2	580452	CABLE FRENO DE MANO	169 420 11 85	
	B 180 CDI	TI	04.2005	24.3727-0452.2	580452	CABLE FRENO DE MANO	169 420 11 85	

Nuevas referencias en almacén - Por aplicación

09/2008



					Denominación	Ref. OE correspondientes a las referencias ATE		Referencia anterior / varios
-----------------------------------------------------------------------------------	-----------------------------------------------------------------------------------	-----------------------------------------------------------------------------------	-------------------------------------------------------------------------------------	-------------------------------------------------------------------------------------	--------------	------------------------------------------------	-------------------------------------------------------------------------------------	------------------------------

MERCEDES BENZ

Clase B (W245) (05-)	B 180 CDI	TD	04.2005		24.3727-0451.2	580451	CABLE FRENO DE MANO	169 420 12 85	
	B 200	TI	04.2005		24.3727-0452.2	580452	CABLE FRENO DE MANO	169 420 11 85	
		TD	04.2005		24.3727-0451.2	580451	CABLE FRENO DE MANO	169 420 12 85	
	B 200 CDI	TI	04.2005		24.3727-0452.2	580452	CABLE FRENO DE MANO	169 420 11 85	
		TD	04.2005		24.3727-0451.2	580451	CABLE FRENO DE MANO	169 420 12 85	
	B 200 Turbo	TD	04.2005		24.3727-0451.2	580451	CABLE FRENO DE MANO	169 420 12 85	
		TI	04.2005		24.3727-0452.2	580452	CABLE FRENO DE MANO	169 420 11 85	
Clase C (CL203) Sportcoupé (01-08)	C 160 Kompressor	DD	04.2005	05.2008	24.3571-1740.7	220668	PINZA DE GARRA	001 420 95 83 , 003 420 22 83	
		DI	04.2005	05.2008	24.3571-1739.7	220667	PINZA DE GARRA	001 420 94 83 , 003 420 21 83	
	C 180	DD	03.2001	05.2008	24.3571-1740.7	220668	PINZA DE GARRA	001 420 95 83 , 003 420 22 83	
		DI	03.2001	05.2008	24.3571-1739.7	220667	PINZA DE GARRA	001 420 94 83 , 003 420 21 83	
	C 180 Kompressor	DI	05.2002	05.2008	24.3571-1739.7	220667	PINZA DE GARRA	001 420 94 83 , 003 420 21 83	
		DD	05.2002	05.2008	24.3571-1740.7	220668	PINZA DE GARRA	001 420 95 83 , 003 420 22 83	
	C 200 CDI	DI	07.2003	05.2008	24.3571-1739.7	220667	PINZA DE GARRA	001 420 94 83 , 003 420 21 83	
		DD	07.2003	05.2008	24.3571-1740.7	220668	PINZA DE GARRA	001 420 95 83 , 003 420 22 83	



					Denominación	Ref. OE correspondientes a las referencias ATE		Referencia anterior / varios
--	--	--	--	--	--------------	------------------------------------------------	--	------------------------------







MERCEDES BENZ

Clase C (CL203) Sportcoupé (01-08)	C 200 CGI Kompressor	DI	07.2003	05.2008	24.3571-1739.7	220667	PINZA DE GARRA	001 420 94 83 , 003 420 21 83	
		DD	07.2003	05.2008	24.3571-1740.7	220668	PINZA DE GARRA	001 420 95 83 , 003 420 22 83	
	C 200 Kompressor	DI	03.2001	05.2008	24.3571-1739.7	220667	PINZA DE GARRA	001 420 94 83 , 003 420 21 83	
		DD	03.2001	05.2008	24.3571-1740.7	220668	PINZA DE GARRA	001 420 95 83 , 003 420 22 83	
	C 220 CDI	DD	03.2001	05.2008	24.3571-1740.7	220668	PINZA DE GARRA	001 420 95 83 , 003 420 22 83	
		DI	03.2001	05.2008	24.3571-1739.7	220667	PINZA DE GARRA	001 420 94 83 , 003 420 21 83	
	C 230 Kompressor	DI	03.2001	05.2008	24.3571-1739.7	220667	PINZA DE GARRA	001 420 94 83 , 003 420 21 83	
		DD	03.2001	05.2008	24.3571-1740.7	220668	PINZA DE GARRA	001 420 95 83 , 003 420 22 83	
Clase C (CLC204) Coupé (08-)	CLC 180 Kompressor	DD	05.2008		24.3571-1740.7	220668	PINZA DE GARRA	001 420 95 83 , 003 420 22 83	
		DI	05.2008		24.3571-1739.7	220667	PINZA DE GARRA	001 420 94 83 , 003 420 21 83	
	CLC 200 CDI	DI	05.2008		24.3571-1739.7	220667	PINZA DE GARRA	001 420 94 83 , 003 420 21 83	
		DD	05.2008		24.3571-1740.7	220668	PINZA DE GARRA	001 420 95 83 , 003 420 22 83	
	CLC 200 Kompressor	DI	05.2008		24.3571-1739.7	220667	PINZA DE GARRA	001 420 94 83 , 003 420 21 83	

Nuevas referencias en almacén - Por aplicación

09/2008



					Denominación	Ref. OE correspondientes a las referencias ATE	 Referencia anterior / varios
-----------------------------------------------------------------------------------	-----------------------------------------------------------------------------------	-----------------------------------------------------------------------------------	-------------------------------------------------------------------------------------	-------------------------------------------------------------------------------------	--------------	------------------------------------------------	---------------------------------------------------------------------------------------------------------------------







MERCEDES BENZ

Clase C (CLC204) Coupé (08-)	CLC 200 Kompressor	DD	05.2008		24.3571-1740.7	220668	PINZA DE GARRA	001 420 95 83 , 003 420 22 83	
	CLC 220 CDI	DD	05.2008		24.3571-1740.7	220668	PINZA DE GARRA	001 420 95 83 , 003 420 22 83	
		DI	05.2008		24.3571-1739.7	220667	PINZA DE GARRA	001 420 94 83 , 003 420 21 83	
Clase C (S203) Break (01-07)	C 180	DD	03.2001	09.2007	24.3571-1740.7	220668	PINZA DE GARRA	001 420 95 83 , 003 420 22 83	
		DI	03.2001	09.2007	24.3571-1739.7	220667	PINZA DE GARRA	001 420 94 83 , 003 420 21 83	
	C 180 Kompressor	DD	05.2002	09.2007	24.3571-1740.7	220668	PINZA DE GARRA	001 420 95 83 , 003 420 22 83	
		DI	05.2002	09.2007	24.3571-1739.7	220667	PINZA DE GARRA	001 420 94 83 , 003 420 21 83	
	C 200 CDI	DD	03.2001	09.2007	24.3571-1740.7	220668	PINZA DE GARRA	001 420 95 83 , 003 420 22 83	
		DI	03.2001	09.2007	24.3571-1739.7	220667	PINZA DE GARRA	001 420 94 83 , 003 420 21 83	
	C 200 CGI Kompressor	DD	07.2003	09.2007	24.3571-1740.7	220668	PINZA DE GARRA	001 420 95 83 , 003 420 22 83	
		DI	07.2003	09.2007	24.3571-1739.7	220667	PINZA DE GARRA	001 420 94 83 , 003 420 21 83	
	C 200 Kompressor	DI	03.2001	09.2007	24.3571-1739.7	220667	PINZA DE GARRA	001 420 94 83 , 003 420 21 83	
		DD	03.2001	09.2007	24.3571-1740.7	220668	PINZA DE GARRA	001 420 95 83 , 003 420 22 83	

Nuevas referencias en almacén - Por aplicación

09/2008



					Denominación	Ref. OE correspondientes a las referencias ATE	 Referencia anterior / varios
-----------------------------------------------------------------------------------	-----------------------------------------------------------------------------------	-----------------------------------------------------------------------------------	-------------------------------------------------------------------------------------	-------------------------------------------------------------------------------------	--------------	------------------------------------------------	------------------------------------------------------------------------------------------------------------------

MERCEDES BENZ

Clase C (S203) Break (01-07)	C 220 CDI	DD	03.2001	09.2007	24.3571-1740.7	220668	PINZA DE GARRA	001 420 95 83 , 003 420 22 83	
		DI	03.2001	09.2007	24.3571-1739.7	220667	PINZA DE GARRA	001 420 94 83 , 003 420 21 83	
	C 320 CDI	DI	02.2005	09.2007	24.3571-1739.7	220667	PINZA DE GARRA	001 420 94 83 , 003 420 21 83	
		DD	02.2005	09.2007	24.3571-1740.7	220668	PINZA DE GARRA	001 420 95 83 , 003 420 22 83	
Clase C (W203) Berlina (00-07)	C 180	DI	04.2000	04.2007	24.3571-1739.7	220667	PINZA DE GARRA	001 420 94 83 , 003 420 21 83	
		DD	04.2000	04.2007	24.3571-1740.7	220668	PINZA DE GARRA	001 420 95 83 , 003 420 22 83	
	C 180 Kompressor	DI	05.2002	04.2007	24.3571-1739.7	220667	PINZA DE GARRA	001 420 94 83 , 003 420 21 83	
		DD	05.2002	04.2007	24.3571-1740.7	220668	PINZA DE GARRA	001 420 95 83 , 003 420 22 83	
	C 200 CDI	DI	04.2000	04.2007	24.3571-1739.7	220667	PINZA DE GARRA	001 420 94 83 , 003 420 21 83	
		DD	04.2000	04.2007	24.3571-1740.7	220668	PINZA DE GARRA	001 420 95 83 , 003 420 22 83	
	C 200 CGI Kompressor	DI	07.2003	04.2007	24.3571-1739.7	220667	PINZA DE GARRA	001 420 94 83 , 003 420 21 83	
		DD	07.2003	04.2007	24.3571-1740.7	220668	PINZA DE GARRA	001 420 95 83 , 003 420 22 83	
	C 200 Kompressor	DD	04.2000	04.2007	24.3571-1740.7	220668	PINZA DE GARRA	001 420 95 83 , 003 420 22 83	

Nuevas referencias en almacén - Por aplicación

09/2008









					Denominación	Ref. OE correspondientes a las referencias ATE		Referencia anterior / varios
--	--	--	--	--	--------------	------------------------------------------------	--	------------------------------

MERCEDES BENZ

Clase C (W203) Berlina (00-07)	C 200 Kompressor	DI	04.2000	04.2007	24.3571-1739.7	220667	PINZA DE GARRA	001 420 94 83 , 003 420 21 83	
	C 220 CDI	DD	04.2000	04.2007	24.3571-1740.7	220668	PINZA DE GARRA	001 420 95 83 , 003 420 22 83	
		DI	04.2000	04.2007	24.3571-1739.7	220667	PINZA DE GARRA	001 420 94 83 , 003 420 21 83	
	C 230 Kompressor	DI	02.2004	04.2007	24.3571-1739.7	220667	PINZA DE GARRA	001 420 94 83 , 003 420 21 83	
		DD	02.2004	04.2007	24.3571-1740.7	220668	PINZA DE GARRA	001 420 95 83 , 003 420 22 83	
	C 320 CDI	DI	02.2005	04.2007	24.3571-1739.7	220667	PINZA DE GARRA	001 420 94 83 , 003 420 21 83	
		DD	02.2005	04.2007	24.3571-1740.7	220668	PINZA DE GARRA	001 420 95 83 , 003 420 22 83	
Clase CLK (A209) Cabrióle (03-)	CLK 200 CGI	DD	05.2003		24.3571-1740.7	220668	PINZA DE GARRA	001 420 95 83 , 003 420 22 83	
		DI	05.2003		24.3571-1739.7	220667	PINZA DE GARRA	001 420 94 83 , 003 420 21 83	
	CLK 200 Kompressor	DD	05.2003		24.3571-1740.7	220668	PINZA DE GARRA	001 420 95 83 , 003 420 22 83	
		DI	05.2003		24.3571-1739.7	220667	PINZA DE GARRA	001 420 94 83 , 003 420 21 83	
Clase CLK (C209) Coupé (02-)	CLK 200 CGI	DI	09.2002		24.3571-1739.7	220667	PINZA DE GARRA	001 420 94 83 , 003 420 21 83	
		DD	09.2002		24.3571-1740.7	220668	PINZA DE GARRA	001 420 95 83 , 003 420 22 83	









					Denominación	Ref. OE correspondientes a las referencias ATE	 Referencia anterior / varios
-----------------------------------------------------------------------------------	-----------------------------------------------------------------------------------	-----------------------------------------------------------------------------------	-------------------------------------------------------------------------------------	-------------------------------------------------------------------------------------	---------------------	-------------------------------------------------------	----------------------------------------------------------------------------------------------------------------------------

MERCEDES BENZ

Clase CLK (C209) Coupé (02-)	CLK 200 Kompressor	DI	09.2002		24.3571-1739.7	220667	PINZA DE GARRA	001 420 94 83 , 003 420 21 83	
		DD	09.2002		24.3571-1740.7	220668	PINZA DE GARRA	001 420 95 83 , 003 420 22 83	
	CLK 220 CDI	DD	05.2005		24.3571-1740.7	220668	PINZA DE GARRA	001 420 95 83 , 003 420 22 83	
		DI	05.2005		24.3571-1739.7	220667	PINZA DE GARRA	001 420 94 83 , 003 420 21 83	
Clase CLS (C219) Coupé (04-)	CLS 280	TI	10.2007		24.3727-0449.2	580449	CABLE FRENO DE MANO	211 420 02 85 , 211 420 23 85	
	CLS 320 CDI	TI	05.2005		24.3727-0449.2	580449	CABLE FRENO DE MANO	211 420 02 85 , 211 420 23 85	
	CLS 350	TI	08.2004		24.3727-0449.2	580449	CABLE FRENO DE MANO	211 420 02 85 , 211 420 23 85	
	CLS 350 CGI	TI	04.2006		24.3727-0449.2	580449	CABLE FRENO DE MANO	211 420 02 85 , 211 420 23 85	
	CLS 500	TI	04.2006		24.3727-0449.2	580449	CABLE FRENO DE MANO	211 420 02 85 , 211 420 23 85	
		TI	08.2004		24.3727-0449.2	580449	CABLE FRENO DE MANO	211 420 02 85 , 211 420 23 85	
	CLS 55 AMG		01.2005		24.0126-0136.1	426136	DISCO DE FRENO	211 423 10 12	
		TI	01.2005		24.3727-0449.2	580449	CABLE FRENO DE MANO	211 420 02 85 , 211 420 23 85	
	CLS 63 AMG		04.2006		24.0126-0136.1	426136	DISCO DE FRENO	211 423 10 12	
		TI	04.2006		24.3727-0449.2	580449	CABLE FRENO DE MANO	211 420 02 85 , 211 420 23 85	



					Denominación	Ref. OE correspondientes a las referencias ATE	 Referencia anterior / varios
-----------------------------------------------------------------------------------	-----------------------------------------------------------------------------------	-----------------------------------------------------------------------------------	-------------------------------------------------------------------------------------	-------------------------------------------------------------------------------------	---------------------	-------------------------------------------------------	----------------------------------------------------------------------------------------------------------------------------

MERCEDES BENZ

Clase E (S211) Break (03-)	E 200 Kompressor	TI	03.2003		24.3727-0449.2	580449	CABLE FRENO DE MANO	211 420 02 85 , 211 420 23 85	
	E 220 CDI	TI	03.2003		24.3727-0449.2	580449	CABLE FRENO DE MANO	211 420 02 85 , 211 420 23 85	
	E 240	TI	03.2003		24.3727-0449.2	580449	CABLE FRENO DE MANO	211 420 02 85 , 211 420 23 85	
	E 240 4-Matic	TI	07.2003		24.3727-0449.2	580449	CABLE FRENO DE MANO	211 420 02 85 , 211 420 23 85	
	E 270 CDI	TI	03.2003		24.3727-0449.2	580449	CABLE FRENO DE MANO	211 420 02 85 , 211 420 23 85	
	E 280	TI	05.2005		24.3727-0449.2	580449	CABLE FRENO DE MANO	211 420 02 85 , 211 420 23 85	
	E 280 4-Matic	TI	05.2005		24.3727-0449.2	580449	CABLE FRENO DE MANO	211 420 02 85 , 211 420 23 85	
	E 280 CDI	TI	05.2004		24.3727-0449.2	580449	CABLE FRENO DE MANO	211 420 02 85 , 211 420 23 85	
	E 280 CDI 4-Matic	TI	05.2005		24.3727-0449.2	580449	CABLE FRENO DE MANO	211 420 02 85 , 211 420 23 85	
	E 320	TI	03.2003		24.3727-0449.2	580449	CABLE FRENO DE MANO	211 420 02 85 , 211 420 23 85	
	E 320 4-Matic	TI	07.2003		24.3727-0449.2	580449	CABLE FRENO DE MANO	211 420 02 85 , 211 420 23 85	
	E 320 CDI	TI	03.2003		24.3727-0449.2	580449	CABLE FRENO DE MANO	211 420 02 85 , 211 420 23 85	
	E 320 CDI 4-Matic	TI	05.2005		24.3727-0449.2	580449	CABLE FRENO DE MANO	211 420 02 85 , 211 420 23 85	



					Denominación	Ref. OE correspondientes a las referencias ATE	Referencia anterior / varios
--	--	--	--	--	--------------	------------------------------------------------	------------------------------

MERCEDES BENZ

Clase E (S211) Break (03-)	E 350	TI	12.2004		24.3727-0449.2	580449	CABLE FRENO DE MANO	211 420 02 85 , 211 420 23 85	
	E 350 4-Matic	TI	12.2004		24.3727-0449.2	580449	CABLE FRENO DE MANO	211 420 02 85 , 211 420 23 85	
	E 500	TI	10.2003		24.3727-0449.2	580449	CABLE FRENO DE MANO	211 420 02 85 , 211 420 23 85	
	E 500 4-Matic	TI	10.2003		24.3727-0449.2	580449	CABLE FRENO DE MANO	211 420 02 85 , 211 420 23 85	
	E 55 Kompressor AMG		07.2003		24.0126-0136.1	426136	DISCO DE FRENO	211 423 10 12	
		TI	07.2003		24.3727-0449.2	580449	CABLE FRENO DE MANO	211 420 02 85 , 211 420 23 85	
	E 63 AMG		03.2006		24.0126-0136.1	426136	DISCO DE FRENO	211 423 10 12	
		TI	03.2006		24.3727-0449.2	580449	CABLE FRENO DE MANO	211 420 02 85 , 211 420 23 85	
Clase E (W211) Berlina (02-)	E 200 CDI	TI	05.2002		24.3727-0449.2	580449	CABLE FRENO DE MANO	211 420 02 85 , 211 420 23 85	
	E 200 Kompressor	TI	05.2002		24.3727-0449.2	580449	CABLE FRENO DE MANO	211 420 02 85 , 211 420 23 85	
	E 220 CDI	TI	03.2002		24.3727-0449.2	580449	CABLE FRENO DE MANO	211 420 02 85 , 211 420 23 85	
	E 230	TI	04.2006		24.3727-0449.2	580449	CABLE FRENO DE MANO	211 420 02 85 , 211 420 23 85	
	E 240	TI	03.2002		24.3727-0449.2	580449	CABLE FRENO DE MANO	211 420 02 85 , 211 420 23 85	
	E 240 4-Matic	TI	03.2003		24.3727-0449.2	580449	CABLE FRENO DE MANO	211 420 02 85 , 211 420 23 85	



					Denominación	Ref. OE correspondientes a las referencias ATE		Referencia anterior / varios
--	--	--	--	--	--------------	------------------------------------------------	--	------------------------------

MERCEDES BENZ

Clase E (W211) Berlina (02-)	E 270 CDI	TI	03.2002		24.3727-0449.2	580449	CABLE FRENO DE MANO	211 420 02 85 , 211 420 23 85	
	E 280	TI	05.2005		24.3727-0449.2	580449	CABLE FRENO DE MANO	211 420 02 85 , 211 420 23 85	
	E 280 4-Matic	TI	05.2005		24.3727-0449.2	580449	CABLE FRENO DE MANO	211 420 02 85 , 211 420 23 85	
	E 280 CDI	TI	05.2004		24.3727-0449.2	580449	CABLE FRENO DE MANO	211 420 02 85 , 211 420 23 85	
	E 280 CDI 4-Matic	TI	05.2005		24.3727-0449.2	580449	CABLE FRENO DE MANO	211 420 02 85 , 211 420 23 85	
	E 300 Bluetec	TI	09.2007		24.3727-0449.2	580449	CABLE FRENO DE MANO	211 420 02 85 , 211 420 23 85	
	E 320	TI	03.2002		24.3727-0449.2	580449	CABLE FRENO DE MANO	211 420 02 85 , 211 420 23 85	
	E 320 4-Matic	TI	03.2003		24.3727-0449.2	580449	CABLE FRENO DE MANO	211 420 02 85 , 211 420 23 85	
	E 320 CDI	TI	11.2002		24.3727-0449.2	580449	CABLE FRENO DE MANO	211 420 02 85 , 211 420 23 85	
	E 320 CDI 4-Matic	TI	05.2005		24.3727-0449.2	580449	CABLE FRENO DE MANO	211 420 02 85 , 211 420 23 85	
	E 350	TI	12.2004		24.3727-0449.2	580449	CABLE FRENO DE MANO	211 420 02 85 , 211 420 23 85	
	E 350 4-Matic	TI	12.2004		24.3727-0449.2	580449	CABLE FRENO DE MANO	211 420 02 85 , 211 420 23 85	
	E 350 CGI	TI	09.2007		24.3727-0449.2	580449	CABLE FRENO DE MANO	211 420 02 85 , 211 420 23 85	

Nuevas referencias en almacén - Por aplicación

09/2008



					Denominación	Ref. OE correspondientes a las referencias ATE		Referencia anterior / varios
--	--	--	--	--	--------------	------------------------------------------------	--	------------------------------

MERCEDES BENZ

Clase E (W211) Berlina (02-)	E 400 CDI	TI	03.2003		24.3727-0449.2	580449	CABLE FRENO DE MANO	211 420 02 85 , 211 420 23 85	
	E 500	TI	03.2002		24.3727-0449.2	580449	CABLE FRENO DE MANO	211 420 02 85 , 211 420 23 85	
	E 500 4-Matic	TI	10.2003		24.3727-0449.2	580449	CABLE FRENO DE MANO	211 420 02 85 , 211 420 23 85	
	E 55 Kompressor AMG		10.2002		24.0126-0136.1	426136	DISCO DE FRENO	211 423 10 12	
		TI	10.2002		24.3727-0449.2	580449	CABLE FRENO DE MANO	211 420 02 85 , 211 420 23 85	
	E 63 AMG		03.2006		24.0126-0136.1	426136	DISCO DE FRENO	211 423 10 12	
		TI	03.2006		24.3727-0449.2	580449	CABLE FRENO DE MANO	211 420 02 85 , 211 420 23 85	
Clase SLK (R171) (04-)	SLK 200 Kompressor	DD	03.2004		24.3571-1740.7	220668	PINZA DE GARRA	001 420 95 83 , 003 420 22 83	
		DI	03.2004		24.3571-1739.7	220667	PINZA DE GARRA	001 420 94 83 , 003 420 21 83	
Transporter (BM 906) SPRINTER (06-)	209 CDI		04.2006		24.0128-0203.1	428203	DISCO DE FRENO	906 421 00 12 , 2E0 615 301	
			04.2006		13.0460-3837.2	603837	PASTILLAS DE FRENO	004 420 69 20	ver figura
	211 CDI		04.2006		24.0128-0203.1	428203	DISCO DE FRENO	906 421 00 12 , 2E0 615 301	
			04.2006		13.0460-3837.2	603837	PASTILLAS DE FRENO	004 420 69 20	ver figura
	213 CDI		04.2006		24.0128-0203.1	428203	DISCO DE FRENO	906 421 00 12 , 2E0 615 301	
			04.2006		13.0460-3837.2	603837	PASTILLAS DE FRENO	004 420 69 20	ver figura
	215 CDI		04.2006		24.0128-0203.1	428203	DISCO DE FRENO	906 421 00 12 , 2E0 615 301	

Nuevas referencias en almacén - Por aplicación

09/2008



					Denominación	Ref. OE correspondientes a las referencias ATE		Referencia anterior / varios
--	--	--	--	--	--------------	------------------------------------------------	--	------------------------------

MERCEDES BENZ

Modelo	Motor	Fecha	Referencia ATE	Referencia OE	Denominación	Ref. OE correspondientes a las referencias ATE	Referencia anterior / varios
Transporter (BM 906) SPRINTER (06-)	215 CDI	04.2006	13.0460-3837.2	603837	PASTILLAS DE FRENO	004 420 69 20	ver figura
	218 CDI	04.2006	24.0128-0203.1	428203	DISCO DE FRENO	906 421 00 12 , 2E0 615 301	
		04.2006	13.0460-3837.2	603837	PASTILLAS DE FRENO	004 420 69 20	ver figura
	224	04.2006	24.0128-0203.1	428203	DISCO DE FRENO	906 421 00 12 , 2E0 615 301	
		04.2006	13.0460-3837.2	603837	PASTILLAS DE FRENO	004 420 69 20	ver figura
	309 CDI	04.2006	24.0128-0203.1	428203	DISCO DE FRENO	906 421 00 12 , 2E0 615 301	
		04.2006	13.0460-3837.2	603837	PASTILLAS DE FRENO	004 420 69 20	ver figura
	311 CDI	04.2006	24.0128-0203.1	428203	DISCO DE FRENO	906 421 00 12 , 2E0 615 301	
		04.2006	13.0460-3837.2	603837	PASTILLAS DE FRENO	004 420 69 20	ver figura
	313 CDI	04.2006	24.0128-0203.1	428203	DISCO DE FRENO	906 421 00 12 , 2E0 615 301	
		04.2006	13.0460-3837.2	603837	PASTILLAS DE FRENO	004 420 69 20	ver figura
	315 CDI	04.2006	24.0128-0203.1	428203	DISCO DE FRENO	906 421 00 12 , 2E0 615 301	
		04.2006	13.0460-3837.2	603837	PASTILLAS DE FRENO	004 420 69 20	ver figura
	318 CDI	04.2006	24.0128-0203.1	428203	DISCO DE FRENO	906 421 00 12 , 2E0 615 301	
		04.2006	13.0460-3837.2	603837	PASTILLAS DE FRENO	004 420 69 20	ver figura
	324	04.2006	24.0128-0203.1	428203	DISCO DE FRENO	906 421 00 12 , 2E0 615 301	
		04.2006	13.0460-3837.2	603837	PASTILLAS DE FRENO	004 420 69 20	ver figura
	411 CDI	04.2006	24.0128-0202.1	428202	DISCO DE FRENO	906 423 01 12 , 2E0 615 601	
		04.2006	24.0128-0203.1	428203	DISCO DE FRENO	906 421 00 12 , 2E0 615 301	









					Denominación	Ref. OE correspondientes a las referencias ATE		Referencia anterior / varios
--	--	--	--	--	--------------	------------------------------------------------	--	------------------------------

MERCEDES BENZ

Modelo	Motor	Fecha	Referencia ATE	Referencia OE	Denominación	Referencia OE correspondientes a las referencias ATE	Referencia anterior / varios
Transporter (BM 906) SPRINTER (06-)	415 CDI	04.2006	24.0128-0202.1	428202	DISCO DE FRENO	906 423 01 12 , 2E0 615 601	
		04.2006	24.0128-0203.1	428203	DISCO DE FRENO	906 421 00 12 , 2E0 615 301	
	418 CDI	04.2006	24.0128-0202.1	428202	DISCO DE FRENO	906 423 01 12 , 2E0 615 601	
		04.2006	24.0128-0203.1	428203	DISCO DE FRENO	906 421 00 12 , 2E0 615 301	
	424	04.2006	24.0128-0202.1	428202	DISCO DE FRENO	906 423 01 12 , 2E0 615 601	
		04.2006	24.0128-0203.1	428203	DISCO DE FRENO	906 421 00 12 , 2E0 615 301	
	509 CDI	04.2006	24.0128-0203.1	428203	DISCO DE FRENO	906 421 00 12 , 2E0 615 301	
		04.2006	24.0128-0202.1	428202	DISCO DE FRENO	906 423 01 12 , 2E0 615 601	
	511 CDI	04.2006	24.0128-0202.1	428202	DISCO DE FRENO	906 423 01 12 , 2E0 615 601	
		04.2006	24.0128-0203.1	428203	DISCO DE FRENO	906 421 00 12 , 2E0 615 301	
	515 CDI	04.2006	24.0128-0203.1	428203	DISCO DE FRENO	906 421 00 12 , 2E0 615 301	
		04.2006	24.0128-0202.1	428202	DISCO DE FRENO	906 423 01 12 , 2E0 615 601	
	518 CDI	04.2006	24.0128-0202.1	428202	DISCO DE FRENO	906 423 01 12 , 2E0 615 601	
		04.2006	24.0128-0203.1	428203	DISCO DE FRENO	906 421 00 12 , 2E0 615 301	
	524	04.2006	24.0128-0202.1	428202	DISCO DE FRENO	906 423 01 12 , 2E0 615 601	
		04.2006	24.0128-0203.1	428203	DISCO DE FRENO	906 421 00 12 , 2E0 615 301	
Transporter VARIO (96-)	VARIO 614 D	09.1996	24.0130-0191.1	430191	DISCO DE FRENO	668 423 01 12	
	VARIO 615 D	09.1998	24.0130-0191.1	430191	DISCO DE FRENO	668 423 01 12	
	VARIO 814 D	09.1996	24.0130-0191.1	430191	DISCO DE FRENO	668 423 01 12	



					Denominación	Ref. OE correspondientes a las referencias ATE		Referencia anterior / varios
-----------------------------------------------------------------------------------	-----------------------------------------------------------------------------------	-----------------------------------------------------------------------------------	-------------------------------------------------------------------------------------	-------------------------------------------------------------------------------------	--------------	------------------------------------------------	-------------------------------------------------------------------------------------	------------------------------







MERCEDES BENZ

Transporter VARIO (96-)	VARIO 815 D		09.1996		24.0130-0191.1	430191	DISCO DE FRENO	668 423 01 12	
VANEO (BM414) (02-)	1,6		02.2002		24.3727-0450.2	580450	CABLE FRENO DE MANO	414 420 01 85	
	1,7 CDI		02.2002		24.3727-0450.2	580450	CABLE FRENO DE MANO	414 420 01 85	
	1,9		02.2002		24.3727-0450.2	580450	CABLE FRENO DE MANO	414 420 01 85	

MINI

R50/R53 (00-06)	Cooper S Works 1,6 i		11.2003	11.2006	24.0122-0244.1	422244	DISCO DE FRENO	34 11 6 768 933	
R52 Cabriole (04-)			11.2003		24.0122-0244.1	422244	DISCO DE FRENO	34 11 6 768 933	
R55 Clubman (07-)	Cooper		09.2007		13.0460-2714.2	602714	PASTILLAS DE FRENO	34 21 6 778 327	ver figura
	Cooper D		09.2007		13.0460-2714.2	602714	PASTILLAS DE FRENO	34 21 6 778 327	ver figura
	Cooper S		09.2007		13.0460-2714.2	602714	PASTILLAS DE FRENO	34 21 6 778 327	ver figura
R56 (06-)	Cooper		11.2006		13.0460-2714.2	602714	PASTILLAS DE FRENO	34 21 6 778 327	ver figura
	Cooper D		04.2007		13.0460-2714.2	602714	PASTILLAS DE FRENO	34 21 6 778 327	ver figura
	Cooper S		11.2006		13.0460-2714.2	602714	PASTILLAS DE FRENO	34 21 6 778 327	ver figura
	One 1,4 i		04.2007		13.0460-2714.2	602714	PASTILLAS DE FRENO	34 21 6 778 327	ver figura









					Denominación	Ref. OE correspondientes a las referencias ATE		Referencia anterior / varios
-----------------------------------------------------------------------------------	-----------------------------------------------------------------------------------	-----------------------------------------------------------------------------------	-------------------------------------------------------------------------------------	-------------------------------------------------------------------------------------	--------------	------------------------------------------------	-------------------------------------------------------------------------------------	------------------------------

MITSUBISHI

L 200 (92-96)	2,5 TD 4WD (K34T)	DI	05.1993	08.1996	24.3431-1705.5	240365	PINZA DE GARRA	MB858404	
		DD	05.1993	08.1996	24.3431-1706.5	240366	PINZA DE GARRA	MB858405	
L 200 (96-06)	2,5 TD 4WD (K74T)	DD	06.1996	07.2001	24.3431-1706.5	240366	PINZA DE GARRA	MB858405	
		DD	08.2001	04.2006	24.3431-1706.5	240366	PINZA DE GARRA	MB858405	
		DI	08.2001	04.2006	24.3431-1705.5	240365	PINZA DE GARRA	MB858404	
		DI	06.1996	07.2001	24.3431-1705.5	240365	PINZA DE GARRA	MB858404	
	2,5 TDi 4WD (K74T)	DD	08.2001	04.2006	24.3431-1706.5	240366	PINZA DE GARRA	MB858405	
		DI	08.2001	04.2006	24.3431-1705.5	240365	PINZA DE GARRA	MB858404	
LANCER Evolution (04-07)	2,0 i 16V (CT9A)		08.2005	08.2007	24.0126-0134.1	426134	DISCO DE FRENO	MR510967 , MR510966	
LANCER Kombi (03-07)	2,0 i 16V (CS9W)		09.2003	03.2007	24.0126-0134.1	426134	DISCO DE FRENO	MR510967 , MR510966	
	2,4 i 16V (CS9W)		09.2003	03.2007	24.0126-0134.1	426134	DISCO DE FRENO	MR510967 , MR510966	
LANCER Limousine (03-07)	2,0 i 16V (CS9A)		12.2003	03.2007	24.0126-0134.1	426134	DISCO DE FRENO	MR510967 , MR510966	
PAJERO (90-00)	2,4 (V21C/V21W)	DI	12.1990	03.2000	24.3431-1705.5	240365	PINZA DE GARRA	MB858404	
		DD	12.1990	03.2000	24.3431-1706.5	240366	PINZA DE GARRA	MB858405	
	2,4 (V41W)	DD	12.1990	03.2000	24.3431-1706.5	240366	PINZA DE GARRA	MB858405	
		DI	12.1990	03.2000	24.3431-1705.5	240365	PINZA DE GARRA	MB858404	
	2,5 TD (V24C/V24W)	DI	12.1990	03.2000	24.3431-1705.5	240365	PINZA DE GARRA	MB858404	
		DD	12.1990	03.2000	24.3431-1706.5	240366	PINZA DE GARRA	MB858405	
	2,5 TD (V44W)	DI	12.1990	03.2000	24.3431-1705.5	240365	PINZA DE GARRA	MB858404	



					Denominación	Ref. OE correspondientes a las referencias ATE	 Referencia anterior / varios
-----------------------------------------------------------------------------------	-----------------------------------------------------------------------------------	-----------------------------------------------------------------------------------	-------------------------------------------------------------------------------------	-------------------------------------------------------------------------------------	--------------	------------------------------------------------	---------------------------------------------------------------------------------------------------------------------

MITSUBISHI

PAJERO (90-00)	2,5 TD (V44W)	DD	12.1990	03.2000	24.3431-1706.5	240366	PINZA DE GARRA	MB858405	
	2,8 TD (V26W)	DD	11.1993	03.2000	24.3431-1706.5	240366	PINZA DE GARRA	MB858405	
		DI	11.1993	03.2000	24.3431-1705.5	240365	PINZA DE GARRA	MB858404	
	2,8 TD (V46W)	DI	11.1993	03.2000	24.3431-1705.5	240365	PINZA DE GARRA	MB858404	
		DD	11.1993	03.2000	24.3431-1706.5	240366	PINZA DE GARRA	MB858405	
	3,0 V6 (V23C/V23W)	DD	12.1990	03.2000	24.3431-1706.5	240366	PINZA DE GARRA	MB858405	
		DI	12.1990	03.2000	24.3431-1705.5	240365	PINZA DE GARRA	MB858404	
	3,0 V6 (V43W)	DD	12.1990	03.2000	24.3431-1706.5	240366	PINZA DE GARRA	MB858405	
		DI	12.1990	03.2000	24.3431-1705.5	240365	PINZA DE GARRA	MB858404	
PAJERO SPORT / MONTERO (USA) (98-)	2,5 TDCi (K94W)	DI	07.2002		24.3431-1705.5	240365	PINZA DE GARRA	MB858404	
		DI	08.2003		24.3431-1705.5	240365	PINZA DE GARRA	MB858404	
		DI	11.1998		24.3431-1705.5	240365	PINZA DE GARRA	MB858404	
		DD	08.2003		24.3431-1706.5	240366	PINZA DE GARRA	MB858405	
		DD	07.2002		24.3431-1706.5	240366	PINZA DE GARRA	MB858405	
		DD	11.1998		24.3431-1706.5	240366	PINZA DE GARRA	MB858405	
SPACE GEAR (95-00)	2,4 i 4x4	DD	05.1995	05.2000	24.3431-1706.5	240366	PINZA DE GARRA	MB858405	
		DI	05.1995	05.2000	24.3431-1705.5	240365	PINZA DE GARRA	MB858404	
	2,5 TDCi 4x4	DD	05.1995	05.2000	24.3431-1706.5	240366	PINZA DE GARRA	MB858405	
		DI	05.1995	05.2000	24.3431-1705.5	240365	PINZA DE GARRA	MB858404	



					Denominación	Ref. OE correspondientes a las referencias ATE		Referencia anterior / varios
--	--	--	--	--	--------------	------------------------------------------------	--	------------------------------

MITSUBISHI

SPACE RUNNER (99-03)	2,0 i 16V (N63W)		05.2000	04.2003	24.0126-0134.1	426134	DISCO DE FRENO	MR510967 , MR510966	
	2,4 16V GDI (N64W)		05.2000	04.2003	24.0126-0134.1	426134	DISCO DE FRENO	MR510967 , MR510966	

NISSAN

ALMERA (N15) (95-00)	1,4 i		07.1997	04.2000	24.0120-0203.1	420203	DISCO DE FRENO	40206-2N301	
	1,6 i		07.1997	04.2000	24.0120-0203.1	420203	DISCO DE FRENO	40206-2N301	
	2,0 D		07.1997	04.2000	24.0120-0203.1	420203	DISCO DE FRENO	40206-2N301	
MURANO (Z50) (03-)	3,5 i V6 4x4		10.2003		24.0116-0122.1	416122	DISCO DE FRENO	43206-CA000	



					Denominación	Ref. OE correspondientes a las referencias ATE		Referencia anterior / varios
--	--	--	--	--	--------------	------------------------------------------------	--	------------------------------







OPEL

ASTRA G / Vauxhall Astra MKIV (98-04)	1,8 16V Cabrio	TI	07.2001	12.2004	24.3384-1753.7	220633	PINZA DE GARRA	93170606 , 5 42 047 , 5 42 467 , 93176084	
		TD	07.2001	12.2004	24.3384-1754.7	220634	PINZA DE GARRA	93170607 , 5 42 044 , 5 42 468 , 93176085	
	1,8 16V Coupe	TI	07.2001	12.2004	24.3384-1753.7	220633	PINZA DE GARRA	93170606 , 5 42 047 , 5 42 467 , 93176084	
		TD	07.2001	12.2004	24.3384-1754.7	220634	PINZA DE GARRA	93170607 , 5 42 044 , 5 42 468 , 93176085	
	2,0 16V OPC	TI	07.2001	12.2004	24.3384-1753.7	220633	PINZA DE GARRA	93170606 , 5 42 047 , 5 42 467 , 93176084	
		TD	07.2001	12.2004	24.3384-1754.7	220634	PINZA DE GARRA	93170607 , 5 42 044 , 5 42 468 , 93176085	
			10.1999	12.2004	24.0325-0142.1	525142	POWER-DISC	5055389 , 4567798 , 9184405 , 5 69 061 , 9194477 , 5391560	
	2,0 16V OPC Cabrio	TI	03.2002	12.2004	24.3384-1753.7	220633	PINZA DE GARRA	93170606 , 5 42 047 , 5 42 467 , 93176084	
		TD	03.2002	12.2004	24.3384-1754.7	220634	PINZA DE GARRA	93170607 , 5 42 044 , 5 42 468 , 93176085	
			03.2002	12.2004	24.0325-0142.1	525142	POWER-DISC	5055389 , 4567798 , 9184405 , 5 69 061 , 9194477 , 5391560	
	2,0 Turbo	TI	07.2001	12.2004	24.3384-1753.7	220633	PINZA DE GARRA	93170606 , 5 42 047 , 5 42 467 , 93176084	
		TD	07.2001	12.2004	24.3384-1754.7	220634	PINZA DE GARRA	93170607 , 5 42 044 , 5 42 468 , 93176085	

Nuevas referencias en almacén - Por aplicación

09/2008









					Denominación	Ref. OE correspondientes a las referencias ATE		Referencia anterior / varios
-----------------------------------------------------------------------------------	-----------------------------------------------------------------------------------	-----------------------------------------------------------------------------------	-------------------------------------------------------------------------------------	-------------------------------------------------------------------------------------	--------------	------------------------------------------------	-------------------------------------------------------------------------------------	------------------------------

OPEL

ASTRA G / Vauxhall Astra MKIV (98-04)	2,0 Turbo		03.2000	12.2004	24.0325-0142.1	525142	POWER-DISC	5055389 , 4567798 , 9184405 , 5 69 061 , 9194477 , 5391560	
	2,2 16V Cabrio	TD	07.2001	12.2004	24.3384-1754.7	220634	PINZA DE GARRA	93170607 , 5 42 044 , 5 42 468 , 93176085	
		TI	07.2001	12.2004	24.3384-1753.7	220633	PINZA DE GARRA	93170606 , 5 42 047 , 5 42 467 , 93176084	
	2,2 16V Coupe	TD	07.2001	12.2004	24.3384-1754.7	220634	PINZA DE GARRA	93170607 , 5 42 044 , 5 42 468 , 93176085	
		TI	07.2001	12.2004	24.3384-1753.7	220633	PINZA DE GARRA	93170606 , 5 42 047 , 5 42 467 , 93176084	
	2,2 DTI 16V Cabrio	TI	09.2002	12.2004	24.3384-1753.7	220633	PINZA DE GARRA	93170606 , 5 42 047 , 5 42 467 , 93176084	
		TD	09.2002	12.2004	24.3384-1754.7	220634	PINZA DE GARRA	93170607 , 5 42 044 , 5 42 468 , 93176085	
	2,2 DTI 16V Coupe	TI	09.2002	12.2004	24.3384-1753.7	220633	PINZA DE GARRA	93170606 , 5 42 047 , 5 42 467 , 93176084	
		TD	09.2002	12.2004	24.3384-1754.7	220634	PINZA DE GARRA	93170607 , 5 42 044 , 5 42 468 , 93176085	
ASTRA H / GTC / Vauxhall Astra MKV (04-)	1,3 CDTI		08.2005		24.0325-0148.1	525148	POWER-DISC	5 69 006 , 93175376 , 93181113 , 5 69 007	
	1,4		01.2004		24.0325-0148.1	525148	POWER-DISC	5 69 006 , 93175376 , 93181113 , 5 69 007	
	1,6		01.2004		24.0325-0148.1	525148	POWER-DISC	5 69 006 , 93175376 , 93181113 , 5 69 007	
			01.2007		24.0325-0148.1	525148	POWER-DISC	5 69 006 , 93175376 , 93181113 , 5 69 007	









					Denominación	Ref. OE correspondientes a las referencias ATE	 Referencia anterior / varios
-----------------------------------------------------------------------------------	-----------------------------------------------------------------------------------	-----------------------------------------------------------------------------------	-------------------------------------------------------------------------------------	-------------------------------------------------------------------------------------	--------------	------------------------------------------------	------------------------------------------------------------------------------------------------------------------

OPEL

Modelo	Motor	Fecha	Fecha	ATE	ATE	Denominación	Ref. OE correspondientes a las referencias ATE	Referencia anterior / varios
ASTRA H / GTC / Vauxhall Astra MKV (04-)	1,6 Turbo	01.2007		24.0325-0148.1	525148	POWER-DISC	5 69 006 , 93175376 , 93181113 , 5 69 007	
		01.2007		24.0325-0142.1	525142	POWER-DISC	5055389 , 4567798 , 9184405 , 5 69 061 , 9194477 , 5391560	
	1,7 CDTI	01.2004		24.0325-0148.1	525148	POWER-DISC	5 69 006 , 93175376 , 93181113 , 5 69 007	
		04.2007		24.0325-0148.1	525148	POWER-DISC	5 69 006 , 93175376 , 93181113 , 5 69 007	
		04.2007		24.0325-0142.1	525142	POWER-DISC	5055389 , 4567798 , 9184405 , 5 69 061 , 9194477 , 5391560	
	1,8	01.2004		24.0325-0148.1	525148	POWER-DISC	5 69 006 , 93175376 , 93181113 , 5 69 007	
		01.2006		24.0325-0148.1	525148	POWER-DISC	5 69 006 , 93175376 , 93181113 , 5 69 007	
	1,9 CDTI	09.2004		24.0325-0142.1	525142	POWER-DISC	5055389 , 4567798 , 9184405 , 5 69 061 , 9194477 , 5391560	
		09.2005		24.0325-0142.1	525142	POWER-DISC	5055389 , 4567798 , 9184405 , 5 69 061 , 9194477 , 5391560	
		09.2004		24.0325-0148.1	525148	POWER-DISC	5 69 006 , 93175376 , 93181113 , 5 69 007	
		09.2005		24.0325-0148.1	525148	POWER-DISC	5 69 006 , 93175376 , 93181113 , 5 69 007	
	2,0 Turbo	01.2004		24.0325-0142.1	525142	POWER-DISC	5055389 , 4567798 , 9184405 , 5 69 061 , 9194477 , 5391560	



					Denominación	Ref. OE correspondientes a las referencias ATE	 Referencia anterior / varios
-----------------------------------------------------------------------------------	-----------------------------------------------------------------------------------	-----------------------------------------------------------------------------------	-------------------------------------------------------------------------------------	-------------------------------------------------------------------------------------	--------------	------------------------------------------------	---------------------------------------------------------------------------------------------------------------------

OPEL

ASTRA H / GTC / Vauxhall Astra MKV (04-)	2,0 Turbo		09.2004		24.0325-0142.1	525142	POWER-DISC	5055389 , 4567798 , 9184405 , 5 69 061 , 9194477 , 5391560	
			01.2004		24.0325-0148.1	525148	POWER-DISC	5 69 006 , 93175376 , 93181113 , 5 69 007	
			09.2004		24.0325-0148.1	525148	POWER-DISC	5 69 006 , 93175376 , 93181113 , 5 69 007	
	2,0 Turbo OPC		03.2005		24.0325-0148.1	525148	POWER-DISC	5 69 006 , 93175376 , 93181113 , 5 69 007	
ASTRA H Caravan/Vau. Astra MKV Estate (04-)	1,3 CDTI		08.2005		24.0325-0148.1	525148	POWER-DISC	5 69 006 , 93175376 , 93181113 , 5 69 007	
	1,4		08.2004		24.0325-0148.1	525148	POWER-DISC	5 69 006 , 93175376 , 93181113 , 5 69 007	
	1,6		08.2004		24.0325-0148.1	525148	POWER-DISC	5 69 006 , 93175376 , 93181113 , 5 69 007	
			01.2007		24.0325-0148.1	525148	POWER-DISC	5 69 006 , 93175376 , 93181113 , 5 69 007	
	1,6 Turbo		01.2007		24.0325-0148.1	525148	POWER-DISC	5 69 006 , 93175376 , 93181113 , 5 69 007	
			01.2007		24.0325-0142.1	525142	POWER-DISC	5055389 , 4567798 , 9184405 , 5 69 061 , 9194477 , 5391560	
	1,7 CDTI		04.2007		24.0325-0148.1	525148	POWER-DISC	5 69 006 , 93175376 , 93181113 , 5 69 007	
			08.2004		24.0325-0148.1	525148	POWER-DISC	5 69 006 , 93175376 , 93181113 , 5 69 007	



					Denominación	Ref. OE correspondientes a las referencias ATE		Referencia anterior / varios
--	--	--	--	--	--------------	------------------------------------------------	--	------------------------------

OPEL

ASTRA H Caravan/Vau. Astra MKV Estate (04-)	1,7 CDTI		04.2007		24.0325-0142.1	525142	POWER-DISC	5055389 , 4567798 , 9184405 , 5 69 061 , 9194477 , 5391560	
	1,8		08.2005		24.0325-0148.1	525148	POWER-DISC	5 69 006 , 93175376 , 93181113 , 5 69 007	
			09.2004		24.0325-0148.1	525148	POWER-DISC	5 69 006 , 93175376 , 93181113 , 5 69 007	
	1,9 CDTI		09.2004		24.0325-0148.1	525148	POWER-DISC	5 69 006 , 93175376 , 93181113 , 5 69 007	
			09.2005		24.0325-0142.1	525142	POWER-DISC	5055389 , 4567798 , 9184405 , 5 69 061 , 9194477 , 5391560	
			09.2005		24.0325-0148.1	525148	POWER-DISC	5 69 006 , 93175376 , 93181113 , 5 69 007	
			08.2004		24.0325-0148.1	525148	POWER-DISC	5 69 006 , 93175376 , 93181113 , 5 69 007	
			09.2004		24.0325-0142.1	525142	POWER-DISC	5055389 , 4567798 , 9184405 , 5 69 061 , 9194477 , 5391560	
			08.2004		24.0325-0142.1	525142	POWER-DISC	5055389 , 4567798 , 9184405 , 5 69 061 , 9194477 , 5391560	
	2,0 Turbo		09.2004		24.0325-0148.1	525148	POWER-DISC	5 69 006 , 93175376 , 93181113 , 5 69 007	
			09.2004		24.0325-0142.1	525142	POWER-DISC	5055389 , 4567798 , 9184405 , 5 69 061 , 9194477 , 5391560	



					Denominación	Ref. OE correspondientes a las referencias ATE		Referencia anterior / varios
--	--	--	--	--	--------------	------------------------------------------------	--	------------------------------

OPEL

ASTRA H Caravan/Vau. Astra MKV Estate (04-)	2,0 Turbo		08.2004		24.0325-0142.1	525142	POWER-DISC	5055389 , 4567798 , 9184405 , 5 69 061 , 9194477 , 5391560	
			08.2004		24.0325-0148.1	525148	POWER-DISC	5 69 006 , 93175376 , 93181113 , 5 69 007	
ASTRA TWIN TOP (06-)	1,6		03.2006		24.0325-0148.1	525148	POWER-DISC	5 69 006 , 93175376 , 93181113 , 5 69 007	
			12.2006		24.0325-0148.1	525148	POWER-DISC	5 69 006 , 93175376 , 93181113 , 5 69 007	
	1,6 Turbo		02.2007		24.0325-0148.1	525148	POWER-DISC	5 69 006 , 93175376 , 93181113 , 5 69 007	
			02.2007		24.0325-0142.1	525142	POWER-DISC	5055389 , 4567798 , 9184405 , 5 69 061 , 9194477 , 5391560	
	1,8		03.2006		24.0325-0148.1	525148	POWER-DISC	5 69 006 , 93175376 , 93181113 , 5 69 007	
	1,9 CDTI		03.2006		24.0325-0142.1	525142	POWER-DISC	5055389 , 4567798 , 9184405 , 5 69 061 , 9194477 , 5391560	
			03.2006		24.0325-0148.1	525148	POWER-DISC	5 69 006 , 93175376 , 93181113 , 5 69 007	
	2,0 Turbo		03.2006		24.0325-0142.1	525142	POWER-DISC	5055389 , 4567798 , 9184405 , 5 69 061 , 9194477 , 5391560	
			03.2006		24.0325-0148.1	525148	POWER-DISC	5 69 006 , 93175376 , 93181113 , 5 69 007	
COMBO / Vauxhall Combo (01-)	1,3 CDTI				24.0325-0148.1	525148	POWER-DISC	5 69 006 , 93175376 , 93181113 , 5 69 007	



					Denominación	Ref. OE correspondientes a las referencias ATE		Referencia anterior / varios
--	--	--	--	--	--------------	------------------------------------------------	--	------------------------------

OPEL

COMBO / Vauxhall Combo (01-)	1,4 16V				24.0325-0148.1	525148	POWER-DISC	5 69 006 , 93175376 , 93181113 , 5 69 007	
	1,6				24.0325-0148.1	525148	POWER-DISC	5 69 006 , 93175376 , 93181113 , 5 69 007	
	1,7 DI 16V				24.0325-0148.1	525148	POWER-DISC	5 69 006 , 93175376 , 93181113 , 5 69 007	
	1,7 DTI 16V				24.0325-0148.1	525148	POWER-DISC	5 69 006 , 93175376 , 93181113 , 5 69 007	
CORSA C / Vauxhall Corsa MK II (00-06)	1,0 12V	DI	09.2000	09.2006	24.3481-1765.5	240369	PINZA DE GARRA	55 42 005 , 9195986	
		DD	09.2000	09.2006	24.3481-1766.5	240370	PINZA DE GARRA	5 42 085 , 9195987	
	1,2 16V	DD	09.2000	09.2006	24.3481-1766.5	240370	PINZA DE GARRA	5 42 085 , 9195987	
		DI	09.2000	09.2006	24.3481-1765.5	240369	PINZA DE GARRA	55 42 005 , 9195986	
	1,7 DI 16V	DI	09.2000	09.2006	24.3481-1765.5	240369	PINZA DE GARRA	55 42 005 , 9195986	
		DD	09.2000	09.2006	24.3481-1766.5	240370	PINZA DE GARRA	5 42 085 , 9195987	
CORSA D / Vauxhall Corsa MK III (06-)	1,0 i		10.2006		24.0112-0184.1	412184	DISCO DE FRENO	93188916 , 55700918 , 55700398 , 5 69 022	
	1,6 Turbo OPC		03.2007		24.0325-0142.1	525142	POWER-DISC	5055389 , 4567798 , 9184405 , 5 69 061 , 9194477 , 5391560	
MERIVA / Vauxhall Meriva (02-)	1,3 CDTI		09.2003		24.0325-0148.1	525148	POWER-DISC	5 69 006 , 93175376 , 93181113 , 5 69 007	
	1,6		01.2006		24.0325-0148.1	525148	POWER-DISC	5 69 006 , 93175376 , 93181113 , 5 69 007	
	1,6 16V	TI	05.2003		24.3384-1753.7	220633	PINZA DE GARRA	93170606 , 5 42 047 , 5 42 467 , 93176084	



					Denominación	Ref. OE correspondientes a las referencias ATE		Referencia anterior / varios
--	--	--	--	--	--------------	------------------------------------------------	--	------------------------------

OPEL

MERIVA / Vauxhall Meriva (02-)	1,6 16V	TD	05.2003		24.3384-1754.7	220634	PINZA DE GARRA	93170607 , 5 42 044 , 5 42 468 , 93176085	
			05.2003		24.0325-0148.1	525148	POWER-DISC	5 69 006 , 93175376 , 93181113 , 5 69 007	
	1,6 Turbo OPC		09.2005		24.0325-0142.1	525142	POWER-DISC	5055389 , 4567798 , 9184405 , 5 69 061 , 9194477 , 5391560	
	1,7 CDTI	TD	09.2003		24.3384-1754.7	220634	PINZA DE GARRA	93170607 , 5 42 044 , 5 42 468 , 93176085	
		TI	09.2003		24.3384-1753.7	220633	PINZA DE GARRA	93170606 , 5 42 047 , 5 42 467 , 93176084	
	1,7 DTI 16V	TI	09.2002		24.3384-1753.7	220633	PINZA DE GARRA	93170606 , 5 42 047 , 5 42 467 , 93176084	
		TD	09.2002		24.3384-1754.7	220634	PINZA DE GARRA	93170607 , 5 42 044 , 5 42 468 , 93176085	
			09.2002		24.0325-0148.1	525148	POWER-DISC	5 69 006 , 93175376 , 93181113 , 5 69 007	
	1,8 16V	TI	09.2002		24.3384-1753.7	220633	PINZA DE GARRA	93170606 , 5 42 047 , 5 42 467 , 93176084	
		TD	09.2002		24.3384-1754.7	220634	PINZA DE GARRA	93170607 , 5 42 044 , 5 42 468 , 93176085	
			09.2002		24.0325-0148.1	525148	POWER-DISC	5 69 006 , 93175376 , 93181113 , 5 69 007	
VECTRA B / Vauxhall Vectra (96-02)	i 500 2,5		05.1998	09.2000	24.0325-0142.1	525142	POWER-DISC	5055389 , 4567798 , 9184405 , 5 69 061 , 9194477 , 5391560	
ZAFIRA I / Vauxhall Zafira I (99-05)	1,6 16V	TD	04.1999	06.2005	24.3384-1754.7	220634	PINZA DE GARRA	93170607 , 5 42 044 , 5 42 468 , 93176085	



					Denominación	Ref. OE correspondientes a las referencias ATE		Referencia anterior / varios
--	--	--	--	--	--------------	------------------------------------------------	--	------------------------------

OPEL

ZAFIRA I / Vauxhall Zafira I (99-05)	1,6 16V	TI	04.1999	06.2005	24.3384-1753.7	220633	PINZA DE GARRA	93170606 , 5 42 047 , 5 42 467 , 93176084	
				06.2005	24.3727-0784.2	580784	CABLE FRENO DE MANO	13153655 , 5 22 032	
	1,8 16V	TD	04.1999	06.2005	24.3384-1754.7	220634	PINZA DE GARRA	93170607 , 5 42 044 , 5 42 468 , 93176085	
		TI	04.1999	06.2005	24.3384-1753.7	220633	PINZA DE GARRA	93170606 , 5 42 047 , 5 42 467 , 93176084	
				06.2005	24.3727-0784.2	580784	CABLE FRENO DE MANO	13153655 , 5 22 032	
	2,0 16V OPC	TI	09.2001	06.2005	24.3384-1753.7	220633	PINZA DE GARRA	93170606 , 5 42 047 , 5 42 467 , 93176084	
		TD	09.2001	06.2005	24.3384-1754.7	220634	PINZA DE GARRA	93170607 , 5 42 044 , 5 42 468 , 93176085	
				06.2005	24.3727-0784.2	580784	CABLE FRENO DE MANO	13153655 , 5 22 032	
			09.2001	06.2005	24.0325-0142.1	525142	POWER-DISC	5055389 , 4567798 , 9184405 , 5 69 061 , 9194477 , 5391560	
	2,0 DI 16V	TI	10.1999	06.2005	24.3384-1753.7	220633	PINZA DE GARRA	93170606 , 5 42 047 , 5 42 467 , 93176084	
		TD	10.1999	06.2005	24.3384-1754.7	220634	PINZA DE GARRA	93170607 , 5 42 044 , 5 42 468 , 93176085	
				06.2005	24.3727-0784.2	580784	CABLE FRENO DE MANO	13153655 , 5 22 032	
	2,0 DTI 16V	TD	06.2000	06.2005	24.3384-1754.7	220634	PINZA DE GARRA	93170607 , 5 42 044 , 5 42 468 , 93176085	
		TI	06.2000	06.2005	24.3384-1753.7	220633	PINZA DE GARRA	93170606 , 5 42 047 , 5 42 467 , 93176084	
				06.2005	24.3727-0784.2	580784	CABLE FRENO DE MANO	13153655 , 5 22 032	



	i				Denominación	Ref. OE correspondientes a las referencias ATE	i Referencia anterior / varios
--	----------	--	--	--	---------------------	-------------------------------------------------------	------------------------------------------

OPEL

ZAFIRA I / Vauxhall Zafira I (99-05)	2,2 16V	TD	09.2000	06.2005	24.3384-1754.7	220634	PINZA DE GARRA	93170607 , 5 42 044 , 5 42 468 , 93176085	
		TI	09.2000	06.2005	24.3384-1753.7	220633	PINZA DE GARRA	93170606 , 5 42 047 , 5 42 467 , 93176084	
				06.2005	24.3727-0784.2	580784	CABLE FRENO DE MANO	13153655 , 5 22 032	
	2,2 DTI 16V	TI	01.2002	06.2005	24.3384-1753.7	220633	PINZA DE GARRA	93170606 , 5 42 047 , 5 42 467 , 93176084	
		TD	01.2002	06.2005	24.3384-1754.7	220634	PINZA DE GARRA	93170607 , 5 42 044 , 5 42 468 , 93176085	
				06.2005	24.3727-0784.2	580784	CABLE FRENO DE MANO	13153655 , 5 22 032	
ZAFIRA II / Vauxhall Zafira II (05-)	1,7 CDTI		12.2007		24.0325-0142.1	525142	POWER-DISC	5055389 , 4567798 , 9184405 , 5 69 061 , 9194477 , 5391560	
	1,9 CDTI		07.2005		24.0325-0142.1	525142	POWER-DISC	5055389 , 4567798 , 9184405 , 5 69 061 , 9194477 , 5391560	
	2,0 Turbo		07.2005		24.0325-0142.1	525142	POWER-DISC	5055389 , 4567798 , 9184405 , 5 69 061 , 9194477 , 5391560	
	2,2		07.2005		24.0325-0142.1	525142	POWER-DISC	5055389 , 4567798 , 9184405 , 5 69 061 , 9194477 , 5391560	



	i				Denominación	Ref. OE correspondientes a las referencias ATE	i Referencia anterior / varios
--	----------	--	--	--	--------------	------------------------------------------------	------------------------------------------

PEUGEOT

BOXER (06-)	2,2 HDi (12/14)		04.2006		24.0124-0208.1	424208	DISCO DE FRENO	4249 26 , 51728377 , 51740244 , 4249 27	
	2,2 HDi (16H)		04.2006		24.0124-0209.1	424209	DISCO DE FRENO	4249 35 , 51728378 , 51740247 , 4249 36	
			04.2006		24.0116-0125.1	416125	DISCO DE FRENO	4249 39 , 51749275 , 51740248 , 4249 40	
	3,0 HDi (12/14)		04.2006		24.0124-0208.1	424208	DISCO DE FRENO	4249 26 , 51728377 , 51740244 , 4249 27	
	3,0 HDi (16H)		04.2006		24.0124-0209.1	424209	DISCO DE FRENO	4249 35 , 51728378 , 51740247 , 4249 36	
			04.2006		24.0116-0125.1	416125	DISCO DE FRENO	4249 39 , 51749275 , 51740248 , 4249 40	



					Denominación	Ref. OE correspondientes a las referencias ATE		Referencia anterior / varios
--	--	--	--	--	--------------	------------------------------------------------	--	------------------------------

RENAULT

LAGUNA II Grandtour (KG_) (01-07)	1,6 16V		03.2001		24.0111-0101.2	411101	DISCO C/ROD. Y SENSOR	77 01 472 838 , 77 01 713 008 , 82 00 367 094	24.0111-0156.1
	1,8 16V (O4/O6/OV)		03.2001		24.0111-0101.2	411101	DISCO C/ROD. Y SENSOR	77 01 472 838 , 77 01 713 008 , 82 00 367 094	24.0111-0156.1
	1,8 16V (OB/OC/OM)		03.2001		24.0111-0101.2	411101	DISCO C/ROD. Y SENSOR	77 01 472 838 , 77 01 713 008 , 82 00 367 094	24.0111-0156.1
	1,8 16V (OJ)		03.2001		24.0111-0101.2	411101	DISCO C/ROD. Y SENSOR	77 01 472 838 , 77 01 713 008 , 82 00 367 094	24.0111-0156.1
	1,9 dCi		01.2005		24.0111-0101.2	411101	DISCO C/ROD. Y SENSOR	77 01 472 838 , 77 01 713 008 , 82 00 367 094	24.0111-0156.1
			03.2001		24.0111-0101.2	411101	DISCO C/ROD. Y SENSOR	77 01 472 838 , 77 01 713 008 , 82 00 367 094	24.0111-0156.1
			05.2005		24.0111-0101.2	411101	DISCO C/ROD. Y SENSOR	77 01 472 838 , 77 01 713 008 , 82 00 367 094	24.0111-0156.1
	1,9 dCi (O8/10)		03.2004		24.0111-0101.2	411101	DISCO C/ROD. Y SENSOR	77 01 472 838 , 77 01 713 008 , 82 00 367 094	24.0111-0156.1
	1,9 dCi (OE)		06.2001		24.0111-0101.2	411101	DISCO C/ROD. Y SENSOR	77 01 472 838 , 77 01 713 008 , 82 00 367 094	24.0111-0156.1
	1,9 dCi (OG)		03.2001		24.0111-0101.2	411101	DISCO C/ROD. Y SENSOR	77 01 472 838 , 77 01 713 008 , 82 00 367 094	24.0111-0156.1
	1,9 dCi (OR)		10.2001		24.0111-0101.2	411101	DISCO C/ROD. Y SENSOR	77 01 472 838 , 77 01 713 008 , 82 00 367 094	24.0111-0156.1
	2,0 16V		01.2005		24.0111-0101.2	411101	DISCO C/ROD. Y SENSOR	77 01 472 838 , 77 01 713 008 , 82 00 367 094	24.0111-0156.1
	2,0 16V (OO/OK/OW)		08.2002		24.0111-0101.2	411101	DISCO C/ROD. Y SENSOR	77 01 472 838 , 77 01 713 008 , 82 00 367 094	24.0111-0156.1









					Denominación	Ref. OE correspondientes a las referencias ATE		Referencia anterior / varios
--	--	--	--	--	--------------	------------------------------------------------	--	------------------------------

RENAULT

LAGUNA II Grandtour (KG_) (01-07)	2,0 16V IDE (ON/OP)		04.2001		24.0111-0101.2	411101	DISCO C/ROD. Y SENSOR	77 01 472 838 , 77 01 713 008 , 82 00 367 094	24.0111-0156.1
	2,0 16V Sport		01.2005		24.0111-0101.2	411101	DISCO C/ROD. Y SENSOR	77 01 472 838 , 77 01 713 008 , 82 00 367 094	24.0111-0156.1
	2,0 16V Turbo		01.2003		24.0111-0101.2	411101	DISCO C/ROD. Y SENSOR	77 01 472 838 , 77 01 713 008 , 82 00 367 094	24.0111-0156.1
	2,0 dCi		08.2005		24.0111-0101.2	411101	DISCO C/ROD. Y SENSOR	77 01 472 838 , 77 01 713 008 , 82 00 367 094	24.0111-0156.1
	2,0 dCi 130		01.2006		24.0111-0101.2	411101	DISCO C/ROD. Y SENSOR	77 01 472 838 , 77 01 713 008 , 82 00 367 094	24.0111-0156.1
	2,2 dCi		05.2005		24.0111-0101.2	411101	DISCO C/ROD. Y SENSOR	77 01 472 838 , 77 01 713 008 , 82 00 367 094	24.0111-0156.1
			10.2001		24.0111-0101.2	411101	DISCO C/ROD. Y SENSOR	77 01 472 838 , 77 01 713 008 , 82 00 367 094	24.0111-0156.1
	3,0 V6		03.2001		24.0111-0101.2	411101	DISCO C/ROD. Y SENSOR	77 01 472 838 , 77 01 713 008 , 82 00 367 094	24.0111-0156.1
LAGUNA II Berlina (BG_) (01-07)	1,6 16V		03.2001		24.0111-0101.2	411101	DISCO C/ROD. Y SENSOR	77 01 472 838 , 77 01 713 008 , 82 00 367 094	24.0111-0156.1
	1,8 16V (O4/O6/OV)		03.2001		24.0111-0101.2	411101	DISCO C/ROD. Y SENSOR	77 01 472 838 , 77 01 713 008 , 82 00 367 094	24.0111-0156.1
	1,8 16V (OB/OC/OM)		03.2001		24.0111-0101.2	411101	DISCO C/ROD. Y SENSOR	77 01 472 838 , 77 01 713 008 , 82 00 367 094	24.0111-0156.1
	1,8 16V (OJ)		03.2001		24.0111-0101.2	411101	DISCO C/ROD. Y SENSOR	77 01 472 838 , 77 01 713 008 , 82 00 367 094	24.0111-0156.1
	1,9 dCi		01.2005		24.0111-0101.2	411101	DISCO C/ROD. Y SENSOR	77 01 472 838 , 77 01 713 008 , 82 00 367 094	24.0111-0156.1



					Denominación	Ref. OE correspondientes a las referencias ATE	 Referencia anterior / varios
-----------------------------------------------------------------------------------	-----------------------------------------------------------------------------------	-----------------------------------------------------------------------------------	-------------------------------------------------------------------------------------	-------------------------------------------------------------------------------------	--------------	------------------------------------------------	------------------------------------------------------------------------------------------------------------------

RENAULT

Modelo	Motor	Fecha 1	Fecha 2	Ref. ATE 1	Ref. ATE 2	Denominación	Ref. OE correspondientes a las referencias ATE	Referencia anterior / varios
LAGUNA II Berlina (BG_) (01-07)	1,9 dCi	03.2001		24.0111-0101.2	411101	DISCO C/ROD. Y SENSOR	77 01 472 838 , 77 01 713 008 , 82 00 367 094	24.0111-0156.1
		05.2005		24.0111-0101.2	411101	DISCO C/ROD. Y SENSOR	77 01 472 838 , 77 01 713 008 , 82 00 367 094	24.0111-0156.1
	1,9 dCi (08/10)	03.2004		24.0111-0101.2	411101	DISCO C/ROD. Y SENSOR	77 01 472 838 , 77 01 713 008 , 82 00 367 094	24.0111-0156.1
	1,9 dCi (OE)	06.2001		24.0111-0101.2	411101	DISCO C/ROD. Y SENSOR	77 01 472 838 , 77 01 713 008 , 82 00 367 094	24.0111-0156.1
	1,9 dCi (OG)	03.2001		24.0111-0101.2	411101	DISCO C/ROD. Y SENSOR	77 01 472 838 , 77 01 713 008 , 82 00 367 094	24.0111-0156.1
	1,9 dCi (OR)	10.2001		24.0111-0101.2	411101	DISCO C/ROD. Y SENSOR	77 01 472 838 , 77 01 713 008 , 82 00 367 094	24.0111-0156.1
	2,0 16V	01.2005		24.0111-0101.2	411101	DISCO C/ROD. Y SENSOR	77 01 472 838 , 77 01 713 008 , 82 00 367 094	24.0111-0156.1
	2,0 16V (OO/OK/OW)	08.2002		24.0111-0101.2	411101	DISCO C/ROD. Y SENSOR	77 01 472 838 , 77 01 713 008 , 82 00 367 094	24.0111-0156.1
	2,0 16V IDE (ON/OP)	04.2001		24.0111-0101.2	411101	DISCO C/ROD. Y SENSOR	77 01 472 838 , 77 01 713 008 , 82 00 367 094	24.0111-0156.1
	2,0 16V Sport	01.2005		24.0111-0101.2	411101	DISCO C/ROD. Y SENSOR	77 01 472 838 , 77 01 713 008 , 82 00 367 094	24.0111-0156.1
	2,0 16V Turbo	01.2003		24.0111-0101.2	411101	DISCO C/ROD. Y SENSOR	77 01 472 838 , 77 01 713 008 , 82 00 367 094	24.0111-0156.1
	2,0 dCi	08.2005		24.0111-0101.2	411101	DISCO C/ROD. Y SENSOR	77 01 472 838 , 77 01 713 008 , 82 00 367 094	24.0111-0156.1
	2,0 dCi 130	01.2006		24.0111-0101.2	411101	DISCO C/ROD. Y SENSOR	77 01 472 838 , 77 01 713 008 , 82 00 367 094	24.0111-0156.1



					Denominación	Ref. OE correspondientes a las referencias ATE		Referencia anterior / varios
--	--	--	--	--	--------------	------------------------------------------------	--	------------------------------

RENAULT

LAGUNA II Berlina (BG_) (01-07)	2,2 dCi		05.2005		24.0111-0101.2	411101	DISCO C/ROD. Y SENSOR	77 01 472 838 , 77 01 713 008 , 82 00 367 094	24.0111-0156.1
			10.2001		24.0111-0101.2	411101	DISCO C/ROD. Y SENSOR	77 01 472 838 , 77 01 713 008 , 82 00 367 094	24.0111-0156.1
	3,0 V6		03.2001		24.0111-0101.2	411101	DISCO C/ROD. Y SENSOR	77 01 472 838 , 77 01 713 008 , 82 00 367 094	24.0111-0156.1
MASTER II Autobús (JD/ND) (98-06)	1,9 dCi 80	ET	11.2001	10.2003	24.0711-5075.3	360232	SENSOR DE LA RUEDA	82 00 037 443	
	1,9 dTi	ET	09.2000	10.2003	24.0711-5075.3	360232	SENSOR DE LA RUEDA	82 00 037 443	
	2,2 dCi 90	ET	11.2002	10.2003	24.0711-5075.3	360232	SENSOR DE LA RUEDA	82 00 037 443	
	2,5 D	ET	07.1999	01.2001	24.0711-5075.3	360232	SENSOR DE LA RUEDA	82 00 037 443	
	2,5 dCi 120	ET	10.2001	10.2003	24.0711-5075.3	360232	SENSOR DE LA RUEDA	82 00 037 443	
	2,8 dTi	ET	07.1999	10.2001	24.0711-5075.3	360232	SENSOR DE LA RUEDA	82 00 037 443	
MASTER II Furgón (FD_) (98-06)	1,9 dCi 80	ET	11.2001	10.2003	24.0711-5075.3	360232	SENSOR DE LA RUEDA	82 00 037 443	
	1,9 dTi	ET	09.2000	10.2003	24.0711-5075.3	360232	SENSOR DE LA RUEDA	82 00 037 443	
	2,2 dCi 90	ET	11.2002	10.2003	24.0711-5075.3	360232	SENSOR DE LA RUEDA	82 00 037 443	
	2,5 D	ET	07.1999	01.2001	24.0711-5075.3	360232	SENSOR DE LA RUEDA	82 00 037 443	
	2,5 dCi 120	ET	10.2001	10.2003	24.0711-5075.3	360232	SENSOR DE LA RUEDA	82 00 037 443	
	2,8 dTi	ET	07.1999	10.2001	24.0711-5075.3	360232	SENSOR DE LA RUEDA	82 00 037 443	

Nuevas referencias en almacén - Por aplicación

09/2008



					Denominación	Ref. OE correspondientes a las referencias ATE		Referencia anterior / varios
--	--	--	--	--	--------------	------------------------------------------------	--	------------------------------







SAAB

9-5 Break (YS3E) (98-)	2		07.2000	07.2001	24.0325-0142.1	525142	POWER-DISC	5055389 , 4567798 , 9184405 , 5 69 061 , 9194477 , 5391560	
	2,0 t		10.1998		24.0325-0142.1	525142	POWER-DISC	5055389 , 4567798 , 9184405 , 5 69 061 , 9194477 , 5391560	
	2,3		06.2003	08.2005	24.0325-0142.1	525142	POWER-DISC	5055389 , 4567798 , 9184405 , 5 69 061 , 9194477 , 5391560	
	2,3 T		01.2006		24.0325-0142.1	525142	POWER-DISC	5055389 , 4567798 , 9184405 , 5 69 061 , 9194477 , 5391560	
			07.2003		24.0325-0142.1	525142	POWER-DISC	5055389 , 4567798 , 9184405 , 5 69 061 , 9194477 , 5391560	
			10.1998		24.0325-0142.1	525142	POWER-DISC	5055389 , 4567798 , 9184405 , 5 69 061 , 9194477 , 5391560	
	2,3 T Aero		09.2001		24.0325-0142.1	525142	POWER-DISC	5055389 , 4567798 , 9184405 , 5 69 061 , 9194477 , 5391560	
			10.1999	09.2001	24.0325-0142.1	525142	POWER-DISC	5055389 , 4567798 , 9184405 , 5 69 061 , 9194477 , 5391560	
			04.2003	03.2004	24.0325-0142.1	525142	POWER-DISC	5055389 , 4567798 , 9184405 , 5 69 061 , 9194477 , 5391560	
	2,3 t BioPower		01.2007		24.0325-0142.1	525142	POWER-DISC	5055389 , 4567798 , 9184405 , 5 69 061 , 9194477 , 5391560	

Nuevas referencias en almacén - Por aplicación

09/2008



					Denominación	Ref. OE correspondientes a las referencias ATE	 Referencia anterior / varios
-----------------------------------------------------------------------------------	-----------------------------------------------------------------------------------	-----------------------------------------------------------------------------------	-------------------------------------------------------------------------------------	-------------------------------------------------------------------------------------	--------------	------------------------------------------------	------------------------------------------------------------------------------------------------------------------

SAAB

9-5 Break (YS3E) (98-)	3,0 t		10.1998		24.0325-0142.1	525142	POWER-DISC	5055389 , 4567798 , 9184405 , 5 69 061 , 9194477 , 5391560	
	3,0 TiD		07.2001		24.0325-0142.1	525142	POWER-DISC	5055389 , 4567798 , 9184405 , 5 69 061 , 9194477 , 5391560	
9-5 Berlina (YS3E) (97-)	2,3 T		07.2003		24.0325-0142.1	525142	POWER-DISC	5055389 , 4567798 , 9184405 , 5 69 061 , 9194477 , 5391560	
			11.2005		24.0325-0142.1	525142	POWER-DISC	5055389 , 4567798 , 9184405 , 5 69 061 , 9194477 , 5391560	
	2,3 T Aero		09.2001		24.0325-0142.1	525142	POWER-DISC	5055389 , 4567798 , 9184405 , 5 69 061 , 9194477 , 5391560	
			04.2003	03.2004	24.0325-0142.1	525142	POWER-DISC	5055389 , 4567798 , 9184405 , 5 69 061 , 9194477 , 5391560	
			10.1999	09.2001	24.0325-0142.1	525142	POWER-DISC	5055389 , 4567798 , 9184405 , 5 69 061 , 9194477 , 5391560	
	3,0 t		01.1998		24.0325-0142.1	525142	POWER-DISC	5055389 , 4567798 , 9184405 , 5 69 061 , 9194477 , 5391560	
	3,0 TiD		07.2001		24.0325-0142.1	525142	POWER-DISC	5055389 , 4567798 , 9184405 , 5 69 061 , 9194477 , 5391560	



					Denominación	Ref. OE correspondientes a las referencias ATE		Referencia anterior / varios
--	--	--	--	--	--------------	------------------------------------------------	--	------------------------------

SEAT

Modelo	Motor	Transmisión	Fecha	ATE	ATE	Denominación	Ref. OE correspondientes a las referencias ATE	Referencia anterior / varios
ALTEA (5P1) (04-)	1,4 i 16V	TI	05.2006	24.3384-1755.7	220635	PINZA DE GARRA	1K0 615 423 D , 1K0 615 423 J , 1K0 615 423 A	
		TD	05.2006	24.3384-1756.7	220636	PINZA DE GARRA	1K0 615 424 D , 1K0 615 424 J , 1K0 615 424 A	
			05.2006	24.0325-0158.1	525158	POWER-DISC	1K0 615 301 AA	
	1,4 TSI	TD	11.2007	24.3384-1756.7	220636	PINZA DE GARRA	1K0 615 424 D , 1K0 615 424 J , 1K0 615 424 A	
		TI	11.2007	24.3384-1755.7	220635	PINZA DE GARRA	1K0 615 423 D , 1K0 615 423 J , 1K0 615 423 A	
			11.2007	24.0325-0158.1	525158	POWER-DISC	1K0 615 301 AA	
	1,6 i 16V	TD	03.2004	24.3384-1756.7	220636	PINZA DE GARRA	1K0 615 424 D , 1K0 615 424 J , 1K0 615 424 A	
		TI	03.2004	24.3384-1755.7	220635	PINZA DE GARRA	1K0 615 423 D , 1K0 615 423 J , 1K0 615 423 A	
			03.2004	24.0325-0158.1	525158	POWER-DISC	1K0 615 301 AA	
	1,8 TFSI	TI	01.2007	24.3384-1755.7	220635	PINZA DE GARRA	1K0 615 423 D , 1K0 615 423 J , 1K0 615 423 A	
		TD	01.2007	24.3384-1756.7	220636	PINZA DE GARRA	1K0 615 424 D , 1K0 615 424 J , 1K0 615 424 A	
			01.2007	24.0325-0158.1	525158	POWER-DISC	1K0 615 301 AA	
	1,9 TDI	TD	03.2004	24.3384-1756.7	220636	PINZA DE GARRA	1K0 615 424 D , 1K0 615 424 J , 1K0 615 424 A	
		TI	03.2004	24.3384-1755.7	220635	PINZA DE GARRA	1K0 615 423 D , 1K0 615 423 J , 1K0 615 423 A	
			03.2004	24.0325-0158.1	525158	POWER-DISC	1K0 615 301 AA	



					Denominación	Ref. OE correspondientes a las referencias ATE		Referencia anterior / varios
--	--	--	--	--	--------------	------------------------------------------------	--	------------------------------

SEAT

Modelo	Motor	Transmisión	Fecha	Ref. ATE	Ref. OE	Denominación	Ref. OE correspondientes a las referencias ATE	Referencia anterior / varios
ALTEA (5P1) (04-)	2,0 FSI	TD	03.2004	24.3384-1756.7	220636	PINZA DE GARRA	1K0 615 424 D , 1K0 615 424 J , 1K0 615 424 A	
		TI	03.2004	24.3384-1755.7	220635	PINZA DE GARRA	1K0 615 423 D , 1K0 615 423 J , 1K0 615 423 A	
			03.2004	24.0325-0158.1	525158	POWER-DISC	1K0 615 301 AA	
	2,0 i 16V	TD	03.2004	24.3384-1756.7	220636	PINZA DE GARRA	1K0 615 424 D , 1K0 615 424 J , 1K0 615 424 A	
		TI	03.2004	24.3384-1755.7	220635	PINZA DE GARRA	1K0 615 423 D , 1K0 615 423 J , 1K0 615 423 A	
			03.2004	24.0325-0158.1	525158	POWER-DISC	1K0 615 301 AA	
	2,0 TDI	TI	03.2006	24.3384-1755.7	220635	PINZA DE GARRA	1K0 615 423 D , 1K0 615 423 J , 1K0 615 423 A	
		TD	03.2006	24.3384-1756.7	220636	PINZA DE GARRA	1K0 615 424 D , 1K0 615 424 J , 1K0 615 424 A	
		TD	03.2004	24.3384-1756.7	220636	PINZA DE GARRA	1K0 615 424 D , 1K0 615 424 J , 1K0 615 424 A	
		TI	03.2004	24.3384-1755.7	220635	PINZA DE GARRA	1K0 615 423 D , 1K0 615 423 J , 1K0 615 423 A	
			03.2004	24.0325-0158.1	525158	POWER-DISC	1K0 615 301 AA	
			03.2006	24.0325-0158.1	525158	POWER-DISC	1K0 615 301 AA	
	2,0 TFSI	TI	03.2006	24.3384-1755.7	220635	PINZA DE GARRA	1K0 615 423 D , 1K0 615 423 J , 1K0 615 423 A	
		TD	03.2006	24.3384-1756.7	220636	PINZA DE GARRA	1K0 615 424 D , 1K0 615 424 J , 1K0 615 424 A	
			03.2006	24.0325-0158.1	525158	POWER-DISC	1K0 615 301 AA	



					Denominación	Ref. OE correspondientes a las referencias ATE		Referencia anterior / varios
--	--	--	--	--	--------------	------------------------------------------------	--	------------------------------

SEAT

Modelo	Motor	Tracción	Fecha	ATE Ref.	ATE Ref.	Denominación	Ref. OE correspondientes a las referencias ATE	Referencia anterior / varios
ALTEA XL (5P5) (06-)	1,4 i 16V	TD	05.2008	24.3384-1756.7	220636	PINZA DE GARRA	1K0 615 424 D , 1K0 615 424 J , 1K0 615 424 A	
		TI	05.2008	24.3384-1755.7	220635	PINZA DE GARRA	1K0 615 423 D , 1K0 615 423 J , 1K0 615 423 A	
			05.2008	24.0325-0158.1	525158	POWER-DISC	1K0 615 301 AA	
	1,4 TSI	TI	11.2007	24.3384-1755.7	220635	PINZA DE GARRA	1K0 615 423 D , 1K0 615 423 J , 1K0 615 423 A	
		TD	11.2007	24.3384-1756.7	220636	PINZA DE GARRA	1K0 615 424 D , 1K0 615 424 J , 1K0 615 424 A	
			11.2007	24.0325-0158.1	525158	POWER-DISC	1K0 615 301 AA	
	1,6 i 16V	TI	10.2006	24.3384-1755.7	220635	PINZA DE GARRA	1K0 615 423 D , 1K0 615 423 J , 1K0 615 423 A	
		TD	10.2006	24.3384-1756.7	220636	PINZA DE GARRA	1K0 615 424 D , 1K0 615 424 J , 1K0 615 424 A	
			10.2006	24.0325-0158.1	525158	POWER-DISC	1K0 615 301 AA	
	1,8 TFSI	TD	10.2006	24.3384-1756.7	220636	PINZA DE GARRA	1K0 615 424 D , 1K0 615 424 J , 1K0 615 424 A	
		TI	10.2006	24.3384-1755.7	220635	PINZA DE GARRA	1K0 615 423 D , 1K0 615 423 J , 1K0 615 423 A	
			10.2006	24.0325-0158.1	525158	POWER-DISC	1K0 615 301 AA	
	1,9 TDI	TD	10.2006	24.3384-1756.7	220636	PINZA DE GARRA	1K0 615 424 D , 1K0 615 424 J , 1K0 615 424 A	
		TI	10.2006	24.3384-1755.7	220635	PINZA DE GARRA	1K0 615 423 D , 1K0 615 423 J , 1K0 615 423 A	
			10.2006	24.0325-0158.1	525158	POWER-DISC	1K0 615 301 AA	



					Denominación	Ref. OE correspondientes a las referencias ATE		Referencia anterior / varios
--	--	--	--	--	--------------	------------------------------------------------	--	------------------------------

SEAT

Modelo	Motor	Transmisión	Fecha	Ref. ATE	Ref. OE	Denominación	Ref. OE correspondientes a las referencias ATE	Referencia anterior / varios
ALTEA XL (5P5) (06-)	2,0 FSI	TI	10.2006	24.3384-1755.7	220635	PINZA DE GARRA	1K0 615 423 D , 1K0 615 423 J , 1K0 615 423 A	
		TD	10.2006	24.3384-1756.7	220636	PINZA DE GARRA	1K0 615 424 D , 1K0 615 424 J , 1K0 615 424 A	
			10.2006	24.0325-0158.1	525158	POWER-DISC	1K0 615 301 AA	
	2,0 TDI	TI	10.2006	24.3384-1755.7	220635	PINZA DE GARRA	1K0 615 423 D , 1K0 615 423 J , 1K0 615 423 A	
		TD	10.2006	24.3384-1756.7	220636	PINZA DE GARRA	1K0 615 424 D , 1K0 615 424 J , 1K0 615 424 A	
			10.2006	24.0325-0158.1	525158	POWER-DISC	1K0 615 301 AA	
	2,0 TDI 4x4	TI	06.2007	24.3384-1755.7	220635	PINZA DE GARRA	1K0 615 423 D , 1K0 615 423 J , 1K0 615 423 A	
		TD	06.2007	24.3384-1756.7	220636	PINZA DE GARRA	1K0 615 424 D , 1K0 615 424 J , 1K0 615 424 A	
			06.2007	24.0325-0158.1	525158	POWER-DISC	1K0 615 301 AA	
	2,0 TFSI 4x4	TD	06.2007	24.3384-1756.7	220636	PINZA DE GARRA	1K0 615 424 D , 1K0 615 424 J , 1K0 615 424 A	
		TI	06.2007	24.3384-1755.7	220635	PINZA DE GARRA	1K0 615 423 D , 1K0 615 423 J , 1K0 615 423 A	
			06.2007	24.0325-0158.1	525158	POWER-DISC	1K0 615 301 AA	
LEON II (1P1) (05-)	1,4 i 16V	TD	06.2006	24.3384-1756.7	220636	PINZA DE GARRA	1K0 615 424 D , 1K0 615 424 J , 1K0 615 424 A	
		TI	08.2005	24.3384-1755.7	220635	PINZA DE GARRA	1K0 615 423 D , 1K0 615 423 J , 1K0 615 423 A	
		TD	08.2005	24.3384-1756.7	220636	PINZA DE GARRA	1K0 615 424 D , 1K0 615 424 J , 1K0 615 424 A	



					Denominación	Ref. OE correspondientes a las referencias ATE		Referencia anterior / varios
--	--	--	--	--	--------------	------------------------------------------------	--	------------------------------

SEAT

Modelo	Motor	Transmisión	Fecha	ATE	ATE	Denominación	Ref. OE correspondientes a las referencias ATE	Referencia anterior / varios
LEON II (1P1) (05-)	1,4 i 16V	TI	06.2006	24.3384-1755.7	220635	PINZA DE GARRA	1K0 615 423 D , 1K0 615 423 J , 1K0 615 423 A	
			06.2006	24.0325-0158.1	525158	POWER-DISC	1K0 615 301 AA	
			08.2005	24.0325-0158.1	525158	POWER-DISC	1K0 615 301 AA	
	1,4 TSI	TD	11.2007	24.3384-1756.7	220636	PINZA DE GARRA	1K0 615 424 D , 1K0 615 424 J , 1K0 615 424 A	
		TI	11.2007	24.3384-1755.7	220635	PINZA DE GARRA	1K0 615 423 D , 1K0 615 423 J , 1K0 615 423 A	
			11.2007	24.0325-0158.1	525158	POWER-DISC	1K0 615 301 AA	
	1,6 i	TD	08.2005	24.3384-1756.7	220636	PINZA DE GARRA	1K0 615 424 D , 1K0 615 424 J , 1K0 615 424 A	
		TI	08.2005	24.3384-1755.7	220635	PINZA DE GARRA	1K0 615 423 D , 1K0 615 423 J , 1K0 615 423 A	
			08.2005	24.0325-0158.1	525158	POWER-DISC	1K0 615 301 AA	
	1,6 i 16V	TI	08.2005	24.3384-1755.7	220635	PINZA DE GARRA	1K0 615 423 D , 1K0 615 423 J , 1K0 615 423 A	
		TD	08.2005	24.3384-1756.7	220636	PINZA DE GARRA	1K0 615 424 D , 1K0 615 424 J , 1K0 615 424 A	
			08.2005	24.0325-0158.1	525158	POWER-DISC	1K0 615 301 AA	
	1,8 T 20V	TD	08.2005	24.3384-1756.7	220636	PINZA DE GARRA	1K0 615 424 D , 1K0 615 424 J , 1K0 615 424 A	
		TI	08.2005	24.3384-1755.7	220635	PINZA DE GARRA	1K0 615 423 D , 1K0 615 423 J , 1K0 615 423 A	
			08.2005	24.0325-0158.1	525158	POWER-DISC	1K0 615 301 AA	



					Denominación	Ref. OE correspondientes a las referencias ATE		Referencia anterior / varios
--	--	--	--	--	--------------	------------------------------------------------	--	------------------------------

SEAT

Modelo	Motor	Transmisión	Fecha	ATE	ATE	Denominación	Ref. OE correspondientes a las referencias ATE	Referencia anterior / varios
LEON II (1P1) (05-)	1,8 TFSI	TD	06.2007	24.3384-1756.7	220636	PINZA DE GARRA	1K0 615 424 D , 1K0 615 424 J , 1K0 615 424 A	
		TI	06.2007	24.3384-1755.7	220635	PINZA DE GARRA	1K0 615 423 D , 1K0 615 423 J , 1K0 615 423 A	
			06.2007	24.0325-0158.1	525158	POWER-DISC	1K0 615 301 AA	
	1,9 TDI	TI	08.2005	24.3384-1755.7	220635	PINZA DE GARRA	1K0 615 423 D , 1K0 615 423 J , 1K0 615 423 A	
		TD	08.2005	24.3384-1756.7	220636	PINZA DE GARRA	1K0 615 424 D , 1K0 615 424 J , 1K0 615 424 A	
			08.2005	24.0325-0158.1	525158	POWER-DISC	1K0 615 301 AA	
	2,0 FSI	TD	08.2005	24.3384-1756.7	220636	PINZA DE GARRA	1K0 615 424 D , 1K0 615 424 J , 1K0 615 424 A	
		TI	08.2005	24.3384-1755.7	220635	PINZA DE GARRA	1K0 615 423 D , 1K0 615 423 J , 1K0 615 423 A	
			08.2005	24.0325-0158.1	525158	POWER-DISC	1K0 615 301 AA	
	2,0 i 16V	TD	08.2005	24.3384-1756.7	220636	PINZA DE GARRA	1K0 615 424 D , 1K0 615 424 J , 1K0 615 424 A	
		TI	08.2005	24.3384-1755.7	220635	PINZA DE GARRA	1K0 615 423 D , 1K0 615 423 J , 1K0 615 423 A	
			08.2005	24.0325-0158.1	525158	POWER-DISC	1K0 615 301 AA	
	2,0 TDI	TD	02.2006	24.3384-1756.7	220636	PINZA DE GARRA	1K0 615 424 D , 1K0 615 424 J , 1K0 615 424 A	
		TD	08.2005	24.3384-1756.7	220636	PINZA DE GARRA	1K0 615 424 D , 1K0 615 424 J , 1K0 615 424 A	
		TI	08.2005	24.3384-1755.7	220635	PINZA DE GARRA	1K0 615 423 D , 1K0 615 423 J , 1K0 615 423 A	









					Denominación	Ref. OE correspondientes a las referencias ATE		Referencia anterior / varios
--	--	--	--	--	--------------	------------------------------------------------	--	------------------------------

SEAT

LEON II (1P1) (05-)	2,0 TDI	TI	02.2006		24.3384-1755.7	220635	PINZA DE GARRA	1K0 615 423 D , 1K0 615 423 J , 1K0 615 423 A	
			02.2006		24.0325-0158.1	525158	POWER-DISC	1K0 615 301 AA	
			08.2005		24.0325-0158.1	525158	POWER-DISC	1K0 615 301 AA	
	2,0 TFSI	TD	09.2005		24.3384-1756.7	220636	PINZA DE GARRA	1K0 615 424 D , 1K0 615 424 J , 1K0 615 424 A	
		TD	11.2006		24.3384-1756.7	220636	PINZA DE GARRA	1K0 615 424 D , 1K0 615 424 J , 1K0 615 424 A	
		TD	08.2005		24.3384-1756.7	220636	PINZA DE GARRA	1K0 615 424 D , 1K0 615 424 J , 1K0 615 424 A	
		TI	08.2005		24.3384-1755.7	220635	PINZA DE GARRA	1K0 615 423 D , 1K0 615 423 J , 1K0 615 423 A	
		TI	11.2006		24.3384-1755.7	220635	PINZA DE GARRA	1K0 615 423 D , 1K0 615 423 J , 1K0 615 423 A	
		TI	09.2005		24.3384-1755.7	220635	PINZA DE GARRA	1K0 615 423 D , 1K0 615 423 J , 1K0 615 423 A	
			09.2005		24.0325-0158.1	525158	POWER-DISC	1K0 615 301 AA	
			08.2005		24.0325-0158.1	525158	POWER-DISC	1K0 615 301 AA	
			11.2006		24.0325-0158.1	525158	POWER-DISC	1K0 615 301 AA	
TOLEDO III (5P2) (05-)	1,6 i 16V	TD	10.2004		24.3384-1756.7	220636	PINZA DE GARRA	1K0 615 424 D , 1K0 615 424 J , 1K0 615 424 A	
		TI	10.2004		24.3384-1755.7	220635	PINZA DE GARRA	1K0 615 423 D , 1K0 615 423 J , 1K0 615 423 A	
	1,8 TFSI	TD	01.2007		24.3384-1756.7	220636	PINZA DE GARRA	1K0 615 424 D , 1K0 615 424 J , 1K0 615 424 A	



					Denominación	Ref. OE correspondientes a las referencias ATE	 Referencia anterior / varios
-----------------------------------------------------------------------------------	-----------------------------------------------------------------------------------	-----------------------------------------------------------------------------------	-------------------------------------------------------------------------------------	-------------------------------------------------------------------------------------	--------------	------------------------------------------------	---------------------------------------------------------------------------------------------------------------------

SEAT

Modelo	Motor	Transmisión	Fecha	Ref. ATE	Ref. OE	Denominación	Ref. OE correspondientes a las referencias ATE	Referencia anterior / varios
TOLEDO III (5P2) (05-)	1,8 TFSI	TI	01.2007	24.3384-1755.7	220635	PINZA DE GARRA	1K0 615 423 D , 1K0 615 423 J , 1K0 615 423 A	
	1,9 TDI	TI	10.2004	24.3384-1755.7	220635	PINZA DE GARRA	1K0 615 423 D , 1K0 615 423 J , 1K0 615 423 A	
		TD	10.2004	24.3384-1756.7	220636	PINZA DE GARRA	1K0 615 424 D , 1K0 615 424 J , 1K0 615 424 A	
	2,0 FSI	TD	10.2004	24.3384-1756.7	220636	PINZA DE GARRA	1K0 615 424 D , 1K0 615 424 J , 1K0 615 424 A	
		TI	10.2004	24.3384-1755.7	220635	PINZA DE GARRA	1K0 615 423 D , 1K0 615 423 J , 1K0 615 423 A	
	2,0 i 16V	TI	10.2004	24.3384-1755.7	220635	PINZA DE GARRA	1K0 615 423 D , 1K0 615 423 J , 1K0 615 423 A	
		TD	10.2004	24.3384-1756.7	220636	PINZA DE GARRA	1K0 615 424 D , 1K0 615 424 J , 1K0 615 424 A	
	2,0 TDI	TD	10.2004	24.3384-1756.7	220636	PINZA DE GARRA	1K0 615 424 D , 1K0 615 424 J , 1K0 615 424 A	
		TI	10.2004	24.3384-1755.7	220635	PINZA DE GARRA	1K0 615 423 D , 1K0 615 423 J , 1K0 615 423 A	
		TI	01.2006	24.3384-1755.7	220635	PINZA DE GARRA	1K0 615 423 D , 1K0 615 423 J , 1K0 615 423 A	
		TD	01.2006	24.3384-1756.7	220636	PINZA DE GARRA	1K0 615 424 D , 1K0 615 424 J , 1K0 615 424 A	
	2,0 TFSI	TD	11.2005	24.3384-1756.7	220636	PINZA DE GARRA	1K0 615 424 D , 1K0 615 424 J , 1K0 615 424 A	
		TI	11.2005	24.3384-1755.7	220635	PINZA DE GARRA	1K0 615 423 D , 1K0 615 423 J , 1K0 615 423 A	



					Denominación	Ref. OE correspondientes a las referencias ATE		Referencia anterior / varios
--	--	--	--	--	--------------	------------------------------------------------	--	------------------------------

SKODA

OCTAVIA II (1Z) (04-)	1,4 i 16V	TD	06.2004		24.3384-1756.7	220636	PINZA DE GARRA	1K0 615 424 D , 1K0 615 424 J , 1K0 615 424 A
		TD	06.2004		24.3414-1710.7	220632	PINZA DE GARRA	1K0 615 424 C , 1K0 615 424 H , 1K0 615 424 F , 1K0 615 424
		TI	06.2004		24.3384-1755.7	220635	PINZA DE GARRA	1K0 615 423 D , 1K0 615 423 J , 1K0 615 423 A
		TI	06.2004		24.3414-1709.7	220631	PINZA DE GARRA	1K0 615 423 C , 1K0 615 423 H , 1K0 615 423 F , 1K0 615 423
	1,6 FSI	TD	06.2004		24.3384-1756.7	220636	PINZA DE GARRA	1K0 615 424 D , 1K0 615 424 J , 1K0 615 424 A
		TI	06.2004		24.3414-1709.7	220631	PINZA DE GARRA	1K0 615 423 C , 1K0 615 423 H , 1K0 615 423 F , 1K0 615 423
		TD	06.2004		24.3414-1710.7	220632	PINZA DE GARRA	1K0 615 424 C , 1K0 615 424 H , 1K0 615 424 F , 1K0 615 424
		TI	06.2004		24.3384-1755.7	220635	PINZA DE GARRA	1K0 615 423 D , 1K0 615 423 J , 1K0 615 423 A
	1,6 i 16V	TI	06.2004		24.3414-1709.7	220631	PINZA DE GARRA	1K0 615 423 C , 1K0 615 423 H , 1K0 615 423 F , 1K0 615 423
		TD	06.2004		24.3414-1710.7	220632	PINZA DE GARRA	1K0 615 424 C , 1K0 615 424 H , 1K0 615 424 F , 1K0 615 424
		TI	06.2004		24.3384-1755.7	220635	PINZA DE GARRA	1K0 615 423 D , 1K0 615 423 J , 1K0 615 423 A



					Denominación	Ref. OE correspondientes a las referencias ATE		Referencia anterior / varios
--	--	--	--	--	--------------	------------------------------------------------	--	------------------------------

SKODA

OCTAVIA II (1Z) (04-)	1,6 i 16V	TD	06.2004		24.3384-1756.7	220636	PINZA DE GARRA	1K0 615 424 D , 1K0 615 424 J , 1K0 615 424 A	
	1,9 TDI	TD	06.2004		24.3414-1710.7	220632	PINZA DE GARRA	1K0 615 424 C , 1K0 615 424 H , 1K0 615 424 F , 1K0 615 424	
		TI	06.2004		24.3414-1709.7	220631	PINZA DE GARRA	1K0 615 423 C , 1K0 615 423 H , 1K0 615 423 F , 1K0 615 423	
		TI	06.2004		24.3384-1755.7	220635	PINZA DE GARRA	1K0 615 423 D , 1K0 615 423 J , 1K0 615 423 A	
		TD	06.2004		24.3384-1756.7	220636	PINZA DE GARRA	1K0 615 424 D , 1K0 615 424 J , 1K0 615 424 A	
	2,0 FSI	TD	11.2004		24.3384-1756.7	220636	PINZA DE GARRA	1K0 615 424 D , 1K0 615 424 J , 1K0 615 424 A	
		TI	11.2004		24.3414-1709.7	220631	PINZA DE GARRA	1K0 615 423 C , 1K0 615 423 H , 1K0 615 423 F , 1K0 615 423	
		TI	11.2004		24.3384-1755.7	220635	PINZA DE GARRA	1K0 615 423 D , 1K0 615 423 J , 1K0 615 423 A	
		TD	11.2004		24.3414-1710.7	220632	PINZA DE GARRA	1K0 615 424 C , 1K0 615 424 H , 1K0 615 424 F , 1K0 615 424	
	2,0 TDI	TD	06.2004		24.3384-1756.7	220636	PINZA DE GARRA	1K0 615 424 D , 1K0 615 424 J , 1K0 615 424 A	
		TI	06.2004		24.3384-1755.7	220635	PINZA DE GARRA	1K0 615 423 D , 1K0 615 423 J , 1K0 615 423 A	
		TI	06.2004		24.3414-1709.7	220631	PINZA DE GARRA	1K0 615 423 C , 1K0 615 423 H , 1K0 615 423 F , 1K0 615 423	



					Denominación	Ref. OE correspondientes a las referencias ATE		Referencia anterior / varios
--	--	--	--	--	--------------	------------------------------------------------	--	------------------------------

SKODA

OCTAVIA II (1Z) (04-)	2,0 TDI	TD	06.2004		24.3414-1710.7	220632	PINZA DE GARRA	1K0 615 424 C , 1K0 615 424 H , 1K0 615 424 F , 1K0 615 424	
	RS 2,0 TFSI		10.2005		24.0325-0158.1	525158	POWER-DISC	1K0 615 301 AA	
SUPERB I (3U4) (02-08)	1,8 i 20V Turbo		12.2001	02.2008	83.7812-0180.3	330854	LATIGUILLO	8D0 611 775 E , 4E0 611 775 F , 8E0 611 775	83.6212-0180.3
	1,9 TDI		10.2005	12.2007	83.7812-0180.3	330854	LATIGUILLO	8D0 611 775 E , 4E0 611 775 F , 8E0 611 775	83.6212-0180.3
			08.2002	12.2007	83.7812-0180.3	330854	LATIGUILLO	8D0 611 775 E , 4E0 611 775 F , 8E0 611 775	83.6212-0180.3
			01.2007	12.2007	83.7812-0180.3	330854	LATIGUILLO	8D0 611 775 E , 4E0 611 775 F , 8E0 611 775	83.6212-0180.3
			12.2001	12.2007	83.7812-0180.3	330854	LATIGUILLO	8D0 611 775 E , 4E0 611 775 F , 8E0 611 775	83.6212-0180.3
	2,0 i		12.2001	02.2008	83.7812-0180.3	330854	LATIGUILLO	8D0 611 775 E , 4E0 611 775 F , 8E0 611 775	83.6212-0180.3
	2,0 TDI		10.2005	12.2007	83.7812-0180.3	330854	LATIGUILLO	8D0 611 775 E , 4E0 611 775 F , 8E0 611 775	83.6212-0180.3
				12.2007	24.0325-0158.1	525158	POWER-DISC	1K0 615 301 AA	
	2,5 TDI		06.2003	12.2007	83.7812-0180.3	330854	LATIGUILLO	8D0 611 775 E , 4E0 611 775 F , 8E0 611 775	83.6212-0180.3
			12.2001	12.2007	83.7812-0180.3	330854	LATIGUILLO	8D0 611 775 E , 4E0 611 775 F , 8E0 611 775	83.6212-0180.3
				12.2007	24.0325-0158.1	525158	POWER-DISC	1K0 615 301 AA	
	2,8 i V6		12.2001	12.2007	83.7812-0180.3	330854	LATIGUILLO	8D0 611 775 E , 4E0 611 775 F , 8E0 611 775	83.6212-0180.3



					Denominación	Ref. OE correspondientes a las referencias ATE		Referencia anterior / varios
--	--	--	--	--	--------------	------------------------------------------------	--	------------------------------

SKODA

SUPERB I (3U4) (02-08)	2,8 i V6			12.2007	24.0325-0158.1	525158	POWER-DISC	1K0 615 301 AA	
------------------------	----------	--	--	---------	----------------	--------	------------	----------------	--

TOYOTA

CARINA E (92-97)	1,6 i (AT190)	DD	02.1992	09.1997	24.3571-1714.5	240202	PINZA DE GARRA	47730-20480	
		DI	02.1992	09.1997	24.3571-1713.5	240201	PINZA DE GARRA	47750-20480	
	1,8 i (AT191)	DD	02.1992	09.1997	24.3571-1714.5	240202	PINZA DE GARRA	47730-20480	
		DI	02.1992	09.1997	24.3571-1713.5	240201	PINZA DE GARRA	47750-20480	
	2,0 D (CT190)	DD	02.1992	09.1997	24.3571-1714.5	240202	PINZA DE GARRA	47730-20480	
		DI	02.1992	09.1997	24.3571-1713.5	240201	PINZA DE GARRA	47750-20480	
CELICA (93-99)	1,8 i (AT200)	DI	11.1993	11.1999	24.3571-1713.5	240201	PINZA DE GARRA	47750-20480	
		DD	11.1993	11.1999	24.3571-1714.5	240202	PINZA DE GARRA	47730-20480	
LAND CRUISER 120 (03-)	3,0 D-4D		01.2005		24.0128-0194.1	428194	DISCO DE FRENO	43512-60150 , 43512-60151	
			01.2003		24.0128-0194.1	428194	DISCO DE FRENO	43512-60150 , 43512-60151	
	4,0 VVTi		01.2003		24.0128-0194.1	428194	DISCO DE FRENO	43512-60150 , 43512-60151	
YARIS (06-)	1,0 VVT-i		01.2006		24.0122-0246.1	422246	DISCO DE FRENO	43512-52120	
	1,3 VVT-i		01.2006		24.0122-0246.1	422246	DISCO DE FRENO	43512-52120	
	1,4 D-4D		01.2006		24.0122-0246.1	422246	DISCO DE FRENO	43512-52120	



					Denominación	Ref. OE correspondientes a las referencias ATE		Referencia anterior / varios
--	--	--	--	--	--------------	------------------------------------------------	--	------------------------------

VOLKSWAGEN

CADDY III (04-)	1,4		02.2004		24.0325-0158.1	525158	POWER-DISC	1K0 615 301 AA	
	1,4 16V		05.2006		24.0325-0158.1	525158	POWER-DISC	1K0 615 301 AA	
	1,6		04.2004		24.0325-0158.1	525158	POWER-DISC	1K0 615 301 AA	
	1,9 TDI		02.2004		24.0325-0158.1	525158	POWER-DISC	1K0 615 301 AA	
			09.2005		24.0325-0158.1	525158	POWER-DISC	1K0 615 301 AA	
	2,0 Eco Fuel		04.2006		24.0325-0158.1	525158	POWER-DISC	1K0 615 301 AA	
	2,0 SDI		02.2004		24.0325-0158.1	525158	POWER-DISC	1K0 615 301 AA	
	2,0 TDI		09.2007		24.0325-0158.1	525158	POWER-DISC	1K0 615 301 AA	
CRAFTER (06-)	2,5 TDI		04.2006		24.0128-0203.1	428203	DISCO DE FRENO	906 421 00 12 , 2E0 615 301	
			04.2006		24.0128-0202.1	428202	DISCO DE FRENO	906 423 01 12 , 2E0 615 601	
EOS (06-)	1,4 TSI	TD	10.2007		24.3384-1756.7	220636	PINZA DE GARRA	1K0 615 424 D , 1K0 615 424 J , 1K0 615 424 A	
		TI	10.2007		24.3414-1709.7	220631	PINZA DE GARRA	1K0 615 423 C , 1K0 615 423 H , 1K0 615 423 F , 1K0 615 423	
		TD	10.2007		24.3414-1710.7	220632	PINZA DE GARRA	1K0 615 424 C , 1K0 615 424 H , 1K0 615 424 F , 1K0 615 424	
		TI	10.2007		24.3384-1755.7	220635	PINZA DE GARRA	1K0 615 423 D , 1K0 615 423 J , 1K0 615 423 A	
			10.2007		24.0325-0158.1	525158	POWER-DISC	1K0 615 301 AA	
	1,6 FSI	TI	05.2006		24.3384-1755.7	220635	PINZA DE GARRA	1K0 615 423 D , 1K0 615 423 J , 1K0 615 423 A	



					Denominación	Ref. OE correspondientes a las referencias ATE		Referencia anterior / varios
--	--	--	--	--	--------------	------------------------------------------------	--	------------------------------

VOLKSWAGEN

EOS (06-)	1,6 FSI	TI	05.2006		24.3414-1709.7	220631	PINZA DE GARRA	1K0 615 423 C , 1K0 615 423 H , 1K0 615 423 F , 1K0 615 423	
		TD	05.2006		24.3384-1756.7	220636	PINZA DE GARRA	1K0 615 424 D , 1K0 615 424 J , 1K0 615 424 A	
		TD	05.2006		24.3414-1710.7	220632	PINZA DE GARRA	1K0 615 424 C , 1K0 615 424 H , 1K0 615 424 F , 1K0 615 424	
			05.2006		24.0325-0158.1	525158	POWER-DISC	1K0 615 301 AA	
	2,0 FSI	TD	05.2006		24.3414-1710.7	220632	PINZA DE GARRA	1K0 615 424 C , 1K0 615 424 H , 1K0 615 424 F , 1K0 615 424	
		TD	05.2006		24.3384-1756.7	220636	PINZA DE GARRA	1K0 615 424 D , 1K0 615 424 J , 1K0 615 424 A	
		TI	05.2006		24.3384-1755.7	220635	PINZA DE GARRA	1K0 615 423 D , 1K0 615 423 J , 1K0 615 423 A	
		TI	05.2006		24.3414-1709.7	220631	PINZA DE GARRA	1K0 615 423 C , 1K0 615 423 H , 1K0 615 423 F , 1K0 615 423	
			05.2006		24.0325-0158.1	525158	POWER-DISC	1K0 615 301 AA	
	2,0 TDI	TD	05.2006		24.3384-1756.7	220636	PINZA DE GARRA	1K0 615 424 D , 1K0 615 424 J , 1K0 615 424 A	
		TI	05.2006		24.3384-1755.7	220635	PINZA DE GARRA	1K0 615 423 D , 1K0 615 423 J , 1K0 615 423 A	
		TI	05.2006		24.3414-1709.7	220631	PINZA DE GARRA	1K0 615 423 C , 1K0 615 423 H , 1K0 615 423 F , 1K0 615 423	









					Denominación	Ref. OE correspondientes a las referencias ATE		Referencia anterior / varios
--	--	--	--	--	--------------	------------------------------------------------	--	------------------------------

VOLKSWAGEN

EOS (06-)	2,0 TDI	TD	05.2006		24.3414-1710.7	220632	PINZA DE GARRA	1K0 615 424 C , 1K0 615 424 H , 1K0 615 424 F , 1K0 615 424	
			05.2006		24.0325-0158.1	525158	POWER-DISC	1K0 615 301 AA	
	2,0 TFSI	TD	05.2006		24.3384-1756.7	220636	PINZA DE GARRA	1K0 615 424 D , 1K0 615 424 J , 1K0 615 424 A	
		TI	05.2006		24.3384-1755.7	220635	PINZA DE GARRA	1K0 615 423 D , 1K0 615 423 J , 1K0 615 423 A	
		TI	05.2006		24.3414-1709.7	220631	PINZA DE GARRA	1K0 615 423 C , 1K0 615 423 H , 1K0 615 423 F , 1K0 615 423	
		TD	05.2006		24.3414-1710.7	220632	PINZA DE GARRA	1K0 615 424 C , 1K0 615 424 H , 1K0 615 424 F , 1K0 615 424	
			05.2006		24.0325-0158.1	525158	POWER-DISC	1K0 615 301 AA	
	3,2 V6	TD	05.2006		24.3384-1756.7	220636	PINZA DE GARRA	1K0 615 424 D , 1K0 615 424 J , 1K0 615 424 A	
		TI	05.2006		24.3414-1709.7	220631	PINZA DE GARRA	1K0 615 423 C , 1K0 615 423 H , 1K0 615 423 F , 1K0 615 423	
		TI	05.2006		24.3384-1755.7	220635	PINZA DE GARRA	1K0 615 423 D , 1K0 615 423 J , 1K0 615 423 A	
		TD	05.2006		24.3414-1710.7	220632	PINZA DE GARRA	1K0 615 424 C , 1K0 615 424 H , 1K0 615 424 F , 1K0 615 424	
			05.2006		24.0325-0158.1	525158	POWER-DISC	1K0 615 301 AA	



					Denominación	Ref. OE correspondientes a las referencias ATE	 Referencia anterior / varios
-----------------------------------------------------------------------------------	-----------------------------------------------------------------------------------	-----------------------------------------------------------------------------------	-------------------------------------------------------------------------------------	-------------------------------------------------------------------------------------	--------------	------------------------------------------------	---------------------------------------------------------------------------------------------------------------------

VOLKSWAGEN

Modelo	Motor	TI	Fecha	ATE	ATE	Denominación	Ref. OE correspondientes a las referencias ATE	Referencia anterior / varios
GOLF V (03-)	1,4 16V	TI	10.2003	24.3414-1709.7	220631	PINZA DE GARRA	1K0 615 423 C , 1K0 615 423 H , 1K0 615 423 F , 1K0 615 423	
		TD	10.2003	24.3384-1756.7	220636	PINZA DE GARRA	1K0 615 424 D , 1K0 615 424 J , 1K0 615 424 A	
		TD	10.2003	24.3414-1710.7	220632	PINZA DE GARRA	1K0 615 424 C , 1K0 615 424 H , 1K0 615 424 F , 1K0 615 424	
		TI	10.2003	24.3384-1755.7	220635	PINZA DE GARRA	1K0 615 423 D , 1K0 615 423 J , 1K0 615 423 A	
			10.2003	24.0325-0158.1	525158	POWER-DISC	1K0 615 301 AA	
	1,4 FSI	TI	10.2003	24.3414-1709.7	220631	PINZA DE GARRA	1K0 615 423 C , 1K0 615 423 H , 1K0 615 423 F , 1K0 615 423	
		TI	10.2003	24.3384-1755.7	220635	PINZA DE GARRA	1K0 615 423 D , 1K0 615 423 J , 1K0 615 423 A	
		TD	10.2003	24.3414-1710.7	220632	PINZA DE GARRA	1K0 615 424 C , 1K0 615 424 H , 1K0 615 424 F , 1K0 615 424	
		TD	10.2003	24.3384-1756.7	220636	PINZA DE GARRA	1K0 615 424 D , 1K0 615 424 J , 1K0 615 424 A	
			10.2003	24.0325-0158.1	525158	POWER-DISC	1K0 615 301 AA	
	1,4 TSI	TD	05.2007	24.3414-1710.7	220632	PINZA DE GARRA	1K0 615 424 C , 1K0 615 424 H , 1K0 615 424 F , 1K0 615 424	
		TD	05.2006	24.3414-1710.7	220632	PINZA DE GARRA	1K0 615 424 C , 1K0 615 424 H , 1K0 615 424 F , 1K0 615 424	



					Denominación	Ref. OE correspondientes a las referencias ATE		Referencia anterior / varios
--	--	--	--	--	--------------	------------------------------------------------	--	------------------------------

VOLKSWAGEN

GOLF V (03-)	1,4 TSI	TI	05.2006		24.3414-1709.7	220631	PINZA DE GARRA	1K0 615 423 C , 1K0 615 423 H , 1K0 615 423 F , 1K0 615 423	
		TI	05.2007		24.3414-1709.7	220631	PINZA DE GARRA	1K0 615 423 C , 1K0 615 423 H , 1K0 615 423 F , 1K0 615 423	
		TI	11.2005		24.3414-1709.7	220631	PINZA DE GARRA	1K0 615 423 C , 1K0 615 423 H , 1K0 615 423 F , 1K0 615 423	
		TI	11.2005		24.3384-1755.7	220635	PINZA DE GARRA	1K0 615 423 D , 1K0 615 423 J , 1K0 615 423 A	
		TD	05.2007		24.3384-1756.7	220636	PINZA DE GARRA	1K0 615 424 D , 1K0 615 424 J , 1K0 615 424 A	
		TD	11.2005		24.3414-1710.7	220632	PINZA DE GARRA	1K0 615 424 C , 1K0 615 424 H , 1K0 615 424 F , 1K0 615 424	
		TD	05.2006		24.3384-1756.7	220636	PINZA DE GARRA	1K0 615 424 D , 1K0 615 424 J , 1K0 615 424 A	
		TI	05.2006		24.3384-1755.7	220635	PINZA DE GARRA	1K0 615 423 D , 1K0 615 423 J , 1K0 615 423 A	
		TD	11.2005		24.3384-1756.7	220636	PINZA DE GARRA	1K0 615 424 D , 1K0 615 424 J , 1K0 615 424 A	
		TI	05.2007		24.3384-1755.7	220635	PINZA DE GARRA	1K0 615 423 D , 1K0 615 423 J , 1K0 615 423 A	
			05.2007		24.0325-0158.1	525158	POWER-DISC	1K0 615 301 AA	
			11.2005		24.0325-0158.1	525158	POWER-DISC	1K0 615 301 AA	
			05.2006		24.0325-0158.1	525158	POWER-DISC	1K0 615 301 AA	

Nuevas referencias en almacén - Por aplicación

09/2008



					Denominación	Ref. OE correspondientes a las referencias ATE		Referencia anterior / varios
--	--	--	--	--	--------------	------------------------------------------------	--	------------------------------

VOLKSWAGEN

GOLF V (03-)	1,6 16V	TI	01.2004		24.3384-1755.7	220635	PINZA DE GARRA	1K0 615 423 D , 1K0 615 423 J , 1K0 615 423 A	
		TI	01.2004		24.3414-1709.7	220631	PINZA DE GARRA	1K0 615 423 C , 1K0 615 423 H , 1K0 615 423 F , 1K0 615 423	
		TD	01.2004		24.3384-1756.7	220636	PINZA DE GARRA	1K0 615 424 D , 1K0 615 424 J , 1K0 615 424 A	
		TD	01.2004		24.3414-1710.7	220632	PINZA DE GARRA	1K0 615 424 C , 1K0 615 424 H , 1K0 615 424 F , 1K0 615 424	
			01.2004		24.0325-0158.1	525158	POWER-DISC	1K0 615 301 AA	
	1,6 FSI	TI	10.2003		24.3384-1755.7	220635	PINZA DE GARRA	1K0 615 423 D , 1K0 615 423 J , 1K0 615 423 A	
		TD	10.2003		24.3384-1756.7	220636	PINZA DE GARRA	1K0 615 424 D , 1K0 615 424 J , 1K0 615 424 A	
		TD	10.2003		24.3414-1710.7	220632	PINZA DE GARRA	1K0 615 424 C , 1K0 615 424 H , 1K0 615 424 F , 1K0 615 424	
		TI	10.2003		24.3414-1709.7	220631	PINZA DE GARRA	1K0 615 423 C , 1K0 615 423 H , 1K0 615 423 F , 1K0 615 423	
			10.2003		24.0325-0158.1	525158	POWER-DISC	1K0 615 301 AA	
	1,9 TDI	TD	05.2004		24.3384-1756.7	220636	PINZA DE GARRA	1K0 615 424 D , 1K0 615 424 J , 1K0 615 424 A	
		TD	10.2003		24.3384-1756.7	220636	PINZA DE GARRA	1K0 615 424 D , 1K0 615 424 J , 1K0 615 424 A	

Nuevas referencias en almacén - Por aplicación

09/2008



					Denominación	Ref. OE correspondientes a las referencias ATE		Referencia anterior / varios
--	--	--	--	--	--------------	------------------------------------------------	--	------------------------------

VOLKSWAGEN

GOLF V (03-)	1,9 TDI	TI	05.2004		24.3414-1709.7	220631	PINZA DE GARRA	1K0 615 423 C , 1K0 615 423 H , 1K0 615 423 F , 1K0 615 423	
		TI	10.2003		24.3414-1709.7	220631	PINZA DE GARRA	1K0 615 423 C , 1K0 615 423 H , 1K0 615 423 F , 1K0 615 423	
		TI	05.2004		24.3384-1755.7	220635	PINZA DE GARRA	1K0 615 423 D , 1K0 615 423 J , 1K0 615 423 A	
		TD	05.2004		24.3414-1710.7	220632	PINZA DE GARRA	1K0 615 424 C , 1K0 615 424 H , 1K0 615 424 F , 1K0 615 424	
		TD	10.2003		24.3414-1710.7	220632	PINZA DE GARRA	1K0 615 424 C , 1K0 615 424 H , 1K0 615 424 F , 1K0 615 424	
		TI	10.2003		24.3384-1755.7	220635	PINZA DE GARRA	1K0 615 423 D , 1K0 615 423 J , 1K0 615 423 A	
			05.2004		24.0325-0158.1	525158	POWER-DISC	1K0 615 301 AA	
			10.2003		24.0325-0158.1	525158	POWER-DISC	1K0 615 301 AA	
	1,9 TDI 4motion	TD	08.2004		24.3414-1710.7	220632	PINZA DE GARRA	1K0 615 424 C , 1K0 615 424 H , 1K0 615 424 F , 1K0 615 424	
		TI	08.2004		24.3414-1709.7	220631	PINZA DE GARRA	1K0 615 423 C , 1K0 615 423 H , 1K0 615 423 F , 1K0 615 423	
			08.2004		24.0325-0158.1	525158	POWER-DISC	1K0 615 301 AA	
	2,0 FSI	TD	10.2003		24.3414-1710.7	220632	PINZA DE GARRA	1K0 615 424 C , 1K0 615 424 H , 1K0 615 424 F , 1K0 615 424	









					Denominación	Ref. OE correspondientes a las referencias ATE		Referencia anterior / varios
--	--	--	--	--	--------------	------------------------------------------------	--	------------------------------

VOLKSWAGEN

GOLF V (03-)	2,0 FSI	TD	10.2003		24.3384-1756.7	220636	PINZA DE GARRA	1K0 615 424 D , 1K0 615 424 J , 1K0 615 424 A	
		TI	10.2003		24.3384-1755.7	220635	PINZA DE GARRA	1K0 615 423 D , 1K0 615 423 J , 1K0 615 423 A	
		TI	10.2003		24.3414-1709.7	220631	PINZA DE GARRA	1K0 615 423 C , 1K0 615 423 H , 1K0 615 423 F , 1K0 615 423	
			10.2003		24.0325-0158.1	525158	POWER-DISC	1K0 615 301 AA	
	2,0 FSI 4motion	TD	08.2004		24.3414-1710.7	220632	PINZA DE GARRA	1K0 615 424 C , 1K0 615 424 H , 1K0 615 424 F , 1K0 615 424	
		TI	08.2004		24.3414-1709.7	220631	PINZA DE GARRA	1K0 615 423 C , 1K0 615 423 H , 1K0 615 423 F , 1K0 615 423	
			08.2004		24.0325-0158.1	525158	POWER-DISC	1K0 615 301 AA	
	2,0 GTI	TI	09.2006		24.3384-1755.7	220635	PINZA DE GARRA	1K0 615 423 D , 1K0 615 423 J , 1K0 615 423 A	
		TD	09.2004		24.3384-1756.7	220636	PINZA DE GARRA	1K0 615 424 D , 1K0 615 424 J , 1K0 615 424 A	
		TD	09.2004		24.3414-1710.7	220632	PINZA DE GARRA	1K0 615 424 C , 1K0 615 424 H , 1K0 615 424 F , 1K0 615 424	
		TD	09.2006		24.3384-1756.7	220636	PINZA DE GARRA	1K0 615 424 D , 1K0 615 424 J , 1K0 615 424 A	
		TI	09.2006		24.3414-1709.7	220631	PINZA DE GARRA	1K0 615 423 C , 1K0 615 423 H , 1K0 615 423 F , 1K0 615 423	



					Denominación	Ref. OE correspondientes a las referencias ATE	 Referencia anterior / varios
-----------------------------------------------------------------------------------	-----------------------------------------------------------------------------------	-----------------------------------------------------------------------------------	-------------------------------------------------------------------------------------	-------------------------------------------------------------------------------------	--------------	------------------------------------------------	------------------------------------------------------------------------------------------------------------------

VOLKSWAGEN

GOLF V (03-)	2,0 GTI	TI	09.2004		24.3384-1755.7	220635	PINZA DE GARRA	1K0 615 423 D , 1K0 615 423 J , 1K0 615 423 A	
		TI	09.2004		24.3414-1709.7	220631	PINZA DE GARRA	1K0 615 423 C , 1K0 615 423 H , 1K0 615 423 F , 1K0 615 423	
		TD	09.2006		24.3414-1710.7	220632	PINZA DE GARRA	1K0 615 424 C , 1K0 615 424 H , 1K0 615 424 F , 1K0 615 424	
			09.2006		24.0325-0158.1	525158	POWER-DISC	1K0 615 301 AA	
			09.2004		24.0325-0158.1	525158	POWER-DISC	1K0 615 301 AA	
	2,0 SDI	TI	01.2004		24.3384-1755.7	220635	PINZA DE GARRA	1K0 615 423 D , 1K0 615 423 J , 1K0 615 423 A	
		TI	01.2004		24.3414-1709.7	220631	PINZA DE GARRA	1K0 615 423 C , 1K0 615 423 H , 1K0 615 423 F , 1K0 615 423	
		TD	01.2004		24.3384-1756.7	220636	PINZA DE GARRA	1K0 615 424 D , 1K0 615 424 J , 1K0 615 424 A	
		TD	01.2004		24.3414-1710.7	220632	PINZA DE GARRA	1K0 615 424 C , 1K0 615 424 H , 1K0 615 424 F , 1K0 615 424	
			01.2004		24.0325-0158.1	525158	POWER-DISC	1K0 615 301 AA	
	2,0 TDI	TI	11.2005		24.3414-1709.7	220631	PINZA DE GARRA	1K0 615 423 C , 1K0 615 423 H , 1K0 615 423 F , 1K0 615 423	
		TD	10.2003		24.3384-1756.7	220636	PINZA DE GARRA	1K0 615 424 D , 1K0 615 424 J , 1K0 615 424 A	
		TD	11.2005		24.3384-1756.7	220636	PINZA DE GARRA	1K0 615 424 D , 1K0 615 424 J , 1K0 615 424 A	



					Denominación	Ref. OE correspondientes a las referencias ATE		Referencia anterior / varios
--	--	--	--	--	--------------	------------------------------------------------	--	------------------------------

VOLKSWAGEN

GOLF V (03-)	2,0 TDI	TI	10.2003		24.3384-1755.7	220635	PINZA DE GARRA	1K0 615 423 D , 1K0 615 423 J , 1K0 615 423 A	
		TD	10.2003		24.3414-1710.7	220632	PINZA DE GARRA	1K0 615 424 C , 1K0 615 424 H , 1K0 615 424 F , 1K0 615 424	
		TI	10.2003		24.3414-1709.7	220631	PINZA DE GARRA	1K0 615 423 C , 1K0 615 423 H , 1K0 615 423 F , 1K0 615 423	
		TI	11.2005		24.3384-1755.7	220635	PINZA DE GARRA	1K0 615 423 D , 1K0 615 423 J , 1K0 615 423 A	
		TD	11.2005		24.3414-1710.7	220632	PINZA DE GARRA	1K0 615 424 C , 1K0 615 424 H , 1K0 615 424 F , 1K0 615 424	
			11.2005		24.0325-0158.1	525158	POWER-DISC	1K0 615 301 AA	
			10.2003		24.0325-0158.1	525158	POWER-DISC	1K0 615 301 AA	
	2,0 TDI 4motion	TD	08.2004		24.3414-1710.7	220632	PINZA DE GARRA	1K0 615 424 C , 1K0 615 424 H , 1K0 615 424 F , 1K0 615 424	
		TI	08.2004		24.3414-1709.7	220631	PINZA DE GARRA	1K0 615 423 C , 1K0 615 423 H , 1K0 615 423 F , 1K0 615 423	
			08.2004		24.0325-0158.1	525158	POWER-DISC	1K0 615 301 AA	
	3,2 R32	TD	11.2005		24.3414-1710.7	220632	PINZA DE GARRA	1K0 615 424 C , 1K0 615 424 H , 1K0 615 424 F , 1K0 615 424	
		TI	11.2005		24.3414-1709.7	220631	PINZA DE GARRA	1K0 615 423 C , 1K0 615 423 H , 1K0 615 423 F , 1K0 615 423	



					Denominación	Ref. OE correspondientes a las referencias ATE		Referencia anterior / varios
--	--	--	--	--	--------------	------------------------------------------------	--	------------------------------

VOLKSWAGEN

GOLF V (03-)	3,2 R32		11.2005		24.0325-0158.1	525158	POWER-DISC	1K0 615 301 AA	
GOLF V Plus (05-)	1,4 16V	TI	01.2005		24.3384-1755.7	220635	PINZA DE GARRA	1K0 615 423 D , 1K0 615 423 J , 1K0 615 423 A	
		TD	01.2005		24.3384-1756.7	220636	PINZA DE GARRA	1K0 615 424 D , 1K0 615 424 J , 1K0 615 424 A	
		TI	01.2005		24.3414-1709.7	220631	PINZA DE GARRA	1K0 615 423 C , 1K0 615 423 H , 1K0 615 423 F , 1K0 615 423	
		TD	01.2005		24.3414-1710.7	220632	PINZA DE GARRA	1K0 615 424 C , 1K0 615 424 H , 1K0 615 424 F , 1K0 615 424	
			01.2005		24.0325-0158.1	525158	POWER-DISC	1K0 615 301 AA	
	1,4 TSI	TI	06.2007		24.3414-1709.7	220631	PINZA DE GARRA	1K0 615 423 C , 1K0 615 423 H , 1K0 615 423 F , 1K0 615 423	
		TI	06.2008		24.3414-1709.7	220631	PINZA DE GARRA	1K0 615 423 C , 1K0 615 423 H , 1K0 615 423 F , 1K0 615 423	
		TI	05.2006		24.3414-1709.7	220631	PINZA DE GARRA	1K0 615 423 C , 1K0 615 423 H , 1K0 615 423 F , 1K0 615 423	
		TI	06.2008		24.3384-1755.7	220635	PINZA DE GARRA	1K0 615 423 D , 1K0 615 423 J , 1K0 615 423 A	
		TI	05.2006		24.3384-1755.7	220635	PINZA DE GARRA	1K0 615 423 D , 1K0 615 423 J , 1K0 615 423 A	
		TD	05.2006		24.3414-1710.7	220632	PINZA DE GARRA	1K0 615 424 C , 1K0 615 424 H , 1K0 615 424 F , 1K0 615 424	



					Denominación	Ref. OE correspondientes a las referencias ATE		Referencia anterior / varios
--	--	--	--	--	--------------	------------------------------------------------	--	------------------------------

VOLKSWAGEN

GOLF V Plus (05-)	1,4 TSI	TD	06.2007		24.3414-1710.7	220632	PINZA DE GARRA	1K0 615 424 C , 1K0 615 424 H , 1K0 615 424 F , 1K0 615 424	
		TD	06.2008		24.3414-1710.7	220632	PINZA DE GARRA	1K0 615 424 C , 1K0 615 424 H , 1K0 615 424 F , 1K0 615 424	
		TD	05.2006		24.3384-1756.7	220636	PINZA DE GARRA	1K0 615 424 D , 1K0 615 424 J , 1K0 615 424 A	
		TD	06.2007		24.3384-1756.7	220636	PINZA DE GARRA	1K0 615 424 D , 1K0 615 424 J , 1K0 615 424 A	
		TD	06.2008		24.3384-1756.7	220636	PINZA DE GARRA	1K0 615 424 D , 1K0 615 424 J , 1K0 615 424 A	
		TI	06.2007		24.3384-1755.7	220635	PINZA DE GARRA	1K0 615 423 D , 1K0 615 423 J , 1K0 615 423 A	
			06.2008		24.0325-0158.1	525158	POWER-DISC	1K0 615 301 AA	
			05.2006		24.0325-0158.1	525158	POWER-DISC	1K0 615 301 AA	
			06.2007		24.0325-0158.1	525158	POWER-DISC	1K0 615 301 AA	
	1,6	TD	05.2005		24.3384-1756.7	220636	PINZA DE GARRA	1K0 615 424 D , 1K0 615 424 J , 1K0 615 424 A	
		TI	05.2005		24.3384-1755.7	220635	PINZA DE GARRA	1K0 615 423 D , 1K0 615 423 J , 1K0 615 423 A	
		TD	05.2005		24.3414-1710.7	220632	PINZA DE GARRA	1K0 615 424 C , 1K0 615 424 H , 1K0 615 424 F , 1K0 615 424	
		TI	05.2005		24.3414-1709.7	220631	PINZA DE GARRA	1K0 615 423 C , 1K0 615 423 H , 1K0 615 423 F , 1K0 615 423	



					Denominación	Ref. OE correspondientes a las referencias ATE		Referencia anterior / varios
--	--	--	--	--	--------------	------------------------------------------------	--	------------------------------

VOLKSWAGEN

Modelo	Motor	Transmisión	Fecha	ATE Ref.	ATE Ref.	Denominación	Ref. OE correspondientes a las referencias ATE	Referencia anterior / varios
GOLF V Plus (05-)	1,6		05.2005	24.0325-0158.1	525158	POWER-DISC	1K0 615 301 AA	
	1,6 FSI	TD	01.2005	24.3414-1710.7	220632	PINZA DE GARRA	1K0 615 424 C , 1K0 615 424 H , 1K0 615 424 F , 1K0 615 424	
		TI	01.2005	24.3414-1709.7	220631	PINZA DE GARRA	1K0 615 423 C , 1K0 615 423 H , 1K0 615 423 F , 1K0 615 423	
		TD	01.2005	24.3384-1756.7	220636	PINZA DE GARRA	1K0 615 424 D , 1K0 615 424 J , 1K0 615 424 A	
		TI	01.2005	24.3384-1755.7	220635	PINZA DE GARRA	1K0 615 423 D , 1K0 615 423 J , 1K0 615 423 A	
			01.2005	24.0325-0158.1	525158	POWER-DISC	1K0 615 301 AA	
	1,9 TDI	TD	01.2005	24.3384-1756.7	220636	PINZA DE GARRA	1K0 615 424 D , 1K0 615 424 J , 1K0 615 424 A	
		TD	05.2005	24.3384-1756.7	220636	PINZA DE GARRA	1K0 615 424 D , 1K0 615 424 J , 1K0 615 424 A	
		TD	05.2005	24.3414-1710.7	220632	PINZA DE GARRA	1K0 615 424 C , 1K0 615 424 H , 1K0 615 424 F , 1K0 615 424	
		TD	01.2005	24.3414-1710.7	220632	PINZA DE GARRA	1K0 615 424 C , 1K0 615 424 H , 1K0 615 424 F , 1K0 615 424	
		TI	05.2005	24.3384-1755.7	220635	PINZA DE GARRA	1K0 615 423 D , 1K0 615 423 J , 1K0 615 423 A	
		TI	01.2005	24.3414-1709.7	220631	PINZA DE GARRA	1K0 615 423 C , 1K0 615 423 H , 1K0 615 423 F , 1K0 615 423	



					Denominación	Ref. OE correspondientes a las referencias ATE		Referencia anterior / varios
--	--	--	--	--	--------------	------------------------------------------------	--	------------------------------

VOLKSWAGEN

GOLF V Plus (05-)	1,9 TDI	TI	05.2005		24.3414-1709.7	220631	PINZA DE GARRA	1K0 615 423 C , 1K0 615 423 H , 1K0 615 423 F , 1K0 615 423	
		TI	01.2005		24.3384-1755.7	220635	PINZA DE GARRA	1K0 615 423 D , 1K0 615 423 J , 1K0 615 423 A	
			05.2005		24.0325-0158.1	525158	POWER-DISC	1K0 615 301 AA	
			01.2005		24.0325-0158.1	525158	POWER-DISC	1K0 615 301 AA	
	2,0 FSI	TI	05.2005		24.3384-1755.7	220635	PINZA DE GARRA	1K0 615 423 D , 1K0 615 423 J , 1K0 615 423 A	
		TI	05.2005		24.3414-1709.7	220631	PINZA DE GARRA	1K0 615 423 C , 1K0 615 423 H , 1K0 615 423 F , 1K0 615 423	
		TD	05.2005		24.3384-1756.7	220636	PINZA DE GARRA	1K0 615 424 D , 1K0 615 424 J , 1K0 615 424 A	
		TD	05.2005		24.3414-1710.7	220632	PINZA DE GARRA	1K0 615 424 C , 1K0 615 424 H , 1K0 615 424 F , 1K0 615 424	
			05.2005		24.0325-0158.1	525158	POWER-DISC	1K0 615 301 AA	
	2,0 TDI	TI	01.2005		24.3414-1709.7	220631	PINZA DE GARRA	1K0 615 423 C , 1K0 615 423 H , 1K0 615 423 F , 1K0 615 423	
		TD	01.2005		24.3414-1710.7	220632	PINZA DE GARRA	1K0 615 424 C , 1K0 615 424 H , 1K0 615 424 F , 1K0 615 424	
		TD	05.2005		24.3414-1710.7	220632	PINZA DE GARRA	1K0 615 424 C , 1K0 615 424 H , 1K0 615 424 F , 1K0 615 424	



					Denominación	Ref. OE correspondientes a las referencias ATE		Referencia anterior / varios
--	--	--	--	--	--------------	------------------------------------------------	--	------------------------------

VOLKSWAGEN

Modelo	Motor	Transmisión	Fecha	Ref. ATE	Ref. OE	Denominación	Ref. OE correspondientes a las referencias ATE	Referencia anterior / varios
GOLF V Plus (05-)	2,0 TDI	TI	05.2005	24.3384-1755.7	220635	PINZA DE GARRA	1K0 615 423 D , 1K0 615 423 J , 1K0 615 423 A	
		TI	01.2005	24.3384-1755.7	220635	PINZA DE GARRA	1K0 615 423 D , 1K0 615 423 J , 1K0 615 423 A	
		TD	01.2005	24.3384-1756.7	220636	PINZA DE GARRA	1K0 615 424 D , 1K0 615 424 J , 1K0 615 424 A	
		TD	05.2005	24.3384-1756.7	220636	PINZA DE GARRA	1K0 615 424 D , 1K0 615 424 J , 1K0 615 424 A	
		TI	05.2005	24.3414-1709.7	220631	PINZA DE GARRA	1K0 615 423 C , 1K0 615 423 H , 1K0 615 423 F , 1K0 615 423	
			01.2005	24.0325-0158.1	525158	POWER-DISC	1K0 615 301 AA	
			05.2005	24.0325-0158.1	525158	POWER-DISC	1K0 615 301 AA	
GOLF V Variant (07-)	1,4		06.2007	24.0325-0158.1	525158	POWER-DISC	1K0 615 301 AA	
	1,4 TSI		07.2008	24.0325-0158.1	525158	POWER-DISC	1K0 615 301 AA	
			06.2007	24.0325-0158.1	525158	POWER-DISC	1K0 615 301 AA	
			05.2007	24.0325-0158.1	525158	POWER-DISC	1K0 615 301 AA	
	1,6		05.2007	24.0325-0158.1	525158	POWER-DISC	1K0 615 301 AA	
	1,9 TDI		05.2007	24.0325-0158.1	525158	POWER-DISC	1K0 615 301 AA	
	1,9 TDI 4motion		12.2007	24.0325-0158.1	525158	POWER-DISC	1K0 615 301 AA	
	2		06.2007	24.0325-0158.1	525158	POWER-DISC	1K0 615 301 AA	
	2,0 TDI		05.2007	24.0325-0158.1	525158	POWER-DISC	1K0 615 301 AA	



				Denominación	Ref. OE correspondientes a las referencias ATE		Referencia anterior / varios
--	--	--	--	--------------	------------------------------------------------	--	------------------------------

VOLKSWAGEN

JETTA III (05-)	1,4 TSI	TI	06.2006		24.3414-1709.7	220631	PINZA DE GARRA	1K0 615 423 C , 1K0 615 423 H , 1K0 615 423 F , 1K0 615 423	
		TD	06.2006		24.3414-1710.7	220632	PINZA DE GARRA	1K0 615 424 C , 1K0 615 424 H , 1K0 615 424 F , 1K0 615 424	
		TI	05.2007		24.3414-1709.7	220631	PINZA DE GARRA	1K0 615 423 C , 1K0 615 423 H , 1K0 615 423 F , 1K0 615 423	
		TD	05.2007		24.3414-1710.7	220632	PINZA DE GARRA	1K0 615 424 C , 1K0 615 424 H , 1K0 615 424 F , 1K0 615 424	
			06.2006		24.0325-0158.1	525158	POWER-DISC	1K0 615 301 AA	
			05.2007		24.0325-0158.1	525158	POWER-DISC	1K0 615 301 AA	
	1,6 FSI	TD	08.2005		24.3414-1710.7	220632	PINZA DE GARRA	1K0 615 424 C , 1K0 615 424 H , 1K0 615 424 F , 1K0 615 424	
		TI	08.2005		24.3414-1709.7	220631	PINZA DE GARRA	1K0 615 423 C , 1K0 615 423 H , 1K0 615 423 F , 1K0 615 423	
			08.2005		24.0325-0158.1	525158	POWER-DISC	1K0 615 301 AA	
	1,6 i 16V	TD	08.2005		24.3414-1710.7	220632	PINZA DE GARRA	1K0 615 424 C , 1K0 615 424 H , 1K0 615 424 F , 1K0 615 424	
		TI	08.2005		24.3414-1709.7	220631	PINZA DE GARRA	1K0 615 423 C , 1K0 615 423 H , 1K0 615 423 F , 1K0 615 423	
			08.2005		24.0325-0158.1	525158	POWER-DISC	1K0 615 301 AA	



					Denominación	Ref. OE correspondientes a las referencias ATE		Referencia anterior / varios
--	--	--	--	--	--------------	------------------------------------------------	--	------------------------------

VOLKSWAGEN

JETTA III (05-)	1,9 TDI	TD	08.2005		24.3414-1710.7	220632	PINZA DE GARRA	1K0 615 424 C , 1K0 615 424 H , 1K0 615 424 F , 1K0 615 424	
		TI	08.2005		24.3414-1709.7	220631	PINZA DE GARRA	1K0 615 423 C , 1K0 615 423 H , 1K0 615 423 F , 1K0 615 423	
			08.2005		24.0325-0158.1	525158	POWER-DISC	1K0 615 301 AA	
	2,0 FSI	TD	08.2005		24.3414-1710.7	220632	PINZA DE GARRA	1K0 615 424 C , 1K0 615 424 H , 1K0 615 424 F , 1K0 615 424	
		TI	08.2005		24.3414-1709.7	220631	PINZA DE GARRA	1K0 615 423 C , 1K0 615 423 H , 1K0 615 423 F , 1K0 615 423	
			08.2005		24.0325-0158.1	525158	POWER-DISC	1K0 615 301 AA	
	2,0 TDI	TI	09.2005		24.3414-1709.7	220631	PINZA DE GARRA	1K0 615 423 C , 1K0 615 423 H , 1K0 615 423 F , 1K0 615 423	
		TI	08.2005		24.3414-1709.7	220631	PINZA DE GARRA	1K0 615 423 C , 1K0 615 423 H , 1K0 615 423 F , 1K0 615 423	
		TI	06.2006		24.3414-1709.7	220631	PINZA DE GARRA	1K0 615 423 C , 1K0 615 423 H , 1K0 615 423 F , 1K0 615 423	
		TD	09.2005		24.3414-1710.7	220632	PINZA DE GARRA	1K0 615 424 C , 1K0 615 424 H , 1K0 615 424 F , 1K0 615 424	
		TD	08.2005		24.3414-1710.7	220632	PINZA DE GARRA	1K0 615 424 C , 1K0 615 424 H , 1K0 615 424 F , 1K0 615 424	



					Denominación	Ref. OE correspondientes a las referencias ATE		Referencia anterior / varios
--	--	--	--	--	--------------	------------------------------------------------	--	------------------------------

VOLKSWAGEN

JETTA III (05-)	2,0 TDI	TD	06.2006		24.3414-1710.7	220632	PINZA DE GARRA	1K0 615 424 C , 1K0 615 424 H , 1K0 615 424 F , 1K0 615 424	
			06.2006		24.0325-0158.1	525158	POWER-DISC	1K0 615 301 AA	
			08.2005		24.0325-0158.1	525158	POWER-DISC	1K0 615 301 AA	
			09.2005		24.0325-0158.1	525158	POWER-DISC	1K0 615 301 AA	
	2,0 TFSI	TI	10.2005		24.3414-1709.7	220631	PINZA DE GARRA	1K0 615 423 C , 1K0 615 423 H , 1K0 615 423 F , 1K0 615 423	
		TD	10.2005		24.3414-1710.7	220632	PINZA DE GARRA	1K0 615 424 C , 1K0 615 424 H , 1K0 615 424 F , 1K0 615 424	
			10.2005		24.0325-0158.1	525158	POWER-DISC	1K0 615 301 AA	
PASSAT (97-05)	1,6		10.1996	06.2005	83.7812-0180.3	330854	LATIGUILLO	8D0 611 775 E , 4E0 611 775 F , 8E0 611 775	83.6212-0180.3
	1,8		01.1997	09.2000	83.7812-0180.3	330854	LATIGUILLO	8D0 611 775 E , 4E0 611 775 F , 8E0 611 775	83.6212-0180.3
			10.1996	09.2000	83.7812-0180.3	330854	LATIGUILLO	8D0 611 775 E , 4E0 611 775 F , 8E0 611 775	83.6212-0180.3
	1,8 T		10.1996	06.2005	83.7812-0180.3	330854	LATIGUILLO	8D0 611 775 E , 4E0 611 775 F , 8E0 611 775	83.6212-0180.3
	1,9 TDI		10.2000	06.2005	83.7812-0180.3	330854	LATIGUILLO	8D0 611 775 E , 4E0 611 775 F , 8E0 611 775	83.6212-0180.3
			10.1996	09.2000	83.7812-0180.3	330854	LATIGUILLO	8D0 611 775 E , 4E0 611 775 F , 8E0 611 775	83.6212-0180.3
			08.1998	06.2005	83.7812-0180.3	330854	LATIGUILLO	8D0 611 775 E , 4E0 611 775 F , 8E0 611 775	83.6212-0180.3



					Denominación	Ref. OE correspondientes a las referencias ATE		Referencia anterior / varios
--	--	--	--	--	--------------	------------------------------------------------	--	------------------------------

VOLKSWAGEN

PASSAT (97-05)	1,9 TDI		10.1996	06.2005	83.7812-0180.3	330854	LATIGUILLO	8D0 611 775 E , 4E0 611 775 F , 8E0 611 775	83.6212-0180.3
	2		05.2002	06.2005	83.7812-0180.3	330854	LATIGUILLO	8D0 611 775 E , 4E0 611 775 F , 8E0 611 775	83.6212-0180.3
			10.2000	06.2005	83.7812-0180.3	330854	LATIGUILLO	8D0 611 775 E , 4E0 611 775 F , 8E0 611 775	83.6212-0180.3
	2,0 TDI		12.2003	06.2005	83.7812-0180.3	330854	LATIGUILLO	8D0 611 775 E , 4E0 611 775 F , 8E0 611 775	83.6212-0180.3
	2,3		10.1996	06.2005	83.7812-0180.3	330854	LATIGUILLO	8D0 611 775 E , 4E0 611 775 F , 8E0 611 775	83.6212-0180.3
	2,5 TDI		08.1998	06.2005	83.7812-0180.3	330854	LATIGUILLO	8D0 611 775 E , 4E0 611 775 F , 8E0 611 775	83.6212-0180.3
	2,8		08.1996	06.2005	83.7812-0180.3	330854	LATIGUILLO	8D0 611 775 E , 4E0 611 775 F , 8E0 611 775	83.6212-0180.3
			01.1997	06.2005	83.7812-0180.3	330854	LATIGUILLO	8D0 611 775 E , 4E0 611 775 F , 8E0 611 775	83.6212-0180.3
PASSAT Berlina (05-)	1,4 TSI		10.2007		24.0325-0158.1	525158	POWER-DISC	1K0 615 301 AA	
	1,6		03.2005		24.0325-0158.1	525158	POWER-DISC	1K0 615 301 AA	
	1,6 FSI		03.2005		24.0325-0158.1	525158	POWER-DISC	1K0 615 301 AA	
	1,8 TSI		10.2007		24.0325-0158.1	525158	POWER-DISC	1K0 615 301 AA	
	1,9 TDI		03.2005		24.0325-0158.1	525158	POWER-DISC	1K0 615 301 AA	
	2,0 FSI		03.2005		24.0325-0158.1	525158	POWER-DISC	1K0 615 301 AA	
	2,0 FSI 4motion		03.2005		24.0325-0158.1	525158	POWER-DISC	1K0 615 301 AA	
	2,0 TDI		08.2005		24.0325-0158.1	525158	POWER-DISC	1K0 615 301 AA	



					Denominación	Ref. OE correspondientes a las referencias ATE		Referencia anterior / varios
--	--	--	--	--	--------------	------------------------------------------------	--	------------------------------

VOLKSWAGEN

PASSAT Berlina (05-)	2,0 TDI		03.2005		24.0325-0158.1	525158	POWER-DISC	1K0 615 301 AA	
	2,0 TDI 4motion		03.2005		24.0325-0158.1	525158	POWER-DISC	1K0 615 301 AA	
	2,0 TFSI		03.2005		24.0325-0158.1	525158	POWER-DISC	1K0 615 301 AA	
	3,2 V6 FSI		11.2005		24.0325-0158.1	525158	POWER-DISC	1K0 615 301 AA	
	3,2 V6 FSI 4motion		09.2005		24.0325-0158.1	525158	POWER-DISC	1K0 615 301 AA	
	3,6 R36		04.2007		24.0325-0158.1	525158	POWER-DISC	1K0 615 301 AA	
PASSAT Variant (05-)	1,4 TSI		10.2007		24.0325-0158.1	525158	POWER-DISC	1K0 615 301 AA	
	1,6		07.2005		24.0325-0158.1	525158	POWER-DISC	1K0 615 301 AA	
	1,6 FSI		07.2005		24.0325-0158.1	525158	POWER-DISC	1K0 615 301 AA	
	1,8 TSI		10.2007		24.0325-0158.1	525158	POWER-DISC	1K0 615 301 AA	
	1,9 TDI		07.2005		24.0325-0158.1	525158	POWER-DISC	1K0 615 301 AA	
	2,0 FSI		07.2005		24.0325-0158.1	525158	POWER-DISC	1K0 615 301 AA	
	2,0 FSI 4motion		09.2005		24.0325-0158.1	525158	POWER-DISC	1K0 615 301 AA	
	2,0 TDI		07.2005		24.0325-0158.1	525158	POWER-DISC	1K0 615 301 AA	
	2,0 TDI 4motion		09.2005		24.0325-0158.1	525158	POWER-DISC	1K0 615 301 AA	
	2,0 TFSI		07.2005		24.0325-0158.1	525158	POWER-DISC	1K0 615 301 AA	
	3,2 V6 FSI		11.2005		24.0325-0158.1	525158	POWER-DISC	1K0 615 301 AA	
	3,2 V6 FSI 4motion		11.2005		24.0325-0158.1	525158	POWER-DISC	1K0 615 301 AA	
	3,6 R36		04.2007		24.0325-0158.1	525158	POWER-DISC	1K0 615 301 AA	



					Denominación	Ref. OE correspondientes a las referencias ATE		Referencia anterior / varios
--	--	--	--	--	--------------	------------------------------------------------	--	------------------------------

VOLKSWAGEN

SCIROCCO (08-)	1,4 TSI	TD	08.2008		24.3384-1756.7	220636	PINZA DE GARRA	1K0 615 424 D , 1K0 615 424 J , 1K0 615 424 A
		TI	08.2008		24.3384-1755.7	220635	PINZA DE GARRA	1K0 615 423 D , 1K0 615 423 J , 1K0 615 423 A
	2,0 TDI	TD	10.2008		24.3384-1756.7	220636	PINZA DE GARRA	1K0 615 424 D , 1K0 615 424 J , 1K0 615 424 A
		TI	10.2008		24.3384-1755.7	220635	PINZA DE GARRA	1K0 615 423 D , 1K0 615 423 J , 1K0 615 423 A
	2,0 TSI	TI	08.2008		24.3384-1755.7	220635	PINZA DE GARRA	1K0 615 423 D , 1K0 615 423 J , 1K0 615 423 A
		TD	08.2008		24.3384-1756.7	220636	PINZA DE GARRA	1K0 615 424 D , 1K0 615 424 J , 1K0 615 424 A
TOURAN (03-)	1,4 FSI	TI	01.2006		24.3414-1709.7	220631	PINZA DE GARRA	1K0 615 423 C , 1K0 615 423 H , 1K0 615 423 F , 1K0 615 423
		TD	01.2006		24.3414-1710.7	220632	PINZA DE GARRA	1K0 615 424 C , 1K0 615 424 H , 1K0 615 424 F , 1K0 615 424
			01.2006		24.0325-0158.1	525158	POWER-DISC	1K0 615 301 AA
	1,4 TSI	TI	09.2006		24.3414-1709.7	220631	PINZA DE GARRA	1K0 615 423 C , 1K0 615 423 H , 1K0 615 423 F , 1K0 615 423
		TD	09.2006		24.3414-1710.7	220632	PINZA DE GARRA	1K0 615 424 C , 1K0 615 424 H , 1K0 615 424 F , 1K0 615 424
		TI	11.2006		24.3414-1709.7	220631	PINZA DE GARRA	1K0 615 423 C , 1K0 615 423 H , 1K0 615 423 F , 1K0 615 423



					Denominación	Ref. OE correspondientes a las referencias ATE		Referencia anterior / varios
--	--	--	--	--	--------------	------------------------------------------------	--	------------------------------

VOLKSWAGEN

TOURAN (03-)	1,4 TSI	TD	11.2006		24.3414-1710.7	220632	PINZA DE GARRA	1K0 615 424 C , 1K0 615 424 H , 1K0 615 424 F , 1K0 615 424	
			09.2006		24.0325-0158.1	525158	POWER-DISC	1K0 615 301 AA	
			11.2006		24.0325-0158.1	525158	POWER-DISC	1K0 615 301 AA	
	1,6	TD	07.2003		24.3414-1710.7	220632	PINZA DE GARRA	1K0 615 424 C , 1K0 615 424 H , 1K0 615 424 F , 1K0 615 424	
		TI	07.2003		24.3414-1709.7	220631	PINZA DE GARRA	1K0 615 423 C , 1K0 615 423 H , 1K0 615 423 F , 1K0 615 423	
			07.2003		24.0325-0158.1	525158	POWER-DISC	1K0 615 301 AA	
	1,6 FSI	TD	02.2003		24.3414-1710.7	220632	PINZA DE GARRA	1K0 615 424 C , 1K0 615 424 H , 1K0 615 424 F , 1K0 615 424	
		TI	02.2003		24.3414-1709.7	220631	PINZA DE GARRA	1K0 615 423 C , 1K0 615 423 H , 1K0 615 423 F , 1K0 615 423	
			02.2003		24.0325-0158.1	525158	POWER-DISC	1K0 615 301 AA	
	1,9 TDI	TD	08.2003		24.3414-1710.7	220632	PINZA DE GARRA	1K0 615 424 C , 1K0 615 424 H , 1K0 615 424 F , 1K0 615 424	
		TI	02.2003		24.3414-1709.7	220631	PINZA DE GARRA	1K0 615 423 C , 1K0 615 423 H , 1K0 615 423 F , 1K0 615 423	
		TI	08.2003		24.3414-1709.7	220631	PINZA DE GARRA	1K0 615 423 C , 1K0 615 423 H , 1K0 615 423 F , 1K0 615 423	



					Denominación	Ref. OE correspondientes a las referencias ATE		Referencia anterior / varios
--	--	--	--	--	--------------	------------------------------------------------	--	------------------------------

VOLKSWAGEN

Modelo	Motor	TI	Fecha	Ref. ATE	Ref. OE	Denominación	Ref. OE correspondientes a las referencias ATE	Referencia anterior / varios
TOURAN (03-)	1,9 TDI	TI	11.2004	24.3414-1709.7	220631	PINZA DE GARRA	1K0 615 423 C , 1K0 615 423 H , 1K0 615 423 F , 1K0 615 423	
		TD	11.2004	24.3414-1710.7	220632	PINZA DE GARRA	1K0 615 424 C , 1K0 615 424 H , 1K0 615 424 F , 1K0 615 424	
		TD	02.2003	24.3414-1710.7	220632	PINZA DE GARRA	1K0 615 424 C , 1K0 615 424 H , 1K0 615 424 F , 1K0 615 424	
			02.2003	24.0325-0158.1	525158	POWER-DISC	1K0 615 301 AA	
			08.2003	24.0325-0158.1	525158	POWER-DISC	1K0 615 301 AA	
			11.2004	24.0325-0158.1	525158	POWER-DISC	1K0 615 301 AA	
	2,0 Eco Fuel	TI	02.2006	24.3414-1709.7	220631	PINZA DE GARRA	1K0 615 423 C , 1K0 615 423 H , 1K0 615 423 F , 1K0 615 423	
		TD	02.2006	24.3414-1710.7	220632	PINZA DE GARRA	1K0 615 424 C , 1K0 615 424 H , 1K0 615 424 F , 1K0 615 424	
			02.2006	24.0325-0158.1	525158	POWER-DISC	1K0 615 301 AA	
	2,0 FSI	TD	10.2003	24.3414-1710.7	220632	PINZA DE GARRA	1K0 615 424 C , 1K0 615 424 H , 1K0 615 424 F , 1K0 615 424	
		TI	10.2003	24.3414-1709.7	220631	PINZA DE GARRA	1K0 615 423 C , 1K0 615 423 H , 1K0 615 423 F , 1K0 615 423	
			10.2003	24.0325-0158.1	525158	POWER-DISC	1K0 615 301 AA	



					Denominación	Ref. OE correspondientes a las referencias ATE		Referencia anterior / varios
--	--	--	--	--	--------------	------------------------------------------------	--	------------------------------

VOLKSWAGEN

Modelo	Motor	Transmisión	Fecha	Referencia ATE	Referencia OE	Denominación	Ref. OE correspondientes a las referencias ATE	Referencia anterior / varios
TOURAN (03-)	2,0 TDI	TI	02.2003	24.3414-1709.7	220631	PINZA DE GARRA	1K0 615 423 C , 1K0 615 423 H , 1K0 615 423 F , 1K0 615 423	
		TD	02.2006	24.3414-1710.7	220632	PINZA DE GARRA	1K0 615 424 C , 1K0 615 424 H , 1K0 615 424 F , 1K0 615 424	
		TD	02.2003	24.3414-1710.7	220632	PINZA DE GARRA	1K0 615 424 C , 1K0 615 424 H , 1K0 615 424 F , 1K0 615 424	
		TI	02.2006	24.3414-1709.7	220631	PINZA DE GARRA	1K0 615 423 C , 1K0 615 423 H , 1K0 615 423 F , 1K0 615 423	
		TI	08.2003	24.3414-1709.7	220631	PINZA DE GARRA	1K0 615 423 C , 1K0 615 423 H , 1K0 615 423 F , 1K0 615 423	
		TD	08.2003	24.3414-1710.7	220632	PINZA DE GARRA	1K0 615 424 C , 1K0 615 424 H , 1K0 615 424 F , 1K0 615 424	
			02.2006	24.0325-0158.1	525158	POWER-DISC	1K0 615 301 AA	
			08.2003	24.0325-0158.1	525158	POWER-DISC	1K0 615 301 AA	
			02.2003	24.0325-0158.1	525158	POWER-DISC	1K0 615 301 AA	



13.0460-3849.2 603849

Aplicación:
FIAT ALBEA (02-)

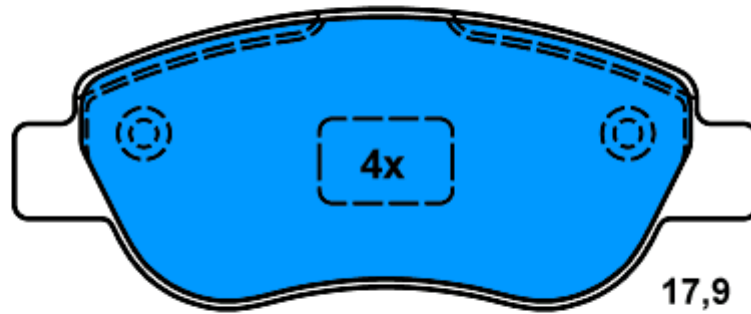
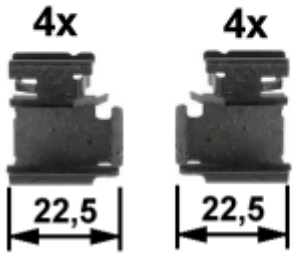

122,8 x 49,3

17,9



13.0460-5753.2 605753

Aplicación:
HONDA CR-V III (07-)

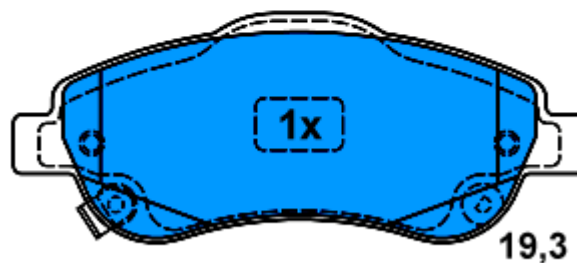
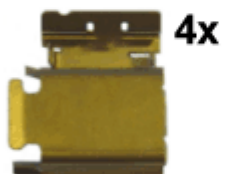
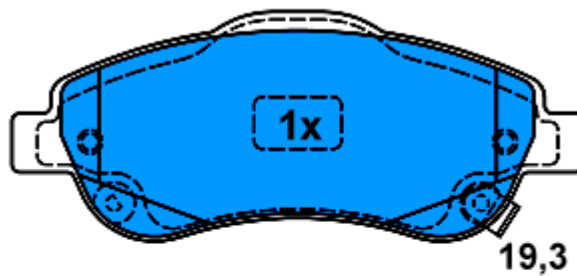
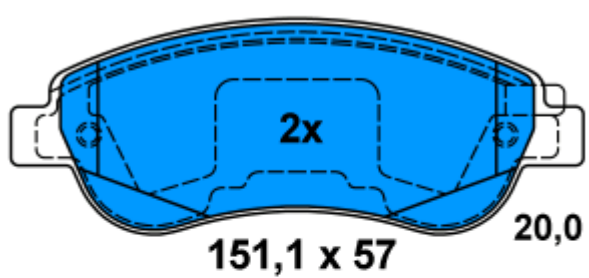



13.0460-5754.2 605754

Aplicación:
HONDA CR-V III (07-)

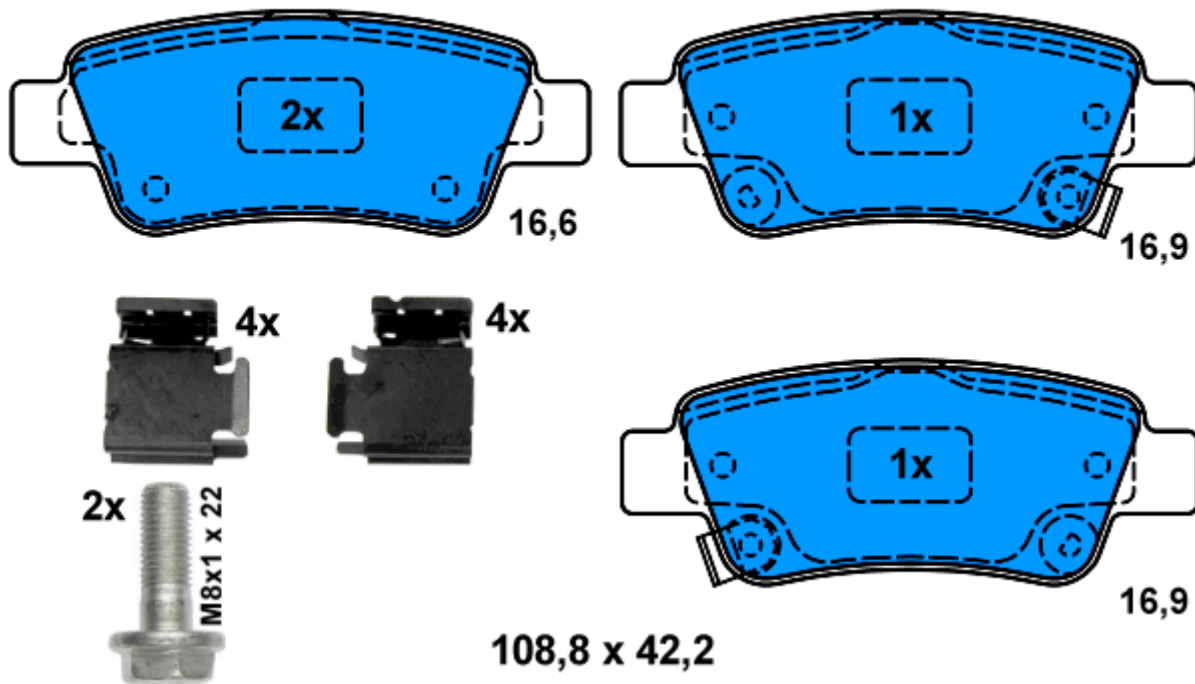

Ate

13.0460-7239.2 607239

Aplicación:

BMW X5 (07-)
BMW X6 (08-)

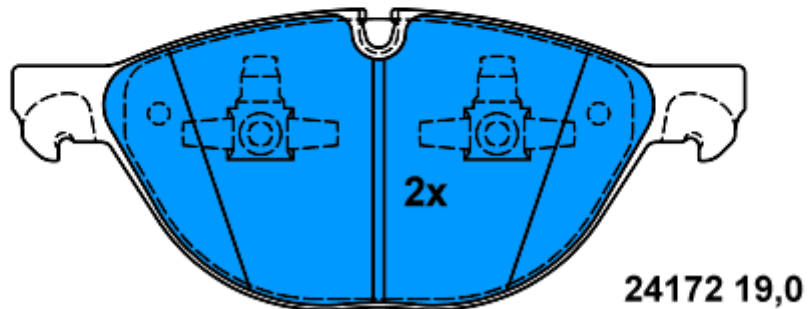
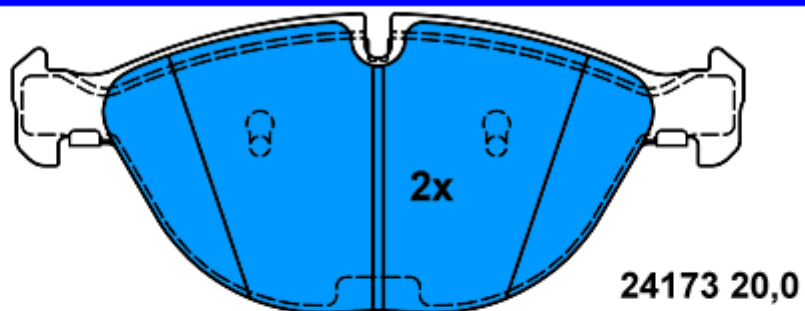

193 x 79



13.0460-3837.2 603837

Aplicación:

MERCEDES BENZ Transporter (BM 906) SPRINTER (06-)

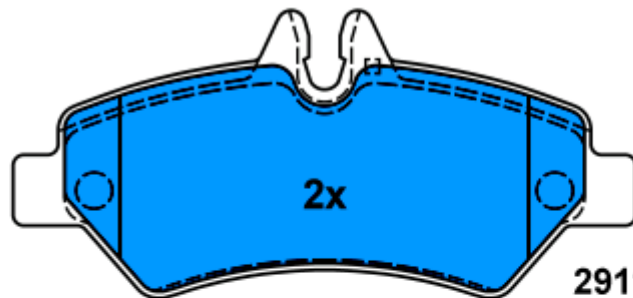

29190 20,2

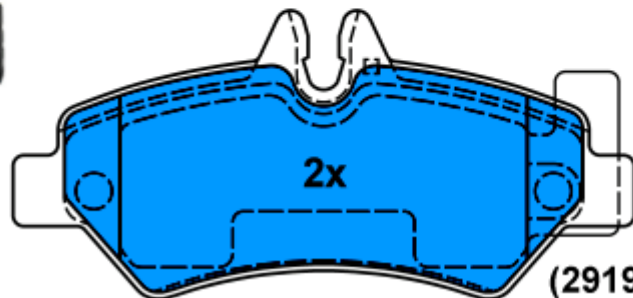
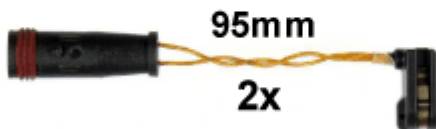

(29190) 20,2



M10x31

136,8 x 63



13.0460-2714.2 602714

Aplicación:

MINI R55 Clubman (07-)
MINI R56 (06-)

