

Nuevas referencias en almacén

Por aplicación

03/2008



www.ate.de



					Denominación	Ref. OE correspondientes a las referencias ATE		Referencia anterior / varios
--	--	--	--	--	--------------	--	--	------------------------------

AUDI

A3 / A3 Sportback (03-)	1,4 TFSI		07.2007		83.7847-0558.3	330871	LATIGUILLO	1K0 611 701 M , 1K0 611 701 H	
	1,6				83.7847-0558.3	330871	LATIGUILLO	1K0 611 701 M , 1K0 611 701 H	
	1,6 FSI				83.7847-0558.3	330871	LATIGUILLO	1K0 611 701 M , 1K0 611 701 H	
	1,8 TFSI				83.7847-0558.3	330871	LATIGUILLO	1K0 611 701 M , 1K0 611 701 H	
	1,9 TDI				83.7847-0558.3	330871	LATIGUILLO	1K0 611 701 M , 1K0 611 701 H	
	2,0 FSI				83.7847-0558.3	330871	LATIGUILLO	1K0 611 701 M , 1K0 611 701 H	
	2,0 TDI				83.7847-0558.3	330871	LATIGUILLO	1K0 611 701 M , 1K0 611 701 H	
	2,0 TDI Quattro				83.7847-0558.3	330871	LATIGUILLO	1K0 611 701 M , 1K0 611 701 H	
	2,0 TFSI				83.7847-0558.3	330871	LATIGUILLO	1K0 611 701 M , 1K0 611 701 H	
	2,0 TFSI Quattro				83.7847-0558.3	330871	LATIGUILLO	1K0 611 701 M , 1K0 611 701 H	
	3,2 Quattro				83.7847-0558.3	330871	LATIGUILLO	1K0 611 701 M , 1K0 611 701 H	
	S3				83.7847-0558.3	330871	LATIGUILLO	1K0 611 701 M , 1K0 611 701 H	
A4 (B6/B7) (01-)	S4 4,2		03.2003		24.0130-0119.1	430119	DISCO DE FRENO	8E0 615 301 K , 8E0 615 301 T	



					Denominación	Ref. OE correspondientes a las referencias ATE		Referencia anterior / varios
--	--	--	--	--	--------------	--	--	------------------------------

AUDI

A4 CABRIOLE (02-)	S4 4,2 Quattro		02.2004		24.0130-0119.1	430119	DISCO DE FRENO	8EO 615 301 K , 8EO 615 301 T	
-------------------	----------------	--	---------	--	----------------	--------	----------------	-------------------------------	--

CITROEN

C2 (03-)	1,1 i		09.2003		24.5246-0185.3	330881	LATIGUILLO	4806 C0	
	1,4 HDi		09.2003		24.5246-0185.3	330881	LATIGUILLO	4806 C0	
	1,4 i		09.2003		24.5246-0185.3	330881	LATIGUILLO	4806 C0	
	1,6 16V		09.2003		24.5246-0185.3	330881	LATIGUILLO	4806 C0	
	1,6 VTS		01.2005		24.5246-0185.3	330881	LATIGUILLO	4806 C0	
C3 (02-)	1,1 i		02.2002		24.5246-0185.3	330881	LATIGUILLO	4806 C0	
	1,4 16V		12.2003		24.5246-0185.3	330881	LATIGUILLO	4806 C0	
	1,4 16V HDi 90		02.2002		24.5246-0185.3	330881	LATIGUILLO	4806 C0	
	1,4 HDi		02.2002		24.5246-0185.3	330881	LATIGUILLO	4806 C0	
	1,4 i		02.2002		24.5246-0185.3	330881	LATIGUILLO	4806 C0	
	1,6 16V		02.2002		24.5246-0185.3	330881	LATIGUILLO	4806 C0	
	1,6 16V HDi 110		09.2005		24.5246-0185.3	330881	LATIGUILLO	4806 C0	
	1,6 16V HDi 90		10.2005		24.5246-0185.3	330881	LATIGUILLO	4806 C0	
C3 Pluriel (03-)	1,4 HDi		04.2004		24.5246-0185.3	330881	LATIGUILLO	4806 C0	
	1,4 i		05.2003		24.5246-0185.3	330881	LATIGUILLO	4806 C0	
	1,6 16V		05.2003		24.5246-0185.3	330881	LATIGUILLO	4806 C0	



					Denominación	Ref. OE correspondientes a las referencias ATE		Referencia anterior / varios
--	--	--	--	--	--------------	--	--	------------------------------

FIAT

500 (07-)	1,2 i		07.2007		24.5228-0165.3	330879	LATIGUILLO	46803893	
	1,3 JTD		07.2007		24.5228-0165.3	330879	LATIGUILLO	46803893	
DOBLO (01-)			10.2005		24.5112-0490.3	330876	LATIGUILLO	51776519	
	1,4 i		10.2005		24.5112-0490.3	330876	LATIGUILLO	51776519	
	1,6 i 16V		10.2005		24.5112-0490.3	330876	LATIGUILLO	51776519	
	1,9 JTD		10.2005		24.5112-0490.3	330876	LATIGUILLO	51776519	
PANDA (03-)	1,1 i		09.2003		24.5228-0165.3	330879	LATIGUILLO	46803893	
	1,2 i		09.2003		24.5228-0165.3	330879	LATIGUILLO	46803893	
	1,3 JTD		09.2003		24.5228-0165.3	330879	LATIGUILLO	46803893	
	1,4 i 16V		11.2006		24.5228-0165.3	330879	LATIGUILLO	46803893	

HYUNDAI

SANTAMO (99-02)	2,0 i 16V		02.1999	10.2002	24.0118-0141.1	418141	DISCO DE FRENO	58411-M2050	
	2,0 i 16V 4x4		02.1999	10.2002	24.0118-0141.1	418141	DISCO DE FRENO	58411-M2050	



					Denominación	Ref. OE correspondientes a las referencias ATE		Referencia anterior / varios
--	--	--	--	--	--------------	--	--	------------------------------

KIA

CARNIVAL II (01-06)	2,5 i V6		12.2003	08.2006	03.0137-0484.2	650484	JUEGO DE ZAPATAS	OK58A-26-38Z	
	2,9 CRDi		12.2003	08.2006	03.0137-0484.2	650484	JUEGO DE ZAPATAS	OK58A-26-38Z	
	3,5 i V6		12.2003	08.2006	03.0137-0484.2	650484	JUEGO DE ZAPATAS	OK58A-26-38Z	
JOICE (00-03)	2,0 i 16V		01.2000	08.2003	24.0118-0141.1	418141	DISCO DE FRENO	58411-M2050	
			09.2001	08.2003	24.0118-0141.1	418141	DISCO DE FRENO	58411-M2050	
SEDONA II (GB) (01-06)	2,5 i V6		12.2003	10.2006	03.0137-0484.2	650484	JUEGO DE ZAPATAS	OK58A-26-38Z	
	2,9 CRDi		12.2003	10.2006	03.0137-0484.2	650484	JUEGO DE ZAPATAS	OK58A-26-38Z	
	3,5 i V6		12.2003	10.2006	03.0137-0484.2	650484	JUEGO DE ZAPATAS	OK58A-26-38Z	

LAND ROVER

FREELANDER (LN) (98-07)	1,8i 16V			03.2007	03.0137-0480.2	650480	JUEGO DE ZAPATAS	SFS000030	
	2,0 DI			03.2007	03.0137-0480.2	650480	JUEGO DE ZAPATAS	SFS000030	
	2,0 TD4			03.2007	03.0137-0480.2	650480	JUEGO DE ZAPATAS	SFS000030	
	2,5 V6			03.2007	03.0137-0480.2	650480	JUEGO DE ZAPATAS	SFS000030	



	i			Denominación	Ref. OE correspondientes a las referencias ATE	i Referencia anterior / varios
--	----------	--	--	---------------------	---	--

LEXUS

Modelo	Motor	Fecha inicio	Fecha fin	Ref. ATE	Ref. OE	Denominación	Ref. OE correspondientes a las referencias ATE	Referencia anterior / varios
GS 300 (97-05)	3,0 i V6 (JZS160)	09.1997	03.2005	24.0112-0703.1	412703	DISCO DE FRENO	42431-30260 , 42431-53010 , 42431-53011	
GS 430 (00-05)	4,3 i V8 (UZS161)	11.2000	03.2005	24.0112-0703.1	412703	DISCO DE FRENO	42431-30260 , 42431-53010 , 42431-53011	
IS 200 (99-05)	2,0 i V6 (GXE10)	04.1999	09.2005	24.0112-0703.1	412703	DISCO DE FRENO	42431-30260 , 42431-53010 , 42431-53011	
IS 300 (01-05)	3,0 i V6 (JCE10)	09.2001	09.2005	24.0112-0703.1	412703	DISCO DE FRENO	42431-30260 , 42431-53010 , 42431-53011	
SC 430 (01-)	4,3 i V8 (UZZ40)	08.2001		24.0112-0703.1	412703	DISCO DE FRENO	42431-30260 , 42431-53010 , 42431-53011	



					Denominación	Ref. OE correspondientes a las referencias ATE		Referencia anterior / varios
--	--	--	--	--	--------------	--	--	------------------------------

MAZDA

626 (91-97)	1,8 i (GE1)	DI	09.1991	04.1994	24.3571-1703.5	240099	PINZA DE GARRA	GA5R-33-71X , GA5R-33-990A , GA5R-33-71XA	
		DD	09.1991	04.1994	24.3571-1704.5	240100	PINZA DE GARRA	GA5R-33-61X , GA5R-33-980A , GA5R-33-61XA	
	2,0 D (GE1)	DD	09.1991	04.1994	24.3571-1704.5	240100	PINZA DE GARRA	GA5R-33-61X , GA5R-33-980A , GA5R-33-61XA	
		DI	09.1991	04.1994	24.3571-1703.5	240099	PINZA DE GARRA	GA5R-33-71X , GA5R-33-990A , GA5R-33-71XA	
	2,0 i (GE1)	DD	09.1991	04.1994	24.3571-1704.5	240100	PINZA DE GARRA	GA5R-33-61X , GA5R-33-980A , GA5R-33-61XA	
		DI	09.1991	04.1994	24.3571-1703.5	240099	PINZA DE GARRA	GA5R-33-71X , GA5R-33-990A , GA5R-33-71XA	
	2,0 i 4WD (GE8)	DI	09.1991	04.1994	24.3571-1703.5	240099	PINZA DE GARRA	GA5R-33-71X , GA5R-33-990A , GA5R-33-71XA	
		DD	09.1991	04.1994	24.3571-1704.5	240100	PINZA DE GARRA	GA5R-33-61X , GA5R-33-980A , GA5R-33-61XA	
	2,5 i V6 (GE1/GE7)	DI	09.1991	04.1994	24.3571-1703.5	240099	PINZA DE GARRA	GA5R-33-71X , GA5R-33-990A , GA5R-33-71XA	
		DD	09.1991	04.1994	24.3571-1704.5	240100	PINZA DE GARRA	GA5R-33-61X , GA5R-33-980A , GA5R-33-61XA	
MX-6 (91-97)	2,0 i (GE1)	DI	07.1991	08.1997	24.3571-1703.5	240099	PINZA DE GARRA	GA5R-33-71X , GA5R-33-990A , GA5R-33-71XA	
		DD	07.1991	08.1997	24.3571-1704.5	240100	PINZA DE GARRA	GA5R-33-61X , GA5R-33-980A , GA5R-33-61XA	
	2,5 i V6 (GE1/GE7)	DI	07.1991	08.1997	24.3571-1703.5	240099	PINZA DE GARRA	GA5R-33-71X , GA5R-33-990A , GA5R-33-71XA	



					Denominación	Ref. OE correspondientes a las referencias ATE		Referencia anterior / varios
--	--	--	--	--	--------------	--	--	------------------------------

MAZDA

MX-6 (91-97)	2,5 i V6 (GE1/GE7)	DD	07.1991	08.1997	24.3571-1704.5	240100	PINZA DE GARRA	GA5R-33-61X , GA5R-33-980A , GA5R-33-61XA	
XEDOS 6 (92-00)	1,6 i 16V (CA1)	DI	06.1992	09.1999	24.3571-1703.5	240099	PINZA DE GARRA	GA5R-33-71X , GA5R-33-990A , GA5R-33-71XA	
		DD	06.1992	09.1999	24.3571-1704.5	240100	PINZA DE GARRA	GA5R-33-61X , GA5R-33-980A , GA5R-33-61XA	
	2,0 i V6 (CA1)	DI	06.1992	10.2000	24.3571-1703.5	240099	PINZA DE GARRA	GA5R-33-71X , GA5R-33-990A , GA5R-33-71XA	
		DD	06.1992	10.2000	24.3571-1704.5	240100	PINZA DE GARRA	GA5R-33-61X , GA5R-33-980A , GA5R-33-61XA	



					Denominación	Ref. OE correspondientes a las referencias ATE		Referencia anterior / varios
--	--	--	--	--	--------------	--	--	------------------------------

MERCEDES BENZ

Clase E (S211) Break (03-)	E 350 4-Matic		12.2004		24.0132-0154.1	432154	DISCO DE FRENO	211 421 11 12	
	E 500 4-Matic		10.2003		24.0132-0154.1	432154	DISCO DE FRENO	211 421 11 12	
Clase E (W211) Berlina (02-)	E 350 4-Matic		12.2004		24.0132-0154.1	432154	DISCO DE FRENO	211 421 11 12	
	E 500 4-Matic		10.2003		24.0132-0154.1	432154	DISCO DE FRENO	211 421 11 12	
Clase GL (X164) (06-)	GL 320 CDI		03.2006		24.0132-0157.1	432157	DISCO DE FRENO	164 421 05 12	
	GL 420 CDI		03.2006		24.0132-0157.1	432157	DISCO DE FRENO	164 421 05 12	
	GL 450		03.2006		24.0132-0157.1	432157	DISCO DE FRENO	164 421 05 12	
	GL 500		03.2006		24.0132-0157.1	432157	DISCO DE FRENO	164 421 05 12	
Clase M (W164) (05-)	ML 420 CDI		04.2006		24.0132-0157.1	432157	DISCO DE FRENO	164 421 05 12	
	ML 500		07.2005		24.0132-0157.1	432157	DISCO DE FRENO	164 421 05 12	
	ML 63 AMG		09.2005		24.0132-0157.1	432157	DISCO DE FRENO	164 421 05 12	
Clase R (R251) (06-)	R 500		11.2005		24.0132-0157.1	432157	DISCO DE FRENO	164 421 05 12	
	R 63 AMG		11.2005		24.0132-0157.1	432157	DISCO DE FRENO	164 421 05 12	
VITO (BM638) (96-03)	108 CDI	TD	03.1999	08.2003	24.3331-1702.7	220612	PINZA DE GARRA	001 420 65 83	
	108 D	TD	03.1996	08.2003	24.3331-1702.7	220612	PINZA DE GARRA	001 420 65 83	
	110 CDI	TD	03.1999	08.2003	24.3331-1702.7	220612	PINZA DE GARRA	001 420 65 83	
	110 D	TD	03.1996	08.2003	24.3331-1702.7	220612	PINZA DE GARRA	001 420 65 83	
	112 CDI	TD	03.1999	08.2003	24.3331-1702.7	220612	PINZA DE GARRA	001 420 65 83	
	113	TD	03.1996	08.2003	24.3331-1702.7	220612	PINZA DE GARRA	001 420 65 83	



					Denominación	Ref. OE correspondientes a las referencias ATE		Referencia anterior / varios
--	--	--	--	--	--------------	--	--	------------------------------

MERCEDES BENZ

VITO (BM638) (96-03)	114	TD	12.1996	08.2003	24.3331-1702.7	220612	PINZA DE GARRA	001 420 65 83	
Clase V (BM638) (96-03)	V 200	TD	09.1996	08.2003	24.3331-1702.7	220612	PINZA DE GARRA	001 420 65 83	
	V 200 CDI	TD	03.1999	08.2003	24.3331-1702.7	220612	PINZA DE GARRA	001 420 65 83	
	V 220 CDI	TD	03.1999	08.2003	24.3331-1702.7	220612	PINZA DE GARRA	001 420 65 83	
	V 230	TD	09.1996	08.2003	24.3331-1702.7	220612	PINZA DE GARRA	001 420 65 83	
	V 230 TD	TD	09.1996	08.2003	24.3331-1702.7	220612	PINZA DE GARRA	001 420 65 83	
	V 280	TD	09.1997	08.2003	24.3331-1702.7	220612	PINZA DE GARRA	001 420 65 83	







MITSUBISHI

PAJERO (06-)	3,2 DiD (V98W)		09.2006		13.0460-5744.2	605744	PASTILLAS DE FRENO	4605A458 , 04466-60020 , 04492-60010 , 04492-60020 , 04466-60010 , 04466-60080 , 04466-60090	ver figura
	3,8 i V6 (V97W)		09.2006		13.0460-5744.2	605744	PASTILLAS DE FRENO	4605A458 , 04466-60020 , 04492-60010 , 04492-60020 , 04466-60010 , 04466-60080 , 04466-60090	ver figura

NISSAN

ALMERA (N15) (95-00)	2,0 i	TD	04.1996	04.2000	24.3344-1720.5	240344	PINZA DE GARRA	44001-0N600	
ALMERA (N16) (00-)	1,5 i	TD	03.2000	03.2001	24.3344-1720.5	240344	PINZA DE GARRA	44001-0N600	
	1,8 i	TD	03.2000	03.2001	24.3344-1720.5	240344	PINZA DE GARRA	44001-0N600	
	2,2 Di	TD	03.2000	03.2001	24.3344-1720.5	240344	PINZA DE GARRA	44001-0N600	



					Denominación	Ref. OE correspondientes a las referencias ATE	 Referencia anterior / varios
---	---	---	---	---	--------------	--	--

OPEL

CORSA C / Vauxhall Corsa MK II (00-06)	1,0 12V	DI	09.2000	09.2006	24.3481-1767.5	240371	PINZA DE GARRA	5 42 071 , 9195982	
		DD	09.2000	09.2006	24.3481-1768.5	240372	PINZA DE GARRA	5 42 072 , 9195983	
	1,2 16V	DD	09.2000	09.2006	24.3481-1768.5	240372	PINZA DE GARRA	5 42 072 , 9195983	
		DI	09.2000	09.2006	24.3481-1767.5	240371	PINZA DE GARRA	5 42 071 , 9195982	
CORSA D / Vauxhall Corsa MK III (06-)	1,0 i		10.2006		13.0460-3839.2	603839	PASTILLAS DE FRENO	16 05 353 , 93189815 , 16 05 359 , 93191698	ver figura
			10.2006		13.0460-3839.2	603839	PASTILLAS DE FRENO	16 05 353 , 93189815 , 16 05 359 , 93191698	ver figura
	1,2 i 16V		10.2006		13.0460-3839.2	603839	PASTILLAS DE FRENO	16 05 353 , 93189815 , 16 05 359 , 93191698	ver figura
			10.2006		13.0460-3839.2	603839	PASTILLAS DE FRENO	16 05 353 , 93189815 , 16 05 359 , 93191698	ver figura
	1,3 CDTI		10.2006		13.0460-3839.2	603839	PASTILLAS DE FRENO	16 05 353 , 93189815 , 16 05 359 , 93191698	ver figura
			10.2006		13.0460-3839.2	603839	PASTILLAS DE FRENO	16 05 353 , 93189815 , 16 05 359 , 93191698	ver figura
			10.2006		13.0460-3840.2	603840	PASTILLAS DE FRENO	16 05 354 , 93189816	ver figura
	1,4 i 16V		10.2006		13.0460-3839.2	603839	PASTILLAS DE FRENO	16 05 353 , 93189815 , 16 05 359 , 93191698	ver figura
			10.2006		13.0460-3839.2	603839	PASTILLAS DE FRENO	16 05 353 , 93189815 , 16 05 359 , 93191698	ver figura



					Denominación	Ref. OE correspondientes a las referencias ATE		Referencia anterior / varios
--	--	--	--	--	--------------	--	--	------------------------------

PEUGEOT

1007 (05-)	1,4		04.2005		24.5246-0185.3	330881	LATIGUILLO	4806 C0	
	1,4 16V		10.2005		24.5246-0185.3	330881	LATIGUILLO	4806 C0	
	1,4 HDi		04.2005		24.5246-0185.3	330881	LATIGUILLO	4806 C0	
	1,6 16V		04.2005		24.5246-0185.3	330881	LATIGUILLO	4806 C0	
206 Berlina (98-)	1,1	DD			24.3481-1770.5	240374	PINZA DE GARRA	4400 P1	
		DI			24.3481-1771.5	240375	PINZA DE GARRA	4400 N8	
		DD			24.3481-1772.5	240376	PINZA DE GARRA	4400 N9	
	1,4	DD			24.3481-1770.5	240374	PINZA DE GARRA	4400 P1	
		DI			24.3481-1771.5	240375	PINZA DE GARRA	4400 N8	
		DD			24.3481-1772.5	240376	PINZA DE GARRA	4400 N9	
	1,4 HDi	DD	09.2001		24.3481-1770.5	240374	PINZA DE GARRA	4400 P1	
		DI	09.2001		24.3481-1771.5	240375	PINZA DE GARRA	4400 N8	
		DD	09.2001		24.3481-1772.5	240376	PINZA DE GARRA	4400 N9	
	1,4 Roland Garros	DD			24.3481-1770.5	240374	PINZA DE GARRA	4400 P1	
	1,6	DD			24.3481-1770.5	240374	PINZA DE GARRA	4400 P1	
	1,9 D	DD			24.3481-1770.5	240374	PINZA DE GARRA	4400 P1	
206 SW (02-)	1,1	DI	07.2002		24.3481-1771.5	240375	PINZA DE GARRA	4400 N8	
		DD	07.2002		24.3481-1772.5	240376	PINZA DE GARRA	4400 N9	
	1,4	DI	07.2002		24.3481-1771.5	240375	PINZA DE GARRA	4400 N8	









	i				Denominación	Ref. OE correspondientes a las referencias ATE	i Referencia anterior / varios
--	----------	--	--	--	---------------------	---	--

PEUGEOT

Modelo	Motor	DD	Fecha	Ref. ATE	Ref. OE	Denominación	Ref. OE correspondientes a las referencias ATE	Referencia anterior / varios
206 SW (02-)	1,4	DD	07.2002	24.3481-1772.5	240376	PINZA DE GARRA	4400 N9	
	1,4 16V	DI	10.2003	24.3481-1771.5	240375	PINZA DE GARRA	4400 N8	
		DD	10.2003	24.3481-1772.5	240376	PINZA DE GARRA	4400 N9	
	1,4 HDi	DD	07.2002	24.3481-1770.5	240374	PINZA DE GARRA	4400 P1	
		DI	07.2002	24.3481-1771.5	240375	PINZA DE GARRA	4400 N8	
		DD	07.2002	24.3481-1772.5	240376	PINZA DE GARRA	4400 N9	









					Denominación	Ref. OE correspondientes a las referencias ATE	 Referencia anterior / varios
---	---	---	---	---	--------------	--	--

RENAULT

GRAND SCENIC (04-)	1,5 dCi		04.2004		24.2123-1760.3	010779	CIL. MAESTRO TANDEM	77 01 207 697	
	1,6		04.2004		24.2123-1760.3	010779	CIL. MAESTRO TANDEM	77 01 207 697	
	1,9 dCi		05.2005		24.2123-1760.3	010779	CIL. MAESTRO TANDEM	77 01 207 697	
			04.2004		24.2123-1760.3	010779	CIL. MAESTRO TANDEM	77 01 207 697	
	2,0 16V		04.2004		24.2123-1760.3	010779	CIL. MAESTRO TANDEM	77 01 207 697	
	2,0 16V Turbo		04.2004		24.2123-1760.3	010779	CIL. MAESTRO TANDEM	77 01 207 697	
MEGANE II COUPE/CABRIOLE (EM_) (03-)	1,5 dCi		05.2005		24.2123-1760.3	010779	CIL. MAESTRO TANDEM	77 01 207 697	
	1,6 16V		09.2003		24.2123-1760.3	010779	CIL. MAESTRO TANDEM	77 01 207 697	
	1,9 dCi		09.2003		24.2123-1760.3	010779	CIL. MAESTRO TANDEM	77 01 207 697	
	2,0 16V		09.2003		24.2123-1760.3	010779	CIL. MAESTRO TANDEM	77 01 207 697	
	2,0 16V Turbo		05.2004		24.2123-1760.3	010779	CIL. MAESTRO TANDEM	77 01 207 697	
	2,0 dCi		09.2005		24.2123-1760.3	010779	CIL. MAESTRO TANDEM	77 01 207 697	
MEGANE II Grandtour (KM_) (03-)	1,4 16V		09.2003		24.0110-0325.2	410325	BREMSSCHEIBE LAG.&SENS	77 01 207 898	24.0110-0303.1-
			09.2003		24.2123-1760.3	010779	CIL. MAESTRO TANDEM	77 01 207 697	
	1,5 dCi		09.2003		24.0110-0325.2	410325	BREMSSCHEIBE LAG.&SENS	77 01 207 898	24.0110-0303.1-
			09.2003		24.2123-1760.3	010779	CIL. MAESTRO TANDEM	77 01 207 697	
	1,6 16V		09.2003		24.0110-0325.2	410325	BREMSSCHEIBE LAG.&SENS	77 01 207 898	24.0110-0303.1-
			09.2003		24.2123-1760.3	010779	CIL. MAESTRO TANDEM	77 01 207 697	
	1,9 dCi		09.2003		24.0110-0325.2	410325	BREMSSCHEIBE LAG.&SENS	77 01 207 898	24.0110-0303.1-









					Denominación	Ref. OE correspondientes a las referencias ATE		Referencia anterior / varios
---	---	---	---	---	---------------------	---	---	-------------------------------------

RENAULT

MEGANE II Grandtour (KM_) (03-)	1,9 dCi		09.2003		24.2123-1760.3	010779	CIL. MAESTRO TANDEM	77 01 207 697	
	2,0 16V		09.2003		24.0110-0325.2	410325	BREMSSCHEIBE LAG.&SENS	77 01 207 898	24.0110-0303.1-
			09.2003		24.2123-1760.3	010779	CIL. MAESTRO TANDEM	77 01 207 697	
	2,0 dCi		09.2005		24.0110-0325.2	410325	BREMSSCHEIBE LAG.&SENS	77 01 207 898	24.0110-0303.1-
			09.2005		24.2123-1760.3	010779	CIL. MAESTRO TANDEM	77 01 207 697	
MEGANE II Berlina 3/5-puertas (BM_/CM_) (02-)	1,4 16V		11.2002		24.2123-1760.3	010779	CIL. MAESTRO TANDEM	77 01 207 697	
	1,5 dCi		11.2002		24.2123-1760.3	010779	CIL. MAESTRO TANDEM	77 01 207 697	
	1,6 16V		11.2002		24.2123-1760.3	010779	CIL. MAESTRO TANDEM	77 01 207 697	
	1,9 dCi		11.2002		24.2123-1760.3	010779	CIL. MAESTRO TANDEM	77 01 207 697	
	2,0 16V		11.2002		24.2123-1760.3	010779	CIL. MAESTRO TANDEM	77 01 207 697	
	2,0 16V Turbo		05.2004		24.2123-1760.3	010779	CIL. MAESTRO TANDEM	77 01 207 697	
	2,0 dCi		09.2005		24.2123-1760.3	010779	CIL. MAESTRO TANDEM	77 01 207 697	
	2,0 Sport		05.2004		24.2123-1760.3	010779	CIL. MAESTRO TANDEM	77 01 207 697	
MEGANE II Berlina 4-puertas (LM_) (03-)	1,4 16V		09.2003		24.2123-1760.3	010779	CIL. MAESTRO TANDEM	77 01 207 697	
	1,5 dCi		09.2003		24.2123-1760.3	010779	CIL. MAESTRO TANDEM	77 01 207 697	
	1,6 16V		09.2003		24.2123-1760.3	010779	CIL. MAESTRO TANDEM	77 01 207 697	
	1,9 dCi		09.2003		24.2123-1760.3	010779	CIL. MAESTRO TANDEM	77 01 207 697	
	2,0 16V		09.2003		24.2123-1760.3	010779	CIL. MAESTRO TANDEM	77 01 207 697	
SCENIC II (JM_) (03-)	1,4 16V		06.2003		24.0110-0325.2	410325	BREMSSCHEIBE LAG.&SENS	77 01 207 898	24.0110-0303.1-



					Denominación	Ref. OE correspondientes a las referencias ATE	 Referencia anterior / varios
---	---	---	---	---	--------------	--	--

RENAULT

Modelo	Motor	Fecha	Referencia ATE	Referencia OE	Denominación	Ref. OE correspondientes a las referencias ATE	Referencia anterior / varios
SCENIC II (JM_) (03-)	1,4 16V	06.2003	24.2123-1760.3	010779	CIL. MAESTRO TANDEM	77 01 207 697	
	1,5 dCi	06.2003	24.0110-0325.2	410325	BREMSSCHEIBE LAG.&SENS	77 01 207 898	24.0110-0303.1-
		05.2005	24.0110-0325.2	410325	BREMSSCHEIBE LAG.&SENS	77 01 207 898	24.0110-0303.1-
		11.2003	24.0110-0325.2	410325	BREMSSCHEIBE LAG.&SENS	77 01 207 898	24.0110-0303.1-
		11.2003	24.2123-1760.3	010779	CIL. MAESTRO TANDEM	77 01 207 697	
		05.2005	24.2123-1760.3	010779	CIL. MAESTRO TANDEM	77 01 207 697	
		06.2003	24.2123-1760.3	010779	CIL. MAESTRO TANDEM	77 01 207 697	
	1,6 16V	06.2003	24.0110-0325.2	410325	BREMSSCHEIBE LAG.&SENS	77 01 207 898	24.0110-0303.1-
		06.2003	24.2123-1760.3	010779	CIL. MAESTRO TANDEM	77 01 207 697	
	1,9 dCi	06.2003	24.0110-0325.2	410325	BREMSSCHEIBE LAG.&SENS	77 01 207 898	24.0110-0303.1-
		05.2005	24.0110-0325.2	410325	BREMSSCHEIBE LAG.&SENS	77 01 207 898	24.0110-0303.1-
		05.2005	24.2123-1760.3	010779	CIL. MAESTRO TANDEM	77 01 207 697	
		06.2003	24.2123-1760.3	010779	CIL. MAESTRO TANDEM	77 01 207 697	
	2,0 16V	06.2003	24.0110-0325.2	410325	BREMSSCHEIBE LAG.&SENS	77 01 207 898	24.0110-0303.1-
		06.2003	24.2123-1760.3	010779	CIL. MAESTRO TANDEM	77 01 207 697	
	2,0 16V Turbo	05.2004	24.0110-0325.2	410325	BREMSSCHEIBE LAG.&SENS	77 01 207 898	24.0110-0303.1-
		05.2004	24.2123-1760.3	010779	CIL. MAESTRO TANDEM	77 01 207 697	
	2,0 dCi 110	09.2005	24.0110-0325.2	410325	BREMSSCHEIBE LAG.&SENS	77 01 207 898	24.0110-0303.1-
		09.2005	24.2123-1760.3	010779	CIL. MAESTRO TANDEM	77 01 207 697	

Nuevas referencias en almacén - Por aplicación

03/2008









					Denominación	Ref. OE correspondientes a las referencias ATE		Referencia anterior / varios
--	--	--	--	--	--------------	--	--	------------------------------

TOYOTA

CAMRY (01-05)	2,0 VVTi (ACV31)		12.2001	12.2005	13.0460-5743.2	605743	PASTILLAS DE FRENO	04465-33260 , 04465-33320	ver figura
	2,4 VVTi (ACV30)		12.2001	12.2005	13.0460-5743.2	605743	PASTILLAS DE FRENO	04465-33260 , 04465-33320	ver figura
	3,0 i V6 (MCV30)		12.2001	12.2005	13.0460-5743.2	605743	PASTILLAS DE FRENO	04465-33260 , 04465-33320	ver figura
COROLLA (97-02)	1,4 i (EE111)		05.1997	01.2000	24.5260-0280.3	330883	LATIGUILLO	90947-02921 , 90080-94067	
	1,6 i (AE111)		05.1997	01.2000	24.5260-0280.3	330883	LATIGUILLO	90947-02921 , 90080-94067	
	2,0 D (CE110)		05.1997	01.2000	24.5260-0280.3	330883	LATIGUILLO	90947-02921 , 90080-94067	
LAND CRUISER 120 (03-)	3,0 D-4D		01.2003		13.0460-5744.2	605744	PASTILLAS DE FRENO	4605A458 , 04466-60020 , 04492-60010 , 04492-60020 , 04466-60010 , 04466-60080 , 04466-60090	ver figura
			01.2005		13.0460-5744.2	605744	PASTILLAS DE FRENO	4605A458 , 04466-60020 , 04492-60010 , 04492-60020 , 04466-60010 , 04466-60080 , 04466-60090	ver figura
	4,0 VVTi		01.2003		13.0460-5744.2	605744	PASTILLAS DE FRENO	4605A458 , 04466-60020 , 04492-60010 , 04492-60020 , 04466-60010 , 04466-60080 , 04466-60090	ver figura
LAND CRUISER 70-75 (90-96)	2,4 (RJ70/73)		01.1990	12.1996	13.0460-5744.2	605744	PASTILLAS DE FRENO	4605A458 , 04466-60020 , 04492-60010 , 04492-60020 , 04466-60010 , 04466-60080 , 04466-60090	ver figura
	2,4 TD (LJ70/73)		01.1990	05.1996	13.0460-5744.2	605744	PASTILLAS DE FRENO	4605A458 , 04466-60020 , 04492-60010 , 04492-60020 , 04466-60010 , 04466-60080 , 04466-60090	ver figura



						Denominación	Ref. OE correspondientes a las referencias ATE	 Referencia anterior / varios
---	---	---	---	---	--	---------------------	---	--

TOYOTA

LAND CRUISER 70-75 (90-96)	4,2 TD (HZJ70/73)		01.1990	12.1996	13.0460-5744.2	605744	PASTILLAS DE FRENO	4605A458 , 04466-60020 , 04492-60010 , 04492-60020 , 04466-60010 , 04466-60080 , 04466-60090	ver figura
LAND CRUISER 90-95 (96-02)	3,0 D-4D (KDJ90/95)		08.2000	08.2002	13.0460-5744.2	605744	PASTILLAS DE FRENO	4605A458 , 04466-60020 , 04492-60010 , 04492-60020 , 04466-60010 , 04466-60080 , 04466-60090	ver figura
	3,0 TD (KZJ90/95)		04.1996	07.2000	13.0460-5744.2	605744	PASTILLAS DE FRENO	4605A458 , 04466-60020 , 04492-60010 , 04492-60020 , 04466-60010 , 04466-60080 , 04466-60090	ver figura
	3,4 i 24V (VZJ90/95)		04.1996	08.2002	13.0460-5744.2	605744	PASTILLAS DE FRENO	4605A458 , 04466-60020 , 04492-60010 , 04492-60020 , 04466-60010 , 04466-60080 , 04466-60090	ver figura
LAND CRUISER BREAK 80 (90-97)	4,0 i (FJ80)		01.1990	08.1992	13.0460-5744.2	605744	PASTILLAS DE FRENO	4605A458 , 04466-60020 , 04492-60010 , 04492-60020 , 04466-60010 , 04466-60080 , 04466-60090	ver figura
	4,2 D (HZJ80)		01.1990	12.1997	13.0460-5744.2	605744	PASTILLAS DE FRENO	4605A458 , 04466-60020 , 04492-60010 , 04492-60020 , 04466-60010 , 04466-60080 , 04466-60090	ver figura
	4,2 TD (HDJ80)		01.1990	12.1997	13.0460-5744.2	605744	PASTILLAS DE FRENO	4605A458 , 04466-60020 , 04492-60010 , 04492-60020 , 04466-60010 , 04466-60080 , 04466-60090	ver figura
	4,5 i 24V (FZJ80)		08.1992	12.1997	13.0460-5744.2	605744	PASTILLAS DE FRENO	4605A458 , 04466-60020 , 04492-60010 , 04492-60020 , 04466-60010 , 04466-60080 , 04466-60090	ver figura



					Denominación	Ref. OE correspondientes a las referencias ATE		Referencia anterior / varios
--	--	--	--	--	--------------	--	--	------------------------------

VOLKSWAGEN

GOLF V Variant (07-)	1,4		06.2007		83.7847-0558.3	330871	LATIGUILLO	1K0 611 701 M , 1K0 611 701 H	
	1,4 TSI		06.2007		83.7847-0558.3	330871	LATIGUILLO	1K0 611 701 M , 1K0 611 701 H	
			05.2007		83.7847-0558.3	330871	LATIGUILLO	1K0 611 701 M , 1K0 611 701 H	
	1,6		05.2007		83.7847-0558.3	330871	LATIGUILLO	1K0 611 701 M , 1K0 611 701 H	
	1,9 TDI		05.2007		83.7847-0558.3	330871	LATIGUILLO	1K0 611 701 M , 1K0 611 701 H	
	1,9 TDI 4motion		12.2007		83.7847-0558.3	330871	LATIGUILLO	1K0 611 701 M , 1K0 611 701 H	
	2		06.2007		83.7847-0558.3	330871	LATIGUILLO	1K0 611 701 M , 1K0 611 701 H	
	2,0 TDI		05.2007		83.7847-0558.3	330871	LATIGUILLO	1K0 611 701 M , 1K0 611 701 H	
JETTA III (05-)	1,4 TSI		05.2007		83.7847-0558.3	330871	LATIGUILLO	1K0 611 701 M , 1K0 611 701 H	
					83.7847-0558.3	330871	LATIGUILLO	1K0 611 701 M , 1K0 611 701 H	
	1,6 FSI				83.7847-0558.3	330871	LATIGUILLO	1K0 611 701 M , 1K0 611 701 H	
	1,6 i 16V				83.7847-0558.3	330871	LATIGUILLO	1K0 611 701 M , 1K0 611 701 H	
	1,9 TDI				83.7847-0558.3	330871	LATIGUILLO	1K0 611 701 M , 1K0 611 701 H	



					Denominación	Ref. OE correspondientes a las referencias ATE		Referencia anterior / varios
--	--	--	--	--	--------------	--	--	------------------------------

VOLKSWAGEN

JETTA III (05-)	2,0 FSI				83.7847-0558.3	330871	LATIGUILLO	1K0 611 701 M , 1K0 611 701 H	
	2,0 TDI				83.7847-0558.3	330871	LATIGUILLO	1K0 611 701 M , 1K0 611 701 H	
	2,0 TFSI				83.7847-0558.3	330871	LATIGUILLO	1K0 611 701 M , 1K0 611 701 H	
TOURAN (03-)	1,4 FSI		11.2006		83.7847-0558.3	330871	LATIGUILLO	1K0 611 701 M , 1K0 611 701 H	
	1,4 TSI		11.2006		83.7847-0558.3	330871	LATIGUILLO	1K0 611 701 M , 1K0 611 701 H	
	1,6		11.2006		83.7847-0558.3	330871	LATIGUILLO	1K0 611 701 M , 1K0 611 701 H	
	1,6 FSI		11.2006		83.7847-0558.3	330871	LATIGUILLO	1K0 611 701 M , 1K0 611 701 H	
	1,9 TDI		11.2006		83.7847-0558.3	330871	LATIGUILLO	1K0 611 701 M , 1K0 611 701 H	
	2,0 Eco Fuel		11.2006		83.7847-0558.3	330871	LATIGUILLO	1K0 611 701 M , 1K0 611 701 H	
	2,0 FSI		11.2006		83.7847-0558.3	330871	LATIGUILLO	1K0 611 701 M , 1K0 611 701 H	
	2,0 TDI		11.2006		83.7847-0558.3	330871	LATIGUILLO	1K0 611 701 M , 1K0 611 701 H	
FURGONETA (T5) (03-)	1,9 TDI	TI	04.2003		24.5237-0250.3	330880	LATIGUILLO	7H0 611 775	
		TI	06.2006		24.5237-0250.3	330880	LATIGUILLO	7H0 611 775	
	2	TI	06.2003		24.5237-0250.3	330880	LATIGUILLO	7H0 611 775	



					Denominación	Ref. OE correspondientes a las referencias ATE		Referencia anterior / varios
--	--	--	--	--	--------------	--	--	------------------------------

VOLKSWAGEN

FURGONETA (T5) (03-)	2,5 TDI	TI	02.2003		24.5237-0250.3	330880	LATIGUILLO	7H0 611 775	
	2,5 TDI 4motion	TI	07.2004		24.5237-0250.3	330880	LATIGUILLO	7H0 611 775	
	3,2 V6	TI	02.2003		24.5237-0250.3	330880	LATIGUILLO	7H0 611 775	
	3,2 V6 4motion	TI	07.2004		24.5237-0250.3	330880	LATIGUILLO	7H0 611 775	



13.0460-3840.2 603840

Aplicación:

OPEL CORSA D / Vauxhall Corsa MK III (06-)

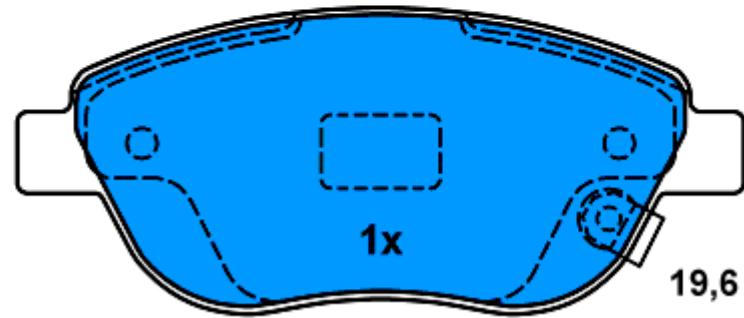
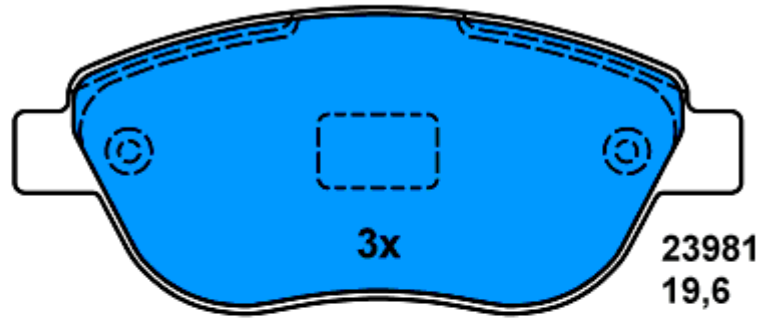
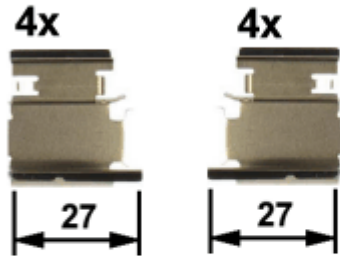

136,9 x 57,4



13.0460-3839.2 603839

Aplicación:

OPEL CORSA D / Vauxhall Corsa MK III (06-)

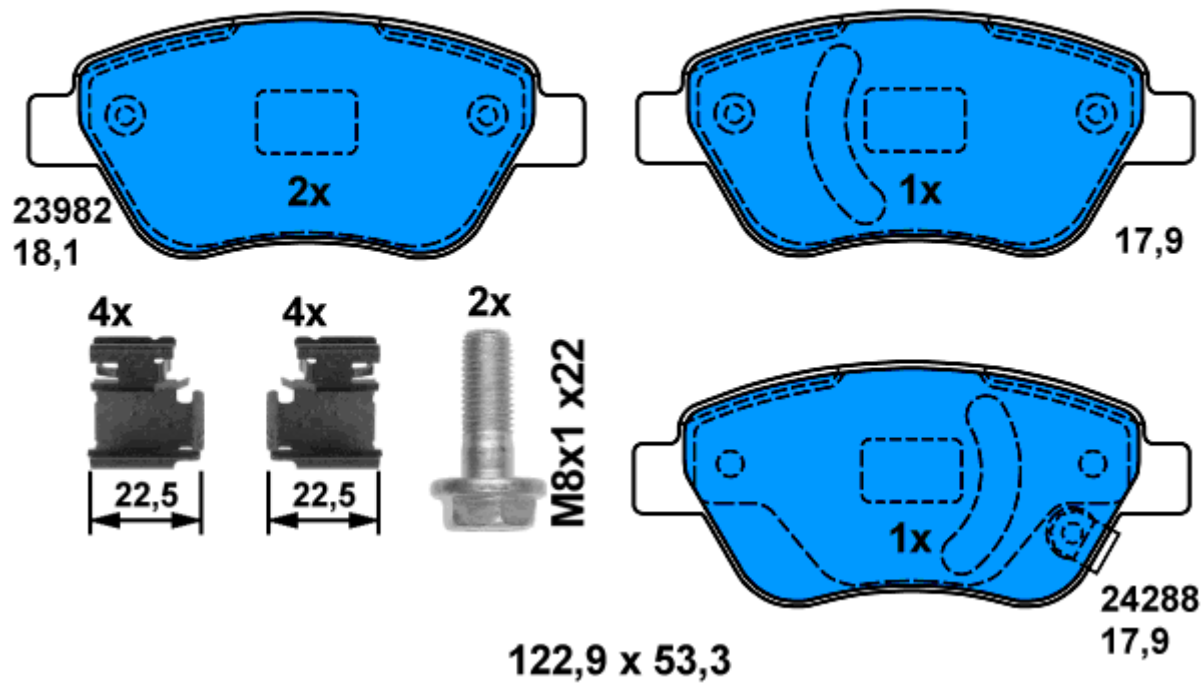

Ate

13.0460-5744.2 605744

Aplicación:

TOYOTA LAND CRUISER 120 (03-)
TOYOTA LAND CRUISER 70-75 (90-96)
TOYOTA LAND CRUISER 90-95 (96-02)
TOYOTA LAND CRUISER STATION WAGON 80 (90-97)
MITSUBISHI PAJERO (06-)

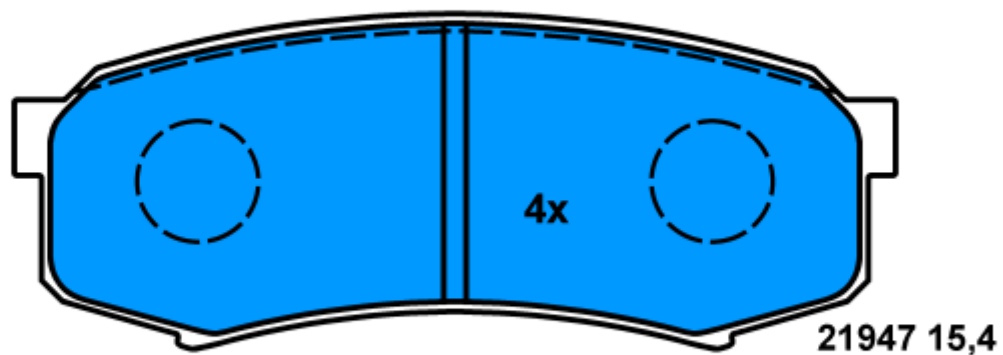

116,2 x 44

21947 15,4

Ate

13.0460-5743.2 605743

Aplicación:

TOYOTA CAMRY (01-05)

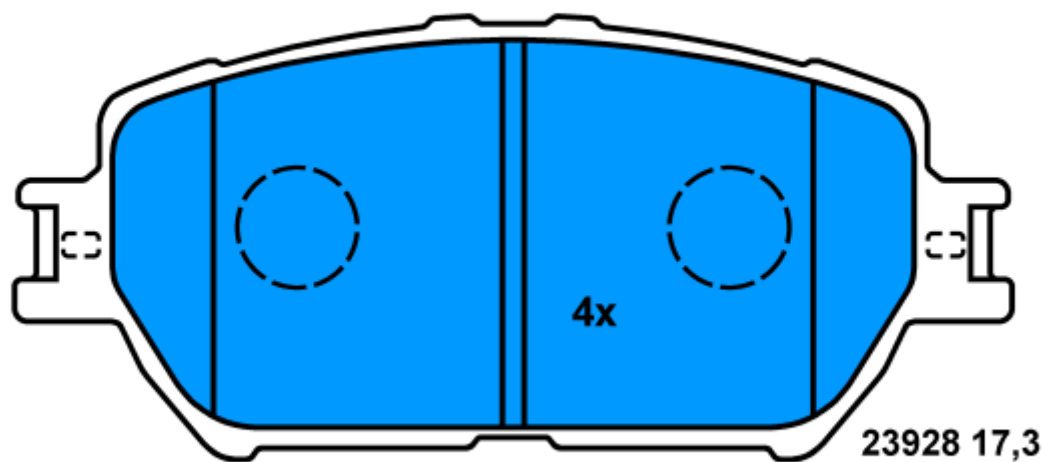

131,4 x 58,5