

Nuevas referencias en almacén

Por aplicación

12/2007



www.ate.de



					Denominación	Ref. OE correspondientes a las referencias ATE		Referencia anterior / varios
--	--	--	--	--	--------------	--	--	------------------------------

AUDI

A3 / A3 Sportback (03-)	1,4 TFSI		07.2007		83.7849-0231.3	330872	LATIGUILLO	1K0 611 775 C	
	1,6		05.2003		83.6249-0519.3	330867	LATIGUILLO	1K0 611 701 A , 1K0 611 701 C	
					83.7849-0231.3	330872	LATIGUILLO	1K0 611 775 C	
	1,6 FSI		08.2003		83.6249-0519.3	330867	LATIGUILLO	1K0 611 701 A , 1K0 611 701 C	
					83.7849-0231.3	330872	LATIGUILLO	1K0 611 775 C	
	1,8 TFSI				83.7849-0231.3	330872	LATIGUILLO	1K0 611 775 C	
			01.2007		83.6249-0519.3	330867	LATIGUILLO	1K0 611 701 A , 1K0 611 701 C	
	1,9 TDI		06.2003		83.6249-0519.3	330867	LATIGUILLO	1K0 611 701 A , 1K0 611 701 C	
					83.7849-0231.3	330872	LATIGUILLO	1K0 611 775 C	
	2,0 FSI				83.7849-0231.3	330872	LATIGUILLO	1K0 611 775 C	
			05.2003		83.6249-0519.3	330867	LATIGUILLO	1K0 611 701 A , 1K0 611 701 C	
	2,0 TDI		05.2003		83.6249-0519.3	330867	LATIGUILLO	1K0 611 701 A , 1K0 611 701 C	
					83.7849-0231.3	330872	LATIGUILLO	1K0 611 775 C	
			03.2006		83.6249-0519.3	330867	LATIGUILLO	1K0 611 701 A , 1K0 611 701 C	
	2,0 TDI Quattro		08.2004		83.6249-0519.3	330867	LATIGUILLO	1K0 611 701 A , 1K0 611 701 C	
					83.7849-0231.3	330872	LATIGUILLO	1K0 611 775 C	



					Denominación	Ref. OE correspondientes a las referencias ATE		Referencia anterior / varios
--	--	--	--	--	--------------	--	--	------------------------------

AUDI

A3 / A3 Sportback (03-)	2,0 TDI Quattro		03.2006		83.6249-0519.3	330867	LATIGUILLO	1K0 611 701 A , 1K0 611 701 C	
			05.2003		83.6249-0519.3	330867	LATIGUILLO	1K0 611 701 A , 1K0 611 701 C	
	2,0 TFSI		06.2004		83.6249-0519.3	330867	LATIGUILLO	1K0 611 701 A , 1K0 611 701 C	
					83.7849-0231.3	330872	LATIGUILLO	1K0 611 775 C	
	2,0 TFSI Quattro		06.2004		83.6249-0519.3	330867	LATIGUILLO	1K0 611 701 A , 1K0 611 701 C	
					83.7849-0231.3	330872	LATIGUILLO	1K0 611 775 C	
	3,2 Quattro				83.7849-0231.3	330872	LATIGUILLO	1K0 611 775 C	
			07.2003		83.6249-0519.3	330867	LATIGUILLO	1K0 611 701 A , 1K0 611 701 C	
	S3				83.7849-0231.3	330872	LATIGUILLO	1K0 611 775 C	
			11.2006		83.6249-0519.3	330867	LATIGUILLO	1K0 611 701 A , 1K0 611 701 C	
A4 (B5) (95-01)	S4 2,7		10.1997	04.2001	13.0460-2705.2	602705	PASTILLAS DE FRENO	8D0 698 151 B	ver figura
A4 (B6/B7) (01-)	1,6				03.7858-4502.4	300202	SERVOFRENO T52	8E0 612 107 B , 8E0 612 107 F	03.7858-4202.4
			12.2000		24.0130-0185.1	430185	DISCO DE FRENO	8E0 615 301 AE	
	1,8 T				03.7858-4502.4	300202	SERVOFRENO T52	8E0 612 107 B , 8E0 612 107 F	03.7858-4202.4
			12.2000		24.0130-0185.1	430185	DISCO DE FRENO	8E0 615 301 AE	
			07.2001		24.0130-0185.1	430185	DISCO DE FRENO	8E0 615 301 AE	

Nuevas referencias en almacén - Por aplicación

12/2007



					Denominación	Ref. OE correspondientes a las referencias ATE		Referencia anterior / varios
--	--	--	--	--	--------------	--	--	------------------------------

AUDI

A4 (B6/B7) (01-)	1,8 T		11.2002		24.0130-0185.1	430185	DISCO DE FRENO	8E0 615 301 AE	
			07.2002		24.0130-0185.1	430185	DISCO DE FRENO	8E0 615 301 AE	
	1,8 T Quattro				03.7858-4502.4	300202	SERVOFRENO T52	8E0 612 107 B , 8E0 612 107 F	03.7858-4202.4
			12.2000		24.0130-0185.1	430185	DISCO DE FRENO	8E0 615 301 AE	
			11.2002		24.0130-0185.1	430185	DISCO DE FRENO	8E0 615 301 AE	
			07.2001		24.0130-0185.1	430185	DISCO DE FRENO	8E0 615 301 AE	
			07.2002		24.0130-0185.1	430185	DISCO DE FRENO	8E0 615 301 AE	
	1,9 TDI				03.7858-4502.4	300202	SERVOFRENO T52	8E0 612 107 B , 8E0 612 107 F	03.7858-4202.4
			06.2004		03.7858-4502.4	300202	SERVOFRENO T52	8E0 612 107 B , 8E0 612 107 F	03.7858-4202.4
			04.2001		24.0130-0185.1	430185	DISCO DE FRENO	8E0 615 301 AE	
			06.2004		24.0130-0185.1	430185	DISCO DE FRENO	8E0 615 301 AE	
			12.2000		24.0130-0185.1	430185	DISCO DE FRENO	8E0 615 301 AE	
	1,9 TDI Quattro				03.7858-4502.4	300202	SERVOFRENO T52	8E0 612 107 B , 8E0 612 107 F	03.7858-4202.4
			12.2000		24.0130-0185.1	430185	DISCO DE FRENO	8E0 615 301 AE	
	2				03.7858-4502.4	300202	SERVOFRENO T52	8E0 612 107 B , 8E0 612 107 F	03.7858-4202.4
			12.2000		24.0130-0185.1	430185	DISCO DE FRENO	8E0 615 301 AE	
	2,0 FSI				03.7858-4502.4	300202	SERVOFRENO T52	8E0 612 107 B , 8E0 612 107 F	03.7858-4202.4

Nuevas referencias en almacén - Por aplicación

12/2007







					Denominación	Ref. OE correspondientes a las referencias ATE		Referencia anterior / varios
--	--	--	--	--	--------------	--	--	------------------------------

AUDI

A4 (B6/B7) (01-)	2,0 FSI		07.2002		24.0130-0185.1	430185	DISCO DE FRENO	8E0 615 301 AE	
	2,0 TDI				03.7858-4502.4	300202	SERVOFRENO T52	8E0 612 107 B , 8E0 612 107 F	03.7858-4202.4
			06.2006		03.7858-4502.4	300202	SERVOFRENO T52	8E0 612 107 B , 8E0 612 107 F	03.7858-4202.4
			06.2006		24.0130-0185.1	430185	DISCO DE FRENO	8E0 615 301 AE	
			11.2004		24.0130-0185.1	430185	DISCO DE FRENO	8E0 615 301 AE	
	2,0 TDI Quattro		01.2006		03.7858-4502.4	300202	SERVOFRENO T52	8E0 612 107 B , 8E0 612 107 F	03.7858-4202.4
			06.2006		03.7858-4502.4	300202	SERVOFRENO T52	8E0 612 107 B , 8E0 612 107 F	03.7858-4202.4
			01.2006		24.0130-0185.1	430185	DISCO DE FRENO	8E0 615 301 AE	
			06.2006		24.0130-0185.1	430185	DISCO DE FRENO	8E0 615 301 AE	
	2,0 TFSI		06.2005		03.7858-4502.4	300202	SERVOFRENO T52	8E0 612 107 B , 8E0 612 107 F	03.7858-4202.4
			11.2004		03.7858-4502.4	300202	SERVOFRENO T52	8E0 612 107 B , 8E0 612 107 F	03.7858-4202.4
			06.2005		24.0130-0185.1	430185	DISCO DE FRENO	8E0 615 301 AE	
			11.2004		24.0130-0185.1	430185	DISCO DE FRENO	8E0 615 301 AE	
	2,0 TFSI Quattro				03.7858-4502.4	300202	SERVOFRENO T52	8E0 612 107 B , 8E0 612 107 F	03.7858-4202.4
			11.2004		24.0130-0185.1	430185	DISCO DE FRENO	8E0 615 301 AE	
			06.2005		24.0130-0185.1	430185	DISCO DE FRENO	8E0 615 301 AE	



					Denominación	Ref. OE correspondientes a las referencias ATE	 Referencia anterior / varios
---	---	---	---	---	--------------	--	--

AUDI

A4 (B6/B7) (01-)	2,4				03.7858-4502.4	300202	SERVOFRENO T52	8E0 612 107 B , 8E0 612 107 F	03.7858-4202.4
			09.2001		24.0130-0185.1	430185	DISCO DE FRENO	8E0 615 301 AE	
	2,5 TDI				03.7858-4502.4	300202	SERVOFRENO T52	8E0 612 107 B , 8E0 612 107 F	03.7858-4202.4
			12.2000		24.0130-0185.1	430185	DISCO DE FRENO	8E0 615 301 AE	
	2,5 TDI Quattro				03.7858-4502.4	300202	SERVOFRENO T52	8E0 612 107 B , 8E0 612 107 F	03.7858-4202.4
			12.2000		24.0130-0185.1	430185	DISCO DE FRENO	8E0 615 301 AE	
	2,7 TDI		01.2006		03.7858-4502.4	300202	SERVOFRENO T52	8E0 612 107 B , 8E0 612 107 F	03.7858-4202.4
			01.2006		24.0130-0185.1	430185	DISCO DE FRENO	8E0 615 301 AE	
	3				03.7858-4502.4	300202	SERVOFRENO T52	8E0 612 107 B , 8E0 612 107 F	03.7858-4202.4
			12.2000		24.0130-0185.1	430185	DISCO DE FRENO	8E0 615 301 AE	
	3,0 Quattro				03.7858-4502.4	300202	SERVOFRENO T52	8E0 612 107 B , 8E0 612 107 F	03.7858-4202.4
			12.2000		24.0130-0185.1	430185	DISCO DE FRENO	8E0 615 301 AE	
	3,0 TDI Quattro				03.7858-4502.4	300202	SERVOFRENO T52	8E0 612 107 B , 8E0 612 107 F	03.7858-4202.4
			01.2006		03.7858-4502.4	300202	SERVOFRENO T52	8E0 612 107 B , 8E0 612 107 F	03.7858-4202.4
			11.2004		24.0130-0185.1	430185	DISCO DE FRENO	8E0 615 301 AE	
			01.2006		24.0130-0185.1	430185	DISCO DE FRENO	8E0 615 301 AE	



					Denominación	Ref. OE correspondientes a las referencias ATE		Referencia anterior / varios
--	--	--	--	--	--------------	--	--	------------------------------

AUDI

A4 (B6/B7) (01-)	3,2 FSI		01.2005		03.7858-4502.4	300202	SERVOFRENO T52	8E0 612 107 B , 8E0 612 107 F	03.7858-4202.4
			01.2005		24.0130-0185.1	430185	DISCO DE FRENO	8E0 615 301 AE	
	3,2 FSI Quattro				03.7858-4502.4	300202	SERVOFRENO T52	8E0 612 107 B , 8E0 612 107 F	03.7858-4202.4
			01.2005		24.0130-0185.1	430185	DISCO DE FRENO	8E0 615 301 AE	
A4 CABRIOLE (02-)	1,8 T				03.7858-4502.4	300202	SERVOFRENO T52	8E0 612 107 B , 8E0 612 107 F	03.7858-4202.4
	1,8 T Quattro		05.2003		03.7858-4502.4	300202	SERVOFRENO T52	8E0 612 107 B , 8E0 612 107 F	03.7858-4202.4
	2		05.2004		03.7858-4502.4	300202	SERVOFRENO T52	8E0 612 107 B , 8E0 612 107 F	03.7858-4202.4
	2,0 TDI		10.2005		03.7858-4502.4	300202	SERVOFRENO T52	8E0 612 107 B , 8E0 612 107 F	03.7858-4202.4
	2,0 TFSI		01.2006		03.7858-4502.4	300202	SERVOFRENO T52	8E0 612 107 B , 8E0 612 107 F	03.7858-4202.4
			10.2005		03.7858-4502.4	300202	SERVOFRENO T52	8E0 612 107 B , 8E0 612 107 F	03.7858-4202.4
	2,4				03.7858-4502.4	300202	SERVOFRENO T52	8E0 612 107 B , 8E0 612 107 F	03.7858-4202.4
	2,5 TDI				03.7858-4502.4	300202	SERVOFRENO T52	8E0 612 107 B , 8E0 612 107 F	03.7858-4202.4
	2,7 TDI		06.2006		03.7858-4502.4	300202	SERVOFRENO T52	8E0 612 107 B , 8E0 612 107 F	03.7858-4202.4
	3				03.7858-4502.4	300202	SERVOFRENO T52	8E0 612 107 B , 8E0 612 107 F	03.7858-4202.4



					Denominación	Ref. OE correspondientes a las referencias ATE		Referencia anterior / varios
--	--	--	--	--	--------------	--	--	------------------------------

AUDI

A4 CABRIOLE (02-)	3,0 Quattro		05.2003		03.7858-4502.4	300202	SERVOFRENO T52	8E0 612 107 B , 8E0 612 107 F	03.7858-4202.4
	3,0 TDI Quattro		01.2006		03.7858-4502.4	300202	SERVOFRENO T52	8E0 612 107 B , 8E0 612 107 F	03.7858-4202.4
			10.2005		03.7858-4502.4	300202	SERVOFRENO T52	8E0 612 107 B , 8E0 612 107 F	03.7858-4202.4
	3,2 FSI		10.2005		03.7858-4502.4	300202	SERVOFRENO T52	8E0 612 107 B , 8E0 612 107 F	03.7858-4202.4
	3,2 FSI Quattro		10.2005		03.7858-4502.4	300202	SERVOFRENO T52	8E0 612 107 B , 8E0 612 107 F	03.7858-4202.4
A6 (C5) (97-05)	1,8			01.2005	03.7858-4502.4	300202	SERVOFRENO T52	8E0 612 107 B , 8E0 612 107 F	03.7858-4202.4
	1,8 T			01.2005	03.7858-4502.4	300202	SERVOFRENO T52	8E0 612 107 B , 8E0 612 107 F	03.7858-4202.4
	1,8 T Quattro			01.2005	03.7858-4502.4	300202	SERVOFRENO T52	8E0 612 107 B , 8E0 612 107 F	03.7858-4202.4
	1,9 TDI			01.2005	03.7858-4502.4	300202	SERVOFRENO T52	8E0 612 107 B , 8E0 612 107 F	03.7858-4202.4
	2			01.2005	03.7858-4502.4	300202	SERVOFRENO T52	8E0 612 107 B , 8E0 612 107 F	03.7858-4202.4
	2,4			01.2005	03.7858-4502.4	300202	SERVOFRENO T52	8E0 612 107 B , 8E0 612 107 F	03.7858-4202.4
	2,4 Quattro			01.2005	03.7858-4502.4	300202	SERVOFRENO T52	8E0 612 107 B , 8E0 612 107 F	03.7858-4202.4
	2,5 TDI		07.2002	01.2005	03.7858-4502.4	300202	SERVOFRENO T52	8E0 612 107 B , 8E0 612 107 F	03.7858-4202.4



					Denominación	Ref. OE correspondientes a las referencias ATE		Referencia anterior / varios
--	--	--	--	--	--------------	--	--	------------------------------

AUDI

A6 (C5) (97-05)	2,5 TDI			01.2005	03.7858-4502.4	300202	SERVOFRENO T52	8E0 612 107 B , 8E0 612 107 F	03.7858-4202.4
	2,5 TDI Quattro			01.2005	03.7858-4502.4	300202	SERVOFRENO T52	8E0 612 107 B , 8E0 612 107 F	03.7858-4202.4
	2,7 T			01.2005	03.7858-4502.4	300202	SERVOFRENO T52	8E0 612 107 B , 8E0 612 107 F	03.7858-4202.4
			03.1998		13.0460-2701.2	602701	PASTILLAS DE FRENO	4B0 698 151 C	ver figura
	2,7 T Quattro			01.2005	03.7858-4502.4	300202	SERVOFRENO T52	8E0 612 107 B , 8E0 612 107 F	03.7858-4202.4
			10.1997		13.0460-2701.2	602701	PASTILLAS DE FRENO	4B0 698 151 C	ver figura
	2,8			01.2005	03.7858-4502.4	300202	SERVOFRENO T52	8E0 612 107 B , 8E0 612 107 F	03.7858-4202.4
	2,8 Quattro			01.2005	03.7858-4502.4	300202	SERVOFRENO T52	8E0 612 107 B , 8E0 612 107 F	03.7858-4202.4
	3			01.2005	03.7858-4502.4	300202	SERVOFRENO T52	8E0 612 107 B , 8E0 612 107 F	03.7858-4202.4
	3,0 Quattro			01.2005	03.7858-4502.4	300202	SERVOFRENO T52	8E0 612 107 B , 8E0 612 107 F	03.7858-4202.4
	4,2 Quattro			01.2005	03.7858-4502.4	300202	SERVOFRENO T52	8E0 612 107 B , 8E0 612 107 F	03.7858-4202.4
	S6 4,2			01.2005	03.7858-4502.4	300202	SERVOFRENO T52	8E0 612 107 B , 8E0 612 107 F	03.7858-4202.4
A6 (C6) Avant (05-)	2,0 TDI				83.7813-0315.3	330870	LATIGUILLO	4F0 611 707 B	
	2,0 TFSI				83.7813-0315.3	330870	LATIGUILLO	4F0 611 707 B	
	2,4				83.7813-0315.3	330870	LATIGUILLO	4F0 611 707 B	

Nuevas referencias en almacén - Por aplicación

12/2007



				Denominación	Ref. OE correspondientes a las referencias ATE		Referencia anterior / varios
--	--	--	--	--------------	--	--	------------------------------

AUDI

A6 (C6) Avant (05-)	2,4 Quattro				83.7813-0315.3	330870	LATIGUILLO	4F0 611 707 B	
	2,7 TDI				83.7813-0315.3	330870	LATIGUILLO	4F0 611 707 B	
	2,7 TDI Quattro				83.7813-0315.3	330870	LATIGUILLO	4F0 611 707 B	
	2,8 FSI				83.7813-0315.3	330870	LATIGUILLO	4F0 611 707 B	
	2,8 FSI Quattro				83.7813-0315.3	330870	LATIGUILLO	4F0 611 707 B	
	3				83.7813-0315.3	330870	LATIGUILLO	4F0 611 707 B	
	3,0 Quattro				83.7813-0315.3	330870	LATIGUILLO	4F0 611 707 B	
	3,0 TDI Quattro				83.7813-0315.3	330870	LATIGUILLO	4F0 611 707 B	
	3,2				83.7813-0315.3	330870	LATIGUILLO	4F0 611 707 B	
	3,2 Quattro				83.7813-0315.3	330870	LATIGUILLO	4F0 611 707 B	
	4,2 FSI Quattro				83.7813-0315.3	330870	LATIGUILLO	4F0 611 707 B	
	4,2 Quattro				83.7813-0315.3	330870	LATIGUILLO	4F0 611 707 B	
	S6				83.7813-0315.3	330870	LATIGUILLO	4F0 611 707 B	
A6 (C6) Berlina (04-)	2,0 TDI				83.7813-0315.3	330870	LATIGUILLO	4F0 611 707 B	
	2,0 TFSI				83.7813-0315.3	330870	LATIGUILLO	4F0 611 707 B	
	2,4				83.7813-0315.3	330870	LATIGUILLO	4F0 611 707 B	
	2,4 Quattro				83.7813-0315.3	330870	LATIGUILLO	4F0 611 707 B	
	2,7 TDI				83.7813-0315.3	330870	LATIGUILLO	4F0 611 707 B	
	2,7 TDI Quattro				83.7813-0315.3	330870	LATIGUILLO	4F0 611 707 B	



					Denominación	Ref. OE correspondientes a las referencias ATE		Referencia anterior / varios
--	--	--	--	--	--------------	--	--	------------------------------

AUDI

A6 (C6) Berlina (04-)	2,8 FSI				83.7813-0315.3	330870	LATIGUILLO	4F0 611 707 B	
	2,8 FSI Quattro				83.7813-0315.3	330870	LATIGUILLO	4F0 611 707 B	
	3				83.7813-0315.3	330870	LATIGUILLO	4F0 611 707 B	
	3,0 Quattro				83.7813-0315.3	330870	LATIGUILLO	4F0 611 707 B	
	3,0 TDI Quattro				83.7813-0315.3	330870	LATIGUILLO	4F0 611 707 B	
	3,2 FSI				83.7813-0315.3	330870	LATIGUILLO	4F0 611 707 B	
	3,2 FSI Quattro				83.7813-0315.3	330870	LATIGUILLO	4F0 611 707 B	
	4,2 FSI Quattro				83.7813-0315.3	330870	LATIGUILLO	4F0 611 707 B	
	4,2 Quattro				83.7813-0315.3	330870	LATIGUILLO	4F0 611 707 B	
	S6				83.7813-0315.3	330870	LATIGUILLO	4F0 611 707 B	
A6 Allroad (06-)	2,7 TDI				83.7813-0315.3	330870	LATIGUILLO	4F0 611 707 B	
	3,0 TDI				83.7813-0315.3	330870	LATIGUILLO	4F0 611 707 B	
	3,2 FSI				83.7813-0315.3	330870	LATIGUILLO	4F0 611 707 B	
	4,2 FSI				83.7813-0315.3	330870	LATIGUILLO	4F0 611 707 B	
Q7 (06-)	3,0 TDI		03.2006	10.2007	83.6212-0400.3	330865	LATIGUILLO	7L0 611 776 , 7L0 611 776 A	
			10.2007		83.6213-0515.3	330866	LATIGUILLO	7L0 611 701 A , 7L0 611 701 C	
			10.2007		83.6212-0400.3	330865	LATIGUILLO	7L0 611 776 , 7L0 611 776 A	
			03.2006	10.2007	83.6213-0515.3	330866	LATIGUILLO	7L0 611 701 A , 7L0 611 701 C	



					Denominación	Ref. OE correspondientes a las referencias ATE		Referencia anterior / varios
--	--	--	--	--	--------------	--	--	------------------------------

AUDI

Q7 (06-)	3,0 TDI		10.2007		03.0137-9288.2	669288	ACCESORIOS ZAPATAS	34 41 0 002 718 , 34 41 0 005 300 , 7L0 698 545 , 34 41 0 146 840 , 34 41 0 304 483 , 34 41 0 417 558	
			03.2006	10.2007	03.0137-9288.2	669288	ACCESORIOS ZAPATAS	34 41 0 002 718 , 34 41 0 005 300 , 7L0 698 545 , 34 41 0 146 840 , 34 41 0 304 483 , 34 41 0 417 558	
	3,6 FSI		08.2006		83.6212-0400.3	330865	LATIGUILLO	7L0 611 776 , 7L0 611 776 A	
			08.2006		83.6213-0515.3	330866	LATIGUILLO	7L0 611 701 A , 7L0 611 701 C	
			08.2006		03.0137-9288.2	669288	ACCESORIOS ZAPATAS	34 41 0 002 718 , 34 41 0 005 300 , 7L0 698 545 , 34 41 0 146 840 , 34 41 0 304 483 , 34 41 0 417 558	
	4,2 FSI		03.2006		83.6212-0400.3	330865	LATIGUILLO	7L0 611 776 , 7L0 611 776 A	
			03.2006		83.6213-0515.3	330866	LATIGUILLO	7L0 611 701 A , 7L0 611 701 C	
			03.2006		03.0137-9288.2	669288	ACCESORIOS ZAPATAS	34 41 0 002 718 , 34 41 0 005 300 , 7L0 698 545 , 34 41 0 146 840 , 34 41 0 304 483 , 34 41 0 417 558	
	4,2 TDI		03.2007		83.6212-0400.3	330865	LATIGUILLO	7L0 611 776 , 7L0 611 776 A	
			03.2007		83.6213-0515.3	330866	LATIGUILLO	7L0 611 701 A , 7L0 611 701 C	
			03.2007		03.0137-9288.2	669288	ACCESORIOS ZAPATAS	34 41 0 002 718 , 34 41 0 005 300 , 7L0 698 545 , 34 41 0 146 840 , 34 41 0 304 483 , 34 41 0 417 558	



	i				Denominación	Ref. OE correspondientes a las referencias ATE	i Referencia anterior / varios
---	----------	---	---	---	--------------	--	--





AUDI

TT Coupe (98-06)	3,2 Quattro		04.2003	06.2006	24.8190-0106.2	620106	CONTACTO DE DESGASTE	1J0 615 121	
TT Roadster (99-06)			04.2003	06.2006	24.8190-0106.2	620106	CONTACTO DE DESGASTE	1J0 615 121	

Nuevas referencias en almacén - Por aplicación

12/2007



					Denominación	Ref. OE correspondientes a las referencias ATE	 Referencia anterior / varios
---	---	---	---	---	--------------	--	--

BMW

1er Reihe/E81/E87 Limousine (04-)	116 i		09.2004		83.6152-0221.3	330858	LATIGUILLO	34 30 6 768 851 , 34 30 6 762 837	
			09.2004		83.6250-0180.3	330859	LATIGUILLO	34 30 6 762 838	
	118 d		03.2007		83.6152-0221.3	330858	LATIGUILLO	34 30 6 768 851 , 34 30 6 762 837	
			03.2007		83.6250-0180.3	330859	LATIGUILLO	34 30 6 762 838	
			09.2004	03.2007	83.6250-0180.3	330859	LATIGUILLO	34 30 6 762 838	
			09.2004	03.2007	83.6152-0221.3	330858	LATIGUILLO	34 30 6 768 851 , 34 30 6 762 837	
	118 i		03.2007		83.6250-0180.3	330859	LATIGUILLO	34 30 6 762 838	
			09.2004	03.2007	83.6152-0221.3	330858	LATIGUILLO	34 30 6 768 851 , 34 30 6 762 837	
			09.2004	03.2007	83.6250-0180.3	330859	LATIGUILLO	34 30 6 762 838	
			03.2007		83.6152-0221.3	330858	LATIGUILLO	34 30 6 768 851 , 34 30 6 762 837	
	120 d		09.2004	03.2007	83.6250-0180.3	330859	LATIGUILLO	34 30 6 762 838	
			03.2007		83.6152-0221.3	330858	LATIGUILLO	34 30 6 768 851 , 34 30 6 762 837	
			03.2007		83.6250-0180.3	330859	LATIGUILLO	34 30 6 762 838	
			09.2004	03.2007	83.6152-0221.3	330858	LATIGUILLO	34 30 6 768 851 , 34 30 6 762 837	
	120 i		03.2007		83.6250-0180.3	330859	LATIGUILLO	34 30 6 762 838	
			09.2004	03.2007	83.6250-0180.3	330859	LATIGUILLO	34 30 6 762 838	

Nuevas referencias en almacén - Por aplicación

12/2007



					Denominación	Ref. OE correspondientes a las referencias ATE		Referencia anterior / varios
--	--	--	--	--	--------------	--	--	------------------------------





BMW

1er Reihe/E81/E87 Limousine (04-)	120 i		03.2007		83.6152-0221.3	330858	LATIGUILLO	34 30 6 768 851 , 34 30 6 762 837	
			09.2004	03.2007	83.6152-0221.3	330858	LATIGUILLO	34 30 6 768 851 , 34 30 6 762 837	
	123 d		10.2007		83.6152-0221.3	330858	LATIGUILLO	34 30 6 768 851 , 34 30 6 762 837	
			10.2007		83.6250-0180.3	330859	LATIGUILLO	34 30 6 762 838	
	130 i		09.2005		83.6152-0221.3	330858	LATIGUILLO	34 30 6 768 851 , 34 30 6 762 837	
			09.2005		83.6250-0180.3	330859	LATIGUILLO	34 30 6 762 838	
1er Reihe/E82 Coupe (07-)	120 d		10.2007		83.6152-0221.3	330858	LATIGUILLO	34 30 6 768 851 , 34 30 6 762 837	
			10.2007		83.6250-0180.3	330859	LATIGUILLO	34 30 6 762 838	
	123 d		10.2007		83.6152-0221.3	330858	LATIGUILLO	34 30 6 768 851 , 34 30 6 762 837	
			10.2007		83.6250-0180.3	330859	LATIGUILLO	34 30 6 762 838	
	135 i		10.2007		83.6152-0221.3	330858	LATIGUILLO	34 30 6 768 851 , 34 30 6 762 837	
			10.2007		83.6250-0180.3	330859	LATIGUILLO	34 30 6 762 838	
Serie 3/E46 (98-06)	M3 Cabrio		05.2001	12.2006	03.0137-9288.2	669288	ACCESORIOS ZAPATAS	34 41 0 002 718 , 34 41 0 005 300 , 7L0 698 545 , 34 41 0 146 840 , 34 41 0 304 483 , 34 41 0 417 558	
	M3 Coupe		06.2000	08.2006	03.0137-9288.2	669288	ACCESORIOS ZAPATAS	34 41 0 002 718 , 34 41 0 005 300 , 7L0 698 545 , 34 41 0 146 840 , 34 41 0 304 483 , 34 41 0 417 558	

Nuevas referencias en almacén - Por aplicación

12/2007



					Denominación	Ref. OE correspondientes a las referencias ATE	 Referencia anterior / varios
---	---	---	---	---	--------------	--	--





BMW

Serie 3/E46 (98-06)	M3 CSL Coupe		05.2003	08.2006	03.0137-9288.2	669288	ACCESORIOS ZAPATAS	34 41 0 002 718 , 34 41 0 005 300 , 7L0 698 545 , 34 41 0 146 840 , 34 41 0 304 483 , 34 41 0 417 558	
Serie 3/E90 Berlina (05-)	316 i		01.2005		83.6250-0180.3	330859	LATIGUILLO	34 30 6 762 838	
			01.2005		83.6152-0221.3	330858	LATIGUILLO	34 30 6 768 851 , 34 30 6 762 837	
	318 d		09.2005		83.6152-0221.3	330858	LATIGUILLO	34 30 6 768 851 , 34 30 6 762 837	
			09.2005		83.6250-0180.3	330859	LATIGUILLO	34 30 6 762 838	
	318 i		09.2005		83.6250-0180.3	330859	LATIGUILLO	34 30 6 762 838	
			09.2005		83.6152-0221.3	330858	LATIGUILLO	34 30 6 768 851 , 34 30 6 762 837	
	320 d		12.2004		83.6250-0180.3	330859	LATIGUILLO	34 30 6 762 838	
			12.2004		83.6152-0221.3	330858	LATIGUILLO	34 30 6 768 851 , 34 30 6 762 837	
	320 i		12.2004		83.6250-0180.3	330859	LATIGUILLO	34 30 6 762 838	
			12.2004		83.6152-0221.3	330858	LATIGUILLO	34 30 6 768 851 , 34 30 6 762 837	
	320 si		06.2006		83.6250-0180.3	330859	LATIGUILLO	34 30 6 762 838	
			06.2006		83.6152-0221.3	330858	LATIGUILLO	34 30 6 768 851 , 34 30 6 762 837	
	325 d		09.2006		83.6250-0180.3	330859	LATIGUILLO	34 30 6 762 838	
			09.2006		83.6152-0221.3	330858	LATIGUILLO	34 30 6 768 851 , 34 30 6 762 837	

Nuevas referencias en almacén - Por aplicación

12/2007



					Denominación	Ref. OE correspondientes a las referencias ATE	 Referencia anterior / varios
---	---	---	---	---	--------------	--	--

BMW

Serie 3/E90 Berlina (05-)	325 i		12.2004		83.6250-0180.3	330859	LATIGUILLO	34 30 6 762 838	
			12.2004		83.6152-0221.3	330858	LATIGUILLO	34 30 6 768 851 , 34 30 6 762 837	
	325 xi		01.2005		83.6250-0180.3	330859	LATIGUILLO	34 30 6 762 838	
			01.2005		83.6152-0221.3	330858	LATIGUILLO	34 30 6 768 851 , 34 30 6 762 837	
		DI	01.2005		24.8190-0247.2	620247	CONTACTO DE DESGASTE	34 35 6 764 851 , 34 35 6 777 650	
		DI	09.2007		24.8190-0247.2	620247	CONTACTO DE DESGASTE	34 35 6 764 851 , 34 35 6 777 650	
		DI	01.2005	08.2007	24.8190-0247.2	620247	CONTACTO DE DESGASTE	34 35 6 764 851 , 34 35 6 777 650	
	330 d		09.2005		83.6152-0221.3	330858	LATIGUILLO	34 30 6 768 851 , 34 30 6 762 837	
			09.2005		83.6250-0180.3	330859	LATIGUILLO	34 30 6 762 838	
	330 i		12.2004		83.6250-0180.3	330859	LATIGUILLO	34 30 6 762 838	
			12.2004		83.6152-0221.3	330858	LATIGUILLO	34 30 6 768 851 , 34 30 6 762 837	
	330 xd		09.2005		83.6152-0221.3	330858	LATIGUILLO	34 30 6 768 851 , 34 30 6 762 837	
			09.2005		83.6250-0180.3	330859	LATIGUILLO	34 30 6 762 838	
		DI	09.2005	08.2007	24.8190-0247.2	620247	CONTACTO DE DESGASTE	34 35 6 764 851 , 34 35 6 777 650	
	330 xi		01.2005		83.6152-0221.3	330858	LATIGUILLO	34 30 6 768 851 , 34 30 6 762 837	

Nuevas referencias en almacén - Por aplicación

12/2007



					Denominación	Ref. OE correspondientes a las referencias ATE		Referencia anterior / varios
--	--	--	--	--	--------------	--	--	------------------------------







BMW

Serie 3/E90 Berlina (05-)	330 xi		01.2005		83.6250-0180.3	330859	LATIGUILLO	34 30 6 762 838	
		DI	01.2005		24.8190-0247.2	620247	CONTACTO DE DESGASTE	34 35 6 764 851 , 34 35 6 777 650	
		DI	01.2005	08.2007	24.8190-0247.2	620247	CONTACTO DE DESGASTE	34 35 6 764 851 , 34 35 6 777 650	
	335 d		09.2006		83.6250-0180.3	330859	LATIGUILLO	34 30 6 762 838	
			09.2006		83.6152-0221.3	330858	LATIGUILLO	34 30 6 768 851 , 34 30 6 762 837	
		DI	09.2006		24.8190-0246.2	620246	CONTACTO DE DESGASTE	34 35 6 777 649	
	335 i		09.2006		83.6250-0180.3	330859	LATIGUILLO	34 30 6 762 838	
			09.2006		83.6152-0221.3	330858	LATIGUILLO	34 30 6 768 851 , 34 30 6 762 837	
		DI	09.2006		24.8190-0246.2	620246	CONTACTO DE DESGASTE	34 35 6 777 649	
	335 xi		03.2007		83.6152-0221.3	330858	LATIGUILLO	34 30 6 768 851 , 34 30 6 762 837	
			03.2007		83.6250-0180.3	330859	LATIGUILLO	34 30 6 762 838	
Serie 3/E91 Touring (05-)	318 d		09.2005		83.6250-0180.3	330859	LATIGUILLO	34 30 6 762 838	
			09.2005		83.6152-0221.3	330858	LATIGUILLO	34 30 6 768 851 , 34 30 6 762 837	
	318 i		01.2006		83.6250-0180.3	330859	LATIGUILLO	34 30 6 762 838	
			01.2006		83.6152-0221.3	330858	LATIGUILLO	34 30 6 768 851 , 34 30 6 762 837	
	320 d		06.2005		83.6152-0221.3	330858	LATIGUILLO	34 30 6 768 851 , 34 30 6 762 837	

Nuevas referencias en almacén - Por aplicación

12/2007



					Denominación	Ref. OE correspondientes a las referencias ATE	 Referencia anterior / varios
---	---	---	---	---	--------------	--	--







BMW

Serie 3/E91 Touring (05-)	320 d		06.2005		83.6250-0180.3	330859	LATIGUILLO	34 30 6 762 838	
	320 i		06.2005		83.6152-0221.3	330858	LATIGUILLO	34 30 6 768 851 , 34 30 6 762 837	
			06.2005		83.6250-0180.3	330859	LATIGUILLO	34 30 6 762 838	
	323 i		06.2005		83.6250-0180.3	330859	LATIGUILLO	34 30 6 762 838	
			06.2005		83.6152-0221.3	330858	LATIGUILLO	34 30 6 768 851 , 34 30 6 762 837	
	325 d		09.2006		83.6152-0221.3	330858	LATIGUILLO	34 30 6 768 851 , 34 30 6 762 837	
			09.2006		83.6250-0180.3	330859	LATIGUILLO	34 30 6 762 838	
	325 i		06.2005		83.6152-0221.3	330858	LATIGUILLO	34 30 6 768 851 , 34 30 6 762 837	
			06.2005		83.6250-0180.3	330859	LATIGUILLO	34 30 6 762 838	
		DI	02.2007		24.8190-0247.2	620247	CONTACTO DE DESGASTE	34 35 6 764 851 , 34 35 6 777 650	
	325 xi		06.2005		83.6250-0180.3	330859	LATIGUILLO	34 30 6 762 838	
			06.2005		83.6152-0221.3	330858	LATIGUILLO	34 30 6 768 851 , 34 30 6 762 837	
		DI	02.2007		24.8190-0247.2	620247	CONTACTO DE DESGASTE	34 35 6 764 851 , 34 35 6 777 650	
		DI	06.2005		24.8190-0247.2	620247	CONTACTO DE DESGASTE	34 35 6 764 851 , 34 35 6 777 650	
	330 d		06.2005		83.6152-0221.3	330858	LATIGUILLO	34 30 6 768 851 , 34 30 6 762 837	

Nuevas referencias en almacén - Por aplicación

12/2007



					Denominación	Ref. OE correspondientes a las referencias ATE		Referencia anterior / varios
---	---	---	---	---	--------------	--	---	------------------------------

BMW

Serie 3/E91 Touring (05-)	330 d		06.2005		83.6250-0180.3	330859	LATIGUILLO	34 30 6 762 838	
	330 i		06.2005		83.6152-0221.3	330858	LATIGUILLO	34 30 6 768 851 , 34 30 6 762 837	
			06.2005		83.6250-0180.3	330859	LATIGUILLO	34 30 6 762 838	
	330 xd		06.2005		83.6152-0221.3	330858	LATIGUILLO	34 30 6 768 851 , 34 30 6 762 837	
			06.2005		83.6250-0180.3	330859	LATIGUILLO	34 30 6 762 838	
		DI	06.2005	08.2007	24.8190-0247.2	620247	CONTACTO DE DESGASTE	34 35 6 764 851 , 34 35 6 777 650	
		DI	09.2007		24.8190-0247.2	620247	CONTACTO DE DESGASTE	34 35 6 764 851 , 34 35 6 777 650	
	330 xi		06.2005		83.6250-0180.3	330859	LATIGUILLO	34 30 6 762 838	
			06.2005		83.6152-0221.3	330858	LATIGUILLO	34 30 6 768 851 , 34 30 6 762 837	
		DI	02.2007		24.8190-0247.2	620247	CONTACTO DE DESGASTE	34 35 6 764 851 , 34 35 6 777 650	
		DI	06.2005		24.8190-0247.2	620247	CONTACTO DE DESGASTE	34 35 6 764 851 , 34 35 6 777 650	
		DI	09.2007		24.8190-0247.2	620247	CONTACTO DE DESGASTE	34 35 6 764 851 , 34 35 6 777 650	
		DI	06.2005	08.2007	24.8190-0247.2	620247	CONTACTO DE DESGASTE	34 35 6 764 851 , 34 35 6 777 650	
	335 d		09.2006		83.6152-0221.3	330858	LATIGUILLO	34 30 6 768 851 , 34 30 6 762 837	
			09.2006		83.6250-0180.3	330859	LATIGUILLO	34 30 6 762 838	

Nuevas referencias en almacén - Por aplicación

12/2007



					Denominación	Ref. OE correspondientes a las referencias ATE		Referencia anterior / varios
--	--	--	--	--	--------------	--	--	------------------------------





BMW

Serie 3/E91 Touring (05-)	335 d	DI	09.2006		24.8190-0246.2	620246	CONTACTO DE DESGASTE	34 35 6 777 649	
	335 i		09.2006		83.6250-0180.3	330859	LATIGUILLO	34 30 6 762 838	
			09.2006		83.6152-0221.3	330858	LATIGUILLO	34 30 6 768 851 , 34 30 6 762 837	
		DI	09.2006		24.8190-0246.2	620246	CONTACTO DE DESGASTE	34 35 6 777 649	
	335 xi		03.2007		83.6250-0180.3	330859	LATIGUILLO	34 30 6 762 838	
			03.2007		83.6152-0221.3	330858	LATIGUILLO	34 30 6 768 851 , 34 30 6 762 837	
Serie 3/E92 Coupé (06-)	320 d		03.2007		83.6152-0221.3	330858	LATIGUILLO	34 30 6 768 851 , 34 30 6 762 837	
			03.2007		83.6250-0180.3	330859	LATIGUILLO	34 30 6 762 838	
	320 i		03.2007		83.6152-0221.3	330858	LATIGUILLO	34 30 6 768 851 , 34 30 6 762 837	
			03.2007		83.6250-0180.3	330859	LATIGUILLO	34 30 6 762 838	
	323 i		09.2006		83.6250-0180.3	330859	LATIGUILLO	34 30 6 762 838	
			09.2006		83.6152-0221.3	330858	LATIGUILLO	34 30 6 768 851 , 34 30 6 762 837	
	325 d		03.2007		83.6152-0221.3	330858	LATIGUILLO	34 30 6 768 851 , 34 30 6 762 837	
			03.2007		83.6250-0180.3	330859	LATIGUILLO	34 30 6 762 838	
	325 i		09.2006		83.6152-0221.3	330858	LATIGUILLO	34 30 6 768 851 , 34 30 6 762 837	
			09.2006		83.6250-0180.3	330859	LATIGUILLO	34 30 6 762 838	

Nuevas referencias en almacén - Por aplicación

12/2007



					Denominación	Ref. OE correspondientes a las referencias ATE	 Referencia anterior / varios
---	---	---	---	---	--------------	--	--





BMW

Serie 3/E92 Coupé (06-)	325 xi		09.2006		83.6152-0221.3	330858	LATIGUILLO	34 30 6 768 851 , 34 30 6 762 837	
			09.2006		83.6250-0180.3	330859	LATIGUILLO	34 30 6 762 838	
		DI	09.2006		24.8190-0247.2	620247	CONTACTO DE DESGASTE	34 35 6 764 851 , 34 35 6 777 650	
	330 d		09.2006		83.6152-0221.3	330858	LATIGUILLO	34 30 6 768 851 , 34 30 6 762 837	
			09.2006		83.6250-0180.3	330859	LATIGUILLO	34 30 6 762 838	
		DI	09.2006		24.8190-0246.2	620246	CONTACTO DE DESGASTE	34 35 6 777 649	
	330 i		09.2006		83.6250-0180.3	330859	LATIGUILLO	34 30 6 762 838	
			09.2006		83.6152-0221.3	330858	LATIGUILLO	34 30 6 768 851 , 34 30 6 762 837	
	330 xd		09.2006		83.6152-0221.3	330858	LATIGUILLO	34 30 6 768 851 , 34 30 6 762 837	
			09.2006		83.6250-0180.3	330859	LATIGUILLO	34 30 6 762 838	
		DI	09.2006		24.8190-0247.2	620247	CONTACTO DE DESGASTE	34 35 6 764 851 , 34 35 6 777 650	
	330 xi		09.2006		83.6250-0180.3	330859	LATIGUILLO	34 30 6 762 838	
			09.2006		83.6152-0221.3	330858	LATIGUILLO	34 30 6 768 851 , 34 30 6 762 837	
		DI	09.2006		24.8190-0247.2	620247	CONTACTO DE DESGASTE	34 35 6 764 851 , 34 35 6 777 650	
	335 d		09.2006		83.6250-0180.3	330859	LATIGUILLO	34 30 6 762 838	

Nuevas referencias en almacén - Por aplicación

12/2007



					Denominación	Ref. OE correspondientes a las referencias ATE	 Referencia anterior / varios
---	---	---	---	---	--------------	--	--





BMW

Serie 3/E92 Coupé (06-)	335 d		09.2006		83.6152-0221.3	330858	LATIGUILLO	34 30 6 768 851 , 34 30 6 762 837	
		DI	09.2006		24.8190-0246.2	620246	CONTACTO DE DESGASTE	34 35 6 777 649	
	335 i		09.2006		83.6152-0221.3	330858	LATIGUILLO	34 30 6 768 851 , 34 30 6 762 837	
			09.2006		83.6250-0180.3	330859	LATIGUILLO	34 30 6 762 838	
		DI	09.2006		24.8190-0246.2	620246	CONTACTO DE DESGASTE	34 35 6 777 649	
	335 xi		09.2007		83.6152-0221.3	330858	LATIGUILLO	34 30 6 768 851 , 34 30 6 762 837	
			09.2007		83.6250-0180.3	330859	LATIGUILLO	34 30 6 762 838	
		DI	09.2007		24.8190-0247.2	620247	CONTACTO DE DESGASTE	34 35 6 764 851 , 34 35 6 777 650	
	M3		03.2007		83.6250-0180.3	330859	LATIGUILLO	34 30 6 762 838	
Serie 3/E93 Cabrióle (07-)	320 i		03.2007		83.6250-0180.3	330859	LATIGUILLO	34 30 6 762 838	
			03.2007		83.6152-0221.3	330858	LATIGUILLO	34 30 6 768 851 , 34 30 6 762 837	
	325 d		09.2007		83.6250-0180.3	330859	LATIGUILLO	34 30 6 762 838	
			09.2007		83.6152-0221.3	330858	LATIGUILLO	34 30 6 768 851 , 34 30 6 762 837	
	325 i		03.2007		83.6250-0180.3	330859	LATIGUILLO	34 30 6 762 838	
			03.2007		83.6152-0221.3	330858	LATIGUILLO	34 30 6 768 851 , 34 30 6 762 837	
	330 d		03.2007		83.6250-0180.3	330859	LATIGUILLO	34 30 6 762 838	

Nuevas referencias en almacén - Por aplicación

12/2007



					Denominación	Ref. OE correspondientes a las referencias ATE		Referencia anterior / varios
---	---	---	---	---	--------------	--	---	------------------------------

BMW

Serie 3/E93 Cabrióle (07-)	330 d		03.2007		83.6152-0221.3	330858	LATIGUILLO	34 30 6 768 851 , 34 30 6 762 837	
	330 i		03.2007		83.6250-0180.3	330859	LATIGUILLO	34 30 6 762 838	
			03.2007		83.6152-0221.3	330858	LATIGUILLO	34 30 6 768 851 , 34 30 6 762 837	
	335 i		03.2007		83.6250-0180.3	330859	LATIGUILLO	34 30 6 762 838	
			03.2007		83.6152-0221.3	330858	LATIGUILLO	34 30 6 768 851 , 34 30 6 762 837	
Serie 5/E39 (96-03)	M5		10.1998	07.2003	03.0137-9288.2	669288	ACCESORIOS ZAPATAS	34 41 0 002 718 , 34 41 0 005 300 , 7L0 698 545 , 34 41 0 146 840 , 34 41 0 304 483 , 34 41 0 417 558	
Serie 5/E60 Berlina (03-)	520 d		07.2005		83.6151-0552.3	330857	LATIGUILLO	34 32 6 760 909 , 34 32 6 767 390	
			07.2005		03.0137-9288.2	669288	ACCESORIOS ZAPATAS	34 41 0 002 718 , 34 41 0 005 300 , 7L0 698 545 , 34 41 0 146 840 , 34 41 0 304 483 , 34 41 0 417 558	
	520 i		07.2003	03.2005	83.6151-0552.3	330857	LATIGUILLO	34 32 6 760 909 , 34 32 6 767 390	
			07.2003	03.2005	03.0137-9288.2	669288	ACCESORIOS ZAPATAS	34 41 0 002 718 , 34 41 0 005 300 , 7L0 698 545 , 34 41 0 146 840 , 34 41 0 304 483 , 34 41 0 417 558	
	523 i		03.2007		83.6151-0552.3	330857	LATIGUILLO	34 32 6 760 909 , 34 32 6 767 390	
			07.2005	03.2007	83.6151-0552.3	330857	LATIGUILLO	34 32 6 760 909 , 34 32 6 767 390	

Nuevas referencias en almacén - Por aplicación

12/2007



	i				Denominación	Ref. OE correspondientes a las referencias ATE	i Referencia anterior / varios
--	----------	--	--	--	--------------	--	--

BMW

Serie 5/E60 Berlina (03-)	523 i		07.2005	03.2007	03.0137-9288.2	669288	ACCESORIOS ZAPATAS	34 41 0 002 718 , 34 41 0 005 300 , 7L0 698 545 , 34 41 0 146 840 , 34 41 0 304 483 , 34 41 0 417 558	
			03.2007		03.0137-9288.2	669288	ACCESORIOS ZAPATAS	34 41 0 002 718 , 34 41 0 005 300 , 7L0 698 545 , 34 41 0 146 840 , 34 41 0 304 483 , 34 41 0 417 558	
	525 d		03.2007		83.6151-0552.3	330857	LATIGUILLO	34 32 6 760 909 , 34 32 6 767 390	
			10.2003	03.2007	83.6151-0552.3	330857	LATIGUILLO	34 32 6 760 909 , 34 32 6 767 390	
			03.2007		03.0137-9288.2	669288	ACCESORIOS ZAPATAS	34 41 0 002 718 , 34 41 0 005 300 , 7L0 698 545 , 34 41 0 146 840 , 34 41 0 304 483 , 34 41 0 417 558	
			10.2003	03.2007	03.0137-9288.2	669288	ACCESORIOS ZAPATAS	34 41 0 002 718 , 34 41 0 005 300 , 7L0 698 545 , 34 41 0 146 840 , 34 41 0 304 483 , 34 41 0 417 558	
	525 i		07.2003	06.2005	83.6151-0552.3	330857	LATIGUILLO	34 32 6 760 909 , 34 32 6 767 390	
			07.2005		83.6151-0552.3	330857	LATIGUILLO	34 32 6 760 909 , 34 32 6 767 390	
			07.2005		03.0137-9288.2	669288	ACCESORIOS ZAPATAS	34 41 0 002 718 , 34 41 0 005 300 , 7L0 698 545 , 34 41 0 146 840 , 34 41 0 304 483 , 34 41 0 417 558	
			07.2003	06.2005	03.0137-9288.2	669288	ACCESORIOS ZAPATAS	34 41 0 002 718 , 34 41 0 005 300 , 7L0 698 545 , 34 41 0 146 840 , 34 41 0 304 483 , 34 41 0 417 558	

Nuevas referencias en almacén - Por aplicación

12/2007



					Denominación	Ref. OE correspondientes a las referencias ATE		Referencia anterior / varios
--	--	--	--	--	--------------	--	--	------------------------------

BMW

Serie 5/E60 Berlina (03-)	525 xi		07.2005	03.2007	83.6151-0552.3	330857	LATIGUILLO	34 32 6 760 909 , 34 32 6 767 390	
			07.2005		03.0137-9288.2	669288	ACCESORIOS ZAPATAS	34 41 0 002 718 , 34 41 0 005 300 , 7L0 698 545 , 34 41 0 146 840 , 34 41 0 304 483 , 34 41 0 417 558	
	530 d		03.2007		83.6151-0552.3	330857	LATIGUILLO	34 32 6 760 909 , 34 32 6 767 390	
			07.2003	03.2007	83.6151-0552.3	330857	LATIGUILLO	34 32 6 760 909 , 34 32 6 767 390	
			07.2003	08.2005	83.6151-0552.3	330857	LATIGUILLO	34 32 6 760 909 , 34 32 6 767 390	
			07.2003	03.2007	03.0137-9288.2	669288	ACCESORIOS ZAPATAS	34 41 0 002 718 , 34 41 0 005 300 , 7L0 698 545 , 34 41 0 146 840 , 34 41 0 304 483 , 34 41 0 417 558	
			03.2007		03.0137-9288.2	669288	ACCESORIOS ZAPATAS	34 41 0 002 718 , 34 41 0 005 300 , 7L0 698 545 , 34 41 0 146 840 , 34 41 0 304 483 , 34 41 0 417 558	
			07.2003	08.2005	03.0137-9288.2	669288	ACCESORIOS ZAPATAS	34 41 0 002 718 , 34 41 0 005 300 , 7L0 698 545 , 34 41 0 146 840 , 34 41 0 304 483 , 34 41 0 417 558	
	530 i		07.2003	03.2005	83.6151-0552.3	330857	LATIGUILLO	34 32 6 760 909 , 34 32 6 767 390	
			03.2007		83.6151-0552.3	330857	LATIGUILLO	34 32 6 760 909 , 34 32 6 767 390	
			07.2005	03.2007	83.6151-0552.3	330857	LATIGUILLO	34 32 6 760 909 , 34 32 6 767 390	

Nuevas referencias en almacén - Por aplicación

12/2007



					Denominación	Ref. OE correspondientes a las referencias ATE		Referencia anterior / varios
--	--	--	--	--	--------------	--	--	------------------------------

BMW

Serie 5/E60 Berlina (03-)	530 i		07.2003	03.2005	03.0137-9288.2	669288	ACCESORIOS ZAPATAS	34 41 0 002 718 , 34 41 0 005 300 , 7L0 698 545 , 34 41 0 146 840 , 34 41 0 304 483 , 34 41 0 417 558	
			07.2005	03.2007	03.0137-9288.2	669288	ACCESORIOS ZAPATAS	34 41 0 002 718 , 34 41 0 005 300 , 7L0 698 545 , 34 41 0 146 840 , 34 41 0 304 483 , 34 41 0 417 558	
			03.2007		03.0137-9288.2	669288	ACCESORIOS ZAPATAS	34 41 0 002 718 , 34 41 0 005 300 , 7L0 698 545 , 34 41 0 146 840 , 34 41 0 304 483 , 34 41 0 417 558	
	530 xd		07.2005	03.2007	83.6151-0552.3	330857	LATIGUILLO	34 32 6 760 909 , 34 32 6 767 390	
			07.2005	03.2007	03.0137-9288.2	669288	ACCESORIOS ZAPATAS	34 41 0 002 718 , 34 41 0 005 300 , 7L0 698 545 , 34 41 0 146 840 , 34 41 0 304 483 , 34 41 0 417 558	
			03.2007		03.0137-9288.2	669288	ACCESORIOS ZAPATAS	34 41 0 002 718 , 34 41 0 005 300 , 7L0 698 545 , 34 41 0 146 840 , 34 41 0 304 483 , 34 41 0 417 558	
	530 xi		07.2005	03.2007	83.6151-0552.3	330857	LATIGUILLO	34 32 6 760 909 , 34 32 6 767 390	
			03.2007		03.0137-9288.2	669288	ACCESORIOS ZAPATAS	34 41 0 002 718 , 34 41 0 005 300 , 7L0 698 545 , 34 41 0 146 840 , 34 41 0 304 483 , 34 41 0 417 558	
			07.2005	03.2007	03.0137-9288.2	669288	ACCESORIOS ZAPATAS	34 41 0 002 718 , 34 41 0 005 300 , 7L0 698 545 , 34 41 0 146 840 , 34 41 0 304 483 , 34 41 0 417 558	

Nuevas referencias en almacén - Por aplicación

12/2007



					Denominación	Ref. OE correspondientes a las referencias ATE		Referencia anterior / varios
--	--	--	--	--	--------------	--	--	------------------------------



BMW

Serie 5/E60 Berlina (03-)	535 d		03.2007		83.6151-0552.3	330857	LATIGUILLO	34 32 6 760 909 , 34 32 6 767 390	
			09.2004	03.2007	83.6151-0552.3	330857	LATIGUILLO	34 32 6 760 909 , 34 32 6 767 390	
			03.2007		03.0137-9288.2	669288	ACCESORIOS ZAPATAS	34 41 0 002 718 , 34 41 0 005 300 , 7L0 698 545 , 34 41 0 146 840 , 34 41 0 304 483 , 34 41 0 417 558	
			09.2004	03.2007	03.0137-9288.2	669288	ACCESORIOS ZAPATAS	34 41 0 002 718 , 34 41 0 005 300 , 7L0 698 545 , 34 41 0 146 840 , 34 41 0 304 483 , 34 41 0 417 558	
	540 i		07.2005		83.6151-0552.3	330857	LATIGUILLO	34 32 6 760 909 , 34 32 6 767 390	
			07.2005		03.0137-9288.2	669288	ACCESORIOS ZAPATAS	34 41 0 002 718 , 34 41 0 005 300 , 7L0 698 545 , 34 41 0 146 840 , 34 41 0 304 483 , 34 41 0 417 558	
	545 i		07.2003	08.2005	83.6151-0552.3	330857	LATIGUILLO	34 32 6 760 909 , 34 32 6 767 390	
			07.2003	08.2005	03.0137-9288.2	669288	ACCESORIOS ZAPATAS	34 41 0 002 718 , 34 41 0 005 300 , 7L0 698 545 , 34 41 0 146 840 , 34 41 0 304 483 , 34 41 0 417 558	
	550 i		07.2005		83.6151-0552.3	330857	LATIGUILLO	34 32 6 760 909 , 34 32 6 767 390	
			07.2005		03.0137-9288.2	669288	ACCESORIOS ZAPATAS	34 41 0 002 718 , 34 41 0 005 300 , 7L0 698 545 , 34 41 0 146 840 , 34 41 0 304 483 , 34 41 0 417 558	

Nuevas referencias en almacén - Por aplicación

12/2007



					Denominación	Ref. OE correspondientes a las referencias ATE	 Referencia anterior / varios
---	---	---	---	---	--------------	--	--

BMW

Serie 5/E60 Berlina (03-)	M5		09.2004		83.6151-0552.3	330857	LATIGUILLO	34 32 6 760 909 , 34 32 6 767 390	
			09.2004		03.0137-9288.2	669288	ACCESORIOS ZAPATAS	34 41 0 002 718 , 34 41 0 005 300 , 7L0 698 545 , 34 41 0 146 840 , 34 41 0 304 483 , 34 41 0 417 558	
Serie 5/E61 Touring (04-)	520 d		07.2005		83.6151-0552.3	330857	LATIGUILLO	34 32 6 760 909 , 34 32 6 767 390	
			07.2005		03.0137-9288.2	669288	ACCESORIOS ZAPATAS	34 41 0 002 718 , 34 41 0 005 300 , 7L0 698 545 , 34 41 0 146 840 , 34 41 0 304 483 , 34 41 0 417 558	
	523 i		07.2005	03.2007	83.6151-0552.3	330857	LATIGUILLO	34 32 6 760 909 , 34 32 6 767 390	
			03.2007		83.6151-0552.3	330857	LATIGUILLO	34 32 6 760 909 , 34 32 6 767 390	
			03.2007		03.0137-9288.2	669288	ACCESORIOS ZAPATAS	34 41 0 002 718 , 34 41 0 005 300 , 7L0 698 545 , 34 41 0 146 840 , 34 41 0 304 483 , 34 41 0 417 558	
			07.2005	03.2007	03.0137-9288.2	669288	ACCESORIOS ZAPATAS	34 41 0 002 718 , 34 41 0 005 300 , 7L0 698 545 , 34 41 0 146 840 , 34 41 0 304 483 , 34 41 0 417 558	
	525 d		03.2007		83.6151-0552.3	330857	LATIGUILLO	34 32 6 760 909 , 34 32 6 767 390	
			05.2004	03.2007	83.6151-0552.3	330857	LATIGUILLO	34 32 6 760 909 , 34 32 6 767 390	

Nuevas referencias en almacén - Por aplicación

12/2007



					Denominación	Ref. OE correspondientes a las referencias ATE		Referencia anterior / varios
--	--	--	--	--	--------------	--	--	------------------------------

BMW

Serie 5/E61 Touring (04-)	525 d		03.2007		03.0137-9288.2	669288	ACCESORIOS ZAPATAS	34 41 0 002 718 , 34 41 0 005 300 , 7L0 698 545 , 34 41 0 146 840 , 34 41 0 304 483 , 34 41 0 417 558	
			05.2004	03.2007	03.0137-9288.2	669288	ACCESORIOS ZAPATAS	34 41 0 002 718 , 34 41 0 005 300 , 7L0 698 545 , 34 41 0 146 840 , 34 41 0 304 483 , 34 41 0 417 558	
	525 i		05.2004	03.2005	83.6151-0552.3	330857	LATIGUILLO	34 32 6 760 909 , 34 32 6 767 390	
			07.2005		83.6151-0552.3	330857	LATIGUILLO	34 32 6 760 909 , 34 32 6 767 390	
			05.2004	03.2005	03.0137-9288.2	669288	ACCESORIOS ZAPATAS	34 41 0 002 718 , 34 41 0 005 300 , 7L0 698 545 , 34 41 0 146 840 , 34 41 0 304 483 , 34 41 0 417 558	
			07.2005		03.0137-9288.2	669288	ACCESORIOS ZAPATAS	34 41 0 002 718 , 34 41 0 005 300 , 7L0 698 545 , 34 41 0 146 840 , 34 41 0 304 483 , 34 41 0 417 558	
	525 xi		07.2005		03.0137-9288.2	669288	ACCESORIOS ZAPATAS	34 41 0 002 718 , 34 41 0 005 300 , 7L0 698 545 , 34 41 0 146 840 , 34 41 0 304 483 , 34 41 0 417 558	
	530 d		05.2004	08.2005	83.6151-0552.3	330857	LATIGUILLO	34 32 6 760 909 , 34 32 6 767 390	
			03.2007		83.6151-0552.3	330857	LATIGUILLO	34 32 6 760 909 , 34 32 6 767 390	
			07.2005	03.2007	83.6151-0552.3	330857	LATIGUILLO	34 32 6 760 909 , 34 32 6 767 390	

Nuevas referencias en almacén - Por aplicación

12/2007



					Denominación	Ref. OE correspondientes a las referencias ATE		Referencia anterior / varios
--	--	--	--	--	--------------	--	--	------------------------------

BMW

Serie 5/E61 Touring (04-)	530 d		03.2007		03.0137-9288.2	669288	ACCESORIOS ZAPATAS	34 41 0 002 718 , 34 41 0 005 300 , 7L0 698 545 , 34 41 0 146 840 , 34 41 0 304 483 , 34 41 0 417 558	
			07.2005	03.2007	03.0137-9288.2	669288	ACCESORIOS ZAPATAS	34 41 0 002 718 , 34 41 0 005 300 , 7L0 698 545 , 34 41 0 146 840 , 34 41 0 304 483 , 34 41 0 417 558	
			05.2004	08.2005	03.0137-9288.2	669288	ACCESORIOS ZAPATAS	34 41 0 002 718 , 34 41 0 005 300 , 7L0 698 545 , 34 41 0 146 840 , 34 41 0 304 483 , 34 41 0 417 558	
	530 i		07.2005	03.2007	83.6151-0552.3	330857	LATIGUILLO	34 32 6 760 909 , 34 32 6 767 390	
			03.2007		83.6151-0552.3	330857	LATIGUILLO	34 32 6 760 909 , 34 32 6 767 390	
			03.2007		03.0137-9288.2	669288	ACCESORIOS ZAPATAS	34 41 0 002 718 , 34 41 0 005 300 , 7L0 698 545 , 34 41 0 146 840 , 34 41 0 304 483 , 34 41 0 417 558	
			07.2005	03.2007	03.0137-9288.2	669288	ACCESORIOS ZAPATAS	34 41 0 002 718 , 34 41 0 005 300 , 7L0 698 545 , 34 41 0 146 840 , 34 41 0 304 483 , 34 41 0 417 558	
	530 xd		07.2005	03.2007	03.0137-9288.2	669288	ACCESORIOS ZAPATAS	34 41 0 002 718 , 34 41 0 005 300 , 7L0 698 545 , 34 41 0 146 840 , 34 41 0 304 483 , 34 41 0 417 558	
			03.2007		03.0137-9288.2	669288	ACCESORIOS ZAPATAS	34 41 0 002 718 , 34 41 0 005 300 , 7L0 698 545 , 34 41 0 146 840 , 34 41 0 304 483 , 34 41 0 417 558	

Nuevas referencias en almacén - Por aplicación

12/2007



					Denominación	Ref. OE correspondientes a las referencias ATE		Referencia anterior / varios
--	--	--	--	--	--------------	--	--	------------------------------

BMW

Serie 5/E61 Touring (04-)	530 xi		03.2007		03.0137-9288.2	669288	ACCESORIOS ZAPATAS	34 41 0 002 718 , 34 41 0 005 300 , 7L0 698 545 , 34 41 0 146 840 , 34 41 0 304 483 , 34 41 0 417 558	
			07.2005	03.2007	03.0137-9288.2	669288	ACCESORIOS ZAPATAS	34 41 0 002 718 , 34 41 0 005 300 , 7L0 698 545 , 34 41 0 146 840 , 34 41 0 304 483 , 34 41 0 417 558	
	535 d		03.2007		83.6151-0552.3	330857	LATIGUILLO	34 32 6 760 909 , 34 32 6 767 390	
			09.2004	03.2007	83.6151-0552.3	330857	LATIGUILLO	34 32 6 760 909 , 34 32 6 767 390	
			09.2004	03.2007	03.0137-9288.2	669288	ACCESORIOS ZAPATAS	34 41 0 002 718 , 34 41 0 005 300 , 7L0 698 545 , 34 41 0 146 840 , 34 41 0 304 483 , 34 41 0 417 558	
			03.2007		03.0137-9288.2	669288	ACCESORIOS ZAPATAS	34 41 0 002 718 , 34 41 0 005 300 , 7L0 698 545 , 34 41 0 146 840 , 34 41 0 304 483 , 34 41 0 417 558	
	545 i		05.2004	08.2005	83.6151-0552.3	330857	LATIGUILLO	34 32 6 760 909 , 34 32 6 767 390	
			05.2004	08.2005	03.0137-9288.2	669288	ACCESORIOS ZAPATAS	34 41 0 002 718 , 34 41 0 005 300 , 7L0 698 545 , 34 41 0 146 840 , 34 41 0 304 483 , 34 41 0 417 558	
	550 i		07.2005		83.6151-0552.3	330857	LATIGUILLO	34 32 6 760 909 , 34 32 6 767 390	
			07.2005		03.0137-9288.2	669288	ACCESORIOS ZAPATAS	34 41 0 002 718 , 34 41 0 005 300 , 7L0 698 545 , 34 41 0 146 840 , 34 41 0 304 483 , 34 41 0 417 558	

Nuevas referencias en almacén - Por aplicación

12/2007



					Denominación	Ref. OE correspondientes a las referencias ATE		Referencia anterior / varios
--	--	--	--	--	--------------	--	--	------------------------------

BMW

Serie 5/E61 Touring (04-)	M5		02.2007		83.6151-0552.3	330857	LATIGUILLO	34 32 6 760 909 , 34 32 6 767 390	
			02.2007		03.0137-9288.2	669288	ACCESORIOS ZAPATAS	34 41 0 002 718 , 34 41 0 005 300 , 7L0 698 545 , 34 41 0 146 840 , 34 41 0 304 483 , 34 41 0 417 558	
Serie 6/E63 Coupé (04-)	630 i		09.2007		83.6151-0552.3	330857	LATIGUILLO	34 32 6 760 909 , 34 32 6 767 390	
			07.2004	08.2007	83.6151-0552.3	330857	LATIGUILLO	34 32 6 760 909 , 34 32 6 767 390	
			09.2007		03.0137-9288.2	669288	ACCESORIOS ZAPATAS	34 41 0 002 718 , 34 41 0 005 300 , 7L0 698 545 , 34 41 0 146 840 , 34 41 0 304 483 , 34 41 0 417 558	
			07.2004	08.2007	03.0137-9288.2	669288	ACCESORIOS ZAPATAS	34 41 0 002 718 , 34 41 0 005 300 , 7L0 698 545 , 34 41 0 146 840 , 34 41 0 304 483 , 34 41 0 417 558	
	635 d		09.2007		83.6151-0552.3	330857	LATIGUILLO	34 32 6 760 909 , 34 32 6 767 390	
			09.2007		03.0137-9288.2	669288	ACCESORIOS ZAPATAS	34 41 0 002 718 , 34 41 0 005 300 , 7L0 698 545 , 34 41 0 146 840 , 34 41 0 304 483 , 34 41 0 417 558	
	645 Ci		12.2003	08.2007	83.6151-0552.3	330857	LATIGUILLO	34 32 6 760 909 , 34 32 6 767 390	
			12.2003	08.2007	03.0137-9288.2	669288	ACCESORIOS ZAPATAS	34 41 0 002 718 , 34 41 0 005 300 , 7L0 698 545 , 34 41 0 146 840 , 34 41 0 304 483 , 34 41 0 417 558	

Nuevas referencias en almacén - Por aplicación

12/2007



					Denominación	Ref. OE correspondientes a las referencias ATE		Referencia anterior / varios
--	--	--	--	--	--------------	--	--	------------------------------

BMW

Serie 6/E63 Coupé (04-)	650 i		07.2005		83.6151-0552.3	330857	LATIGUILLO	34 32 6 760 909 , 34 32 6 767 390	
			07.2005		03.0137-9288.2	669288	ACCESORIOS ZAPATAS	34 41 0 002 718 , 34 41 0 005 300 , 7L0 698 545 , 34 41 0 146 840 , 34 41 0 304 483 , 34 41 0 417 558	
	M6		06.2005		83.6151-0552.3	330857	LATIGUILLO	34 32 6 760 909 , 34 32 6 767 390	
			06.2005		03.0137-9288.2	669288	ACCESORIOS ZAPATAS	34 41 0 002 718 , 34 41 0 005 300 , 7L0 698 545 , 34 41 0 146 840 , 34 41 0 304 483 , 34 41 0 417 558	
Serie 6/E64 Cabriolé (04-)	630 i		09.2007		83.6151-0552.3	330857	LATIGUILLO	34 32 6 760 909 , 34 32 6 767 390	
			07.2004	08.2007	83.6151-0552.3	330857	LATIGUILLO	34 32 6 760 909 , 34 32 6 767 390	
			09.2007		03.0137-9288.2	669288	ACCESORIOS ZAPATAS	34 41 0 002 718 , 34 41 0 005 300 , 7L0 698 545 , 34 41 0 146 840 , 34 41 0 304 483 , 34 41 0 417 558	
			07.2004	08.2007	03.0137-9288.2	669288	ACCESORIOS ZAPATAS	34 41 0 002 718 , 34 41 0 005 300 , 7L0 698 545 , 34 41 0 146 840 , 34 41 0 304 483 , 34 41 0 417 558	
	635 d		09.2007		83.6151-0552.3	330857	LATIGUILLO	34 32 6 760 909 , 34 32 6 767 390	
			09.2007		03.0137-9288.2	669288	ACCESORIOS ZAPATAS	34 41 0 002 718 , 34 41 0 005 300 , 7L0 698 545 , 34 41 0 146 840 , 34 41 0 304 483 , 34 41 0 417 558	



					Denominación	Ref. OE correspondientes a las referencias ATE		Referencia anterior / varios
--	--	--	--	--	--------------	--	--	------------------------------





BMW

Serie 6/E64 Cabrióle (04-)	645 Ci		04.2004	08.2007	83.6151-0552.3	330857	LATIGUILLO	34 32 6 760 909 , 34 32 6 767 390	
			04.2004	08.2007	03.0137-9288.2	669288	ACCESORIOS ZAPATAS	34 41 0 002 718 , 34 41 0 005 300 , 7L0 698 545 , 34 41 0 146 840 , 34 41 0 304 483 , 34 41 0 417 558	
	650 i		07.2005		83.6151-0552.3	330857	LATIGUILLO	34 32 6 760 909 , 34 32 6 767 390	
			07.2005		03.0137-9288.2	669288	ACCESORIOS ZAPATAS	34 41 0 002 718 , 34 41 0 005 300 , 7L0 698 545 , 34 41 0 146 840 , 34 41 0 304 483 , 34 41 0 417 558	
	M6		07.2006		83.6151-0552.3	330857	LATIGUILLO	34 32 6 760 909 , 34 32 6 767 390	
Serie 7/E65-66 (02-)	730 d		09.2002		03.0137-9288.2	669288	ACCESORIOS ZAPATAS	34 41 0 002 718 , 34 41 0 005 300 , 7L0 698 545 , 34 41 0 146 840 , 34 41 0 304 483 , 34 41 0 417 558	
	730 i		03.2003		03.0137-9288.2	669288	ACCESORIOS ZAPATAS	34 41 0 002 718 , 34 41 0 005 300 , 7L0 698 545 , 34 41 0 146 840 , 34 41 0 304 483 , 34 41 0 417 558	
	730 i,Li		07.2005		03.0137-9288.2	669288	ACCESORIOS ZAPATAS	34 41 0 002 718 , 34 41 0 005 300 , 7L0 698 545 , 34 41 0 146 840 , 34 41 0 304 483 , 34 41 0 417 558	
	730 Ld		03.2005		03.0137-9288.2	669288	ACCESORIOS ZAPATAS	34 41 0 002 718 , 34 41 0 005 300 , 7L0 698 545 , 34 41 0 146 840 , 34 41 0 304 483 , 34 41 0 417 558	

Nuevas referencias en almacén - Por aplicación

12/2007



					Denominación	Ref. OE correspondientes a las referencias ATE	 Referencia anterior / varios
---	---	---	---	---	--------------	--	--

BMW

Serie 7/E65-66 (02-)	730 Li		03.2003		03.0137-9288.2	669288	ACCESORIOS ZAPATAS	34 41 0 002 718 , 34 41 0 005 300 , 7L0 698 545 , 34 41 0 146 840 , 34 41 0 304 483 , 34 41 0 417 558	
	735 i		11.2001		03.0137-9288.2	669288	ACCESORIOS ZAPATAS	34 41 0 002 718 , 34 41 0 005 300 , 7L0 698 545 , 34 41 0 146 840 , 34 41 0 304 483 , 34 41 0 417 558	
	735 Li		04.2002		03.0137-9288.2	669288	ACCESORIOS ZAPATAS	34 41 0 002 718 , 34 41 0 005 300 , 7L0 698 545 , 34 41 0 146 840 , 34 41 0 304 483 , 34 41 0 417 558	
	740 d		09.2002		03.0137-9288.2	669288	ACCESORIOS ZAPATAS	34 41 0 002 718 , 34 41 0 005 300 , 7L0 698 545 , 34 41 0 146 840 , 34 41 0 304 483 , 34 41 0 417 558	
	740 i,Li		03.2005		03.0137-9288.2	669288	ACCESORIOS ZAPATAS	34 41 0 002 718 , 34 41 0 005 300 , 7L0 698 545 , 34 41 0 146 840 , 34 41 0 304 483 , 34 41 0 417 558	
	745 d		03.2005		03.0137-9288.2	669288	ACCESORIOS ZAPATAS	34 41 0 002 718 , 34 41 0 005 300 , 7L0 698 545 , 34 41 0 146 840 , 34 41 0 304 483 , 34 41 0 417 558	
	745 i		11.2001		03.0137-9288.2	669288	ACCESORIOS ZAPATAS	34 41 0 002 718 , 34 41 0 005 300 , 7L0 698 545 , 34 41 0 146 840 , 34 41 0 304 483 , 34 41 0 417 558	
	745 Li		04.2002		03.0137-9288.2	669288	ACCESORIOS ZAPATAS	34 41 0 002 718 , 34 41 0 005 300 , 7L0 698 545 , 34 41 0 146 840 , 34 41 0 304 483 , 34 41 0 417 558	

Nuevas referencias en almacén - Por aplicación

12/2007



					Denominación	Ref. OE correspondientes a las referencias ATE		Referencia anterior / varios
--	--	--	--	--	--------------	--	--	------------------------------

BMW

Serie 7/E65-66 (02-)	750 i		03.2005		03.0137-9288.2	669288	ACCESORIOS ZAPATAS	34 41 0 002 718 , 34 41 0 005 300 , 7L0 698 545 , 34 41 0 146 840 , 34 41 0 304 483 , 34 41 0 417 558	
	750 Li		03.2005		03.0137-9288.2	669288	ACCESORIOS ZAPATAS	34 41 0 002 718 , 34 41 0 005 300 , 7L0 698 545 , 34 41 0 146 840 , 34 41 0 304 483 , 34 41 0 417 558	
	760 i		03.2003		03.0137-9288.2	669288	ACCESORIOS ZAPATAS	34 41 0 002 718 , 34 41 0 005 300 , 7L0 698 545 , 34 41 0 146 840 , 34 41 0 304 483 , 34 41 0 417 558	
	760 Li		03.2003		03.0137-9288.2	669288	ACCESORIOS ZAPATAS	34 41 0 002 718 , 34 41 0 005 300 , 7L0 698 545 , 34 41 0 146 840 , 34 41 0 304 483 , 34 41 0 417 558	
X3 (03-)	2,0 d		08.2004		03.0137-9288.2	669288	ACCESORIOS ZAPATAS	34 41 0 002 718 , 34 41 0 005 300 , 7L0 698 545 , 34 41 0 146 840 , 34 41 0 304 483 , 34 41 0 417 558	
	2,0 i		07.2005		03.0137-9288.2	669288	ACCESORIOS ZAPATAS	34 41 0 002 718 , 34 41 0 005 300 , 7L0 698 545 , 34 41 0 146 840 , 34 41 0 304 483 , 34 41 0 417 558	
	2,5 i		03.2004	08.2006	03.0137-9288.2	669288	ACCESORIOS ZAPATAS	34 41 0 002 718 , 34 41 0 005 300 , 7L0 698 545 , 34 41 0 146 840 , 34 41 0 304 483 , 34 41 0 417 558	
	2,5 si		09.2006		03.0137-9288.2	669288	ACCESORIOS ZAPATAS	34 41 0 002 718 , 34 41 0 005 300 , 7L0 698 545 , 34 41 0 146 840 , 34 41 0 304 483 , 34 41 0 417 558	

Nuevas referencias en almacén - Por aplicación

12/2007



					Denominación	Ref. OE correspondientes a las referencias ATE		Referencia anterior / varios
--	--	--	--	--	--------------	--	--	------------------------------



BMW

X3 (03-)	3,0 d		10.2003	08.2006	03.0137-9288.2	669288	ACCESORIOS ZAPATAS	34 41 0 002 718 , 34 41 0 005 300 , 7L0 698 545 , 34 41 0 146 840 , 34 41 0 304 483 , 34 41 0 417 558	
			01.2004		03.0137-9288.2	669288	ACCESORIOS ZAPATAS	34 41 0 002 718 , 34 41 0 005 300 , 7L0 698 545 , 34 41 0 146 840 , 34 41 0 304 483 , 34 41 0 417 558	
	3,0 i		10.2003	08.2006	03.0137-9288.2	669288	ACCESORIOS ZAPATAS	34 41 0 002 718 , 34 41 0 005 300 , 7L0 698 545 , 34 41 0 146 840 , 34 41 0 304 483 , 34 41 0 417 558	
	3,0 sd		09.2006		03.0137-9288.2	669288	ACCESORIOS ZAPATAS	34 41 0 002 718 , 34 41 0 005 300 , 7L0 698 545 , 34 41 0 146 840 , 34 41 0 304 483 , 34 41 0 417 558	
	3,0 si		09.2006		03.0137-9288.2	669288	ACCESORIOS ZAPATAS	34 41 0 002 718 , 34 41 0 005 300 , 7L0 698 545 , 34 41 0 146 840 , 34 41 0 304 483 , 34 41 0 417 558	
X5 (00-06)	3,0 d		10.2003	03.2007	03.0137-9288.2	669288	ACCESORIOS ZAPATAS	34 41 0 002 718 , 34 41 0 005 300 , 7L0 698 545 , 34 41 0 146 840 , 34 41 0 304 483 , 34 41 0 417 558	
			05.2001	09.2003	03.0137-9288.2	669288	ACCESORIOS ZAPATAS	34 41 0 002 718 , 34 41 0 005 300 , 7L0 698 545 , 34 41 0 146 840 , 34 41 0 304 483 , 34 41 0 417 558	
		ET	05.2001	09.2003	24.0710-2012.1	360219	SENSOR DE LA RUEDA	34 52 1 165 573 , 34 52 6 756 380 , 34 52 0 025 726	

Nuevas referencias en almacén - Por aplicación

12/2007



					Denominación	Ref. OE correspondientes a las referencias ATE	 Referencia anterior / varios
---	---	---	---	---	--------------	--	--







BMW

X5 (00-06)	3,0 i		04.2000	03.2007	03.0137-9288.2	669288	ACCESORIOS ZAPATAS	34 41 0 002 718 , 34 41 0 005 300 , 7L0 698 545 , 34 41 0 146 840 , 34 41 0 304 483 , 34 41 0 417 558	
		ET	04.2000	09.2003	24.0710-2012.1	360219	SENSOR DE LA RUEDA	34 52 1 165 573 , 34 52 6 756 380 , 34 52 0 025 726	
	4,4 i		10.2003	03.2007	03.0137-9288.2	669288	ACCESORIOS ZAPATAS	34 41 0 002 718 , 34 41 0 005 300 , 7L0 698 545 , 34 41 0 146 840 , 34 41 0 304 483 , 34 41 0 417 558	
			04.2000	09.2003	03.0137-9288.2	669288	ACCESORIOS ZAPATAS	34 41 0 002 718 , 34 41 0 005 300 , 7L0 698 545 , 34 41 0 146 840 , 34 41 0 304 483 , 34 41 0 417 558	
		ET	04.2000	09.2003	24.0710-2012.1	360219	SENSOR DE LA RUEDA	34 52 1 165 573 , 34 52 6 756 380 , 34 52 0 025 726	
	4,6 iS		12.2001	09.2003	03.0137-9288.2	669288	ACCESORIOS ZAPATAS	34 41 0 002 718 , 34 41 0 005 300 , 7L0 698 545 , 34 41 0 146 840 , 34 41 0 304 483 , 34 41 0 417 558	
		ET	12.2001	09.2003	24.0710-2012.1	360219	SENSOR DE LA RUEDA	34 52 1 165 573 , 34 52 6 756 380 , 34 52 0 025 726	
	4,8 iS		03.2004	03.2007	03.0137-9288.2	669288	ACCESORIOS ZAPATAS	34 41 0 002 718 , 34 41 0 005 300 , 7L0 698 545 , 34 41 0 146 840 , 34 41 0 304 483 , 34 41 0 417 558	
Z4 Coupe (06-)	3,0 si		03.2006		24.8190-0244.2	620244	CONTACTO DE DESGASTE	34 35 7 836 795	
	M 3,2		03.2006		03.0137-9288.2	669288	ACCESORIOS ZAPATAS	34 41 0 002 718 , 34 41 0 005 300 , 7L0 698 545 , 34 41 0 146 840 , 34 41 0 304 483 , 34 41 0 417 558	

Nuevas referencias en almacén - Por aplicación

12/2007





					Denominación	Ref. OE correspondientes a las referencias ATE	 Referencia anterior / varios
---	---	---	---	---	--------------	--	--

BMW

Z4 Coupe (06-)	M 3,2		03.2006		24.8190-0245.2	620245	CONTACTO DE DESGASTE	34 35 7 836 969	
			03.2006		24.8190-0244.2	620244	CONTACTO DE DESGASTE	34 35 7 836 795	
Z4 Roadster (03-)	3,0 si		01.2006		24.8190-0244.2	620244	CONTACTO DE DESGASTE	34 35 7 836 795	
	M 3,2		01.2006		03.0137-9288.2	669288	ACCESORIOS ZAPATAS	34 41 0 002 718 , 34 41 0 005 300 , 7L0 698 545 , 34 41 0 146 840 , 34 41 0 304 483 , 34 41 0 417 558	
			01.2006		24.8190-0245.2	620245	CONTACTO DE DESGASTE	34 35 7 836 969	
			01.2006		24.8190-0244.2	620244	CONTACTO DE DESGASTE	34 35 7 836 795	







					Denominación	Ref. OE correspondientes a las referencias ATE	 Referencia anterior / varios
---	---	---	---	---	--------------	--	--

CHEVROLET

EVANDA (05-)	2,0 i 16V		03.2005		13.0460-5859.2	605859	PASTILLAS DE FRENO	96446742 , 96495227 , 96245178 , 96253367 , S4510019 , 96253382	ver figura
LACETTI (05-)	1,4 i 16V		03.2005		13.0460-5863.2	605863	PASTILLAS DE FRENO	96391891 , 96405129	ver figura
	1,6 i 16V		03.2005		13.0460-5863.2	605863	PASTILLAS DE FRENO	96391891 , 96405129	ver figura
	1,8 i 16V		03.2005		13.0460-5863.2	605863	PASTILLAS DE FRENO	96391891 , 96405129	ver figura
MATIZ (05-)	0,8 (KLA4)		03.2005		24.3728-2900.2	592900	CABLE DE EMBRAGUE	96315242	
	1,0 (KLA0)		03.2005		24.3728-2900.2	592900	CABLE DE EMBRAGUE	96315242	
NUBIRA (05-)	1,6 i 16V		03.2005		13.0460-5859.2	605859	PASTILLAS DE FRENO	96446742 , 96495227 , 96245178 , 96253367 , S4510019 , 96253382	ver figura
					13.0460-5863.2	605863	PASTILLAS DE FRENO	96391891 , 96405129	ver figura
	1,8 i 16V		03.2005		13.0460-5859.2	605859	PASTILLAS DE FRENO	96446742 , 96495227 , 96245178 , 96253367 , S4510019 , 96253382	ver figura
					13.0460-5863.2	605863	PASTILLAS DE FRENO	96391891 , 96405129	ver figura
REZZO (05-)	1,6 i				13.0460-5859.2	605859	PASTILLAS DE FRENO	96446742 , 96495227 , 96245178 , 96253367 , S4510019 , 96253382	ver figura
	2,0 i 16V				13.0460-5859.2	605859	PASTILLAS DE FRENO	96446742 , 96495227 , 96245178 , 96253367 , S4510019 , 96253382	ver figura





					Denominación	Ref. OE correspondientes a las referencias ATE	 Referencia anterior / varios
---	---	---	---	---	--------------	--	--

CITROEN

C1 (05-)	1	06.2005		24.3728-0851.2	590851	CABLE DE EMBRAGUE	2150 CQ	
	1,4 HDi	06.2005		24.3728-0852.2	590852	CABLE DE EMBRAGUE	2150 CR	
JUMPER (02-06)	2,0 HDi (10/14)	04.2002	03.2006	03.0137-9285.2	669285	ACCESORIOS ZAPATAS	4308 64	
	2,0 i (10/14)	04.2002	03.2006	03.0137-9285.2	669285	ACCESORIOS ZAPATAS	4308 64	
	2,2 HDi (10/14)	04.2002	03.2006	03.0137-9285.2	669285	ACCESORIOS ZAPATAS	4308 64	
	2,8 HDi (10/14)	04.2002	03.2006	03.0137-9285.2	669285	ACCESORIOS ZAPATAS	4308 64	
JUMPER Autobús (94-02)	1,9 D (10)	11.2001	03.2002	03.0137-9285.2	669285	ACCESORIOS ZAPATAS	4308 64	
	1,9 TD (10/14)	11.2001	03.2002	03.0137-9285.2	669285	ACCESORIOS ZAPATAS	4308 64	
	2,0 i (10/14)	11.2001	03.2002	03.0137-9285.2	669285	ACCESORIOS ZAPATAS	4308 64	
	2,5 D (14)	11.2001	03.2002	03.0137-9285.2	669285	ACCESORIOS ZAPATAS	4308 64	
	2,5 TD (14)	11.2001	03.2002	03.0137-9285.2	669285	ACCESORIOS ZAPATAS	4308 64	
	2,8 HDi (14)	11.2001	03.2002	03.0137-9285.2	669285	ACCESORIOS ZAPATAS	4308 64	
JUMPER Furgón (94-02)	1,9 D (10)	11.2001	03.2002	03.0137-9285.2	669285	ACCESORIOS ZAPATAS	4308 64	
	1,9 TD (10/14)	11.2001	03.2002	03.0137-9285.2	669285	ACCESORIOS ZAPATAS	4308 64	
	2,0 HDi (10/14)	11.2001	03.2002	03.0137-9285.2	669285	ACCESORIOS ZAPATAS	4308 64	
	2,0 i (10/14)	11.2001	03.2002	03.0137-9285.2	669285	ACCESORIOS ZAPATAS	4308 64	
	2,5 D (14)	11.2001	03.2002	03.0137-9285.2	669285	ACCESORIOS ZAPATAS	4308 64	
	2,5 TD (14)	11.2001	03.2002	03.0137-9285.2	669285	ACCESORIOS ZAPATAS	4308 64	
	2,8 HDi (14)	11.2001	03.2002	03.0137-9285.2	669285	ACCESORIOS ZAPATAS	4308 64	



					Denominación	Ref. OE correspondientes a las referencias ATE	 Referencia anterior / varios
---	---	---	---	---	--------------	--	--

CITROEN

JUMPER Camión con plataforma/chasis (94-02)	2,0 i (18)		03.1994	10.2001	03.0137-9285.2	669285	ACCESORIOS ZAPATAS	4308 64	
	2,5 D (18)		03.1994	10.2001	03.0137-9285.2	669285	ACCESORIOS ZAPATAS	4308 64	
	2,5 TD (18)		03.1994	10.2001	03.0137-9285.2	669285	ACCESORIOS ZAPATAS	4308 64	
	2,5 TDi (18)		12.1996	10.2001	03.0137-9285.2	669285	ACCESORIOS ZAPATAS	4308 64	
	2,8 HDi (18)		09.2000	10.2001	03.0137-9285.2	669285	ACCESORIOS ZAPATAS	4308 64	

DACIA

LOGAN Berlina (04-)	1,4		09.2004		24.3728-1031.2	591031	CABLE DE EMBRAGUE	60 01 546 867	
	1,5 dCi		01.2006		24.3728-1031.2	591031	CABLE DE EMBRAGUE	60 01 546 867	
			09.2005		24.3728-1031.2	591031	CABLE DE EMBRAGUE	60 01 546 867	
	1,6		09.2004		24.3728-1031.2	591031	CABLE DE EMBRAGUE	60 01 546 867	
	1,6 16V		02.2006		24.3728-1031.2	591031	CABLE DE EMBRAGUE	60 01 546 867	







					Denominación	Ref. OE correspondientes a las referencias ATE		Referencia anterior / varios
--	--	--	--	--	--------------	--	--	------------------------------

DAEWOO

EVANDA (02-05)	2,0 i 16V		08.2002	02.2005	13.0460-5859.2	605859	PASTILLAS DE FRENO	96446742 , 96495227 , 96245178 , 96253367 , S4510019 , 96253382	ver figura
LACETTI (04-05)	1,4 i 16V		02.2004	02.2005	13.0460-5863.2	605863	PASTILLAS DE FRENO	96391891 , 96405129	ver figura
	1,6 i 16V		02.2004	02.2005	13.0460-5863.2	605863	PASTILLAS DE FRENO	96391891 , 96405129	ver figura
	1,8 i 16V		02.2004	02.2005	13.0460-5863.2	605863	PASTILLAS DE FRENO	96391891 , 96405129	ver figura
LEGANZA (97-02)	2,0 i 16V		06.1997	12.2002	13.0460-5859.2	605859	PASTILLAS DE FRENO	96446742 , 96495227 , 96245178 , 96253367 , S4510019 , 96253382	ver figura
			07.2000	12.2002	13.0460-5859.2	605859	PASTILLAS DE FRENO	96446742 , 96495227 , 96245178 , 96253367 , S4510019 , 96253382	ver figura
	2,2 i 16V		04.1999	12.2002	13.0460-5859.2	605859	PASTILLAS DE FRENO	96446742 , 96495227 , 96245178 , 96253367 , S4510019 , 96253382	ver figura
MAGNUS (99-)	2		07.1999		13.0460-5859.2	605859	PASTILLAS DE FRENO	96446742 , 96495227 , 96245178 , 96253367 , S4510019 , 96253382	ver figura
MATIZ (98-05)	0,8 (KLA4)		07.1998	02.2005	24.3728-2900.2	592900	CABLE DE EMBRAGUE	96315242	
	1,0 (KLA0)		01.2003	02.2005	24.3728-2900.2	592900	CABLE DE EMBRAGUE	96315242	
NUBIRA (99-05)	1,6 i 16V		06.1999		13.0460-5859.2	605859	PASTILLAS DE FRENO	96446742 , 96495227 , 96245178 , 96253367 , S4510019 , 96253382	ver figura
			08.2003		13.0460-5859.2	605859	PASTILLAS DE FRENO	96446742 , 96495227 , 96245178 , 96253367 , S4510019 , 96253382	ver figura







					Denominación	Ref. OE correspondientes a las referencias ATE		Referencia anterior / varios
---	---	---	---	---	--------------	--	---	------------------------------

DAEWOO

Modelo	Motor	Fecha 1	Fecha 2	Ref. ATE 1	Ref. ATE 2	Denominación	Ref. OE correspondientes a las referencias ATE	Referencia anterior / varios
NUBIRA (99-05)	1,6 i 16V	07.2000	02.2005	13.0460-5859.2	605859	PASTILLAS DE FRENO	96446742 , 96495227 , 96245178 , 96253367 , S4510019 , 96253382	ver figura
			02.2005	13.0460-5863.2	605863	PASTILLAS DE FRENO	96391891 , 96405129	ver figura
	1,8 i 16V		02.2005	13.0460-5863.2	605863	PASTILLAS DE FRENO	96391891 , 96405129	ver figura
		08.2003		13.0460-5859.2	605859	PASTILLAS DE FRENO	96446742 , 96495227 , 96245178 , 96253367 , S4510019 , 96253382	ver figura
	2,0 i 16V		02.2005	13.0460-5863.2	605863	PASTILLAS DE FRENO	96391891 , 96405129	ver figura
		06.1999		13.0460-5859.2	605859	PASTILLAS DE FRENO	96446742 , 96495227 , 96245178 , 96253367 , S4510019 , 96253382	ver figura
REZZO (00-05)	1,6 i 16V		02.2005	13.0460-5859.2	605859	PASTILLAS DE FRENO	96446742 , 96495227 , 96245178 , 96253367 , S4510019 , 96253382	ver figura
	1,8 i		02.2005	13.0460-5859.2	605859	PASTILLAS DE FRENO	96446742 , 96495227 , 96245178 , 96253367 , S4510019 , 96253382	ver figura
	2,0 i 16V		02.2005	13.0460-5859.2	605859	PASTILLAS DE FRENO	96446742 , 96495227 , 96245178 , 96253367 , S4510019 , 96253382	ver figura
TACUMA (00-05)	1,6 i 16V		02.2005	13.0460-5859.2	605859	PASTILLAS DE FRENO	96446742 , 96495227 , 96245178 , 96253367 , S4510019 , 96253382	ver figura
	1,8 i		02.2005	13.0460-5859.2	605859	PASTILLAS DE FRENO	96446742 , 96495227 , 96245178 , 96253367 , S4510019 , 96253382	ver figura



	i				Denominación	Ref. OE correspondientes a las referencias ATE	i Referencia anterior / varios
---	----------	---	---	---	--------------	--	--





DAEWOO

TACUMA (00-05)	2,0 i 16V			02.2005	13.0460-5859.2	605859	PASTILLAS DE FRENO	96446742 , 96495227 , 96245178 , 96253367 , S4510019 , 96253382	ver figura
----------------	-----------	--	--	---------	----------------	--------	--------------------	---	------------

Nuevas referencias en almacén - Por aplicación

12/2007



					Denominación	Ref. OE correspondientes a las referencias ATE		Referencia anterior / varios
---	---	---	---	---	---------------------	---	---	-------------------------------------

FIAT

500 (07-)	1,2 i		07.2007		24.3728-0532.2	590532	CABLE DE EMBRAGUE	55183097	
DUCATO (02-06)	2,0 i (11/15)		04.2002	07.2006	03.0137-9285.2	669285	ACCESORIOS ZAPATAS	4308 64	
	2,0 JTD (11/15)		04.2002	07.2006	03.0137-9285.2	669285	ACCESORIOS ZAPATAS	4308 64	
	2,3 JTD (11/15)		04.2002	07.2006	03.0137-9285.2	669285	ACCESORIOS ZAPATAS	4308 64	
	2,8 JTD (11/15)		04.2002	07.2006	03.0137-9285.2	669285	ACCESORIOS ZAPATAS	4308 64	
	2,8 JTD 4x4 (11/15)		07.2002	07.2006	03.0137-9285.2	669285	ACCESORIOS ZAPATAS	4308 64	
DUCATO (94-02)	1,9 D (10)		11.2001	03.2002	03.0137-9285.2	669285	ACCESORIOS ZAPATAS	4308 64	
	1,9 TD (10)		11.2001	03.2002	03.0137-9285.2	669285	ACCESORIOS ZAPATAS	4308 64	
	1,9 TD-ECO (10)		11.2001	03.2002	03.0137-9285.2	669285	ACCESORIOS ZAPATAS	4308 64	
	2,0 i (10/14)		11.2001	03.2002	03.0137-9285.2	669285	ACCESORIOS ZAPATAS	4308 64	
	2,0 JTD (14)		10.2001	03.2002	03.0137-9285.2	669285	ACCESORIOS ZAPATAS	4308 64	
	2,5 D (14)		11.2001	03.2002	03.0137-9285.2	669285	ACCESORIOS ZAPATAS	4308 64	
	2,5 TDI (14)		11.2001	03.2002	03.0137-9285.2	669285	ACCESORIOS ZAPATAS	4308 64	
	2,5 TDI ECO (14)		11.2001	03.2002	03.0137-9285.2	669285	ACCESORIOS ZAPATAS	4308 64	
	2,8 D (14)		11.2001	03.2002	03.0137-9285.2	669285	ACCESORIOS ZAPATAS	4308 64	
	2,8 JTD (14)		11.2001	03.2002	03.0137-9285.2	669285	ACCESORIOS ZAPATAS	4308 64	
	2,8 TDI (14)		11.2001	03.2002	03.0137-9285.2	669285	ACCESORIOS ZAPATAS	4308 64	
PANDA (03-)	1,1 i		09.2003		24.3728-0532.2	590532	CABLE DE EMBRAGUE	55183097	
	1,2 i		09.2003		24.3728-0532.2	590532	CABLE DE EMBRAGUE	55183097	



	i			Denominación	Ref. OE correspondientes a las referencias ATE	i Referencia anterior / varios
--	----------	--	--	--------------	--	--

FIAT

PANDA (03-)	1,3 JTD		09.2003		24.3728-0532.2	590532	CABLE DE EMBRAGUE	55183097	
PUNTO (03-06)	1,2 i		07.2003	11.2005	83.6401-0454.3	330860	LATIGUILLO	46760308	
	1,2 i 16V		07.2003	11.2005	83.6401-0454.3	330860	LATIGUILLO	46760308	
	1,3 JTD 16V		07.2003	11.2005	83.6401-0454.3	330860	LATIGUILLO	46760308	
	1,4 i 16V		07.2003	11.2005	83.6401-0454.3	330860	LATIGUILLO	46760308	
	1,8 i 16V		07.2003	11.2005	83.6401-0454.3	330860	LATIGUILLO	46760308	
	1,9 JTD		07.2003	11.2005	83.6401-0454.3	330860	LATIGUILLO	46760308	



					Denominación	Ref. OE correspondientes a las referencias ATE		Referencia anterior / varios
--	--	--	--	--	--------------	--	--	------------------------------

FORD

FUSION (02-)	1,25 i 16V		08.2004		83.7827-0321.3	330862	LATIGUILLO	1207358 , 1426700 , 1213135 , 2N11 2282-AA , 2N11 2282-AB , 2N11 2282-AC	
			08.2004		83.7769-0493.3	330861	LATIGUILLO	1211729 , 1426690 , 2N11 2078-AB , 2N11 2078-AC	
	1,4 i 16V		07.2002		83.7769-0493.3	330861	LATIGUILLO	1211729 , 1426690 , 2N11 2078-AB , 2N11 2078-AC	
			07.2002		83.7827-0321.3	330862	LATIGUILLO	1207358 , 1426700 , 1213135 , 2N11 2282-AA , 2N11 2282-AB , 2N11 2282-AC	
	1,4 TDCi		07.2002		83.7827-0321.3	330862	LATIGUILLO	1207358 , 1426700 , 1213135 , 2N11 2282-AA , 2N11 2282-AB , 2N11 2282-AC	
			07.2002		83.7769-0493.3	330861	LATIGUILLO	1211729 , 1426690 , 2N11 2078-AB , 2N11 2078-AC	
	1,6 i 16V		07.2002		83.7827-0321.3	330862	LATIGUILLO	1207358 , 1426700 , 1213135 , 2N11 2282-AA , 2N11 2282-AB , 2N11 2282-AC	
			07.2002		83.7769-0493.3	330861	LATIGUILLO	1211729 , 1426690 , 2N11 2078-AB , 2N11 2078-AC	
	1,6 TDCi		10.2004		83.7827-0321.3	330862	LATIGUILLO	1207358 , 1426700 , 1213135 , 2N11 2282-AA , 2N11 2282-AB , 2N11 2282-AC	
			10.2004		83.7769-0493.3	330861	LATIGUILLO	1211729 , 1426690 , 2N11 2078-AB , 2N11 2078-AC	







	i				Denominación	Ref. OE correspondientes a las referencias ATE	i Referencia anterior / varios
--	----------	--	--	--	--------------	--	--

HONDA

ACCORD (98-02)	1,6 i 16V (CG7)		10.1998	12.2002	13.0460-5861.2	605861	PASTILLAS DE FRENO	45022-S1A-E63 , 45022-S1A-E80	ver figura
	1,6 i 16V (GH5)		10.1998	12.2002	13.0460-5861.2	605861	PASTILLAS DE FRENO	45022-S1A-E63 , 45022-S1A-E80	ver figura
JAZZ (02-)	1,2 (GD)		03.2002	12.2003	03.0137-9284.2	669284	ACCESORIOS ZAPATAS		
	1,4 (GD)		03.2002	12.2003	03.0137-9284.2	669284	ACCESORIOS ZAPATAS		



					Denominación	Ref. OE correspondientes a las referencias ATE	 Referencia anterior / varios
---	---	---	---	---	--------------	--	--

HYUNDAI

Modelo	Motor	Desde	Hasta	Ref. ATE	Ref. OE	Denominación	Ref. OE correspondientes a las referencias ATE	Referencia anterior / varios
ATOS / AMICA (GB) (98-)	1,0 i 12V	01.1998	08.2000	24.3728-3100.2	593100	CABLE DE EMBRAGUE	41510-02010 , 41510-02000	
		09.2000		24.3728-3100.2	593100	CABLE DE EMBRAGUE	41510-02010 , 41510-02000	
	1,0 i 12V Prime	09.1999		24.3728-3100.2	593100	CABLE DE EMBRAGUE	41510-02010 , 41510-02000	
		09.2000		24.3728-3100.2	593100	CABLE DE EMBRAGUE	41510-02010 , 41510-02000	
	1,1 i 12V	03.2004		24.3728-3100.2	593100	CABLE DE EMBRAGUE	41510-02010 , 41510-02000	
		08.2003		24.3728-3100.2	593100	CABLE DE EMBRAGUE	41510-02010 , 41510-02000	
ELANTRA (00-03)	1,6 i 16V	01.2003	07.2003	13.0460-5876.2	605876	PASTILLAS DE FRENO	58101-2DA50	ver figura
		01.2003	07.2003	13.0460-5876.2	605876	PASTILLAS DE FRENO	58101-2DA50	ver figura
	2,0 CRDi	01.2003	07.2003	13.0460-5876.2	605876	PASTILLAS DE FRENO	58101-2DA50	ver figura
		01.2003	07.2003	13.0460-5876.2	605876	PASTILLAS DE FRENO	58101-2DA50	ver figura
ELANTRA (03-06)	1,6 i 16V	08.2003	05.2006	13.0460-5876.2	605876	PASTILLAS DE FRENO	58101-2DA50	ver figura
		08.2003	05.2006	13.0460-5876.2	605876	PASTILLAS DE FRENO	58101-2DA50	ver figura
	2,0 CRDi	08.2003	05.2006	13.0460-5876.2	605876	PASTILLAS DE FRENO	58101-2DA50	ver figura
		08.2003	05.2006	13.0460-5876.2	605876	PASTILLAS DE FRENO	58101-2DA50	ver figura
GETZ (02-)	1,1 i 12V	09.2005		03.0137-9292.2	669292	ACCESORIOS ZAPATAS		
		09.2002	08.2005	03.0137-9292.2	669292	ACCESORIOS ZAPATAS		
	1,3 i 12V	09.2003	04.2005	03.0137-9292.2	669292	ACCESORIOS ZAPATAS		
		09.2002	04.2005	03.0137-9292.2	669292	ACCESORIOS ZAPATAS		
	1,4 i 16V	08.2005		03.0137-9292.2	669292	ACCESORIOS ZAPATAS		
1,5 CRDi	03.2003	04.2005	03.0137-9292.2	669292	ACCESORIOS ZAPATAS			



					Denominación	Ref. OE correspondientes a las referencias ATE		Referencia anterior / varios
--	--	--	--	--	--------------	--	--	------------------------------

HYUNDAI

GETZ (02-)	1,5 i GL		09.2002	07.2005	03.0137-9292.2	669292	ACCESORIOS ZAPATAS		
	1,6 i 16V		09.2002	07.2005	03.0137-9292.2	669292	ACCESORIOS ZAPATAS		
LANTRA (00-03)			01.2003	07.2003	13.0460-5876.2	605876	PASTILLAS DE FRENO	58101-2DA50	ver figura
	1,8 i 16V		01.2003	07.2003	13.0460-5876.2	605876	PASTILLAS DE FRENO	58101-2DA50	ver figura
	2,0 CRDi		01.2003	07.2003	13.0460-5876.2	605876	PASTILLAS DE FRENO	58101-2DA50	ver figura
	2,0 i 16V		01.2003	07.2003	13.0460-5876.2	605876	PASTILLAS DE FRENO	58101-2DA50	ver figura

JAGUAR

S-TYPE (CCX) (99-)	2,5 V6		04.2002		24.0130-0182.1	430182	DISCO DE FRENO	C2C 8354	
			04.2002		13.0460-2898.2	602898	PASTILLAS DE FRENO	XR8 30139 , XR8 37417	ver figura
	2,7 D		06.2004		24.0130-0182.1	430182	DISCO DE FRENO	C2C 8354	
			06.2004		13.0460-2898.2	602898	PASTILLAS DE FRENO	XR8 30139 , XR8 37417	ver figura
	3,0 V6		01.1999		24.0130-0182.1	430182	DISCO DE FRENO	C2C 8354	
			01.1999		13.0460-2898.2	602898	PASTILLAS DE FRENO	XR8 30139 , XR8 37417	ver figura
	4,0 V8		01.1999	04.2002	24.0130-0182.1	430182	DISCO DE FRENO	C2C 8354	
			01.1999	04.2002	13.0460-2898.2	602898	PASTILLAS DE FRENO	XR8 30139 , XR8 37417	ver figura



	i				Denominación	Ref. OE correspondientes a las referencias ATE	i Referencia anterior / varios
--	----------	--	--	--	---------------------	---	--

JEEP

GRAND CHEROKEE II (WJ,WG) (99-05)	2,7 CRD		10.2001		13.0460-7206.2	607206	PASTILLAS DE FRENO	5011 969AA , 5018 592AA	ver figura
	3,1 TD		04.1999		13.0460-7206.2	607206	PASTILLAS DE FRENO	5011 969AA , 5018 592AA	ver figura
	4		04.1999		13.0460-7206.2	607206	PASTILLAS DE FRENO	5011 969AA , 5018 592AA	ver figura
	4,7 V8		04.1999	08.2000	13.0460-7206.2	607206	PASTILLAS DE FRENO	5011 969AA , 5018 592AA	ver figura
			10.2001		13.0460-7206.2	607206	PASTILLAS DE FRENO	5011 969AA , 5018 592AA	ver figura
			08.2000		13.0460-7206.2	607206	PASTILLAS DE FRENO	5011 969AA , 5018 592AA	ver figura
			06.2003		13.0460-7206.2	607206	PASTILLAS DE FRENO	5011 969AA , 5018 592AA	ver figura

KIA

PREGIO (97-04)	2,5 TCiD		09.2002	03.2004	03.0137-0486.2	650486	JUEGO DE ZAPATAS	SE28-26-38Z , SE28-26-38ZA , OK72A-26-38Z	
	2,7 D		10.1997	12.2001	03.0137-0486.2	650486	JUEGO DE ZAPATAS	SE28-26-38Z , SE28-26-38ZA , OK72A-26-38Z	
SORENTO (02-)	2,4 i 16V		08.2002	11.2006	03.0137-3009.2	653009	JUEGO DE ZAPATAS	58350-3ED00	
	2,5 CRDi		08.2002	11.2006	03.0137-3009.2	653009	JUEGO DE ZAPATAS	58350-3ED00	
	3,5 i V6		08.2002		03.0137-3009.2	653009	JUEGO DE ZAPATAS	58350-3ED00	



	i				Denominación	Ref. OE correspondientes a las referencias ATE	i Referencia anterior / varios
--	----------	--	--	--	---------------------	---	--

LANCIA

THESIS (02-)	2,0 i 20V Turbo		07.2002		24.0122-0234.1	422234	DISCO DE FRENO	46469907	
	2,4 i 20V		07.2002		24.0122-0234.1	422234	DISCO DE FRENO	46469907	
	2,4 JTD		07.2002		24.0122-0234.1	422234	DISCO DE FRENO	46469907	
	3,0 i V6		07.2002		24.0122-0234.1	422234	DISCO DE FRENO	46469907	
	3,2 i V6		05.2003		24.0122-0234.1	422234	DISCO DE FRENO	46469907	

LAND ROVER

RANGE ROVER SPORT (05-)	4,2 V8 Kompressor		02.2005		24.8190-1307.2	621307	CONTACTO DE DESGASTE	SEM500026	
-------------------------	-------------------	--	---------	--	----------------	--------	----------------------	-----------	--



LEXUS

LX 470 (02-05)	4,7 i V8 4WD (UJZ100)		08.2002	07.2005	03.0137-3008.2	653008	JUEGO DE ZAPATAS	46540-60050 , 46550-60060 , 46580-60050	
----------------	-----------------------	--	---------	---------	----------------	--------	------------------	---	--

Nuevas referencias en almacén - Por aplicación

12/2007



					Denominación	Ref. OE correspondientes a las referencias ATE	 Referencia anterior / varios
---	---	---	---	---	--------------	--	--

MAZDA

E2000/E2200 Autobús (87-)	2		12.1987		03.0137-0486.2	650486	JUEGO DE ZAPATAS	SE28-26-38Z , SE28-26-38ZA , OK72A-26-38Z	
	2,0 4WD		12.1987		03.0137-0486.2	650486	JUEGO DE ZAPATAS	SE28-26-38Z , SE28-26-38ZA , OK72A-26-38Z	
	2,2 D		12.1987		03.0137-0486.2	650486	JUEGO DE ZAPATAS	SE28-26-38Z , SE28-26-38ZA , OK72A-26-38Z	
	2,2 D 4WD		12.1987		03.0137-0486.2	650486	JUEGO DE ZAPATAS	SE28-26-38Z , SE28-26-38ZA , OK72A-26-38Z	
E2000/E2200 Furgón (87-)	2		12.1987		03.0137-0486.2	650486	JUEGO DE ZAPATAS	SE28-26-38Z , SE28-26-38ZA , OK72A-26-38Z	
	2,2 D		12.1987		03.0137-0486.2	650486	JUEGO DE ZAPATAS	SE28-26-38Z , SE28-26-38ZA , OK72A-26-38Z	
E2000/E2200 Camión plataforma (87-)	2		12.1987		03.0137-0486.2	650486	JUEGO DE ZAPATAS	SE28-26-38Z , SE28-26-38ZA , OK72A-26-38Z	
	2,2 D		12.1987		03.0137-0486.2	650486	JUEGO DE ZAPATAS	SE28-26-38Z , SE28-26-38ZA , OK72A-26-38Z	
MPV II (99-05)	2,0 CITD (LW19)		07.2002	10.2005	13.0460-5884.2	605884	PASTILLAS DE FRENO	LDY5-33-23Z , LEY5-33-23Z , LEY9-33-23Z , LCY4-33-23Z , LCY4-33-23ZA , LCY4-33-23ZB , LDY3-33-23Z , LCY4-33-23ZC , LCY4-33-23ZD , LDY2-33-23Z	ver figura
	2,0 i 16V (LW19)		08.2000	06.2002	13.0460-5884.2	605884	PASTILLAS DE FRENO	LDY5-33-23Z , LEY5-33-23Z , LEY9-33-23Z , LCY4-33-23Z , LCY4-33-23ZA , LCY4-33-23ZB , LDY3-33-23Z , LCY4-33-23ZC , LCY4-33-23ZD , LDY2-33-23Z	ver figura







					Denominación	Ref. OE correspondientes a las referencias ATE		Referencia anterior / varios
--	--	--	--	--	--------------	--	--	------------------------------

MAZDA

MPV II (99-05)	2,0 i 16V (LW19)		09.1999	07.2000	13.0460-5884.2	605884	PASTILLAS DE FRENO	LDY5-33-23Z , LEY5-33-23Z , LEY9-33-23Z , LCY4-33-23Z , LCY4-33-23ZA , LCY4-33-23ZB , LDY3-33-23Z , LCY4-33-23ZC , LCY4-33-23ZD , LDY2-33-23Z	ver figura
	2,3 i 16V (LW19)		07.2002	10.2005	13.0460-5884.2	605884	PASTILLAS DE FRENO	LDY5-33-23Z , LEY5-33-23Z , LEY9-33-23Z , LCY4-33-23Z , LCY4-33-23ZA , LCY4-33-23ZB , LDY3-33-23Z , LCY4-33-23ZC , LCY4-33-23ZD , LDY2-33-23Z	ver figura
	2,5 i V6 (LW19)		09.1999	03.2002	13.0460-5884.2	605884	PASTILLAS DE FRENO	LDY5-33-23Z , LEY5-33-23Z , LEY9-33-23Z , LCY4-33-23Z , LCY4-33-23ZA , LCY4-33-23ZB , LDY3-33-23Z , LCY4-33-23ZC , LCY4-33-23ZD , LDY2-33-23Z	ver figura
	3,0 i V6 (LW19)		03.2002	10.2005	13.0460-5884.2	605884	PASTILLAS DE FRENO	LDY5-33-23Z , LEY5-33-23Z , LEY9-33-23Z , LCY4-33-23Z , LCY4-33-23ZA , LCY4-33-23ZB , LDY3-33-23Z , LCY4-33-23ZC , LCY4-33-23ZD , LDY2-33-23Z	ver figura
MX-5 (98-05)	1,9 i 16V (NB18)		08.2000	02.2005	24.0122-0235.1	422235	DISCO DE FRENO	NOYY-33-25X	
			08.2000	02.2005	13.0460-5867.2	605867	PASTILLAS DE FRENO	NOY9-33-23Z , NCY3-33-23Z	ver figura









					Denominación	Ref. OE correspondientes a las referencias ATE		Referencia anterior / varios
---	---	---	---	---	--------------	--	---	------------------------------

MERCEDES BENZ

Clase C (CL203) Sportcoupé (01-)	C 160 Kompressor		04.2005		83.7705-0386.3	330828	LATIGUILLO	202 428 07 35	83.6105-0386.3
	C 180		03.2001		83.7705-0386.3	330828	LATIGUILLO	202 428 07 35	83.6105-0386.3
	C 180 Kompressor		05.2002		83.7705-0386.3	330828	LATIGUILLO	202 428 07 35	83.6105-0386.3
	C 200 CDI		07.2003		83.7705-0386.3	330828	LATIGUILLO	202 428 07 35	83.6105-0386.3
	C 200 CGI Kompressor		07.2003		83.7705-0386.3	330828	LATIGUILLO	202 428 07 35	83.6105-0386.3
	C 200 Kompressor		03.2001		83.7705-0386.3	330828	LATIGUILLO	202 428 07 35	83.6105-0386.3
	C 220 CDI		03.2001		83.7705-0386.3	330828	LATIGUILLO	202 428 07 35	83.6105-0386.3
	C 230		06.2005		83.7705-0386.3	330828	LATIGUILLO	202 428 07 35	83.6105-0386.3
	C 230 Kompressor		03.2001		83.7705-0386.3	330828	LATIGUILLO	202 428 07 35	83.6105-0386.3
	C 30 CDI AMG		09.2002		83.7705-0386.3	330828	LATIGUILLO	202 428 07 35	83.6105-0386.3
	C 320		09.2002		83.7705-0386.3	330828	LATIGUILLO	202 428 07 35	83.6105-0386.3
	C 350		06.2005		83.7705-0386.3	330828	LATIGUILLO	202 428 07 35	83.6105-0386.3
Clase C (S202) Break (96-01)	C 180		06.1996	04.2001	83.7705-0386.3	330828	LATIGUILLO	202 428 07 35	83.6105-0386.3
	C 200		06.1996	04.2001	83.7705-0386.3	330828	LATIGUILLO	202 428 07 35	83.6105-0386.3
	C 200 CDI		03.1998	04.2001	83.7705-0386.3	330828	LATIGUILLO	202 428 07 35	83.6105-0386.3
	C 200 D		07.1996	04.2001	83.7705-0386.3	330828	LATIGUILLO	202 428 07 35	83.6105-0386.3
	C 200 Kompressor		11.1996	04.2001	83.7705-0386.3	330828	LATIGUILLO	202 428 07 35	83.6105-0386.3
	C 220 CDI		09.1997	04.2001	83.7705-0386.3	330828	LATIGUILLO	202 428 07 35	83.6105-0386.3
	C 220 D		06.1996	04.2001	83.7705-0386.3	330828	LATIGUILLO	202 428 07 35	83.6105-0386.3







					Denominación	Ref. OE correspondientes a las referencias ATE		Referencia anterior / varios
---	---	---	---	---	--------------	--	---	------------------------------

MERCEDES BENZ

Clase C (S202) Break (96-01)	C 230		06.1996	06.1997	83.7705-0386.3	330828	LATIGUILLO	202 428 07 35	83.6105-0386.3
	C 230 Kompressor		06.1997	04.2001	83.7705-0386.3	330828	LATIGUILLO	202 428 07 35	83.6105-0386.3
	C 240		06.1997	04.2001	83.7705-0386.3	330828	LATIGUILLO	202 428 07 35	83.6105-0386.3
	C 250 TD		06.1996	04.2001	83.7705-0386.3	330828	LATIGUILLO	202 428 07 35	83.6105-0386.3
	C 280		06.1997	04.2001	83.7705-0386.3	330828	LATIGUILLO	202 428 07 35	83.6105-0386.3
	C 43 AMG		09.1997	04.2001	83.7705-0386.3	330828	LATIGUILLO	202 428 07 35	83.6105-0386.3
C-Klasse (S203) Kombi (01-07)	C 180		03.2001	09.2007	83.7705-0386.3	330828	LATIGUILLO	202 428 07 35	83.6105-0386.3
	C 180 Kompressor		05.2002	09.2007	83.7705-0386.3	330828	LATIGUILLO	202 428 07 35	83.6105-0386.3
	C 200 CDI		03.2001	09.2007	83.7705-0386.3	330828	LATIGUILLO	202 428 07 35	83.6105-0386.3
	C 200 CGI Kompressor		07.2003	09.2007	83.7705-0386.3	330828	LATIGUILLO	202 428 07 35	83.6105-0386.3
	C 200 Kompressor		03.2001	09.2007	83.7705-0386.3	330828	LATIGUILLO	202 428 07 35	83.6105-0386.3
	C 220 CDI		03.2001	09.2007	83.7705-0386.3	330828	LATIGUILLO	202 428 07 35	83.6105-0386.3
	C 230		06.2005	09.2007	83.7705-0386.3	330828	LATIGUILLO	202 428 07 35	83.6105-0386.3
	C 230 Kompressor		02.2004	09.2007	83.7705-0386.3	330828	LATIGUILLO	202 428 07 35	83.6105-0386.3
	C 240		03.2001	09.2007	83.7705-0386.3	330828	LATIGUILLO	202 428 07 35	83.6105-0386.3
	C 270 CDI		03.2001	09.2007	83.7705-0386.3	330828	LATIGUILLO	202 428 07 35	83.6105-0386.3
	C 280		06.2005	09.2007	83.7705-0386.3	330828	LATIGUILLO	202 428 07 35	83.6105-0386.3
	C 30 CDI AMG		01.2003	09.2007	83.7705-0386.3	330828	LATIGUILLO	202 428 07 35	83.6105-0386.3
	C 32 Kompressor AMG		03.2001	09.2007	83.7705-0386.3	330828	LATIGUILLO	202 428 07 35	83.6105-0386.3



					Denominación	Ref. OE correspondientes a las referencias ATE	 Referencia anterior / varios
---	---	---	---	---	--------------	--	--



MERCEDES BENZ

Modelo	Motor	Fecha inicio	Fecha fin	Ref. OE	ATE	Denominación	Ref. OE correspondientes a las referencias ATE	Referencia anterior / varios
C-Klasse (S203) Kombi (01-07)	C 320	03.2001	09.2007	83.7705-0386.3	330828	LATIGUILLO	202 428 07 35	83.6105-0386.3
	C 320 CDI	02.2005	09.2007	83.7705-0386.3	330828	LATIGUILLO	202 428 07 35	83.6105-0386.3
	C 350	06.2005	09.2007	83.7705-0386.3	330828	LATIGUILLO	202 428 07 35	83.6105-0386.3
	C 55 AMG	02.2004	09.2007	83.7705-0386.3	330828	LATIGUILLO	202 428 07 35	83.6105-0386.3
Clase C (W202) Berlina (93-00)	C 180		05.2000	83.7705-0386.3	330828	LATIGUILLO	202 428 07 35	83.6105-0386.3
	C 200		05.2000	83.7705-0386.3	330828	LATIGUILLO	202 428 07 35	83.6105-0386.3
	C 200 CDI	03.1998	05.2000	83.7705-0386.3	330828	LATIGUILLO	202 428 07 35	83.6105-0386.3
	C 200 D		05.2000	83.7705-0386.3	330828	LATIGUILLO	202 428 07 35	83.6105-0386.3
	C 200 Kompressor	10.1995	05.2000	83.7705-0386.3	330828	LATIGUILLO	202 428 07 35	83.6105-0386.3
	C 220		08.1996	83.7705-0386.3	330828	LATIGUILLO	202 428 07 35	83.6105-0386.3
	C 220 CDI	09.1997	05.2000	83.7705-0386.3	330828	LATIGUILLO	202 428 07 35	83.6105-0386.3
	C 220 D		05.2000	83.7705-0386.3	330828	LATIGUILLO	202 428 07 35	83.6105-0386.3
	C 230	07.1996	06.1997	83.7705-0386.3	330828	LATIGUILLO	202 428 07 35	83.6105-0386.3
	C 230 Kompressor	09.1995	05.2000	83.7705-0386.3	330828	LATIGUILLO	202 428 07 35	83.6105-0386.3
	C 240	06.1997	05.2000	83.7705-0386.3	330828	LATIGUILLO	202 428 07 35	83.6105-0386.3
	C 250 D		08.1995	83.7705-0386.3	330828	LATIGUILLO	202 428 07 35	83.6105-0386.3
	C 250 TD	09.1995	05.2000	83.7705-0386.3	330828	LATIGUILLO	202 428 07 35	83.6105-0386.3
	C 280		05.2000	83.7705-0386.3	330828	LATIGUILLO	202 428 07 35	83.6105-0386.3
	C 36 AMG		08.1997	83.7705-0386.3	330828	LATIGUILLO	202 428 07 35	83.6105-0386.3

Nuevas referencias en almacén - Por aplicación

12/2007



					Denominación	Ref. OE correspondientes a las referencias ATE		Referencia anterior / varios
---	---	---	---	---	--------------	--	---	------------------------------

MERCEDES BENZ

Clase C (W202) Berlina (93-00)	C 43 AMG		09.1997	05.2000	83.7705-0386.3	330828	LATIGUILLO	202 428 07 35	83.6105-0386.3
Clase C (W203) Berlina (00-07)	C 180		04.2000	04.2007	83.7705-0386.3	330828	LATIGUILLO	202 428 07 35	83.6105-0386.3
	C 180 Kompressor		05.2002	04.2007	83.7705-0386.3	330828	LATIGUILLO	202 428 07 35	83.6105-0386.3
	C 200 CDI		04.2000	04.2007	83.7705-0386.3	330828	LATIGUILLO	202 428 07 35	83.6105-0386.3
	C 200 CGI Kompressor		07.2003	04.2007	83.7705-0386.3	330828	LATIGUILLO	202 428 07 35	83.6105-0386.3
	C 200 Kompressor		04.2000	04.2007	83.7705-0386.3	330828	LATIGUILLO	202 428 07 35	83.6105-0386.3
	C 220 CDI		04.2000	04.2007	83.7705-0386.3	330828	LATIGUILLO	202 428 07 35	83.6105-0386.3
	C 230		06.2005	04.2007	83.7705-0386.3	330828	LATIGUILLO	202 428 07 35	83.6105-0386.3
	C 230 Kompressor		02.2004	04.2007	83.7705-0386.3	330828	LATIGUILLO	202 428 07 35	83.6105-0386.3
	C 240		04.2000	04.2007	83.7705-0386.3	330828	LATIGUILLO	202 428 07 35	83.6105-0386.3
	C 270 CDI		08.2000	04.2007	83.7705-0386.3	330828	LATIGUILLO	202 428 07 35	83.6105-0386.3
	C 280		06.2005	04.2007	83.7705-0386.3	330828	LATIGUILLO	202 428 07 35	83.6105-0386.3
	C 30 CDI AMG		01.2003	04.2007	83.7705-0386.3	330828	LATIGUILLO	202 428 07 35	83.6105-0386.3
	C 32 Kompressor AMG		03.2001	04.2007	83.7705-0386.3	330828	LATIGUILLO	202 428 07 35	83.6105-0386.3
	C 320		04.2000	04.2007	83.7705-0386.3	330828	LATIGUILLO	202 428 07 35	83.6105-0386.3
	C 320 CDI		02.2005	04.2007	83.7705-0386.3	330828	LATIGUILLO	202 428 07 35	83.6105-0386.3
	C 350		06.2005	04.2007	83.7705-0386.3	330828	LATIGUILLO	202 428 07 35	83.6105-0386.3
	C 55 AMG		02.2004	04.2007	83.7705-0386.3	330828	LATIGUILLO	202 428 07 35	83.6105-0386.3
Clase CLK (A208) Cabriole (98-03)	CLK 200		06.1998	06.2003	83.7705-0386.3	330828	LATIGUILLO	202 428 07 35	83.6105-0386.3

Nuevas referencias en almacén - Por aplicación

12/2007



					Denominación	Ref. OE correspondientes a las referencias ATE		Referencia anterior / varios
--	--	--	--	--	--------------	--	--	------------------------------

MERCEDES BENZ

Clase CLK (A208) Cabrióle (98-03)	CLK 200 Kompressor		06.1998	06.2003	83.7705-0386.3	330828	LATIGUILLO	202 428 07 35	83.6105-0386.3
	CLK 230 Kompressor		06.1998	06.2003	83.7705-0386.3	330828	LATIGUILLO	202 428 07 35	83.6105-0386.3
	CLK 320		06.1998	06.2003	83.7705-0386.3	330828	LATIGUILLO	202 428 07 35	83.6105-0386.3
	CLK 430		06.1999	06.2003	83.7705-0386.3	330828	LATIGUILLO	202 428 07 35	83.6105-0386.3
Clase CLK (A209) Cabrióle (03-)	CLK 200 CGI		05.2003		83.7705-0386.3	330828	LATIGUILLO	202 428 07 35	83.6105-0386.3
	CLK 200 Kompressor		05.2003		83.7705-0386.3	330828	LATIGUILLO	202 428 07 35	83.6105-0386.3
	CLK 240		05.2003		83.7705-0386.3	330828	LATIGUILLO	202 428 07 35	83.6105-0386.3
	CLK 280		05.2005		83.7705-0386.3	330828	LATIGUILLO	202 428 07 35	83.6105-0386.3
	CLK 320		05.2003		83.7705-0386.3	330828	LATIGUILLO	202 428 07 35	83.6105-0386.3
	CLK 320 CDI		05.2005		83.7705-0386.3	330828	LATIGUILLO	202 428 07 35	83.6105-0386.3
	CLK 350		05.2005		83.7705-0386.3	330828	LATIGUILLO	202 428 07 35	83.6105-0386.3
	CLK 500		05.2003		83.7705-0386.3	330828	LATIGUILLO	202 428 07 35	83.6105-0386.3
	CLK 55 AMG		05.2003		83.7705-0386.3	330828	LATIGUILLO	202 428 07 35	83.6105-0386.3
	CLK 63 AMG		04.2006		83.7705-0386.3	330828	LATIGUILLO	202 428 07 35	83.6105-0386.3
			04.2006		13.0460-4806.2	604806	PASTILLAS DE FRENO	004 420 50 20	ver figura
Clase CLK (C208) Coupé (97-02)	CLK 200		06.1997	06.2002	83.7705-0386.3	330828	LATIGUILLO	202 428 07 35	83.6105-0386.3
	CLK 200 Kompressor		06.1997	06.2002	83.7705-0386.3	330828	LATIGUILLO	202 428 07 35	83.6105-0386.3
	CLK 230 Kompressor		06.1997	06.2002	83.7705-0386.3	330828	LATIGUILLO	202 428 07 35	83.6105-0386.3
	CLK 320		06.1997	06.2002	83.7705-0386.3	330828	LATIGUILLO	202 428 07 35	83.6105-0386.3







					Denominación	Ref. OE correspondientes a las referencias ATE		Referencia anterior / varios
--	--	--	--	--	--------------	--	--	------------------------------

MERCEDES BENZ

Clase CLK (C208) Coupé (97-02)	CLK 430		03.1998	06.2002	83.7705-0386.3	330828	LATIGUILLO	202 428 07 35	83.6105-0386.3
	CLK 55 AMG		08.1999	06.2002	83.7705-0386.3	330828	LATIGUILLO	202 428 07 35	83.6105-0386.3
Clase CLK (C209) Coupé (02-)	CLK 200 CGI		09.2002		83.7705-0386.3	330828	LATIGUILLO	202 428 07 35	83.6105-0386.3
	CLK 200 Kompressor		09.2002		83.7705-0386.3	330828	LATIGUILLO	202 428 07 35	83.6105-0386.3
	CLK 220 CDI		05.2005		83.7705-0386.3	330828	LATIGUILLO	202 428 07 35	83.6105-0386.3
	CLK 240		05.2002		83.7705-0386.3	330828	LATIGUILLO	202 428 07 35	83.6105-0386.3
	CLK 270 CDI		10.2002		83.7705-0386.3	330828	LATIGUILLO	202 428 07 35	83.6105-0386.3
	CLK 280		05.2005		83.7705-0386.3	330828	LATIGUILLO	202 428 07 35	83.6105-0386.3
	CLK 320		05.2002		83.7705-0386.3	330828	LATIGUILLO	202 428 07 35	83.6105-0386.3
	CLK 320 CDI		05.2005		83.7705-0386.3	330828	LATIGUILLO	202 428 07 35	83.6105-0386.3
	CLK 350		05.2005		83.7705-0386.3	330828	LATIGUILLO	202 428 07 35	83.6105-0386.3
	CLK 500		05.2002		83.7705-0386.3	330828	LATIGUILLO	202 428 07 35	83.6105-0386.3
	CLK 55 AMG		09.2002		83.7705-0386.3	330828	LATIGUILLO	202 428 07 35	83.6105-0386.3
	CLK 63 AMG		04.2006		83.7705-0386.3	330828	LATIGUILLO	202 428 07 35	83.6105-0386.3
			04.2006		13.0460-4806.2	604806	PASTILLAS DE FRENO	004 420 50 20	ver figura
Clase CL (C215) Coupé (99-06)	CL 500		03.1999	08.2006	03.0137-9297.2	669297	ACCESORIOS ZAPATAS		
	CL 55 AMG		10.1999	08.2006	03.0137-9297.2	669297	ACCESORIOS ZAPATAS		
	CL 55 Kompressor AMG		06.2002	08.2006	03.0137-9297.2	669297	ACCESORIOS ZAPATAS		
	CL 600		03.1999	08.2006	03.0137-9297.2	669297	ACCESORIOS ZAPATAS		
Clase CLS (C219) Coupé (04-)	CLS 280		10.2007		03.0137-9297.2	669297	ACCESORIOS ZAPATAS		





					Denominación	Ref. OE correspondientes a las referencias ATE	 Referencia anterior / varios
---	---	---	---	---	--------------	--	--

MERCEDES BENZ

Clase CLS (C219) Coupé (04-)	CLS 320 CDI		05.2005		03.0137-9297.2	669297	ACCESORIOS ZAPATAS		
	CLS 350		08.2004		03.0137-9297.2	669297	ACCESORIOS ZAPATAS		
	CLS 350 CGI		04.2006		03.0137-9297.2	669297	ACCESORIOS ZAPATAS		
	CLS 500		08.2004		03.0137-9297.2	669297	ACCESORIOS ZAPATAS		
			04.2006		03.0137-9297.2	669297	ACCESORIOS ZAPATAS		
	CLS 55 AMG		01.2005		03.0137-9297.2	669297	ACCESORIOS ZAPATAS		
	CLS 63 AMG		04.2006		03.0137-9297.2	669297	ACCESORIOS ZAPATAS		
Clase E (S210) Break (96-03)	E 200		05.1996	04.2003	83.7705-0386.3	330828	LATIGUILLO	202 428 07 35	83.6105-0386.3
	E 200 Kompressor		09.1997	04.2003	83.7705-0386.3	330828	LATIGUILLO	202 428 07 35	83.6105-0386.3
	E 220 CDI		07.1998	04.2003	83.7705-0386.3	330828	LATIGUILLO	202 428 07 35	83.6105-0386.3
	E 230		05.1996	08.1997	83.7705-0386.3	330828	LATIGUILLO	202 428 07 35	83.6105-0386.3
	E 240		09.1997	04.2003	83.7705-0386.3	330828	LATIGUILLO	202 428 07 35	83.6105-0386.3
	E 250 D		05.1996	04.2003	83.7705-0386.3	330828	LATIGUILLO	202 428 07 35	83.6105-0386.3
	E 250 TD		09.1997	04.2003	83.7705-0386.3	330828	LATIGUILLO	202 428 07 35	83.6105-0386.3
	E 270 CDI		07.1999	04.2003	83.7705-0386.3	330828	LATIGUILLO	202 428 07 35	83.6105-0386.3
	E 280		10.1996	04.2003	83.7705-0386.3	330828	LATIGUILLO	202 428 07 35	83.6105-0386.3
	E 290 TD		05.1996	04.2003	83.7705-0386.3	330828	LATIGUILLO	202 428 07 35	83.6105-0386.3
	E 300 TD		10.1996	04.2003	83.7705-0386.3	330828	LATIGUILLO	202 428 07 35	83.6105-0386.3
	E 320		10.1996	04.2003	83.7705-0386.3	330828	LATIGUILLO	202 428 07 35	83.6105-0386.3
	E 320 CDI		07.1999	04.2003	83.7705-0386.3	330828	LATIGUILLO	202 428 07 35	83.6105-0386.3



					Denominación	Ref. OE correspondientes a las referencias ATE		Referencia anterior / varios
---	---	---	---	---	--------------	--	---	------------------------------

MERCEDES BENZ

Clase E (S210) Break (96-03)	E 420		05.1996	08.1997	83.7705-0386.3	330828	LATIGUILLO	202 428 07 35	83.6105-0386.3
	E 430		09.1997	04.2003	83.7705-0386.3	330828	LATIGUILLO	202 428 07 35	83.6105-0386.3
	E 55 AMG		09.1997	04.2003	83.7705-0386.3	330828	LATIGUILLO	202 428 07 35	83.6105-0386.3
Clase E (S211) Break (03-)	E 200 Kompressor		03.2003		03.0137-9297.2	669297	ACCESORIOS ZAPATAS		
	E 220 CDI		03.2003		03.0137-9297.2	669297	ACCESORIOS ZAPATAS		
	E 240		03.2003		03.0137-9297.2	669297	ACCESORIOS ZAPATAS		
	E 240 4-Matic		07.2003		03.0137-9297.2	669297	ACCESORIOS ZAPATAS		
	E 270 CDI		03.2003		03.0137-9297.2	669297	ACCESORIOS ZAPATAS		
	E 280		05.2005		03.0137-9297.2	669297	ACCESORIOS ZAPATAS		
	E 280 4-Matic		05.2005		03.0137-9297.2	669297	ACCESORIOS ZAPATAS		
	E 280 CDI		05.2004		03.0137-9297.2	669297	ACCESORIOS ZAPATAS		
	E 280 CDI 4-Matic		05.2005		03.0137-9297.2	669297	ACCESORIOS ZAPATAS		
	E 320		03.2003		03.0137-9297.2	669297	ACCESORIOS ZAPATAS		
	E 320 4-Matic		07.2003		03.0137-9297.2	669297	ACCESORIOS ZAPATAS		
	E 320 CDI		03.2003		03.0137-9297.2	669297	ACCESORIOS ZAPATAS		
	E 320 CDI 4-Matic		05.2005		03.0137-9297.2	669297	ACCESORIOS ZAPATAS		
	E 350		12.2004		03.0137-9297.2	669297	ACCESORIOS ZAPATAS		
	E 350 4-Matic		12.2004		03.0137-9297.2	669297	ACCESORIOS ZAPATAS		
	E 500		10.2003		03.0137-9297.2	669297	ACCESORIOS ZAPATAS		
	E 500 4-Matic		10.2003		03.0137-9297.2	669297	ACCESORIOS ZAPATAS		
	E 55 Kompressor AMG		07.2003		03.0137-9297.2	669297	ACCESORIOS ZAPATAS		

Nuevas referencias en almacén - Por aplicación

12/2007



					Denominación	Ref. OE correspondientes a las referencias ATE		Referencia anterior / varios
--	--	--	--	--	--------------	--	--	------------------------------

MERCEDES BENZ

Clase E (S211) Break (03-)	E 63 AMG		03.2006		03.0137-9297.2	669297	ACCESORIOS ZAPATAS		
Clase E (W210) Berlina (95-02)	E 200		06.1995	04.2002	83.7705-0386.3	330828	LATIGUILLO	202 428 07 35	83.6105-0386.3
	E 200 CDI		07.1998	04.2002	83.7705-0386.3	330828	LATIGUILLO	202 428 07 35	83.6105-0386.3
	E 200 D		10.1996	04.2002	83.7705-0386.3	330828	LATIGUILLO	202 428 07 35	83.6105-0386.3
	E 200 Kompressor		09.1997	04.2002	83.7705-0386.3	330828	LATIGUILLO	202 428 07 35	83.6105-0386.3
	E 220 CDI		07.1998	04.2002	83.7705-0386.3	330828	LATIGUILLO	202 428 07 35	83.6105-0386.3
	E 220 D		06.1995	06.1998	83.7705-0386.3	330828	LATIGUILLO	202 428 07 35	83.6105-0386.3
	E 230		06.1995	08.1997	83.7705-0386.3	330828	LATIGUILLO	202 428 07 35	83.6105-0386.3
	E 240		09.1997	04.2002	83.7705-0386.3	330828	LATIGUILLO	202 428 07 35	83.6105-0386.3
	E 250 D		06.1995	04.2002	83.7705-0386.3	330828	LATIGUILLO	202 428 07 35	83.6105-0386.3
	E 250 TD		09.1997	04.2002	83.7705-0386.3	330828	LATIGUILLO	202 428 07 35	83.6105-0386.3
	E 270 CDI		07.1999	04.2002	83.7705-0386.3	330828	LATIGUILLO	202 428 07 35	83.6105-0386.3
	E 280		01.1996	04.2002	83.7705-0386.3	330828	LATIGUILLO	202 428 07 35	83.6105-0386.3
	E 290 TD		01.1996	04.2002	83.7705-0386.3	330828	LATIGUILLO	202 428 07 35	83.6105-0386.3
	E 300 D		06.1995	04.2002	83.7705-0386.3	330828	LATIGUILLO	202 428 07 35	83.6105-0386.3
	E 300 TD		10.1996	04.2002	83.7705-0386.3	330828	LATIGUILLO	202 428 07 35	83.6105-0386.3
	E 320		06.1995	04.2002	83.7705-0386.3	330828	LATIGUILLO	202 428 07 35	83.6105-0386.3
	E 320 CDI		07.1999	04.2002	83.7705-0386.3	330828	LATIGUILLO	202 428 07 35	83.6105-0386.3
	E 420		01.1996	08.1997	83.7705-0386.3	330828	LATIGUILLO	202 428 07 35	83.6105-0386.3



					Denominación	Ref. OE correspondientes a las referencias ATE		Referencia anterior / varios
--	--	--	--	--	--------------	--	--	------------------------------







MERCEDES BENZ

Clase E (W210) Berlina (95-02)	E 430		09.1997	04.2002	83.7705-0386.3	330828	LATIGUILLO	202 428 07 35	83.6105-0386.3
	E 50 AMG		01.1996	08.1997	83.7705-0386.3	330828	LATIGUILLO	202 428 07 35	83.6105-0386.3
	E 55 AMG		09.1997	04.2002	83.7705-0386.3	330828	LATIGUILLO	202 428 07 35	83.6105-0386.3
Clase E (W211) Berlina (02-)	E 200 CDI		05.2002		03.0137-9297.2	669297	ACCESORIOS ZAPATAS		
	E 200 Kompressor		05.2002		03.0137-9297.2	669297	ACCESORIOS ZAPATAS		
	E 220 CDI		03.2002		03.0137-9297.2	669297	ACCESORIOS ZAPATAS		
	E 230		04.2006		03.0137-9297.2	669297	ACCESORIOS ZAPATAS		
	E 240		03.2002		03.0137-9297.2	669297	ACCESORIOS ZAPATAS		
	E 240 4-Matic		03.2003		03.0137-9297.2	669297	ACCESORIOS ZAPATAS		
	E 270 CDI		03.2002		03.0137-9297.2	669297	ACCESORIOS ZAPATAS		
	E 280		05.2005		03.0137-9297.2	669297	ACCESORIOS ZAPATAS		
	E 280 4-Matic		05.2005		03.0137-9297.2	669297	ACCESORIOS ZAPATAS		
	E 280 CDI		05.2004		03.0137-9297.2	669297	ACCESORIOS ZAPATAS		
	E 280 CDI 4-Matic		05.2005		03.0137-9297.2	669297	ACCESORIOS ZAPATAS		
	E 320		03.2002		03.0137-9297.2	669297	ACCESORIOS ZAPATAS		
	E 320 4-Matic		03.2003		03.0137-9297.2	669297	ACCESORIOS ZAPATAS		
	E 320 CDI		11.2002		03.0137-9297.2	669297	ACCESORIOS ZAPATAS		
	E 320 CDI 4-Matic		05.2005		03.0137-9297.2	669297	ACCESORIOS ZAPATAS		
	E 350		12.2004		03.0137-9297.2	669297	ACCESORIOS ZAPATAS		
	E 350 4-Matic		12.2004		03.0137-9297.2	669297	ACCESORIOS ZAPATAS		
	E 400 CDI		03.2003		03.0137-9297.2	669297	ACCESORIOS ZAPATAS		

Nuevas referencias en almacén - Por aplicación

12/2007



					Denominación	Ref. OE correspondientes a las referencias ATE		Referencia anterior / varios
---	---	---	---	---	--------------	--	---	------------------------------

MERCEDES BENZ

Clase E (W211) Berlina (02-)	E 500		03.2002		03.0137-9297.2	669297	ACCESORIOS ZAPATAS		
	E 500 4-Matic		10.2003		03.0137-9297.2	669297	ACCESORIOS ZAPATAS		
	E 55 Kompressor AMG		10.2002		03.0137-9297.2	669297	ACCESORIOS ZAPATAS		
	E 63 AMG		03.2006		03.0137-9297.2	669297	ACCESORIOS ZAPATAS		
Clase S (W220) (98-06)	S 280		11.1998	03.2006	03.0137-9297.2	669297	ACCESORIOS ZAPATAS		
	S 320		11.1998	03.2006	03.0137-9297.2	669297	ACCESORIOS ZAPATAS		
	S 320 CDI		08.1999	03.2006	03.0137-9297.2	669297	ACCESORIOS ZAPATAS		
	S 350		09.2002	03.2006	03.0137-9297.2	669297	ACCESORIOS ZAPATAS		
	S 350 4-Matic		06.2003	03.2006	03.0137-9297.2	669297	ACCESORIOS ZAPATAS		
	S 370		08.2004	03.2006	03.0137-9297.2	669297	ACCESORIOS ZAPATAS		
	S 400 CDI		08.2000	03.2006	03.0137-9297.2	669297	ACCESORIOS ZAPATAS		
	S 430		11.1998	03.2006	03.0137-9297.2	669297	ACCESORIOS ZAPATAS		
	S 430 4-Matic		09.2002	03.2006	03.0137-9297.2	669297	ACCESORIOS ZAPATAS		
	S 500		11.1998	03.2006	03.0137-9297.2	669297	ACCESORIOS ZAPATAS		
	S 500 4-Matic		09.2002	03.2006	03.0137-9297.2	669297	ACCESORIOS ZAPATAS		
	S 55 AMG		04.1999	03.2006	03.0137-9297.2	669297	ACCESORIOS ZAPATAS		
	S 55 AMG Kompressor		06.2002	03.2006	03.0137-9297.2	669297	ACCESORIOS ZAPATAS		
	S 600		08.1999	03.2006	03.0137-9297.2	669297	ACCESORIOS ZAPATAS		
Clase SLK (R170) (96-04)	SLK 200		09.1996	03.2004	83.7705-0386.3	330828	LATIGUILLO	202 428 07 35	83.6105-0386.3
	SLK 200 Kompressor		09.1996	03.2004	83.7705-0386.3	330828	LATIGUILLO	202 428 07 35	83.6105-0386.3
	SLK 230 Kompressor		09.1996	03.2004	83.7705-0386.3	330828	LATIGUILLO	202 428 07 35	83.6105-0386.3







					Denominación	Ref. OE correspondientes a las referencias ATE		Referencia anterior / varios
--	--	--	--	--	--------------	--	--	------------------------------

MERCEDES BENZ

Clase SLK (R170) (96-04)	SLK 32 AMG		03.2001	03.2004	83.7705-0386.3	330828	LATIGUILLO	202 428 07 35	83.6105-0386.3
	SLK 320		04.2000	03.2004	83.7705-0386.3	330828	LATIGUILLO	202 428 07 35	83.6105-0386.3
Clase SLK (R171) (04-)	SLK 200 Kompressor		03.2004		83.7705-0386.3	330828	LATIGUILLO	202 428 07 35	83.6105-0386.3
	SLK 280		04.2005		83.7705-0386.3	330828	LATIGUILLO	202 428 07 35	83.6105-0386.3
	SLK 350		03.2004		83.7705-0386.3	330828	LATIGUILLO	202 428 07 35	83.6105-0386.3
	SLK 55 AMG		03.2004		83.7705-0386.3	330828	LATIGUILLO	202 428 07 35	83.6105-0386.3
			03.2004		13.0460-4806.2	604806	PASTILLAS DE FRENO	004 420 50 20	ver figura
Clase SL (R230) (01-)	SL 280		11.2007		03.0137-9297.2	669297	ACCESORIOS ZAPATAS		
	SL 350		02.2003		03.0137-9297.2	669297	ACCESORIOS ZAPATAS		
	SL 500		09.2001		03.0137-9297.2	669297	ACCESORIOS ZAPATAS		
	SL 55 AMG		09.2001		03.0137-9297.2	669297	ACCESORIOS ZAPATAS		
	SL 600		04.2003		03.0137-9297.2	669297	ACCESORIOS ZAPATAS		
	SL 65 AMG		03.2004		03.0137-9297.2	669297	ACCESORIOS ZAPATAS		
Transporter (BM 905) SPRINTER (01-06)	616 CDI		04.2001	05.2006	24.8190-0423.2	620423	JGO. CONTACTO DESGAST	669 540 07 17 , 669 540 09 17 , 669 540 08 17	







					Denominación	Ref. OE correspondientes a las referencias ATE	 Referencia anterior / varios
---	---	---	---	---	--------------	--	--

MITSUBISHI

Modelo	Motor	Desde	Hasta	Ref. ATE	Ref. OE	Denominación	Ref. OE correspondientes a las referencias ATE	Referencia anterior / varios
L 200 (96-06)	2,0 i (K62T)	06.1996	07.2001	03.0137-0482.2	650482	JUEGO DE ZAPATAS	MN102637 , MR178823	
	2,4 i 4WD (K75T)	06.1996	07.2001	03.0137-9291.2	669291	ACCESORIOS ZAPATAS		
	2,5 D (K64T)	06.1996	07.2001	03.0137-0482.2	650482	JUEGO DE ZAPATAS	MN102637 , MR178823	
	2,5 TD 4WD (K64T)	06.1996	07.2001	03.0137-0482.2	650482	JUEGO DE ZAPATAS	MN102637 , MR178823	
	2,5 TD 4WD (K74T)	06.1996	07.2001	03.0137-9291.2	669291	ACCESORIOS ZAPATAS		
		08.2001	04.2006	03.0137-9291.2	669291	ACCESORIOS ZAPATAS		
	2,5 TDi 4WD (K74T)	08.2001	04.2006	03.0137-9291.2	669291	ACCESORIOS ZAPATAS		
PAJERO PININ / SHOGUN PININ (GB) (99-)	1,8 i 16V (H67W)	11.2001		24.0122-0230.1	422230	DISCO DE FRENO	MR334996	
	1,8 i 16V GDi (H66W)	10.1999	10.2001	24.0122-0230.1	422230	DISCO DE FRENO	MR334996	
	2,0 16V GDi (H77W)	09.2000		24.0122-0230.1	422230	DISCO DE FRENO	MR334996	
SPACE GEAR (95-00)	2,0 i 16V	08.1996	05.2000	03.0137-0482.2	650482	JUEGO DE ZAPATAS	MN102637 , MR178823	
		05.1995	05.2000	03.0137-0482.2	650482	JUEGO DE ZAPATAS	MN102637 , MR178823	
	2,4 i	05.1995	05.2000	03.0137-0482.2	650482	JUEGO DE ZAPATAS	MN102637 , MR178823	
	2,5 TDiC	05.1995	05.2000	03.0137-0482.2	650482	JUEGO DE ZAPATAS	MN102637 , MR178823	



					Denominación	Ref. OE correspondientes a las referencias ATE	 Referencia anterior / varios
---	---	---	---	---	--------------	--	--

NISSAN

350 Z (Z33) (03-)	3,5 i V6 (Z33)		10.2003		03.0137-3006.2	653006	JUEGO DE ZAPATAS	D40F0-AR025 , D40F0-AR06K	
MICRA (K11E) (92-02)	1,0 i 16V		09.2000	12.2002	03.0520-4217.3	694217	ATE TOPKIT		
			02.1998	08.2000	03.0520-4217.3	694217	ATE TOPKIT		
	1,3 i 16V		09.2000	12.2002	03.0520-4217.3	694217	ATE TOPKIT		
			02.1998	08.2000	03.0520-4217.3	694217	ATE TOPKIT		
	1,5 D		02.1998	12.2002	03.0520-4217.3	694217	ATE TOPKIT		
MURANO (Z50) (03-)	3,5 i V6 4x4		10.2003		13.0460-0017.2	610017	ACCESORIO PASTILLAS	41080-CA028 , 41080-EB325	
NAVARA (D40M) (05-)	2,5 dCi		07.2005		13.0460-0017.2	610017	ACCESORIO PASTILLAS	41080-CA028 , 41080-EB325	
	2,5 dCi 4WD		10.2006		13.0460-0017.2	610017	ACCESORIO PASTILLAS	41080-CA028 , 41080-EB325	
			07.2005		13.0460-0017.2	610017	ACCESORIO PASTILLAS	41080-CA028 , 41080-EB325	
PATHFINDER (R50) (97-03)	3,3 i V6 4WD		09.1997	10.2000	03.0137-9290.2	669290	ACCESORIOS ZAPATAS	44090-37G10	
			03.1998	10.2000	03.0137-9290.2	669290	ACCESORIOS ZAPATAS	44090-37G10	
	3,5 i V6 4WD		11.2000	08.2003	03.0137-9290.2	669290	ACCESORIOS ZAPATAS	44090-37G10	
PATHFINDER (R51M) (05-)	2,5 dCi 4WD		10.2006		13.0460-0017.2	610017	ACCESORIO PASTILLAS	41080-CA028 , 41080-EB325	
			03.2005		13.0460-0017.2	610017	ACCESORIO PASTILLAS	41080-CA028 , 41080-EB325	
	4,0 4WD		09.2005		13.0460-0017.2	610017	ACCESORIO PASTILLAS	41080-CA028 , 41080-EB325	
PATROL GR II (Y61) (97-)	2,8 TD		06.1997	04.2000	13.0460-5751.2	605751	PASTILLAS DE FRENO	44060-VB190 , 44060-VC090 , D4060-VC090	ver figura
			06.1997	04.2000	13.0460-5879.2	605879	PASTILLAS DE FRENO	41060-VB290 , 41060-VC091 , 41060-VC290 , D1060-VC290 , D1060-VC091	ver figura



					Denominación	Ref. OE correspondientes a las referencias ATE		Referencia anterior / varios
--	--	--	--	--	--------------	--	--	------------------------------

NISSAN

PATROL GR II (Y61) (97-)	3,0 DTi		05.2000		13.0460-5879.2	605879	PASTILLAS DE FRENO	41060-VB290 , 41060-VC091 , 41060-VC290 , D1060-VC290 , D1060-VC091	ver figura
			05.2000		13.0460-5751.2	605751	PASTILLAS DE FRENO	44060-VB190 , 44060-VC090 , D4060-VC090	ver figura
	4,8 i V6		10.2002		13.0460-5879.2	605879	PASTILLAS DE FRENO	41060-VB290 , 41060-VC091 , 41060-VC290 , D1060-VC290 , D1060-VC091	ver figura
PICK-UP (D21) (85-97)	2,4 i 4WD		10.1988	02.1998	03.0137-9290.2	669290	ACCESORIOS ZAPATAS	44090-37G10	
PICK-UP (D22) (98-)			11.2001		03.0137-9290.2	669290	ACCESORIOS ZAPATAS	44090-37G10	
			02.1998	10.2001	03.0137-9290.2	669290	ACCESORIOS ZAPATAS	44090-37G10	
	2,5 TD 4WD		05.1998	10.2001	03.0137-9290.2	669290	ACCESORIOS ZAPATAS	44090-37G10	
	2,5 TDi 4WD		11.2001		03.0137-9290.2	669290	ACCESORIOS ZAPATAS	44090-37G10	
PICK-UP (D22S) (06-)	2,5 DDTi 4WD		01.2006		03.0137-9290.2	669290	ACCESORIOS ZAPATAS	44090-37G10	
PRIMASTAR (X83) Bus (01-)	1,9 dCi (100)		03.2001		24.0112-0177.2	412177	DISCO DE FRENO	43206-00QAB , 43206-00QAC , 77 01 206 846 , 82 00 228 610 , 44 08 276 , 91159916 , 44 14 633 , 44 11 910 , 91166212 , 44 13 736 , 93161254 , 93850649 , 77 11 130 076	24.0112-0163.1
	1,9 dCi (80)		03.2001		24.0112-0177.2	412177	DISCO DE FRENO	43206-00QAB , 43206-00QAC , 77 01 206 846 , 82 00 228 610 , 44 08 276 , 91159916 , 44 14 633 , 44 11 910 , 91166212 , 44 13 736 , 93161254 , 93850649 , 77 11 130 076	24.0112-0163.1



				Denominación	Ref. OE correspondientes a las referencias ATE		Referencia anterior / varios
--	--	--	--	--------------	--	--	------------------------------

NISSAN

PRIMASTAR (X83) Bus (01-)	2,0 i 16V		03.2001		24.0112-0177.2	412177	DISCO DE FRENO	43206-00QAB , 43206-00QAC , 77 01 206 846 , 82 00 228 610 , 44 08 276 , 91159916 , 44 14 633 , 44 11 910 , 91166212 , 44 13 736 , 93161254 , 93850649 , 77 11 130 076	24.0112-0163.1
	2,5 dCi (140)		09.2003		24.0112-0177.2	412177	DISCO DE FRENO	43206-00QAB , 43206-00QAC , 77 01 206 846 , 82 00 228 610 , 44 08 276 , 91159916 , 44 14 633 , 44 11 910 , 91166212 , 44 13 736 , 93161254 , 93850649 , 77 11 130 076	24.0112-0163.1
PRIMASTAR (X83) Van (02-)	1,9 dCi (100)		07.2002		24.0112-0177.2	412177	DISCO DE FRENO	43206-00QAB , 43206-00QAC , 77 01 206 846 , 82 00 228 610 , 44 08 276 , 91159916 , 44 14 633 , 44 11 910 , 91166212 , 44 13 736 , 93161254 , 93850649 , 77 11 130 076	24.0112-0163.1
	1,9 dCi (80)		07.2002		24.0112-0177.2	412177	DISCO DE FRENO	43206-00QAB , 43206-00QAC , 77 01 206 846 , 82 00 228 610 , 44 08 276 , 91159916 , 44 14 633 , 44 11 910 , 91166212 , 44 13 736 , 93161254 , 93850649 , 77 11 130 076	24.0112-0163.1
	2,0 i 16V		07.2002		24.0112-0177.2	412177	DISCO DE FRENO	43206-00QAB , 43206-00QAC , 77 01 206 846 , 82 00 228 610 , 44 08 276 , 91159916 , 44 14 633 , 44 11 910 , 91166212 , 44 13 736 , 93161254 , 93850649 , 77 11 130 076	24.0112-0163.1

Nuevas referencias en almacén - Por aplicación

12/2007



	i				Denominación	Ref. OE correspondientes a las referencias ATE	i Referencia anterior / varios
--	----------	--	--	--	--------------	--	--

NISSAN

PRIMASTAR (X83) Van (02-)	2,5 dCi (140)		09.2003		24.0112-0177.2	412177	DISCO DE FRENO	43206-00QAB , 43206-00QAC , 77 01 206 846 , 82 00 228 610 , 44 08 276 , 91159916 , 44 14 633 , 44 11 910 , 91166212 , 44 13 736 , 93161254 , 93850649 , 77 11 130 076	24.0112-0163.1
X-TRAIL (T30) (01-07)	2,0 i 16V		07.2001	02.2007	03.0137-9293.2	669293	ACCESORIOS ZAPATAS		
	2,0 i 16V 4x4		07.2001	02.2007	03.0137-9293.2	669293	ACCESORIOS ZAPATAS		
	2,2 dCi		12.2003	02.2007	03.0137-9293.2	669293	ACCESORIOS ZAPATAS		
	2,2 dCi 4x4		12.2003	02.2007	03.0137-9293.2	669293	ACCESORIOS ZAPATAS		
	2,2 TDi 4x4		07.2001	11.2003	03.0137-9293.2	669293	ACCESORIOS ZAPATAS		
	2,5 i 16V 4x4		01.2003	02.2007	03.0137-9293.2	669293	ACCESORIOS ZAPATAS		



					Denominación	Ref. OE correspondientes a las referencias ATE	 Referencia anterior / varios
---	---	---	---	---	---------------------	---	---

OPEL

AGILA (00-07)	1		08.2003	07.2007	24.3728-0727.2	590727	CABLE DE EMBRAGUE	47 05 606 , 9210079	
	1,0 12V		09.2000		03.0137-9286.2	669286	ACCESORIOS ZAPATAS		
				07.2007	24.3728-0727.2	590727	CABLE DE EMBRAGUE	47 05 606 , 9210079	
	1,2 16V		09.2000		03.0137-9286.2	669286	ACCESORIOS ZAPATAS		
CALIBRA / Vauxhall Calibra (89-97)	2,5			06.1996	13.0460-0347.2	610347	ACCESORIO PASTILLAS	16 05 007	
OMEGA A / Vauxhall Carlton (87-93)	1,8 Caravan		08.1986	08.1993	13.0460-0347.2	610347	ACCESORIO PASTILLAS	16 05 007	
	1,8 Limousine			08.1993	13.0460-0347.2	610347	ACCESORIO PASTILLAS	16 05 007	
	2,0 Caravan		08.1986	08.1993	13.0460-0347.2	610347	ACCESORIO PASTILLAS	16 05 007	
	2,0 Limousine			08.1993	13.0460-0347.2	610347	ACCESORIO PASTILLAS	16 05 007	
	2,3 D Caravan		08.1986	08.1993	13.0460-0347.2	610347	ACCESORIO PASTILLAS	16 05 007	
	2,3 D Limousine			08.1993	13.0460-0347.2	610347	ACCESORIO PASTILLAS	16 05 007	
	2,3 TD Caravan		08.1986	08.1993	13.0460-0347.2	610347	ACCESORIO PASTILLAS	16 05 007	
	2,3 TD Limousine			08.1993	13.0460-0347.2	610347	ACCESORIO PASTILLAS	16 05 007	
	2,4		08.1988	08.1993	13.0460-0347.2	610347	ACCESORIO PASTILLAS	16 05 007	
	2,6		09.1990	08.1993	13.0460-0347.2	610347	ACCESORIO PASTILLAS	16 05 007	
	3		08.1986	08.1993	13.0460-0347.2	610347	ACCESORIO PASTILLAS	16 05 007	
	3,0 24V		08.1989	08.1993	13.0460-0347.2	610347	ACCESORIO PASTILLAS	16 05 007	
OMEGA B / Vauxhall Omega (94-03)	2		03.1994	09.1999	13.0460-0347.2	610347	ACCESORIO PASTILLAS	16 05 007	
	2,0 16V		03.1994	09.1999	13.0460-0347.2	610347	ACCESORIO PASTILLAS	16 05 007	
	2,0 DTI 16V		09.1997	08.2000	13.0460-0347.2	610347	ACCESORIO PASTILLAS	16 05 007	



					Denominación	Ref. OE correspondientes a las referencias ATE		Referencia anterior / varios
--	--	--	--	--	--------------	--	--	------------------------------







OPEL

OMEGA B / Vauxhall Omega (94-03)	2,2 16V		10.1999	08.2003	13.0460-0347.2	610347	ACCESORIO PASTILLAS	16 05 007	
	2,2 DTI 16V		09.2000	08.2003	13.0460-0347.2	610347	ACCESORIO PASTILLAS	16 05 007	
	2,5 DTI		09.2001	08.2003	13.0460-0347.2	610347	ACCESORIO PASTILLAS	16 05 007	
	2,5 TD		04.1994	08.2003	13.0460-0347.2	610347	ACCESORIO PASTILLAS	16 05 007	
	2,5 V6		03.1994	08.2003	13.0460-0347.2	610347	ACCESORIO PASTILLAS	16 05 007	
	2,6 V6		09.2000	08.2003	13.0460-0347.2	610347	ACCESORIO PASTILLAS	16 05 007	
	3,0 V6		04.1994	01.2001	13.0460-0347.2	610347	ACCESORIO PASTILLAS	16 05 007	
	3,2 V6		02.2001	08.2003	13.0460-0347.2	610347	ACCESORIO PASTILLAS	16 05 007	
SENATOR B / Vauxhall Royal (88-93)	2,5		09.1990	09.1993	13.0460-0347.2	610347	ACCESORIO PASTILLAS	16 05 007	
	2,6		08.1990	09.1993	13.0460-0347.2	610347	ACCESORIO PASTILLAS	16 05 007	
	3		09.1987	09.1993	13.0460-0347.2	610347	ACCESORIO PASTILLAS	16 05 007	
	3,0 24V		08.1989	09.1993	13.0460-0347.2	610347	ACCESORIO PASTILLAS	16 05 007	
SIGNUM / Vauxhall Signum (03-)	2,8 V6 Turbo				24.8190-0721.2	620721	CONTACTO DE DESGASTE	62 35 623 , 13131256	
			03.2006		24.8190-0721.2	620721	CONTACTO DE DESGASTE	62 35 623 , 13131256	
	3,0 V6 CDTI				24.8190-0721.2	620721	CONTACTO DE DESGASTE	62 35 623 , 13131256	
	3,2 V6				24.8190-0721.2	620721	CONTACTO DE DESGASTE	62 35 623 , 13131256	
VECTRA B / Vauxhall Vectra (96-02)	1,6 16V		09.1995	04.2002	13.0460-0347.2	610347	ACCESORIO PASTILLAS	16 05 007	
	1,7 TD		09.1995	11.1996	13.0460-0347.2	610347	ACCESORIO PASTILLAS	16 05 007	
	1,8 16V		09.1995	04.2002	13.0460-0347.2	610347	ACCESORIO PASTILLAS	16 05 007	

Nuevas referencias en almacén - Por aplicación

12/2007



					Denominación	Ref. OE correspondientes a las referencias ATE	 Referencia anterior / varios
---	---	---	---	---	---------------------	---	---

OPEL

VECTRA B / Vauxhall Vectra (96-02)	2,0 16V		09.1995	04.2002	13.0460-0347.2	610347	ACCESORIO PASTILLAS	16 05 007	
	2,0 DI 16V Caravan		11.1996	04.2002	13.0460-0347.2	610347	ACCESORIO PASTILLAS	16 05 007	
	2,0 DTI 16V		06.1997	04.2002	13.0460-0347.2	610347	ACCESORIO PASTILLAS	16 05 007	
	2,2 16V		09.2000	04.2002	13.0460-0347.2	610347	ACCESORIO PASTILLAS	16 05 007	
	2,2 DTI 16V		09.2000	04.2002	13.0460-0347.2	610347	ACCESORIO PASTILLAS	16 05 007	
	2,5 V6		09.1995	09.2000	13.0460-0347.2	610347	ACCESORIO PASTILLAS	16 05 007	
	2,6 V6		09.2000	04.2002	13.0460-0347.2	610347	ACCESORIO PASTILLAS	16 05 007	
VECTRA C (F68,F69)/Vau. Vectra MK II (02-)	2,8 V6 Turbo		08.2006		24.8190-0721.2	620721	CONTACTO DE DESGASTE	62 35 623 , 13131256	
					24.8190-0721.2	620721	CONTACTO DE DESGASTE	62 35 623 , 13131256	
	3,0 CDTI				24.8190-0721.2	620721	CONTACTO DE DESGASTE	62 35 623 , 13131256	
	3,2 V6				24.8190-0721.2	620721	CONTACTO DE DESGASTE	62 35 623 , 13131256	
VECTRA C Caravan (F35) / Vau. MK II (03-)	2,8 V6 Turbo				24.8190-0721.2	620721	CONTACTO DE DESGASTE	62 35 623 , 13131256	
	3,0 V6 CDTI				24.8190-0721.2	620721	CONTACTO DE DESGASTE	62 35 623 , 13131256	
			08.2005		24.8190-0721.2	620721	CONTACTO DE DESGASTE	62 35 623 , 13131256	
	3,2 V6				24.8190-0721.2	620721	CONTACTO DE DESGASTE	62 35 623 , 13131256	
VIVARO (01-)	1,9 DI		08.2001		24.0112-0177.2	412177	DISCO DE FRENO	43206-00QAB , 43206-00QAC , 77 01 206 846 , 82 00 228 610 , 44 08 276 , 91159916 , 44 14 633 , 44 11 910 , 91166212 , 44 13 736 , 93161254 , 93850649 , 77 11 130 076	24.0112-0163.1



					Denominación	Ref. OE correspondientes a las referencias ATE		Referencia anterior / varios
--	--	--	--	--	--------------	--	--	------------------------------

OPEL

VIVARO (01-)	1,9 DTI		08.2001		24.0112-0177.2	412177	DISCO DE FRENO	43206-00QAB , 43206-00QAC , 77 01 206 846 , 82 00 228 610 , 44 08 276 , 91159916 , 44 14 633 , 44 11 910 , 91166212 , 44 13 736 , 93161254 , 93850649 , 77 11 130 076	24.0112-0163.1
	2,0 16V		08.2001		24.0112-0177.2	412177	DISCO DE FRENO	43206-00QAB , 43206-00QAC , 77 01 206 846 , 82 00 228 610 , 44 08 276 , 91159916 , 44 14 633 , 44 11 910 , 91166212 , 44 13 736 , 93161254 , 93850649 , 77 11 130 076	24.0112-0163.1
	2,5 DTI		05.2003		24.0112-0177.2	412177	DISCO DE FRENO	43206-00QAB , 43206-00QAC , 77 01 206 846 , 82 00 228 610 , 44 08 276 , 91159916 , 44 14 633 , 44 11 910 , 91166212 , 44 13 736 , 93161254 , 93850649 , 77 11 130 076	24.0112-0163.1



					Denominación	Ref. OE correspondientes a las referencias ATE		Referencia anterior / varios
--	--	--	--	--	--------------	--	--	------------------------------

PEUGEOT

107 (05-)	1		06.2005		24.3728-0851.2	590851	CABLE DE EMBRAGUE	2150 CQ	
	1,4 HDi		06.2005		24.3728-0852.2	590852	CABLE DE EMBRAGUE	2150 CR	
BOXER (02-06)	2,0 HDi (10/14)		04.2002	03.2006	03.0137-9285.2	669285	ACCESORIOS ZAPATAS	4308 64	
	2,0 i (10/14)		04.2002	03.2006	03.0137-9285.2	669285	ACCESORIOS ZAPATAS	4308 64	
	2,2 HDi (10/14)		04.2002	03.2006	03.0137-9285.2	669285	ACCESORIOS ZAPATAS	4308 64	
	2,8 HDi (10/14)		04.2002	03.2006	03.0137-9285.2	669285	ACCESORIOS ZAPATAS	4308 64	
BOXER Autobús (94-02)	1,9 D (10)		11.2001	03.2002	03.0137-9285.2	669285	ACCESORIOS ZAPATAS	4308 64	
	1,9 TD (10/14)		11.2001	03.2002	03.0137-9285.2	669285	ACCESORIOS ZAPATAS	4308 64	
	2,0 i (10/14)		11.2001	03.2002	03.0137-9285.2	669285	ACCESORIOS ZAPATAS	4308 64	
	2,5 D (14)		11.2001	03.2002	03.0137-9285.2	669285	ACCESORIOS ZAPATAS	4308 64	
	2,5 TD (14)		11.2001	03.2002	03.0137-9285.2	669285	ACCESORIOS ZAPATAS	4308 64	
	2,5 TDi (14)		11.2001	03.2002	03.0137-9285.2	669285	ACCESORIOS ZAPATAS	4308 64	
	2,8 HDi (14)		11.2001	03.2002	03.0137-9285.2	669285	ACCESORIOS ZAPATAS	4308 64	
BOXER Furgón (94-02)	1,9 D (10)		11.2001	03.2002	03.0137-9285.2	669285	ACCESORIOS ZAPATAS	4308 64	
	1,9 TD (10/14)		11.2001	03.2002	03.0137-9285.2	669285	ACCESORIOS ZAPATAS	4308 64	
	2,0 HDi (10/14)		11.2001	03.2002	03.0137-9285.2	669285	ACCESORIOS ZAPATAS	4308 64	
	2,0 i (10/14)		11.2001	03.2002	03.0137-9285.2	669285	ACCESORIOS ZAPATAS	4308 64	
	2,5 D (14)		11.2001	03.2002	03.0137-9285.2	669285	ACCESORIOS ZAPATAS	4308 64	
	2,5 TD (14)		11.2001	03.2002	03.0137-9285.2	669285	ACCESORIOS ZAPATAS	4308 64	



					Denominación	Ref. OE correspondientes a las referencias ATE		Referencia anterior / varios
--	--	--	--	--	--------------	--	--	------------------------------

PEUGEOT

Modelo	Motor	Fecha 1	Fecha 2	Ref. ATE 1	Ref. ATE 2	Denominación	Ref. OE	Referencia anterior / varios
BOXER Furgón (94-02)	2,5 TDi (14)	11.2001	03.2002	03.0137-9285.2	669285	ACCESORIOS ZAPATAS	4308 64	
	2,8 HDi (14)	11.2001	03.2002	03.0137-9285.2	669285	ACCESORIOS ZAPATAS	4308 64	
BOXER Camión con plataforma/Chasis (94-02)	1,9 TD (10/14)	11.2001	03.2002	03.0137-9285.2	669285	ACCESORIOS ZAPATAS	4308 64	
	2,0 i (10/14)	11.2001	03.2002	03.0137-9285.2	669285	ACCESORIOS ZAPATAS	4308 64	
	2,5 D (14)	11.2001	03.2002	03.0137-9285.2	669285	ACCESORIOS ZAPATAS	4308 64	
	2,5 TD (14)	11.2001	03.2002	03.0137-9285.2	669285	ACCESORIOS ZAPATAS	4308 64	
	2,5 TDi (14)	11.2001	03.2002	03.0137-9285.2	669285	ACCESORIOS ZAPATAS	4308 64	
	2,8 HDi (14)	11.2001	03.2002	03.0137-9285.2	669285	ACCESORIOS ZAPATAS	4308 64	





					Denominación	Ref. OE correspondientes a las referencias ATE		Referencia anterior / varios
--	--	--	--	--	--------------	--	--	------------------------------

PORSCHE

911 (996) (97-)	3,4 CARRERA	DI	01.2002		24.0134-0101.1	434101	DISCO DE FRENO	996 351 409 02	
	3,4 CARRERA 4	DI	01.2002		24.0134-0101.1	434101	DISCO DE FRENO	996 351 409 02	
	3,6 CARRERA	DI	01.2002		24.0134-0101.1	434101	DISCO DE FRENO	996 351 409 02	
	3,6 CARRERA 4	DI	01.2002		24.0134-0101.1	434101	DISCO DE FRENO	996 351 409 02	
	3,6 TURBO 4	DI	06.2000		24.0134-0101.1	434101	DISCO DE FRENO	996 351 409 02	
911 CABRIOLE (996) (98-)	3,4 CARRERA	DI	01.2002		24.0134-0101.1	434101	DISCO DE FRENO	996 351 409 02	
	3,4 CARRERA 4	DI	01.2002		24.0134-0101.1	434101	DISCO DE FRENO	996 351 409 02	
	3,6 CARRERA	DI	01.2002		24.0134-0101.1	434101	DISCO DE FRENO	996 351 409 02	
	3,6 CARRERA 4	DI	01.2002		24.0134-0101.1	434101	DISCO DE FRENO	996 351 409 02	
	3,6 TURBO 4	DI	10.2003		24.0134-0101.1	434101	DISCO DE FRENO	996 351 409 02	
911 CABRIOLE (997) (05-)	3,8 CARRERA 4S	DI	04.2005		24.0134-0101.1	434101	DISCO DE FRENO	996 351 409 02	
	3,8 CARRERA S	DI	04.2005		24.0134-0101.1	434101	DISCO DE FRENO	996 351 409 02	
911 COUPE (997) (04-)	3,8 CARRERA 4S	DI	07.2004		24.0134-0101.1	434101	DISCO DE FRENO	996 351 409 02	
	3,8 CARRERA S	DI	07.2004		24.0134-0101.1	434101	DISCO DE FRENO	996 351 409 02	
CAYENNE (03-)	3,2		10.2003		03.0137-9288.2	669288	ACCESORIOS ZAPATAS	34 41 0 002 718 , 34 41 0 005 300 , 7L0 698 545 , 34 41 0 146 840 , 34 41 0 304 483 , 34 41 0 417 558	
	4,5 S		09.2002		03.0137-9288.2	669288	ACCESORIOS ZAPATAS	34 41 0 002 718 , 34 41 0 005 300 , 7L0 698 545 , 34 41 0 146 840 , 34 41 0 304 483 , 34 41 0 417 558	







	i				Denominación	Ref. OE correspondientes a las referencias ATE	i Referencia anterior / varios
---	----------	---	---	---	--------------	--	--

PORSCHE

CAYENNE (03-)	4,5 Turbo		09.2002		03.0137-9288.2	669288	ACCESORIOS ZAPATAS	34 41 0 002 718 , 34 41 0 005 300 , 7L0 698 545 , 34 41 0 146 840 , 34 41 0 304 483 , 34 41 0 417 558	
---------------	-----------	--	---------	--	----------------	--------	--------------------	---	--



					Denominación	Ref. OE correspondientes a las referencias ATE	 Referencia anterior / varios
---	---	---	---	---	--------------	--	--

RENAULT

Modelo	Motor	Desde	Hasta	Ref. ATE	Cantidad	Denominación	Ref. OE correspondientes a las referencias ATE	Referencia anterior / varios
CLIO II Kasten (SB_) (98-05)	1,5 dCi	06.2001	06.2005	03.7853-1502.4	300200	SERVOFRENO T52	77 01 207 899	
CLIO II Limousine (BB_/CB_) (98-05)	1,2 16V	06.2001	06.2005	03.7853-1502.4	300200	SERVOFRENO T52	77 01 207 899	
	1,4 16V	08.2000	06.2005	03.7853-1502.4	300200	SERVOFRENO T52	77 01 207 899	
		10.1999	07.2000	03.7853-1502.4	300200	SERVOFRENO T52	77 01 207 899	
	1,5 dCi	01.2004	06.2005	03.7853-1502.4	300200	SERVOFRENO T52	77 01 207 899	
		06.2001	06.2005	03.7853-1502.4	300200	SERVOFRENO T52	77 01 207 899	
GRAND SCENIC (04-)		04.2004		24.0111-0166.2	411166	DISCO DE FRENO	77 01 206 328 , 77 01 208 230	24.0111-0161.1
	1,6	04.2004		24.0111-0166.2	411166	DISCO DE FRENO	77 01 206 328 , 77 01 208 230	24.0111-0161.1
	1,9 dCi	04.2004		24.0111-0166.2	411166	DISCO DE FRENO	77 01 206 328 , 77 01 208 230	24.0111-0161.1
		05.2005		24.0111-0166.2	411166	DISCO DE FRENO	77 01 206 328 , 77 01 208 230	24.0111-0161.1
	2,0 16V	04.2004		24.0111-0166.2	411166	DISCO DE FRENO	77 01 206 328 , 77 01 208 230	24.0111-0161.1
	2,0 16V Turbo	04.2004		24.0111-0166.2	411166	DISCO DE FRENO	77 01 206 328 , 77 01 208 230	24.0111-0161.1
MEGANE I Grandtour (KA_) (98-03)	1,4 16V (OD)	03.1999	12.2003	24.0111-0166.2	411166	DISCO DE FRENO	77 01 206 328 , 77 01 208 230	24.0111-0161.1
	1,6 16V (O4)	07.1999	12.2003	24.0111-0166.2	411166	DISCO DE FRENO	77 01 206 328 , 77 01 208 230	24.0111-0161.1
	1,8 16V	01.2001	12.2003	24.0111-0166.2	411166	DISCO DE FRENO	77 01 206 328 , 77 01 208 230	24.0111-0161.1







					Denominación	Ref. OE correspondientes a las referencias ATE		Referencia anterior / varios
--	--	--	--	--	--------------	--	--	------------------------------

RENAULT

MEGANE I Grandtour (KA_) (98-03)	1,9 dCi		02.2001	12.2003	24.0111-0166.2	411166	DISCO DE FRENO	77 01 206 328 , 77 01 208 230	24.0111-0161.1
	1,9 dTi (1U)		02.2001	12.2003	24.0111-0166.2	411166	DISCO DE FRENO	77 01 206 328 , 77 01 208 230	24.0111-0161.1
	1,9 dTi (ON)		07.1999	02.2001	24.0111-0166.2	411166	DISCO DE FRENO	77 01 206 328 , 77 01 208 230	24.0111-0161.1
SCENIC I (JA_) (99-03)	1,4 16V (10)		10.1999	06.2003	24.0111-0166.2	411166	DISCO DE FRENO	77 01 206 328 , 77 01 208 230	24.0111-0161.1
	1,4 16V (1H)		10.1999	06.2003	24.0111-0166.2	411166	DISCO DE FRENO	77 01 206 328 , 77 01 208 230	24.0111-0161.1
	1,4 16V (OD)		10.1999	06.2003	24.0111-0166.2	411166	DISCO DE FRENO	77 01 206 328 , 77 01 208 230	24.0111-0161.1
	1,4 16V (OW)		10.1999	06.2003	24.0111-0166.2	411166	DISCO DE FRENO	77 01 206 328 , 77 01 208 230	24.0111-0161.1
	1,6 16V (11)		10.1999	06.2003	24.0111-0166.2	411166	DISCO DE FRENO	77 01 206 328 , 77 01 208 230	24.0111-0161.1
	1,6 16V (OB)		10.1999	06.2003	24.0111-0166.2	411166	DISCO DE FRENO	77 01 206 328 , 77 01 208 230	24.0111-0161.1
	1,6 16V (OJ)		10.1999	06.2003	24.0111-0166.2	411166	DISCO DE FRENO	77 01 206 328 , 77 01 208 230	24.0111-0161.1
	1,8 16V		01.2001	06.2003	24.0111-0166.2	411166	DISCO DE FRENO	77 01 206 328 , 77 01 208 230	24.0111-0161.1
	1,9 dCi (01)		06.2000	06.2003	24.0111-0166.2	411166	DISCO DE FRENO	77 01 206 328 , 77 01 208 230	24.0111-0161.1
	1,9 dCi (05)		06.2000	06.2003	24.0111-0166.2	411166	DISCO DE FRENO	77 01 206 328 , 77 01 208 230	24.0111-0161.1



					Denominación	Ref. OE correspondientes a las referencias ATE	 Referencia anterior / varios
---	---	---	---	---	--------------	--	--

RENAULT

SCENIC I (JA_) (99-03)	1,9 dCi (1F)		06.2000	06.2003	24.0111-0166.2	411166	DISCO DE FRENO	77 01 206 328 , 77 01 208 230	24.0111-0161.1
	1,9 dTi (1U)		01.2001	06.2003	24.0111-0166.2	411166	DISCO DE FRENO	77 01 206 328 , 77 01 208 230	24.0111-0161.1
	1,9 dTi (ON)		10.1999	06.2003	24.0111-0166.2	411166	DISCO DE FRENO	77 01 206 328 , 77 01 208 230	24.0111-0161.1
	2,0 16V		03.2000	06.2003	24.0111-0166.2	411166	DISCO DE FRENO	77 01 206 328 , 77 01 208 230	24.0111-0161.1
	2,0 16V (1B)		06.2000	06.2003	24.0111-0166.2	411166	DISCO DE FRENO	77 01 206 328 , 77 01 208 230	24.0111-0161.1
	2,0 16V (1D)		06.2000	06.2003	24.0111-0166.2	411166	DISCO DE FRENO	77 01 206 328 , 77 01 208 230	24.0111-0161.1
	2,0 16V (OC)		06.2000	06.2003	24.0111-0166.2	411166	DISCO DE FRENO	77 01 206 328 , 77 01 208 230	24.0111-0161.1
TRAFIC II (JL/FL/EL) (01-)	1,9 dCi 100		03.2001		24.0112-0177.2	412177	DISCO DE FRENO	43206-00QAB , 43206-00QAC , 77 01 206 846 , 82 00 228 610 , 44 08 276 , 91159916 , 44 14 633 , 44 11 910 , 91166212 , 44 13 736 , 93161254 , 93850649 , 77 11 130 076	24.0112-0163.1
	1,9 dCi 80		03.2001		24.0112-0177.2	412177	DISCO DE FRENO	43206-00QAB , 43206-00QAC , 77 01 206 846 , 82 00 228 610 , 44 08 276 , 91159916 , 44 14 633 , 44 11 910 , 91166212 , 44 13 736 , 93161254 , 93850649 , 77 11 130 076	24.0112-0163.1



					Denominación	Ref. OE correspondientes a las referencias ATE		Referencia anterior / varios
--	--	--	--	--	--------------	--	--	------------------------------





RENAULT

TRAFIC II (JL/FL/EL) (01-)	2,0 16V		03.2001		24.0112-0177.2	412177	DISCO DE FRENO	43206-00QAB , 43206-00QAC , 77 01 206 846 , 82 00 228 610 , 44 08 276 , 91159916 , 44 14 633 , 44 11 910 , 91166212 , 44 13 736 , 93161254 , 93850649 , 77 11 130 076	24.0112-0163.1
	2,0 dCi		10.2006		24.0112-0177.2	412177	DISCO DE FRENO	43206-00QAB , 43206-00QAC , 77 01 206 846 , 82 00 228 610 , 44 08 276 , 91159916 , 44 14 633 , 44 11 910 , 91166212 , 44 13 736 , 93161254 , 93850649 , 77 11 130 076	24.0112-0163.1
	2,5 dCi		05.2003		24.0112-0177.2	412177	DISCO DE FRENO	43206-00QAB , 43206-00QAC , 77 01 206 846 , 82 00 228 610 , 44 08 276 , 91159916 , 44 14 633 , 44 11 910 , 91166212 , 44 13 736 , 93161254 , 93850649 , 77 11 130 076	24.0112-0163.1
			10.2006		24.0112-0177.2	412177	DISCO DE FRENO	43206-00QAB , 43206-00QAC , 77 01 206 846 , 82 00 228 610 , 44 08 276 , 91159916 , 44 14 633 , 44 11 910 , 91166212 , 44 13 736 , 93161254 , 93850649 , 77 11 130 076	24.0112-0163.1

Nuevas referencias en almacén - Por aplicación

12/2007



					Denominación	Ref. OE correspondientes a las referencias ATE	 Referencia anterior / varios
---	---	---	---	---	---------------------	---	--

SAAB

900 (94-98)	2,0 16V Turbo		09.1996	03.1998	13.0460-0347.2	610347	ACCESORIO PASTILLAS	16 05 007	
	2,0 i		09.1996	03.1998	13.0460-0347.2	610347	ACCESORIO PASTILLAS	16 05 007	
	2,3 16V		09.1996	03.1998	13.0460-0347.2	610347	ACCESORIO PASTILLAS	16 05 007	
	2,5 V6		09.1996	03.1998	13.0460-0347.2	610347	ACCESORIO PASTILLAS	16 05 007	
9-3 Cabriole (YS3D) (98-03)	2,0 i		02.1998	08.2002	13.0460-0347.2	610347	ACCESORIO PASTILLAS	16 05 007	
	2,0 SE Turbo		02.1998	08.2002	13.0460-0347.2	610347	ACCESORIO PASTILLAS	16 05 007	
	2,0 T		10.1999	08.2002	13.0460-0347.2	610347	ACCESORIO PASTILLAS	16 05 007	
			02.1998	08.2002	13.0460-0347.2	610347	ACCESORIO PASTILLAS	16 05 007	
			10.1998	08.2002	13.0460-0347.2	610347	ACCESORIO PASTILLAS	16 05 007	
	2,0 Turbo		01.2001	08.2002	13.0460-0347.2	610347	ACCESORIO PASTILLAS	16 05 007	
	2,3 i		02.1998	08.2002	13.0460-0347.2	610347	ACCESORIO PASTILLAS	16 05 007	
			10.1999	08.2002	13.0460-0347.2	610347	ACCESORIO PASTILLAS	16 05 007	
9-3 Coupé (YS3D) (98-02)	2		01.2001	09.2002	13.0460-0347.2	610347	ACCESORIO PASTILLAS	16 05 007	
			02.1998	09.2002	13.0460-0347.2	610347	ACCESORIO PASTILLAS	16 05 007	
	2,0 Turbo		02.1998	09.2002	13.0460-0347.2	610347	ACCESORIO PASTILLAS	16 05 007	
			10.1998	09.2002	13.0460-0347.2	610347	ACCESORIO PASTILLAS	16 05 007	
			10.1999	09.2002	13.0460-0347.2	610347	ACCESORIO PASTILLAS	16 05 007	
	2,0 Turbo Sport		02.1998	09.2002	13.0460-0347.2	610347	ACCESORIO PASTILLAS	16 05 007	
	2,2 TiD		02.1998	11.2000	13.0460-0347.2	610347	ACCESORIO PASTILLAS	16 05 007	

Nuevas referencias en almacén - Por aplicación

12/2007



					Denominación	Ref. OE correspondientes a las referencias ATE		Referencia anterior / varios
--	--	--	--	--	--------------	--	--	------------------------------

SAAB

9-3 Coupé (YS3D) (98-02)	2,2 TiD		11.2000	09.2002	13.0460-0347.2	610347	ACCESORIO PASTILLAS	16 05 007	
	2,3		02.1998	09.2002	13.0460-0347.2	610347	ACCESORIO PASTILLAS	16 05 007	
	2,3 Viggen		10.1998	09.2002	13.0460-0347.2	610347	ACCESORIO PASTILLAS	16 05 007	
9-3 Berlina (YS3D) (98-02)	2,0 i		02.1998	09.2002	13.0460-0347.2	610347	ACCESORIO PASTILLAS	16 05 007	
	2,0 SE Turbo		02.1998	09.2002	13.0460-0347.2	610347	ACCESORIO PASTILLAS	16 05 007	
	2,0 Turbo		02.1998	09.2002	13.0460-0347.2	610347	ACCESORIO PASTILLAS	16 05 007	
			10.1998	09.2002	13.0460-0347.2	610347	ACCESORIO PASTILLAS	16 05 007	
			10.1999	09.2002	13.0460-0347.2	610347	ACCESORIO PASTILLAS	16 05 007	
	2,2 TiD		11.2000	09.2002	13.0460-0347.2	610347	ACCESORIO PASTILLAS	16 05 007	
			02.1998	11.2000	13.0460-0347.2	610347	ACCESORIO PASTILLAS	16 05 007	
	2,3 i		02.1998	09.2002	13.0460-0347.2	610347	ACCESORIO PASTILLAS	16 05 007	
	2,3 Viggen		10.1998	09.2002	13.0460-0347.2	610347	ACCESORIO PASTILLAS	16 05 007	
9-5 Break (YS3E) (98-)	2,0 t		10.1998		13.0460-0347.2	610347	ACCESORIO PASTILLAS	16 05 007	
	2,3 t		10.1998		13.0460-0347.2	610347	ACCESORIO PASTILLAS	16 05 007	
	3,0 t		10.1998		13.0460-0347.2	610347	ACCESORIO PASTILLAS	16 05 007	
9-5 Berlina (YS3E) (97-)	2,0 t		09.1997		13.0460-0347.2	610347	ACCESORIO PASTILLAS	16 05 007	
	2,3 t		09.1997		13.0460-0347.2	610347	ACCESORIO PASTILLAS	16 05 007	
	3,0 t		01.1998		13.0460-0347.2	610347	ACCESORIO PASTILLAS	16 05 007	



					Denominación	Ref. OE correspondientes a las referencias ATE		Referencia anterior / varios
--	--	--	--	--	--------------	--	--	------------------------------

SUZUKI

Modelo	Motor	Fecha	Fecha	Ref. ATE	Ref. OE	Denominación	Ref. OE correspondientes a las referencias ATE	Referencia anterior / varios
GRAND VITARA (98-)	1,6 i 16V	03.1998		13.0460-5864.2	605864	PASTILLAS DE FRENO	55200-65D00 , 55200-65D01 , 55200-65D21	ver figura
		03.1998		03.0137-9289.2	669289	ACCESORIOS ZAPATAS		
	2,0 i 16V	03.1998		13.0460-5857.2	605857	PASTILLAS DE FRENO	55200-65D10 , 55200-65D31 , 55200-65D50 , 55200-65D11 , 55200-77E00	ver figura
		03.1998		13.0460-5864.2	605864	PASTILLAS DE FRENO	55200-65D00 , 55200-65D01 , 55200-65D21	ver figura
		03.1998		03.0137-9289.2	669289	ACCESORIOS ZAPATAS		
	2,0 TD	03.1998	06.2001	13.0460-5857.2	605857	PASTILLAS DE FRENO	55200-65D10 , 55200-65D31 , 55200-65D50 , 55200-65D11 , 55200-77E00	ver figura
		03.1998	06.2001	03.0137-9289.2	669289	ACCESORIOS ZAPATAS		
	2,0 TDi	07.2001		13.0460-5857.2	605857	PASTILLAS DE FRENO	55200-65D10 , 55200-65D31 , 55200-65D50 , 55200-65D11 , 55200-77E00	ver figura
		07.2001		03.0137-9289.2	669289	ACCESORIOS ZAPATAS		
	2,5 i V6	08.2004		13.0460-5857.2	605857	PASTILLAS DE FRENO	55200-65D10 , 55200-65D31 , 55200-65D50 , 55200-65D11 , 55200-77E00	ver figura
		04.1998		13.0460-5857.2	605857	PASTILLAS DE FRENO	55200-65D10 , 55200-65D31 , 55200-65D50 , 55200-65D11 , 55200-77E00	ver figura
		04.1998		03.0137-9289.2	669289	ACCESORIOS ZAPATAS		
		08.2004		03.0137-9289.2	669289	ACCESORIOS ZAPATAS		
	2,7 i V6	09.2001		13.0460-5857.2	605857	PASTILLAS DE FRENO	55200-65D10 , 55200-65D31 , 55200-65D50 , 55200-65D11 , 55200-77E00	ver figura



	i				Denominación	Ref. OE correspondientes a las referencias ATE	i Referencia anterior / varios
--	----------	--	--	--	---------------------	---	--

SUZUKI

GRAND VITARA (98-)	2,7 i V6		04.2003		13.0460-5857.2	605857	PASTILLAS DE FRENO	55200-65D10 , 55200-65D31 , 55200-65D50 , 55200-65D11 , 55200-77E00	ver figura
VITARA (89-98)	2,0 i V6		12.1994	03.1998	13.0460-5857.2	605857	PASTILLAS DE FRENO	55200-65D10 , 55200-65D31 , 55200-65D50 , 55200-65D11 , 55200-77E00	ver figura







				Denominación	Ref. OE correspondientes a las referencias ATE		Referencia anterior / varios
--	--	--	--	--------------	--	--	------------------------------

TOYOTA

LAND CRUISER 100 (98-)	4,2 TDi (HDJ100)		01.1998		03.0137-3008.2	653008	JUEGO DE ZAPATAS	46540-60050 , 46550-60060 , 46580-60050	
	4,7 V8 (UZJ100)		01.1998		03.0137-3008.2	653008	JUEGO DE ZAPATAS	46540-60050 , 46550-60060 , 46580-60050	
LAND CRUISER 120 (03-)	3,0 D-4D		01.2003		03.0137-3007.2	653007	JUEGO DE ZAPATAS	46580-60060 , 46540-60060 , 46550-60070	
			01.2005		03.0137-3007.2	653007	JUEGO DE ZAPATAS	46580-60060 , 46540-60060 , 46550-60070	
	4,0 VVTi		01.2003		03.0137-3007.2	653007	JUEGO DE ZAPATAS	46580-60060 , 46540-60060 , 46550-60070	
LAND CRUISER 70-75 (90-96)	2,4 (RJ70/73)		01.1990	12.1996	13.0460-5893.2	605893	PASTILLAS DE FRENO	04491-60110 , 04465-60050 , 04465-YZZAX	ver figura
	2,4 TD (LJ70/73)		01.1990	05.1996	13.0460-5893.2	605893	PASTILLAS DE FRENO	04491-60110 , 04465-60050 , 04465-YZZAX	ver figura
LAND CRUISER 90-95 (96-02)	3,0 D-4D (KDJ90/95)		08.2000	08.2002	03.0137-3007.2	653007	JUEGO DE ZAPATAS	46580-60060 , 46540-60060 , 46550-60070	
	3,0 TD (KZJ90/95)		04.1996	07.2000	03.0137-3007.2	653007	JUEGO DE ZAPATAS	46580-60060 , 46540-60060 , 46550-60070	
	3,4 i 24V (VZJ90/95)		04.1996	08.2002	03.0137-3007.2	653007	JUEGO DE ZAPATAS	46580-60060 , 46540-60060 , 46550-60070	



					Denominación	Ref. OE correspondientes a las referencias ATE	 Referencia anterior / varios
---	---	---	---	---	--------------	--	--

VOLKSWAGEN

GOLF IV (98-03)	3,2 R32 4motion		06.2002	10.2003	24.8190-0106.2	620106	CONTACTO DE DESGASTE	1J0 615 121	
GOLF V (03-)	1,9 TDI 4motion		08.2004		83.6249-0519.3	330867	LATIGUILLO	1K0 611 701 A , 1K0 611 701 C	
	2,0 FSI 4motion		08.2004		83.6249-0519.3	330867	LATIGUILLO	1K0 611 701 A , 1K0 611 701 C	
	2,0 TDI 4motion		08.2004		83.6249-0519.3	330867	LATIGUILLO	1K0 611 701 A , 1K0 611 701 C	
	3,2 R32		11.2005		83.6249-0519.3	330867	LATIGUILLO	1K0 611 701 A , 1K0 611 701 C	
GOLF V Variant (07-)	1,4		06.2007		83.7849-0231.3	330872	LATIGUILLO	1K0 611 775 C	
	1,4 TSI		06.2007		83.7849-0231.3	330872	LATIGUILLO	1K0 611 775 C	
			05.2007		83.7849-0231.3	330872	LATIGUILLO	1K0 611 775 C	
	1,6		05.2007		83.7849-0231.3	330872	LATIGUILLO	1K0 611 775 C	
	1,9 TDI		05.2007		83.7849-0231.3	330872	LATIGUILLO	1K0 611 775 C	
	2,0 TDI		05.2007		83.7849-0231.3	330872	LATIGUILLO	1K0 611 775 C	
JETTA III (05-)	1,4 TSI				83.7849-0231.3	330872	LATIGUILLO	1K0 611 775 C	
			05.2007		83.7849-0231.3	330872	LATIGUILLO	1K0 611 775 C	
	1,6 FSI				83.7849-0231.3	330872	LATIGUILLO	1K0 611 775 C	
	1,6 i 16V				83.7849-0231.3	330872	LATIGUILLO	1K0 611 775 C	
	1,9 TDI				83.7849-0231.3	330872	LATIGUILLO	1K0 611 775 C	
	2,0 FSI				83.7849-0231.3	330872	LATIGUILLO	1K0 611 775 C	
	2,0 TDI				83.7849-0231.3	330872	LATIGUILLO	1K0 611 775 C	



					Denominación	Ref. OE correspondientes a las referencias ATE		Referencia anterior / varios
--	--	--	--	--	--------------	--	--	------------------------------

VOLKSWAGEN

JETTA III (05-)	2,0 TFSI				83.7849-0231.3	330872	LATIGUILLO	1K0 611 775 C	
PASSAT (97-05)	4,0 W8 4motion		09.2001	06.2005	24.8190-0107.2	620107	CONTACTO DE DESGASTE	3B7 615 121	
TOUAREG (03-)	2,5 R5 TDI		01.2003		83.6212-0400.3	330865	LATIGUILLO	7L0 611 776 , 7L0 611 776 A	
			01.2003		83.6213-0515.3	330866	LATIGUILLO	7L0 611 701 A , 7L0 611 701 C	
			01.2003		03.0137-9288.2	669288	ACCESORIOS ZAPATAS	34 41 0 002 718 , 34 41 0 005 300 , 7L0 698 545 , 34 41 0 146 840 , 34 41 0 304 483 , 34 41 0 417 558	
	3,0 V6 TDI		11.2004		83.6213-0515.3	330866	LATIGUILLO	7L0 611 701 A , 7L0 611 701 C	
			11.2004		83.6212-0400.3	330865	LATIGUILLO	7L0 611 776 , 7L0 611 776 A	
			11.2004		03.0137-9288.2	669288	ACCESORIOS ZAPATAS	34 41 0 002 718 , 34 41 0 005 300 , 7L0 698 545 , 34 41 0 146 840 , 34 41 0 304 483 , 34 41 0 417 558	
	3,2 V6		11.2002	12.2005	83.6213-0515.3	330866	LATIGUILLO	7L0 611 701 A , 7L0 611 701 C	
			11.2002	12.2005	83.6212-0400.3	330865	LATIGUILLO	7L0 611 776 , 7L0 611 776 A	
			11.2002	12.2005	03.0137-9288.2	669288	ACCESORIOS ZAPATAS	34 41 0 002 718 , 34 41 0 005 300 , 7L0 698 545 , 34 41 0 146 840 , 34 41 0 304 483 , 34 41 0 417 558	
	3,6 V6 FSI		01.2006		83.6212-0400.3	330865	LATIGUILLO	7L0 611 776 , 7L0 611 776 A	
			01.2006		83.6213-0515.3	330866	LATIGUILLO	7L0 611 701 A , 7L0 611 701 C	



					Denominación	Ref. OE correspondientes a las referencias ATE		Referencia anterior / varios
--	--	--	--	--	--------------	--	--	------------------------------

VOLKSWAGEN

TOUAREG (03-)	3,6 V6 FSI		01.2006		03.0137-9288.2	669288	ACCESORIOS ZAPATAS	34 41 0 002 718 , 34 41 0 005 300 , 7L0 698 545 , 34 41 0 146 840 , 34 41 0 304 483 , 34 41 0 417 558	
	4,2 V8		12.2002	11.2006	83.6213-0515.3	330866	LATIGUILLO	7L0 611 701 A , 7L0 611 701 C	
			12.2002	11.2006	83.6212-0400.3	330865	LATIGUILLO	7L0 611 776 , 7L0 611 776 A	
			12.2002	11.2006	03.0137-9288.2	669288	ACCESORIOS ZAPATAS	34 41 0 002 718 , 34 41 0 005 300 , 7L0 698 545 , 34 41 0 146 840 , 34 41 0 304 483 , 34 41 0 417 558	
	4,2 V8 FSI		12.2006		83.6213-0515.3	330866	LATIGUILLO	7L0 611 701 A , 7L0 611 701 C	
			12.2006		83.6212-0400.3	330865	LATIGUILLO	7L0 611 776 , 7L0 611 776 A	
			12.2006		03.0137-9288.2	669288	ACCESORIOS ZAPATAS	34 41 0 002 718 , 34 41 0 005 300 , 7L0 698 545 , 34 41 0 146 840 , 34 41 0 304 483 , 34 41 0 417 558	
	5,0 V10 TDI		11.2002		83.6213-0515.3	330866	LATIGUILLO	7L0 611 701 A , 7L0 611 701 C	
			11.2002		83.6212-0400.3	330865	LATIGUILLO	7L0 611 776 , 7L0 611 776 A	
			11.2002		03.0137-9288.2	669288	ACCESORIOS ZAPATAS	34 41 0 002 718 , 34 41 0 005 300 , 7L0 698 545 , 34 41 0 146 840 , 34 41 0 304 483 , 34 41 0 417 558	
	6,0 W12		08.2004	11.2006	83.6212-0400.3	330865	LATIGUILLO	7L0 611 776 , 7L0 611 776 A	
			08.2004	11.2006	83.6213-0515.3	330866	LATIGUILLO	7L0 611 701 A , 7L0 611 701 C	



					Denominación	Ref. OE correspondientes a las referencias ATE		Referencia anterior / varios
--	--	--	--	--	--------------	--	--	------------------------------

VOLKSWAGEN

TOUAREG (03-)	6,0 W12		08.2004	11.2006	03.0137-9288.2	669288	ACCESORIOS ZAPATAS	34 41 0 002 718 , 34 41 0 005 300 , 7L0 698 545 , 34 41 0 146 840 , 34 41 0 304 483 , 34 41 0 417 558	
TOURAN (03-)	1,4 FSI		01.2006		83.7849-0236.3	330873	LATIGUILLO	1T0 611 775 , 1T0 611 775 A	
	1,4 TSI		09.2006		83.7849-0236.3	330873	LATIGUILLO	1T0 611 775 , 1T0 611 775 A	
			11.2006		83.7849-0236.3	330873	LATIGUILLO	1T0 611 775 , 1T0 611 775 A	
	1,6		01.2006		83.7849-0236.3	330873	LATIGUILLO	1T0 611 775 , 1T0 611 775 A	
	1,6 FSI		01.2006		83.7849-0236.3	330873	LATIGUILLO	1T0 611 775 , 1T0 611 775 A	
	1,9 TDI				83.7849-0236.3	330873	LATIGUILLO	1T0 611 775 , 1T0 611 775 A	
			01.2006		83.7849-0236.3	330873	LATIGUILLO	1T0 611 775 , 1T0 611 775 A	
	2,0 Eco Fuel		02.2006		83.7849-0236.3	330873	LATIGUILLO	1T0 611 775 , 1T0 611 775 A	
	2,0 FSI		01.2006		83.7849-0236.3	330873	LATIGUILLO	1T0 611 775 , 1T0 611 775 A	
	2,0 TDI		02.2006		83.7849-0236.3	330873	LATIGUILLO	1T0 611 775 , 1T0 611 775 A	
			01.2006		83.7849-0236.3	330873	LATIGUILLO	1T0 611 775 , 1T0 611 775 A	
FURGONETA (T5) (03-)	1,9 TDI		06.2006		83.6113-0510.3	330863	LATIGUILLO	7H0 611 701 B	
			04.2003		83.6113-0552.3	330864	LATIGUILLO	7H8 611 701	
			06.2006		83.6113-0552.3	330864	LATIGUILLO	7H8 611 701	
			04.2003		83.6113-0510.3	330863	LATIGUILLO	7H0 611 701 B	
			06.2006		03.0137-9288.2	669288	ACCESORIOS ZAPATAS	34 41 0 002 718 , 34 41 0 005 300 , 7L0 698 545 , 34 41 0 146 840 , 34 41 0 304 483 , 34 41 0 417 558	





					Denominación	Ref. OE correspondientes a las referencias ATE		Referencia anterior / varios
--	--	--	--	--	--------------	--	--	------------------------------

VOLKSWAGEN

FURGONETA (T5) (03-)	1,9 TDI		04.2003		03.0137-9288.2	669288	ACCESORIOS ZAPATAS	34 41 0 002 718 , 34 41 0 005 300 , 7L0 698 545 , 34 41 0 146 840 , 34 41 0 304 483 , 34 41 0 417 558	
	2		06.2003		83.6113-0552.3	330864	LATIGUILLO	7H8 611 701	
			06.2003		83.6113-0510.3	330863	LATIGUILLO	7H0 611 701 B	
			06.2003		03.0137-9288.2	669288	ACCESORIOS ZAPATAS	34 41 0 002 718 , 34 41 0 005 300 , 7L0 698 545 , 34 41 0 146 840 , 34 41 0 304 483 , 34 41 0 417 558	
	2,5 TDI		02.2003		83.6113-0510.3	330863	LATIGUILLO	7H0 611 701 B	
			02.2003		83.6113-0552.3	330864	LATIGUILLO	7H8 611 701	
			02.2003		03.0137-9288.2	669288	ACCESORIOS ZAPATAS	34 41 0 002 718 , 34 41 0 005 300 , 7L0 698 545 , 34 41 0 146 840 , 34 41 0 304 483 , 34 41 0 417 558	
	2,5 TDI 4motion		07.2004		83.6113-0552.3	330864	LATIGUILLO	7H8 611 701	
			07.2004		83.6113-0510.3	330863	LATIGUILLO	7H0 611 701 B	
			07.2004		03.0137-9288.2	669288	ACCESORIOS ZAPATAS	34 41 0 002 718 , 34 41 0 005 300 , 7L0 698 545 , 34 41 0 146 840 , 34 41 0 304 483 , 34 41 0 417 558	
	3,2 V6		02.2003		83.6113-0552.3	330864	LATIGUILLO	7H8 611 701	
			02.2003		83.6113-0510.3	330863	LATIGUILLO	7H0 611 701 B	
			02.2003		03.0137-9288.2	669288	ACCESORIOS ZAPATAS	34 41 0 002 718 , 34 41 0 005 300 , 7L0 698 545 , 34 41 0 146 840 , 34 41 0 304 483 , 34 41 0 417 558	





					Denominación	Ref. OE correspondientes a las referencias ATE	 Referencia anterior / varios
---	---	---	---	---	--------------	--	--

VOLKSWAGEN

FURGONETA (T5) (03-)	3,2 V6 4motion		07.2004		83.6113-0510.3	330863	LATIGUILLO	7H0 611 701 B	
			07.2004		83.6113-0552.3	330864	LATIGUILLO	7H8 611 701	
			07.2004		03.0137-9288.2	669288	ACCESORIOS ZAPATAS	34 41 0 002 718 , 34 41 0 005 300 , 7L0 698 545 , 34 41 0 146 840 , 34 41 0 304 483 , 34 41 0 417 558	



					Denominación	Ref. OE correspondientes a las referencias ATE	 Referencia anterior / varios
---	---	---	---	---	--------------	--	--

VOLVO

S60 (00-)	2,0 T		09.2001		24.0128-0184.1	428184	DISCO DE FRENO	9475266	
			09.2001		03.0137-9283.2	669283	ACCESORIOS ZAPATAS		
	2,3 T5		11.2000		24.0128-0184.1	428184	DISCO DE FRENO	9475266	
			11.2000		03.0137-9283.2	669283	ACCESORIOS ZAPATAS		
	2,4		11.2000		24.0128-0184.1	428184	DISCO DE FRENO	9475266	
			11.2000		03.0137-9283.2	669283	ACCESORIOS ZAPATAS		
	2,4 Bifuel		06.2002		24.0128-0184.1	428184	DISCO DE FRENO	9475266	
			06.2002		03.0137-9283.2	669283	ACCESORIOS ZAPATAS		
	2,4 D		09.2005		24.0128-0184.1	428184	DISCO DE FRENO	9475266	
			12.2001		24.0128-0184.1	428184	DISCO DE FRENO	9475266	
			12.2001		03.0137-9283.2	669283	ACCESORIOS ZAPATAS		
			09.2005		03.0137-9283.2	669283	ACCESORIOS ZAPATAS		
	2,4 D5		07.2001		24.0128-0184.1	428184	DISCO DE FRENO	9475266	
			09.2005		24.0128-0184.1	428184	DISCO DE FRENO	9475266	
			07.2001		03.0137-9283.2	669283	ACCESORIOS ZAPATAS		
			09.2005		03.0137-9283.2	669283	ACCESORIOS ZAPATAS		
	2,4 T		11.2000		24.0128-0184.1	428184	DISCO DE FRENO	9475266	
			11.2000		03.0137-9283.2	669283	ACCESORIOS ZAPATAS		
	2,4 T AWD		11.2001		24.0128-0184.1	428184	DISCO DE FRENO	9475266	
			11.2001		03.0137-9283.2	669283	ACCESORIOS ZAPATAS		







					Denominación	Ref. OE correspondientes a las referencias ATE		Referencia anterior / varios
--	--	--	--	--	--------------	--	--	------------------------------

VOLVO

S60 (00-)	2,4 T5		04.2004		24.0128-0184.1	428184	DISCO DE FRENO	9475266	
			04.2004		03.0137-9283.2	669283	ACCESORIOS ZAPATAS		
	2,5 T		02.2004		24.0128-0184.1	428184	DISCO DE FRENO	9475266	
			02.2004		03.0137-9283.2	669283	ACCESORIOS ZAPATAS		
	2,5 T AWD		04.2004		24.0128-0184.1	428184	DISCO DE FRENO	9475266	
			04.2004		03.0137-9283.2	669283	ACCESORIOS ZAPATAS		
	R 2,5 T AWD		03.2003		03.0137-9283.2	669283	ACCESORIOS ZAPATAS		
S80 I (98-06)	2		06.1998	02.2006	24.0128-0184.1	428184	DISCO DE FRENO	9475266	
			06.1998	02.2006	03.0137-9283.2	669283	ACCESORIOS ZAPATAS		
	2,0 T		12.1999	02.2006	24.0128-0184.1	428184	DISCO DE FRENO	9475266	
			06.1998	02.2006	24.0128-0184.1	428184	DISCO DE FRENO	9475266	
			12.1999	02.2006	03.0137-9283.2	669283	ACCESORIOS ZAPATAS		
			06.1998	02.2006	03.0137-9283.2	669283	ACCESORIOS ZAPATAS		
	2,4		01.1999	02.2006	24.0128-0184.1	428184	DISCO DE FRENO	9475266	
			01.1999	02.2006	03.0137-9283.2	669283	ACCESORIOS ZAPATAS		
	2,4 Bifuel		09.2001	02.2006	24.0128-0184.1	428184	DISCO DE FRENO	9475266	
			09.2001	02.2006	03.0137-9283.2	669283	ACCESORIOS ZAPATAS		
	2,4 D		10.2001	02.2006	24.0128-0184.1	428184	DISCO DE FRENO	9475266	
			10.2001	02.2006	03.0137-9283.2	669283	ACCESORIOS ZAPATAS		
	2,4 D5		08.2001	02.2006	24.0128-0184.1	428184	DISCO DE FRENO	9475266	
			08.2001	02.2006	03.0137-9283.2	669283	ACCESORIOS ZAPATAS		



					Denominación	Ref. OE correspondientes a las referencias ATE	 Referencia anterior / varios
---	---	---	---	---	---------------------	---	---



VOLVO

Modelo	Motor	Desde	Hasta	Ref. ATE	Ref. OE	Denominación	Ref. OE correspondientes a las referencias ATE	Referencia anterior / varios
S80 I (98-06)	2,4 T	06.2000	02.2006	24.0128-0184.1	428184	DISCO DE FRENO	9475266	
		06.2000	02.2006	03.0137-9283.2	669283	ACCESORIOS ZAPATAS		
	2,5 T	07.2003	02.2006	24.0128-0184.1	428184	DISCO DE FRENO	9475266	
		07.2003	02.2006	03.0137-9283.2	669283	ACCESORIOS ZAPATAS		
	2,5 TDI	01.1999	02.2006	24.0128-0184.1	428184	DISCO DE FRENO	9475266	
		01.1999	02.2006	03.0137-9283.2	669283	ACCESORIOS ZAPATAS		
	2,8 T6	05.1998	02.2006	24.0128-0184.1	428184	DISCO DE FRENO	9475266	
		05.1998	02.2006	03.0137-9283.2	669283	ACCESORIOS ZAPATAS		
	2,9	05.1998	02.2006	24.0128-0184.1	428184	DISCO DE FRENO	9475266	
		03.1999	02.2006	24.0128-0184.1	428184	DISCO DE FRENO	9475266	
		05.1998	02.2006	03.0137-9283.2	669283	ACCESORIOS ZAPATAS		
	3	06.2001	02.2006	24.0128-0184.1	428184	DISCO DE FRENO	9475266	
		06.2001	02.2006	03.0137-9283.2	669283	ACCESORIOS ZAPATAS		
	3,0 T6	06.2001	02.2006	24.0128-0184.1	428184	DISCO DE FRENO	9475266	
		06.2001	02.2006	03.0137-9283.2	669283	ACCESORIOS ZAPATAS		
S80 II (06-)	2,4 D	03.2006		03.0137-9283.2	669283	ACCESORIOS ZAPATAS		
		03.2006		03.0137-9283.2	669283	ACCESORIOS ZAPATAS		
	03.2006		03.0137-9283.2	669283	ACCESORIOS ZAPATAS			
	03.2006		03.0137-9283.2	669283	ACCESORIOS ZAPATAS			
	03.2006		03.0137-9283.2	669283	ACCESORIOS ZAPATAS			

Nuevas referencias en almacén - Por aplicación

12/2007



					Denominación	Ref. OE correspondientes a las referencias ATE	 Referencia anterior / varios
---	---	---	---	---	---------------------	---	--

VOLVO

V70 II (00-07)	2,0 T		07.2001		24.0128-0184.1	428184	DISCO DE FRENO	9475266	
			07.2001		03.0137-9283.2	669283	ACCESORIOS ZAPATAS		
	2,3 T5		03.2000		24.0128-0184.1	428184	DISCO DE FRENO	9475266	
			03.2000		03.0137-9283.2	669283	ACCESORIOS ZAPATAS		
	2,4		03.2000		24.0128-0184.1	428184	DISCO DE FRENO	9475266	
			03.2000		03.0137-9283.2	669283	ACCESORIOS ZAPATAS		
	2,4 Bifuel		09.2001		24.0128-0184.1	428184	DISCO DE FRENO	9475266	
			09.2001		03.0137-9283.2	669283	ACCESORIOS ZAPATAS		
	2,4 D		12.2001		24.0128-0184.1	428184	DISCO DE FRENO	9475266	
			05.2005		24.0128-0184.1	428184	DISCO DE FRENO	9475266	
			05.2005		03.0137-9283.2	669283	ACCESORIOS ZAPATAS		
			12.2001		03.0137-9283.2	669283	ACCESORIOS ZAPATAS		
	2,4 D5		12.2005		24.0128-0184.1	428184	DISCO DE FRENO	9475266	
			08.2001		24.0128-0184.1	428184	DISCO DE FRENO	9475266	
			08.2001		03.0137-9283.2	669283	ACCESORIOS ZAPATAS		
			12.2005		03.0137-9283.2	669283	ACCESORIOS ZAPATAS		
	2,4 D5 AWD		12.2005		24.0128-0184.1	428184	DISCO DE FRENO	9475266	
			03.2003		24.0128-0184.1	428184	DISCO DE FRENO	9475266	
			03.2003		03.0137-9283.2	669283	ACCESORIOS ZAPATAS		
			12.2005		03.0137-9283.2	669283	ACCESORIOS ZAPATAS		

Nuevas referencias en almacén - Por aplicación

12/2007



					Denominación	Ref. OE correspondientes a las referencias ATE		Referencia anterior / varios
--	--	--	--	--	--------------	--	--	------------------------------

VOLVO

V70 II (00-07)	2,4 T		03.2000		24.0128-0184.1	428184	DISCO DE FRENO	9475266	
			03.2000		03.0137-9283.2	669283	ACCESORIOS ZAPATAS		
	2,4 T AWD		09.2001		24.0128-0184.1	428184	DISCO DE FRENO	9475266	
			09.2001		03.0137-9283.2	669283	ACCESORIOS ZAPATAS		
	2,4 T5		04.2004		24.0128-0184.1	428184	DISCO DE FRENO	9475266	
			04.2004		03.0137-9283.2	669283	ACCESORIOS ZAPATAS		
	2,5 T		04.2004		24.0128-0184.1	428184	DISCO DE FRENO	9475266	
			04.2004		03.0137-9283.2	669283	ACCESORIOS ZAPATAS		
	2,5 T AWD		09.2002		24.0128-0184.1	428184	DISCO DE FRENO	9475266	
			09.2002		03.0137-9283.2	669283	ACCESORIOS ZAPATAS		
	2,5 TDI		03.2000		24.0128-0184.1	428184	DISCO DE FRENO	9475266	
			03.2000		03.0137-9283.2	669283	ACCESORIOS ZAPATAS		
	R 2,5 T AWD		03.2003		03.0137-9283.2	669283	ACCESORIOS ZAPATAS		
XC70 I CROSS COUNTRY (00-07)	2,4 D5 AWD		12.2005		24.0128-0184.1	428184	DISCO DE FRENO	9475266	
			12.2005		03.0137-9283.2	669283	ACCESORIOS ZAPATAS		
	2,4 T AWD		09.2000		24.0128-0184.1	428184	DISCO DE FRENO	9475266	
			09.2000		03.0137-9283.2	669283	ACCESORIOS ZAPATAS		
	2,5 D5 AWD		09.2002		24.0128-0184.1	428184	DISCO DE FRENO	9475266	
			09.2002		03.0137-9283.2	669283	ACCESORIOS ZAPATAS		
	2,5 T AWD		09.2002		24.0128-0184.1	428184	DISCO DE FRENO	9475266	
			09.2002		03.0137-9283.2	669283	ACCESORIOS ZAPATAS		



	i			Denominación	Ref. OE correspondientes a las referencias ATE	i Referencia anterior / varios
--	----------	--	--	--------------	--	--

VOLVO

Modelo	Motor	Fecha	Referencia ATE	Referencia OE	Denominación	Referencia OE correspondiente
XC70 I CROSS COUNTRY (00-07)	3,2 AWD	02.2007	24.0128-0184.1	428184	DISCO DE FRENO	9475266
		02.2007	03.0137-9283.2	669283	ACCESORIOS ZAPATAS	
XC90 (02-)	2,4 D5	10.2002	03.0137-9283.2	669283	ACCESORIOS ZAPATAS	
		05.2006	03.0137-9283.2	669283	ACCESORIOS ZAPATAS	
	2,5 T	10.2002	03.0137-9283.2	669283	ACCESORIOS ZAPATAS	
	3,0 T6	10.2002	03.0137-9283.2	669283	ACCESORIOS ZAPATAS	
	3,2	05.2006	03.0137-9283.2	669283	ACCESORIOS ZAPATAS	
	4,0 V8	01.2005	03.0137-9283.2	669283	ACCESORIOS ZAPATAS	



13.0460-2701.2 602701

Aplicación:

AUDI A6 (C5) (97-05)

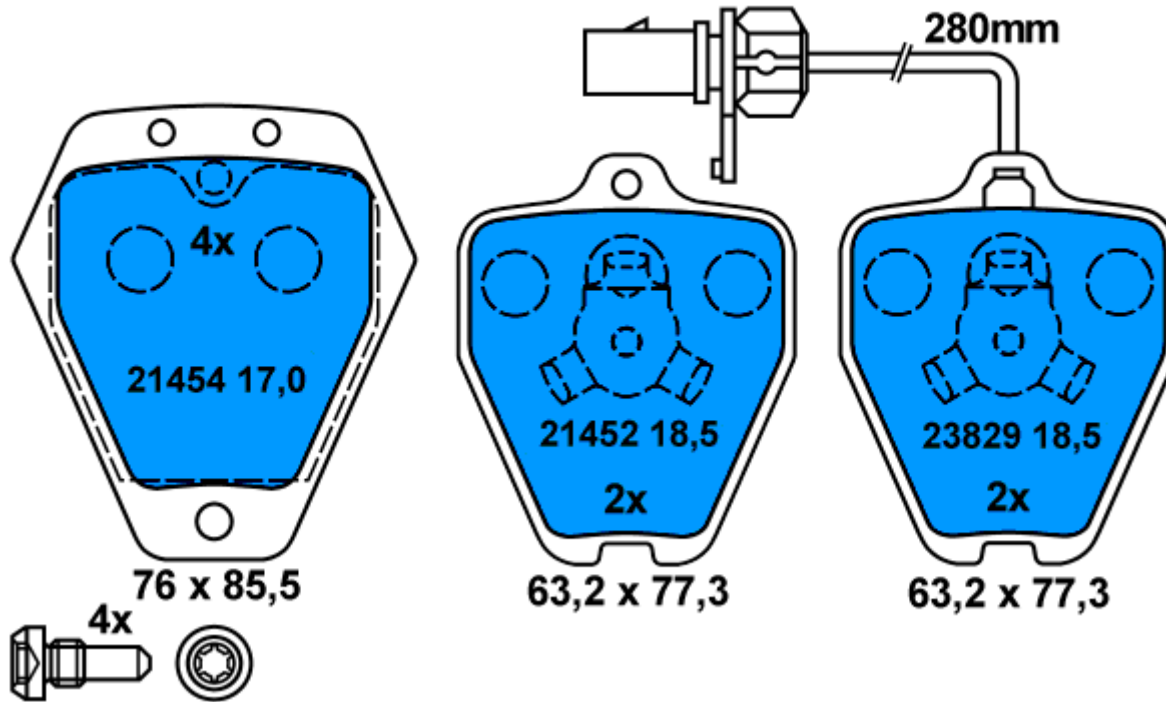



13.0460-5859.2 605859

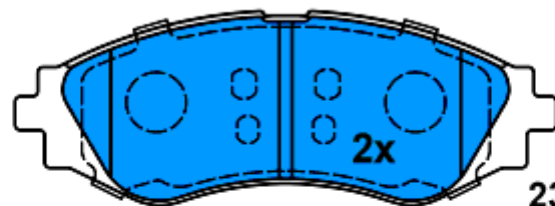

23234 17,5

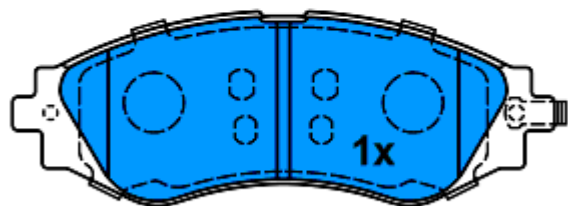

23235 17,5

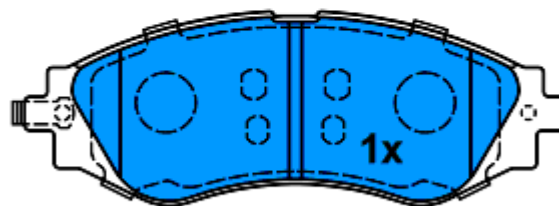

23236 17,5

143,2 x 51,5

Aplicación:

DAEWOO EVANDA (02-05)
CHEVROLET EVANDA (05-)
DAEWOO LEGANZA (97-02)
DAEWOO MAGNUS (99-)
CHEVROLET NUBIRA (05-)
DAEWOO NUBIRA (99-05)
DAEWOO REZZO (00-05)
CHEVROLET REZZO (05-)
DAEWOO TACUMA (00-05)

Ate

13.0460-5863.2 605863

Aplicación:

DAEWOO LACETTI (04-05)
CHEVROLET LACETTI (05-)
CHEVROLET NUBIRA (05-)
DAEWOO NUBIRA (99-05)

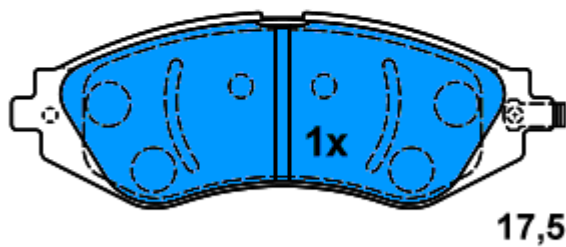
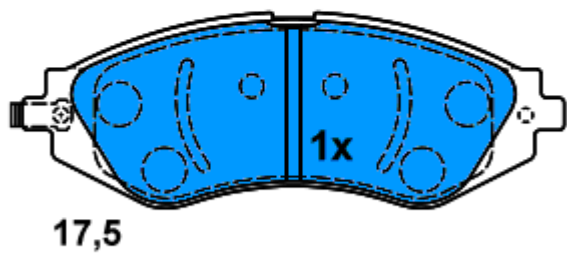
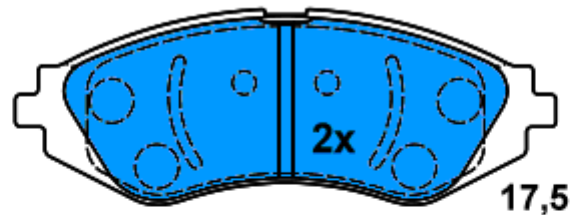

142,9 x 51,3



13.0460-5861.2 605861

Aplicación:

HONDA ACCORD (98-02)

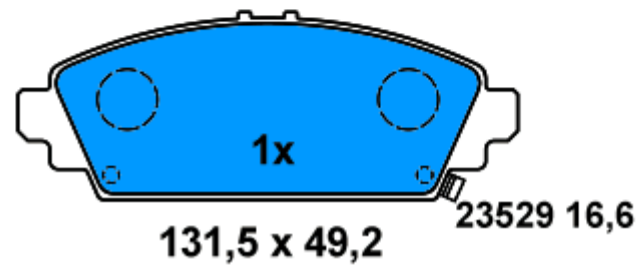
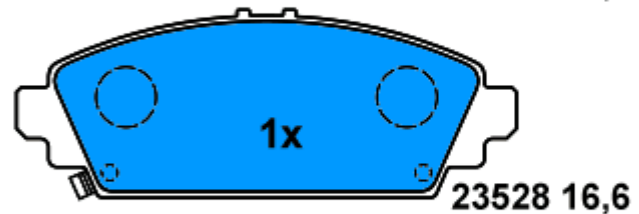
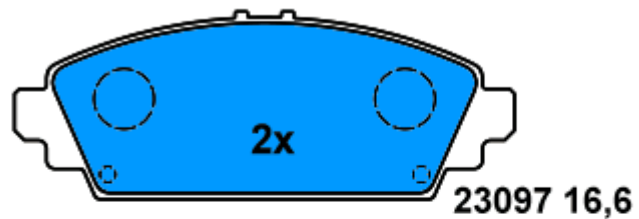
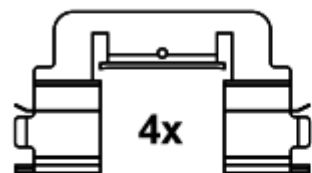

Ate

13.0460-5857.2 605857

Aplicación:

SUZUKI GRAND VITARA (98-)
SUZUKI VITARA (89-98)

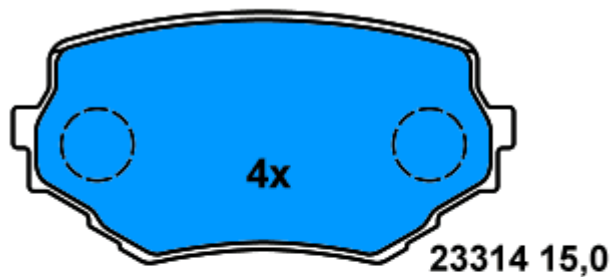
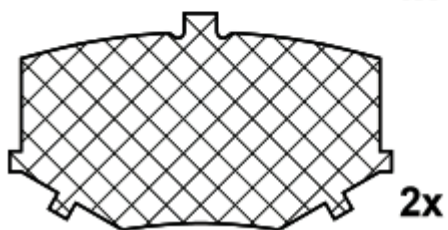
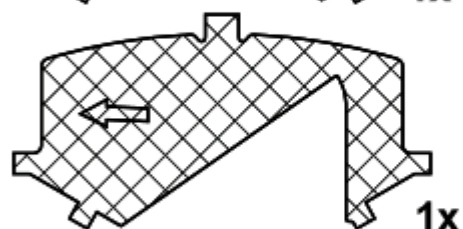
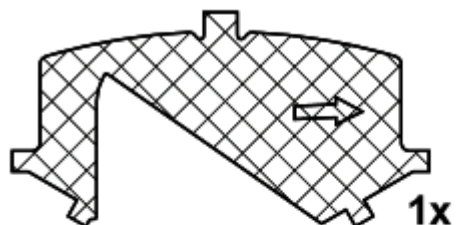

110 x 55

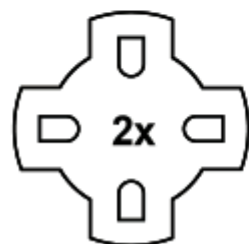



13.0460-2705.2 602705

Aplicación:

AUDI A4 (B5) (95-01)

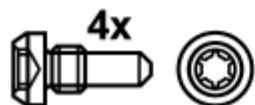
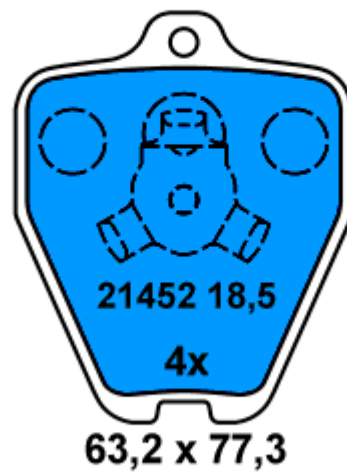
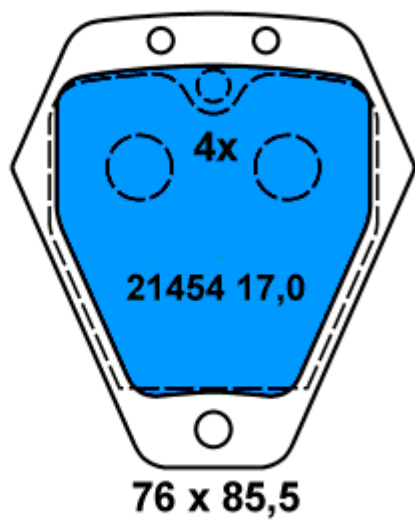

Ate

13.0460-2898.2 602898

Aplicación:

JAGUAR S-TYPE (CCX) (99-)

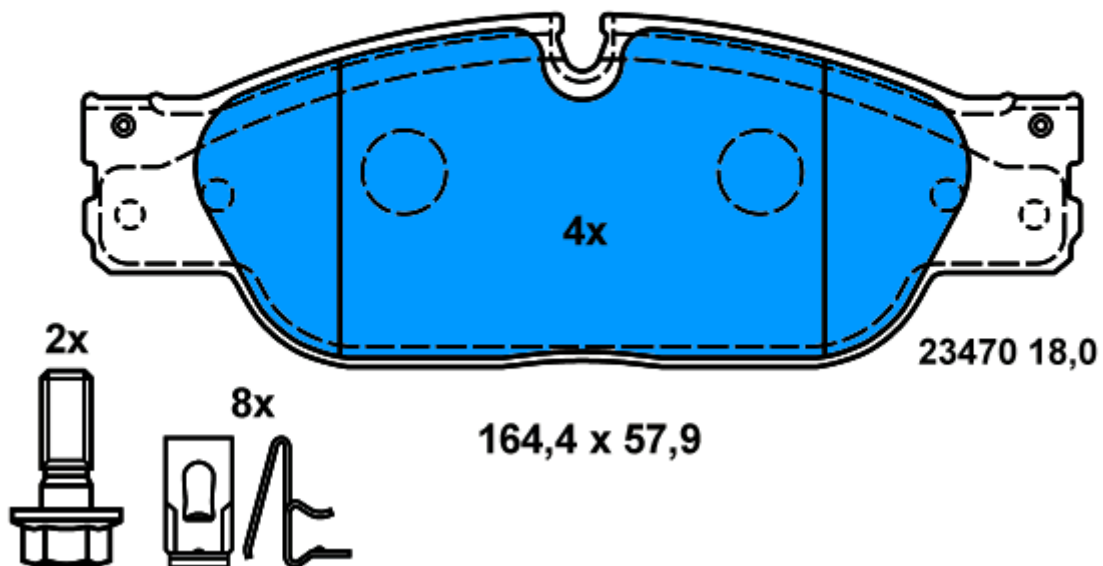

Ate

13.0460-4806.2 604806

Aplicación:

MERCEDES BENZ CLK-Klasse (A209) Cabrio (03-)
MERCEDES BENZ CLK-Klasse (C209) Coupe (02-)
MERCEDES BENZ SLK-Klasse (R171) (04-)

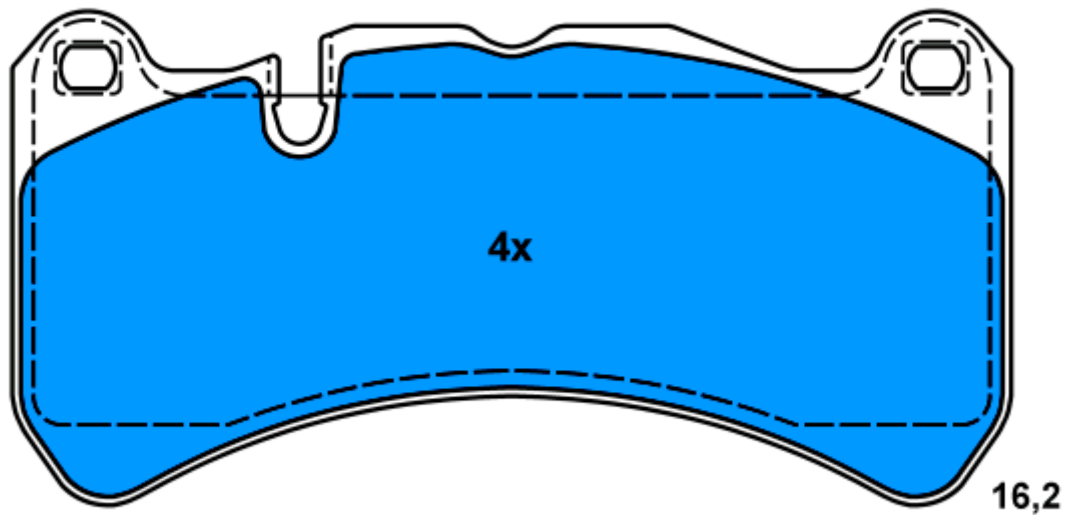



13.0460-5751.2 605751

Aplicación:

NISSAN PATROL GR II (Y61) (97-)

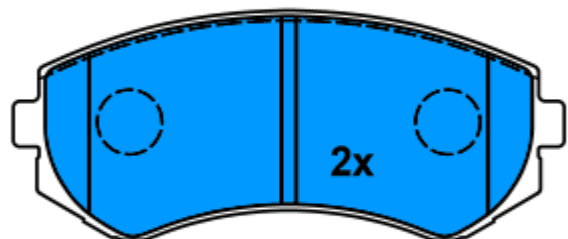

23502 16,0

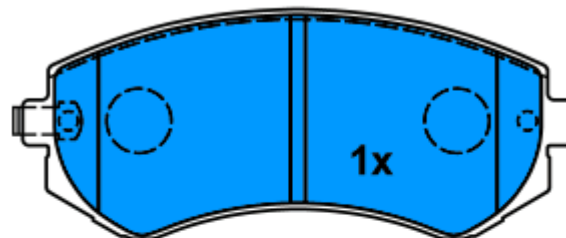

23503 16,0

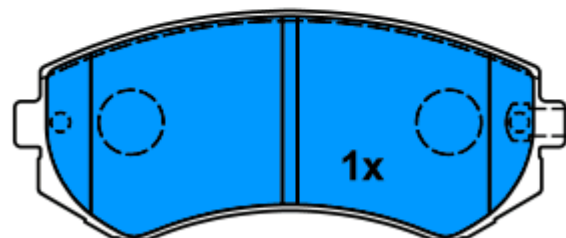

23504 16,0

120,9 x 50,5



13.0460-7206.2 607206

Aplicación:

JEEP GRAND CHEROKEE II (WJ,WG) (99-05)

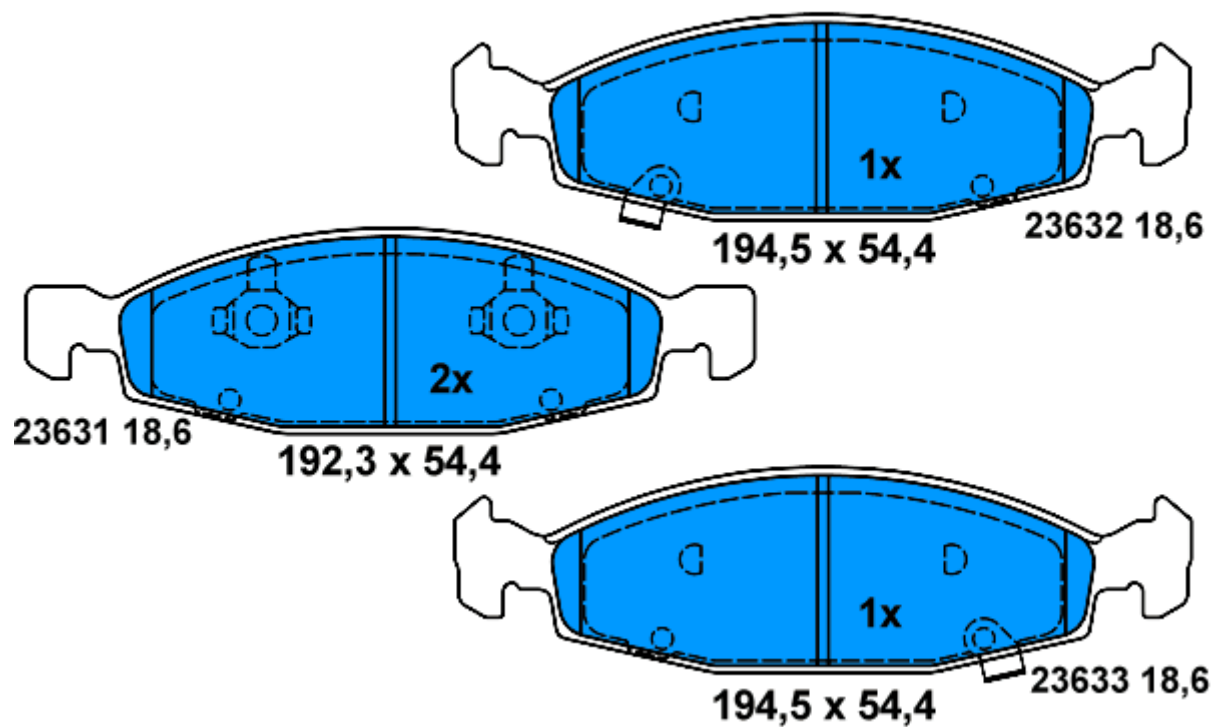

Ate

13.0460-5884.2 605884

Aplicación:

MAZDA MPV II (99-05)

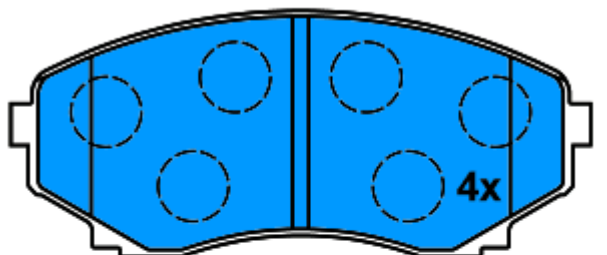
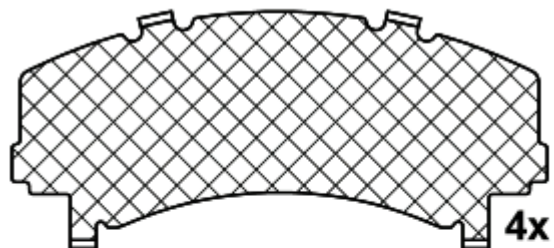

23515 15,8

139 x 59

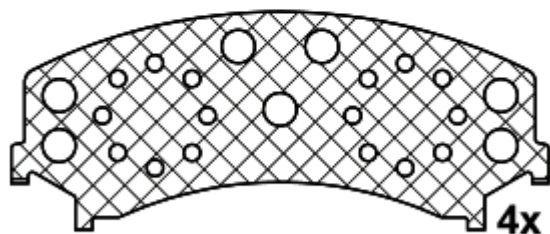

4x



4x



13.0460-5893.2 605893

Aplicación:

TOYOTA LAND CRUISER 70-75 (90-96)

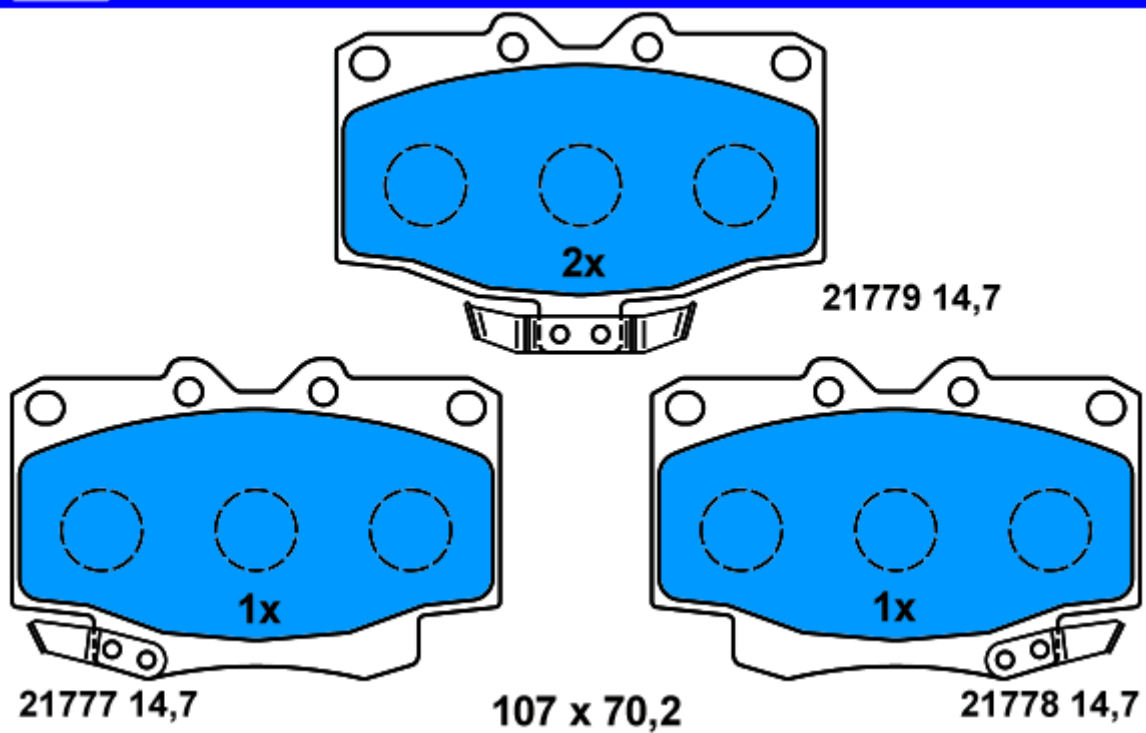



13.0460-5876.2 605876

Aplicación:

HYUNDAI ELANTRA (00-03)
HYUNDAI ELANTRA (03-06)
HYUNDAI LANTRA (00-03)

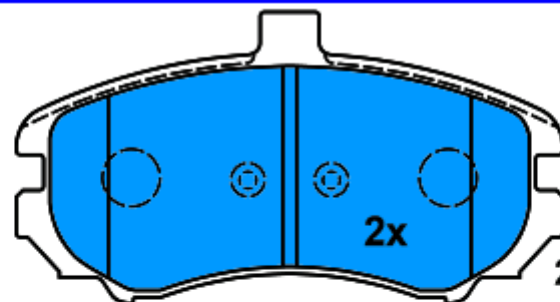

24369 17,2

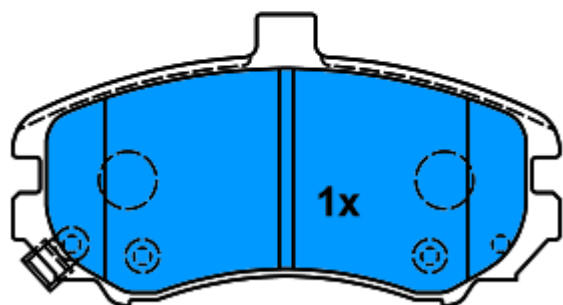

24374 17,2

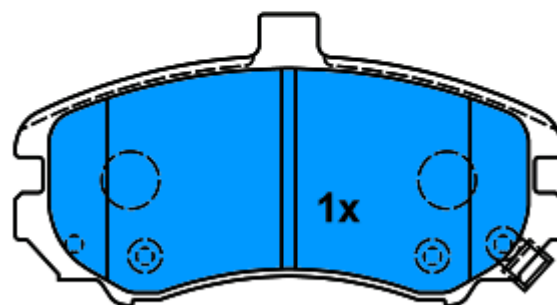

24373 17,2

131,1 x 70



13.0460-5864.2 605864

Aplicación:

SUZUKI GRAND VITARA (98-)

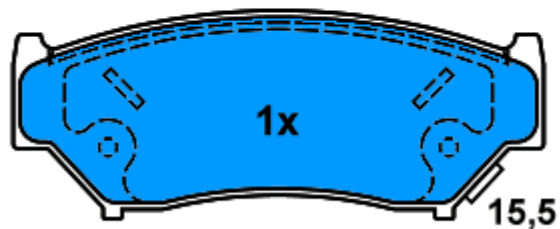
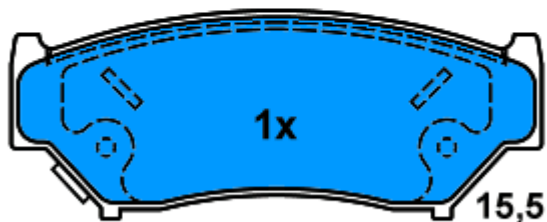
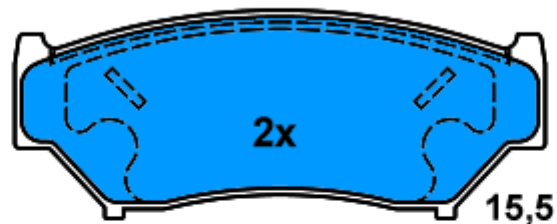

116,4 x 45,7

Ate

13.0460-5867.2 605867

Aplicación:

MAZDA MX-5 (98-05)

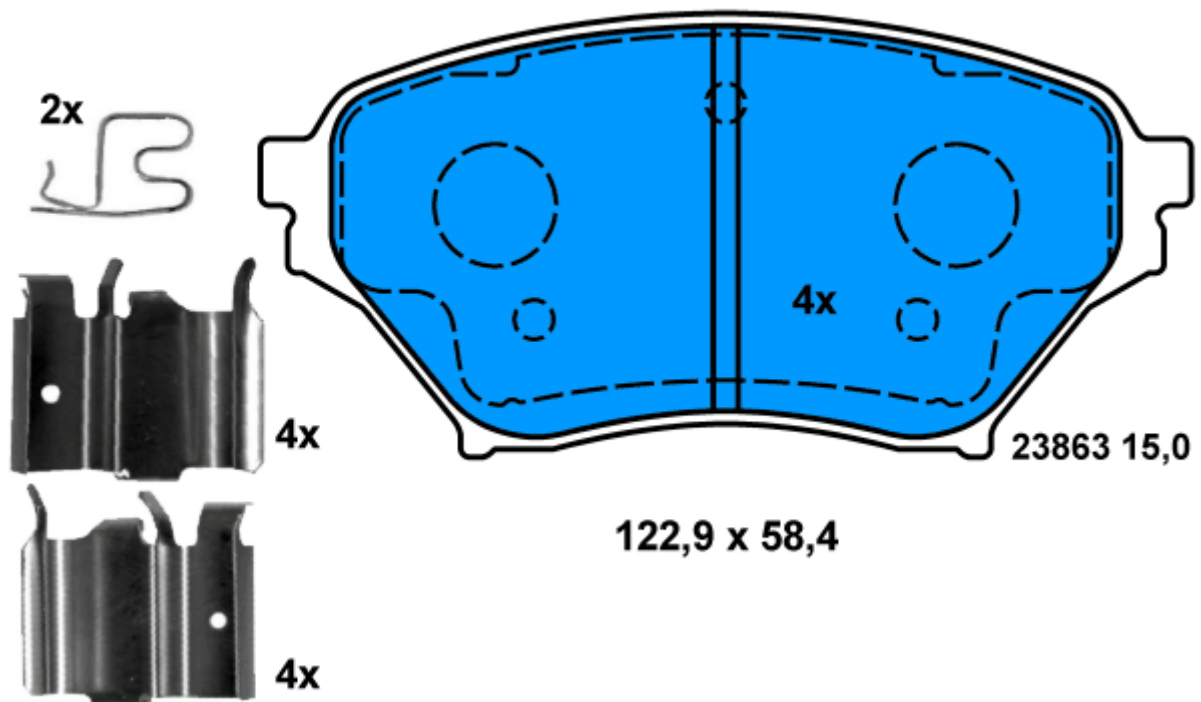



13.0460-5879.2 605879

Aplicación:

NISSAN PATROL GR II (Y61) (97-)

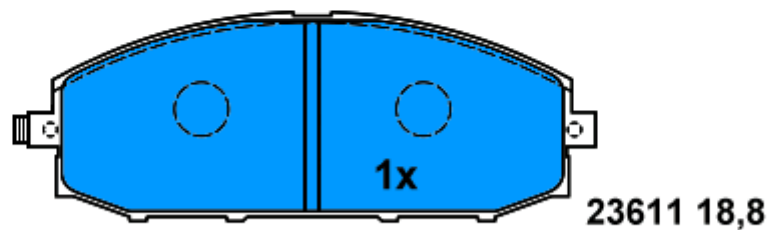
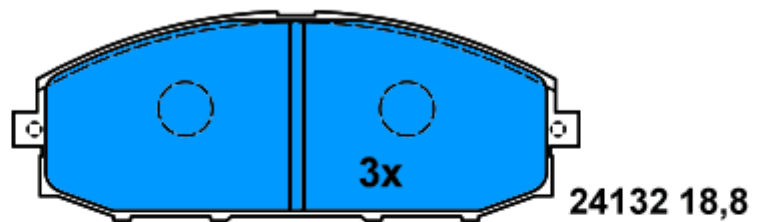

165,7 x 61,4