



Nuevas referencias en almacén

Por aplicación

04/2007



www.ate.de

Nuevas referencias en almacén - Por aplicación

04/2007



					Denominación	Ref. OE correspondientes a las referencias ATE		Referencia anterior / varios
--	--	--	--	--	--------------	--	--	------------------------------

AUDI

A3 (96-03)	1,6		09.1996	06.2003	83.7838-0435.3	330834	LATIGUILLO	1J0 611 701	83.6238-0435.3
	1,8		09.1996	06.2003	83.7838-0435.3	330834	LATIGUILLO	1J0 611 701	83.6238-0435.3
	1,8 T		12.1996	06.2003	83.7838-0435.3	330834	LATIGUILLO	1J0 611 701	83.6238-0435.3
			12.1998	06.2003	83.7838-0435.3	330834	LATIGUILLO	1J0 611 701	83.6238-0435.3
	1,9 TDI		09.2000	06.2003	83.7838-0435.3	330834	LATIGUILLO	1J0 611 701	83.6238-0435.3
			09.1996	06.2001	83.7838-0435.3	330834	LATIGUILLO	1J0 611 701	83.6238-0435.3
			03.1997	06.2001	83.7838-0435.3	330834	LATIGUILLO	1J0 611 701	83.6238-0435.3
A4 (B6) (01-)	1,6				24.0112-0166.1	412166	DISCO DE FRENO	8E0 615 601 M	
	1,8 T				24.0112-0166.1	412166	DISCO DE FRENO	8E0 615 601 M	
	1,8 T Quattro				24.0112-0166.1	412166	DISCO DE FRENO	8E0 615 601 M	
	1,9 TDI				24.0112-0166.1	412166	DISCO DE FRENO	8E0 615 601 M	
	1,9 TDI Quattro				24.0112-0166.1	412166	DISCO DE FRENO	8E0 615 601 M	
	2				24.0112-0166.1	412166	DISCO DE FRENO	8E0 615 601 M	
	2,0 FSI				24.0112-0166.1	412166	DISCO DE FRENO	8E0 615 601 M	
	2,0 TDI		06.2006		24.0112-0166.1	412166	DISCO DE FRENO	8E0 615 601 M	
					24.0112-0166.1	412166	DISCO DE FRENO	8E0 615 601 M	
	2,0 TDI Quattro		01.2006		24.0112-0166.1	412166	DISCO DE FRENO	8E0 615 601 M	
			06.2006		24.0112-0166.1	412166	DISCO DE FRENO	8E0 615 601 M	
	2,0 TFSI				24.0112-0166.1	412166	DISCO DE FRENO	8E0 615 601 M	

Nuevas referencias en almacén - Por aplicación

04/2007









				Denominación	Ref. OE correspondientes a las referencias ATE		Referencia anterior / varios
--	--	--	--	--------------	--	--	------------------------------

AUDI

Modelo	Motor	Fecha	Ref. ATE	Ref. OE	Denominación	Ref. OE correspondientes a las referencias ATE	Referencia anterior / varios
A4 (B6) (01-)	2,0 TFSI Quattro			24.0112-0166.1 412166	DISCO DE FRENO	8E0 615 601 M	
	2,4			24.0112-0166.1 412166	DISCO DE FRENO	8E0 615 601 M	
	2,5 TDI			24.0112-0166.1 412166	DISCO DE FRENO	8E0 615 601 M	
	2,5 TDI Quattro			24.0112-0166.1 412166	DISCO DE FRENO	8E0 615 601 M	
	2,7 TDI	01.2006		24.0112-0166.1 412166	DISCO DE FRENO	8E0 615 601 M	
	3			24.0112-0166.1 412166	DISCO DE FRENO	8E0 615 601 M	
	3,0 Quattro			24.0112-0166.1 412166	DISCO DE FRENO	8E0 615 601 M	
	3,0 TDI Quattro			24.0112-0166.1 412166	DISCO DE FRENO	8E0 615 601 M	
		01.2006		24.0112-0166.1 412166	DISCO DE FRENO	8E0 615 601 M	
	3,2 FSI			24.0112-0166.1 412166	DISCO DE FRENO	8E0 615 601 M	
	3,2 FSI Quattro			24.0112-0166.1 412166	DISCO DE FRENO	8E0 615 601 M	
A4 CABRIOLE (02-)	1,8 T			24.0112-0166.1 412166	DISCO DE FRENO	8E0 615 601 M	
	1,8 T Quattro			24.0112-0166.1 412166	DISCO DE FRENO	8E0 615 601 M	
	2			24.0112-0166.1 412166	DISCO DE FRENO	8E0 615 601 M	
	2,0 TDI			24.0112-0166.1 412166	DISCO DE FRENO	8E0 615 601 M	
	2,0 TFSI			24.0112-0166.1 412166	DISCO DE FRENO	8E0 615 601 M	
	2,4			24.0112-0166.1 412166	DISCO DE FRENO	8E0 615 601 M	
	2,5 TDI			24.0112-0166.1 412166	DISCO DE FRENO	8E0 615 601 M	
	2,7 TDI			24.0112-0166.1 412166	DISCO DE FRENO	8E0 615 601 M	



					Denominación	Ref. OE correspondientes a las referencias ATE	 Referencia anterior / varios
---	---	---	---	---	---------------------	---	---







AUDI

A4 CABRIOLE (02-)	3				24.0112-0166.1	412166	DISCO DE FRENO	8E0 615 601 M	
	3,0 Quattro				24.0112-0166.1	412166	DISCO DE FRENO	8E0 615 601 M	
	3,0 TDI Quattro		01.2006		24.0112-0166.1	412166	DISCO DE FRENO	8E0 615 601 M	
					24.0112-0166.1	412166	DISCO DE FRENO	8E0 615 601 M	
	3,2 FSI				24.0112-0166.1	412166	DISCO DE FRENO	8E0 615 601 M	
	3,2 FSI Quattro				24.0112-0166.1	412166	DISCO DE FRENO	8E0 615 601 M	

Nuevas referencias en almacén - Por aplicación

04/2007



						Denominación	Ref. OE correspondientes a las referencias ATE	 Referencia anterior / varios
---	---	---	---	---	--	--------------	--	--

BMW

1502 - 2002 (65-77)	1600 2		01.1966	12.1968	83.7704-0290.3	330826	LATIGUILLO	34 32 1 108 133 , 34 32 1 116 515 , 34 32 1 189 882 , 34 32 4 650 315	83.6104-0290.3
	1600 2 ti		01.1967	12.1968	83.7704-0290.3	330826	LATIGUILLO	34 32 1 108 133 , 34 32 1 116 515 , 34 32 1 189 882 , 34 32 4 650 315	83.6104-0290.3
	2000		01.1966	12.1969	83.7704-0290.3	330826	LATIGUILLO	34 32 1 108 133 , 34 32 1 116 515 , 34 32 1 189 882 , 34 32 4 650 315	83.6104-0290.3
	2002		01.1968	12.1969	83.7704-0290.3	330826	LATIGUILLO	34 32 1 108 133 , 34 32 1 116 515 , 34 32 1 189 882 , 34 32 4 650 315	83.6104-0290.3
1er Reihe/E87 5-T?rer/E81 3-T?rer (04-)	116 i		09.2004		24.0110-0314.1	410314	DISCO DE FRENO	34 21 6 764 647	
			09.2004		13.0460-2713.2	602713	PASTILLAS DE FRENO	34 21 6 767 145 , 34 21 6 767 146	ver figura
	118 d		09.2004	03.2007	24.0110-0314.1	410314	DISCO DE FRENO	34 21 6 764 647	
			03.2007		24.0122-0238.1	422238	DISCO DE FRENO	34 11 6 764 641	
			09.2004	03.2007	13.0460-2713.2	602713	PASTILLAS DE FRENO	34 21 6 767 145 , 34 21 6 767 146	ver figura
	118 i		09.2004	03.2007	24.0110-0314.1	410314	DISCO DE FRENO	34 21 6 764 647	
			03.2007		24.0122-0238.1	422238	DISCO DE FRENO	34 11 6 764 641	
			03.2007		13.0460-2713.2	602713	PASTILLAS DE FRENO	34 21 6 767 145 , 34 21 6 767 146	ver figura
			09.2004	03.2007	13.0460-2713.2	602713	PASTILLAS DE FRENO	34 21 6 767 145 , 34 21 6 767 146	ver figura
	120 d		09.2004	03.2007	24.0122-0238.1	422238	DISCO DE FRENO	34 11 6 764 641	

Nuevas referencias en almacén - Por aplicación

04/2007



					Denominación	Ref. OE correspondientes a las referencias ATE		Referencia anterior / varios
--	--	--	--	--	--------------	--	--	------------------------------







BMW

1er Reihe/E87 5-T?rer/E81 3-T?rer (04-)	120 i		09.2004	03.2007	24.0122-0238.1	422238	DISCO DE FRENO	34 11 6 764 641	
			03.2007		13.0460-2713.2	602713	PASTILLAS DE FRENO	34 21 6 767 145 , 34 21 6 767 146	ver figura
			09.2004	03.2007	13.0460-2713.2	602713	PASTILLAS DE FRENO	34 21 6 767 145 , 34 21 6 767 146	ver figura
Serie 3/E90 Berlina (05-)	316 i		01.2005		24.0122-0238.1	422238	DISCO DE FRENO	34 11 6 764 641	
			01.2005		13.0460-2713.2	602713	PASTILLAS DE FRENO	34 21 6 767 145 , 34 21 6 767 146	ver figura
	318 d		09.2005		24.0122-0238.1	422238	DISCO DE FRENO	34 11 6 764 641	
			09.2005		13.0460-2713.2	602713	PASTILLAS DE FRENO	34 21 6 767 145 , 34 21 6 767 146	ver figura
	318 i		09.2005		24.0122-0238.1	422238	DISCO DE FRENO	34 11 6 764 641	
			09.2005		13.0460-2713.2	602713	PASTILLAS DE FRENO	34 21 6 767 145 , 34 21 6 767 146	ver figura
	320 i		12.2004		24.0122-0238.1	422238	DISCO DE FRENO	34 11 6 764 641	
			12.2004		13.0460-2713.2	602713	PASTILLAS DE FRENO	34 21 6 767 145 , 34 21 6 767 146	ver figura

CHEVROLET

KALOS (05-)	1,2 i		03.2005		13.0460-5899.2	605899	PASTILLAS DE FRENO	96534653	ver figura
	1,4 i		03.2005		13.0460-5899.2	605899	PASTILLAS DE FRENO	96534653	ver figura
	1,4 i 16V		03.2005		13.0460-5899.2	605899	PASTILLAS DE FRENO	96534653	ver figura



		 		Denominación	Ref. OE correspondientes a las referencias ATE	 Referencia anterior / varios
---	---	---	---	---------------------	---	---

CHRYSLER

VOYAGER (RG) (00-)	2,4		02.2000		13.0460-2899.2	602899	PASTILLAS DE FRENO	5066 427AA	ver figura
	2,5 CRD		02.2000		13.0460-2899.2	602899	PASTILLAS DE FRENO	5066 427AA	ver figura
	2,8 CRD		06.2004		13.0460-2899.2	602899	PASTILLAS DE FRENO	5066 427AA	ver figura
	3,3		02.2000		13.0460-2899.2	602899	PASTILLAS DE FRENO	5066 427AA	ver figura
	3,3 AWD		02.2000		13.0460-2899.2	602899	PASTILLAS DE FRENO	5066 427AA	ver figura
	3,8		02.2000		13.0460-2899.2	602899	PASTILLAS DE FRENO	5066 427AA	ver figura
	3,8 AWD		02.2000		13.0460-2899.2	602899	PASTILLAS DE FRENO	5066 427AA	ver figura









					Denominación	Ref. OE correspondientes a las referencias ATE		Referencia anterior / varios
--	--	--	--	--	--------------	--	--	------------------------------

CITROEN

BERLINGO Break (96-)	1,6 16V	TI	10.2000		24.3727-0349.2	580349	CABLE FRENO DE MANO	4745 Y0 , 4745 X2	
		TD	10.2000		24.3727-0347.2	580347	CABLE FRENO DE MANO	4745 Y1 , 4745 X3	
	1,6 HDi 75	TI	07.2005		24.3727-0349.2	580349	CABLE FRENO DE MANO	4745 Y0 , 4745 X2	
		TD	07.2005		24.3727-0347.2	580347	CABLE FRENO DE MANO	4745 Y1 , 4745 X3	
	1,6 HDi 90	TI	07.2005		24.3727-0349.2	580349	CABLE FRENO DE MANO	4745 Y0 , 4745 X2	
		TD	07.2005		24.3727-0347.2	580347	CABLE FRENO DE MANO	4745 Y1 , 4745 X3	
	2,0 HDi	TI	12.2000		24.3727-0349.2	580349	CABLE FRENO DE MANO	4745 Y0 , 4745 X2	
		TD	12.2000		24.3727-0347.2	580347	CABLE FRENO DE MANO	4745 Y1 , 4745 X3	
C5 Break (01-)	1,8 16V	DD	06.2001		24.3572-1708.7	220620	PINZA DE GARRA	4400 L7	
		DI	06.2001		24.3572-1707.7	220619	PINZA DE GARRA	4400 L6	
	2,0 16V	DI	06.2001		24.3572-1707.7	220619	PINZA DE GARRA	4400 L6	
		DD	06.2001		24.3572-1708.7	220620	PINZA DE GARRA	4400 L7	
	2,0 HDi 110	DI	06.2001		24.3572-1707.7	220619	PINZA DE GARRA	4400 L6	
		DD	06.2001		24.3572-1708.7	220620	PINZA DE GARRA	4400 L7	
	2,0 HDi 90	DI	06.2001		24.3572-1707.7	220619	PINZA DE GARRA	4400 L6	
		DD	06.2001		24.3572-1708.7	220620	PINZA DE GARRA	4400 L7	
C5 Berlina (01-)	2,0 16V	DD	03.2001		24.3572-1708.7	220620	PINZA DE GARRA	4400 L7	
		DI	03.2001		24.3572-1707.7	220619	PINZA DE GARRA	4400 L6	
	2,0 HDi 110	DD	03.2001		24.3572-1708.7	220620	PINZA DE GARRA	4400 L7	



					Denominación	Ref. OE correspondientes a las referencias ATE		Referencia anterior / varios
---	---	---	---	---	--------------	--	---	------------------------------







CITROEN

C5 Berlina (01-)	2,0 HDi 110	DI	03.2001		24.3572-1707.7	220619	PINZA DE GARRA	4400 L6	
	2,0 HDi 90	DD	03.2001		24.3572-1708.7	220620	PINZA DE GARRA	4400 L7	
		DI	03.2001		24.3572-1707.7	220619	PINZA DE GARRA	4400 L6	
C5 II Break (04-)	1,6 HDi	DI	09.2004		24.3572-1707.7	220619	PINZA DE GARRA	4400 L6	
		DD	09.2004		24.3572-1708.7	220620	PINZA DE GARRA	4400 L7	
	1,8 16V	DI	09.2005		24.3572-1707.7	220619	PINZA DE GARRA	4400 L6	
		DI	09.2004		24.3572-1707.7	220619	PINZA DE GARRA	4400 L6	
		DD	09.2005		24.3572-1708.7	220620	PINZA DE GARRA	4400 L7	
		DD	09.2004		24.3572-1708.7	220620	PINZA DE GARRA	4400 L7	
	2,0 16V	DI	09.2004		24.3572-1707.7	220619	PINZA DE GARRA	4400 L6	
		DD	09.2004		24.3572-1708.7	220620	PINZA DE GARRA	4400 L7	
C5 II Berlina (04-)	1,6 HDi	DD	09.2004		24.3572-1708.7	220620	PINZA DE GARRA	4400 L7	
		DI	09.2004		24.3572-1707.7	220619	PINZA DE GARRA	4400 L6	
	2,0 16V	DD	09.2004		24.3572-1708.7	220620	PINZA DE GARRA	4400 L7	
		DI	09.2004		24.3572-1707.7	220619	PINZA DE GARRA	4400 L6	
JUMPER (02-06)	2,0 HDi (10/14/18)		04.2002		03.0137-4002.2	654002	JUEGO DE ZAPATAS	77362699 , 77363478 , 4241 NO , 77362696 , 77363479 , 4241 L9	
				03.2006	03.0137-4002.2	654002	JUEGO DE ZAPATAS	77362699 , 77363478 , 4241 NO , 77362696 , 77363479 , 4241 L9	
			04.2002		24.3727-0348.2	580348	CABLE FRENO DE MANO	4745 V4	

Nuevas referencias en almacén - Por aplicación

04/2007



					Denominación	Ref. OE correspondientes a las referencias ATE	 Referencia anterior / varios
---	---	---	---	---	--------------	--	--

CITROEN

JUMPER (02-06)	2,0 i (10/14/18)			03.2006	03.0137-4002.2	654002	JUEGO DE ZAPATAS	77362699 , 77363478 , 4241 NO , 77362696 , 77363479 , 4241 L9	
			04.2002		03.0137-4002.2	654002	JUEGO DE ZAPATAS	77362699 , 77363478 , 4241 NO , 77362696 , 77363479 , 4241 L9	
			04.2002		24.3727-0348.2	580348	CABLE FRENO DE MANO	4745 V4	
	2,2 HDi (10/14/18)			03.2006	03.0137-4002.2	654002	JUEGO DE ZAPATAS	77362699 , 77363478 , 4241 NO , 77362696 , 77363479 , 4241 L9	
			04.2002		03.0137-4002.2	654002	JUEGO DE ZAPATAS	77362699 , 77363478 , 4241 NO , 77362696 , 77363479 , 4241 L9	
			04.2002		24.3727-0348.2	580348	CABLE FRENO DE MANO	4745 V4	
	2,8 HDi (10/14/18)			03.2006	03.0137-4002.2	654002	JUEGO DE ZAPATAS	77362699 , 77363478 , 4241 NO , 77362696 , 77363479 , 4241 L9	
			04.2002		03.0137-4002.2	654002	JUEGO DE ZAPATAS	77362699 , 77363478 , 4241 NO , 77362696 , 77363479 , 4241 L9	
			04.2002		24.3727-0348.2	580348	CABLE FRENO DE MANO	4745 V4	
	2,8 HDi 4x4(10/14/18)		04.2002		24.3727-0348.2	580348	CABLE FRENO DE MANO	4745 V4	
JUMPER Autobús (94-02)	1,9 TD 4x4 (10/14)		08.1996	03.2002	24.3727-0842.2	580842	CABLE FRENO DE MANO	4745 J2	
	2,0 i 4x4 (10/14/18)		08.1996	03.2002	24.3727-0842.2	580842	CABLE FRENO DE MANO	4745 J2	
	2,5 D 4x4 (14/18)		08.1996	03.2002	24.3727-0842.2	580842	CABLE FRENO DE MANO	4745 J2	
	2,5 TD 4x4 (14/18)		08.1996	03.2002	24.3727-0842.2	580842	CABLE FRENO DE MANO	4745 J2	









					Denominación	Ref. OE correspondientes a las referencias ATE		Referencia anterior / varios
--	--	--	--	--	--------------	--	--	------------------------------

CITROEN

Modelo	Motor	Fecha inicio	Fecha fin	Ref. ATE	Ref. OE	Denominación	Ref. OE correspondientes a las referencias ATE	Referencia anterior / varios
JUMPER Autobús (94-02)	2,5 TDi 4x4 (14/18)	12.1996	11.2000	24.3727-0842.2	580842	CABLE FRENO DE MANO	4745 J2	
	2,8 HDi 4x4 (14/18)	09.2000	03.2002	24.3727-0842.2	580842	CABLE FRENO DE MANO	4745 J2	
JUMPER Furgón (94-02)	1,9 D (10)		03.2002	24.3727-0348.2	580348	CABLE FRENO DE MANO	4745 V4	
	1,9 TD (10/14)		03.2002	24.3727-0348.2	580348	CABLE FRENO DE MANO	4745 V4	
	2,0 HDi (10/14/18)	11.2001	03.2002	24.3727-0348.2	580348	CABLE FRENO DE MANO	4745 V4	
	2,0 i (10/14/18)		03.2002	24.3727-0348.2	580348	CABLE FRENO DE MANO	4745 V4	
	2,5 D (14/18)		03.2002	24.3727-0348.2	580348	CABLE FRENO DE MANO	4745 V4	
	2,5 D 4x4 (14/18)	03.2000	03.2002	24.3727-0842.2	580842	CABLE FRENO DE MANO	4745 J2	
	2,5 TD (14/18)		03.2002	24.3727-0348.2	580348	CABLE FRENO DE MANO	4745 V4	
	2,5 TDi (14/18)		11.2000	24.3727-0348.2	580348	CABLE FRENO DE MANO	4745 V4	
	2,5 TDi 4x4 (14/18)	03.2000	11.2000	24.3727-0842.2	580842	CABLE FRENO DE MANO	4745 J2	
	2,8 HDi (14/18)		03.2002	24.3727-0348.2	580348	CABLE FRENO DE MANO	4745 V4	
	2,8 HDi 4x4 (14/18)	09.2000	03.2002	24.3727-0842.2	580842	CABLE FRENO DE MANO	4745 J2	
JUMPER Camión con plataforma/chasis (94-02)	1,9 TD (10/14)		03.2002	24.3727-0348.2	580348	CABLE FRENO DE MANO	4745 V4	
	2,0 i (10/14/18)		03.2002	24.3727-0348.2	580348	CABLE FRENO DE MANO	4745 V4	
	2,5 D (14/18)		03.2002	24.3727-0348.2	580348	CABLE FRENO DE MANO	4745 V4	
	2,5 D 4x4 (14/18)	03.1994	03.2002	24.3727-0842.2	580842	CABLE FRENO DE MANO	4745 J2	
	2,5 TD (14/18)		03.2002	24.3727-0348.2	580348	CABLE FRENO DE MANO	4745 V4	
	2,5 TDi (14/18)		03.2002	24.3727-0348.2	580348	CABLE FRENO DE MANO	4745 V4	



					Denominación	Ref. OE correspondientes a las referencias ATE		Referencia anterior / varios
---	---	---	---	---	--------------	--	---	------------------------------

CITROEN

JUMPER Camión con plataforma/chasis (94-02)	2,5 TDi 4x4 (14/18)		12.1996	03.2002	24.3727-0842.2	580842	CABLE FRENO DE MANO	4745 J2	
	2,8 HDi (14/18)			03.2002	24.3727-0348.2	580348	CABLE FRENO DE MANO	4745 V4	





DAEWOO

KALOS (02-05)	1,2 i		04.2003	02.2005	13.0460-5899.2	605899	PASTILLAS DE FRENO	96534653	ver figura
	1,4 i		09.2002	02.2005	13.0460-5899.2	605899	PASTILLAS DE FRENO	96534653	ver figura
	1,4 i 16V		04.2003	02.2005	13.0460-5899.2	605899	PASTILLAS DE FRENO	96534653	ver figura
	1,6 i 16V		11.2002	02.2005	13.0460-5899.2	605899	PASTILLAS DE FRENO	96534653	ver figura
LEGANZA (97-02)	2,0 i 16V		06.1997	12.2002	24.0110-0282.1	410282	DISCO DE FRENO	96219485	
	2,2 i 16V		04.1999	12.2002	24.0110-0282.1	410282	DISCO DE FRENO	96219485	

Nuevas referencias en almacén - Por aplicación

04/2007



				Denominación	Ref. OE correspondientes a las referencias ATE	 Referencia anterior / varios
---	---	--	---	--------------	--	--

FIAT

DUCATO (02-06)	2,0 i (11/15/18)		04.2002	09.2004	03.0137-4002.2	654002	JUEGO DE ZAPATAS	77362699 , 77363478 , 4241 NO , 77362696 , 77363479 , 4241 L9	
			10.2004	07.2006	03.0137-4002.2	654002	JUEGO DE ZAPATAS	77362699 , 77363478 , 4241 NO , 77362696 , 77363479 , 4241 L9	
	2,0 JTD (11/15/18)		10.2004	07.2006	03.0137-4002.2	654002	JUEGO DE ZAPATAS	77362699 , 77363478 , 4241 NO , 77362696 , 77363479 , 4241 L9	
			04.2002	09.2004	03.0137-4002.2	654002	JUEGO DE ZAPATAS	77362699 , 77363478 , 4241 NO , 77362696 , 77363479 , 4241 L9	
	2,3 JTD (11/15/18)		10.2004	07.2006	03.0137-4002.2	654002	JUEGO DE ZAPATAS	77362699 , 77363478 , 4241 NO , 77362696 , 77363479 , 4241 L9	
			04.2002	09.2004	03.0137-4002.2	654002	JUEGO DE ZAPATAS	77362699 , 77363478 , 4241 NO , 77362696 , 77363479 , 4241 L9	
	2,8 JTD (11/15/18)		10.2004	07.2006	03.0137-4002.2	654002	JUEGO DE ZAPATAS	77362699 , 77363478 , 4241 NO , 77362696 , 77363479 , 4241 L9	
			04.2002	09.2004	03.0137-4002.2	654002	JUEGO DE ZAPATAS	77362699 , 77363478 , 4241 NO , 77362696 , 77363479 , 4241 L9	
	2,8 JTD 4x4(11/15/18)		10.2004	07.2006	03.0137-4002.2	654002	JUEGO DE ZAPATAS	77362699 , 77363478 , 4241 NO , 77362696 , 77363479 , 4241 L9	
			07.2002	09.2004	03.0137-4002.2	654002	JUEGO DE ZAPATAS	77362699 , 77363478 , 4241 NO , 77362696 , 77363479 , 4241 L9	
GRANDE PUNTO (06-)	1,3 JTD		10.2005		24.0122-0241.1	422241	DISCO DE FRENO	55700922 , 55700923	



					Denominación	Ref. OE correspondientes a las referencias ATE		Referencia anterior / varios
--	--	--	--	--	--------------	--	--	------------------------------

FIAT

GRANDE PUNTO (06-)	1,9 JTD		02.2006		24.0122-0241.1	422241	DISCO DE FRENO	55700922 , 55700923	
			10.2005		24.0122-0241.1	422241	DISCO DE FRENO	55700922 , 55700923	
MULTIPLA (98-)	1,6 i 16V	TI	04.2002	11.2005	24.3384-1747.7	220617	PINZA DE GARRA	9949353	
	1,9 JTD	TI	04.2002	11.2005	24.3384-1747.7	220617	PINZA DE GARRA	9949353	
STILO (01-)	1,2 i 16V	TI	10.2001	05.2005	24.3384-1747.7	220617	PINZA DE GARRA	9949353	
	1,4 i 16V	TI	01.2004	05.2005	24.3384-1747.7	220617	PINZA DE GARRA	9949353	
	1,6 i 16V	TI	10.2001	05.2005	24.3384-1747.7	220617	PINZA DE GARRA	9949353	
	1,8 i 16V	TI	10.2001	05.2005	24.3384-1747.7	220617	PINZA DE GARRA	9949353	
	1,9 JTD	TI	09.2004	05.2005	24.3384-1747.7	220617	PINZA DE GARRA	9949353	
		TI	10.2001	05.2005	24.3384-1747.7	220617	PINZA DE GARRA	9949353	
		TI	01.2004	05.2005	24.3384-1747.7	220617	PINZA DE GARRA	9949353	
	2,4 i 20V	TI	10.2001	05.2005	24.3384-1747.7	220617	PINZA DE GARRA	9949353	



						Denominación	Ref. OE correspondientes a las referencias ATE		Referencia anterior / varios
--	--	--	--	--	--	--------------	--	--	------------------------------

FORD

FOCUS I (98-04)	1,4 i 16V		10.1998	08.2001	24.3727-0656.2	580656	CABLE FRENO DE MANO	1101841	
	1,6 i 16V		10.1998	08.2001	24.3727-0656.2	580656	CABLE FRENO DE MANO	1101841	
	1,8 i 16V		10.1998	08.2001	24.3727-0656.2	580656	CABLE FRENO DE MANO	1101841	
	1,8 TDCi		03.2001	08.2001	24.3727-0656.2	580656	CABLE FRENO DE MANO	1101841	
	1,8 Turbo DI		10.1998	08.2001	24.3727-0656.2	580656	CABLE FRENO DE MANO	1101841	
	2,0 i 16V		10.1998	08.2001	24.3727-0656.2	580656	CABLE FRENO DE MANO	1101841	
	ST 170		03.2002	09.2004	24.0110-0313.1	410313	DISCO DE FRENO	4324591 , 4411312	







HYUNDAI

TERRACAN (01-)	2,5 TDiC		11.2001	10.2003	24.0127-0100.1	427100	DISCO DE FRENO	51712-H1000	
	2,9 CRDi		11.2003		24.0127-0100.1	427100	DISCO DE FRENO	51712-H1000	
			11.2001		24.0127-0100.1	427100	DISCO DE FRENO	51712-H1000	
	3,5 i V6 4WD		11.2001		24.0127-0100.1	427100	DISCO DE FRENO	51712-H1000	

JEEP

CHEROKEE (KJ) (01-)	2,4		09.2001		13.0460-2899.2	602899	PASTILLAS DE FRENO	5066 427AA	ver figura
	2,5 CRD		09.2001		13.0460-2899.2	602899	PASTILLAS DE FRENO	5066 427AA	ver figura
	2,8 CRD		11.2002		13.0460-2899.2	602899	PASTILLAS DE FRENO	5066 427AA	ver figura
	3,7 V6		09.2001		13.0460-2899.2	602899	PASTILLAS DE FRENO	5066 427AA	ver figura









					Denominación	Ref. OE correspondientes a las referencias ATE	 Referencia anterior / varios
---	---	---	---	---	--------------	--	--

MAZDA

3 (03-)	1,4 i 16V	DI	10.2003		11.9571-9785.2	220595	PINZA DE GARRA	BPYK-33-71XA	
		DD	10.2003		11.9571-9786.2	220596	PINZA DE GARRA	BPYK-33-61XA	
	1,6 CITD	DD	06.2004		11.9571-9786.2	220596	PINZA DE GARRA	BPYK-33-61XA	
		DI	06.2004		11.9571-9785.2	220595	PINZA DE GARRA	BPYK-33-71XA	
	1,6 i 16V	DD	10.2003		11.9571-9786.2	220596	PINZA DE GARRA	BPYK-33-61XA	
		DI	10.2003		11.9571-9785.2	220595	PINZA DE GARRA	BPYK-33-71XA	
	2,0 i 16V	DI	10.2003		11.9571-9785.2	220595	PINZA DE GARRA	BPYK-33-71XA	
		DD	10.2003		11.9571-9786.2	220596	PINZA DE GARRA	BPYK-33-61XA	
	2,3 i 16V	DD	10.2003		11.9571-9786.2	220596	PINZA DE GARRA	BPYK-33-61XA	
		DI	10.2003		11.9571-9785.2	220595	PINZA DE GARRA	BPYK-33-71XA	
5 (05-)	1,8 i 16V	DD	03.2005		11.9571-9786.2	220596	PINZA DE GARRA	BPYK-33-61XA	
		DI	03.2005		11.9571-9785.2	220595	PINZA DE GARRA	BPYK-33-71XA	
	2,0 CITD	DD	03.2005		11.9571-9786.2	220596	PINZA DE GARRA	BPYK-33-61XA	
		DI	03.2005		11.9571-9785.2	220595	PINZA DE GARRA	BPYK-33-71XA	
		DD	06.2005		11.9571-9786.2	220596	PINZA DE GARRA	BPYK-33-61XA	
		DI	06.2005		11.9571-9785.2	220595	PINZA DE GARRA	BPYK-33-71XA	
	2,0 i 16V	DD	03.2005		11.9571-9786.2	220596	PINZA DE GARRA	BPYK-33-61XA	
		DI	03.2005		11.9571-9785.2	220595	PINZA DE GARRA	BPYK-33-71XA	
PREMACY (05-)	1,8 i 16V	DD	03.2005		11.9571-9786.2	220596	PINZA DE GARRA	BPYK-33-61XA	



					Denominación	Ref. OE correspondientes a las referencias ATE	 Referencia anterior / varios
---	---	---	---	---	---------------------	---	---

MAZDA

PREMACY (05-)	1,8 i 16V	DI	03.2005		11.9571-9785.2	220595	PINZA DE GARRA	BPYK-33-71XA	
	2,0 CITD	DD	03.2005		11.9571-9786.2	220596	PINZA DE GARRA	BPYK-33-61XA	
		DD	06.2005		11.9571-9786.2	220596	PINZA DE GARRA	BPYK-33-61XA	
		DI	06.2005		11.9571-9785.2	220595	PINZA DE GARRA	BPYK-33-71XA	
		DI	03.2005		11.9571-9785.2	220595	PINZA DE GARRA	BPYK-33-71XA	
	2,0 i 16V	DD	03.2005		11.9571-9786.2	220596	PINZA DE GARRA	BPYK-33-61XA	
		DI	03.2005		11.9571-9785.2	220595	PINZA DE GARRA	BPYK-33-71XA	









					Denominación	Ref. OE correspondientes a las referencias ATE		Referencia anterior / varios
--	--	--	--	--	--------------	--	--	------------------------------

MERCEDES BENZ

MERCEDES-BENZ Clase A (W169) (04-)	A 150		08.2004		24.0108-0113.1	408113	DISCO DE FRENO	169 423 03 12	
			08.2004		24.0112-0167.1	412167	DISCO DE FRENO	169 421 00 12	
	A 160 CDI		08.2004		24.0108-0113.1	408113	DISCO DE FRENO	169 423 03 12	
			08.2004		24.0112-0167.1	412167	DISCO DE FRENO	169 421 00 12	
	A 170		08.2004		24.0108-0113.1	408113	DISCO DE FRENO	169 423 03 12	
	A 180 CDI		08.2004		24.0108-0113.1	408113	DISCO DE FRENO	169 423 03 12	
	A 200		08.2004		24.0108-0113.1	408113	DISCO DE FRENO	169 423 03 12	
	A 200 CDI		08.2004		24.0108-0113.1	408113	DISCO DE FRENO	169 423 03 12	
	A 200 Turbo		03.2005		24.0108-0113.1	408113	DISCO DE FRENO	169 423 03 12	
MERCEDES-BENZ Clase B (W245) (05-)	B 150		04.2005		24.0108-0113.1	408113	DISCO DE FRENO	169 423 03 12	
	B 170		04.2005		24.0108-0113.1	408113	DISCO DE FRENO	169 423 03 12	
	B 180 CDI		04.2005		24.0108-0113.1	408113	DISCO DE FRENO	169 423 03 12	
	B 200		04.2005		24.0108-0113.1	408113	DISCO DE FRENO	169 423 03 12	
	B 200 CDI		04.2005		24.0108-0113.1	408113	DISCO DE FRENO	169 423 03 12	
	B 200 Turbo		04.2005		24.0108-0113.1	408113	DISCO DE FRENO	169 423 03 12	
MERCEDES-BENZ Clase M (W164) (05-)	ML 280 CDI		07.2005		24.0132-0158.1	432158	DISCO DE FRENO	164 421 04 12	
	ML 320 CDI		07.2005		24.0132-0158.1	432158	DISCO DE FRENO	164 421 04 12	
	ML 350		07.2005		24.0132-0158.1	432158	DISCO DE FRENO	164 421 04 12	
MERCEDES-BENZ Clase R (R251) (06-)	R 280		01.2007		24.0132-0158.1	432158	DISCO DE FRENO	164 421 04 12	



					Denominación	Ref. OE correspondientes a las referencias ATE	 Referencia anterior / varios
---	---	---	---	---	---------------------	---	---

MERCEDES BENZ

MERCEDÉS-BENZ Clase R (R251) (06-)	R 280 CDI		11.2005		24.0132-0158.1	432158	DISCO DE FRENO	164 421 04 12	
	R 300		01.2007		24.0132-0158.1	432158	DISCO DE FRENO	164 421 04 12	
	R 320 CDI		11.2005		24.0132-0158.1	432158	DISCO DE FRENO	164 421 04 12	
	R 350		11.2005		24.0132-0158.1	432158	DISCO DE FRENO	164 421 04 12	



					Denominación	Ref. OE correspondientes a las referencias ATE		Referencia anterior / varios
--	--	--	--	--	--------------	--	--	------------------------------

NISSAN

INTERSTAR (X70) (02-)	1,9 CDi		11.2003		24.5111-0510.3	330819	LATIGUILLO	44 15 698 , 93182621 , 82 00 196 055 , 46201-00QAH	
		TI	11.2003		24.5258-0450.3	330824	LATIGUILLO	44 15 858 , 93183554 , 44230-00QAD , 77 01 059 963	
			07.2002		24.3727-0762.2	580762	CABLE FRENO DE MANO	77 00 311 216 , 36402-00QAA , 45 00 250 , 44 03 487 , 9111487 , 9160550	
	2,2 CDi		11.2003		24.5111-0510.3	330819	LATIGUILLO	44 15 698 , 93182621 , 82 00 196 055 , 46201-00QAH	
		TI	11.2003		24.5258-0450.3	330824	LATIGUILLO	44 15 858 , 93183554 , 44230-00QAD , 77 01 059 963	
			07.2002		24.3727-0762.2	580762	CABLE FRENO DE MANO	77 00 311 216 , 36402-00QAA , 45 00 250 , 44 03 487 , 9111487 , 9160550	
	2,5 CDi		11.2003		24.5111-0510.3	330819	LATIGUILLO	44 15 698 , 93182621 , 82 00 196 055 , 46201-00QAH	
		TI	11.2003		24.5258-0450.3	330824	LATIGUILLO	44 15 858 , 93183554 , 44230-00QAD , 77 01 059 963	
			07.2002		24.3727-0762.2	580762	CABLE FRENO DE MANO	77 00 311 216 , 36402-00QAA , 45 00 250 , 44 03 487 , 9111487 , 9160550	
	3,0 CDi	TI	11.2003		24.5258-0450.3	330824	LATIGUILLO	44 15 858 , 93183554 , 44230-00QAD , 77 01 059 963	
			11.2003		24.5111-0510.3	330819	LATIGUILLO	44 15 698 , 93182621 , 82 00 196 055 , 46201-00QAH	
			11.2003		24.3727-0762.2	580762	CABLE FRENO DE MANO	77 00 311 216 , 36402-00QAA , 45 00 250 , 44 03 487 , 9111487 , 9160550	



					Denominación	Ref. OE correspondientes a las referencias ATE		Referencia anterior / varios
--	--	--	--	--	--------------	--	--	------------------------------

NISSAN

Modelo	Motor	Transmisión	Fecha	Ref. ATE	Ref. OE	Denominación	Ref. OE correspondientes a las referencias ATE	Referencia anterior / varios
MICRA (K12E) (03-)	1,0 i 16V	TD	01.2003	24.3727-1719.2	581719	CABLE FRENO DE MANO	36530-AX600 , 36530-AX601	
		TI	01.2003	24.3727-1718.2	581718	CABLE FRENO DE MANO	36531-AX600 , 36531-AX601	
	1,2 i 16V	TI	01.2003	24.3727-1718.2	581718	CABLE FRENO DE MANO	36531-AX600 , 36531-AX601	
		TD	01.2003	24.3727-1719.2	581719	CABLE FRENO DE MANO	36530-AX600 , 36530-AX601	
	1,4 i 16V	TD	01.2003	24.3727-1719.2	581719	CABLE FRENO DE MANO	36530-AX600 , 36530-AX601	
		TI	01.2003	24.3727-1718.2	581718	CABLE FRENO DE MANO	36531-AX600 , 36531-AX601	
	1,5 dCi	TI	01.2003	24.3727-1718.2	581718	CABLE FRENO DE MANO	36531-AX600 , 36531-AX601	
		TI	09.2003	24.3727-1718.2	581718	CABLE FRENO DE MANO	36531-AX600 , 36531-AX601	
		TD	09.2003	24.3727-1719.2	581719	CABLE FRENO DE MANO	36530-AX600 , 36530-AX601	
		TD	01.2003	24.3727-1719.2	581719	CABLE FRENO DE MANO	36530-AX600 , 36530-AX601	
	1,6 i 16V	TI	05.2005	24.3727-1718.2	581718	CABLE FRENO DE MANO	36531-AX600 , 36531-AX601	
		TD	05.2005	24.3727-1719.2	581719	CABLE FRENO DE MANO	36530-AX600 , 36530-AX601	
MICRA C+C (CK12E) (05-)	1,4 i 16V	TI	08.2005	24.3727-1718.2	581718	CABLE FRENO DE MANO	36531-AX600 , 36531-AX601	
		TD	08.2005	24.3727-1719.2	581719	CABLE FRENO DE MANO	36530-AX600 , 36530-AX601	
	1,6 i 16V	TI	08.2005	24.3727-1718.2	581718	CABLE FRENO DE MANO	36531-AX600 , 36531-AX601	
		TD	08.2005	24.3727-1719.2	581719	CABLE FRENO DE MANO	36530-AX600 , 36530-AX601	
PRIMASTAR (X83) Bus (01-)	1,9 dCi (100)		03.2001	24.3727-0763.2	580763	CABLE FRENO DE MANO	36518-00QAA , 77 00 313 058 , 44 08 735 , 91165521	
	1,9 dCi (80)		03.2001	24.3727-0763.2	580763	CABLE FRENO DE MANO	36518-00QAA , 77 00 313 058 , 44 08 735 , 91165521	



					Denominación	Ref. OE correspondientes a las referencias ATE		Referencia anterior / varios
--	--	--	--	--	--------------	--	--	------------------------------

NISSAN

PRIMASTAR (X83) Bus (01-)	2,0 i 16V		03.2001		24.3727-0763.2	580763	CABLE FRENO DE MANO	36518-00QAA , 77 00 313 058 , 44 08 735 , 91165521	
	2,5 dCi (140)		09.2003		24.3727-0763.2	580763	CABLE FRENO DE MANO	36518-00QAA , 77 00 313 058 , 44 08 735 , 91165521	
PRIMASTAR (X83) Van (02-)	1,9 dCi (100)		07.2002		24.3727-0763.2	580763	CABLE FRENO DE MANO	36518-00QAA , 77 00 313 058 , 44 08 735 , 91165521	
	1,9 dCi (80)		07.2002		24.3727-0763.2	580763	CABLE FRENO DE MANO	36518-00QAA , 77 00 313 058 , 44 08 735 , 91165521	
	2,0 i 16V		07.2002		24.3727-0763.2	580763	CABLE FRENO DE MANO	36518-00QAA , 77 00 313 058 , 44 08 735 , 91165521	
	2,5 dCi (140)		09.2003		24.3727-0763.2	580763	CABLE FRENO DE MANO	36518-00QAA , 77 00 313 058 , 44 08 735 , 91165521	
PRIMERA (P10E) Berlina (90-96)	1,6	TD	09.1994	01.1996	24.3220-1730.3	020492	CILINDRO DE RUEDA	44100-3F000	
		TI	09.1994	01.1996	24.3220-1729.3	020491	CILINDRO DE RUEDA	44101-3F000	
	1,6 i	TD	09.1994	01.1996	24.3220-1730.3	020492	CILINDRO DE RUEDA	44100-3F000	
		TI	09.1994	01.1996	24.3220-1729.3	020491	CILINDRO DE RUEDA	44101-3F000	
PRIMERA (W11) Break (98-02)	1,6 i 16V		04.1998	03.2001	24.0110-0310.1	410310	DISCO DE FRENO	43206-99J04	
	1,8 i 16V		08.1999	03.2001	24.0110-0310.1	410310	DISCO DE FRENO	43206-99J04	
	2,0 i 16V		04.1998	03.2001	24.0110-0310.1	410310	DISCO DE FRENO	43206-99J04	
			08.1999	03.2001	24.0110-0310.1	410310	DISCO DE FRENO	43206-99J04	
	2,0 TD		04.1998	03.2001	24.0110-0310.1	410310	DISCO DE FRENO	43206-99J04	



					Denominación	Ref. OE correspondientes a las referencias ATE		Referencia anterior / varios
--	--	--	--	--	--------------	--	--	------------------------------

OPEL

AGILA (00-)	1	DI	08.2003		24.3481-1757.5	240325	PINZA DE GARRA	9195321 , 55102-83E00 , 47 01 929	
		DD	08.2003		24.3481-1758.5	240326	PINZA DE GARRA	9195322 , 55101-83E00 , 47 01 930	
	1,0 12V	DI	09.2000		24.3481-1757.5	240325	PINZA DE GARRA	9195321 , 55102-83E00 , 47 01 929	
		DD	09.2000		24.3481-1758.5	240326	PINZA DE GARRA	9195322 , 55101-83E00 , 47 01 930	
	1,2 16V	DD	09.2000		24.3481-1758.5	240326	PINZA DE GARRA	9195322 , 55101-83E00 , 47 01 930	
		DI	09.2000		24.3481-1757.5	240325	PINZA DE GARRA	9195321 , 55102-83E00 , 47 01 929	
	1,3 CDTI	DI	08.2003		24.3481-1757.5	240325	PINZA DE GARRA	9195321 , 55102-83E00 , 47 01 929	
		DD	08.2003		24.3481-1758.5	240326	PINZA DE GARRA	9195322 , 55101-83E00 , 47 01 930	
COMBO / Vauxhall Combo (01-)					24.2122-1758.3	010770	CIL. MAESTRO TANDEM	93177770 , 5 58 137	
					24.2122-1757.3	010769	CIL. MAESTRO TANDEM	93177769 , 5 58 133	
	1,4 16V				24.2122-1757.3	010769	CIL. MAESTRO TANDEM	93177769 , 5 58 133	
					24.2122-1758.3	010770	CIL. MAESTRO TANDEM	93177770 , 5 58 137	
	1,6				24.2122-1757.3	010769	CIL. MAESTRO TANDEM	93177769 , 5 58 133	
					24.2122-1758.3	010770	CIL. MAESTRO TANDEM	93177770 , 5 58 137	
	1,7 CDTI		06.2003		24.2122-1757.3	010769	CIL. MAESTRO TANDEM	93177769 , 5 58 133	
			06.2003		24.2122-1758.3	010770	CIL. MAESTRO TANDEM	93177770 , 5 58 137	

Nuevas referencias en almacén - Por aplicación

04/2007



					Denominación	Ref. OE correspondientes a las referencias ATE		Referencia anterior / varios
--	--	--	--	--	--------------	--	--	------------------------------

OPEL

COMBO / Vauxhall Combo (01-)	1,7 DI 16V				24.2122-1758.3	010770	CIL. MAESTRO TANDEM	93177770 , 5 58 137	
					24.2122-1757.3	010769	CIL. MAESTRO TANDEM	93177769 , 5 58 133	
	1,7 DTI 16V				24.2122-1758.3	010770	CIL. MAESTRO TANDEM	93177770 , 5 58 137	
					24.2122-1757.3	010769	CIL. MAESTRO TANDEM	93177769 , 5 58 133	
CORSA C / Vauxhall Corsa MK II (00-06)	1,0 12V			09.2006	24.2122-1758.3	010770	CIL. MAESTRO TANDEM	93177770 , 5 58 137	
				09.2006	24.2122-1757.3	010769	CIL. MAESTRO TANDEM	93177769 , 5 58 133	
	1,2 16V			09.2006	24.2122-1758.3	010770	CIL. MAESTRO TANDEM	93177770 , 5 58 137	
				09.2006	24.2122-1757.3	010769	CIL. MAESTRO TANDEM	93177769 , 5 58 133	
	1,3 CDTI			09.2006	24.2122-1758.3	010770	CIL. MAESTRO TANDEM	93177770 , 5 58 137	
				09.2006	24.2122-1757.3	010769	CIL. MAESTRO TANDEM	93177769 , 5 58 133	
	1,6			09.2006	24.2122-1757.3	010769	CIL. MAESTRO TANDEM	93177769 , 5 58 133	
				09.2006	24.2122-1758.3	010770	CIL. MAESTRO TANDEM	93177770 , 5 58 137	
	1,7 CDTI			09.2006	24.2122-1757.3	010769	CIL. MAESTRO TANDEM	93177769 , 5 58 133	
				09.2006	24.2122-1758.3	010770	CIL. MAESTRO TANDEM	93177770 , 5 58 137	
	1,7 DI 16V			09.2006	24.2122-1757.3	010769	CIL. MAESTRO TANDEM	93177769 , 5 58 133	
				09.2006	24.2122-1758.3	010770	CIL. MAESTRO TANDEM	93177770 , 5 58 137	
	1,7 DTI 16V			09.2006	24.2122-1758.3	010770	CIL. MAESTRO TANDEM	93177770 , 5 58 137	
				09.2006	24.2122-1757.3	010769	CIL. MAESTRO TANDEM	93177769 , 5 58 133	
MOVANO (98-)	1,9 DTI		09.2003		24.5111-0510.3	330819	LATIGUILLO	44 15 698 , 93182621 , 82 00 196 055 , 46201-00QAH	



					Denominación	Ref. OE correspondientes a las referencias ATE		Referencia anterior / varios
--	--	--	--	--	--------------	--	--	------------------------------

OPEL

MOVANO (98-)	1,9 DTI		09.2000		24.3727-0762.2	580762	CABLE FRENO DE MANO	77 00 311 216 , 36402-00QAA , 45 00 250 , 44 03 487 , 9111487 , 9160550	
	2,2 DTI 16V		09.2003		24.5111-0510.3	330819	LATIGUILLO	44 15 698 , 93182621 , 82 00 196 055 , 46201-00QAH	
		TI	09.2003		24.5258-0450.3	330824	LATIGUILLO	44 15 858 , 93183554 , 44230-00QAD , 77 01 059 963	
			09.2000		24.3727-0762.2	580762	CABLE FRENO DE MANO	77 00 311 216 , 36402-00QAA , 45 00 250 , 44 03 487 , 9111487 , 9160550	
	2,5 D		07.1998	09.2000	24.3727-0762.2	580762	CABLE FRENO DE MANO	77 00 311 216 , 36402-00QAA , 45 00 250 , 44 03 487 , 9111487 , 9160550	
	2,5 DTI	TI	10.2003		24.5258-0450.3	330824	LATIGUILLO	44 15 858 , 93183554 , 44230-00QAD , 77 01 059 963	
			10.2003		24.5111-0510.3	330819	LATIGUILLO	44 15 698 , 93182621 , 82 00 196 055 , 46201-00QAH	
			09.2003		24.5111-0510.3	330819	LATIGUILLO	44 15 698 , 93182621 , 82 00 196 055 , 46201-00QAH	
			10.2003		24.3727-0762.2	580762	CABLE FRENO DE MANO	77 00 311 216 , 36402-00QAA , 45 00 250 , 44 03 487 , 9111487 , 9160550	
			10.2001		24.3727-0762.2	580762	CABLE FRENO DE MANO	77 00 311 216 , 36402-00QAA , 45 00 250 , 44 03 487 , 9111487 , 9160550	
	2,8 DTI		07.1998	10.2001	24.3727-0762.2	580762	CABLE FRENO DE MANO	77 00 311 216 , 36402-00QAA , 45 00 250 , 44 03 487 , 9111487 , 9160550	



					Denominación	Ref. OE correspondientes a las referencias ATE		Referencia anterior / varios
--	--	--	--	--	--------------	--	--	------------------------------

OPEL

Modelo	Motor	TI	Fecha	Ref. ATE	Ref. OE	Denominación	Ref. OE correspondientes a las referencias ATE	Referencia anterior / varios
MOVANO (98-)	3,0 DTI		10.2003	24.5111-0510.3	330819	LATIGUILLO	44 15 698 , 93182621 , 82 00 196 055 , 46201-00QAH	
		TI	10.2003	24.5258-0450.3	330824	LATIGUILLO	44 15 858 , 93183554 , 44230-00QAD , 77 01 059 963	
			10.2003	24.3727-0762.2	580762	CABLE FRENO DE MANO	77 00 311 216 , 36402-00QAA , 45 00 250 , 44 03 487 , 9111487 , 9160550	
VIVARO (01-)	1,9 DI		08.2001	24.3727-0764.2	580764	CABLE FRENO DE MANO	82 00 008 473 , 44 08 730 , 91165522	
			08.2001	24.3727-0763.2	580763	CABLE FRENO DE MANO	36518-00QAA , 77 00 313 058 , 44 08 735 , 91165521	
	1,9 DTI		08.2001	24.3727-0763.2	580763	CABLE FRENO DE MANO	36518-00QAA , 77 00 313 058 , 44 08 735 , 91165521	
			08.2001	24.3727-0764.2	580764	CABLE FRENO DE MANO	82 00 008 473 , 44 08 730 , 91165522	
	2,0 16V		08.2001	24.3727-0764.2	580764	CABLE FRENO DE MANO	82 00 008 473 , 44 08 730 , 91165522	
			08.2001	24.3727-0763.2	580763	CABLE FRENO DE MANO	36518-00QAA , 77 00 313 058 , 44 08 735 , 91165521	
	2,5 DTI		05.2003	24.3727-0764.2	580764	CABLE FRENO DE MANO	82 00 008 473 , 44 08 730 , 91165522	
			05.2003	24.3727-0763.2	580763	CABLE FRENO DE MANO	36518-00QAA , 77 00 313 058 , 44 08 735 , 91165521	



					Denominación	Ref. OE correspondientes a las referencias ATE		Referencia anterior / varios
--	--	--	--	--	--------------	--	--	------------------------------

PEUGEOT

Modelo	Motor	TD	TI	Fecha	Ref. ATE	Ref. OE	Denominación	Ref. OE correspondientes a las referencias ATE	Referencia anterior / varios
206 CC (00-)	CC 110			09.2000	24.3728-0845.2	590845	CABLE DE EMBRAGUE	2150 X3	24.3728-0829.2
206 Berlina (98-)	1,1			09.1998	24.3728-0845.2	590845	CABLE DE EMBRAGUE	2150 X3	24.3728-0829.2
	1,4			09.1998	24.3728-0845.2	590845	CABLE DE EMBRAGUE	2150 X3	24.3728-0829.2
	1,6			09.1998	12.2000	24.3728-0845.2	CABLE DE EMBRAGUE	2150 X3	24.3728-0829.2
	1,6 16V			12.2000	24.3728-0845.2	590845	CABLE DE EMBRAGUE	2150 X3	24.3728-0829.2
206 SW (02-)	1,1			07.2002	24.3728-0845.2	590845	CABLE DE EMBRAGUE	2150 X3	24.3728-0829.2
	1,4			07.2002	24.3728-0845.2	590845	CABLE DE EMBRAGUE	2150 X3	24.3728-0829.2
	1,6 16V			07.2002	24.3728-0845.2	590845	CABLE DE EMBRAGUE	2150 X3	24.3728-0829.2
607 (00-)	2,0 16V				24.5257-0480.3	330823	LATIGUILLO	4806 F5	
		TD		02.2000	24.3727-0841.2	580841	CABLE FRENO DE MANO	4745 X7	
		TI		02.2000	24.3727-0840.2	580840	CABLE FRENO DE MANO	4745 X6	
	2,0 HDi			09.2005	24.5257-0480.3	330823	LATIGUILLO	4806 F5	
					24.5257-0480.3	330823	LATIGUILLO	4806 F5	
		TD		09.2005	24.3727-0841.2	580841	CABLE FRENO DE MANO	4745 X7	
		TI		02.2000	24.3727-0840.2	580840	CABLE FRENO DE MANO	4745 X6	
		TI		09.2005	24.3727-0840.2	580840	CABLE FRENO DE MANO	4745 X6	
		TD		02.2000	24.3727-0841.2	580841	CABLE FRENO DE MANO	4745 X7	
	2,2 16V				24.5257-0480.3	330823	LATIGUILLO	4806 F5	
				09.2005	24.5257-0480.3	330823	LATIGUILLO	4806 F5	

Nuevas referencias en almacén - Por aplicación

04/2007



				Denominación	Ref. OE correspondientes a las referencias ATE		Referencia anterior / varios
--	--	--	--	--------------	--	--	------------------------------

PEUGEOT

Modelo	Motor	Transmisión	Fecha	Ref. ATE	Ref. OE	Denominación	Ref. OE correspondientes a las referencias ATE	Referencia anterior / varios
607 (00-)	2,2 16V	TD	09.2005	24.3727-0841.2	580841	CABLE FRENO DE MANO	4745 X7	
		TD	02.2000	24.3727-0841.2	580841	CABLE FRENO DE MANO	4745 X7	
		TI	09.2005	24.3727-0840.2	580840	CABLE FRENO DE MANO	4745 X6	
		TI	02.2000	24.3727-0840.2	580840	CABLE FRENO DE MANO	4745 X6	
	2,2 HDi			24.5257-0480.3	330823	LATIGUILLO	4806 F5	
		TI	02.2000	24.3727-0840.2	580840	CABLE FRENO DE MANO	4745 X6	
		TD	02.2000	24.3727-0841.2	580841	CABLE FRENO DE MANO	4745 X7	
	2,2 HDi 170		05.2006	24.5257-0480.3	330823	LATIGUILLO	4806 F5	
		TD	05.2006	24.3727-0841.2	580841	CABLE FRENO DE MANO	4745 X7	
		TI	05.2006	24.3727-0840.2	580840	CABLE FRENO DE MANO	4745 X6	
	2,7 HDi		12.2004	24.5257-0480.3	330823	LATIGUILLO	4806 F5	
		TI	12.2004	24.3727-0840.2	580840	CABLE FRENO DE MANO	4745 X6	
		TD	12.2004	24.3727-0841.2	580841	CABLE FRENO DE MANO	4745 X7	
	3,0 24V		03.2004	24.5257-0480.3	330823	LATIGUILLO	4806 F5	
		TD	03.2004	24.3727-0841.2	580841	CABLE FRENO DE MANO	4745 X7	
		TI	03.2004	24.3727-0840.2	580840	CABLE FRENO DE MANO	4745 X6	
	3,0 V6			24.5257-0480.3	330823	LATIGUILLO	4806 F5	
		TD	02.2000	24.3727-0841.2	580841	CABLE FRENO DE MANO	4745 X7	
		TI	02.2000	24.3727-0840.2	580840	CABLE FRENO DE MANO	4745 X6	



					Denominación	Ref. OE correspondientes a las referencias ATE		Referencia anterior / varios
--	--	--	--	--	--------------	--	--	------------------------------

PEUGEOT

Modelo	Motor	Fecha	Referencia ATE	Referencia OE	Denominación	Referencia OE correspondientes a las referencias ATE	Referencia anterior / varios
BOXER (02-06)	2,0 HDi (10/14/18)			03.0137-4002.2	654002	JUEGO DE ZAPATAS	77362699 , 77363478 , 4241 NO , 77362696 , 77363479 , 4241 L9
		04.2002		03.0137-4002.2	654002	JUEGO DE ZAPATAS	77362699 , 77363478 , 4241 NO , 77362696 , 77363479 , 4241 L9
		04.2002		24.3727-0348.2	580348	CABLE FRENO DE MANO	4745 V4
	2,0 i (10/14/18)			03.0137-4002.2	654002	JUEGO DE ZAPATAS	77362699 , 77363478 , 4241 NO , 77362696 , 77363479 , 4241 L9
		04.2002		03.0137-4002.2	654002	JUEGO DE ZAPATAS	77362699 , 77363478 , 4241 NO , 77362696 , 77363479 , 4241 L9
		04.2002		24.3727-0348.2	580348	CABLE FRENO DE MANO	4745 V4
	2,2 HDi (10/14/18)	04.2002		03.0137-4002.2	654002	JUEGO DE ZAPATAS	77362699 , 77363478 , 4241 NO , 77362696 , 77363479 , 4241 L9
				03.0137-4002.2	654002	JUEGO DE ZAPATAS	77362699 , 77363478 , 4241 NO , 77362696 , 77363479 , 4241 L9
		04.2002		24.3727-0348.2	580348	CABLE FRENO DE MANO	4745 V4
	2,8 HDi (10/14/18)			03.0137-4002.2	654002	JUEGO DE ZAPATAS	77362699 , 77363478 , 4241 NO , 77362696 , 77363479 , 4241 L9
		04.2002		03.0137-4002.2	654002	JUEGO DE ZAPATAS	77362699 , 77363478 , 4241 NO , 77362696 , 77363479 , 4241 L9
		04.2002		24.3727-0348.2	580348	CABLE FRENO DE MANO	4745 V4

Nuevas referencias en almacén - Por aplicación

04/2007



					Denominación	Ref. OE correspondientes a las referencias ATE		Referencia anterior / varios
--	--	--	--	--	--------------	--	--	------------------------------

PEUGEOT

BOXER (02-06)	2,8 HDi 4x4(10/14/18)		04.2002		24.3727-0348.2	580348	CABLE FRENO DE MANO	4745 V4	
BOXER Autobús (94-02)	1,9 TD 4x4 (10/14)		07.1996	03.2002	24.3727-0842.2	580842	CABLE FRENO DE MANO	4745 J2	
	2,0 i 4x4 (10/14/18)		07.1996	03.2002	24.3727-0842.2	580842	CABLE FRENO DE MANO	4745 J2	
	2,5 D 4x4 (14/18)		07.1996	03.2002	24.3727-0842.2	580842	CABLE FRENO DE MANO	4745 J2	
	2,5 TD 4x4 (14/18)		07.1996	03.2002	24.3727-0842.2	580842	CABLE FRENO DE MANO	4745 J2	
	2,5 TDi 4x4 (14/18)		01.1997	03.2002	24.3727-0842.2	580842	CABLE FRENO DE MANO	4745 J2	
BOXER Furgón (94-02)	1,9 D (10)			03.2002	24.3727-0348.2	580348	CABLE FRENO DE MANO	4745 V4	
	1,9 TD (10/14)			03.2002	24.3727-0348.2	580348	CABLE FRENO DE MANO	4745 V4	
	2,0 HDi (10/14/18)		08.2001	03.2002	24.3727-0348.2	580348	CABLE FRENO DE MANO	4745 V4	
	2,0 i (10/14/18)			03.2002	24.3727-0348.2	580348	CABLE FRENO DE MANO	4745 V4	
	2,5 D (14/18)			03.2002	24.3727-0348.2	580348	CABLE FRENO DE MANO	4745 V4	
	2,5 D 4x4 (14/18)		07.1999	03.2002	24.3727-0842.2	580842	CABLE FRENO DE MANO	4745 J2	
	2,5 TD (14/18)			03.2002	24.3727-0348.2	580348	CABLE FRENO DE MANO	4745 V4	
	2,5 TDi (14/18)			03.2002	24.3727-0348.2	580348	CABLE FRENO DE MANO	4745 V4	
	2,5 TDi 4x4 (14/18)		07.1999	03.2002	24.3727-0842.2	580842	CABLE FRENO DE MANO	4745 J2	
	2,8 HDi (14/18)			03.2002	24.3727-0348.2	580348	CABLE FRENO DE MANO	4745 V4	
BOXER Camión con plataforma/Chasis (94-02)	1,9 TD (10/14)			03.2002	24.3727-0348.2	580348	CABLE FRENO DE MANO	4745 V4	
	2,0 i (10/14/18)			03.2002	24.3727-0348.2	580348	CABLE FRENO DE MANO	4745 V4	
	2,5 D (14/18)			03.2002	24.3727-0348.2	580348	CABLE FRENO DE MANO	4745 V4	









					Denominación	Ref. OE correspondientes a las referencias ATE		Referencia anterior / varios
--	--	--	--	--	--------------	--	--	------------------------------

PEUGEOT

BOXER Camión con plataforma/Chasis (94-02)	2,5 D 4x4 (14/18)		07.1999	03.2002	24.3727-0842.2	580842	CABLE FRENO DE MANO	4745 J2	
	2,5 TD (14/18)			03.2002	24.3727-0348.2	580348	CABLE FRENO DE MANO	4745 V4	
	2,5 TDi (14/18)			03.2002	24.3727-0348.2	580348	CABLE FRENO DE MANO	4745 V4	
	2,5 TDi 4x4 (14/18)		07.1999	03.2002	24.3727-0842.2	580842	CABLE FRENO DE MANO	4745 J2	
	2,8 HDi (14/18)			03.2002	24.3727-0348.2	580348	CABLE FRENO DE MANO	4745 V4	
PARTNER Break (96-)	1,6 16V	TD	07.2001		24.3727-0347.2	580347	CABLE FRENO DE MANO	4745 Y1 , 4745 X3	
		TI	07.2001		24.3727-0349.2	580349	CABLE FRENO DE MANO	4745 Y0 , 4745 X2	
	1,6 HDi 75	TD	02.2006		24.3727-0347.2	580347	CABLE FRENO DE MANO	4745 Y1 , 4745 X3	
		TI	02.2006		24.3727-0349.2	580349	CABLE FRENO DE MANO	4745 Y0 , 4745 X2	
	1,6 HDi 90	TD	02.2006		24.3727-0347.2	580347	CABLE FRENO DE MANO	4745 Y1 , 4745 X3	
		TI	02.2006		24.3727-0349.2	580349	CABLE FRENO DE MANO	4745 Y0 , 4745 X2	
	2,0 HDi 90	TD	02.2000		24.3727-0347.2	580347	CABLE FRENO DE MANO	4745 Y1 , 4745 X3	
		TI	02.2000		24.3727-0349.2	580349	CABLE FRENO DE MANO	4745 Y0 , 4745 X2	









					Denominación	Ref. OE correspondientes a las referencias ATE	 Referencia anterior / varios
---	---	---	---	---	--------------	--	--

RENAULT

MASTER II Bus (JD/ND_) (98-)	1,9 dCi 80	TI	12.2003		24.5258-0450.3	330824	LATIGUILLO	44 15 858 , 93183554 , 44230-00QAD , 77 01 059 963	
			11.2003		24.5111-0510.3	330819	LATIGUILLO	44 15 698 , 93182621 , 82 00 196 055 , 46201-00QAH	
			11.2001		24.3727-0762.2	580762	CABLE FRENO DE MANO	77 00 311 216 , 36402-00QAA , 45 00 250 , 44 03 487 , 9111487 , 9160550	
	1,9 dTi		11.2003		24.5111-0510.3	330819	LATIGUILLO	44 15 698 , 93182621 , 82 00 196 055 , 46201-00QAH	
		TI	12.2003		24.5258-0450.3	330824	LATIGUILLO	44 15 858 , 93183554 , 44230-00QAD , 77 01 059 963	
			09.2000		24.3727-0762.2	580762	CABLE FRENO DE MANO	77 00 311 216 , 36402-00QAA , 45 00 250 , 44 03 487 , 9111487 , 9160550	
	2,2 dCi 90	TI	12.2003		24.5258-0450.3	330824	LATIGUILLO	44 15 858 , 93183554 , 44230-00QAD , 77 01 059 963	
			11.2003		24.5111-0510.3	330819	LATIGUILLO	44 15 698 , 93182621 , 82 00 196 055 , 46201-00QAH	
			09.2000		24.3727-0762.2	580762	CABLE FRENO DE MANO	77 00 311 216 , 36402-00QAA , 45 00 250 , 44 03 487 , 9111487 , 9160550	
	2,5 D		07.1998	01.2001	24.3727-0762.2	580762	CABLE FRENO DE MANO	77 00 311 216 , 36402-00QAA , 45 00 250 , 44 03 487 , 9111487 , 9160550	
	2,5 dCi 100		10.2003		24.5111-0510.3	330819	LATIGUILLO	44 15 698 , 93182621 , 82 00 196 055 , 46201-00QAH	
		TI	12.2003		24.5258-0450.3	330824	LATIGUILLO	44 15 858 , 93183554 , 44230-00QAD , 77 01 059 963	









					Denominación	Ref. OE correspondientes a las referencias ATE	 Referencia anterior / varios
---	---	---	---	---	--------------	--	---

RENAULT

MASTER II Bus (JD/ND_) (98-)	2,5 dCi 100		10.2003		24.3727-0762.2	580762	CABLE FRENO DE MANO	77 00 311 216 , 36402-00QAA , 45 00 250 , 44 03 487 , 9111487 , 9160550	
	2,5 dCi 120	TI	12.2003		24.5258-0450.3	330824	LATIGUILLO	44 15 858 , 93183554 , 44230-00QAD , 77 01 059 963	
			11.2003		24.5111-0510.3	330819	LATIGUILLO	44 15 698 , 93182621 , 82 00 196 055 , 46201-00QAH	
			10.2001		24.3727-0762.2	580762	CABLE FRENO DE MANO	77 00 311 216 , 36402-00QAA , 45 00 250 , 44 03 487 , 9111487 , 9160550	
	2,8 dTi		07.1998	10.2001	24.3727-0762.2	580762	CABLE FRENO DE MANO	77 00 311 216 , 36402-00QAA , 45 00 250 , 44 03 487 , 9111487 , 9160550	
	3,0 dCi 140	TI	12.2003		24.5258-0450.3	330824	LATIGUILLO	44 15 858 , 93183554 , 44230-00QAD , 77 01 059 963	
			10.2003		24.5111-0510.3	330819	LATIGUILLO	44 15 698 , 93182621 , 82 00 196 055 , 46201-00QAH	
			10.2003		24.3727-0762.2	580762	CABLE FRENO DE MANO	77 00 311 216 , 36402-00QAA , 45 00 250 , 44 03 487 , 9111487 , 9160550	
MASTER II Kasten (FD_) (98-)	1,9 dCi 80		11.2003		24.5111-0510.3	330819	LATIGUILLO	44 15 698 , 93182621 , 82 00 196 055 , 46201-00QAH	
		TI	12.2003		24.5258-0450.3	330824	LATIGUILLO	44 15 858 , 93183554 , 44230-00QAD , 77 01 059 963	
			11.2001		24.3727-0762.2	580762	CABLE FRENO DE MANO	77 00 311 216 , 36402-00QAA , 45 00 250 , 44 03 487 , 9111487 , 9160550	
	1,9 dTi	TI	12.2003		24.5258-0450.3	330824	LATIGUILLO	44 15 858 , 93183554 , 44230-00QAD , 77 01 059 963	









					Denominación	Ref. OE correspondientes a las referencias ATE	 Referencia anterior / varios
---	---	---	---	---	--------------	--	--

RENAULT

MASTER II Kasten (FD_) (98-)	1,9 dTi		11.2003		24.5111-0510.3	330819	LATIGUILLO	44 15 698 , 93182621 , 82 00 196 055 , 46201-00QAH	
			09.2000		24.3727-0762.2	580762	CABLE FRENO DE MANO	77 00 311 216 , 36402-00QAA , 45 00 250 , 44 03 487 , 9111487 , 9160550	
	2,2 dCi 90	TI	12.2003		24.5258-0450.3	330824	LATIGUILLO	44 15 858 , 93183554 , 44230-00QAD , 77 01 059 963	
			11.2003		24.5111-0510.3	330819	LATIGUILLO	44 15 698 , 93182621 , 82 00 196 055 , 46201-00QAH	
			09.2000		24.3727-0762.2	580762	CABLE FRENO DE MANO	77 00 311 216 , 36402-00QAA , 45 00 250 , 44 03 487 , 9111487 , 9160550	
	2,5 D		08.2000	01.2001	24.3727-0762.2	580762	CABLE FRENO DE MANO	77 00 311 216 , 36402-00QAA , 45 00 250 , 44 03 487 , 9111487 , 9160550	
	2,5 dCi 100	TI	12.2003		24.5258-0450.3	330824	LATIGUILLO	44 15 858 , 93183554 , 44230-00QAD , 77 01 059 963	
			10.2003		24.5111-0510.3	330819	LATIGUILLO	44 15 698 , 93182621 , 82 00 196 055 , 46201-00QAH	
			10.2003		24.3727-0762.2	580762	CABLE FRENO DE MANO	77 00 311 216 , 36402-00QAA , 45 00 250 , 44 03 487 , 9111487 , 9160550	
	2,5 dCi 120		11.2003		24.5111-0510.3	330819	LATIGUILLO	44 15 698 , 93182621 , 82 00 196 055 , 46201-00QAH	
		TI	12.2003		24.5258-0450.3	330824	LATIGUILLO	44 15 858 , 93183554 , 44230-00QAD , 77 01 059 963	
			10.2001		24.3727-0762.2	580762	CABLE FRENO DE MANO	77 00 311 216 , 36402-00QAA , 45 00 250 , 44 03 487 , 9111487 , 9160550	









					Denominación	Ref. OE correspondientes a las referencias ATE	 Referencia anterior / varios
---	---	---	---	---	--------------	--	---

RENAULT

MASTER II Kasten (FD_) (98-)	2,8 dTi		08.2000	10.2001	24.3727-0762.2	580762	CABLE FRENO DE MANO	77 00 311 216 , 36402-00QAA , 45 00 250 , 44 03 487 , 9111487 , 9160550	
	3,0 dCi 120		06.2005		24.5111-0510.3	330819	LATIGUILLO	44 15 698 , 93182621 , 82 00 196 055 , 46201-00QAH	
		TI	06.2005		24.5258-0450.3	330824	LATIGUILLO	44 15 858 , 93183554 , 44230-00QAD , 77 01 059 963	
			06.2005		24.3727-0762.2	580762	CABLE FRENO DE MANO	77 00 311 216 , 36402-00QAA , 45 00 250 , 44 03 487 , 9111487 , 9160550	
	3,0 dCi 140		10.2003		24.5111-0510.3	330819	LATIGUILLO	44 15 698 , 93182621 , 82 00 196 055 , 46201-00QAH	
		TI	12.2003		24.5258-0450.3	330824	LATIGUILLO	44 15 858 , 93183554 , 44230-00QAD , 77 01 059 963	
			10.2003		24.3727-0762.2	580762	CABLE FRENO DE MANO	77 00 311 216 , 36402-00QAA , 45 00 250 , 44 03 487 , 9111487 , 9160550	
	3,0 dCi 160		06.2005		24.5111-0510.3	330819	LATIGUILLO	44 15 698 , 93182621 , 82 00 196 055 , 46201-00QAH	
		TI	06.2005		24.5258-0450.3	330824	LATIGUILLO	44 15 858 , 93183554 , 44230-00QAD , 77 01 059 963	
			06.2005		24.3727-0762.2	580762	CABLE FRENO DE MANO	77 00 311 216 , 36402-00QAA , 45 00 250 , 44 03 487 , 9111487 , 9160550	
MASTER II Pritsche/Fahrgestell (ED/HD/UD_) (98-)	2,2 dCi 90		11.2003		24.5111-0510.3	330819	LATIGUILLO	44 15 698 , 93182621 , 82 00 196 055 , 46201-00QAH	
		TI	12.2003		24.5258-0450.3	330824	LATIGUILLO	44 15 858 , 93183554 , 44230-00QAD , 77 01 059 963	









					Denominación	Ref. OE correspondientes a las referencias ATE	 Referencia anterior / varios
---	---	---	---	---	--------------	--	--

RENAULT

MASTER II Pritsche/Fahrgestell (ED/HD/UD_) (98-)	2,2 dCi 90		09.2000		24.3727-0762.2	580762	CABLE FRENO DE MANO	77 00 311 216 , 36402-00QAA , 45 00 250 , 44 03 487 , 9111487 , 9160550	
	2,5 D		07.1998	01.2001	24.3727-0762.2	580762	CABLE FRENO DE MANO	77 00 311 216 , 36402-00QAA , 45 00 250 , 44 03 487 , 9111487 , 9160550	
	2,5 dCi 100	TI	12.2003		24.5258-0450.3	330824	LATIGUILLO	44 15 858 , 93183554 , 44230-00QAD , 77 01 059 963	
			10.2003		24.5111-0510.3	330819	LATIGUILLO	44 15 698 , 93182621 , 82 00 196 055 , 46201-00QAH	
			10.2003		24.3727-0762.2	580762	CABLE FRENO DE MANO	77 00 311 216 , 36402-00QAA , 45 00 250 , 44 03 487 , 9111487 , 9160550	
	2,5 dCi 120	TI	12.2003		24.5258-0450.3	330824	LATIGUILLO	44 15 858 , 93183554 , 44230-00QAD , 77 01 059 963	
			11.2003		24.5111-0510.3	330819	LATIGUILLO	44 15 698 , 93182621 , 82 00 196 055 , 46201-00QAH	
			10.2001		24.3727-0762.2	580762	CABLE FRENO DE MANO	77 00 311 216 , 36402-00QAA , 45 00 250 , 44 03 487 , 9111487 , 9160550	
	2,8 dTi		07.1998	10.2001	24.3727-0762.2	580762	CABLE FRENO DE MANO	77 00 311 216 , 36402-00QAA , 45 00 250 , 44 03 487 , 9111487 , 9160550	
	3,0 dCi 120		06.2005		24.5111-0510.3	330819	LATIGUILLO	44 15 698 , 93182621 , 82 00 196 055 , 46201-00QAH	
		TI	06.2005		24.5258-0450.3	330824	LATIGUILLO	44 15 858 , 93183554 , 44230-00QAD , 77 01 059 963	









					Denominación	Ref. OE correspondientes a las referencias ATE	 Referencia anterior / varios
---	---	---	---	---	--------------	--	--

RENAULT

MASTER II Pritsche/Fahrgestell (ED/HD/UD_) (98-)	3,0 dCi 120		06.2005		24.3727-0762.2	580762	CABLE FRENO DE MANO	77 00 311 216 , 36402-00QAA , 45 00 250 , 44 03 487 , 9111487 , 9160550	
	3,0 dCi 140		10.2003		24.5111-0510.3	330819	LATIGUILLO	44 15 698 , 93182621 , 82 00 196 055 , 46201-00QAH	
		TI	11.2003		24.5258-0450.3	330824	LATIGUILLO	44 15 858 , 93183554 , 44230-00QAD , 77 01 059 963	
			10.2003		24.3727-0762.2	580762	CABLE FRENO DE MANO	77 00 311 216 , 36402-00QAA , 45 00 250 , 44 03 487 , 9111487 , 9160550	
	3,0 dCi 160	TI	06.2005		24.5258-0450.3	330824	LATIGUILLO	44 15 858 , 93183554 , 44230-00QAD , 77 01 059 963	
			06.2005		24.5111-0510.3	330819	LATIGUILLO	44 15 698 , 93182621 , 82 00 196 055 , 46201-00QAH	
			06.2005		24.3727-0762.2	580762	CABLE FRENO DE MANO	77 00 311 216 , 36402-00QAA , 45 00 250 , 44 03 487 , 9111487 , 9160550	
TRAFIC II (JL/FL/EL) (01-)	1,9 dCi 100		03.2001		24.3727-0763.2	580763	CABLE FRENO DE MANO	36518-00QAA , 77 00 313 058 , 44 08 735 , 91165521	
			03.2001		24.3727-0764.2	580764	CABLE FRENO DE MANO	82 00 008 473 , 44 08 730 , 91165522	
	1,9 dCi 80		03.2001		24.3727-0764.2	580764	CABLE FRENO DE MANO	82 00 008 473 , 44 08 730 , 91165522	
			03.2001		24.3727-0763.2	580763	CABLE FRENO DE MANO	36518-00QAA , 77 00 313 058 , 44 08 735 , 91165521	
	2,0 16V		03.2001		24.3727-0763.2	580763	CABLE FRENO DE MANO	36518-00QAA , 77 00 313 058 , 44 08 735 , 91165521	



		 		Denominación	Ref. OE correspondientes a las referencias ATE	 Referencia anterior / varios
---	---	---	---	---------------------	---	---

RENAULT

TRAFIC II (JL/FL/EL) (01-)	2,0 16V		03.2001		24.3727-0764.2	580764	CABLE FRENO DE MANO	82 00 008 473 , 44 08 730 , 91165522	
	2,0 dCi		10.2006		24.3727-0764.2	580764	CABLE FRENO DE MANO	82 00 008 473 , 44 08 730 , 91165522	
			10.2006		24.3727-0763.2	580763	CABLE FRENO DE MANO	36518-00QAA , 77 00 313 058 , 44 08 735 , 91165521	
	2,5 dCi		10.2006		24.3727-0764.2	580764	CABLE FRENO DE MANO	82 00 008 473 , 44 08 730 , 91165522	
			10.2006		24.3727-0763.2	580763	CABLE FRENO DE MANO	36518-00QAA , 77 00 313 058 , 44 08 735 , 91165521	
			05.2003		24.3727-0763.2	580763	CABLE FRENO DE MANO	36518-00QAA , 77 00 313 058 , 44 08 735 , 91165521	
			05.2003		24.3727-0764.2	580764	CABLE FRENO DE MANO	82 00 008 473 , 44 08 730 , 91165522	









	i			Denominación	Ref. OE correspondientes a las referencias ATE	i Referencia anterior / varios
--	----------	--	--	--------------	--	--

SEAT

LEON I (1M1) (99-05)	1,4 i 16V		11.1999	07.2005	83.7838-0435.3	330834	LATIGUILLO	1J0 611 701	83.6238-0435.3
	1,6 i 16V		11.1999	07.2005	83.7838-0435.3	330834	LATIGUILLO	1J0 611 701	83.6238-0435.3
	1,8 i 20V		11.1999	07.2005	83.7838-0435.3	330834	LATIGUILLO	1J0 611 701	83.6238-0435.3
	1,8 T 20V		11.1999	07.2005	83.7838-0435.3	330834	LATIGUILLO	1J0 611 701	83.6238-0435.3
	1,9 SDI		11.1999	07.2005	83.7838-0435.3	330834	LATIGUILLO	1J0 611 701	83.6238-0435.3
	1,9 TDI		02.2001	07.2005	83.7838-0435.3	330834	LATIGUILLO	1J0 611 701	83.6238-0435.3
			11.1999	07.2005	83.7838-0435.3	330834	LATIGUILLO	1J0 611 701	83.6238-0435.3
TOLEDO II (1M2) (99-04)	1,6 i		10.1998	09.2004	83.7838-0435.3	330834	LATIGUILLO	1J0 611 701	83.6238-0435.3
	1,8 i 20V		10.1998	09.2004	83.7838-0435.3	330834	LATIGUILLO	1J0 611 701	83.6238-0435.3
	1,9 TDI		10.1998	09.2004	83.7838-0435.3	330834	LATIGUILLO	1J0 611 701	83.6238-0435.3
	2,3 i V5		10.1998	09.2004	83.7838-0435.3	330834	LATIGUILLO	1J0 611 701	83.6238-0435.3



					Denominación	Ref. OE correspondientes a las referencias ATE	 Referencia anterior / varios
---	---	---	---	---	--------------	--	--







SKODA

OCTAVIA I (97-06)	1,4 i		04.1999		83.7838-0435.3	330834	LATIGUILLO	1J0 611 701	83.6238-0435.3
	1,6 i		10.1996		83.7838-0435.3	330834	LATIGUILLO	1J0 611 701	83.6238-0435.3
	1,8 i 20V		10.1996		83.7838-0435.3	330834	LATIGUILLO	1J0 611 701	83.6238-0435.3
	1,8 i 20V Turbo		03.1998		83.7838-0435.3	330834	LATIGUILLO	1J0 611 701	83.6238-0435.3
	1,9 SDI		05.1997		83.7838-0435.3	330834	LATIGUILLO	1J0 611 701	83.6238-0435.3
	1,9 TDI		01.2003		83.7838-0435.3	330834	LATIGUILLO	1J0 611 701	83.6238-0435.3
			08.1997		83.7838-0435.3	330834	LATIGUILLO	1J0 611 701	83.6238-0435.3
			10.1996		83.7838-0435.3	330834	LATIGUILLO	1J0 611 701	83.6238-0435.3
	1,9 TDI 4x4		09.2000		83.7838-0435.3	330834	LATIGUILLO	1J0 611 701	83.6238-0435.3
	2,0 i		04.1999		83.7838-0435.3	330834	LATIGUILLO	1J0 611 701	83.6238-0435.3
	RS 1,8 T 20V		01.2003		83.7838-0435.3	330834	LATIGUILLO	1J0 611 701	83.6238-0435.3

SUZUKI

WAGON R+ (00-)	1,3 i 16V	DD	05.2000		24.3481-1758.5	240326	PINZA DE GARRA	9195322 , 55101-83E00 , 47 01 930	
		DI	05.2000		24.3481-1757.5	240325	PINZA DE GARRA	9195321 , 55102-83E00 , 47 01 929	
	1,3 i 16V 4WD	DI	10.2001		24.3481-1757.5	240325	PINZA DE GARRA	9195321 , 55102-83E00 , 47 01 929	
		DD	10.2001		24.3481-1758.5	240326	PINZA DE GARRA	9195322 , 55101-83E00 , 47 01 930	



					Denominación	Ref. OE correspondientes a las referencias ATE	 Referencia anterior / varios
---	---	---	---	---	---------------------	---	---

TOYOTA

Modelo	Motor	Fecha inicio	Fecha fin	Ref. ATE	Ref. OE	Denominación	Ref. OE correspondientes a las referencias ATE	Referencia anterior / varios
YARIS (99-)	1,0 i 16V	04.2003		24.3219-1744.3	020488	CILINDRO DE RUEDA	47550-0D010	
		01.2001	03.2003	24.3219-1744.3	020488	CILINDRO DE RUEDA	47550-0D010	
	1,3 i 16V	04.2002		24.3219-1744.3	020488	CILINDRO DE RUEDA	47550-0D010	
	1,4 D-4D	12.2001	03.2003	24.3219-1744.3	020488	CILINDRO DE RUEDA	47550-0D010	

Nuevas referencias en almacén - Por aplicación

04/2007



					Denominación	Ref. OE correspondientes a las referencias ATE		Referencia anterior / varios
--	--	--	--	--	--------------	--	--	------------------------------

VOLKSWAGEN

BEETLE (98-)	1,4		08.2001		83.7838-0435.3	330834	LATIGUILLO	1J0 611 701	83.6238-0435.3
	1,6		11.1999		83.7838-0435.3	330834	LATIGUILLO	1J0 611 701	83.6238-0435.3
	1,8 T		10.1999		83.7838-0435.3	330834	LATIGUILLO	1J0 611 701	83.6238-0435.3
	1,9 TDI		01.1998	02.2001	83.7838-0435.3	330834	LATIGUILLO	1J0 611 701	83.6238-0435.3
			10.2000		83.7838-0435.3	330834	LATIGUILLO	1J0 611 701	83.6238-0435.3
			07.2005		83.7838-0435.3	330834	LATIGUILLO	1J0 611 701	83.6238-0435.3
	2		01.1998		83.7838-0435.3	330834	LATIGUILLO	1J0 611 701	83.6238-0435.3
	2,3 V5		01.1999	12.2005	83.7838-0435.3	330834	LATIGUILLO	1J0 611 701	83.6238-0435.3
	3,2 RSI		04.2000	03.2003	83.7838-0435.3	330834	LATIGUILLO	1J0 611 701	83.6238-0435.3
VW BEETLE Cabrióle (03-)	1,4		01.2003		83.7838-0435.3	330834	LATIGUILLO	1J0 611 701	83.6238-0435.3
	1,6		01.2003		83.7838-0435.3	330834	LATIGUILLO	1J0 611 701	83.6238-0435.3
	1,8 T		12.2003		83.7838-0435.3	330834	LATIGUILLO	1J0 611 701	83.6238-0435.3
	1,9 TDI		07.2003		83.7838-0435.3	330834	LATIGUILLO	1J0 611 701	83.6238-0435.3
			07.2005		83.7838-0435.3	330834	LATIGUILLO	1J0 611 701	83.6238-0435.3
	2		01.2003		83.7838-0435.3	330834	LATIGUILLO	1J0 611 701	83.6238-0435.3
BORA (98-04)	1,4 16V		09.1998	12.2004	83.7838-0435.3	330834	LATIGUILLO	1J0 611 701	83.6238-0435.3
	1,6		09.1998	12.2004	83.7838-0435.3	330834	LATIGUILLO	1J0 611 701	83.6238-0435.3
	1,6 16V		02.2000	12.2004	83.7838-0435.3	330834	LATIGUILLO	1J0 611 701	83.6238-0435.3
	1,6 FSI		01.2002	12.2004	83.7838-0435.3	330834	LATIGUILLO	1J0 611 701	83.6238-0435.3

Nuevas referencias en almacén - Por aplicación

04/2007



					Denominación	Ref. OE correspondientes a las referencias ATE	Referencia anterior / varios
--	--	--	--	--	--------------	--	------------------------------

VOLKSWAGEN

Modelo	Motor	Fecha inicio	Fecha fin	Ref. ATE	Ref. OE	Denominación	Ref. OE correspondientes a las referencias ATE	Referencia anterior / varios
BORA (98-04)	1,8	09.1998	12.2004	83.7838-0435.3	330834	LATIGUILLO	1J0 611 701	83.6238-0435.3
	1,8 4motion	02.1999	08.2000	83.7838-0435.3	330834	LATIGUILLO	1J0 611 701	83.6238-0435.3
	1,8 T	05.2002	12.2004	83.7838-0435.3	330834	LATIGUILLO	1J0 611 701	83.6238-0435.3
		09.2000	12.2004	83.7838-0435.3	330834	LATIGUILLO	1J0 611 701	83.6238-0435.3
	1,9 SDI	09.1998	12.2004	83.7838-0435.3	330834	LATIGUILLO	1J0 611 701	83.6238-0435.3
	1,9 TDI	02.1999	06.2001	83.7838-0435.3	330834	LATIGUILLO	1J0 611 701	83.6238-0435.3
		04.2001	12.2004	83.7838-0435.3	330834	LATIGUILLO	1J0 611 701	83.6238-0435.3
		09.2000	12.2004	83.7838-0435.3	330834	LATIGUILLO	1J0 611 701	83.6238-0435.3
		10.2000	12.2004	83.7838-0435.3	330834	LATIGUILLO	1J0 611 701	83.6238-0435.3
		09.1998	06.2001	83.7838-0435.3	330834	LATIGUILLO	1J0 611 701	83.6238-0435.3
	1,9 TDI 4motion	02.1999	08.2000	83.7838-0435.3	330834	LATIGUILLO	1J0 611 701	83.6238-0435.3
	2	09.1998	12.2004	83.7838-0435.3	330834	LATIGUILLO	1J0 611 701	83.6238-0435.3
	2,0 4motion	04.2000	08.2000	83.7838-0435.3	330834	LATIGUILLO	1J0 611 701	83.6238-0435.3
	2,3 V5	09.1998	12.2004	83.7838-0435.3	330834	LATIGUILLO	1J0 611 701	83.6238-0435.3
	2,3 V5 4motion	02.1999	08.2000	83.7838-0435.3	330834	LATIGUILLO	1J0 611 701	83.6238-0435.3
	2,8 V6 4motion	05.1999	08.2000	83.7838-0435.3	330834	LATIGUILLO	1J0 611 701	83.6238-0435.3
GOLF IV (98-03)	1,4	10.1997	10.2003	83.7838-0435.3	330834	LATIGUILLO	1J0 611 701	83.6238-0435.3
	1,6	10.1997	10.2003	83.7838-0435.3	330834	LATIGUILLO	1J0 611 701	83.6238-0435.3
	1,6 FSI	01.2002	10.2003	83.7838-0435.3	330834	LATIGUILLO	1J0 611 701	83.6238-0435.3



					Denominación	Ref. OE correspondientes a las referencias ATE		Referencia anterior / varios
--	--	--	--	--	--------------	--	--	------------------------------

VOLKSWAGEN

GOLF IV (98-03)	1,8		10.1997	10.2003	83.7838-0435.3	330834	LATIGUILLO	1J0 611 701	83.6238-0435.3
	1,8 T GTI		10.1997	10.2003	83.7838-0435.3	330834	LATIGUILLO	1J0 611 701	83.6238-0435.3
	1,9 SDI		10.1997	10.2003	83.7838-0435.3	330834	LATIGUILLO	1J0 611 701	83.6238-0435.3
	1,9 TDI		04.2001	10.2003	83.7838-0435.3	330834	LATIGUILLO	1J0 611 701	83.6238-0435.3
			09.2000	10.2003	83.7838-0435.3	330834	LATIGUILLO	1J0 611 701	83.6238-0435.3
			10.1997	06.2001	83.7838-0435.3	330834	LATIGUILLO	1J0 611 701	83.6238-0435.3
			05.1999	06.2001	83.7838-0435.3	330834	LATIGUILLO	1J0 611 701	83.6238-0435.3
	2		08.1998	10.2003	83.7838-0435.3	330834	LATIGUILLO	1J0 611 701	83.6238-0435.3
	2,3 V5		10.1997	10.2003	83.7838-0435.3	330834	LATIGUILLO	1J0 611 701	83.6238-0435.3
GOLF IV Variant (99-)	1,4		05.1999		83.7838-0435.3	330834	LATIGUILLO	1J0 611 701	83.6238-0435.3
	1,6		05.1999		83.7838-0435.3	330834	LATIGUILLO	1J0 611 701	83.6238-0435.3
	1,6 FSI		01.2002		83.7838-0435.3	330834	LATIGUILLO	1J0 611 701	83.6238-0435.3
	1,8 T		05.2000		83.7838-0435.3	330834	LATIGUILLO	1J0 611 701	83.6238-0435.3
	1,9 SDI		05.1999		83.7838-0435.3	330834	LATIGUILLO	1J0 611 701	83.6238-0435.3
	1,9 TDI		04.2001		83.7838-0435.3	330834	LATIGUILLO	1J0 611 701	83.6238-0435.3
			09.2000		83.7838-0435.3	330834	LATIGUILLO	1J0 611 701	83.6238-0435.3
			05.1999	06.2001	83.7838-0435.3	330834	LATIGUILLO	1J0 611 701	83.6238-0435.3
	2		05.1999		83.7838-0435.3	330834	LATIGUILLO	1J0 611 701	83.6238-0435.3
	2,3 V5		05.1999		83.7838-0435.3	330834	LATIGUILLO	1J0 611 701	83.6238-0435.3



					Denominación	Ref. OE correspondientes a las referencias ATE		Referencia anterior / varios
--	--	--	--	--	--------------	--	--	------------------------------

VOLKSWAGEN

POLO III (95-01)	1,4 16V		04.1996	09.2001	83.7838-0435.3	330834	LATIGUILLO	1J0 611 701	83.6238-0435.3
TRANSPORTER (T5) (03-)	1,9 TDI		06.2006		13.0460-7218.2	607218	PASTILLAS DE FRENO	7H8 698 451	ver figura
			04.2003		13.0460-7218.2	607218	PASTILLAS DE FRENO	7H8 698 451	ver figura
	2		06.2003		13.0460-7218.2	607218	PASTILLAS DE FRENO	7H8 698 451	ver figura
	2,5 TDI		02.2003		13.0460-7218.2	607218	PASTILLAS DE FRENO	7H8 698 451	ver figura
	2,5 TDI 4motion		07.2004		13.0460-7218.2	607218	PASTILLAS DE FRENO	7H8 698 451	ver figura
	3,2 V6		02.2003		13.0460-7218.2	607218	PASTILLAS DE FRENO	7H8 698 451	ver figura
	3,2 V6 4motion		07.2004		13.0460-7218.2	607218	PASTILLAS DE FRENO	7H8 698 451	ver figura

VOLVO

XC90 (02-)	2,4 D5		05.2006		13.0460-7189.2	607189	PASTILLAS DE FRENO	274330 , 274528	ver figura
			10.2002		13.0460-7189.2	607189	PASTILLAS DE FRENO	274330 , 274528	ver figura
	2,5 T		10.2002		13.0460-7189.2	607189	PASTILLAS DE FRENO	274330 , 274528	ver figura
	3,0 T6		10.2002		13.0460-7189.2	607189	PASTILLAS DE FRENO	274330 , 274528	ver figura
	4,0 V8		01.2005		13.0460-7189.2	607189	PASTILLAS DE FRENO	274330 , 274528	ver figura



13.0460-2713.2 602713

Aplicación:

BMW 1er Reihe/E87 5-T?rer/E81 3-T?rer (04-)
BMW 3er Reihe/E90 Limousine (05-)

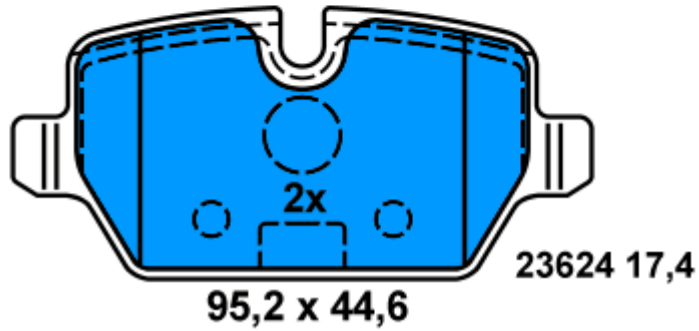
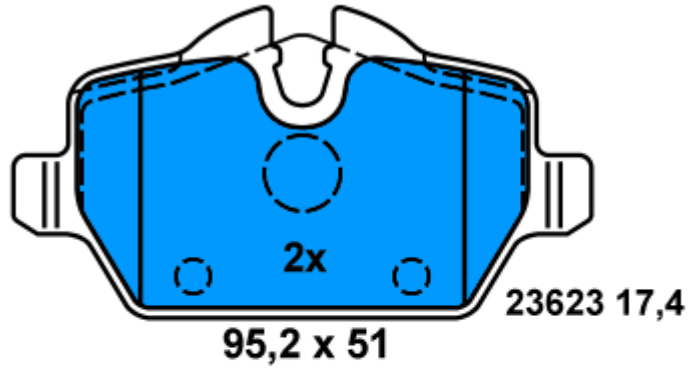
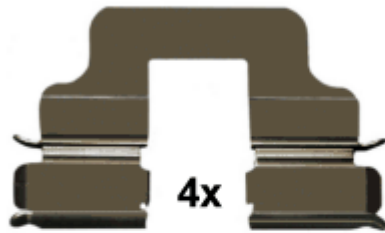



13.0460-2899.2 602899

Aplicación:

JEEP CHEROKEE (KJ) (01-)
CHRYSLER VOYAGER (RG) (00-)

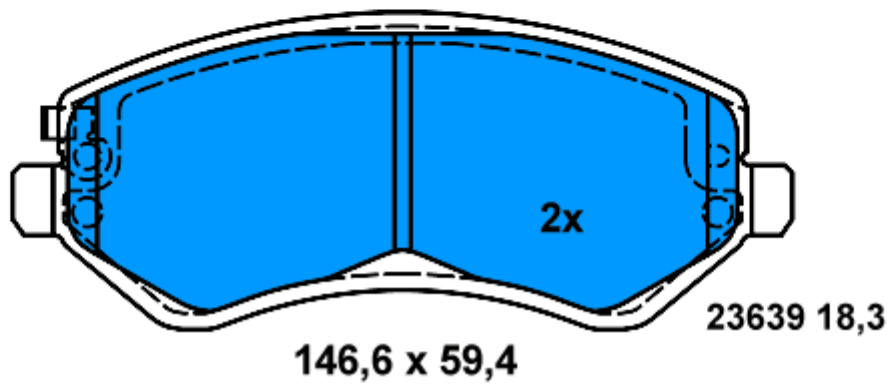
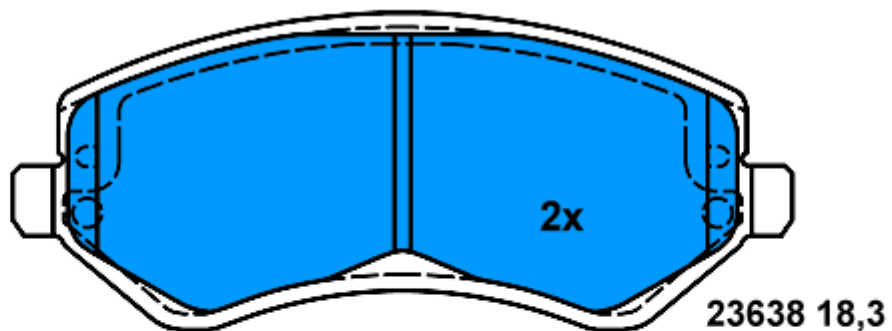



13.0460-5899.2 605899

Aplicación:

DAEWOO KALOS (02-05)
CHEVROLET KALOS (05-)

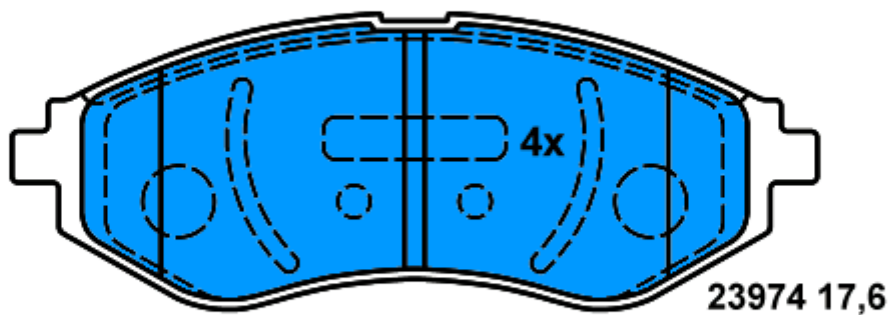

133 x 48,9



13.0460-7189.2 607189

Aplicación:

VOLVO XC90 (02-)

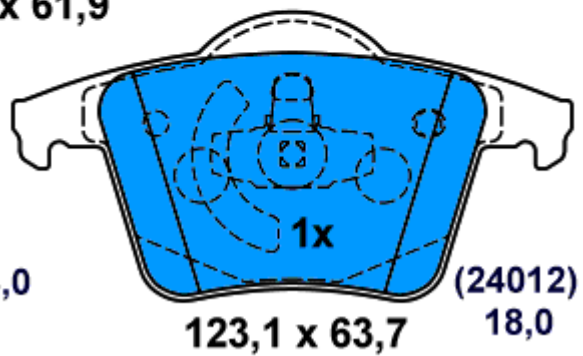
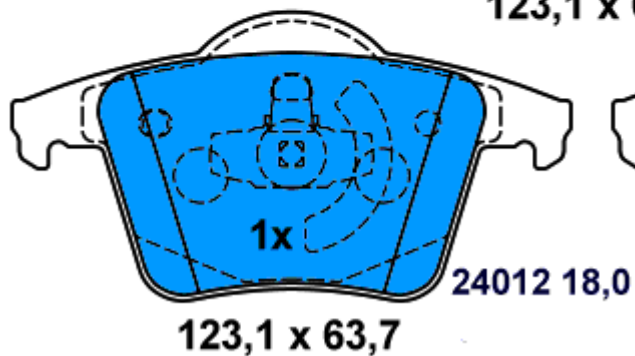
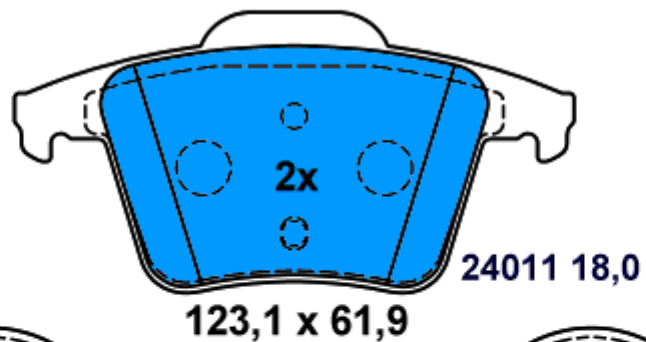



13.0460-7218.2 607218

Aplicación:

VOLKSWAGEN TRANSPORTER (T5) (03-)

